

**RECAMBIOS
MARINOS**

YAMAHA SUZUKI HONDA TOHATSU SELVA

FUERABORDA • OUTBOARD • FUORIBORDO • HORS-BORD

**2021
2022**



www.recambiosmarinos.es

YAMAHA SUZUKI HONDA TOHATSU SELVA

FUERABORDA • OUTBOARD • FUORIBORDO • HORS-BORD

2021
2022



IMPORTANTE

LOS PRODUCTOS QUE APARECEN EN NUESTROS CATALOGOS SON VÁLIDOS Y COMPATIBLES CON LOS MOTORES Y TRANSMISIONES DE LAS MARCAS ORIGINALES QUE APARECEN EN CADA SECCIÓN. EN ALGUNOS CASOS TAMBIÉN SUMINISTRAMOS RECAMBIOS ORIGINALES. ESTA INFORMACIÓN APARECE CON LA REFERENCIA EN EL MOMENTO DE CONFIRMAR EL PEDIDO POR NUESTRA WEB. LA IMÁGENES AQUÍ CONTENIDAS PUEDEN NO CORRESPONDER CON TOTAL PRECISIÓN AL PRODUCTO SUMINISTRADO. RECAMBIOS MARINOS, S.L.U. SE RESERVA EL DERECHO DE ANULAR O CAMBIAR PRODUCTOS SIN PREVIO AVISO.

IMPORTANT

THE PRODUCTS THAT APPEAR IN OUR CATALOGS ARE VALID AND COMPATIBLE WITH THE MOTORS AND TRANSMISSIONS OF THE ORIGINAL BRANDS THAT APPEAR IN EACH SECTION. IN SOME CASES WE ALSO SUPPLIED ORIGINAL SPARE PARTS. THIS INFORMATION APPEARS WITH THE REFERENCE AT THE TIME OF CONFIRMING THE ORDER BY OUR WEB. IMAGES CONTAINED HERE MAY NOT CORRESPOND WITH TOTAL ACCURACY TO THE PRODUCT SUPPLIED. RECAMBIOS MARINOS, S.L.U. RESERVES THE RIGHT TO CANCEL OR CHANGE PRODUCTS WITHOUT PRIOR NOTICE.

IMPORTANTE

I PRODOTTI CHE COMPAIONO NEI NOSTRI CATALOGHI SONO VALIDI E COMPATIBILI CON I MOTORI E LE TRASMISSIONI DEI MARCHI ORIGINALI CHE APPAIONO IN OGNI SEZIONE. IN ALCUNI CASI ABBIAMO FORNITO ANCHE RICAMBI ORIGINALI. QUESTA INFORMAZIONE RISULTA CON IL RIFERIMENTO AL MOMENTO DELLA CONFERMA DELL'ORDINE DA PARTE DEL NOSTRO WEB. LE IMMAGINI QUI CONTENUTE POTREBBERO NON CORRISPONDERE ESATTAMENTE AL PRODOTTO FORNITO. RECAMBIOS MARINOS, S.L.U., SI RISERVA IL DIRITTO DI CANCELLARE O MODIFICARE I PRODOTTI SENZA PREAVVISO.

IMPORTANT

LES PRODUITS QUI FIGURENT DANS NOS CATALOGUES SONT VALIDES ET COMPATIBLES AVEC LES MOTEURS ET LES TRANSMISSIONS DES MARQUES ORIGINALES QUI SONT PRESENTES DANS CHAQUE SECTION. DANS CERTAINS CAS NOUS FOURNISSONS EGALEMENT DES PIECES DE RECHANGE ORIGINALES. CETTE INFORMATION EST MENTIONNEE AVEC LA REFERENCE SUR NOTRE SITE WEB. LES IMAGES CONTENUES DANS CE DOCUMENT PEUVENT NE PAS CORRESPONDRE AVEC UNE PRECISION TOTALE AU PRODUIT FOURNI. RECAMBIOS MARINOS SLU SE RESERVE LE DROIT D'ANNULER OU DE MODIFIER DES PRODUITS SANS PREAVIS.

• **YAMAHA** 59
REF --> R.O. / OEM 406

• **SUZUKI** 435
REF --> R.O. / OEM 533

• **HONDA** 543
REF --> R.O. / OEM 583

• **TOHATSU** 587
REF --> R.O. / OEM 630

• **SELVA** 635
REF --> R.O. / OEM 643

| ÍNDICE accesorios | Accessories Table of contents | INDICE accessori | INDEX accessoires | |
|--|--|---|---|-----------|
| TX MARINE | TX MARINE | TX MARINE | TX MARINE | 4 |
| SOPORTES | STANDS | SUPPORTI | SUPPORTS | 8 |
| DIRECCIÓN MECÁNICA | STEERING SYSTEM | TIMONERIA MECCANICA | DIRECTION MÉCANIQUE | 12 |
| DIRECCIÓN HIDRÁULICA | HYDRAULICS STEERING SYSTEM | TIMONERIA IDRAULICA | DIRECTION HYDRAULIQUE | 14 |
| MANDOS UNIVERSALES Y ACCESORIOS | UNIVERSAL CONTROLS AND ACCESSORIES | CONTROLLI UNIVERSALI E ACCESSORI | COMMANDES UNIVERSELLES ET ACCESSORIES | 17 |
| SISTEMA DE GOBIERNO Y ACCESORIOS DE INSTALACIÓN | STEERING SYSTEM ET INSTALLATION ACCESSORIES | SISTEMA DI GUIDA E ACCESSORI DIREZIONE | SYSTÈME DE DIRECTION ET ACCESSORIES D'INSTALLATION | 20 |
| CABLES MANDOS | CONTROL CABLES | CAVI COMANDO | CÂBLES DE COMMANDE | 25 |
| SISTEMA DE COMBUSTIBLE | FUEL SYSTEM | SISTEMA DI COMBUSTIBILE | SYSTÈME DE CARBURANT | 27 |
| FILTROS DE COMBUSTIBLE | FUEL FILTERS | FILTRO BENZINA | FILTRES À CARBURAT | 29 |
| SISTEMA ELÉCTRICO | ELECTRIC SYSTEM | SISTEMA ELETTRICO | SYSTÈME ÉLECTRIQUE | 32 |
| LUBRICANTES Y PINTURAS | LUBRICANTS ET PAINTS | LUBRIFICANTI E PITTURE | LUBRIFIANTS ET PEINTURES | 36 |
| ACCESORIOS Y HERRAMIENTAS DE INSTALACIÓN | ACCESSORIES AND INSTALLATION TOOLS | ACCESSORI E ATTREZZI ISTALLAZIONE | ACCESSOIRES ET OUTILS D'INSTALLATION | 45 |
| ESTABILIZADORES, ELEVADORES Y SEGURIDAD | HYDROFOIL STABILIZER AND SECURITY | STABILIZZATORI, ASCENSORI E SICUREZZA | STABILISATEURS, POWER TRIM-LIFT ET SÉCURITÉ | 54 |



AXONE NEMO

La primera diagnosis Smart en el mundo

Axone Nemo es un potente tablet diseñado para asegurar al mecánico un óptimo uso, tanto en el entorno de taller, como en las intervenciones en el exterior.

Permite efectuar operaciones de diagnosis a gran velocidad. El chasis de magnesio le proporciona una mayor robustez y rigidez ante los golpes, muy ligero con gran capacidad de disipación de la temperatura interna.

El software operativo IDC5 destaca todas sus características, además del "touch gesture" para alcanzar en poco tiempo las funciones deseadas.

The first Smart diagnosis in the world

Axone Nemo is a powerful tablet designed to ensure the mechanic optimal use, both in the workshop environment, as interventions abroad.

It allows to carry out diagnosis operations at high speed. The magnesium chassis provides greater robustness and rigidity against shock, very light with great capacity to dissipate the internal temperature.

The IDC5 operating software highlights all its features, in addition to the "touch gesture" to reach the desired functions in a short time.

La prima diagnosi Smart nel mondo

Axone Nemo è un potente tablet creato per assicurare al meccanico un ottimo uso, sia nelle officine sia negli interventi all'esterno.

Permette di effettuare operazioni di diagnosi a gran velocità. La scocca in magnesio gli dona una maggior robustezza contro i colpi, molto leggero.

Il software operativo IDC5 evidenzia tutte le sue caratteristiche, come il "touch gesture" per eseguire in poco tempo le funzioni desiderate.

Le premier outil de diagnostic intelligent au monde

Axone Nemo est une tablette puissante conçue pour assurer une utilisation mécanique optimale, aussi bien dans un atelier que lors des interventions à l'extérieur. Il permet d'effectuer des opérations de diagnostic à grande vitesse. Le châssis en magnésium offre une plus grande robustesse contre les chocs, très léger avec une grande capacité à dissiper la température interne. Le logiciel IDC5 met en évidence toutes ses fonctionnalités.

12" (2160 x 1440)
 Intel Quad Core N3160
 8 GB RAM
 250 GB
 WIFI double channel
 Bluetooth 4.0 Low Energy
 2 camera x 5 Megapixels

SOFTWARE IDC5

IDC5 es la última evolución de TEXA, gracias a la reescritura del código se incrementa la velocidad de trabajo, lo que garantiza una entrada de comunicación con la centralita casi inmediata. La nueva función "Esquemas eléctricos interactivos" permite consultar los esquemas eléctricos aprovechando las animaciones de los dispositivos implicados y generando un mapa interactivo con flujos de señales entrada o salida de centralitas.

IDC5 is the latest evolution of TEXA, thanks to the rewriting of the code the working speed is increased, which guarantees a communication input with the control unit almost immediately. The new function "Interactive electrical diagrams" allows consulting the electrical diagrams taking advantage of the animations of the devices involved and generating an interactive map with flows of signals input or output of control units.

IDC5 è l'ultima evoluzione di TEXA, grazie ai nuovi aggiornamenti, si incrementa la velocità di lavoro, che garantisce la comunicazione quasi immediata con l'unità di controllo. La nuova funzione "Diagrammi interattivi elettronici" permettono di consultare i diagrammi elettronici con l'animazione dei led generando una mappa interattiva con un flusso di segnali in entrata e in uscita della centralina.

IDC5 est la dernière évolution du célèbre logiciel TEXA, grâce à une importante réécriture du programme, la rapidité est encore augmentée, garantissant une entrée en communication presque immédiate avec les calculateurs. La nouvelle fonctionnalité appelée "Schémas Electriques Interactif" est très intéressante car elle permet de consulter les schémas électriques en exploitant les animations des dispositifs concernés et en générant une cartographie interactive avec les flux de signaux d'entrée ou de sortie des calculateurs.



| Ref. | | | | |
|--------------|--|---|---|---|
| RECAxONENEMO | Axone Nemo | Axone Nemo | Axone Nemo | Axone Nemo |
| RECD06591 | Navigator TXB Evolution | Navigator TXB Evolution | Navigator TXB Evolution | Navigator TXB Evolution |
| RECD127X0 | Axone Nemo + Navigator TXB Marine | Axone Nemo + Navigator TXB | Axone Nemo + Navigator TXB | Axone Nemo + Navigator TXB |
| RECZ06590PC | Navigator TXB + PC | Navigator TXB + Labtop | Navigator TXB + PC | Navigator TXB + Pc portable |
| REC3901775 | Kit maleta para guardar cables de interface | Hand case for harnesses | Kit per cavi intergaccia | Valise pour ranger les câbles d'interface |
| RECAGA00M1 | Contrato de actualización software (y renovación anual). | Software contract and annual renovation | Contratto software (e rinnovo annuale). | Contrat de mise à jour logicielle (et renouvellement annuel). |

TEXA

NAVIGATOR TXB EVOLUTION & AXONE NEMO / PC



SRAM 16Mb
MEMORY NAND Flash 8 GB
BLUETOOTH

NAVIGATOR TXB EVOLUTION

La evolución de la diagnosis, diseñado y desarrollado específicamente para el ambiente Marino.

Las características del hardware lo compatibilizan con todos los protocolos actualmente existentes, su conector CPC de 16 polos integrados, permite el uso de todos los cables de diagnosis. Es compatible con AXONE NEMO y PC. Gracias a la tecnología Bluetooth el técnico podrá realizar una cómoda diagnosis sin cables de por medio, incluso desde el pantalán.

Extremadamente potente, permite al mecánico una gestión fácil de los archivos de mapa. Los estándares CAN soportados incluyen la posibilidad de gestión CAN single wire y un CAN controller más para la diagnosis sobre más redes.

Permite la grabación de la sesión de diagnosis en modalidad "pruebas dinámicas", es decir con la embarcación en movimiento, para localizar averías específicas que no se podrían verificar en el amarre. La interfaz reconstruye una panorámica completa de la situación en la que la anomalía se ha verificado, proporcionando importantes elementos de análisis para identificar las causas de la avería.

The evolution of the diagnosis, designed and developed specifically for the marine environment.

The characteristics of the hardware make it compatible with all currently existing protocols, its integrated 16-pole CPC connector, allows the use of all diagnostic cables. It is compatible with AXONE NEMO and PC. Thanks to Bluetooth technology, the technician can make a comfortable diagnosis without wires, even from the jetty.

Extremely powerful, they allow the mechanic to easily manage the map files. The CAN standards supported include the possibility of CAN single wire management and a further CAN controller for the diagnosis of more networks.

It allows the recording of the diagnosis session in "dynamic tests" mode, that is to say with the boat in motion, to locate specific faults that could not be verified in the mooring. The interface reconstructs a complete panorama of the situation in which the anomaly has been verified, providing important elements of analysis to identify the causes of the failure.

L'evoluzione della diagnosi, disegnata e sviluppata specificamente per l'ambiente marino.

Le caratteristiche hardware lo rendono compatibile con tutti i protocolli attualmente esistenti, il suo connettore CPC 16 poli integrato consente l'utilizzo di tutti i cavi diagnostici. È compatibile con AXONE NEMO e PC. Grazie alla tecnologia Bluetooth il tecnico potrà realizzare una diagnosi senza cavi in mezzo, anche dal molo.

Estremamente potente, permette al meccanico una gestione facile degli archivi della mappa. Gli standard CAN supportati offrono la possibilità di gestire: CAN single wire e un altro CAN controller per eseguire le diagnosi su più reti.

Permette la registrazione di una sessione di diagnosi in modalità "prova dinamica", ovvero con l'imbarcazione in movimento, per constatare avarie specifiche che non si possono verificare in officina. La sua interfaccia permette di ricostruire una panorámica completa della situazione in cui l'anomalia si è verificata, fornendo gli elementi per identificare le eventuali avarie.

L'évolution du diagnostic, dessiner et développer spécialement pour l'environnement marin

Les caractéristiques du matériel le rendent compatible avec tous les protocoles existants, son connecteur CPC 16 pôles intégré permet l'utilisation de tous les câbles de diagnostic. Il est compatible avec Axone Nemo et Pc. Grâce à la technologie Bluetooth, le technicien peut effectuer un diagnostic sans fil, même depuis le quai. Extrêmement puissant, il permet au mécanicien de gérer facilement les fichiers des cartes. Les normes CAN prises en charge incluent la possibilité d'une gestion CAN à fil unique et un autre contrôleur CAN pour le diagnostic en réseaux. Il permet l'enregistrement de la séance de diagnostic en mode «test dynamique» c'est à dire avec le bateau en mouvement pour localiser des défauts spécifiques non vérifiables en atelier. L'interface reconstruit un panorama complet de la situation dans laquelle l'anomalie a été constatée, fournissant des éléments d'analyse importants pour identifier les causes de la panne.

Consulte la lista actualizada de aplicaciones en:

See the updated list of applications in:

Vedi l'elenco aggiornato delle applicazioni in:

Consultez la liste mise à jour des applications sur:

www.texaiberica.com/cobertura-diagnosis

| MOTORES INTRABORDA INBOARD ENGINES MOTORI ENTROBORDO MOTEURS IN-BORD | |
|---|---|
| CATERPILLAR | 3196, 3176, 3126B, 3508B, 3508C, C12, C12 Acert, C18 Acert Tier 2, C32 Acert IMO II, C32 Acert Tier 2, C32 Acert Tier 2 HP, 3512 B HD, C3512B, 3512C HD, 3512C, 3516B HD, 32 Acert Tier 2 H.P. Recreational, C32 Acert Tier 3, C7, C7 Acert, C9 Acert., 3516B, 3516C HD, 3516C, C15 Acert, C6.6 Acert |
| CRUSADER | 5.0, 5.7, 6.0, 8.1 MPI & HO MPI QSD2.0-115 / 130 / 150 / 170, QSD2.8-220, QSD4.2-270 / 320 / 350, QSB5.9 / 6.7, QSC8.3, QSK19, QSL9, QSM11 (Sistema Inyección Bosch System injection Bosch Sistema Iniezione Bosch Système d'injection Bosch) Comon Rail |
| CUMMINS / MW | |
| FIAT | C13, C78, C87, GE CURSOR 250E, 350E, 400E, N40, N60, N67, S30 |
| FNM | HPEP, HPE 80-300 HP |
| HYUNDAI SEASALL | D150P/S, D170J/P/S, S220P/S, S250J/P/S, U125J/P/S |
| ILMOR | 5.7L, 6.0L, 6.2L, MV-8 |
| INDMAR | 5.7, 6.0, 8.1, Steyr 256 Diesel |
| KOHLER | |
| LOMBARDINI Marine | LDW 194 JMT, LDW 240 JMT |
| MAN | D2868, V8-1000, V8-1200 350, 377, 454, 496, 496MAG, 3.0L, 4.3L, 5.0L, 5.7L, 6.2L, 7.4L, 8.1L, 8.2L, TBI, MPI, Black Scorpion, Vazer, Mandos SmartCraft, D2.8D-Tronic |
| MERCURISER | VM D-Tronic, VM (no D-Tronic), MD2.0-115/130/150/170, MD2.8-270/320/350, TDI3.0-230/260, TDI4.2 |
| MERCURISER Diesel | |
| MERCURY Racing Inbord | SCI, EFI, QC4V, 500EFI, 520, 525EFI, 540, 565, 575, 600, 850, Scorpion 377 |
| MTU | MDEC C2 |
| PCM MARINE Engines | 5.0L, 5.7L, 6.0L, 8.1L |
| PERKINS | 1106C-E6OTA 6.0L |
| SEA-DOO | Speedster, Challenger, Utopia, Islandia, Wake, Wake Speedster, Sportster |
| SISU AGCO | 44 CTIM-2V, 49/66/74/84 CTIM-4V |
| STEYR MOTORS | MO306H43WJ, MO54NA33, MO84K32, MO94K33, MO114K33, MO126M28, MO144M38, MO156K25, MO164M40, MO166M28, MO174V40, MO196K35, MO236K42, MO256H45, MO256H43, MO286H43 SE126E25, SE156E26, SE196E35, SE236E40, SE236S36 SE266, SE286, SE306J38 |
| VM MOTORI | 2.8L, 4.2L D-Tronic, MD704, MD706, MR504LB |
| VOLKSWAGEN Marine | SDI, TDI |
| VOLVO PENTA | KAD, EDG, EGC, EVC, GXI, OSI, GI, GSI, OSXI, IPS, TAMD 4BY2-150 / 180, 6BY2-220 / 260 (Sistema Inyección Bosch System injection Bosch Sistema Iniezione Bosch Système d'injection Bosch) 4BY3-150/180, 4JH, 6BY3-220/260, 6LY3, 8LV-320/350/370 |

| MOTORES FUERABORDA OUTBOARD ENGINES MOTORI FUORIBORDO MOTEURS HORS-BORD | |
|--|---|
| EVINRUDE | (90 - 250 Ficht Ram) E-Tec 25 - 300 HP, DFI |
| HONDA Marine | BF 40-250 HP |
| JOHNSON | 4 Stroke |
| MARINER | 4 Stroke, OptiMax, Verado, DFI, EFI |
| MERCURY | 4 Stroke, OptiMax, Verado, DFI, EFI |
| MERCURY Racing | OPTIMAX, DSI, VERADO 400R |
| PARSUN | 40 EFI |
| SELVA Marine | 4 S troke EFI |
| SUZUKI Marine | DF 40 -300 HP |
| TOHATSU | MFS, BFW, BFT |
| YAMAHA Marine | F, T, Z 30 - 350 HP |

| MOTOS DE AGUA PWC MOTO D'ACQUA SCOOTER DES MERS | |
|--|--|
| HONDA Marine | Aquatrax |
| KAWASAKI Marine | STX, Ultra. |
| SEA-DOO | GTI, GTX, RXP, RXT, GTR, GTS, GTX-S, Spark, Wake Pro, Wake |
| YAMAHA Marine | Waverunner FX, FZR, FZS, GP, VX |

SIN CABLES DE INTERFACE
WITHOUT INTERFACE CABLE
SENZA CAVI INTERFACE
SANS CABLES D'INTERFACE

| | | CABLE WIRE CAVI CÂBLE |
|-------------------|--|------------------------------|
| REC3902417 | OBD, FNM Marine, VOLKSWAGEN, HYUNDAI | AM08 |
| REC3902659 | Marine FPT | AM11 |
| REC3904277 | Marine CUMMINS, MERCURISER Diesel, VM (not D-Tronic), KOHLER | AM24A |
| REC3905159 | Marine VOLVO EGC 05/05>05/07 | AM26 |
| REC3905286 | Marine MTU-MDEC | AM28 |
| REC3905397 | Marine CATERPILLAR, PERKINS | AM29 |
| REC3906219 | Marine TOHATSU | AM30 |
| REC3906891 | Marine MAN | AM31 |
| REC3905015 | Personal Water Craft KAWASAKI cable kit | |



REC3902659



REC3902417



REC3905159

REC3904277



Conector redondo
Round connector
Connettore rotondo
Connecteur rond



REC3905397



REC3906219



REC3905286



REC3906891



REC3905015

INTERFACE AM01

Ref. AM01

REC3902358



CABLE
WIRE
CAVI
CÂBLE

| | | |
|------------|--|---------------|
| REC3902407 | Marine HONDA / TOHATSU, PGM (FI) | AM02 |
| REC3902247 | Marine 2 pin MERCURY, MERCURISER | AM04 |
| REC3902250 | Marine 4 pin MERCURY, MERCURISER | AM05 |
| REC3902413 | Marine YAMAHA / SELVA | AM06 |
| REC3902414 | Marine 6 pin VOLVO PENTA | AM07 |
| REC3902467 | Marine VOLVO KAD - TAMD | AM09 |
| REC3902864 | Marine STEYR | AM12 |
| REC3902865 | Marine EVINRUDE | AM13 |
| REC3902907 | Marine VOLVO, MERCURISER (gasolina fuel benzina essence), MEFI-4, 4B,3,2,1, CRUSADER | AM14 |
| REC3902931 | Marine YANMAR | AM15 |
| REC3903560 | Marine SUZUKI | AM22 |
| REC3905265 | Marine MERCURISER / VM D-Tronic | AM27 |
| REC3908405 | PARSUNS | 3151/ AP54 |



INTERFACE AM01CAN

Ref. AM01CAN

REC3903008



CABLE
WIRE
CAVI
CÂBLE

| | | |
|------------|--|------|
| REC3902960 | Marine VOLVO, MERCURISER (gasolina fuel benzina essence), MEFI-5 / EGC, ILMOR, CRUSADER, ILMOR, INDMAR, PCM (MEFI-5/EGC UBD-Msocket) | AM16 |
| REC3903502 | Marine VOLVO, EGC-EV | AM18 |
| REC3904778 | Marine MERCURY, MARINER, CUMMINS 2010+, MANDOS MCM, SMARTCRAFT | AM25 |
| REC3907103 | Marine STEYR with CAN Line protocol | AM32 |
| REC3907642 | YANMAR MARINE CAN CABLE | AM33 |



KIT DIAGNOSIS Y REPROGRAMACIÓN DE LLAVE CABLE KIT FOR DIAGNOSIS AND KEY REPROGRAMMING KIT PER LA DIAGNOSI E RIPROGRAMMAZIONE DI CHIAVE KIT DE DIAGNOSTIC ET REPROGRAMATION DE CLÉ

CABLE
WIRE
CAVI
CÂBLE

REC3906015 BRP Group

3151/AP43



PUNTAS DE DERIVACIÓN REFERRAL POINTS PUNTA DI DERIVAZIONE PONTS DE DÉRIVATION

CABLE
WIRE
CAVI
CÂBLE

REC3904048 AM10



Puede utilizarse con interface AM01 o AM01CAN dependiendo de la marca.

It can be used with AM01 or AM01CAN interface depending on the brand.

Può essere utilizzato con l'interfaccia AM01 o AM01CAN in base alla marca.

Peut être utilisé avec l'interface AM01 ou AM01CAN selon la marque.

SOPORTES

STANDS

SUPPORTI

SUPPORTS

SOPORTES DESCARGA DE EMBARCACIONES

RECH10
Para cargar o descargar embarcaiones de los remolques o cuna.
Los remolques pueden entrar y salir de entre los gatos hidráulicos libremente, facilitando su tarea.
Levantam embarcaciones de hasta 18 toneladas.
Su recorrido de elevación es de 51 cm.
Equipado con válvula de bloqueo que permite mantener el barco indefinidamente en la posición deseada.
Puede actuar sobre tierra, grava, asfalto o cemento, tanto en la tienda, como en el varadero o exposición.

BOAT HANDLING JACKS & STANDS

RECH10
Work station for bottom repair & cleaning. Trailer rolls in out past jacks, allowing you to take boats on or off trailers easily.
Jacks have an auto lock allowing boats to be left on indefinitely.
Can be used on dirt, gravel, black top or cement.
Can be used anywhere! Shop, yard, showroom.
Lifts boats up to 40,000 lbs.

SUPPORTI SCARICO IMBARCAZIONI

RECH10
Per caricare o scaricare imbarcazioni da rimorchi o sostegni.
I rimorchi possono entrare e uscire tra i crik idraulici liberamente, facilitando il compito.
Solleva imbarcazioni fino a 18 tonnellate.
Escursione max di 51 cm.
Fornito di valvola di blocco che permette di mantenere la barca nella posizione desiderata per diverso tempi.
Può essere usato su terra, ghiaia, asfalto o cemento, come in negozio o in esposizione.

SUPPORTS DE DÉCHARGE DE BATEAU

RECH10
Pour charger ou décharger des bateaux de remorques ou de berceaux.
Les remorques peuvent entrer et sortir librement entre les vérins hydrauliques, ce qui facilite leur tâche.
Ils lèvent des navires jusqu'à 18 tonnes.
Sa course d'élevation est de 51 cm.
Équipé d'une valve de blocage qui permet au navire d'être maintenu indéfiniment dans la position souhaitée.
Il peut agir sur terre, gravier, asphalte ou ciment, aussi bien en magasin qu'en hangar à bateaux ou en exposition.

| REF | INCLUYE | INCLUDED | INCLOSO | COMPREND |
|------------|---------------------------|-----------------------|--------------------------|---------------------------------|
| RECH10 | Soportes hidráulicos | Jacks | Supporti idraulici | Supports hydrauliques x 4 |
| | Soportes | Straight arms | Supporti | Supports x 4 |
| | Soportes inclinados 25 cm | 10" drop arms | Supporti inclinati 25 cm | Supports inclinés de 25 cm x 4 |
| | Soportes asiento barco | 4" x 18" contact pads | Supporti appoggi barche | Supports de siège de bateau x 4 |
| RECH10-1/4 | Soporte hidráulico | Jack | Supporto idraulico | Support hydraulique 1 |
| | Soporte | Straight arm | Supporto | Support 1 |
| | Soporte inclinados 25 cm | 10" drop arms | Supporto inclinato 25 cm | Support incliné de 25 cm 1 |
| | Soporte asiento barco | 4" x 18" contact pad | Supporto appoggio barche | Support de siège de bateau 1 |



| REF | | | | | |
|-------|--------------------|---------------------------|-------------------------|-----------------------|--------------------------|
| REC12 | Soporte plano std. | Straight support standard | Braccia piatto standard | Support plat standard | 83,8 - 132 cm |
| | 1ª posición | 1st pin hole | 1ª posizione | 1ère position | 900 kg |
| | 2ª posición | 2nd pin hole | 2ª posizione | 2ème position | 1.800 kg |
| | 3ª posición | 3rd pin hole | 3ª posizione | 3ème position | 3.600 kg |
| | 4ª posición | 4th pin hole | 4ª posizione | 4ème position | 4.500 kg |
| REC15 | Soporte inclinado | Drop arm | Braccia | Support incliné | 28 cm = 10" |
| REC16 | Soporte inclinado | Drop arm | Braccia | Support incliné | 51 cm = 20" |
| REC17 | Suplemento | Single riser extension | Suplementi | Supplement | 12,5 cm = 5" |
| REC18 | Suplemento | Single riser extension | Suplementi | Supplement | 25 cm = 10" |
| REC19 | Soporte con goma | Large pad | Braccia contatto | Support | 6.800 kg + 76 cm = 30" |
| REC20 | Soporte con goma | Large pad | Braccia contatto | Support | - 6.800 kg 45.7 cm = 18" |

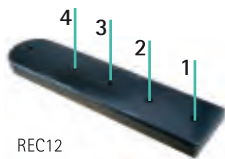

RECAMBIOS

SPARES

RICAMBIO

REPLACEMENT

| REF | RECMAR® | | | |
|----------|---------|--------|---------|-------|
| RECNSCYL | Pistón | Piston | Pistone | Vérin |

| REF | YARJAT® | | | |
|-------------|-------------------|-------------|--------------------|-------------------|
| YARSLKTN | Kit reparación | Repair kit | Kit riparazione | Kit de réparation |
| YARJAT | Rueda | Wheel | Ruota | Roue |
| YARNSTVALVE | Llave de recambio | Spare T key | Chiave di ricambio | Clé de rechange |



YARSLKTN



RECNSCYL



YARJAT



YARNSTVALVE

SOPORTES PARA EMBARCACIONES

BOAT STANDS

SUPPORTI PER IMBARCAZIONI

BERS ROULANT POUR BATEAU

REF



RECED36

1.500 kg

REF

RECED36C



RECMAR

SOPORTES PARA COLAS

STANDS FOR STERN DRIVES

SUPPORTI PER PIEDI

SUPPORTS D'EMBASES

RECJO6HD

Carro con gato hidráulico para la instalación de todo tipo de colas. Permite desmontar o montar colas, una sola persona. Especialmente útil en embarcaciones con plataforma integrada. Construido con brazos extra largos de sujeción y base con 4 ruedas neumáticas. Gran capacidad de elevación para colas de peso extra. También en colas de doble hélice. Varias regulaciones.

RECJO6HD

Stern drive installer. Works in all makes and models. Allows one man to remove and install stern drives. Especially helpful on boats with integrated swim platforms. Built with extra long clamping arms and wheel base, plus heavyduty lifting capacity for those extra heavy drives. Also works great on dual prop drives. Unique low cost shop tool. 4 air tires allow for rugged yard use.

RECJO6HD

Carro con crik idraulico per l'installazione di tutti i tipi di piedi. Permette ad una persona di smontare o montare i piedi da solo. Specialmente utile nelle imbarcazioni con piattaforma integrata. Costruito con larghi bracci di fissaggio e una base con 4 ruote pneumatiche. Grande capacità di sollevamento per piedi con peso extra. Anche per piedi con doppia elica. Varie regolazioni.

RECJO6HD

Chariot avec vérin hydraulique pour l'installation de tous types d'embase. Il permet à une seule personne de démonter ou de monter des pieds. Particulièrement utile dans les bateaux avec plate-forme intégrée. Construit avec des bras de support extra longs et une base avec 4 roues pneumatiques. Grande capacité de levage pour des embases de poids important. Egalement en arbre double hélice.

REF

RECJO6HD

RECMAR



RECAMBIOS

SPARES

RICAMBIO

REPLACEMENT

REF

| REF | | | | |
|----------------|------------------|-------------------------|-------------------|---------------------|
| RECKO CYL | Pistón | Piston | Pistone | Vérin |
| RECKRW | Rueda completa | Hydraulic jack RE-Wheel | Ruota completa | Roue complète |
| RECKFW | Rueda hidráulica | Hydraulic jack FT-Wheel | Ruota idraulica | Roue |
| RECJO10 | Suplemento 25 cm | Suplement 10" | Supplemento 25 cm | Supplément de 25 cm |
| RECHANDLEJO6HD | Maneta | Handle | Maniglia | Poignée |
| RECSRINGJO6HD | Muelle | Spring | Molla | Ressort |



RECKO CYL



RECJO10



RECKRW



RECKFW



RECHANDLEJO6HD

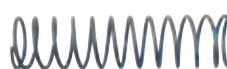

RECSRINGJO6HD

YASRS5
 Soporte para 5 colas.
 Mantiene el taller limpio y organizado.
 Protege las colas de golpes y daños.

YASRS5
 Holds 5 stern drives.
 Keeps shop looking neat and clean.
 Protects drives from being cratched and damaged.

YASRS5
 Supporto per 5 piedi.
 Mantiene l'officina pulita e organizzata.
 Protegge i piedi dai colpi e dai danni.

YASRS5
 Prise en charge de 5 embases.
 Maintient l'atelier propre et organisé.
 Protège les pieds d'embase des chocs et des dommages.

REF

YASRS5



REF

YASRSC



RECWS3
 Soporte trabajo reparación todo tipo de colas.

RECWS3
 Work station.
 Holds all kind of drives.

RECWS3
 Supporto lavoro per riparare tutti i tipi di piedi.

RECWS3
 Support pour les travaux de réparation de tous types d'embase.

REF

RECWS3



SOPORTES PARA MOTORES

STANDS FOR ENGINES

SUPPORTI PER MOTORI

SUPPORTS MOTEUR

Soporte de trabajo giratorio 360° con ruedas. Para todo tipo de motores; GM, FORD, VOLVO. Ideal para reparaciones completas.

Allow engine to be rotated 36 0°. Adjustable mounting plate will accommodate all engine types.

Carrello supporto motore, permette il movimento per 360° utile per lavorazioni in coppa. Fornito di ruote piene, può montare tutti i blocchi GM, FORD, VOLVO.

Support de travail rotatif à 360 ° avec roues. Pour tous types de moteurs; GM, FORD, VOLVO.

REF

RECTOOL1



YARES2

Soporte trabajo giratorio 360° con ruedas. Para todo tipo de motores: GM, FORD, VOLVO.

Ideal para reparaciones completas. Se le pueden adaptar los soportes referencias YARCHA para GM y YARFHA para FORD y probar motores en funcionamiento.

YARES2

360° rotating work support with wheels. For all types of engines: GM, FORD, VOLVO.

Ideal for complete repairs. You can adapt the YARCHA reference supports for GM and YARFHA for FORD and test running engines.

YARES2

Supporto lavoro girevole 360° con ruote.

Per tutti i tipi di motori: GM, FORD, VOLVO.

Ideale per riparazioni complete. Si possono adattare i supporti di riferimento YARCHA per GM e YARFHA per FORD e provare i motori in funzione.

YARES2

Support de travail rotatif à 360° avec roues. Pour tous types de moteurs : GM, FORD, VOLVO.

Idéal pour des réparations complètes. Vous pouvez adapter les supports de référence YARCHA pour GM et YARFHA pour FORD et tester les moteurs en cours d'exécution.

REF

| | |
|--------|-----------------|
| YARES2 | GM, FORD, VOLVO |
| YARFHA | Kit FORD |
| YARCHA | Kit GM |

YARDARM

YARFHA

YARCHA

**CARROS PORTAMOTOR**

Soporte portamotor con ruedas, para fueraborda. Con soporte para depósito de combustible y sandow de fijación. Fabricado en acero zincado y tablero marino de 43 cm. Diámetro ruedas: 15 cm

OUTBOARD MOTOR CARRIER

Manufactured in galvanized steel pipe and wooden board 43 cm. With tank holder and fixing strap. Diameter wheels: 15 cm.

CARRELLO PORTA MOTORE

Supporto porta motore con ruote, per fuoribordo. Con supporto per serbatoio carburante. In acciaio zincato e bordo marino da 43 cm. Diametro ruote: 15 cm

CHARIOT MOTEUR

Chariot-moteur avec roues, pour hors-bord. Avec support pour réservoir de carburant et fixation sandow. Fabriqué en acier galvanisé et planche marine de 43 cm. Diamètre de roue: 15 cm

Ref



12 kg



50 kg



90 cm

GS73122

GOLDENSHIP

Soporte portamotor con ruedas, para fueraborda. Con soporte para depósito de combustible y sandow de fijación. Fabricado en acero zincado y tablero marino de 45 cm. Diámetro ruedas: 36 cm

Manufactured in galvanized steel pipe and wooden board 45 cm. With tank holder and fixing strap. Diameter wheels: 36 cm.

Supporto porta motore con ruote, per fuoribordo. Con supporto per serbatoio carburante. In acciaio zincato e bordo marino da 45 cm. Diametro ruote: 36 cm

Chariot-moteur avec roues, pour hors-bord. Avec support pour réservoir de carburant et fixation sandow. Fabriqué en acier galvanisé et panneau marin de 45 cm. Diamètre de roue: 36 cm

Ref



12 kg



80 kg



95 cm

GS73119

GOLDENSHIP**SOPORTE EXPOSITOR OUTBOARD STAND**

Soporte portamotor con ruedas, para fueraborda. Plegable. Fabricado en acero zincado y tablero marino de 43 cm.

Folding display for outboards. Manufactured in galvanized steel pipe and wooden board of 43 cm.

SUPPORTO ESPOSITORE

Supporto per motori fuoribordo. Pieghevole. In acciaio zincato e bordo marino da 43 cm.

PRÉSENTOIR

Chariot-moteur sans roues, pour hors-bord. Pliable. Fabriqué en acier galvanisé et planche marine de 43 cm.

Ref



6 kg



40 kg



90 cm

GS73120

GOLDENSHIP

DIRECCIÓN MECÁNICA

STEERING SYSTEM

TIMONERIA MECCANICA

DIRECTION MÉCANIQUE

CAJA DE DIRECCIÓN AJUSTABLE ZTS

Con mecanismo antirretorno. Elimina el «feedback» de la hélice. Nº vueltas babor-estribor: 3,8. Para utilizar con cables 3000 SS. Reemplaza Teleflex-Morse® NFB Safe-T II, NFB 4.2, T73BRFC

ZTS ROTARY SINGLE HELM

Zero torque steering rotary helm. Eliminates prop feedback load. Precise response of 3.8 turns lock-to-lock. For use with the steering cables 3000 SS. Replaces Teleflex-Morse® NFB Safe-T II, NFB 4.2, T73BRFC

TIMONERIA ZTS

Timoneria con meccanismo anti-ritorno. Elimina il feedback delle eliche. Nº giri destra e sinistra: 3,8. Da utilizzare con cavi: 3000 SS. Rimpiazza TeleflexMorse®NFB Safe-T II, NFB 4.2, T73BRFC

BOÎTIER DE DIRECTION ZTS

Avec mécanisme anti-retour. Élimine le "retour" de l'hélice. Nombre de tours bâbord-tribord: 3.8. Utilisation avec les câbles 3000 SS. Remplace Teleflex-Morse® NFB Safe-T II, NFB 4.2, T73BRFC

REF

| | | | | |
|-----------|------------------------|---------------|--------------|----------------------|
| PRE500010 | Caja de dirección | Helm | Timoneria | Boitier de direction |
| PRE500012 | Ménsula de montaje 90° | Bezel kit 90° | Coprizzo 90° | Support incliné 90° |
| PRE500014 | Ménsula de montaje 20° | Bezel kit 20° | Coprizzo 20° | Support incliné 20° |



PRE500012



PRE500014



PRE500010

Caja de dirección con sistema de ángulo ajustable hasta 40°. Se acomoda la postura de conducción más idónea para el piloto.

Tilt rotary steering system to use with the steering cables 3000 SS. With full 40 degree range of motion.

Timoneria con sistema di angolo fino a 40°. Si può impostare la posizione più idonea di guida per il pilota.

Boîtier de direction avec système d'angle réglable jusqu'à 40°. Permet d'obtenir la position de conduite la plus appropriée pour le pilote.

REF

| | |
|-----------|------|
| PRE500007 | ZTS |
| PRE370987 | 3000 |



PRE500007



PRE370987

KIT LT

KIT LT

KIT LT

KIT LT

Compuesto por 1 caja operadora, 1 cable de dirección según las medidas indicadas y un bisel de montaje de 90°. Radio mínimo curvatura del cable 360°. Carrera del cable 230 mm con 2,5 vueltas de volante

Rotary steering system: Helm, Steering cable and 90° bezel. 2,5 turns lock to lock. Travel 230 mm.

Composto da una timoneria, 1 cavo timoneria secondo le dimensioni indicate e una piastra da 90°. Raggio minimo curvatura del cavo 360°. Corsa cavo 230mm con 2,5 giri del volante.

Composé d'un boîtier de commande, d'un câble de direction selon les mesures indiquées et d'un support incliné à 90°. Course du câble 230 mm avec 2,5 tours de volant

REF

| | | | |
|-----------|--------------|-------|-------|
| PRE208005 | 5' / 1,50 m | 5,5 m | 55 hp |
| PRE208006 | 6' / 1,80 m | | |
| PRE208007 | 7' / 2,10 m | | |
| PRE208008 | 8' / 2,45 m | | |
| PRE208009 | 9' / 2,75 m | | |
| PRE208010 | 10' / 3,05 m | | |

REF

| | | | |
|-----------|--------------|-------|-------|
| PRE208011 | 11' / 3,35 m | 5,5 m | 55 hp |
| PRE208012 | 12' / 3,65 m | | |
| PRE208013 | 13' / 3,95 m | | |
| PRE208014 | 14' / 4,25 m | | |
| PRE208015 | 15' / 4,60 m | | |
| PRE208016 | 16' / 4,90 m | | |



steerflex



| KIT 3000 SS | KIT 3000 SS | KIT 3000 SS | KIT 3000 SS |
|---|--|---|--|
| <p>Compuesto por 1 caja operadora, 1 cable de dirección fabricado en acero inox según medidas indicadas y un bisel de montaje de 90°.</p> <p>Para embarcaciones con un esfuerzo máximo de 140 kg en el punto de unión. Puede montarse en cualquier posición con movimientos de 90°.</p> <p>Radio mínimo curvatura del cable 200 mm. Carrera del cable 230 mm con 3,6 vueltas de volante</p> <p>Reemplaza Teleflex-Morse® Safe-T QC, Safe-T, Uflex T71FC</p> | <p>Rotary steering system: Helm, Stainless Steel Cable and 90° Bezel.</p> <p>Stainless steel inner cable with spring stainless steel enclosure coil.</p> <p>Maximum working load: 300 lb at the tiller arm.</p> <p>Three turns lock to lock. Travel 230 mm.</p> <p>Replaces Teleflex-Morse® Safe-T QC, Safe-T, Uflex T71FC</p> | <p>Composto da una timoneria, 1 cavo timoneria in acciaio inox, secondo le misure richieste e una piastra di montaggio di 90°.</p> <p>Per imbarcazioni con uno sforzo massimo di 140kg nel punto di unione. Si può montare in qualunque posizione con un movimento di 90°. Raggio minimo curvatura 200mm.</p> <p>Corsa del cavo 230mm con 3,6 giri del volante.</p> <p>Rimpiazza Teleflex-Morse® Safe-T QC, Safe-T, Uflex T71FC</p> | <p>Composé de 1 boîtier de commande, 1 câble de direction en acier inoxydable selon les mesures indiquées et un support incliné à 90°.</p> <p>Pour les bateaux avec un effort maximum de 140 kg au point de jonction.</p> <p>Course du câbles 230 mm avec 3,6 tours de volant</p> <p>Remplace Teleflex-Morse® Safe-T QC, Safe-T, Uflex T71FC</p> |

| REF | | |
|-----------|--------------|-----|
| PRE315008 | 8' / 2,45 m | 8 m |
| PRE315009 | 9' / 2,75 m | |
| PRE315010 | 10' / 3,05 m | |
| PRE315011 | 11' / 3,35 m | |
| PRE315012 | 12' / 3,65 m | |
| PRE315013 | 13' / 3,95 m | |
| PRE315014 | 14' / 4,25 m | |

| REF | | |
|-----------|--------------|-----|
| PRE315015 | 15' / 4,60 m | 8 m |
| PRE315016 | 16' / 4,90 m | |
| PRE315017 | 17' / 5,20 m | |
| PRE315018 | 18' / 5,50 m | |
| PRE315019 | 19' / 5,80 m | |
| PRE315020 | 20' / 6,10 m | |



| CABLES DE DIRECCIÓN LT | LT STEERING CABLE | CAVO DI TIMONERIA LT | CÂBLES DE DIRECTION LT |
|------------------------|-------------------|----------------------|------------------------|
|------------------------|-------------------|----------------------|------------------------|

| REF | |
|-----------|--------------|
| PRE250005 | 5' / 1,50 m |
| PRE250006 | 6' / 1,80 m |
| PRE250007 | 7' / 2,10 m |
| PRE250008 | 8' / 2,45 m |
| PRE250009 | 9' / 2,75 m |
| PRE250010 | 10' / 3,05 m |

| REF | |
|-----------|--------------|
| PRE250011 | 11' / 3,35 m |
| PRE250012 | 12' / 3,65 m |
| PRE250013 | 13' / 3,95 m |
| PRE250014 | 14' / 4,25 m |
| PRE250015 | 15' / 4,60 m |
| PRE250016 | 16' / 4,90 m |



| CABLES DE DIRECCIÓN 3000 SS DE ACERO INOX | STEERING CABLE 3000 SS STAINLESS STEEL | CAVO TIMONERIA 3000 SS ACCIAIO INOX | CÂBLES DE DIRECTION 3000 SS ACIER INOXYDABLE |
|---|--|-------------------------------------|--|
|---|--|-------------------------------------|--|

| REF | |
|-----------|--------------|
| PRE550008 | 8' / 2,45 m |
| PRE550009 | 9' / 2,75 m |
| PRE550010 | 10' / 3,05 m |
| PRE550011 | 11' / 3,35 m |
| PRE550012 | 12' / 3,65 m |
| PRE550013 | 13' / 3,95 m |
| PRE550014 | 14' / 4,25 m |
| PRE550015 | 15' / 4,60 m |
| PRE550016 | 16' / 4,90 m |
| PRE550017 | 17' / 5,20 m |

| REF | |
|-----------|--------------|
| PRE550018 | 18' / 5,50 m |
| PRE550019 | 19' / 5,80 m |
| PRE550020 | 20' / 6,10 m |
| PRE550021 | 21' / 6,40 m |
| PRE550022 | 22' / 6,70 m |
| PRE550023 | 23' / 7,00 m |
| PRE550024 | 24' / 7,30 m |
| PRE550025 | 25' / 7,60 m |
| PRE550026 | 26' / 7,90 m |



| CABLES DE DIRECCIÓN MEGA-UR | MEGA-UR STEERING CABLE | CAVO TIMONERIA MEGA-UR | CÂBLES DE DIRECTION MEGA-UR |
|-----------------------------|------------------------|------------------------|-----------------------------|
|-----------------------------|------------------------|------------------------|-----------------------------|

Reemplaza | Replace | Rimpiazzano | Remplace:
 Ultraflex T71FC, T72FC, T73NR FC, T81FC, T82FC, T83NR FC.
 Teleflex Safe-T QC, NFB 4.2, NFB Safe-T II

| REF | |
|-----------|--------------|
| PRE509007 | 7' / 2,14 m |
| PRE509008 | 8' / 2,45 m |
| PRE509009 | 9' / 2,75 m |
| PRE509010 | 10' / 3,05 m |
| PRE509011 | 11' / 3,35 m |
| PRE509012 | 12' / 3,65 m |
| PRE509013 | 13' / 3,95 m |

| REF | |
|-----------|--------------|
| PRE509014 | 14' / 4,25 m |
| PRE509015 | 15' / 4,60 m |
| PRE509016 | 16' / 4,90 m |
| PRE509017 | 17' / 5,20 m |
| PRE509018 | 18' / 5,50 m |
| PRE509019 | 19' / 5,80 m |
| PRE509020 | 20' / 6,10 m |



| ACCESORIOS DIRECCIÓN MECÁNICA | ACCESSORIES FOR STEERING SYSTEM | ACCESSORI PER TIMONERIA MECCANICA | ACCESSOIRES POUR DIRECTION MÉCANIQUE |
|-------------------------------|---|---|--|
| REF | | | |
| PRE370618 | Cardan de unión del cable de dirección al motor. Swivel joint for steering cables. | Per unire cavi timoneria al motore. | Union cardan du câble de direction au moteur. |
| PRE370046 | Soporte para cable de dirección. Para montaje en el espejo de popa Bracket kit for inboard transom steering mount. | Supporto per cavi timoneria. Per il montaggio nello specchio di poppa. | Support pour câble de direction. Pour montage sur le tableau AR |
| PRE370613 | Soporte para cable de dirección. Para montaje estanco en los laterales de la embarcación. Regulable. Bracket kit for inboard side splashwell steering mount. | Supporto per cavi timoneria. Montaggio della flangia ai lati dell'imbarcazione. Regolabile. | Support pour câble de direction. Pour un montage étanche sur les côtés du bateau. Réglable. |
| PRE370619 | Rótula para unión rápida del cable de dirección al motor. Ball joint for steering cables. | Giunto per unire i cavi timoneria al motore. | Rotule pour une connexion rapide du câble de direction au moteur. |
| PRE370621 | Barra de reenvío para conexión de los cables de dirección. Fabricada en acero inox. Reforzada. Link arm for outboards steering. | Barra di direzione per collegare i cavi. In acciaio inox. Rinforzata. | Barre de renvoi pour connecter les câbles de direction. Fabriqué en acier inoxydable. Renforcé |



PRE370618



PRE370046



PRE370619



PRE370613



PRE370621

DIRECCIÓN HIDRÁULICA

HYDRAULICS STEERING SYSTEM

TIMONERIA IDRAULICA

DIRECTION HYDRAULIQUE

| FUERABORDAS 150 HP | OUTBOARDS 150 HP | FUORIBORDO 150 HP | HORS-BORD 150 HP |
|--|--|---|---|
| Bomba de aluminio, con válvula antirretorno incorporada. Cilindro de aluminio y acero inox. con purgadores. Se suministra completa con racors, tubo flexible de rilsan y 2L de aceite hidráulico | Helm pump made in aluminum, with non-return valve incorporated. Cylinder in aluminum and stainless steel, with breather valves. Completed with racors, rilsan tubing and 2L hydraulic oil. | Corpo pompa in alluminio, con valvola anti-ritorno incorporata. Cilindro in alluminio e acciaio inox, con spurgo. Si vende completa di raccordi, tubo flessibile e 2 l di olio idraulico. | Pompe en aluminium, avec clapet anti-retour intégré. Vérin en aluminium et acier inoxydable. Livré complet avec raccords, tube flexible et 2L d'huile hydraulique |

| | | | | TX4200K 150 HP | TX6400K 300 HP |
|---------------------------|--------------------|-----------------------------|---------------------------|---------------------|----------------------|
| Modelo bomba | Pump model | Modelo pompa | Modèle de pompe | BayStar | SeaStar |
| Capacidad bomba | helm volume | Cap. Pompa | Capacité de la pompe | 23 cm ³ | 27,8 cm ³ |
| Modelo cilindro | Cylinder model | Mod. Cilindro | Modèle de vérin | HC4645H | HC5345H |
| Capacidad cilindro | Cylinder volume | Cap. Cilindro | Cylindrée | 105 cm ³ | 139 cm ³ |
| Carrera del pistón | Cylinder travel | Corsa pistone | Course du vérin | 206 mm | 206 mm |
| Nº vueltas babor-estribor | Turns lock to lock | Nº giri a destra e sinistra | No. tourne bâbord-tribord | 5 | 5 |
| Manguera con racors | Hose with racors | Tubo con raccordo | Tuyau avec raccords | 2 x 6 m | 2 x 7 m |
| Velocidad máxima | Max. speed | Velocità max | Vitesse maximale | 50 kn | 65 kn |

BayStar
TX4200K



SeaStar
TX6400K

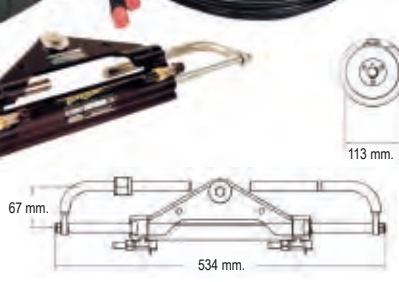

TUBOS HIDRÁULICOS PARA TX6400K

HYDRAULIC HOSES FOR TX6400K

TUBI IDRAULICI PER TX6400K



TUYAUX HYDRAULIQUES POUR TX6400K

2 Tubos con racors montados

Pair of hydraulic hoses with racors

2 tubi con raccordi montati

2 tuyaux avec raccords montés

| | | |
|----------|---|---|
| REF |  |  |
| TXMP5126 | 26' / 8 m | 2 |

Seastar



KITS

KIT

KITS

KITS

Bomba de aluminio, con válvula anti-retorno y sobrepresión. Cilindro de aluminio y acero inoxidable, con purgadores. Se suministra completa con racors de latón cromado, tubo flexible de rilsan y aceite hidráulico.

Helm pump made in aluminum, with a non-return and pressure relief valves. Cylinder in aluminum and stainless steel, with breather valves. Completed with racors, rilsan tubing and hydraulic oil.

Corpo pompa in alluminio con valvola anti-ritorno e sovrappresione. Cilindro in alluminio e acciaio inox, con spurgo. Si vende completa di raccordi in ottone cromato, tubo flessibile e olio idraulico.

Pompe en aluminium, avec soupape de refoulement et de surpression. Vérin en aluminium et acier inoxydable. Livré complet avec raccords en laiton chromé, tuyau flexible et huile hydraulique.

| | | | | GS41062 80 hp | GS41065 150 hp | GS41066 300 hp | GS41059 350 hp |
|---------------------------|--------------------|---------------------------|--------------------------|--------------------|--------------------|---------------------|---------------------|
| Modelo bomba | Pump model | Modello pompa | Modèle de pompe | GM3-MRA | GMO-MRA | GM2-MRA01 | GM2-MRA01 |
| Capacidad bomba | helm volume | Cap. Pompa | Capacité de la pompe | 14 cm ³ | 17 cm ³ | 27 cm ³ | 27 cm ³ |
| Modelo cilindro | Cylinder model | Mod. Cilindro | Modèle de vérin | MC90B | MC150BR | MC300A | MC350A |
| Capacidad cilindro | Cylinder volume | Cap. Cilindro | Cylindrée | 75 cm ³ | 83 cm ³ | 130 cm ³ | 140 cm ³ |
| Carrera del pistón | Cylinder travel | Corsa pistone | Course du vérin | 206 mm | 200 mm | 198 mm | 198 mm |
| Nº vueltas babor-estribor | Turns lock to lock | Nº giri destra e sinistra | No. tours bâbord-tribord | 5,2 | 4,9 | 4,9 | 5,2 |
| Manguera con racors | Hose with racors | Tubo con raccordo | Tuyau avec raccords | 2 x 5 m | 2 x 6 m | 2 x 7 m | 2 x 7,5 m |
| Ø Tubo | Tube Ø | Ø Tubo | Ø Tuyau | 6,3 mm = 1/4" | 6,3 mm = 1/4" | 7,94 mm = 5/16" | 7,94 mm = 5/16" |



GS41062



GS41065



GS41066



GS41059



KITS DIRECCIÓN HIDRAULICA PARA COLAS **HYDRAULIC STEERING FOR STERN-DRIVE KITS** **KIT TIMONERIA IDRAULICA PER PIEDI** **DIRECTION HYDRAULIQUE POUR EMBASE**

Bomba de aluminio estampado en caliente. Eje de acero inox AISI 316. Rotor a 7 pistones fabricado en acero. Cilindro de aluminio y acero inox. Se suministra completa con racors, 2 x 7,5 m tubo flexible de rilsan y 2 L de aceite hidráulico.

Helm pump made in aluminum with hot pressing processing (not casting). Shaft made of stainless steel AISI 316. 7 pistons rotor made in steel. Cylinder in aluminum and stainless steel, with breather valves. Completed with racors, rilsan tubing and 2 L hydraulic oil.

Corpo pompa in alluminio con stampaggio a fusione. Asse in acciaio inox AISI316. Cilindro a 7 pistoni fabbricato in acciaio. Cilindro in alluminio e acciaio inox. Si vende completo di raccordi, 2x7,5 m di tubo flessibile e 2 l di olio idraulico.

Pompe en aluminium estampé à chaud. Arbre en acier inoxydable AISI 316. Rotor à 7 pistons en acier. Vérin en aluminium et acier inoxydable. Livré complet avec raccords, 2 tuyaux flexibles de 7,5 m et 2 litres d'huile hydraulique.

| SERVO-ASISTIDA | POWER ASSISTED | SERVOASSISTITO | ASSISTÉE | GS41053 |
|---------------------------|--------------------|---------------------------|--------------------------|--------------------|
| Denominación | Model | Modello | Dénomination | GF150ET |
| Modelo bomba | Pump model | Modello pompa | Modèle de pompe | GM2-MRA01 |
| Capacidad bomba | helm volume | Cap. pompa | Capacité de la pompe | 27 cm ³ |
| Modelo cilindro | Cylinder model | Mod. cilindro | Modèle de vérin | MC150 |
| Capacidad cilindro | Cylinder volume | Cap. pompa | Cylindrée | 88cm ³ |
| Carrera del pistón | Cylinder travel | Corsa pistone | Course du vérin | 200 mm |
| Peso bomba | Helm weight | Peso pompa | Poids de la pompe | 3 kg |
| Nº vueltas babor-estribor | Turns lock to lock | Nº giri destra e sinistra | No. tours bâbord-tribord | 3,4 |
| Ø Tubo | Tube Ø | Ø Tubo | Ø Tuyau | 7,94 mm / 5/16" |
| Longitud tubo | Tube length | Lungh. tubo | Longueur tuyau | 2 x 7,5 m |



| SIN SERVO | NON POWER ASSISTED | SERVOASSISTITO | ASSISTÉE | GS41054 |
|---------------------------|--------------------|---------------------------|--------------------------|---------------------|
| Denominación | Model | Modello | Dénomination | GF300BET |
| Modelo bomba | Pump model | Modello pompa | Modèle de pompe | GM2-MRA03 |
| Capacidad bomba | helm volume | Cap. pompa | Capacité de la pompe | 32 cm ³ |
| Modelo cilindro | Cylinder model | Mod. cilindro | Modèle de vérin | MC300BET |
| Capacidad cilindro | Cylinder volume | Cap. cilindro | Cylindrée | 146 cm ³ |
| Carrera del pistón | Cylinder travel | Corsa pistone | Course du vérin | 200 mm |
| Peso bomba | Helm weight | Peso pompa | Poids de la pompe | 3,7 kg |
| Nº vueltas babor-estribor | Turns lock to lock | Nº giri destra e sinistra | No. tours bâbord-tribord | 4,6 |
| Ø Tubo | Tube Ø | Ø Tubo | Ø Tuyau | 7,94 mm / 5/16" |
| Longitud tubo | Tube length | Lungh. tubo | Longueur tuyau | 2 x 7,5 m |



ACCESORIOS DIRECCIÓN HIDRAULICA **ACCESSORIES FOR HYDRAULIC STEERING SYSTEM** **ACCESSORI PER TIMONERIA IDRAULICA** **ACCESSOIRES POUR DIRECTION HYDRAULIQUE**

| REF | R.O. OEM | | | | (mm) | |
|---------|------------------------------|---|---|---|---|-----------|
| GS41080 | | Barra de dirección para conexión de los cables de dirección. Acero inox. | Link arm for outboards steerings. Stainless steel. | Barra di rinvio per la connessione dei cavi timoneria. Fabbricata in acciaio inox. | Barre de renvoi pour connecter les câbles de direction. Acier inoxydable. | 320 - 340 |
| GS41082 | | Barra de dirección con conexión rápida para conexión de los cables de dirección. Acero inox. | Link arm quick connection for outboards steerings. Stainless steel. | Barra di rinvio con connessione rapida per la connessione dei cavi timoneria. Fabbricata in acciaio inox. | Barre de renvoi avec connexion rapide pour connecter les câbles de direction. Acier inoxydable. | 330 - 370 |
| GS41083 | | Barra de unión para el acople de dos motores | Universal tie bar for two engines | Barra di unione per accoppiamento di due motori. | Barre d'accouplement pour deux moteurs | 850 |
| GS41084 | 6E5-61301-01 6E5-61301-00 | Barra de unión con conexión a rótula para el acople de dos motores fueraborda hasta 300 hp. Acero inox. Aisi 316. | Universal tie bar with spherical joint for two engines up to 300 hp. Made in stainless steel. | Barra di unione con snfo sferico per due motori fuoribordo fino a 300hp. In acciaio inox aisi316 | Kit barre d'accouplement à rotule pour deux moteurs hors-bord jusqu'à 300 ch. Acier inoxydable. Aisi 316. | 640 - 780 |

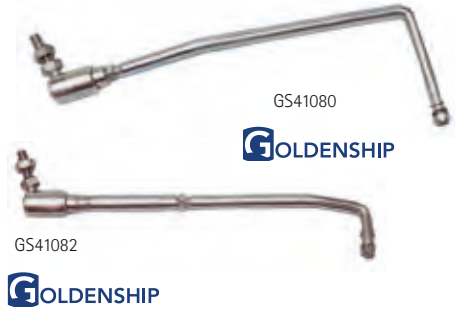

BOMBA **PUMP** **POMPA** **POMPE**

| REF | R.O. OEM |
|---------|-----------|
| GS41070 | GM3-MRA |
| GS41071 | GM0-MRA |
| GS41072 | GM2-MRA01 |
| GS41073 | GM2-MRA03 |



CILINDRO

CYLINDER

CILINDRO

VERIN

| REF | R.O. OEM |
|---------|----------|
| GS41077 | MC350HD |
| GS41060 | MC90B |
| GS41063 | MC150BR |
| GS41089 | MC300A |



CONECTORES

CONNECTORS

PIASTRA CONNESSIONE

CONNECTEURS

| REF | | |
|---------|---|---|
| GS41067 | Honda 115-130 | 1 |
| GS41068 | Yamaha 40-50-60-70 HP Honda 115-130 HP | 1 |
| GS41069 | Mercury Optimax 115 Mercury 150 EFI | 1 |



GS41069



GS41067



GS41068

ACEITE PARA DIRECCIÓN HIDRÁULICA

OIL FOR HYDRAULIC STEERING SYSTEM

OLIO PER TIMONERIA IDRAULICA

HUILE POUR DIRECTION HYDRAULIQUE

| REF | |
|---------|-----|
| GS41074 | 1 L |



MANDOS UNIVERSALES Y ACCESORIOS

UNIVERSAL CONTROLS AND ACCESSORIES

CONTROLLI UNIVERSALI E ACCESSORI

COMMANDES UNIVERSELLES ET ACCESSOIRES

MANDO ELECTRÓNICO

ELECTRONIC CONTROL

SCATOLA DI COMANDO

COMMANDE ÉLECTRONIQUE

Reemplaza y mejora el funcionamiento de los mandos mecánicos tradicionales, permitiendo un control más preciso y suave de las maniobras.

Se suministran en kits completos con todos los componentes para sustituir de modo sencillo los mandos tradicionales, listos para instalar y operar.

Sistema de conexión CANbus.

Alimentación estandar 12V (24V Bajo demanda).

- Hasta 6 puestos de control.
- Sincronización de r.p.m. en ambos motores.
- Posibilidad de aumentar y reducir las revoluciones del motor mediante ligeras pulsaciones de los botones de control.
- Puede incorporar mandos de control remoto mediante conexión «CANbus».
- Memoria de diagnósticos de avisos y alarmas.

Easily upgrade the traditional boat mechanical controls.

Gives finger tip, precise control of your engines shift and throttle functions.

Supplied in complete kits with all components required and ready to install. Latest CANbus technology for easy installation and set up.

12V Standard power (24V on demand).

- Can be connected up to 6 control heads.
- Auto synchronization r.p.m.
- Possibility of throttle in «BUMP» mode.
- Can incorporate Handheld Remote Controls.
- Memory of diagnostics checks of warning and alarms.



Sostituisce e migliora la scatola di comando tradizionale, permettendo un controllo più preciso delle manovre. Si vende in kit completo con tutti i componenti richiesti per sostituire in modo semplice la scatola di comando tradizionale.

Tecnologia CANbus, Alimentazione standard **12V** (24V on demand).

- Fino a 6 postazioni di controllo
- Auto sincronizzazione r.p.m.
- Possibilità di diminuire e aumentare i giri del motore, tramite un pulsante di controllo.
- Si può incorporare comandi di controllo remoto tramite la connessione CANbus
 - Memoria diagnostica di avviso e allarme.

Elle remplace et améliore le fonctionnement des commandes mécaniques traditionnelles, permettant un contrôle plus précis et plus fluide des manœuvres.

Ils sont fournis en kits complets avec tous les composants pour remplacer facilement les commandes traditionnelles, prêts à installer et à utiliser.

Système de connexion CANbus.

Alimentation standard **12V** (24V sur demande).

- Jusqu'à 6 points de contrôle peuvent être connectés.
- Synchronisation de r.p.m. dans les deux moteurs.
- Possibilité d'augmenter et de réduire les tours du moteur en appuyant légèrement sur les boutons de commande.
- Vous pouvez intégrer des commandes de télécommande via une connexion «CANbus».
- Mémoire de diagnostic des avertissements et alarmes.



| KITS | KITS | KIT | KITS | |
|--|---------------------------------------|---|---|-----------------|
| 1 MOTOR INTERIOR 1 ESTACIÓN | 1 INBOARD ENGINE 1 STATION | 1 MOTORE ENTROBORDO 1 STAZIONE | 1 MOTEUR IN-BORD 1 STATION | GLE1M1EI |
| Actuador SA2 | Actuator SA2 | 1 attuatore SA2 | Actionneur SA2 | 1 |
| Mando 1 palanca - 2 pulsadores | Single Control Head - 2-buttons | Telecomando 1 leva - 2 pulsanti | 1 commande à levier - 2 boutons | 1 |
| Cable comunicación mando-actuador 12 m | Station comm. cable 40ft. | Cavo comunicazione comando-attuatore 12m | Câble de communication commande-actionneur 12 m | 1 |
| Resistencia terminal BUS | Terminating resistor | Resistenza terminale BUS | Résistance de borne BUS | 2 |
| Cable alimentación DC - actuador 9 m. | Harness DC power-actuador 30ft. | Cavo alimentazione DC- attuatore 9m | Câble d'alimentation CC - actionneur 9 m. | 1 |
| Cable Start Interlock 9 m | Harness Start Interlock 30ft | Cablaggio start e blocco 9m | Câble de verrouillage de démarrage 9 m | 1 |
| Cable encendido «jumper» | Harness Ignition enable jumper | Cablaggio accensione | Câble d'allumage de cavalier | 1 |
| Cable encendido 9 m | Harness Ignition 40ft. | Cablaggio accensione | Câble sur 9 m | 1 |

| KIT 2ª ESTACIÓN 1 MOTOR INTERIOR | KIT 2ND STATION 1 ENGINE INBOARD | KIT 2ª STAZIONE 1 MOTORE ENTROBORDO | KIT DE 2E STATION 1 MOTEUR IN-BORD | GLE1M2EI |
|--|-------------------------------------|--|---|----------|
| Mando 1 palanca - 2 pulsadores | Single Control Head - 2-buttons | Telecomando- 1 leva- 2 pulsanti | 1 commande à levier - 2 boutons | 1 |
| Cable comunicación mando-actuador 12 m | Station comm. cable 40ft. | Cavo cablaggio comando-attuatore 12m. | Câble de communication commande-actionneur 12 m | 1 |

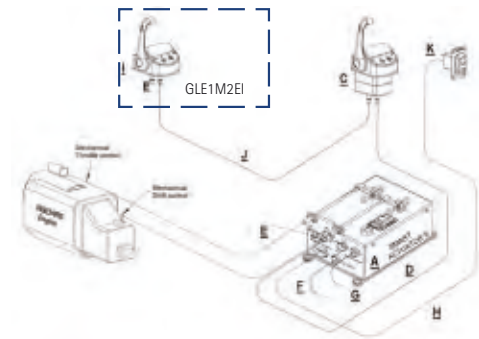

| 2 MOTORES INTERIORES 1 ESTACIÓN | 2 INBOARD ENGINES 1 STATION | 2 MOTORI ENTROBORDO 1 STAZIONE | 2 MOTEURS IN-BORD 1 STATION | GLE2M1EI |
|--|----------------------------------|--------------------------------------|--|----------|
| Actuador SA2 | Actuator SA2 | Attuatore SA2 | Actionneur SA2 | 2 |
| Mando 2 palanca - 2 pulsadores | Twin Control Head - 2-buttons | Telecomando 2 leve- 2 pulsanti | 2 commandes à levier - 2 boutons poussoirs | 1 |
| Cable comunicación mando-actuador 12 m | Station comm. cable 40ft. | Cavo cablaggio comando-attuatore 12m | Câble de communication commande-actionneur 12 m | 1 |
| Cable comunicación actuador-actuador 6 m | Station comm. cable 20ft. | Cavo cablaggio comando-attuatore 6m | Câble de communication actionneur-actionneur 6 m | 1 |
| Resistencia terminal BUS | Terminating resistor | Resistenza terminale BUS | Résistance de borne BUS | 2 |
| Cable alimentación DC - actuador 9 m. | Harness DC power-actuador 30ft. | Cavo alimentazione BUS-attuatore 9m | Câble d'alimentation CC - actionneur 9 m. | 2 |
| Cable Start Interlock 9 m | Harness Start Interlock 30ft | Cablaggio start e blocco 9m | Câble de verrouillage de démarrage 9 m | 2 |
| Cable encendido «jumper» | Harness Ignition enable jumper | Cablaggio accensione | Câble d'allumage de cavalier | 1 |
| Cable actuador sensor tacómetro | Harness Act. enable tach sender. | Cavo attuatore sensore tachimetro | Câble d'actionneur de capteur de tachymètre | 1 |
| Cable encendido 12 m | Harness Ignition 40ft. | Cavo accensione 12m | Câble sur 12 m | 1 |

| KIT 2ª ESTACIÓN 2 MOTORES INTERIOR | KIT 2ND STATION 2 ENGINE INBOARD | KIT 2ª STAZIONE 2 MOTORI ENTROBORDO | KIT DE 2E STATION 2 MOTEURS IN-BORD | GLE2M2EI |
|--|-------------------------------------|--|---|----------|
| Mando 2 palanca - 2 pulsadores | Twin Control Head - 2-buttons | Telecomando 2 leve-2 pulsanti | 2 commandes à levier - 2 boutons poussoirs | 1 |
| Cable comunicación mando-actuador 12 m | Station comm. cable 40ft. | Cavo cablaggio comando-attuatore 12m | Câble de communication commande-actionneur 12 m | 1 |

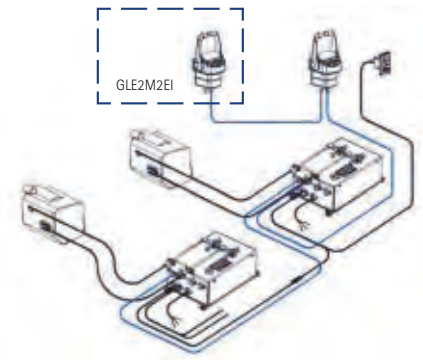

| 1 MOTOR INTRA/FUERABORDA O FUERABORDA 1 ESTACIÓN + TRIM | 1 ENGINE I/O - OUTBOARD 1 STATION + TRIM | 1 MOTORE ENTRO/FUORIBORDO O FUORIBORDO 1 STAZIONE + TRIM | 1 MOTEUR IN-BORD OU HORS-BORD 1 STATION + GARNITURE | GLE1M1EC |
|--|---|---|--|----------|
| Actuador SA2 | Actuator SA2 | Attuatore SA2 | Actionneur SA2 | 1 |
| Mando 1 palanca - 6 pulsadores | Single Control Head - 6-buttons | Telecomando 1 leva- 6 pulsanti | 1 commande à levier - 6 boutons | 1 |
| Cable comunicación mando-actuador 12 m | Station comm. cable 40ft. | Cavo cablaggio comando-attuatore 12m | Câble de communication commande-actionneur 12 m | 1 |
| Resistencia terminal BUS | Terminating resistor | Resistenza terminale BUS | Résistance de borne BUS | 2 |
| Cable alimentación DC - actuador 9 m. | Harness DC power-actuator 30ft. | Cavo alimentazione DC- attuatore 9m | Câble d'alimentation CC - actionneur 9 m. | 1 |
| Cable Trim/Encendido/Start interlock | Harness Trim/Ignition/Start Interlock | Cavo trim/accensione/start e blocco | Câble de verrouillage Trim / On / Start | 1 |

| KIT 2ª ESTACIÓN 1 MOTOR INTRA/FUERABORDA O FUERABORDA 2 ESTACIONES + TRIM | KIT 2ND STATION 1 ENG. I/O - OUTBOARD 2 STATIONS + TRIM | KIT 2° STAZIONE 1 MOTORE ENTRO/FUORIBORDO O FUORIBORDO 2 STAZIONE + TRIM | KIT DE 2E STATION 1 MOTEUR IN-BORD OU HORS-BORD 2 STATIONS + GARNITURE | GLE1M2EC |
|---|---|--|--|----------|
| Mando 1 palanca - 6 pulsadores | Single Control Head - 6-buttons | Telecomando 1 leva- 6 pulsanti | 1 commande à levier - 6 boutons | 1 |
| Cable comunicación mando-actuador 12 m | Station comm. cable 40ft. | Cavo cablaggio comando-attuatore 12m | Câble de communication commande-actionneur 12 m | 1 |

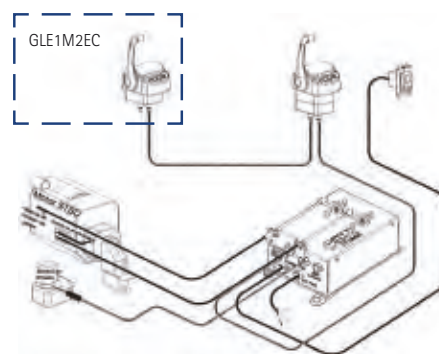

| 2 MOTORES INTRA/FUERABORDA O FUERABORDA 1 ESTACIÓN + TRIM | 2 INBOARD ENGINES 1 STATION | 1 MOTORE ENTRO/FUORIBORDO O FUORIBORDO 1 STAZIONE + TRIM | 2 MOTEURS IN-BORD OU HORS-BORD 1 STATION + GARNITURE | GLE2M1EC |
|--|-----------------------------------|---|---|----------|
| Actuador SA2 | Actuator SA2 | Attuatore SA2 | Actionneur SA2 | 2 |
| Mando 2 palancas - 6 pulsadores | Twin Control Head - 6-buttons | Telecomando 2 leve- 6 pulsanti | Contrôle 2 leviers - 6 boutons | 1 |
| Cable comunicación mando-actuador 12 m | Station comm. cable 40ft. | Cavo cablaggio comando-attuatore 12m | Câble de communication commande-actionneur 12 m | 1 |
| Cable comunicación actuador-actuador 6 m | Station comm. cable 20ft. | Cavo cablaggio comando- attuatore 6m | Câble de communication actionneur-actionneur 6 m | 1 |
| Resistencia terminal BUS | Terminating resistor | Resistenza terminale BUS | Résistance de borne BUS | 2 |
| Cable alimentación DC - actuador 9 m. | Harness DC power-actuator 30ft. | Cavo alimentazione DC- actuatore 9m | Câble d'alimentation CC - actionneur 9 m. | 2 |
| Cable Encendido/Tacómetro babor. | Harness Ignition/Tach sender port | Cavo accensione/ tachimetro sinistra | Tachymètre pour câble d'alimentation / port. | 1 |
| Cable Tacómetro esribor. | Harness Tach sender starboard. | Cavo tachimetro destra | Câble tachymètre tachymétrique. | 1 |
| Cables Trim / Start Interlock. | Harness Trim / Start Interlock. | Cavo trim/ start e blocco | Trim / Start Interlock cables. | 2 |

| KIT 2ª ESTACION 2 MOTORES INTRA/FUERABORDA O FUERABORDA 2 ESTACIONES + TRIM | KIT 2ND STATION 2 ENGINE I/O - OUTBOARD 2 STATIONS + TRIM | KIT 2° STAZIONE 2 MOTORE ENTRO/FUORIBORDO O FUORIBORDO 2 STAZIONE + TRIM | KIT DE 2E STATION 2 MOTEURS IN-BORD OU HORS-BORDRES 2 STATIONS + GARNITURE | GLE2M2EC |
|---|---|--|--|----------|
| Mando 2 palanca - 6 pulsadores | Twin Control Head - 6-buttons | Telecomando 2 leve- 6 pulsanti | 2 commandes à levier - 6 boutons | 1 |
| Cable comunicación mando-actuador 12 m | Station comm. cable 40ft. | Cavo cablaggio comando-attuatore 12m | Câble de communication commande-actionneur 12 m | 1 |

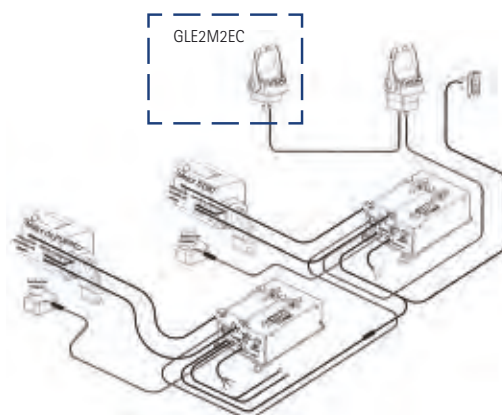

SISTEMA DE GOBIERNO Y ACCESORIOS DE INSTALACIÓN

STEERING SYSTEM & INSTALATION ACCESSORIES

SISTEMA DI GUIDA E ACCESSORI DIREZIONE

SYSTÈME DE DIRECTION ET ACCESSOIRES D'INSTALLATION

MANGUERA DE PROTECCION

Manguera de protección para los cables de dirección, mando, etc. desde la salida del casco hasta el motor, presentando un sólo núcleo limpio y ordenado.
Color gris.

PROTECTIVE CABLE SYSTEM



This system gives a good protection to the service cables of outboard engines against dirt and corrosion. Available in two diameters, complete with fittings in black colour. Hose in grey colour.

TUBO DI PROTEZIONE

Tubo di protezione per cavi di timoneria, comando etc. dall'uscita dello scafo fino al motore, per tenere i cavi ordinati. Colore grigio.

GAINE DE PROTECTION

Gaine de protection pour les câbles de direction, de commande, etc. de la sortie de coque au moteur, présentant un seul fourreau propre et bien rangé. Gris.

| REF | |  | Ø INT (mm) |  |  |
|---------|--------------------------------------|---|------------|---|---|
| GS41164 | Kit | 80 cm | 50 | 1 | |
| GS41165 | | 80 cm | 32 | 1 | |
| GS41160 | Terminal casco Hull end fitting | | 50 | 1 | |
| GS41166 | Terminale scafo Terminal coque | | 32 | 1 | |
| GS41161 | Manguera Hose | 15 m | 50 | | 15 m |
| GS41167 | Tubo Gainé | 15 m | 32 | | 15 m |
| GS41162 | Terminal motor Engine end fitting | | 50 | 1 | |
| GS41168 | Terminale motore Terminal moteur | | 32 | 1 | |

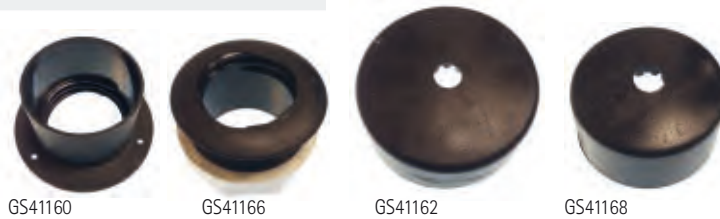

ARO PROTECTOR

Protección de los cables de control y dirección. Vinilo marino resistente a los rayos U.V., gasolina y aceites. Se ajusta alrededor de los cables.

CABLE BOOTS

Finishes and protects pass thru hole for wires and cables. Rugged marine vinyl. Resists UV, gasoline and oil. Cable tie snugs around wires and cables.

CUFFIA PASSACAVO

Protezione di cavi di controllo e di comando. Vinile marino resistente a raggi UV, benzina e oli. Si adatta attorno ai cavi.

ANNEAU DE PROTECTION

Protection des câbles de commande et de direction. Vinyle marin résistant aux rayons UV, à l'essence et aux huiles. Il s'adapte autour des fils.

| REF | PARA AGUJERO FOR HOLE PER FORI POUR TROU |  |
|---------|---|---|
| THCB-2 | 2" | 1 |
| THCB-1 | 3" | 1 |
| THCB-4 | 4 1/2" | 1 |
| THCB-2W | 2" | 1 |
| THCB-1W | 3" | 1 |
| THCB-4W | 4 1/2" | 1 |



Protección de los cables de control y dirección. Fabricado en plástico cromado.

Finishes and protects pass thru hole for wires and cables. Chrome plated plastic.

Protezione cavi di controllo e di comando. Fabbriato in plastica cromata.

Protection des câbles de commande et de direction. Fabbriqué en plastique chromé.

| REF |  |
|----------|---|
| THRF-1CP | 1 |



PROTECTOR ESPEJO

Fabricada en aluminio. Con soporte para terminal del cable de dirección.

PROTECTION PLATE



Aluminum transom plate complete with support and tube for steering cable.

PIASTRA SALVA POPPA

Fabbriata in alluminio. Con supporto per i cavi di timoneria.

PLAQUE DE PROTECTION

Fabbriqué en aluminium Avec support pour de câble de direction.

| REF |  |  |
|---------|---|---|
| GS73132 | 280 x 115 (mm) | 1 |



Fabricada en plástico semirígido. Color blanco.

Made in plastic. White.

In plastica semirigida. Colore bianco.

Fabriqué en plastique Couleur blanche.

| REF | (mm) | |
|---------|-----------|---|
| GS73133 | 430 x 350 | 1 |

GOLDENSHIP



Fabricada en plástico semirígido.

Made in plastic.

In plastica semirigida.

Fabriqué en plastique.

| REF | (mm) | |
|---------|-----------|---|
| GS73130 | 225 x 85 | 1 |
| GS73131 | 270 x 100 | 1 |

GOLDENSHIP



Fabricada en polipropileno resistente a los rayos UV. Color blanco.

Made in solid UV resistant polypropilene. Colour white.

Fabbricata in polipropileno resistente ai raggi UV. Colore bianco

Fabriqué en polypropylène résistant aux UV. Couleur blanche.

| REF | A (mm) | B (mm) | C (mm) | GRUESO THICKNESS SPESSORE EPAISSEUR (mm) | |
|-----------|--------|--------|--------|--|---|
| OCE100133 | 390 | 350 | 330 | 8 | 1 |
| OCE100134 | 390 | 350 | 330 | 15 | 1 |

OCEANSOUTH



CONTRAPLACA TRANSOM

TRANSOM SUPPORT PLATE

CONTROPIASTRA

CONTRE-PLAQUE

Reparte el esfuerzo de los tornillos de sujeción del motor. Fabricado en aluminio de alta calidad, de 10mm de espesor.

Distributes stress of engine bolts. Manufactured in high quality cast aluminum. All plates 3/8".

Contropiastra. Fabbricata in alluminio di alta qualità, di 10mm di spessore.

Répartissez l'effort des boulons de fixation du moteur. Fabriqué en aluminium de haute qualité, épaisseur 10 mm.

| REF | | A | B | C |
|---------|---------------------------|-----|----|-----|
| THTSP-1 | Para tornillos superiores | 15" | 2" | 13" |
| | For top bolts | | | |
| | Per viti superiori | | | |
| THTSP-2 | Para tornillos inferiores | 12" | 2" | 10" |
| | For lower bolts | | | |
| | Per viti inferiori | | | |
| | Pour vis inférieures | | | |

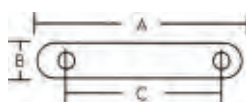

TUERCA DE ENGRASE

STEERING GUARD

DADO LUBRIFICANTE

ÉCROU DE GRAISSAGE

Tuerca engrasadora para todos los cables de dirección. Sella el cable evitando el agua y la corrosión.

Steering guard to be installed in all cable and side mounted hydraulic steering systems to lubricate clean and seal the systems. Made of stainless steel.

Dado lubrificante per tutti i cavi di timoneria. Chiude il cavo evitando l'acqua e la corrosione.

Écrou de graissage pour tous les câbles de direction. Scellez le câble en évitant l'eau et la corrosion.

| REF | | |
|---------|------|---|
| GS41170 | 7/8" | 1 |

GOLDENSHIP



MANDO MECÁNICO

MECHANICAL CONTROL

SCATOLA MECCANICHE

CONTRÔLE MÉCANIQUE

TELEFLEX «XTREME»



new

Cambios mínimos en el esquema de montaje o anidamiento de cables desde Osprey o SL-3.
Impulsiones de popa e interiores. La palanca de doble función controla el acelerador y el cambio de un motor. Enclavamiento neutro y protección de arranque en marcha (estándar) para controles de montaje lateral.
TRIM/TILT opcional en el mango. Función de calentamiento del motor neutro (estándar).
Interruptor de apagado de emergencia del motor para controles de montaje lateral.
Acepta todos los tipos de cable OEM y 3300 / 33C.
Cumple / excede todos los estándares aplicables.

Minimal changes to mounting scheme or cable nesting from Osprey or SL-3.
Dual function lever controls both throttle and shift of one engine. Neutral interlock and start-in-gear protection (standard) for side mount controls.
Optional TRIM / TILT in the handle. Neutral engine warm-up feature (standard).
Standard lanyard-style cut-off switch for emergency engine shut down for side mount controls.
Accepts every type of OEM and 3300/33C type cable.
Meets/exceeds all applicable standards.

Modifiche minime dello schema di assemblaggio o di nidificazione dei cavi da Osprey o SL-3.
Azionamenti di popa e interni. La leva a doppia funzione controlla l'acceleratore e il cambio di un motore.
Interblocco neutro e protezione marcia in marcia (standard) per comandi di montaggio laterali.
TRIM / TILT opzionale sul manico. Funzione di riscaldamento del motore neutro (standard).
Interruttore di arresto di emergenza del motore per comandi di montaggio laterali.
Accetta tutti i tipi di cavi OEM e 3300 / 33C.
Soddisfa / supera tutti gli standard applicabili.

Modifications minimes dans le schéma d'assemblage des câbles d'Osprey ou SL-3.
Commandes latérales ou sur console. Le levier à double fonction contrôle l'accélérateur et l'inversion de marche. Verrouillage neutre et protection de démarrage (standard) pour les commandes à montage latéral.
TRIM / TILT en option sur la poignée. Fonction de chauffage neutre du moteur (standard).
Interrupteur d'arrêt d'urgence du moteur pour commandes à montage latéral.
Accepte tous les types de câbles OEM et 3300 / 33C.
Répond / dépasse toutes les normes applicables.

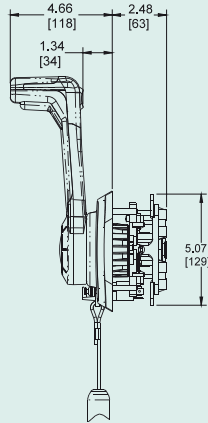

| REF | LATERAL CENTRAL NEGRO | SIDE CENTER BLACK | LATERALE CENTRALE NERO | LATERAL NOIR |
|------------|--|---|---|--|
| TXCHX8850P | Interlock Hombre al agua | Interlock Stoper, hang rope assy | Interlock Stacco aut. d'emergencia | Verrouillage Coupe circuit |
| TXCHX8852P | Interlock Hombre al agua Trim/Tilt | Interlock Stoper, hang rope assy Trim/Tilt switch | Interlock Stacco aut. d'emergencia Trim/Tilt switch | Verrouillage Coupe circuit Trim / Tilt |

| REF | LATERAL NEGRO | SIDE BLACK | LATERALE NERO | LATERAL NOIR |
|------------|--|---|---|--|
| TXCHX8550P | Interlock Hombre al agua | Interlock Stoper, hang rope assy | Interlock Stacco aut. d'emergencia | Verrouillage Coupe circuit |
| TXCHX8552P | Interlock Hombre al agua Trim/Tilt | Interlock Trim/Tilt switch Stoper, hang rope assy | Interlock Trim/Tilt switch Stacco aut. d'emergencia | Verrouillage Coupe circuit Trim/Tilt |
| TXCHX8553P | Interlock | Interlock | Interlock | Verrouillage |
| TXCHX8555P | Interlock Trim/Tilt | Interlock Trim/Tilt switch | Interlock Trim/Tilt switch | Verrouillage Trim/Tilt |

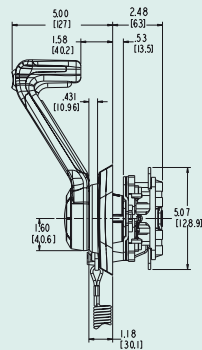
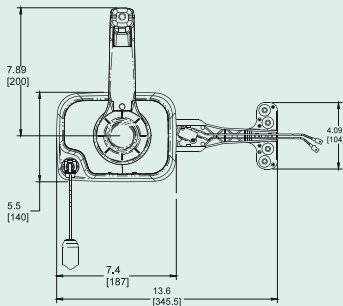

| REF | CONSOLA NEGRO | CONSOLE BLACK | CONSOLLE NERO | CONSOLE NOIR |
|------------|---------------|------------------|------------------|--------------|
| TXCHX8640P | Estándar | Standard | Standard | Standard |
| TXCHX8642P | Trim/Tilt | Trim/Tilt switch | Trim/Tilt switch | Trim/Tilt |

| REF | CONSOLA CROMADO | CONSOLE CHROME | CONSOLLE CROMATO | CONSOLE CHROME |
|------------|---------------------|----------------------------|----------------------------|----------------|
| TXCHX8650P | Interlock | Interlock | Interlock | Verrouillage |
| TXCHX8652P | Interlock Trim/Tilt | Interlock Trim/Tilt switch | Interlock Trim/Tilt switch | Trim/Tilt |

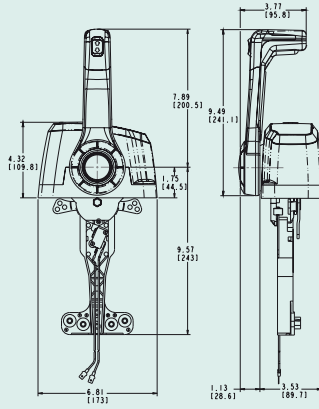

| REF | CONSOLA DOBLE NEGRO | DOUBLE CONSOLE BLACK | CONSOLLE DOPPIO NERO | DOUBLE CONSOLE NOIR |
|------------|---------------------|----------------------|----------------------|---------------------|
| TXCHX8740P | Estándar | Standard | Standard | Standard |
| TXCHX8742P | Trim/Tilt | Trim/Tilt switch | Trim/Tilt switch | Trim/Tilt |

| REF | CONSOLA DOBLE CROMADO | DOUBLE CONSOLE CHROME | CONSOLLE DOPPIO CROMATO | DOUBLE CONSOLE CHROME |
|------------|-----------------------|-----------------------|-------------------------|-----------------------|
| TXCHX8240P | Estándar | Standard | Standard | Standard |
| TXCHX8242P | Trim/Tilt | Trim/Tilt switch | Trim/Tilt switch | Trim/Tilt |

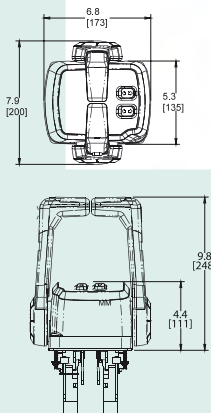
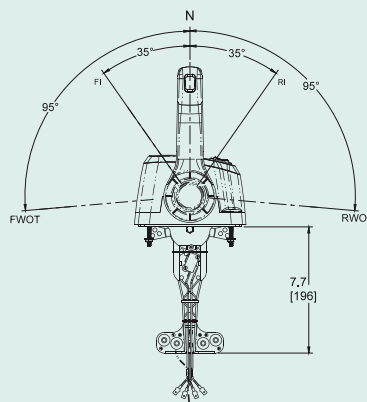

3300C

Recorrido trabajo: 76 mm.
Rosca 10-32"

Travel 3"
Threaded 10-32"

Estensione: 76 mm
Filetto 10-32"

Course: 76 mm.
Fil 10-32"

| REF | RO |  |
|------------|-----------------|---|
| PRE3300C05 | YMM-21005-C8-00 | 5' / 1,50 m |
| PRE3300C06 | YMM-21006-C8-00 | 6' / 1,80 m |
| PRE3300C07 | YMM-21007-C8-00 | 7' / 2,10 m |
| PRE3300C08 | YMM-21008-C8-00 | 8' / 2,45 m |
| PRE3300C09 | YMM-21009-C8-00 | 9' / 2,75 m |
| PRE3300C10 | YMM-21010-C8-00 | 10' / 3,05 m |
| PRE3300C11 | YMM-21011-C8-00 | 11' / 3,35 m |
| PRE3300C12 | YMM-21012-C8-00 | 12' / 3,65 m |
| PRE3300C13 | YMM-21013-C8-00 | 13' / 3,95 m |
| PRE3300C14 | YMM-21014-C8-00 | 14' / 4,25 m |
| PRE3300C15 | YMM-21015-C8-00 | 15' / 4,60 m |
| PRE3300C16 | YMM-21016-C8-00 | 16' / 4,90 m |
| PRE3300C17 | YMM-21017-C8-00 | 17' / 5,20 m |
| PRE3300C18 | YMM-21018-C8-00 | 18' / 5,50 m |
| PRE3300C19 | YMM-21019-C8-00 | 19' / 5,80 m |
| PRE3300C20 | YMM-21020-C8-00 | 20' / 6,10 m |
| PRE3300C21 | YMM-21021-C8-00 | 21' / 6,40 m |
| PRE3300C22 | YMM-21022-C8-00 | 22' / 6,70 m |
| PRE3300C23 | YMM-21023-C8-00 | 23' / 7,00 m |
| PRE3300C24 | YMM-21024-C8-00 | 24' / 7,30 m |

| REF | RO |  |
|------------|-----------------|--|
| PRE3300C25 | YMM-21025-C8-00 | 25' / 7,60 m |
| PRE3300C26 | YMM-21026-C8-00 | 26' / 7,90 m |
| PRE3300C27 | YMM-21027-C8-00 | 27' / 8,25 m |
| PRE3300C28 | YMM-21028-C8-00 | 28' / 8,55 m |
| PRE3300C29 | YMM-21029-C8-00 | 29' / 8,85 m |
| PRE3300C30 | YMM-21030-C8-00 | 30' / 9,15 m |
| PRE3300C31 | | 31' / 9,50 m |
| PRE3300C32 | | 32' / 9,75 m |
| PRE3300C33 | | 33' / 10,00 m |
| PRE3300C34 | | 34' / 10,35 m |
| PRE3300C35 | | 35' / 10,65 m |
| PRE3300C36 | | 36' / 11,00 m |
| PRE3300C38 | | 38' / 11,50 m |
| PRE3300C40 | | 40' / 12,10 m |
| PRE3300C42 | | 42' / 12,70 m |
| PRE3300C44 | | 44' / 13,30 m |
| PRE3300C46 | | 46' / 14,00 m |
| PRE3300C48 | | 48' / 14,50 m |
| PRE3300C50 | | 50' / 15,00 m |

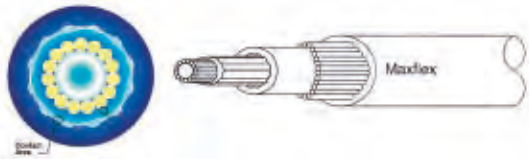

maxflex



4300C

Para trabajos pesados.
Recorrido trabajo: 76 mm.
Rosca 1/4-28"

Heavy Duty.
Travel 3"
Threaded 1/4-28"

Per lavori pesanti
Estensione 7,6cm
Filetto 1/4-28"

Pour les travaux lourds.
Course: 76 mm.
Filetage 1/4-28"

| REF |  |
|------------|---|
| PRE6500C05 | 5' / 1,50 m |
| PRE6500C06 | 6' / 1,80 m |
| PRE6500C07 | 7' / 2,10 m |
| PRE6500C08 | 8' / 2,45 m |
| PRE6500C09 | 9' / 2,75 m |
| PRE6500C10 | 10' / 3,05 m |
| PRE6500C12 | 12' / 3,65 m |
| PRE6500C14 | 14' / 4,25 m |
| PRE6500C16 | 16' / 4,90 m |
| PRE6500C18 | 18' / 5,50 m |
| PRE6500C19 | 19' / 5,80 m |
| PRE6500C21 | 21' / 6,40 m |
| PRE6500C23 | 23' / 7,00 m |

| REF |  |
|------------|---|
| PRE6500C25 | 25' / 7,60 m |
| PRE6500C27 | 27' / 8,25 m |
| PRE6500C29 | 29' / 8,85 m |
| PRE6500C31 | 31' / 9,50 m |
| PRE6500C33 | 33' / 10,00 m |
| PRE6500C35 | 35' / 10,65 m |
| PRE6500C37 | 37' / 11,28 m |
| PRE6500C39 | 39' / 11,89 m |
| PRE6500C41 | 41' / 12,56 m |
| PRE6500C43 | 43' / 13,11 m |
| PRE6500C45 | 45' / 13,71 m |
| PRE6500C47 | 47' / 14,33 m |



maxflex

PINNACLE

CABLES DE STOP

UTILITY CABLE

CAVO DI STOP

TIRETTES D'ARRÊT

| REF |  |
|----------|---|
| PRE31507 | 7' / 2,10 m |
| PRE31508 | 8' / 2,45 m |
| PRE31509 | 9' / 2,75 m |
| PRE31510 | 10' / 3,05 m |
| PRE31511 | 11' / 3,35 m |

| REF |  |
|----------|---|
| PRE31512 | 12' / 3,65 m |
| PRE31513 | 13' / 3,95 m |
| PRE31514 | 14' / 4,25 m |
| PRE31515 | 15' / 4,60 m |
| PRE31516 | 16' / 4,90 m |



maxflex



ACCESORIOS PARA CABLES DE MANDO

ACCESSORIES FOR CONTROL CABLES

ACCESSORI CAVI COMANDI

ACCESSOIRES POUR CÂBLES DE COMMANDE

| REF | | | | | |
|-----------|--|--|-------------------------|--|---|
| PRE331125 | Horquilla | Fork | Forcella | Chappe | 1 |
| PRE31799 | Rótula | Ball joint | Snodo | Rotule | 1 |
| PRE308650 | Pivote | Pivot | Perno | Pivot | 1 |
| PRE332010 | Abrazadera | Clamp | Ferma cavo | Collier | 1 |
| PRE331538 | Platina | Shim | Piastrina | Platine | 1 |
| PRE331980 | Terminal ojo | Terminale eye | Terminale cavo | Terminal | 1 |
| PRE336174 | Fijador 1 cable | Stop collar 1 | Fissatore 1 cavo | Fixateur de câble | 1 |
| PRE215154 | Fijador 2 cable | Stop collar 2 | Fissatore 2 cavi | Fixateur 2 câbles | 1 |
| PRE31916 | Tirador SD para cable de paro y otros usos | SD control. Handle for throttle, choke, stop, etc. | Tirante SD | Poignée SD pour câble d'arrêt et autres utilisations | 1 |
| PRE31917 | Soporte angular para tirador SD | Mounting bracket for SD control | Supporto per tirante SD | Support angulaire pour SD shooter | 1 |



SISTEMA DE COMBUSTIBLE

FUEL SYSTEM

SISTEMA DI COMBUSTIBILE

SYSTÈME DE CARBURANT

CONECTOR TANQUE DE COMBUSTIBLE

TANK CONNECTOR

ATTACCO PER SERBATOIO

CONNECTEUR POUR RÉSERVOIR DE CARBURANT

| REF | R.O. OEM | | |
|---------|-------------------------|----------|---|
| GS31025 | MERCURY/MARINER | 1/4" NPT | 1 |
| GS31073 | YAMAHA | | 1 |
| GS31083 | 772681 JOHNSON/EVINRUDE | | 1 |
| GS31081 | MERCURY/MARINER | | 1 |

| REF | R.O. OEM | | |
|---------|-------------------------|----------|---|
| GS31022 | MERCURY/MARINER STANDAR | | 1 |
| GS31023 | MERCURY/MARINER NEW | | 1 |
| GS31020 | YAMAHA | 1/4" NPT | 1 |
| GS31021 | JOHNSON/EVINRUDE | 1/4" NPT | 1 |



CONECTOR DOBLE

DOUBLE CONNECTOR

CONNETTORE DOPPIO

DOUBLE CONNECTEUR

| REF | | | |
|---------|-----------------|------|---|
| GS31091 | OMC | 8 mm | 1 |
| GS31092 | YAMAHA | 8 mm | 1 |
| GS31093 | MERCURY/MARINER | 8 mm | 1 |



SOLUCIONES DE INSTALACIÓN • INTALATION SOLUTIONS • SOLUZIONI INSTALLAZIONE • SOLUTIONS D'INSTALLATIONS



CODO DEPÓSITO DE LATÓN

TANK ELBOW IN BRASS

GOMITO SERBATOIO

COUDE EN LAITON

| | | |
|---------|---|---|
| REF |  |  |
| GS31068 | 1/4" NPT | 1 |



CONECTOR T

T CONNECTOR

CONNETTORE "T"

CONNECTEUR T

Para conectar dos motores a un sólo depósito, o viceversa.

Fabricado en latón. Made in machined brass.

Per collegare due motori a un singolo serbatoio o viceversa.

Pour connecter deux moteurs à un seul réservoir, ou vice versa.

| | | |
|---------|---|---|
| REF |  |  |
| GS31069 | 1/4" NPT | 1 |



PASAMAMPAROS

THRU HULL

PASSA SCAFO



PASSE CLOISONS

Para atravesar mamparos de hasta 12 mm. Fabricado en latón.

For bulkhead up to 12 mm. Made in machined brass.

Per attraversare paratie fino a 12 mm. Fabricato in ottone.

Pour traverser des cloisons jusqu'à 12 mm. En laiton.

| | | |
|---------|---|---|
| REF |  |  |
| GS31064 | 3/8" | 1 |



VÁLVULA ANTIRETORNO

NON-RETURN VALVE

VALVOLA ANTI-RITORNO



CLAPET ANTI-RETOUR

Válvula antiretorno para líneas de combustible y ventilación.

In-Line non-return valve for fuel pipes.

Valvola anti-ritorno per linee di combustibile e ventilazione.

Clapet anti-retour pour les conduites de carburant et de ventilation.

| | | |
|---------|---|---|
| REF |  |  |
| GS31003 | 8 mm | 1 |
| GS31004 | 10 mm | 1 |
| GS31005 | 12 mm | 1 |



VÁLVULA DE COMBUSTIBLE

FUEL VALVE

VALVOLA CARBURANTE



VANNE POUR CARBURANT

Válvula manual a 3 vías, para combustible. Fabricada en latón pulido. Montaje mediante soporte con 2 agujeros. Para conectar 2 depósitos a un solo motor.



Three ways fuel valve. Made in brass, with 2 holes flange. To connect 2 tanks to one single feeding pipe.

Valvola manuale a 3 uscite, per carburante. Fabricata in ottone. Fissare mediante supporto con 2 fori. Per collegare 2 serbatoi a un solo motore.

Vanne manuelle 3 voies, pour carburant. Fabriqué en laiton poli. Montage par support à 2 trous pour connecter 2 réservoirs à un seul moteur.

| | | | |
|---------|---|---|---|
| REF |  |  |  |
| GS31010 | 1/4" | 10 mm | 1 |
| GS31011 | 3/8" | 10-13 mm | 1 |



| | | | |
|---------|---|---|---|
| REF |  |  |  |
| GS30111 | 1/4" | 10 mm | 1 |
| GS30112 | 3/8" | 12 mm | 1 |



Válvula manual a 2 vías, para combustible. Fabricada en latón pulido.

Two ways fuel valve. Made in brass.

Valvola manuale a 2 uscite, per carburante. Fabricata in ottone.

Vanne manuelle 2 voies, pour carburant. Fabriqué en laiton poli.

| | | | |
|---------|---|---|---|
| REF |  |  |  |
| GS31006 | 1/4" NPT | 1/4" NPT | 1 |





Válvula manual para combustible. Fabricada en latón cromado con racors. Puede montarse en línea o desmontando el soporte, incorporarla directamente al depósito.

Manual and remote fuel valve. Made in chrome plated brass. Can be mounted in line with hose or directly on gasoline tanks.

Valvola manuale per carburante. Fabricata in ottone cromato con raccordo. Si può montare in linea o smontando il supporto, incorporarla direttamente al serbatoio.

Vanne manuelle pour le carburant. Fabriqué en laiton chromé avec raccords. Elle peut être montée en ligne ou en l'intégrant directement dans le réservoir sans son support.

| REF |  |  |  |
|---------|---|---|---|
| GS31012 | 1/4" | 10 mm | 1 |

GOLDENSHIP



ELECTROVÁVULA DE COMBUSTIBLE

FUEL ELECTRO-VALVE

ELETTROVALVOLA CARBURANTE





ÉLECTROVANNE POUR CARBURANT

Incluye conexiones para mangueras flexibles y para tubo de cobre. Accionamiento a 12V y manual. CE 94/25 (EN28846) y R.I.Na.DIP 61697

Fuel cut off electrovalve 12V with manual cock. Includes racors for flexible hose and cooper tube. CE 94/25 (EN28846) et R.I.Na.DIP 61697

Incluye raccordi per tubo flessibile e per tubi di rame. Avviamento a 12V e manuale. CE 94/25 (EN28846) e R.I.Na.DIP 61697

Comprend des connexions pour tuyaux flexibles et tube en cuivre. Entraînement 12V et manuel. CE 94/25 (EN28846) et R.I.Na.DIP 61697

| REF |  |  |  |  |  |
|---------|---|---|---|---|---|
| GS31013 | 12V | 100l/h | 1/4" | 8-10 mm | 1 |

GOLDENSHIP



FILTROS DE COMBUSTIBLE

FUEL FILTERS

FILTRO BENZINA

FILTRES À CARBURANT

FILTRO PARA MONTAJE EN LINEA

IN-LINE FILTER

FILTRO PER MONTARE IN LINEA



FILTRE POUR MONTAGE EN LIGNE

| REF |  |  | GOLDENSHIP |
|---------|---|---|---|
| GS31185 | 6-8 mm | 1 | Cubeta extraíble Removable bowl Vasca estraibile Seau amovible |
| GS31186 | 6-8 mm | 1 | |







| REF |  | RECmar |
|--------------|---|---|
| REC35-80365M | 6 mm | 2-8 HP (2 T/ Strokes) 8-15 HP (4 T/ Strokes) |

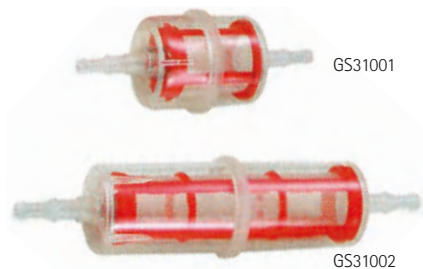

| REF |  |  |  |
|---------|--|---|---|
| GS31001 | 50 l/h | 6-8 mm | 1 |
| GS31002 | 150 l/h | 8-10 mm | 1 |



| REF | R.O. OEM |  | RECmar |
|---------------|----------|---|---|
| PAF4-05000300 | 35-16248 | 6 mm | 4-9.8 HP (2 T/ Strokes) 4-25 HP (4 T/ Strokes) |



| REF |  |  |  | RECmar |
|----------|---|---|---|---|
| REC40145 | 1/4" | | |  |
| REC40155 | 5/16" | | | |
| REC40165 | 3/8" | | | |
| REC40135 | 5/16" | 3/8" | | |

De metal y cristal. Montaje en línea. Racors para mangueras de 6-8-10 mm.

In-line. Clear body permits visual inspection. Racors 6-8-10 mm.



Di metallo e cristal. Montare in linea. Raccordi per tubi da 6-8-10 mm.

En métal et verre. Montage en ligne. Raccors pour tuyaux 6-8-10 mm.



| REF |  |  | GOLDENSHIP |
|---------|---|---|--|
| GS30435 | 6, 8, 10 mm | 1 |  |



FILTRO COMBUSTIBLE SEPARADOR DE AGUA **WATER SEPARATING FUEL FILTER** **FILTRO SEPARATORE ACQUA-BENZINA** **FILTRE À CARBURANT SEPARATEUR D'EAU**

| REF | MICRAS MICRON |  |  |
|-----------------|---------------|---|--|
| REC24942 | 10 | 4-7/16" |  RACPF5510 |
| REC35-802893Q01 | 10 | 4-7/16" | |
| REC855686 | 28 | 4-7/16" | |
| REC35-802893Q | 25 | 3-3/4" | |
| RACPF5510 | 10 | 4-7/16" | |



| REF | MICRAS MICRON |  | Filtro original. | OEM filter. | Filtro benzina originale. | Filtre d'origine |
|--------------|---------------|---|------------------|-------------|---------------------------|---|
| RM35-802893Q | 10 | 3-3/4" | | | |  |

FILTRO CON BRACKET
Bracket de Aluminio.
Con 2 tapones de bronce y 1 tubo de extensión.

OEM FILTER WITH BRACKET
Cast Aluminium Bracket.
With 2 brass plugs & 1 extension tube.

FILTRO BENZINA CON SUPPORTO
Supporto in alluminio.
Con 2 tappi di bronzo e 1 tubo di estensione.

FILTRE AVEC SUPPORT
Support en aluminium
Avec 2 bouchons en bronze et 1 tube d'extension.

| REF | MICRAS MICRON |  |  |
|----------|---------------|---|---|
| REC24950 | 25 | 1/4" | 50 GPH |
| REC24952 | 10 | 1/4" | 50 GPH |



FILTRO DECANTADOR GASOLINA

Filtro de combustible con braket.

COMPLETE FUEL FILTER



Complete fuel filter with braket.

FILTRO DECANTATORE BENZINA

Filtro combustibile con supporto.

FILTRE DÉCANTEUR POUR ESSENCE

Filtre à carburant avec support.

| REF |  |  |
|-------------|---|---|
| RAC23299-10 | RAC23289-10 | 130 HP (4 T/ Strokes) |

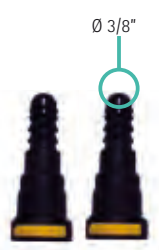

| REF | OEM |  | MICRAS MICRON |  |  |
|----------------|--------------|---|---------------|---|---|
| REC90794-46866 | 907-94469-05 | REC90794-46868 | 10 | 117 l/h | 175 hp |

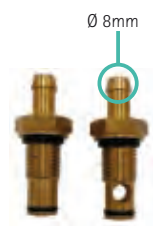

LLAVE PARA FILTRO
FILTER KEY
CHIAVE DA FILTRO
CLE A FILTRE

| REF |
|--------------|
| RECYS-225-15 |



Consultar filtros específicos para una marca en su catálogo.
Consult specific filters for a brand in his catalog.
Consulta i filtri specifici per un marchio nel suo catalogo.
Consulter les filtres spécifique à une marque dans votre catalogue.



| | | | |
|-----------------------------------|-----------------------------|-----------------------------------|--------------------------------------|
| FILTRO DECANTADOR GASOLINA | COMPLETE FUEL FILTER | FILTRO DECANTATORE BENZINA | FILTRE DÉCANTEUR POUR ESSENCE |
|-----------------------------------|-----------------------------|-----------------------------------|--------------------------------------|

RACOR.



| | RAC120R-RAC-01 | RAC320R-RAC-01 | RAC320R-INOX-01 | RAC320R-RAC-02 |
|---|----------------------|----------------------|----------------------|----------------------|
| FLUJO MÁXIMO MAX. FLOW FLUSSO MASSIMO FLUX MASSIMALE | 114 l/h 30 gph | 340 l/h 60 gph | 340 l/h 60 gph | 340 l/h 60 gph |
| ELEMENTO ELEMENT ELEMENTO ELEMENT | RACS3240 | RACS3213 | RACS3213 | RACS3220UL |
| CAZOLETA TRANSPARENTE (sólo se recomienda para fueraborda.) CLEAR BOWL (Just for outboards) VASCHETTA TRASPARENTE (Solo nei fuoribordo.) CAZOLETA TRANSPARENTE (Uniquement recommandé pour le hors-bord.) | ✓ | ✓ | ✓ | ✗ |
| ROSCAS CENTRALES CENTRAL THREADS FILETTO CENTRALE FILS CENTRAUX | M18 x 1.5 | 1 1/4" | 1 1/4" | 1 1/4" |
| TAMAÑO ROSCA CABEZA HEAD PORT SIZE DIMENSIONE VITE TESTA TAILLE DU FIL DE TÊTE | 1/4-18 NPTF | 1/4-18 NPTF | 1/4-18 NPTF | 1/4-18 NPTF |
| ALTURA X Ø HEIGHT X Ø ALTEZZA X Ø HAUTEUR X Ø | 166 x 81 x 81 mm | 238 x 102 x 102 mm | 238 x 102 x 102 mm | 238 x 102 x 102 mm |
| PESO WEIGHT PESO POIDS | 0,5 kg | 0,9 kg | 0,9 kg | 0,9 kg |
| CAIDA DE PRESIÓN PRESSURE DROP CADUTA DI PRESSIONE CHUTE DE PRESSION | 0.15 PSI 0.01 bar | 0.61 PSI 0.04 bar | 0.61 PSI 0.04 bar | 0.61 PSI 0.04 bar |
| PRESIÓN MÁXIMA MAX. PRESSURE PRESSIONE MASSIMA PRESSION MAXIMALE | 7 PSI 0.05 bar | 7 PSI 0.05 bar | 7 PSI 0.05 bar | 7 PSI 0.05 bar |
| DESMONTAJE CARTUCHO-CAZOLETA ELEMENT REMOVAL UNDERBOWL RIMOZIONE DELLA CARTUCCIA DEMONTAGE DE LA CARTOUCHE | 25,4 mm 1" | 25,4 mm 1" | 25,4 mm 1" | 25,4 mm 1" |
| TEMPERATURA DE TRABAJO OPERATING TEMPERATURE TEMPERATURA DI LAVORO TEMPERATURE DE TRAVAIL | -40°C +124°C | | | |

| ELEMENTOS DE RECAMBIO | | ELEMENT | ELEMENTI DI RICAMBIO | CARTOUCHE DE RECHANGE |
|-----------------------|--------------|---|--|---|
| REF | R.OM. OEM | FILTRO FILTER FILTRO | | |
| RACS3240 | | RAC120R-RAC-01 |  | |
| LENS3240 | | | | |
| RACS3227 | YMM-2E227-00 | Yamaha-Suzuki |  | |
| LENS3227 | | | | |
| RACS3213 | | RAC320R-RAC-01 | | |
| LENS3213 | | RAC320R-RAC-01 INOX | | |
| | | RAC320R-RAC-03 | | |
| RACS3214 | | Johnson & Evinrude | | |
| RACS3228UL | | RAC320R-RAC-02, con/with/con/avec bracket RACOR | |  |
| | | | LENS3240 LENS3227 LENS3214 | RACS3228UL |
| | | | RACS3240 RACS3227 RACS3214 | |





| RÁCORES | | RACORS | RACCORDI | RACCORDS |
|---|---|--------|----------|---|
| Para for per pour: RAC120R-RAC-01, RAC320R-RAC-01, RAC320R-RAC-02 | | | | |
| REF |  | 90° | 0° |  |
| GS31065 | 1/4" NPT | 3/8" | | 1 |
| GS31066 | 1/4" NPT | | 5/16" | 2 |
| GS31067 | 1/4" NPT | | 3/8" | 2 |











GS31065 GS31066
GS31067

SISTEMA ELÉCTRICO ELECTRIC SYSTEM SISTEMA ELETTRICO SYSTÈME ÉLECTRIQUE

| FUSIBLE ATC | | MARINE FUSES ATC | FUSIBILE ATC | FUSIBLE ATC |
|-------------|---|--|---|---|
| Ref |  |  (mm) |  |  |
| GS11501 | 3 A | 19 x 19 | 5 | BS5291 |
| GS11502 | 4 A | 19 x 19 | 5 | BS5292 |
| GS11503 | 10 A | 19 x 19 | 5 | BS5293 |
| GS11504 | 15 A | 19 x 19 | 5 | BS5294 |
| GS11505 | 20 A | 19 x 19 | 5 | BS5295 |
| GS11506 | 30 A | 19 x 19 | 5 | BS5296 |

| Ref |  |  (mm) |  |
|--------|---|--|---|
| BS5291 | 3 A | 19 x 19 | 2 |
| BS5292 | 5 A | 19 x 19 | 2 |
| BS5293 | 7,5 A | 19 x 19 | 2 |
| BS5294 | 10 A | 19 x 19 | 2 |
| BS5295 | 15 A | 19 x 19 | 2 |
| BS5296 | 20 A | 19 x 19 | 2 |
| BS5297 | 25 A | 19 x 19 | 2 |
| BS5298 | 30 A | 19 x 19 | 2 |
| BS5299 | 40 A | 19 x 19 | 2 |









Con LED indicador de fundido. With illuminated LED when blown. Con indicatore LED. Avec indicateur LED.



| FUSIBLE ATM | | MARINE FUSES ATM | FUSIBILE ATM | FUSIBLE ATM |
|-------------|---|--|---|-------------|
| Ref |  |  (mm) |  | |
| AM603905 | 5 A | 11 x 16 | 2 | |
| AM603910 | 10 A | 11 x 16 | 2 | |
| AM603915 | 15 A | 11 x 16 | 2 | |
| AM603920 | 20 A | 11 x 16 | 2 | |
| AM603930 | 30 A | 11 x 16 | 2 | |

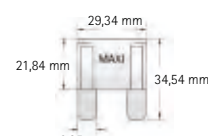

| FUSIBLE MAXI | | FUSES MAXI | FUSIBILE MAXI | FUSIBLE MAXI |
|---|---|---|--|---|
| Contactos estañados para resistir a la corrosión. | | Tin plated connector blades for corrosion resistance. | Connettori stagni per resistere alla corrosione. | Contacts étamés pour résister à la corrosion. |
| Ref |  |  | | |
| BS5138 | 30 A | 1 | | |
| BS5139 | 40 A | 1 | | |
| BS5140 | 50 A | 1 | | |
| BS5141 | 60 A | 1 | | |
| BS5142 | 70 A | 1 | | |
| BS5143 | 80 A | 1 | | |

DESCONECTOR DE SEGURIDAD

Interruptor de encendido para motores. Aísla los circuitos en unidades dobles para prevenir el retorno al alternador.

IGNITION KILL SWITCHES

Emergency and stop switch. Isolates circuits on dual units to prevent feedback.

INTERRUTTORE DI STOP

Interruttore di accensione per motori. Isola i circuiti in doppie unità per prevenire il ritorno all'alternatore.

INTERRUPTEUR DE SECURITE

Contacteur d'allumage pour moteurs. Isolez les circuits en unités doubles pour empêcher le retour à l'alternateur.

| REF | | | | | |
|---------|-----------------|-----------------|-----------------|-------------------|---|
| THKS-1 | Un fueraborda | Single outboard | Un fuoribordo | Un hors-bord | 1 |
| THKS-2 | Un intraborda | Single I/O | Un entrobordeo | Un inboard | 1 |
| THKS-12 | Dos fuerabordas | Dual outboard | Due fuoribordo | Deux hors-bord | 1 |
| THKS-22 | Dos intrabordas | Dual I/O | Due entrobordeo | Deux inboard | 1 |
| THL-4 | Cuerda recambio | Spare lanyard | Corda ricambio | Corde de rechange | 1 |



| REF | RO OEM | | |
|-----------------|--------------------------|-------------------|---|
| REC87-823609A17 | 87-823609A17 | Mercury / Mariner | 1 |
| REC37800-93954 | 37800-9354 37800-9353 | Suzuki | 1 |



REC87-823609A17



REC37800-9354

Interruptor de encendido para todo tipo de motores fueraborda o intraborda.

Emergency and stop switch for inboard or outboards.

Interruttore di accensione per tutti i tipi di motori entrobordeo e fuoribordo.

Contacteur d'allumage pour tous types de moteurs hors-bord ou in-bord.

| REF | | | | | |
|----------|-------------------------|---------------|------------------------|-------------------|---|
| REC40970 | Conjunto completo | Complete kit | Kit completo | Ensemble complet | 1 |
| REC40990 | Cuerda tirador recambio | Spare | Corda tirante ricambio | Corde de rechange | 1 |
| GS11290 | Conjunto completo | Complete kit | Kit completo | Ensemble complet | 1 |
| GS11291 | Cuerda recambio | Spare lanyard | Corda ricambio | Corde de rechange | 1 |
| GS11292 | Kit | Kit | Kit | kit | 1 |



REC40970- REC40990



GS11290



GS11292



GS11291

| REF | RO OEM | | |
|-----------------|--------------|-------------------|---|
| REC37830-89E03 | 37830-84E03 | Suzuki | 1 |
| REC37820-92E03 | 37820-92E00 | Suzuki | 1 |
| REC69W-82575-00 | 69W-82575-0 | Yamaha / Mariner | 1 |
| REC688-82575-01 | 688-82575-01 | Yamaha / Mariner | 1 |
| REC200 | | Mercury / Mariner | 1 |
| REC369-0682-0 | 369-0682-00 | Tohatsu | 1 |



REC69W-82575-00



REC688-82575-01



REC37830-89E03

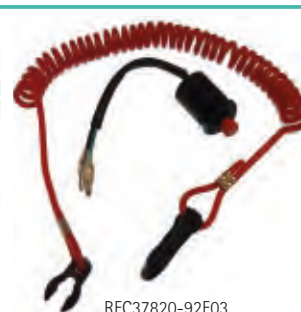

REC37820-92E03



REC369-0682-0



REC200

KITS LLAVES

KILL SWITCHES KEYS

KIT CHIAVI

KITS DE CLÉS

| REF | | |
|---------|--|---|
| GS11294 | Johnson / Evinrude OMC Mercury Yamaha Honda Suzuki Tohatsu | 1 |



LLAVE DE ARRANQUE

IGNITION STARTER SWITCHES

CHIAVE DI AVVIAMENTO

CONTACTEUR À CLÉ

3 posiciones con retroceso, Off-Contacto-Arranque (Choke).
Poliester anticorrosión.

3 positions, Off-Run-Start. Magneto.

3 posizioni con ritorno: Off-Contatto-Avviamento. Poliestere anticorrosione.

3 positions, Off-Contact-Start (Choke). Polyester anti-corrosion.

| REF | PANELES PANELS PANNELLI PANNEAUX | TERMINALES TERMINALS TERMINALI BORNES | POSICIONES POSITIONS POSIZIONE POSITIONS | |
|---------|---|--|---|---|
| MP39200 | 28 mm | 3 | 3 | 1 |



3 posiciones con retroceso, Off-Contacto-Arranque. Poliester anticorrosión.

3 positions, Off-Run-Start. Conventional

3 posizioni con ritorno: Off-Contatto-Avviamento. Poliestere anticorrosione.

3 positions, Off-Contact-Start. Polyester anti-corrosion.

| REF | RO OEM | TERMINALES TERMINALS TERMINALI BORNES | POSICIONES POSITIONS POSIZIONE POSITIONS | |
|---------|------------------|--|---|---|
| MP39760 | 393301 508180 | 5 + 1 | 3 | 1 |



3 posiciones con retroceso, Off-Contacto-Arranque (Choke). Poliester anticorrosión. Para fuerabordas Mercury y Mariner.

3 positions, Off-Run-Start. Magneto

3 posizioni con ritorno: Off-Contatto-Avviamento. Poliestere anticorrosione. Per fuoribordo Mercury e Mariner.

3 positions, Off-Contact-Start (Choke). Polyester anti-corrosion. Pour les moteurs hors-bord Mercury et Mariner.

| REF | RO OEM | TERMINALES TERMINALS TERMINALI BORNES | POSICIONES POSITIONS POSIZIONE POSITIONS | |
|---------|------------------------------|--|---|---|
| MP41070 | MC 87-17009A2, 87-17009A5 | 6 | 3 | 1 |



3 posiciones con retroceso, Off-Contacto-Arranque (Choke). Poliester anticorrosión. Para fuerabordas Mercury y Mariner.

3 positions, Off-Run-Start. Magneto.

3 posizioni con ritorno: Off-Contatto-Avviamento. Poliestere anticorrosione. Per fuoribordo Mercury e Mariner.

3 positions, Off-Contact-Start (Choke). Polyester anti-corrosion. Pour les moteurs hors-bord Mercury et Mariner.

| REF | RO OEM | TERMINALES TERMINALS TERMINALI BORNES | POSICIONES POSITIONS POSIZIONE POSITIONS | |
|---------|-------------|--|---|---|
| MP41000 | MC 87-88107 | 6 | 3 | 1 |



3 posiciones con retroceso, Off-Contacto-Arranque. Poliester anticorrosión. Montadas por Bayliner y SeaRay (1990+).

3 positions, Off-Run-Start. Conventional.

Chiave di avviamento a 3 posizioni con ritorno: Off-Contatto-Avviamento. Poliestere anticorrosione. Montato da Bayliner e SeaRay dall'anno 1990.

3 positions, Off-Contact-Start. Polyester anti-corrosion. Assemblé par Bayliner et SeaRay (1990+).

| REF | PANELES PANELS PANNELLI PANNEAUX | TERMINALES TERMINALS TERMINALI BORNES | POSICIONES POSITIONS POSIZIONE POSITIONS | |
|---------|---|--|---|---|
| MP41030 | 15 mm | 3 | 3 | 1 |



3 posiciones con retroceso, Off-Contacto-Arranque. Fabricada en latón con frontal cromado. Chrome plated brass face nut and brass back-up nut.

3 positions with return, Off-Ignition-Start.

3 posizioni con ritorno: Off-Contatto-Avviamento. In ottone con frontale cromato.

3 positions, Off-Contact-Start. Fabriqué en laiton avec façade chromée. Ecrou frontal en laiton chromé et écrou d'appui en laiton.

| REF | PANELES PANELS PANNELLI PANNEAUX | TERMINALES TERMINALS TERMINALI BORNES | POSICIONES POSITIONS POSIZIONE POSITIONS | |
|---------|---|--|---|---|
| GS11150 | 28 mm | 3, 15A 12V | 3 | 1 |



Fabricada en latón con frontal protector de goma. 3 posiciones con retroceso, Off-Contacto-Arranque.

Made in brass with rubber cap protector. 3 positions with return, Off-Ignition-Start.

Prodotta in ottone con parte frontale in gomma, 3 posizioni con ritorno, Off-Contatto-Avviamiento.

En laiton avec façade de protection en caoutchouc. 3 positions: Off-Contact-Start.

| REF | TERMINALES TERMINALS TERMINALI BORNES | POSICIONES POSITIONS POSIZIONE POSITIONS |  |
|---------|--|---|---|
| GS11151 | 3 | 3 | 1 |
| GS11154 | 4 | 3 | 1 |



Plástico con frontal protector de goma. 3 posiciones con retroceso, Off-Contacto-Arranque.

Made in plastic with rubber cap protector. 3 positions with return, Off-Ignition-Start.

In plastica con parte frontale in gomma 3 posizioni con ritorno, Off-Contatto-Avviamiento.

Plastique avec façade de protection en caoutchouc. 3 positions: Off, contact et démarrage.

| REF | TERMINALES TERMINALS TERMINALI BORNES | POSICIONES POSITIONS POSIZIONE POSITIONS |  |
|---------|--|---|---|
| GS11152 | 3 | 3 | 1 |
| GS11153 | 5 | 3 | 1 |



Plástico. 4 posiciones con retroceso, Accesorios-Off-Contacto-Arranque.

Made in plastic with rubber cap protector. 4 positions with return, Acc-Off-Ignition-Start.

Prodotta in plastica. 4 posizioni con ritorno, Blower-Off-Contatto-Avviamiento.

Plastique 4 positions avec recul, Accessoires-Off-Contact-Start.

| REF | PANELES PANELS PANNELLI PANNEAUX | TERMINALES TERMINALS TERMINALI BORNES | POSICIONES POSITIONS POSIZIONE POSITIONS |  |
|---------|---|--|---|---|
| GS11155 | 15 mm = 5/8" | 7 | 4 | 1 |
| GS11156 | 6 mm = 1/4" | 7 | 4 | 1 |



Fabricada en plástico. 3 posiciones con retroceso, Off-Contacto-Arranque (Starter).

Made in plastic. 3 positions with return, Off-Ignition-Start (Choke).

Prodotta in plastica. 3 posizioni con ritorno, Off-Contatto-Avviamiento (Starter).

En plastique. 3 positions avec recul, démarreur sans contact.

| REF | PANELES PANELS PANNELLI PANNEAUX | TERMINALES TERMINALS TERMINALI BORNES | POSICIONES POSITIONS POSIZIONE POSITIONS |  |
|---------|---|--|---|---|
| GS11158 | 15 mm = 5/8" | 6 | 3 | 1 |
| GS11157 | 6 mm = 1/4" | 6 | 3 | 1 |



Fabricada en plástico. Con cables incluidos. 3 posiciones con retroceso, Off-Contacto-Arranque (Starter).

Made in plastic. 3 positions with return, Off-Ignition-Start (Choke). With wires included.

Prodotta in plastica. Con cavi inclusi. 3 posizioni con ritorno, Off-Contatto-Avviamiento (Starter).

En plastique. Avec câbles inclus. 3 positions avec recul, démarreur sans contact.

| REF | TERMINALES TERMINALS TERMINALI BORNES | POSICIONES POSITIONS POSIZIONE POSITIONS |  |
|---------|--|---|---|
| GS11159 | 6 | 3 | 1 |



LUBRICANTES Y PINTURAS

LUBRICANTS & PAINTS

LUBRIFICANTI E PITTURE

LUBRIFIANTS ET PEINTURES

PINTURA EN SPRAY

SPRAY PAINT

PITTURE SPRAY

PEINTURE EN SPRAY

Sprays de pintura con los colores originales para retoque de los motores fueraborda, interiores, intra-fueraborda y colas fueraborda más usuales. Capacidad: 400ml.

Spray paints with the original colors for maintenance and painting inboards and outboard marine engine as well as stern-drives units. Bottle: 400ml.

Vernice spray con i colori originali per ritocchi dei motori fuoribordo, entro-bordo, entro-fuoribordo e i piedi. Capacità: 400ml.

Peinture en aérosol aux couleurs originales pour la retouche des moteurs hors-bord, in-bord et les embases les plus courantes. Capacité: 400 ml

| REF | COLOR | COLOUR | COLORE | COULEUR |
|----------|------------------------------------|---------------------------|----------------------------|---------------------------|
| GS90019 | Barniz transparente | Clear Varnish | Vernice trasparente | Vernis transparent |
| PS110410 | Evinrude Azul (1989) | Blue (1989) | Blu (1989) | Bleu (1989) |
| GS90037 | Evinrude Azul XP | Blue XP | Blu XP | XP bleu |
| PS111139 | Honda Gris Beige (1991) | Grey (1991) | Grigio-Beige (1991) | Gris Beige (1991) |
| GS90038 | Honda Gris metalizado | Grey Metal | Grigio metallizzato | Gris métallisé |
| GS90023 | Honda Plata met. | Silver Metal | Argento metallizzato | Argent métallisé |
| GS90030 | Johnson Blanco (1972-90) - (1993+) | White (1972-90) - (1993+) | Bianco (1972-90) - (1993+) | Blanc (1972-90) - (1993+) |
| GS90026 | Johnson Blanco (1981-83) | White (1981-83) | Bianco (1981-83) | Blanc (1981-83) |
| GS90039 | Johnson Plata metalizado | Silver Metal | Argento metallizzato | Argent métallisé |
| GS90040 | Mariner Gris | Grey | Grigio | Gris |
| GS90002 | Mercury Negro | Black | Nero | Noir |
| GS90049 | Parsun Negro | Black | Nero | Noir |
| GS90032 | Suzuki Plateado (1983-89) | Silver (1983-89) | Argento (1983-89) | Argent (1983-89) |
| GS90025 | Suzuki Gris metalizado | Grey Metal | Grigio metallizzato | Gris métallisé |
| GS90042 | Suzuki Negro metalizado | Black Metal | Nero Metallizzato | Noir métallisé |
| GS90024 | Tohatsu Gris Metal (1991) | Grey Metal (1991) | Grigio Metallizzato (1991) | Gris métallisé (1991) |
| GS90027 | Tohatsu Azul Cobalto (1988-90) | Blue Cobalt (1988-90) | Blu Cobalto (1988-90) | Bleu cobalt (1988-90) |
| GS90043 | Tohatsu Azul | Blue | Blu | Bleu |
| PS114694 | Yamaha Azul Metal (1974) | Blue Metal (1974) | Blu Metallizzato (1974) | Bleu métal (1974) |
| GS90021 | Yamaha Azul (1984+) | Blue (1984+) | Blu (1984+) | Bleu (1984+) |
| GS90020 | Yamaha Azul Origen | Blue Origin | Blue Origen | Bleu Origine |
| GS90022 | Yamaha Gris Metal (1994) | Grey Metal (1994) | Grigio Metallizzato (1994) | Gris métallisé (1994) |
| PS110485 | Yamaha Gris Capot (1994) | Grey Capot (1994) | Grigio Capot (1994) | Gris capot (1994) |



GOLDENSHIP

PROTECTOR DE MOTOR

ENGINE PROTECTOR

PROTETTORE MOTORE

PROTECTION DU MOTEUR

Producto a base de aceites y grasas que protege del óxido y la corrosión las superficies exteriores y partes eléctricas de los motores durante el invierno. Evita la formación de agarrotamientos debido a la presencia de salitre. Facilita el arranque eliminando los residuos de agua y humedad. Se elimina fácilmente.

Oil Et grease made, protects from rust Et corrosion external engine surface during winter storage. Removes salt deposit and loosens rusted parts. Easy to remove.

Prodotto a base di olio e grasso che protegge dall'ossidazione e dalla corrosione le superfici esterne e parti elettriche dei motori durante l'invernaggio. Evita la formazione dell'ossidazione dovuta alla presenza del salmastro. Facilita l'accensione eliminando i residui di acqua e umidità. Si elimina facilmente.

Produit à base d'huiles et de graisses qui protège les surfaces extérieures et les parties électriques des moteurs de la rouille et de la corrosion pendant l'hivernage. Il empêche la formation de crises dues à la présence de salpêtre. Il facilite le démarrage en éliminant les résidus d'eau et d'humidité. Il s'enlève facilement.



| | |
|---------|---|
| REF |  |
| GS90090 | 500 ml |

GOLDENSHIP

PROTECTOR DIELECTRICO

DIELECTRIC PROTECTOR

PROTETTORE DIELETRICO

PROTECTEUR DIÉLECTRIQUE

Protector dieléctrico antihumedad para uso marino. Protege de la humedad y oxidación todos las partes eléctricas y mecánicas de los motores marinos. Ideal para invernaje de motores y mantenimiento de temporada.

Prevents humidity and corrosion of all electric and mechanical parts in marine engines. Specially indicate for winter storages and maintenance in the season.



Protettore dielettrico anti-umidità per uso marino. Protegge dalla umidità e dall'ossidazione tutte le parti elettriche e meccaniche dei motori marini. Ideale per invernaggio dei motori e manutenzione di lunga durata.



Protecteur diélectrique anti-humidité pour usagé marin. Protège toutes les pièces électriques et mécaniques des moteurs marins contre l'humidité et l'oxydation. Idéal pour l'hivernage des moteurs et l'entretien saisonnier.



| | |
|---------|---|
| REF |  |
| GS90092 | 400 ml |

GOLDENSHIP

| DESCALCIFICADOR DE MOTOR | DESCALING ENGINE FLUSH | DECALCIFICANTE MOTORE | DÉTARTRANT MOTEUR |
|--|---|---|--|
| <p>Limpiador para eliminar las incrustaciones, algas, y suciedad en los motores marinos. No daña las juntas ni impulsores de goma.</p> | <p>Removes scale, zebra mussels, general marine growth and vegetation rom all marine engines.</p> | <p>Pulitore per eliminare le incrostazioni, alghe, e sporcizia nei motori marini. Non danneggia guarnizioni e giranti in gomma.</p> | <p>Nettoyant pour éliminer le tartre, les algues et la saleté dans les moteurs marins. N'endommage pas les joints ou les turbines en caoutchouc.</p> |
| <p>REF STA92600</p> <p>3,8 L</p>  | | |  |

| LIMPIADOR CARBURADOR Y STARTER | CARBURATOR & CHOKE CLEANER | PULITORE CARBURATORE | NETTOYANT CARBURATEUR |
|--|--|---|---|
| <p>Aerosol para motores de 2 y 4 tiempos. Para limpieza del carburador y de los componentes internos del motor. Asegura arranques fáciles y ralenti suave. Despega los aros de los pistones. Restablece la potencia del motor.</p> | <p>Spray for all 2 and 4 cycle engines. Marine motor de-carb. Dissolves gum, varnish dirt and carbon deposits. Restore power & performance. Reduce fuel consumption.</p> | <p>Aerosol per motori di 2 e 4 tempi. Per la pulizia del carburatore e dei componenti interni del motore. Assicura partenze più facili e un minimo stabile. Lubrifica le fasce dei pistoni. Ristabilizza la potenza del motore.</p> | <p>Spray pour moteurs 2 et 4 temps. Pour nettoyer le carburateur et les composants internes du moteur. Assure des démarrages faciles et un ralenti en douceur. Décolle les segments du piston. Restaure la puissance du moteur.</p> |
| <p>REF GEGC15</p> <p>354 g</p>  | | |  |

| ACEITE DE INVERNAJE | FOGGING OIL | OLIO INVERNAGGIO | FOGGING OIL |
|--|---|--|--|
| <p>Para inyectar en los carburadores de motores a 2 y 4 tiempos. Protege las paredes de los cilindros, aros de pistones y otras superficies de la cámara de combustión durante los periodos de invernaje, facilitando el arranque del motor después de éste periodo.</p> | <p>Prevents corrosion when storing inboard or outboard engines for a extended period of time. Special formula makes starting engine after storage quick and easy.</p> | <p>Da inserire nei carburatori dei motori da 2 e 4 tempi. Protegge le pareti dei cilindri, le fasce dei pistoni e altre superfici della camera di combustione durante il periodo di invernaggio, facilitando la partenza del motore dopo questo periodo.</p> | <p>Pour injecter dans les carburateurs des moteurs 2 et 4 temps. Il protège les parois des cylindres, segments et autres surfaces de la chambre de combustion pendant les périodes d'hivernage, facilitant le démarrage du moteur après cette période.</p> |
| <p>REF STA84800 GE22001</p> <p>3,8 L 340 g</p> | | |  <p>RECmar® GE22001</p> <p>STA84800</p> |

| ADITIVO GASOLINA | GASOLINE ADDITIVE | ADDITIVO BENZINA | ADDITIF ESSENCE |
|--|--|--|--|
| <p>Elimina y previene los problemas del ethanol. Reduce todas las emisiones contaminantes. Estabiliza la química del combustible durante 1 año. Reduce el mantenimiento del sistema de combustible. Elimina la producción de carbonilla. Reduce el consumo de combustible.</p> | <p>Eliminates and prevents ethanol fuel problems. Reduces all emissions. Prevents fuel oxidation and stabilizes fuel chemistry for at least 1 year. Lower fuel system maintenance. Eliminates carbon build-up. Increases fuel economy.</p> | <p>Elimina e previene i problemi dell'etanolo. Riduce tutte le emissioni contaminanti. Stabilizza la chimica del combustibile durante 1 anno. Elimina la produzione di residui carboniosi. Riduce il consumo del combustibile.</p> | <p>Élimine et prévient les problèmes d'éthanol. Réduise toutes les émissions polluantes. Stabilise la chimie du carburant pendant 1 an. Réduit l'entretien du système de carburant. Élimine la production de charbon. Réduis la consommation de carburant.</p> |
| <p>REF STA93008 STA93016</p> <p>237 ml 473 ml</p> <p>PARA TRATAR HASTA TREAT UP TRATTARE FINO A POUR TRAITER JUSQU'À 475 L 950 L</p>  | | |  |

ESTABILIZADOR DE GASOLINA

FUEL STABILIZER

STABILIZZATORE BENZINA

STABILISATEUR D'ESSENCE

Elimina el agua, limpia los carburadores e inyectores. Contiene antioxidantes para prevenir el óxido y la corrosión. No requiere vaciar el depósito para el invierno y mantiene el combustible fresco para un rápido y fácil arranque.

Keeps fuel fresh and allows for easier starts after periods of storage. Removes water, cleans carburetors and fuel injectors. Contains antioxidant to prevent rust and corrosion.

Elimina l'acqua, pulisce i carburatori e i iniettori. Contiene antiossidanti per prevenire l'ossidazione e la corrosione. Non è necessario svuotare il serbatoio per l'invernaggio e mantiene il carburante fresco per una rapida e facile partenza.

Élimine l'eau, nettoie les carburateurs et les injecteurs. Contient des antioxydants pour empêcher la rouille et la corrosion. Il ne nécessite pas de vider le réservoir pour l'hivernage et maintient le carburant frais pour un démarrage rapide et facile.



GE22207

GE22254

| REF | PARA TRATAR HASTA TREAT UP TRATTARE FINO A POUR TRAITER JUSQU'À | | |
|---------|--|---------|--|
| GE22207 | 475 ml | 150 L | Gasolina Gasoline Benzina Gasoline |
| GE22254 | 946 ml | 1.200 L | Diesel |



LIMPIADOR DEPOSITOS

FUEL TANK CLEANER

PULITORE SERBATOIO

NETTOYANT RÉSERVOIR

Excepcionalmente efectivo en la limpieza de lodos y algas en depósitos de gasolina o diesel. Retrasa la formación de nuevas algas que puedan contaminar el combustible. Nuevo y revolucionario aditivo que reemplaza los costosos sistemas de limpieza de los depósitos de combustible.

Exceptionally effective at cleaning sludge and algae from gasoline and diesel tanks. Slows the recurrence of new algae that can contaminate fuel. A revolutionary new additive that replaces expensive fuel polishing and tank cleaning.

Eccezionale efficacia nella pulizia dal fango e alghe nel serbatoio benzina o diesel. Ritarda la formazione di nuove alghe che possono contaminare il combustibile. Nuovo e rivoluzionario additivo che rimpiazza i costosi sistemi di pulizia dei serbatoi del combustibile.

Exceptionnellement efficace pour nettoyer les boues et les algues dans les réservoirs d'essence ou de diesel. Il retarde la formation de nouvelles algues qui peuvent contaminer le carburant. Nouvel additif révolutionnaire qui remplace les systèmes coûteux de nettoyage des réservoirs de carburant.



STA93116

STA93664

| REF | PARA TRATAR HASTA TREAT UP TRATTARE FINO A POUR TRAITER JUSQU'À | | |
|----------|--|---------|--|
| STA93664 | 1,9 L | 950 L | |
| STA93116 | 473 ml | 1.900 L | |



LUBRICANTE PARA 2 TIEMPOS

2 STROKE LUBRICANT

LUBRIFICANTE PER 2 TEMPI HUILE 2 TEMPS TC-W3

2 STROKES TC-W3

Especialmente formulado para motores marinos de 2 tiempos. Inhibidor de corrosión y herrumbre. Gran capacidad de limpieza de las partes internas del motor (pistón, bujías...), evita el pegado de segmentos y la formación de depósitos. Alta fluidez a bajas temperaturas.

Specially formulated for 2-stroke marine engines. Excellent anti-wear protection for the internal parts of the engine. When the engine is not in use, it effectively protects from corrosion and rust. Very effective in maintaining the internal parts of the engine (pistons, spark plugs, etc.) clean, avoiding piston rings from sticking and sediments accumulating.

Formulazione specificamente studiata per motori marino a 2 tempi. Eccellente protezione contro l'usura dei componenti interni del motore. Garantisce un'alta protezione contro la corrosione e la ruggine. Contribuisce a mantenere pulite le parti interne del motore (pistone, candela, ecc.), evita l'aderenza delle fasce del pistone e la formazione di depositi. Alta fluidità a basse temperature.

Spécialement conçu pour des moteurs 2 temps, Elle vous offre une excellente protection face à l'usure des éléments internes du moteur et une haute protection contre la corrosion et la rouille. Elle a une haute fluidité à basses températures. Notamment applicable dans des conditions climatiques très froides.

new

QUALITY LEVELS
NMMA TC-W3
(NMMA, National Marine Manufacturers Association)

| REF | | |
|---------|-----|---|
| REC2TU6 | 1 L | 6 |
| REC2TU3 | 5 L | 3 |





ACEITE MEZCLA 2 TIEMPOS

2 CYCLE OIL S

OLIO MISCELA 2 TEMPI

HUILE 2 TEMPS

| REF | R.O. OEM |  |  | |
|------------------|--------------|---|---|--------------|
| RM92-858026QB1U6 | 92-858026QB1 | 1 L | 6 | PREMIUM PLUS |
| RM92-858027QB1U3 | 92-858027QB1 | 3,8 L | 3 | PREMIUM PLUS |
| RM92-858037QB1U3 | 92-858037QB1 | 3,8 L | 3 | OPTIMAX /DFI |



RM92-858026QB1U6



RM92-858027QB1U3



RM92-858037QB1U3

ACEITE MINERAL FUERABORDAS TC-W3

Utilize el TC-W3 para obtener mayor potencia en su motor. Provee de una mayor protección contra la carbonilla en los pistones, el resacamiento de los aros, el fallo de las bujías en el arranque y del óxido. Recomendado para los sistemas de inyección de aceite.

2-CYCLE OIL TC-W3



Formulated from ultra-clean base stock oil to provide superior protection against piston scuffing, bearing wear, spark plug fouling, pre-ignition and rust. This formulation has outstanding lubricity and miscibility for better mixing of fuel and oil, resulting in a cleaner running engine. Contains no phosphorus. Recommended for oil injection systems. Outboard motor Oil.

OLIO MINERALE PER FUORIBORDO TC-W3

Utilizzare il TC-W3 per ottenere maggior potenza nel motore. Fornisce una maggiore protezione contro i residui di combustione nei pistoni, l'essiccazione delle fasce, il non funzionamento delle candele nell'accensione. Raccomandato per i sistemi di iniezione ad olio.

HUILE MINÉRALE 2 TEMPS TC-W3

Utilisez la TC-W3 pour augmenter la puissance de votre moteur. Elle offre une meilleure protection contre le carbone dans les pistons, le séchage des segments, la défaillance des bougies d'allumage au démarrage et la rouille. Recommandé pour les systèmes d'injection d'huile.

| REF | R.O. OEM |  |  | |
|------------------|--------------|---|---|--|
| LUB11591U12 | | 1 L | 12 | |
| RM92-858021QB1U6 | 92-858021QB1 | 1 L | 6 | |
| RM92-858022QB1U3 | 92-858022QB1 | 3,8 L | 3 | |
| RM92-858023QB1U2 | 92-858023QB1 | 9,5 L | 2 | |

LUB11591U12



RM92-858021QB1U6



RM92-858022QB1U3



RM92-858023QB1U2

SAE 5W40

ACEITE 100% SINTÉTICO

Lubricante marino 100% sintético. Excelente fluidez en frío, facilita el arranque y reduce los desgastes de motor. Evita el pegado de segmentos al dispersar lodos, barnices y otros productos de oxidación a altas temperaturas. Contiene inhibidores antiherrumbre y anticorrosión.

100% SYNTHETIC OIL

100% synthetic lubricant designed for all types of 4T petrol engines. Good fluidity in cold temperatures facilitates performance and reduces engine wear. It avoids piston rings from sticking by clearing dirt, varnish and other oil oxidation deposits when subject to high temperatures. Contains effective anti-rust and anti-corrosion inhibitors that protect the engine in the marine environment.

OLIO 100% SINTETICO

Lubrificante 100% sintetico pensato per motori a benzina 4T di ogni tipo. Buona fluidità a freddo, facilita la messa in moto e riduce l'usura del motore. Evita l'aderenza delle fasce del pistone, disperdendo fanghi, lacche e altri prodotti derivanti dall'ossidazione dell'olio ad alte temperature. Contiene efficaci inibitori antiruggine e anticorrosione, per proteggere il motore in ambiente marino.

HUILE 100% SYNTHÉTIQUE

Lubrifiant 100% synthétique adapté à tout type de moteurs à essence 4T. Bonne fluidité à froid qui aide au démarrage et réduit la détérioration du moteur. Évite le collage des segments lors de la dispersion de boue dans le moteur, vernis et autres produits oxydant l'huile à haute température. Contient des inhibiteurs de corrosion et antirouille.

new

QUALITY LEVELS
API SN/CF
ACEA A3/B3/B4
MB 229.3
VW 502.00/505.00
RN 710
OPEL A&B
JASO MA2



| REF |  |  |
|-----------|---|---|
| REC5W40U6 | 1 L | 6 |
| REC5W40U3 | 5 L | 3 |



Especialmente desarrollado para motores de alto rendimiento. Las propiedades especiales de este aceite le permiten lubricar el motor incluso durante el arranque a baja temperatura. El aceite combate la acumulación de lodo y brinda una excelente protección contra el desgaste. Especialmente adecuado para motores que están sujetos a arranques y paradas frecuentes.

Specially developed for high performance engines. The special properties of this oil allow it to lubricate the engine even during low temperature starting. The oil combats sludge build-up and gives excellent protection against wear. Particularly suitable for engines that are subject to frequent starting and stopping.

Sviluppato appositamente per motori ad alte prestazioni. Le proprietà speciali di questo olio consentono di lubrificare il motore anche durante l'avviamento a bassa temperatura. L'olio combatte il fango accumulato e offre un'eccellente protezione contro l'usura. Particolarmente adatto per motori soggetti a frequenti avviamenti e arresti.

Spécialement développé pour les moteurs hautes performances. Les propriétés particulières de cette huile vous permettent de lubrifier le moteur même lors d'un démarrage à basse température. L'huile combat l'accumulation de boue et offre une excellente protection contre l'usure. Particulièrement adapté aux moteurs soumis à des démarrages et arrêts fréquents.



| REF | R.O. OEM |  | |
|-------------|----------|---|--------|
| REC21363429 | 21363429 | 1 L | API SM |
| REC21363430 | 21363430 | 5 L | |



REC21363429

REC21363430

**SAE 10W30
SAE 10W40**

| REF | R.O. OEM |  |  |
|------------------|--------------|---|---|
| RM92-8M0086220U6 | 92-8M0086220 | 1 L | 6 |
| RM92-8M0086221U3 | 92-8M0086221 | 4 L | 3 |



RM92-8M0086220U6

RM92-8M0086221U3

ACEITE SINTÉTICO PREMIUM

Lubricante marino reforzado con bases sintéticas, para motores gasolina 4T fueraborda e intraborda. Especificaciones NMMA FC-W. HTHS elevado, asegura viscosidad a elevadas temperaturas. Anticorrosivo con antioxidantes incorporados, elevadas propiedades antiespumantes.

SYNTHETIC PREMIUM OIL

Marine lubricant strengthened with a synthetic base, especially formulated for outboard and inboard 4T petrol engines, with NMMA FC-W specifications. With a high HTHS, it ensures great viscosity at high temperatures. Better anti-oxidant resistance. Improved anti-foaming properties.



OLIO SINTETICO PREMIUM

Lubrificante marino potenziato con basi sintetiche, specificamente formulato per motori a benzina 4T fuoribordo ed entro bordo, a norma specifiche NMMA FC-W. Con indice HTHS più elevato, garantisce un'alta viscosità a temperatura elevata. Aumenta la protezione anticorrosione. Maggiore resistenza all'ossidazione. Proprietà antischiuma migliorate.



HUILE SYNTHÉTIQUE PREMIUM

Lubrifiant marin renforcée avec des bases synthétiques, pour les moteurs à essence 4T hors-bord et inboard avec des spécifications NMMA FC-W. Avec des HTHS supérieures, qui vous assure une haute viscosité à des températures élevées. Résistance antioxydante majeure. Propriétés anti-mousse améliorées.

QUALITY LEVELS:
NMMA FC-31015T
(NMMA, National Marine
Manufacturers Association)
API SJ/SG

| REF |  |  |
|------------|---|---|
| REC10W30U6 | 1 L | 6 |
| REC10W30U3 | 5 L | 3 |

QUALITY LEVELS
NMMA FC-11815R
(NMMA, National Marine
Manufacturers Association)
API SJ/SG

| REF |  |  |
|------------|---|---|
| REC10W40U6 | 1 L | 6 |
| REC10W40U3 | 5 L | 3 |



new

SAE 15W40

MULTIGRADE HIGH PERFORMANCE

Lubricante multigrado marino, superior al nivel SHPD, especialmente formulado para motores marinos turboalimentados. Contiene inhibidores de corrosión, oxidación, herrumbre y antiespumantes. Capacidad detergente, reduce los depósitos en válvulas y pistones. Excelentes cualidades dispersantes antilodos.

Marine multigrade oil, exceeds the SHPD performance level, especially formulated to meet the demanding requirements of 4-stroke diesel turbocharged engine manufacturers in the marine environment. Contains effective corrosion, oxidation, rust and foam inhibitors. Excellent detergent effect that reduces sediments in valves and pistons. Very good dispersion qualities that prevent sludge in cold temperatures.



Olio marino multigrado, con prestazioni oltre il livello SHPD, specificamente formulato per soddisfare le particolari esigenze dei motori diesel a 4 tempi turboalimentati in ambiente marino. Contiene efficaci inibitori contro corrosione, ossidazione, ruggini e formazione di schiuma. Eccellente capacità detergente, riduce i depositi in valvole e pistoni. Ottime qualità disperdenti che impediscono la formazione di fanghi a freddo.

Huile multigrade marine, dépasse les niveaux de performances SHPD, spécialement conçu pour les moteurs diesel 4T avec turbo. Contient des inhibiteurs contre la corrosion, l'oxydation, anti-rouille et anti-mousse. Evite les dommages dans les chemises, habituel sur les moteurs suralimentés de haute puissance. Haute qualité dispersante pour empêcher l'apparition de boue dans le moteur.

new

QUALITY LEVELS

API CI-4/SL
ACEA E7
Caterpillar ECF-1^a
Cummins CES 20071/72/76/77/78
MACK EO-M+
MAN M3275
MB 228.3
MTU Level 2
Renault RLD/RLD-2
Volvo VDS-2 VDS-3

| REF |  |  |
|------------|---|---|
| REC15W40U3 | 5 L | 3 |



ACEITE MINERALES VDS-3

VDS-3 cubre los requisitos más estrictos sobre la limpieza del pistón en comparación con VDS-2, lo que garantiza la durabilidad y fiabilidad de los motores. La alta calidad del aceite VDS-3 permite un aumento en los intervalos de drenaje. Para motores diesel y de gasolina (ver manuales de los operadores).

VDS-3 MINERAL GEAR OILS

VDS-3 covers even more stringent requirements on piston cleanliness and bore polish compared to VDS-2, ensuring the durability and reliability of the engines. The high quality of VDS-3 oil allows in certain cases an increase in drain intervals. Fits both diesel and gas engines (check operators manuals).

OLIO MINERALE VDS-3

VDS-3 copre requisiti ancora più stringenti sulla pulizia del pistone e sulla lucidatura del foro rispetto a VDS-2, garantendo la durata e l'affidabilità dei motori. L'alta qualità dell'olio VDS-3 consente un aumento degli intervalli di scarico. Adatto sia ai motori diesel che a quelli a gas (consultare i manuali degli operatori).

HUILE MINÉRALE VDS-3

Le VDS-3 couvre les exigences les plus strictes en matière de nettoyage des pistons par rapport au VDS-2, ce qui garantit la durabilité et la fiabilité des moteurs. La haute qualité de l'huile VDS-3 permet une augmentation des intervalles de vidange. Pour les moteurs diesel et essence (voir les manuels d'utilisation).

| REF | R.O. OEM |  | |
|-------------|----------|---|----------|
| REC22479638 | 22479638 | 1 L | API CI-4 |
| REC22479642 | 22479642 | 5 L | ACEA E5 |



REC22479638



REC22479642

ACEITE MOTORES DIESEL

DIESEL ENGINES OIL

OLIO MOTORE DIESEL

HUILE MOTEUR DIESEL

| REF | R.O. OEM |  |  |
|------------------|--------------|---|---|
| RM92-8M0096794U3 | 92-8M0096794 | 3,8 L | 3 |



SAE 25W40

ACEITE SEMISINTÉTICO 4T

Lubricante semisintético para motores con cargas y RPM elevadas. Excelentes inhibidores de corrosión, oxidación y desgaste. Buenas propiedades de arranque en frío, antiespumantes incorporados.



4 STROKES SEMI-SYNTHETIC OIL

Semi-synthetic oil for 4-stroke engines suitable for engines with high RPM and heavy loads. Lubrication of all engine components, great anti-corrosion, anti-oxidation and anti-wear properties. Good performance in cold conditions. Keeps the engine clean and increases protection against corrosion in saline water environments.

QUALITY LEVELS
NMMA FC13101T
(NMMA, National Marine
Manufacturers Association)
API SJ/SG

| REF |  |  |
|------------|---|---|
| REC25W40U3 | 5 L | 3 |

OLIO SEMISINTETICO 4 TEMPI

Olio semisintetico per motori a 4 tempi, adatto a motori con elevati RPM e carichi pesanti. Lubrificazione di tutti i componenti del motore, elevate proprietà anticorrosione, antiossidazione e antiusura. Buone proprietà di avvio a freddo.



HUILE SEMI-SYNTHÉTIQUE 4T

Huile semi-synthétique pour des moteurs 4T adapté aux moteurs avec des hauts RPM. Grande capacité anti-corrosion, anti-oxydation et contre l'usure. Propriétés adéquates pour un démarrage à froid. Elle maintient la propreté du moteur et augmente la protection face à la corrosion dû à l'environnement salin.

new



ACEITE SINTÉTICO PARA MOTORES VERADO

| REF | R.O. OEM |  |  |
|------------------|--------------|---|---|
| RM92-8M0086227U3 | 92-8M0086227 | 4 L | 3 |

SYNTHETIC OIL FOR VERADO ENGINES

OLIO SINTETICO PER MOTORI VERADO

HUILE SYNTHÉTIQUE POUR VERADO



ACEITE MOTORES GASOLINA

| REF | R.O. OEM |  |  |
|------------------|--------------|---|---|
| RM92-8M0086224U3 | 92-8M0086224 | 3,8 L | 3 |

GASOLINE ENGINES OIL



OLIO MOTORE BENZINA

HUILE MOTEUR ESSENCE



ACEITE SINTÉTICO TRASMISSIONES

Aceite sintético de altas prestaciones. Para colas de transmisión mecánica.

| REF | R.O. OEM |  |  |
|------------------|--------------|---|---|
| RM92-858064QB1U6 | 92-858064QB1 | 1 L | 6 |
| RM92-858065QB1U2 | 92-858065QB1 | 9,5 L | 2 |

SYNTHETIC DRIVES OIL

High performance synthetic Lower Unit Gear Lube for mechanical drives.

OLIO SINTETICO PER TRASMISSIONE

Olio sintetico di alte prestazioni. Per piedi poppieri a trasmissione meccanica.

HUILE SYNTHÉTIQUE POUR EMBASES

Huile synthétique haute performance. Pour les embases mécanique.



RM92-858064QB1U6



RM92-858065QB1U2

Lubricante marino para transmisiones de motores intraborda y fueraborda de los principales fabricantes, que requieren aceites con una calidad API GL 5. Consulte el manual de usuario antes de elegir el lubricante.

GL-5 synthetic oil of the highest quality for marine drives and IPS Oil recommended for the transmission of inboard and outboard engines of the main manufacturers that require API GL 5 quality oils. Read the user manual before choosing a lubricant.

Olio sintetico GL-5 di altissima qualità per s-drive, trasmissioni IPS e riduttori. Olio consigliato per trasmissioni entro bordo e fuoribordo dai principali produttori che richiedono oli di qualità API GL 5. Consultare il manuale d'uso prima di scegliere il lubrificante.

Huile Synthétique recommandé par les principaux fabricants conçu pour des transmissions de moteur inboard et hors-bord qui précisent d'une qualité API GL 5. N'hésitez pas à consulter le manuel d'utilisation avant de choisir votre lubrifiant

new



QUALITY LEVELS
API GL-5

| REF |  |  |
|------------|---|---|
| REC80W90U6 | 1 L | 6 |
| REC80W90U3 | 5 L | 3 |



ACEITES SINTÉTICOS

SYNTHETIC OILS

OLIO SINTETICO



HUILES SYNTHÉTIQUES

Aceite sintético de alta calidad. Para colas de transmisión mecánica. Especialmente indicados para los motores de gran cilindrada o de uso frecuente. Reduce el grado de fricción y calentamiento. No se mezcla con el agua. No anula las garantías de los fabricantes.

Lower Unit Gear Lube for mechanical drives. A synthetic gear lube that protects high-performance lower units in extreme operating conditions. Highly recommended for all engines over 100 hp. Will not avoid manufacturers' warranties.

Olio sintetico di alta qualità. Per trasmissione meccanica. Indicato specialmente per motori di grande cilindrata o di uso frequente. Riduce il grado di attrito e riscaldamento. Non si mescola con l'acqua. Non annulla la garanzia del produttore.

Huile synthétique de haute qualité. Pour les embases mécanique. Particulièrement adapté pour les moteurs de grande cylindrée ou à usage fréquent. Réduit le degré de friction et d'échauffement. Elle ne se mélange pas à l'eau. N'annule pas les garanties du fabricant.

| REF |  |  |
|-------------|---|---|
| LUB11564U12 | 1 L | 12 |
| LUB11565 | 19 L | 1 |



LUB11564U12

LUB11565

ACEITE MINERALES

MINERAL GEAR OILS

OLIO MINERALE



HUILE MINÉRALE

Para colas de transmisión mecánica. Especialmente indicados para los motores de gran cilindrada o de uso frecuente. Fabricado con aditivos especiales para proveer una máxima durabilidad e inhibidores de la corrosión para una mayor protección contra el óxido y la corrosión.

Lower Unit Gear Lube for mechanical drives. Lower Unit Gear Lube. Ideal for modern outboard and stern drive lower units. Will not avoid manufacturers' warranties.

Per piedi poppieri a trasmissione meccanica. Indicato specialmente per motori di grande cilindrata o di uso frequente. Fabricato con additivi speciali per fornire una massima durata e impedire la corrosione per una maggiore protezione contro l'ossidazione e la corrosione.

Pour les embases mécanique. Particulièrement adapté pour les moteurs de grande cylindrée ou à usage fréquent. Fabriqué avec des additifs spéciaux pour offrir une durabilité maximale et des inhibiteurs de corrosion pour une meilleure protection contre la rouille et la corrosion.

| REF |  |  |  |
|-------------|---|---|---|
| LUB11540U12 | 280 g | 12 | |
| LUB11552U12 | 1 L | 12 | |
| LUB11546 | 19 L | 1 | |



LUB11540U12

LUB11552U12

LUB11546

KIT ACEITE COLAS

Kit para cambiar el aceite mineral de las colas OMC, Volvo, Mercruiser, Mercury y Mariner.

| | |
|----------|---|
| REF |  |
| LUB11101 | 385 g |



LOWER UNIT LUBE KIT

Includes 2 tubes of high-viscosity lower unit gear lube. For OMC, Volvo, Mercruiser, Mercury & Mariner drives.

KIT OLIO PIEDI

Kit per cambiare l'olio minerale dei piedi poppieri OMC, Volvo, Mercruiser, Mercury e Mariner.



KIT D'HUILE D'EMBASE

Kit pour changer l'huile minérale des embases OMC, Volvo, Mercruiser, Mercury et Mariner etc...



GRASA MARINA. INSOLUBLE AL AGUA

Grasa marina semisintética con base de litio-calcio, de cuerpo espeso y color azul. 100% insoluble al agua, especialmente formulada para todo tipo de aplicaciones náuticas incluso prensaestopas y hélices plegables, gracias a la buena adhesión al metal.

| | | |
|----------|---|---|
| REF |  |  |
| REGREU1 | 5 kg | 1 |
| REGREU12 | 400 g | 12 |



MARINE GREASE. NON-WATER-SOLUBLE

Semi-synthetic marine grease with a lithium and calcium base, thick and blue. 100% non-water-soluble, especially formulated for all nautical uses, including cable glands and foldable propellers, thanks to good adherence to metal.

GRASSO MARINO. INSOLUBILE IN ACQUA

Grasso marino semisintetico a base di litio-calcio, di aspetto denso e di colore azzurro. 100% insolubile in acqua, specificamente formulato per applicazioni nautiche di tutti i tipi, compresi premistoppa ed eliche pieghevoli, grazie all'alta aderenza ai metalli.

GRAISSE MARINE INSOLUBLE A L'EAU

Graisse marine semi-synthétique à base de lithium-calcium, épais et bleu. 100% insoluble avec l'eau, spécialement conçu pour tout type d'application nautiques, même pour des presse-étoupes et les hélices pliables grâce à sa propriété d'adhésion au métal.





Lubricante insoluble al agua, ideal para aplicaciones marinas. Excelente protección contra fricciones, óxido y corrosión.

Special calcium sulfonate complex, water insoluble formula ideal for marine applications. Provides excellent corrosion protection under severe conditions caused by salt water and air.

Lubrificante insolubile all'acqua, ideale per applicazioni marine. Eccellente protezione contro l'attrito, l'ossido e la corrosione.

Lubrifiant insoluble dans l'eau, idéal pour les applications marines. Excellente protection contre le frottement, la rouille et la corrosion.

| | | | |
|----------|---|---|---|
| REF |  | PISTOLA GUN PISTOLA PISTOLET |  |
| LUB11400 | 85g | RECT30190 | 4 |
| LUB11402 | 400g | RECT30201 | 1 |
| LUB11406 | 280g | LUB30197 | 1 |
| LUB11407 | 13,5 kg | | 1 |
| LUB11404 | 450g | | 1 |



LUB11400



LUB11402



LUB11406



LUB11407

LUB11404

| GRASA DE LITIO | LITHIUM GREASE | GRASSO AL LITIO | GRAISSE AU LITHIUM |
|----------------|----------------|-----------------|--------------------|
|----------------|----------------|-----------------|--------------------|

Grasa de litio con Teflón. Color blanco.

Heavy duty white lithium grease with Teflon.

Grasso al litio con Teflón. Colore bianco.

Graisse au lithium avec téflon. Couleur blanche.

REF
LUB11363 350 ml



| ACEITE TRIM / TILT | POWER TRIM & TILT FLUID | OLIO TRIM / TILT | HUILE DE TRIM/TILT |
|--------------------|-------------------------|------------------|--------------------|
|--------------------|-------------------------|------------------|--------------------|

Proporciona la viscosidad y lubricación necesaria para asegurar el perfecto funcionamiento de la bomba alargando la vida de los retenes y juntas.

Formulated to provide viscosity and lubricity necessary to ensure proper pump performance and seal life.

Fornisce la viscosità e la lubrificazione necessaria per assicurare il perfetto funzionamento della pompa allungando la vita delle guarnizioni.

Elle fournit la viscosité et la lubrification nécessaires pour assurer le fonctionnement parfait de la pompe, prolonge la durée de vie des joints, joints.

REF
LUB11578U12 280 g 12



| ACCESORIOS Y HERRAMIENTAS DE INSTALACIÓN | ACCESSORIES AND INSTALATION TOOLS | ACCESSORI E ATTREZZI ISTALAZIONE | ACCESSOIRES ET OUTILS D'INSTALLATION |
|--|-----------------------------------|----------------------------------|--------------------------------------|
|--|-----------------------------------|----------------------------------|--------------------------------------|

KIT PISTOLA + GRASA

MIDGET GREASE GUN KIT

KIT PISTOLA + GRASSO

KIT PISTOLET + GRAISSE

Kit compuesto de una pistola pequeña y muy versátil que permite la salida del tubo conector frontal o superior. Presión máxima 300 k/cm². Incluye un bloqueador para mantener el cartucho en posición y tubo de salida de 14 cm. Admite cartuchos de 3 onzas (85 g) o grasa a granel.

Marine corrosion control lubrication kit. Small, versatile gun allows for front or top pipe placement. Barrel takes 3 oz grease cartridge or can be bulk loaded. Develops up to 4,500 psi.

Kit composto da una pistola piccola e molto versatile che permette l'uscita del grasso dal tubo frontale o superiore. Pressione massima 300 k/cm². Include un blocco per tenere la cartuccia in posizione, il tubo è da 14 cm. Utilizza cartuccia da 85 gr o grasso sfuso.

Kit composé d'un petit pistolet très polyvalent qui permet la sortie du tube de connexion avant ou supérieur. Pression maximale 300 k / cm². Il comprend un bloqueur pour maintenir la cartouche en position et un tube de sortie de 14 cm. Prend en charge des cartouches de 3 oz (85 g) ou de la graisse en vrac.

REF
RECT30190



BOMBA DEPÓSITO

Para llenado de colas. Con válvula de ventilación para evitar derrames.

GREASECASE FILLER

With check valve venting system to avoid overflow

POMPA OLIO

Per mettere l'olio nei piedi poppier. Con valvola di sfianto per evitare fuoriuscite.

POMPE DE REMPLISSAGE

Pour le remplissage des embases. Avec valve de ventilation pour éviter les déversements.

| REF | | | | |
|------------|------------------------------------|-------------------------------|-------------------------------------|-----------------------------------|
| REC55133GF | Bomba depósito | Greasecase filler | Pompa olio | Pompe de remplissage |
| REC55133M | Adaptador métrico (excepto Suzuki) | Metric adaptor (excl. Suzuki) | Adattatore metrico (eccetto Suzuki) | Adaptateur métrique (sauf Suzuki) |
| REC55133S | Adaptador para Suzuki | Adaptor for Suzuki | Adattatore per Suzuki | Adaptateur Suzuki |



PISTOLA DE GRASA

Incluye manguera curvada y conector standard. Ideal para engrasar crucetas, cables de dirección, cañas de motor fuerborda, piñones y cualquier otra parte del motor que precise engrase. Con visor para reserva. Se recarga sin necesidad de tubo.

LEVER GREASE GUN

Standard Lever grease gun. Includes curved pipe and std coupler. Ideal for greasing spreaders, steering wires, rods outboard engine, gear bearing and other parts of the engine that needs greasing. With Viewer for reservation. Will reload without tube.

PISTOLE GRASSO

Incluye tubo flessibile curvo e conettore standard. Ideale per ingrassare cavi dello sterzo, barre del motore fuorbordo, ingranaggi e qualsiasi altra parte del motore che abbia bisogno di lubrificazione. Con visora per la prenotazione. Si ricarica senza tubo.

POMPE A GRAISSE

Comprend un tuyau incurvé et un connecteur standard. Idéal pour graisser les traverses, les câbles de direction, les tiges de moteur entraîné, les pignons et toute autre partie du moteur qui a besoin d'être graissée. Avec viseur pour reservation. Il se recharge sans tube.

| REF | | |
|-----------|---|-----------|
| RECT30201 | 600 cc | 16000 psi |
| LUB10212 | Manguera 30 cm Hose 30 cm Tubo 30 cm Tuyau 30 cm | |



LUB10212



RECT30201

Pistola para tubos de grasa. Incluye manguera flexible de 14 cm y adaptador standard.

All purpose gun operates handy, squeeze tubes. Includes 2-11/16" pipe and plastic push-type coupler.

Pistola per tubi di grasso. Include tubo flessibile da 14 cm e adattatore standard.

Pistolet pour tubes de graisse. Comprend un tuyau flexible de 14 cm et un adaptateur standard.

| REF |
|----------|
| LUB30197 |



PISTOLA DE ACEITE

Pistola para acoplar en los envases de botella de 1 litro de LUB11552 y LUB11564. Se suministra con kit de adaptación con válvula anti-retorno.

BOTTLE GREASE PUMP

Lower unit quart pump. Complete with metal threaded filler fitting.

PISTOLA OLIO

Pistola da accoppiare a bottiglie da 1 L LUB11552 e LUB11564. Si vende con kit di accoppiamento con valvola anti-ritorno.

POMPE POUR HUILE

Pompe pour les bidons de 1 litre de LUB11552 et LUB11564. Livré avec kit d'adaptation avec clapet anti-retour.

| REF |
|----------|
| REC55005 |



KI ENGRASADORES METRICOS

METRIC GREASE FITTINGS

KIT LUBRIFICATORI METRICI

KIT GRAISSEURS METRIQUES

| REF | 0° | 45° | 90° | |
|----------|----|-----|-----|------|
| LUB11957 | 4 | 2 | 2 | M6x1 |



| REF | 90° |
|-----------|--------|
| RECT11958 | 4 M6x1 |



OREJERAS REDONDAS

MOTOR FLUSHER ROUND

CUFFIE LAVAGGIO ROTONDE

OREILLES RONDES

Tomas de agua para refrigeración de motores fueraborda y colas intra-fueraborda.

For use on most outboards and inboard/outboards engines with side water inlets.

Cuffie lavaggio per motori entro-fuoribordo e fuoribordo.

Sorties d'eau pour le refroidissement du moteur hors-bord et in-bord.



| REF | |
|---------|---|
| GS30350 | 1 |



USO PROFESIONAL
PROFESSIONAL
USO PROFESSIONALE
USAGE PROFESSIONNEL

| REF | |
|---------|---|
| GS30351 | 1 |



OREJERAS CUADRADAS

MOTOR FLUSHER SQUARE

CUFFIE LAVAGGIO QUADRATE

OREILLES CARRÉES

Tomas de agua para refrigeración de motores fueraborda y colas intra-fueraborda.

For use on most outboards and inboard/outboards engines with side water inlets.

Cuffie lavaggio per motori entro-fuoribordo e fuoribordo.

Sorties d'eau pour le refroidissement du moteur hors-bord et in-bord.



| REF | |
|---------|---|
| GS30352 | 1 |



USO PROFESIONAL
PROFESSIONAL
USO PROFESSIONALE
USAGE PROFESSIONNEL

| REF | |
|---------|---|
| GS30353 | 1 |



EXTRACTOR IMPULSORES

IMPELLER REMOVAL

ESTRATTORE GIRANTE

EXTRACTEUR DE TURBINE

Extractor para impulsores flexibles de bombas, motores fueraborda e interiores.

Flexible impeller removal tool, suitable for all marine flexible impellers of water pumps, outboard and inboard engines.

Estrattore per giranti di pompe di motori fuoribordo e entrobordo.

Extracteur pour turbines flexibles, moteurs hors-bord et in-bord.

| REF | |
|---------|----------------------------|
| GS20198 | ∅ 65 mm 2-1/2" |
| GS20199 | ∅ 77 - 127 mm ∅ 3" - 5" |



EXTRACTOR COJINETES Y HÉLICES

Extractor de cojinetes y hélices, con patas. Para todos los cojinetes Mercruiser y la mayoría de las hélices.

REF
REC90095
RECMAR®

PROP AND BEARING PULLER

Prop and bearing carrier puller. Capacity: 5 Tons (Min). For Mercruiser All Style Bearing Carrier and Most Props.

ESTRATTORE CUSCINETTI E ELICHE

Estrattore cuscinetti e eliche. Per tutti i cuscinetti Mercruiser e la maggior parte delle eliche.

EXTRACTEUR DE ROULEMENT ET D'HELICE

Extracteur de roulements et hélices. Pour tous les roulements Mercruiser et la plupart des hélices.



Para hélices y cojinetes antiguos For prop and old style bearing carrier. Per eliche e cuscinetti vecchi. Pour hélices et roulements anciens

Para cojinetes modernos For new style bearing carrier. Per cuscinetti moderni. Pour roulements modernes

FONENDOSCOPIO

Instrumento de precisión, resistente a golpes, detecta fácilmente ruidos en motores, cojinetes y otras partes móviles. Incluye varilla de test, trompeta y auriculares.

REF
REC91-00003
RECMAR®

SPARK GAP TESTER

Sensitive, shockproof instrument, easily locates noises in engines bearings and other moving parts. Includes aluminium alloy probe / needle, surgical PVC, rubber trumpet and plastic earphones.

FONENDOSCOPIO

Strumento di precisione, resistente a colpi, rileva facilmente rumori nel motore, nei cuscinetti e altre parti mobili. Include la tromba e gli auricolari.

PHONENDOSCOPE

Instrument de précision, résistant aux chocs, détecte facilement le bruit dans les moteurs, roulements et autres pièces mobiles. Comprend une tige d'essai, une trompette et des écouteurs.



EXTRACTOR PIÑONES Y COJINETES

| REF | PIÑONES BEARINGS PIGNONE PIGNON |
|-------------|--|
| REC91-00001 | 30-50 mm / 1 1/4" ~ 2 1/4" |
| REC91-00002 | 50-75 mm / 2 1/4" ~ 3 1/2" |
| REC91-37241 | 75-105 mm / 3" ~ 4 1/2" |

RECMAR®

UNIVERSAL PULLER PLATE

ESTRATTORE PIGNONE E CUSCINETTI

EXTRACTEUR DE PIGNON ET PALIER



LLAVE DINAMOMÉTRICA

Con escala en: 20-150 pie/lb y 33.9 - 210 N.m Incrementos cada 1 pie/lb y 1,4 N.m Dado de conexión: 1/2"

REF
CRA944595 518 x 35 x 40 mm

TORQUE WRENCH

Scale in: 20-150 ft.-lbs. 33.9 - 210 N.m Increases each 1 ft.-lbs. & 1,4 N.m 1/2" drive.

CHIAVE DINAMOMETRICA

Con scala da: 20-150 piedi/lb e 33.9 - 210 N.m Incremento di 1 pie/lb e 1,4 N.m Dado attacco: 1/2"

CLÉ DYNAMOMÉTRIQUE

Avec échelle à: 20-150 pieds/livres et 33.9 - 210 N.m Incréments tous les 1 pied/livre et 1,4 N.m Embout de connexion: 1/2"



LLAVE FRENO VOLANTE PARA FUERABORDAS

REF
REC5515100
RECMAR®

FLYWHEEL HOLDER PER OUTBOARDS

CHIAVE FRENO VOLANTE PER FUORIBORDO

CLÉ FREIN DE VOLANT POUR HORS-BORD



| CHISPÓMETRO | SPARK GAP TESTER | SCINTILLOMETRO | CONTRÔLEUR D'ALLUMAGE | | | | | | |
|--|--|--|--|---|--------|---|---|--|--|
| Se puede comprobar la chispa con el motor en funcionamiento. | Good for checking spark on running engine. | Si può provare la scintilla con il motore in funzione. | L'étincelle peut être vérifiée avec le moteur en marche. | | | | | | |
| <table border="1"> <thead> <tr> <th>REF</th> <th>CYL</th> </tr> </thead> <tbody> <tr> <td>REC5119766</td> <td>8</td> </tr> <tr> <td>REC004</td> <td>1</td> </tr> </tbody> </table>  | REF | CYL | REC5119766 | 8 | REC004 | 1 |  <p>REC5119766</p> |  <p>REC004</p> | |
| REF | CYL | | | | | | | | |
| REC5119766 | 8 | | | | | | | | |
| REC004 | 1 | | | | | | | | |

| KIT EXTRACTOR DE POLEAS | PULLER TOOL KIT | KIT ESTRATTORE PULEGGE | KIT EXTRACTEUR DE POULIE | | |
|---|---|---|--|---|--|
| Extractor de polea contrapesos. Contiene 5 juegos de tornillos de diferentes medidas. | Harmonic ballancer puller. 5 sets of screws are provided. | Estrattore di pulegge. Contiene 5 kit di viti di differenti misure. | Extracteur de poulie. Il contient 5 jeux de vis de différentes tailles. | | |
| <table border="1"> <thead> <tr> <th>REF</th> </tr> </thead> <tbody> <tr> <td>SSP4600</td> </tr> </tbody> </table>  | REF | SSP4600 |  |  | |
| REF | | | | | |
| SSP4600 | | | | | |

| Kit para extraer e instalar poleas. Para uso en todos los motores Ford, GM y Chrysler. También puede utilizarse para volantes de dirección y poleas en general. Esfuerzo máximo recomendado: 20 kg. | Harmonic ballancer puller and installation tool kit. Use on all Ford, GM & Chrysler engines. Heavy duty tool. Can also be used for steering wheels and pulleys | Kit per estrarre e installare pulegge in tutti i motori Ford, GM e Chrysler. Si può utilizzare per volani di direzione e pulegge in generale. Carico massimo: 20 kg. | Kit pour extraire et installer les poulies. A utiliser sur tous les moteurs Ford, GM et Chrysler. Il peut également être utilisé pour les volants et les poulies en général. Effort maximal recommandé: 20 kg. | | |
|--|--|--|--|--|--|
| <table border="1"> <thead> <tr> <th>REF</th> </tr> </thead> <tbody> <tr> <td>SSPHBP100K</td> </tr> </tbody> </table>  | REF | SSPHBP100K |  |  | |
| REF | | | | | |
| SSPHBP100K | | | | | |

| EXTRACTOR FILTROS | OIL FILTER WRENCH | ESTRATTORE FILTRI | CLÉ À FILTRE | | | | |
|---|---|---|--------------|-------------|--|--|--|
| <table border="1"> <thead> <tr> <th>REF</th> <th>PARA FILTROS FILTERS PER FILTRI POUR FILTRES</th> </tr> </thead> <tbody> <tr> <td>REC70720</td> <td>65 - 110 mm</td> </tr> </tbody> </table>  | REF | PARA FILTROS FILTERS PER FILTRI POUR FILTRES | REC70720 | 65 - 110 mm | | |  |
| REF | PARA FILTROS FILTERS PER FILTRI POUR FILTRES | | | | | | |
| REC70720 | 65 - 110 mm | | | | | | |

| KIT LLAVE HÉLICE | PROP WRENCH KIT | KIT CHIAVE ELICHA | KIT CLÉ À HÉLICE | | | | | | |
|---|--|---|---|----------------|--|---|--|--|--|
| <table border="1"> <thead> <tr> <th>REF</th> <th>R.O. OEM</th> <th></th> </tr> </thead> <tbody> <tr> <td>REC91-859046Q4</td> <td>MC 91-859046Q4 HONDA 89-89206-ZW7-000AH</td> <td>Mercury Mariner Force V4 & V6 Mercruiser Honda BF75-BF130</td> </tr> </tbody> </table>  | REF | R.O. OEM |  | REC91-859046Q4 | MC 91-859046Q4 HONDA 89-89206-ZW7-000AH | Mercury Mariner Force V4 & V6 Mercruiser Honda BF75-BF130 | | |  |
| REF | R.O. OEM |  | | | | | | | |
| REC91-859046Q4 | MC 91-859046Q4 HONDA 89-89206-ZW7-000AH | Mercury Mariner Force V4 & V6 Mercruiser Honda BF75-BF130 | | | | | | | |

JUEGO DE MACHOS

TAP AND DIE SET

FILIERA

KIT TARAUDS ET FILIÈRES

Garantía de por vida.

Lifetime warranty.

Garantita a vita.

Garantie à vie

| REF | |
|-----------|---|
| CRA952343 | Pulgadas Inches Pollici Pouce |
| CRA952344 | Métricos Metrical Metrico Métrique |



EXTRACTOR TAPONES DE TRIM

TRIM PLUGS EXTRACTOR

ESTRATTORE PER TAPPI DI TRIM

EXTRACTEUR DE BOUCHON DE TRIM

new

| REF | |
|----------------|--|
| RECTOOLTRIMKIT | RECTOOLTRIM1 + RECTOOLTRIM2 + RECTOOLTRIM3 |



**KITS DE RECAMBIO
SPARE KITS
KIT DI RICAMBIO
KITS DE RECHANGE**



| REF | ÚTIL TOOL ATTREZZO UTILILE | | | (A) |
|--------------|-------------------------------------|-----------|-------------|-------|
| RECTOOLTRIM1 | 1/2" | + RECPIN4 | + RECPIN4.5 | 38 mm |
| RECTOOLTRIM2 | 1/2" | + RECPIN4 | + RECPIN4.5 | 32 mm |
| RECTOOLTRIM3 | 1/2" | + RECPIN6 | | 35 mm |

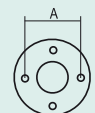

| REF | | PARA FOR PER POUR |
|-----------|----------------|------------------------------|
| RECPIN4 | 3 PIN x 4 mm | RECTOOLTRIM1 RECTOOLTRIM1 |
| RECPIN4.5 | 3 PIN x 4.5 mm | RECTOOLTRIM1 |
| RECPIN6 | 3 PIN x 6 mm | RECTOOLTRIM3 |

Los pines de repuesto no tienen garantía.
Replacement pins are not guaranteed.
I perni di ricambio non sono garantiti.
Les broches de remplacement ne sont pas garanties.

| TRIM PISTON | TILT PISTON | | HP |
|--------------|--------------|--|----------------------|
| RECTOOLTRIM1 | | Yamaha | F25 - F40 |
| RECTOOLTRIM2 | RECTOOLTRIM3 | Yamaha | F115 |
| RECTOOLTRIM2 | RECTOOLTRIM3 | Yamaha | F150 |
| RECTOOLTRIM2 | RECTOOLTRIM1 | Yamaha | F150 |
| RECTOOLTRIM2 | RECTOOLTRIM3 | Yamaha | F175 - F200 (2.8L) |
| RECTOOLTRIM1 | RECTOOLTRIM1 | Yamaha | F200 - F250 (3.3L) |
| RECTOOLTRIM1 | RECTOOLTRIM1 | Yamaha | F225 - F300 (4.2L) |
| RECTOOLTRIM2 | RECTOOLTRIM3 | Yamaha | F350 |
| RECTOOLTRIM2 | | Yamaha | F425 |
| RECTOOLTRIM2 | | Yamaha | 55-90 (2-Stroke) |
| RECTOOLTRIM2 | RECTOOLTRIM3 | Yamaha | 115-200 + VMAX |
| RECTOOLTRIM1 | RECTOOLTRIM1 | Yamaha | 225 (2-Stroke) |
| RECTOOLTRIM2 | RECTOOLTRIM3 | Suzuki | DF115 - DF300 |
| RECTOOLTRIM2 | RECTOOLTRIM3 | Evinrude | 115 - 300 ETEC |
| RECTOOLTRIM3 | | Johnson Evinrude | 25 - 50 (2 Strokes) |
| RECTOOLTRIM2 | RECTOOLTRIM3 | Johnson Evinrude | 60 - 250 (2 Strokes) |
| RECTOOLTRIM2 | RECTOOLTRIM3 | Honda | 75 - 225 |
| RECTOOLTRIM1 | | Seastar Steering | |
| RECTOOLTRIM2 | | Volvo Penta Trim Cylinders | |
| RECTOOLTRIM1 | | Mercuriser Alpha One Et Bravo Trim Cylinders | |

JUEGO DE LLAVES

MECHANICAL TOOL SET

CASSETTA ATTREZZI

MALETTE D'OUTILLAGE

154 llaves en métrico y en pulgadas para un completo trabajo en motores. Garantía de por vida.

154 pcs. Mechanics tool set in metric & inches. Lifetime warranty.

154 chiavi metriche e in pollici per un lavoro completo nel motore. Garantita a vita.

154 clés, métriques et en pouces pour un travail complet sur le moteur. Garantie à vie

| REF |
|-----------|
| CRA935154 |



| HERRAMIENTA AROS-PISTONES | RING COMPRESOR KIT | KIT FASCE-PISTONI | OUTIL SEGMENTS ET PISTONS |
|---|---|--|---|
| <p>Kit herramientas para la instalación de aros y pistones. Incluye 6 bandas de 7 a 11 cm.</p> <p>REF SSP4213</p> <p>RECMAR®</p> | <p>Ring compressor kit for pistons. Includes 6 band 2-7/8" - 4-3/8"</p>  | <p>Kit per montare le fasce dei pistoni. Include 6 bande da 7 a 11 cm.</p> | <p>Kit d'outils pour l'installation des segments et pistons. Il comprend 6 colliers de 7 à 11 cm.</p> |

| | |
|--|---|
| <p>REF</p> <p>SSP4206</p> <p>SSP4207</p> <p>RECMAR®</p> | <p>PARA AROS Y PISTONES RING COMPRESOR PISTONS PER FASCE E PISTONI POUR SEGMENTS ET PISTONS</p> <p>127 mm Ø / 2-1/8" - 5" Ø</p> <p>178 mm Ø / 3-1/2" - 7" Ø</p>  |
|--|---|

| KIT ALARGADOR CABLE BUJIAS | EXTENSION WIRES | KIT PROLUNGA CAVI CANDELE | KIT EXTENSION DE FAISCEAU DE BOUGIE | | | | | | | | | |
|---|-----------------|---------------------------|-------------------------------------|------------|-------|---|------------|-------|---|---|--|--|
| <table border="1"> <tr> <th>REF</th> <th>Length</th> <th>Quantity</th> </tr> <tr> <td>REC5119902</td> <td>18 cm</td> <td>4</td> </tr> <tr> <td>REC5119903</td> <td>60 cm</td> <td>4</td> </tr> </table> <p>RECMAR®</p> | REF | Length | Quantity | REC5119902 | 18 cm | 4 | REC5119903 | 60 cm | 4 |  <p>REC5119902</p> |  <p>REC5119903</p> | |
| REF | Length | Quantity | | | | | | | | | | |
| REC5119902 | 18 cm | 4 | | | | | | | | | | |
| REC5119903 | 60 cm | 4 | | | | | | | | | | |

| PULIDORA DE CILINDROS | ENGINE CYLINDER HONE | PULITRICE CILINDRI | RODOIR DE CYLINDRE |
|---|--|---|--|
| <p>Para pulir los cilindros de los bloques. Garantizada de por vida.</p> <p>REF CRA904633</p> <p>RECMAR®</p> | <p>Quickly removes the glaze from engine cylinder walls before installing new piston rings. Lifetime warranty.</p> | <p>Per pulire i cilindri dei blocchi. Garantita a vita.</p> | <p>Poli les cylindres des blocs moteur. Garanti à vie.</p>  |
| <p>KIT DE 3 PIEDRAS PARA RECAMBIO DE LA PULIDORA 3 PIECES SPARE PART FOR HONE KIT DA 3 SPAZZOLE DI RICAMBIO PER LA PULITRICE KIT DE 3 PIERRES DE REMPLACEMENT POUR LE RODOIR</p> <p>REF CRA946331</p>  | | | |

VACUÓMETRO DOBLE FUNCIÓN

Presión y vacío. Ideal para comprobar las colas.

REF
REC55134
RECMAR

PRESSURE / VACUUM TESTER

Combination unit that does pressure and vacuum testing in one units. Recommended to test drives.

VACUOMETRO DOPPIA FUNZIONE

Pressione e sottovuoto. Ideale per il controllo dei piedi.

VACUOMÈTRE DOUBLE FONCTION

Pression et vide. Idéal pour vérifier les embases.



COMPRESÍMETRO

Para motores gasolina con bases GM o Ford.

REF
CRA902171

COMPRESSION TESTER KIT

For gas engines with GM or Ford base.

MANOMETRO

Per motori benzina con base GM e Ford.

COMPRESSIOMÈTRE

Pour les moteurs à essence bases GM ou Ford.



PISTOLA PUESTA A PUNTO

Con regulador de avance.

REF
CRA921023

TIMING LIGHT

0-60 advance scale.

PISTOLA MESSA A PUNTO

Con regolatore avanzamento.

LAMPE STROBOSCOPIQUE

Avec régulateur d'avance.



INTERRUPTOR ARRANQUE

REF
CRA902175

REMOTE STARTER

INTERRUTTORE AVVIAMENTO

INTERRUPTEUR DE DÉMARRAGE A DISTANCE



MULTITESTER DIGITAL

DIGITAL MULTITESTER

MULTITESTER DIGITALE

MULTIMÈTRE DIGITAL

Multímetro ecológico autorango con símbolos de función en pantalla, energía mediante generador manual incorporado, también puede funcionar con batería. Incorpora manivela plegable para cargar el multímetro, 20 segundos de manivela generan suficiente carga para trabajar 10 min (sin batería).
Equipo recomendado para mantenimiento del sector náutico.
Multímetro digital de 3 5/6 dig. (6000)
Medidas de tensión CC / CA
Medidas de corriente CC / CA
Medidas de resistencia / continuidad
Medidas de capacidades / frecuencias
Medidas / Prueba de diodos
Detecta tensión AC o DC automáticamente
Retención de lectura Hold
Selección de rango: auto y manual
Función de autoapagado (3min)
Pantalla grande 46x45mm

Ecological autoranging multimeter with function panel on screen, hand power generator, it can also run on battery. Includes folding crank to charge the meter, 20-second crank generate enough charge to work 10 min (without battery).
Recommended equipment for maintenance, nautical sector.
Digital Multimeter 3 5/6 Digit. (6000)
Measures voltage DC / AC
Measures DC / AC current
Measures resistance / continuity
Measures capacity / frequency
Measures / Diode Test
Detects AC or DC voltage automatically
Hold reading retention
Range Selection: auto and manual
Auto Off function (3min)
Large display 46x45mm

Multitester ecologico con simboli di funzione nello schermo, energia mediante generatore manuale incorporato, funziona anche con batteria.
Manovella piegabile incorporata, per ricaricare il multitester, 20 secondi di manovella. In genere per lavorare è sufficiente caricarlo per 10 minuti senza batteria.
Strumento raccomandato per utilizzo nel settore nautico.
Multitester digitale 3 5/6 dig. (6000)
Misure di tensione CC / CA
Misure di corrente CC / CA
Misure di resistenza / continuità
Misure di capacità / frequenza
Misure / Prova di diodi
Rileva la tensione AC o DC automaticamente
Ritenzione di lettura Hold
Selezione di gamma: auto e manuale
Accensione automatica (3min)
Display grande 46x45mm

Multimètre écologique avec symboles de fonction sur l'écran, alimentation au moyen d'un générateur manuel intégré, il peut également fonctionner avec une batterie. Il intègre une manivelle pliante pour charger le multimètre, 20 secondes de manivelle génèrent suffisamment de charge pour fonctionner 10 min (sans batterie).
Matériel recommandé pour la maintenance, secteur nautique.
Multimètre digital 3 5/6 chiffres. (6000)
Mesures de tension DC / AC
Mesures de courant DC / AC
Mesures de résistance / continuité
Mesures de capacité / fréquence
Mesures / Test de diode
Détecte automatiquement la tension alternative ou continue
Maintien la rétention de lecture
Sélection de gamme: automatique et manuelle
Fonction d'arrêt automatique (3min)
Grand écran 46x45mm



REF
TEC145

VACUÓMETRO SINCRONIZADOR

VACUUMMATE ALLWEATHER

VACUOMETRO

VACUOMETRE SYNCHRONISEUR

Vacuómetro, sincronizador de admisión, analizador dinámico de fugas y tacómetro. Impermeable e insumergible con una funda especial.
Posee mayor estabilidad que los indicadores analógicos o que cualquier otro sistema. Se autorregula a los cambios de presión barométrica.
Alimentación con corriente continua de 12 V, se puede utilizar con cualquier batería de embarcación o vehículo o con un adaptador de entrada a la red (230V/12V).
Indicadores LED de batería descargada y de alimentación no adecuada.
Contiene: Cable y pinzas por alimentación 12V, tubos de santoprene de conexión, 2 juegos de adaptadores flexi-rígidos, caja de almacenaje.

Vacuomate allweather, 4 x carb/throttle valve.
Shock resistant composite-moulded polyurethane and polycarbonate casing for maximum strength and resilience. Self-calibrates for barometric changes. Solid state sensors are drop proof. It has internal rechargeable 1,5Ah 7,2V NiMH batteries providing up to 6 hours autonomy. Battery power is conserved by auto-switch-off 5 minutes after last being used and LEDs use full power only when measurements are taken. Kit includes custom travel case, battery cord-set, T-connector & 2 full sets of unique flexi-rigid.

Vacuometro, sincronizzatore d'aspirazione, analizzatore dinamico di fughe e tachimetro.
Impermeabile e immergibile con una custodia speciale.
Possiede maggiore sensibilità degli indicatori analogici o con altri sistemi. Si autoregola al cambio di pressione barometrica.
Alimentazione con corrente continua da 12 V, si può utilizzare con qualsiasi batteria per imbarcazioni, veicoli e con un adattatore di entrata da 230V/12V.
Indicatore LED di batteria scarica e di alimentazione non corretta. Contiene: Cavi e pinze per alimentazione 12V, tubi di santoprene di connesione, 2 adattatori flexi-rigidi, scatola per conservare l'attrezzo.

VacuomMate affiche la pression d'admission individuelle de 4 carburateurs séparés (ou boîtier papillons à injection de carburant). Imperméable et insumersible avec une housse spéciale. Il a une plus grande stabilité que les indicateurs analogiques ou tout autre système. Il autorégule les changements de pression barométrique.
Alimentation 12 V DC, utilisable avec n'importe quelle batterie de bateau ou de véhicule ou avec un adaptateur secteur (230V/12V).
Indicateurs LED de batterie déchargée et de puissance insuffisante.
Contient: câble d'alimentation 12V et pinces, tubes de connexion, 2 jeux d'adaptateurs flexi-rigides, boîte de rangement.



REF
TCMVRM5

PINZA AMPERIMÉTRICA

AMPERIC NIPPER

PINZA AMPEROMETRICA

PINCE AMPÈREMÉTRIQUE

Tenaza autorango y multifunción para AC y DC.
Diámetro maxilar: 30 mm
Display de 3 3/4 dígitos. Máx. 3999.
Realiza medidas en: AC/DC: 40A/400A
Precisión: +/- (1,9% + 5 d. en AC)
Ancho de banda: 50Hz - 500Hz (AC)
Resolución: AC/DC 10mA. 100mV.
Resistencia: 400 Ohms.

Iron autoranging and multifunction for AC and DC.
Jaw diameter: 30 mm
Display of 3 3/4 digit. Max. 3999.
Measurements in: AC/DC current: 40A/400A
Precision: +/- (1,9% + 5 d. en AC)
Precision: +/- (2,5% + 10 d. en DC)
Bandwidth: 50 Hz - 500 Hz (AC)
Resolution: AC/DC 10mA. 100mV.
Resistance: 400 Ohms.

Pinza multifunzione per AC e DC.
Diámetro max: 30 mm.
Display da 3 3/4 digitale. Máx. 3999.
Può realizzare misurazioni in:
Corrente AC/DC: 40A/400A.
Precisione: +/- (1,9% + 5 d. en AC)
Precisione: +/- (2,5% + 10 d. en DC)
Banda larga: 50Hz - 500Hz (AC)
Risoluzione: AC/DC 10mA. 100mV.
Resistenza: 400 Ohms.

Pince ampèremétrique multifonction pour AC et DC.
Diamètre maxi: 30 mm
Affichage de 3 3/4 chiffres. Max. 3999
Effectue des mesures en: AC / DC: 40A / 400A
Précision: +/- (1,9% + 5 jours en CA)
Précision: +/- (2,5% + 10 d. en DC)
Bande passante: 50 Hz - 500 Hz (AC)
Résolution: AC / DC 10mA. 100mV
Résistance: 400 Ohms



REF
TEC218

| TERMÓMETRO MULTIFUNCIONAL | INFRARED THERMOMETER | TERMOMETRO MULTIFUNZIONALE | THERMOMÈTRE MULTIFONCTIONNEL |
|---|---|--|--|
| <p>Termómetro multifunción digital, por rayos infrarrojos. Emisividad fija: 0,95 Rango: -20°C + 320°C. Lectura en grados centígrados y fahrenheit. Precisión +/- 2%. Resolución: 1°C Distancia óptima de medida: de 6 a 60 cm. Retención de la última lectura. Autoapagado.</p> | <p>Multifunction digital infrared thermometer. Fixed emissivity: 0.95 range: - 20 °C + 320 °C. Reading in Celsius and Fahrenheit. Precision +/-2%. Resolution: 1°C Distancia optimal measurement: 6 to 60 cm. Retention of the last reading. Auto Off function.</p> | <p>Termometro multifunzione digitale, a infrarrossi. Misurazione: 0,95 Rango: -20°C + 320°C. Lettura in gradi centigradi e fahrenheit. Precisione +/- 2%. Risoluzione: 1°C Distanza ottimale di misurazione: da 6 a 60 cm. Memoria dell'ultima lettura. Autospegnimento.</p> | <p>Thermomètre multifonction numérique, par rayons infrarouges. Mesure fixe: 0,95 Plage: -20°C + 320°C. Lecture en degrés Celsius et fahrenheit. Précision +/- 2%. Résolution: 1°C Distance de mesure optimale: de 6 à 60 cm. Conservation de la dernière lecture. Arrêt automatique</p> |



REF
TECDT8580

| ESTABILIZADORES, ELEVADORES Y SEGURIDAD | HYDROFOIL STABILIZER AND SECURITY | STABILIZZATORI, ASCENSORI E SICUREZZA | STABILISATEURS, POWER TRIM-LIFT ET SÉCURITÉ |
|--|--|--|--|
| <p>ALETAS ESTABILIZADORAS</p> <p>Aletas para acoplar a la placa de cavitación de los motores fueraborda y colas intra-fueraborda. Se obtiene el planeo en menor tiempo. Elimina la cavitación. Mejora la sustentación. Permite mayor estabilidad y ahorro de combustible.</p> | <p>HYDROFOIL STABILIZER</p> <p>Gives outboards and sterndrives a performance boost. Wipes out cavitation. On plane in less time. Saves fuel. Delivers true stabilization.</p> | <p>ALETTE</p> <p>Alette da installare nei motori fuoribordo o nei piedi entro-fuoribordo. Planata in minor tempo. Elimina la cavitazione. Migliora la stabilità e riduce il consumo del carburante.</p> | <p>HYDROFOIL</p> <p>Hydrofoil à fixer sur la plaque de cavitation des moteurs hors-bord et les embases. Le déjaugage met moins de temps. Élimine la cavitation. Permet une plus grande stabilité et économise de carburant.</p> |

| REF | | (cm) |
|---------|----------------|-------|
| SRXPIJR | 2,5 HP - 40 HP | 18,50 |
| SRXPI | 40 HP + | 18,50 |



SRXPIJR



SRXPI

| | | | |
|--|----------------------------------|------------------------------|--|
| <p>Diseño de montaje SIN AGUJEROS.</p> | <p>NO-DRILL mounting design.</p> | <p>Montaggio senza fori.</p> | <p>Conception de montage SANS TROUS.</p> |
|--|----------------------------------|------------------------------|--|

| REF | | (cm) |
|------|----------------|-------|
| SRSF | 40 HP - 300 HP | 18,50 |





Diseño de montaje SIN AGUJEROS
Perfil hidrodinámico pulido
Empuje mejorado
Canalización del chorro de agua



NO-DRILL mounting design.
Sleeker hydrodynamic profile.
Captive Prop-Wash Resulting In
Improved Thrust
Fastest Hole Shot

Montaggio senza fori.
Profilo idrodinamico.
Spinta migliorata.
Canalizzazione del getto dell'acqua.

Conception de montage SANS TROUS
Profil hydrodynamique poli
Poussée améliorée
Canalisation par jet d'eau

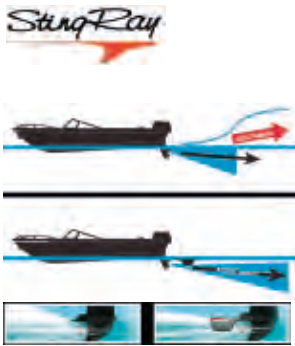
| REF |  |  (cm) |
|-----------|---|--|
| SRXRIIUR. | 2,5 HP - 75 HP | 18,50 |
| SRXRIII | 75 HP + | 18,50 |



| REF |  |  (cm) |
|--------|--|--|
| SRPRO1 | 40 HP - 300 HP | 19,55 |

POWER TRIM-LIFT

Soporte con kit de Power Trim y Tilt.
Fabricado en extrusión de aluminio con tornillos de acero inox.
El motor electro-hidráulico de 3500kg de empuje se encuentra dentro de un contenedor para una mayor protección.

Electric hydraulic Tilt & Trim with a rated thrust of 7800 lbs.
Made with extruded aluminum and stainless steel fasteners.

Supporto con kit Power Trim e Tilt.
Fabricato in alluminio con viti in acciaio inox.
Il motore elettroidraulico ha una spinta da 3500kg e si trova all'interno di un contenitore per una maggior protezione.

Prise en charge avec le kit Power Trim et Tilt.
Fabriqué en aluminium extrudé avec des vis en acier inoxydable.
Le moteur de poussée électro-hydraulique de 3500 kg est à l'intérieur d'un boîtier pour une protection supplémentaire.

| | | | | CMC13002Q | CMC13001Q |
|-----------------------|-----------------------|-------------------|--------------------|--------------|--------------|
| Fuerabordas | Outboards | Fuoribordo | Hors-bord | -130 HP | -130 HP |
| Recorrido Trim | Trim travel | Escursione Trim | Angle de Trim | 20° | 20° |
| Recorrido Tilt | Tilt travel | Escursione Tilt | Angle de Tilt | 90° | 90° |
| Alimentación | Operation | Alimentazione | Alimentation | 12 V | 12 V |
| Reloj indicador | Lift gauge | Indicatore trim | Indicateur de trim | | ✓ |
| Separación del espejo | Set-Back from transom | Specchio di poppa | Recul de traverse | 152 mm 6" | 152 mm 6" |



Soporte con kit de Power Trim y Tilt.
Fabricado en extrusión de aluminio con tornillos de acero inox.
El motor electro-hidráulico de 3500 kg de empuje se encuentra dentro de un contenedor para una mayor protección.

Electric hydraulic Tilt & Trim with a rated thrust of 7800 lbs.
Made with extruded aluminum and stainless steel fasteners.

Supporto con kit Power Trim e Tilt.
Fabricato in alluminio con viti in acciaio inox.
Il motore elettroidraulico ha una spinta di 3500kg e si trova all'interno di un contenitore per una maggior protezione.

Prise en charge avec le kit Power Trim et Tilt.
Fabriqué aluminium extrudé avec des vis en acier inoxydable.
Le moteur électro-hydraulique à une poussée de 3500 kg il est à l'intérieur d'un boîtier pour une protection supplémentaire.

| | | | | CMC52100D |
|-----------------------|-----------------------|-------------------|-------------------|------------------|
| Fuerabordas | Outboards | Fuoribordo | Hors-bord | -35 HP |
| Recorrido Trim | Trim Travel | Escursione Trim | Angle de Trim | 84° |
| Alimentación | Operation | Alimentazione | Alimentation | 12 V |
| Separación del espejo | Set-Back from transom | Specchio di poppa | Recul de traverse | 140 mm 5 1/2" |



POWER LIFT

Soporte con kit elevador vertical.
Fabricado en extrusión de aluminio con tornillos de acero inox.
El motor electro-hidráulico de 3500 kg de empuje se encuentra dentro de un contenedor para una mayor protección. Tornillos de 3/4" de acero inoxidable, con tuercas de aleación de aluminio y bronce resistentes a los choques y corrosión.

Electric hydraulic power lift transom jack with a rated thrust of 7800 lbs.
Made of 1/2" 6061 T6 alloy aluminum extrusions and stainless steel fasteners.
Totally waterproof electro-hydraulic power lift transom jack with a rated thrust of 7800 lbs.

Supporto con kit elevatore verticale.
Fabricato in alluminio con viti in acciaio inox.
Il motore elettroidraulico ha una spinta da 3500kg e si trova all'interno di un contenitore per una maggior protezione. Viti da 3/4" in acciaio inox, con dadi in alluminio e bronzo resistenti alla corrosione.

Support avec kit de levage vertical.
Fabriqué en aluminium extrudé avec des vis en acier inoxydable.
Le moteur électro-hydraulique à poussée de 3500 kg est à l'intérieur d'un boîtier pour une protection supplémentaire. Vis 3/4" en acier inoxydable, avec écrous en alliage d'aluminium et de bronze résistant aux chocs et à la corrosion.

| | | | | CMC65001Q |
|-----------------------|-----------------------|-------------------|--------------------|---|
| Fuerabordas | Outboards | Fuoribordo | Hors-bord | V6 |
| Recorrido vertical | Vertical travel | Lavoro verticale | Relevage vertical | 125 mm / 5" |
| Alimentación | Operation | Alimentazione | Alimentation | 12V |
| Dimensiones | Dimensions | Dimensioni | Les dimensions | 460 x 420 mm 18 ¹ / ₈ " x 16 ¹ / ₂ " |
| Reloj indicador | Lift gauge | Indicatore trim | Indicateur de Trim | ✓ |
| Separación del espejo | Set-Back from transom | Specchio di poppa | Recul de traverse | 140 mm / 5 ¹ / ₂ " |



| | | | | CMC61001Q |
|-----------------------|-----------------------|-------------------|--------------------|--------------|
| Reloj indicador | Lift gauge | Indicatore trim | Indicateur de Trim | ✓ |
| Separación del espejo | Set-Back from transom | Specchio di poppa | Recul de traverse | 254 mm / 10" |



**V-8
300 HP**

| | | | | CMC65501 |
|-----------------------|-----------------------|-------------------|--------------------|------------------|
| Fuerabordas | Outboards | Fuoribordo | Hors-bord | V8 300HP |
| Reloj indicador | Lift gauge | Indicatore trim | Indicateur de Trim | ✓ |
| Separación del espejo | Set-Back from transom | Specchio di poppa | Recul de traverse | 140 mm 5-1/2" |



new

Soporte con kit elevador vertical.
Fabricado en extrusión de aluminio con tornillos de acero inox. de 3/4".



Electric hydraulic power lift transom jack. Made with extruded aluminum and stainless steel fasteners.
Totally waterproof.

Supporto con kit elevatore verticale.
Fabricato in alluminio con viti in acciaio inox da 3/4".



Support avec kit de levage vertical.
Fabriqué en aluminium extrudé avec des vis en acier inoxydable. 3/4".

| | | | | THAHJM-4DP |
|-----------------------|-----------------------|-------------------|--------------------|---|
| Fuerabordas | Outboards | Fuoribordo | Hors-bord | 75 HP |
| Recorrido vertical | Vertical travel | Lavoro verticale | Relevage vertical | 127 mm / 5" |
| Alimentación | Operation | Alimentazione | Alimentation | 12 V |
| Reloj indicador | Lift gauge | Indicatore trim | Indicateur de Trim | ✓ |
| Separación del espejo | Set-Back from transom | Specchio di poppa | Recul de traverse | 37 x 30 cm 14 ⁵ / ₈ " x 11 ¹ / ₂ " |



| | | | |
|--|---|--|---|
| <p>ADAPTADORES. POWER TRIM-LIFT</p> <p>Par de cuñas de 2º inclinación para espejo de popa.</p> <p>REF CMC20122Q</p>  | <p>BACK SPACERS. POWER TRIM-LIFT</p> <p>Pair of 2 degrees wedge for the transom.</p> | <p>ADATTATORI. POWER TRIM-LIFT</p> <p>Piastre per lo specchio di poppa inclinate di 2°</p>  | <p>ADAPTATEURS POWER TRIM-LIFT</p> <p>Paire de cales avec 2ème inclinaison pour tableau arrière.</p> |
|--|---|--|---|

| | | | |
|---|---|--|--|
| <p>Kit de adaptadores para la instalación de motores con palomillas.</p> <p>REF CMC13022Q</p>  | <p>Adaptors kit for motors mounted with transom clamps.</p> | <p>Kit per l'installazione di motori con chiusura con galletti.</p>  | <p>Kit d'adaptateur pour l'installation du moteur.</p> |
|---|---|--|--|

| | | | |
|--|--|---|--|
| <p>ADAPTADORES. POWER LIFT</p> <p>Kit de adaptadores para motores de 75 HP.</p> <p>REF THAHJM-CMADP</p>  | <p>BACK SPACERS. POWER LIFT</p> <p>Clampon motor adapter 75 HP.</p>  | <p>ADATTATORI. POWER LIFT</p> <p>Kit adattatori per motori 75 HP</p>  | <p>ADAPTATEURS POWER LIFT</p> <p>Kit adaptateur pour moteurs 75 CV.</p> |
|--|--|---|--|

| <p>ALARGO BARRA FUERABORDA</p> <p>Prolongador de caña con pulsador de paro, para motores fueraborda. Fabricado en aluminio anodizado y maneta de plástico.</p> <table border="1"> <tr> <th>REF</th> <th>(cm)</th> <th></th> </tr> <tr> <td>GS73135</td> <td>70</td> <td>Fijo Fixed Fisso Fixe</td> </tr> <tr> <td>GS73136</td> <td>60 - 100</td> <td>Telescópico Telescopic Telescopico Télescopique</td> </tr> </table> <p>GOLDENSHIP</p> | REF | (cm) | | GS73135 | 70 | Fijo Fixed Fisso Fixe | GS73136 | 60 - 100 | Telescópico Telescopic Telescopico Télescopique | <p>EXTENSION HANDLE OUTBOARD</p> <p>With push-button to switch-off the engine. Made of anodized aluminum and plastic handle.</p> | <p>PROLUNGA PER FUORIBORDO</p> <p>Prolunga per fuoribordo, fabbricato in alluminio anodizzato e impugnatura in plastica.</p> | <p>RALLONGE DE BARRE FRANCHE POUR HB</p> <p>Rallonge de barre franche avec bouton d'arrêt, pour moteurs hors-bord. Fabriqué en aluminium anodisé et poignée en plastique.</p>  |
|--|----------|---|--|---------|----|-----------------------------|---------|----------|---|---|---|---|
| REF | (cm) | | | | | | | | | | | |
| GS73135 | 70 | Fijo Fixed Fisso Fixe | | | | | | | | | | |
| GS73136 | 60 - 100 | Telescópico Telescopic Telescopico Télescopique | | | | | | | | | | |

| <p>PROTECTOR DE HÉLICES</p> <p>Mejora el control direccional y aumentando la eficiencia de la hélice. Fabricado en polipropileno de alto impacto. NOTA: Todos los motores «Big Foot» y de arrastre requieren la medida superior. Velocidad Máx: 30 nudos</p> <table border="1"> <thead> <tr> <th>REF</th> <th></th> <th>Ø INT</th> </tr> </thead> <tbody> <tr> <td>REC5-9.8</td> <td>5 - 9 HP</td> <td>9"</td> </tr> <tr> <td>REC9.9-20</td> <td>9.9 - 20 HP</td> <td>9"</td> </tr> <tr> <td>REC25-35</td> <td>25 - 35 HP</td> <td>11"</td> </tr> <tr> <td>REC40-65</td> <td>40 - 65 HP</td> <td>13"</td> </tr> <tr> <td>REC70-100</td> <td>70 - 100 HP</td> <td>14"</td> </tr> <tr> <td>REC110-230</td> <td>110 - 230 HP</td> <td>16"</td> </tr> </tbody> </table> <p>GOLDENSHIP</p> | REF | | Ø INT | REC5-9.8 | 5 - 9 HP | 9" | REC9.9-20 | 9.9 - 20 HP | 9" | REC25-35 | 25 - 35 HP | 11" | REC40-65 | 40 - 65 HP | 13" | REC70-100 | 70 - 100 HP | 14" | REC110-230 | 110 - 230 HP | 16" | <p>PROPELLER PROTECTOR</p> <p>Manufactured in high impact polypropylene. Better control in directional force. Increase the propeller efficiency. NOTE: All hp's with «Big Foot» and High Thrust applications require next size up. Max. Speed: 30 knots</p> | <p>PROTETTORI ELICHE</p> <p>Migliora il controllo direzionale e aumentando l'efficienza delle eliche. Prodotto in polipropilene di alta qualità. NOTA: Tutti i motori «Big Foot» a alta spinta richiedono la referenza superiore. Velocità Mas.: 30 nodi</p>  | <p>PROTECTION D'HÉLICE</p> <p>Améliore le contrôle directionnel et augmente l'efficacité de l'hélice. Fabriqué en polypropylène résistant aux chocs. REMARQUE: Tous les moteurs "Big Foot" et à forte poussée nécessitent la taille supérieure. Vitesse maximale: 30 nœuds</p> |
|--|--------------|-------|-------|----------|----------|----|-----------|-------------|----|----------|------------|-----|----------|------------|-----|-----------|-------------|-----|------------|--------------|-----|---|---|--|
| REF | | Ø INT | | | | | | | | | | | | | | | | | | | | | | |
| REC5-9.8 | 5 - 9 HP | 9" | | | | | | | | | | | | | | | | | | | | | | |
| REC9.9-20 | 9.9 - 20 HP | 9" | | | | | | | | | | | | | | | | | | | | | | |
| REC25-35 | 25 - 35 HP | 11" | | | | | | | | | | | | | | | | | | | | | | |
| REC40-65 | 40 - 65 HP | 13" | | | | | | | | | | | | | | | | | | | | | | |
| REC70-100 | 70 - 100 HP | 14" | | | | | | | | | | | | | | | | | | | | | | |
| REC110-230 | 110 - 230 HP | 16" | | | | | | | | | | | | | | | | | | | | | | |

ANTI-ROBO

Para motores fueraborda. Fabricado en acero inox. de 3 mm con candado de latón con 2 llaves.

| REF | |
|---------|--------|
| GS73138 | 240 mm |
| GS73139 | 320 mm |



ANTI THEFT

Manufactured in 3 mm stainless steel pipe. Provided with a padlock in brass with 2 keys.



ANTI-FURTO

Per motori fuoribordo. Prodotto in acciaio inox da 3 mm con lucchetto in ottone con 2 chiavi.

ANTIVOL

Pour les moteurs hors-bord. Fabriqué en acier inoxydable, 3 mm avec serrure en laiton livrée avec 2 clés.

ARNÉS FUERABORDA

Confeccionado con cincha sintética. Una sola medida se ajusta para fuerabordas de 2 a 15 HP.

| REF |
|---------|
| GS73069 |



HOISTING HARNESS

Outboard hoisting harness. One size works on virtually all 2 to 15 HP outboards.

IMBRAGATURA FUORIBORDO

Confezionato con cinghia sintetica. Una sola misura, si regola per i fuoribordo da 2 a 15 HP.

HARNAIS HORS-BORD

Fabriqué dans une sangle synthétique. Une seule taille à ajustée pour les moteurs hors-bord de 2 à 15 CV.



FUNDAS PARA FUERABORDA

Para motores fueraborda de 2 y 4 tiempos. Confeccionadas en tejido de poliéster de 320 g/m2. Impermeabilizado, transpirable. Costuras reforzadas. Color gris claro.

| REF | | A | B | C |
|-----------|------------|-------|-------|-------|
| OCEMA0741 | -15 hp | 32 cm | 27 cm | 50 cm |
| OCEMA0742 | 15-30 hp | 40 cm | 30 cm | 56 cm |
| OCEMA0743 | 30-60 hp | 49 cm | 36 cm | 62 cm |
| OCEMA0744 | 60-100 hp | 53 cm | 40 cm | 68 cm |
| OCEMA0745 | 100-150 hp | 58 cm | 46 cm | 74 cm |
| OCEMA0746 | 175-250 hp | 60 cm | 50 cm | 82 cm |



OUTBOARD COVERS

For outboard engines 2 Et 4 stoke. Manufactured in 320 gsm polyester canvas. Weather proof, breathable. Reinforced top stitched seams. Grey color.

COPERTURA FUORIBORDO

Per motori fuoribordo di 2 e 4 tempi. Confezionato in tessuto di poliesterre da 320 g/m². Impermeabile, traspirante. Cuciture rinforzate. Colore grigio chiaro.

HOUSES POUR HORS-BORD

Pour moteurs hors-bord 2 et 4 temps. Fabriqué en tissu polyester 320g/m². Imperméable, respirant. Coutures renforcées. Couleur gris clair.

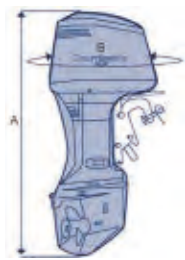

| REF | | A | B |
|-----------|--------------|--------|--------|
| OCEMA0751 | - 6 hp | 98 cm | 126 cm |
| OCEMA0752 | 8 - 15 hp | 110 cm | 140 cm |
| OCEMA0753 | 15 - 20 hp | 125 cm | 150 cm |
| OCEMA0754 | 20 - 30 hp | 137 cm | 165 cm |
| OCEMA0755 | 30 - 60 hp | 144 cm | 180 cm |
| OCEMA0756 | 60 - 100 hp | 170 cm | 200 cm |
| OCEMA0757 | 115 - 150 hp | 190 cm | 226 cm |
| OCEMA0758 | 175 - 250 hp | 197 cm | 248 cm |

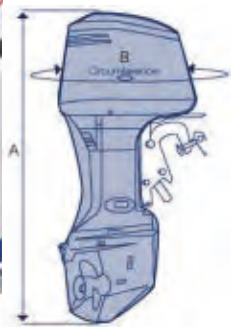

YAMAHA

ES

| | | | | | |
|--|-----------|---|-----|------------------------------------|-----|
| GUÍA MANTENIMIENTO COLAS Y Y KITS | 64 | CDI Y CAJAS NEGRAS | 117 | INTERRUPTOR PANEL SIMPLE (704) | 128 |
| SISTEMA DE ALIMENTACIÓN Y FILTRACIÓN | 74 | DESCONECTORES DE SEGURIDAD | 120 | INTERRUPTOR POWER TRIM (703) | 127 |
| ACEITE | 84 | KITS | 121 | ZUMBADOR ACÚSTICO (703) | 127 |
| ACELERADOR | 101 | LLAVES DE ARRANQUE | 113 | MANDO ACELERADOR | 134 |
| VARILLA DE ACELERADOR | 101 | LLAVE DOBLE INSTALACIÓN | 113 | MANETAS Y FIJACIONES | 134 |
| BOMBA DE COMBUSTIBLE EN LÍNEA | 74 | LLAVE CON CHOQUE | 114 | MANDOS DE CONTROL | 126 |
| ABRAZADERA PARA MANGUERA | 75 | LLAVE PARA MANDO POPERO | 114 | CONECTORES DE CABLES | 127 |
| ADAPTADOR LÍNEA DE COMBUSTIBLE | 75 | MONTAJE EN MANDO DE CONTROL | 113 | MANDO LATERAL PUSH TO OPEN | 126 |
| BOMBA DE COMBUSTIBLE | 74 | MONTAJE EN PANEL | 113 | MANDO LATERAL | 127 |
| LÍNEA DE COMBUSTIBLE | 74 | MOTORES DE ARRANQUE | 110 | MANDO PARA CONSOLA | 127 |
| MANGUERA DE COMBUSTIBLE | 74 | CABLE DE MOTOR DE ARRANQUE A BATERÍA | 112 | SILENBLOCK | 135 |
| MUELLE TUBO COMBUSTIBLE | 75 | MUELLE DE ARRANQUE | 112 | SISTEMA DE REFRIGERACIÓN | 136 |
| BOMBA DE COMBUSTIBLE | 85 | PLATO Y PLACA DE ARRANQUE MANUAL | 113 | ÁNODOS | 158 |
| BOMBA DE COMBUSTIBLE ELÉCTRICA | 86 | TIRADOR DE ARRANQUE | 113 | ÁNODO CANADA METAL | 158 |
| BOMBA DE COMBUSTIBLE MECÁNICA | 85 | TRINQUETE TRACCIÓN PLATO | 112 | ÁNODO TECNOSAL | 163 |
| JUNTAS VST | 88 | REGULADORES Y RECTIFICADORES | 116 | GUÍA DE ÁNODOS | 169 |
| MEMBRANAS Y JUNTAS | 87 | SENSORES | 102 | KITS DE ÁNODOS CANADA METAL | 162 |
| REGULADORES DE PRESIÓN COMBUSTIBLE | 89 | SENSOR ACCELERACIÓN TS | 103 | KITS DE ÁNODOS TECNOSAL | 168 |
| BOMBA DE INYECCIÓN DE ACEITE | 84 | SENSOR DE OXÍGENO | 103 | TAPA DE ÁNODO (66M) | 168 |
| CARBURADOR | 91 | SENSOR MAP | 102 | BOMBA DE AGUA | 147 |
| AGUJA CARBURADOR | 98 | SENSOR PRESIÓN DE ACEITE | 103 | CUERPO BOMBA DE AGUA | 147 |
| BOYAS | 100 | SENSOR IAC | 102 | GUÍA BOMBAS DE AGUA 4T | 154 |
| CARBURADOR COMPLETO | 91 | SENSOR TEMPERATURA DEL AGUA | 103 | GUÍA BOMBAS DE AGUA 2T | 155 |
| CONECTOR DE CARBURADOR | 100 | SENSOR TPS | 102 | GUÍA KITS DE BOMBA DE AGUA | 153 |
| ELEMENTO FILTRO DEL CARBURADOR | 101 | SOLENOIDE RELÉ | 114 | KITS DE REPARACIÓN BOMBA DE AGUA | 150 |
| GUÍA CARBURADORES | 93 | STARTOR | 121 | TAPA DE LA BOMBA | 148 |
| JUNTAS CARBURADORES | 94 | TRIM, TILT & POWER TRIM | 122 | GUÍA DE IMPULSORES | 143 |
| KITS CARBURADORES | 95 | EXTRACTOR TAPONES DE TRIM | 125 | KITS DE JUNTAS | 144 |
| KIT 3 CARBURADORES | 92 | DESPIECE PISTÓN TRIM | 125 | LÍQUIDO INHIBIDOR DE LA CORROSIÓN | 136 |
| PASADOR DE BOYA | 99 | INSTALACIÓN ELÉCTRICA | 122 | TERMOSTATO | 136 |
| TORNILLOS CARBURADOR | 98 | INTERRUPTOR POWER TRIM | 122 | CUBIERTAS TERMOSTATO | 139 |
| VÁLVULA DE LÁMINAS | 99 | POWER TRIM COMPLETO | 124 | GUÍA TERMOSTATO | 137 |
| COMPONENTES TANQUE Y CONECTORES | 75 | TRIM COMPLETO BIDIRECCIONAL | 122 | JUNTAS TAPA DE REFRIGERACIÓN | 140 |
| CONECTOR DE DEPÓSITO | 76 | VOLANTE DE MOTOR | 109 | JUNTAS TERMOSTATO | 138 |
| FILTRO | 76 | ELÉCTRICO | 109 | NIPLE | 139 |
| LLAVE DE CIERRE DE DEPÓSITO | 76 | SIN DIENTES (MANUAL) | 109 | RESORTE | 139 |
| MEDIDOR DE COMBUSTIBLE | 76 | SISTEMA DE GOBIERNO | 126 | TERMOSTATO | 136 |
| PASAMAMPAROS | 77 | ARNÉS | 128 | VÁLVULA ANTIPRESIÓN DE TERMOSTATO | 139 |
| RESORTE DE SEGURIDAD PARA TAPÓN | 75 | ARNÉS COMPLETO (703) | 128 | PARTES DEL MOTOR | 170 |
| TAPÓN CON RESPIRADERO | 75 | EXTENSIÓN DE ARNÉS (703/704) | 128 | CIGÜEÑAL 4 TIEMPOS | 219 |
| TAPÓN | 75 | BRACKET | 131 | GUÍA CIGÜEÑAL COMPLETO | 219 |
| FILTRO DE ACEITE | 83 | BRACKET BABOR | 131 | CIGÜEÑAL 2 TIEMPOS | 256 |
| GUÍA FILTROS DE ACEITE | 83 | BRACKET ESTRIBOR | 131 | GUÍA BIELAS | 260 |
| FILTRO DE COMBUSTIBLE Y ELEMENTOS | 77 | CIRCLIP | 132 | GUÍA CIGÜEÑAL COMPLETO | 256 |
| BRACKET | 77 | CONECTOR | 133 | GUÍA PARTES DE CIGÜEÑAL | 256 |
| FILTRO DECANTADOR DE COMBUSTIBLE COMPLETO CON VASO TRASPARENTE | 78 | EJE CONECTOR ACELERADOR | 132 | GUÍA RODAMIENTOS DE MOTOR | 257 |
| FILTRO COMBUSTIBLE MONTAJE EN LÍNEA | 80 | ENGRASADOR INOX 316 M6 | 133 | DESPIECE MOTOR DE 4 TIEMPOS | 170 |
| FILTRO COMBUSTIBLE SEPARADOR AGUA | 77 | SOPORTE BARRA DE DIRECCIÓN | 132 | F2.5 | 170 |
| GUÍA FILTROS DE COMBUSTIBLE | 81 | SOPORTE GIRATORIO | 131 | F4 | 174 |
| GUÍA FILTROS VST | 82 | SOPORTE INFERIOR | 132 | F5 • F6 | 178 |
| FILTRO VST | 82 | RETÉN INFERIOR DEL BRACKET | 132 | F8 | 181 |
| LLAVES PARA FILTRO | 79 | VARILLA DE BASCULACIÓN | 132 | F9.9 | 180 |
| RACOR DE LATÓN | 79 | BUJES | 133 | F13.5 • F15 | 182 |
| INYECTORES | 89 | COLLAR | 134 | F20 • F25 | 190 |
| GUÍA INYECTORES Y SENSORES | 90 | COMPONENTES 703 | 129 | F30 • F40 | 196 |
| INYECTOR | 89 | CABLE DE ACELERADOR | 130 | F50 • F60 | 202 |
| SISTEMA ELÉCTRICO | 102 | CABLES DE CONTROL | 130 | F70 | 204 |
| BOBINAS | 104 | ESPACIADOR | 129 | F80 • F100 • F115 | 208 |
| BOBINA DE CARGA | 106 | MANETA ACELERADOR | 131 | F150 | 210 |
| BOBINA DE IGNICIÓN | 104 | PALANCA ACELERADOR | 129 | F200 • F225 • F250 | 212 |
| BOBINA DE LUZ | 104 | PLACA CERRADURA SELECTOR | 129 | F300 • F350 | 214 |
| BOBINA DE PULSACIÓN | 107 | RUEDA ACCELERACIÓN | 129 | DESPIECE MOTOR DE 2 TIEMPOS | 220 |
| BOBINA DE T.C.I. | 106 | VARILLA DE ENLACE | 131 | 2 | 220 |
| BUJÍAS | 108 | EJE DE CAMBIO | 134 | 4 • 5 | 221 |
| | | INTERRUPTORES PARA MANDOS | 127 | 6 • 8 | 222 |
| | | INTERRUPTOR PANEL COMPLETO O DOBLE ESTACIÓN | 128 | 9.9 • 13.5 • 15 | 226 |

YAMAHA

RECAMBIOS MARINOS

| | |
|---|------------|
| 25 • 30 | 228 |
| 40 | 232 |
| 48 • 55 | 238 |
| 50 • 60 • 70 | 240 |
| 75 • 85 | 242 |
| 100 • 115 • 130 • 140 | 244 |
| 150 • 175 • 200 • 225 | 246 |
| GUÍA CORREAS DE DISTRIBUCIÓN | 267 |
| JUNTAS DE MOTOR 4 TIEMPOS | 215 |
| JUNTAS BASE DE MOTOR | 217 |
| JUNTAS DE CULATA | 215 |
| KIT JUNTAS DE CULATA | 216 |
| GUÍA JUNTAS DE MOTOR | 218 |
| JUNTAS DE MOTOR 2 TIEMPOS | 248 |
| JUNTAS BASE DE MOTOR | 252 |
| JUNTAS DE CULATA | 248 |
| JUNTAS DE CULATÍN | 255 |
| GUÍA JUNTAS DE MOTOR | 254 |
| KITS JUNTAS DE CULATA | 249 |
| PISTONES 4 TIEMPOS | 219 |
| KITS DE PISTONES | 219 |
| PISTONES 2 TIEMPOS | 262 |
| GUÍA DE PISTONES Y SEGMENTOS | 266 |
| KIT DE PISTONES | 262 |
| SISTEMA DE ESCAPE Y ADMISIÓN | 268 |
| SISTEMA DE ADMISIÓN | 273 |
| JUNTAS DEL SISTEMA DE ADMISIÓN | 273 |
| SISTEMA DE ESCAPE | 268 |
| JUNTAS DE COLECTOR Y CARTER | 270 |
| JUNTAS DE SISTEMA DE ESCAPE | 268 |
| UNIDADES DE TRANSMISIÓN | 277 |
| COLA COMPLETA | 277 |
| COLAS DE 4 TIEMPOS | 277 |
| COLAS DE 2 TIEMPOS | 279 |
| DESPIECE COLAS 4 TIEMPOS | 282 |
| F2.5 | 282 |
| F4 | 284 |
| F5 | 286 |
| F6 • F8 • F9.9 | 288 |
| F13.5 • F15 | 290 |
| F20 • F25 | 292 |
| F30 • F40 | 298 |
| F50 • F60 | 306 |
| F70 | 314 |
| F80 • F100 | 318 |
| F115 • F130 | 322 |
| F150 • F175 • F200 | 326 |
| F225 | 330 |
| F250 • F300 | 334 |
| F350 | 340 |
| DESPIECE COLAS 2 TIEMPOS | 342 |
| 2 | 342 |
| 4 • 5 | 344 |
| 6 • 8 | 346 |
| 9.9 | 348 |
| 13.5 • 15 | 350 |
| 20 • 25 • 30 | 352 |
| 40 • 50 | 358 |
| 55 | 368 |
| 75 • 85 | 370 |
| 80 • 90 | 372 |
| 115 • 130 | 374 |
| V6 | 378 |
| 225 • 250 | 382 |
| VZ200 • VZ205 • VZ250 • VZ300 | 386 |
| GUÍA PIEZAS COLA | 387 |
| GUÍA RODAMIENTOS | 393 |
| SISTEMA DE PROPULSIÓN | 401 |
| HÉLICES ALUMINIO E INOXIDABLE DE 3 Y 4 PALAS | 401 |
| GUÍA HÉLICES CON NÚCLEO INTEGRADO | 402 |
| GUÍA DE RECAMBIOS DE HÉLICE | 405 |
| HÉLICES PARA NÚCLEO INTERCAMBIABLE | 404 |
| NÚCLEO INTERCAMBIABLE | 405 |
| REF --> RO | 406 |
| RO --> REF | 420 |

EN

| | | | |
|--|------------|-------------------------------------|------------|
| DRIVES MAINTENANCE GUIDE & KITS | 64 | FLYWHELL | 109 |
| FUEL & FILTRATION SYSTEM | 74 | ELECTRIC | 109 |
| ACCELERATOR | 101 | WITHOUT TOOTH | 109 |
| VARILLA DE ACELERADOR | 101 | IGNITION STARTER SWITCH | 113 |
| CARBURATOR | 91 | CONTROL BOX | 113 |
| ACCELEROGRAPH CONTROL | 100 | DASH MOUNT | 113 |
| BOLT SCREW | 98 | DUAL ENGINE APPLICATION | 113 |
| CARBURETOR GASKES | 94 | KEY FOR STERN CONTROL | 114 |
| CARBURETOR KITS | 95 | PUSH T. CHOKE | 114 |
| ELEMENT FILTER (CARB INLET) | 101 | REGULATOR AND RECTIFIERS | 116 |
| FLOATS | 100 | SENSORS | 102 |
| FULL CARBURATOR | 91 | IAC SENSOR | 102 |
| GUIDE CARBURETORS | 93 | MAP SENSOR | 102 |
| KIT 3 CARBURETORS | 92 | OXYGEN SENSOR | 103 |
| NEEDLE VALVE | 98 | TPS SENDER | 102 |
| PIN FLOAT | 99 | SENSOR | 103 |
| VALVE OF SHEETS | 99 | SENSOR, OIL PRESSURE | 103 |
| FUEL FILTERS AND ELEMENTS | 77 | SENSOR, WATER TEMPERATURE | 103 |
| BRACKET | 77 | SOLENOID RELAY | 114 |
| COMPLET FUEL FILTER, TRANSPARENT BOWL | 78 | STARTERS | 110 |
| FUEL FILTER GUIDE | 82 | CONNECTION LINE, POWER | 112 |
| FUEL FILTER GUIDE VST | 81 | PAWL, DRIVE | 112 |
| FILTER KEY | 79 | PLATE & DRUM, DRIVE | 113 |
| IN-LINE FUEL FILTER | 80 | STARTER HANDLE ASSY | 113 |
| RACOR MADE IN BRASS | 79 | STEERING SPRING | 112 |
| VST FILTER | 82 | STARTOR | 121 |
| WATER SEPARATING FUEL FILTER | 77 | TRIM, TILT & POWER TRIM | 122 |
| FUEL PUMP | 85 | COMPLETE POWER TRIM ASSEMBLY | 124 |
| DIAPHRAGMS & GASKETS | 87 | COMPLETE TRIM ASSEMBLY | 122 |
| FUEL PUMP ELECTRIC | 86 | PARTI PISTONE TRIM | 125 |
| FUEL PUMP MECHANICAL | 85 | POWER TRIM SWITCH | 122 |
| FUEL REGULATOR | 89 | TRIM PLUGS EXTRACTOR | 125 |
| VST GASKETS | 88 | WIRING HARNESS | 122 |
| FUEL PUMP IN LINE | 74 | STEERING SYSTEM | 126 |
| CLAMP SMALL | 75 | ARNES | 129 |
| COUPLER | 75 | ARNES ASSY (703) | 129 |
| FUEL HOSE | 74 | ARNES EXTENSION (703/704) | 129 |
| FUEL LINE ASSEMBLY | 74 | BRACKET | 131 |
| FUEL PUMP | 74 | BOLT, CLAMP BRACKET | 132 |
| SPRING, FUEL PIPE | 75 | BRACKET OIL SEAL | 132 |
| FUEL TANK COMPONENTS & CONNECTORS | 75 | BRACKET ROTARY | 131 |
| FILTER | 76 | CIRCLIP | 132 |
| KNOB OIL SWITCH | 76 | CONNECTOR | 133 |
| OLEOMETER ASSY | 76 | LEFT BRACKET ASSY | 131 |
| PLUG | 75 | OILER M6 | 133 |
| PLUG WITH BREATHER | 75 | RIGHT BRACKET ASSY | 131 |
| TANK CONNECTOR | 76 | SHELL, MOUNT DAMPER | 132 |
| THRU HULL | 77 | THROTTLE SHAFT CONNECTOR | 132 |
| SPRING, PREVENT DESQUAMATING | 75 | TILT ROD | 132 |
| INJEKTOR | 89 | BUSHINGS | 133 |
| GUIDE INJECTORS & SENDERS | 90 | COMPONENTS 703 | 129 |
| INJEKTOR | 89 | BLOCK CONTROL HANDLE | 129 |
| OIL | 84 | CONTROL CABLES | 130 |
| OIL FILTER | 83 | LEVER THROTTLE | 131 |
| OIL FILTER GUIDE | 83 | LINK ROD ASSY | 131 |
| OIL INJECTION PUMP | 84 | PLATE CONTROL BOX | 129 |
| ELECTRIC SYSTEM | 102 | THROTTLE CABLE | 130 |
| CDI & POWER PACK | 117 | THROTTLE HANDLE INCHING | 129 |
| COILS | 104 | ENGINE CONTROLS | 126 |
| COIL LIGHTING | 104 | CABLE CONNECTOR | 127 |
| CHARGE COIL | 106 | CONSOLE CONTROL | 127 |
| IGNITION COIL | 104 | SIDE CONTROL PUSH TO OPEN | 126 |
| PULSER COIL | 107 | SIDE CONTROL | 127 |
| SPARK | 108 | HANDLE GEAR SHIFT ASSY | 134 |
| T.C.I. COIL | 106 | SILENBLOCK | 135 |
| CUT OFF SWITCHES | 120 | STARTER HANDLE & FIXINGS | 134 |
| KIT | 121 | STEERING HANDLE ASSY | 134 |
| | | SWITCHES FOR ENGINE CONTROLS | 127 |
| | | BUZZER (703) | 128 |

| | |
|-------------------------|-----|
| PANEL TWIN STATION | 128 |
| POWER TRIM SWITCH (703) | 127 |
| SWITCH (704) | 128 |
| WASHER, BELOW | 134 |

COOLING SYSTEM 136

| | |
|-------------------------------|-----|
| ANODES | 158 |
| ANODES APPLICATION | 169 |
| ANODES CANADA METAL | 158 |
| ANODES KIT CANADA METAL | 162 |
| ANODES KIT TECNOSEAL | 168 |
| ANODES TECNOSEAL | 163 |
| COVER ANODE (66M) | 168 |
| GASKETS KIT | 144 |
| IMPELLER GUIDE | 143 |
| SALT OFF | 136 |
| THERMOSTAT | 136 |
| GASKET, EXHAUST INNER COVER | 140 |
| NIPPLE | 139 |
| SPRING | 139 |
| THERMOSTAT | 136 |
| THERMOSTAT COVER | 139 |
| THERMOSTAT GASKETS | 138 |
| THERMOSTAT GUIDE | 137 |
| THERMOSTAT, PRESSURE VALVE | 139 |
| WATER PUMP | 147 |
| GUIDE WATER PUMP 4 STROKES | 154 |
| GUIDE WATER PUMP 2 STROKES | 155 |
| GUIDE WATER PUMP SERVICE KITS | 153 |
| HOUSING, WATER PUMP | 147 |
| WATER PUMP, COVER | 148 |
| WATER PUMP SERVICE KITS | 150 |

ENGINE PARTS 170

| | |
|--------------------------------|-----|
| CRANKSHAFT 4 STROKES | 219 |
| GUIDE CRANKSHAFT ASSY | 219 |
| CRANKSHAFT 2 STROKES | 256 |
| GUIDE CONNECTING ROD | 260 |
| GUIDE CRANKSHAFT ASSY | 256 |
| GUIDE CRANKSHAFT PARTS | 256 |
| GUIDE ENGINE BEARING | 257 |
| ENGINE GASKET 4 STROKES | 215 |
| ENGINE GASKET GUIDE | 218 |
| CYLINDER GASKET | 217 |
| CYLINDER HEAD GASKET | 215 |
| CYLINDER HEAD GASKET KIT | 216 |
| ENGINE GASKET 2 STROKES | 248 |
| ENGINE GASKET GUIDE | 254 |
| CYLINDER GASKET | 252 |
| CYLINDER HEAD GASKET | 248 |
| CYLINDER HEAD GASKET KIT | 249 |
| GASKET, HEAD COVER | 255 |
| ENGINE PARTS 4 STROKES | 170 |
| F2.5 | 170 |
| F4 | 174 |
| F5 • F6 | 178 |
| F8 | 181 |
| F9.9 | 180 |
| F13.5 • F15 | 182 |
| F20 • F25 | 190 |
| F30 • F40 | 196 |
| F50 • F60 | 202 |
| F70 | 204 |
| F80 • F100 • F115 | 208 |
| F150 | 210 |
| F200 • F225 • F250 | 212 |
| F300 • F350 | 214 |
| ENGINE PARTS 2 STROKES | 220 |
| 2 | 220 |
| 4 • 5 | 221 |

| | |
|--------------------------|-----|
| 6 • 8 | 222 |
| 9.9 • 13.5 • 15 | 226 |
| 25 • 30 | 228 |
| 40 | 232 |
| 48 • 55 | 238 |
| 50 • 60 • 70 | 240 |
| 75 • 85 | 242 |
| 100 • 115 • 130 • 140 | 244 |
| 150 • 175 • 200 • 225 | 246 |
| GUIDE TIMING BELT | 267 |
| PISTONS 4 STROKES | 219 |
| PISTON KITS | 219 |
| PISTON 2 STROKES | 262 |
| GUIDE PISTON & RING | 266 |
| PISTON KITS | 262 |

EXHAUST & INTAKE SYSTEM 268

| | |
|--|-----|
| EXHAUST SYSTEM | 268 |
| EXHAUST GASKETS | 268 |
| GASKET, UPPERCASING, OIL PAN, MANIFOLD | 270 |
| INTAKE SYSTEM | 273 |
| GASKETS INTAKE | 273 |

UNIT DRIVES & COMPONENTS 277

| | |
|--|-----|
| COMPLETE GEARCASE ASSY | 277 |
| 4 STROKES GEARCASE | 277 |
| 2 STROKES GEARCASE | 279 |
| GEAR CASE PARTS 4 STROKES | 282 |
| F2.5 | 282 |
| F4 | 284 |
| F5 | 286 |
| F6 • F8 • F9.9 | 288 |
| F13.5 • F15 | 290 |
| F20 • F25 | 292 |
| F30 • F40 | 298 |
| F50 • F60 | 306 |
| F70 | 314 |
| F80 • F100 | 318 |
| F115 • F130 | 322 |
| F150 • F175 • F200 | 326 |
| F225 | 330 |
| F250 • F300 | 334 |
| F350 | 340 |
| GEARCASE PARTS 2 STROKES | 342 |
| 2 | 342 |
| 4 • 5 | 344 |
| 6 • 8 | 346 |
| 9.9 | 348 |
| 13.5 • 15 | 350 |
| 20 • 25 • 30 | 352 |
| 40 • 50 | 358 |
| 55 | 368 |
| 75 • 85 | 370 |
| 80 • 90 | 372 |
| 115 • 130 | 374 |
| V6 | 378 |
| 225 • 250 | 382 |
| VZ200 • VZ205 • VZ250 • VZ300 | 386 |
| STERN DRIVE BEARING APPLICATION | 393 |
| STERN DRIVE COMPONENTS GUIDE | 387 |

PROPULSION SYSTEM 401

| | |
|--|-----|
| 3 & 4 BLADE ALUMINIUM & SS PROPELLERS | 401 |
| INTERCHANGEABLE HUB | 405 |
| PROPELLERS APPLICATION WITH RUBBER HUB | 402 |
| PROPELLERS FOR INTERCHANGEABLE HUB | 404 |
| PROPELLER SPARE PARTS | 405 |
| REF --> OEM | 406 |
| OEM --> REF | 420 |

IT

GUIDA MANUTENZIONE E KIT 64

SISTEMA DI ALIMENTAZIONE E FILTRAZIONE 74

| | |
|---|-----|
| ACCELERATORE | 101 |
| ASTA ACCELERATORE | 101 |
| CARBURATORE | 91 |
| CARBURATORE COMPLETO | 91 |
| CONTROLLO DELL'ACCELEROGRAFO | 100 |
| FILTRO CARBURATORE | 101 |
| GALLEGGIANTE | 100 |
| GUARNIZIONI CARBURATORI | 94 |
| GUIDA CARBURATORI | 93 |
| KIT CARBURATORI | 95 |
| KIT 3 CARBURATORI | 92 |
| SPILLO CONICO CARBURATORE | 98 |
| SPINOTTO GALLEGGIANTE | 99 |
| VALVOLA | 99 |
| VITE CARBURATORE | 98 |
| COMPONENTI SERBATOIO E CONETTORI | 75 |
| ATTACCO SERBATOIO | 76 |
| CHIAVE DE DEPOSITO BLOCCO | 76 |
| FILTRO | 76 |
| MISURATORE DI CARBURANTE | 76 |
| MOLLA SICURITÀ PER TAPPO | 75 |
| PASSASCAFO | 77 |
| SPINA CON RESPIRO | 75 |
| TAPPO | 75 |
| FILTRI BENZINA E RACCORDI | 77 |
| CHIAVE DA FILTRO | 79 |
| FILTRO BENZINA PER MONTARE IN LINEA | 80 |
| FILTRO DI DECANTAZIONE BENZINA COMPLETO CON VASCHETTA TRASPARENTE | 78 |
| FILTRO SEPARATORE ACQUA-BENZINA | 77 |
| FILTRO VST | 82 |
| GUIDA FILTRO BENZINA | 81 |
| GUIDA FILTRO BENZINA VST | 82 |
| RACCORDO IN OTTONE | 79 |
| SUPPORTO | 77 |
| FILTRO OLIO | 83 |
| GUIDA FILTRO OLIO | 83 |
| INIETTORE | 89 |
| GUIDA INIETTORI E SENSORI | 90 |
| INIETTORE | 89 |
| OLIO | 84 |
| POMPA BENZINA IN LINEA | 74 |
| ADATTATORE | 75 |
| FASCETTE | 75 |
| MOLLA TUBO COMBUSTIBILE | 75 |
| POMPA BENZINA | 74 |
| TUBO BENZINA | 74 |
| TUBO CARBURANTE | 74 |
| POMPA BENZINA | 85 |
| GUARNIZIONE VST | 88 |
| MEMBRANA E GUARNIZIONI | 87 |
| POMPA BENZINA ELETTRICA | 86 |
| POMPA BENZINA MECCANICA | 85 |
| REGOLATORE BENZINA | 89 |
| POMPA INIEZIONE BENZINA | 84 |
| SISTEMA ELETTRICO | 102 |
| BOBINE | 104 |
| BOBINE ACCENSIONE | 107 |
| BOBINA AVVIAMENTO | 104 |
| BOBINA DI CARICA | 106 |
| BOBINA LUCE | 104 |
| BOBINE T.C.I. | 106 |
| CANDELE | 108 |
| CDI E CENTRALINA | 117 |
| CHIAVETTA DI SICUREZZA | 120 |
| KIT | 121 |
| CHIAVI DI ACCENSIONE | 113 |
| CHIAVE CON CONTATTO | 114 |
| CHIAVE DOPPIA INSTALLAZIONE | 113 |
| CHIAVE PER COMANDO A GUIDA | 114 |
| MONTAGGIO NEL PANNELLO | 113 |
| MONTAGGIO NEL TELECOMANDO | 113 |
| MOTORINI AVVIAMENTO | 110 |
| CAVO MOTORE DI AVVIAMENTO A BATTERIA | 112 |
| CRICCHETTO TRAZIONE PLATTO | 112 |
| MANIGLIA AVVIAMENTO | 113 |
| MOLLA AVVIAMENTO | 112 |
| PLACCA E PLATTO DI AVVIAMENTO MANUALE | 113 |
| REGOLATORI E RADDRIZZATORI | 116 |

| | | | | | |
|--|-----|--|-----|---|-----|
| FILTRE À ESSENCE ET CARTOUCHE DE RECHANGE | 77 | CIRCLIP | 132 | F70 | 204 |
| CLÉ À FILTRE | 79 | ETRIER DROIT | 131 | F80 • F100 • F115 | 208 |
| FILTRE À ESSENCE | 77 | ETRIER GAUCHE | 131 | F150 | 210 |
| FILTRE À ESSENCE EN LIGNE | 80 | CONNECTEUR | 133 | F200 • F225 • F250 | 212 |
| FILTRE SÉPARATEUR D'ESSENCE | 78 | GRAISSEUR M6 INOX 316 | 133 | F300 • F350 | 214 |
| FILTRE VST | 82 | JOINT INFÉRIEUR DU SUPPORT | 132 | PIECES MOTEUR 2 TEMPS | 220 |
| GUIDE FILTRE À ESSENCE | 81 | SUPPORT SILENT BLOCK | 132 | 2 | 220 |
| GUIDE FILTRES VST | 82 | SUPPORT TOURNANT | 131 | 4 • 5 | 221 |
| RACCORD EN LAITON | 79 | TUBE SUPPORT CABLE DE DIRECTION | 132 | 6 • 8 | 222 |
| TÊTE DE FILTRE À ESSENCE | 77 | TIGE DE CONNEXION ACCELERATEUR | 132 | 9.9 • 13.5 • 15 | 226 |
| FILTRE À HUILE | 83 | CALLE | 134 | 25 • 30 | 228 |
| GUIDE FILTRE A HUILE | 83 | COMMANDE D'INVERSION | 134 | 40 | 232 |
| HUILES | 84 | COMPOSANT (703) | 129 | 48 • 55 | 238 |
| INJECTEURS | 89 | BARRE D'ACCOUPLÉMENT COMPLETE | 131 | 50 • 60 • 70 | 240 |
| GUIDE INJECTEURS ET SONDÉS | 90 | CÂBLE D'ACCELERATEUR | 130 | 75 • 85 | 242 |
| INJECTEUR | 89 | CÂBLES DE COMMANDE | 130 | 100 • 115 • 130 • 140 | 244 |
| POIRE À CARBURANT | 74 | CALE POIGNEE DE CONTRÔLE | 129 | 150 • 175 • 200 • 225 | 246 |
| COLLIER | 75 | LEVIER DE COMMANDE | 129 | PISTONS DE 2 TEMPS | 262 |
| POIRE À CARBURANT | 74 | PLAQUE BOITIER DE COMMANDE | 129 | KIT DE PISTONS | 262 |
| RACCORD COUPLEUR | 75 | POIGNEE DE PAPILLON | 131 | GUIDE PISTONS ET SEGMENTS | 266 |
| RESSORT, TUYAU DE CARBURANT | 75 | ROUE D'ACCELERATEUR | 129 | PISTONS DE 4 TEMPS | 219 |
| TUYAU CARBURANT | 74 | FAISCEAU ELECTRIQUE | 128 | KIT PISTON | 219 |
| POMPE À ESSENCE | 85 | FAISCEAU ELECTRIQUE BOITIER CDE (703) | 128 | VILEBREQUIN DE 4 TEMPS | 219 |
| POMPE À ESSENCE ELECTRIQUE | 86 | RALLONGE FAISCEAU (703/704) | 128 | GUIDE VILEBREQUIN COMPLET | 219 |
| POMPE À ESSENCE MECANIQUE | 85 | INTERRUPTEUR DE CONTRÔLE | 127 | VILEBREQUIN DE 2 TEMPS | 256 |
| JOINTS VST | 88 | AVERTISSEUR SONORE (703) | 128 | GUIDE DE BIELLES | 260 |
| MEMBRANES ET JOINTS | 87 | BOITIER DE DEMARRAGE 2 MOTEURS | 128 | GUIDE PARTS DE VILEBREQUIN | 256 |
| REGULATEUR DE PRESSION D'ESSENCE | 89 | COMMUTATEUR DE TRIM (703) | 127 | GUIDE ROULEMENTS DE MOTEUR | 257 |
| POMPE D'INJECTION D'HUILE | 84 | TABLEAU DE COMMANDE SIMPLE (704) | 128 | GUIDE VILEBREQUIN COMPLET | 256 |
| SYSTÈME ÉLECTRIQUE | 102 | POIGNEE DE DIRECTION | 134 | SYSTÈME D'ÉCHAPPEMENT ET SYSTÈME D'ADMISSION | 268 |
| BOBINES | 104 | POIGNEE LANCEUR ET DE SERRAGE | 134 | SYSTÈME D'ADMISSION | 273 |
| BOBINE D'ALLUMAGE | 104 | SILENT BLOC | 135 | JOINTS D'ADMISSION | 273 |
| BOBINE D'ÉCLAIRAGE | 104 | SYSTÈME DE REFROIDISSEMENT | 136 | SYSTÈME D'ÉCHAPPEMENT | 268 |
| BOBINE DE CHARGE | 106 | ANODES | 158 | JOINTS D'ÉCHAPPEMENT | 268 |
| BOBINE PULSEUR | 107 | ANODE CANADA METAL | 158 | JOINTS DE COLLECTEUR ET CARTER D'HUILE | 270 |
| BOBINE T.C.I. | 106 | ANODE TECNOSEAL | 163 | EMBASES ET PIECES | 277 |
| BOUGIES | 108 | COUVERCLE DU ANODE (66M) | 168 | EMBASE COMPLETE | 277 |
| CDI ET BOITIER ELECTRONIQUE | 117 | GUIDE DES ANODES | 169 | EMBASES DE MOTEUR 4T | 277 |
| CONTACTEUR A CLÉ | 113 | KIT ANODES CANADA METAL | 162 | EMBASES DE MOTEUR 2T | 279 |
| AVEC STARTER | 114 | KIT ANODES TECNOSEAL | 168 | PIECES D'EMBASES DE 4 TEMPS | 282 |
| CONTACTEUR A CLÉ COMPLET | 114 | GUIDE TURBINES | 143 | F2.5 | 282 |
| MONTAGE POUR BOITIER DE COMMANDE | 113 | KITS JOINTS | 144 | F4 | 284 |
| MONTAGE POUR TABLEAU DE BORD | 113 | POMPE D'EAU | 147 | F5 | 286 |
| POUR INSTALLATION DOUBLE | 113 | CORPS DE POMPE À EAU | 147 | F6 • F8 • F9.9 | 288 |
| CAPTEURS | 102 | GUIDE KITS POMPES À EAU | 153 | F13.5 • F15 | 290 |
| CAPTEUR D'ACCELERATEUR TS | 103 | GUIDE POMPE À EAU 4T | 154 | F20 • F25 | 292 |
| CAPTEUR DE TEMPERATURE | 103 | GUIDE POMPE À EAU 2T | 155 | F30 • F40 | 298 |
| CAPTEUR MAP | 102 | KIT REPARATION DE POMPE À EAU | 150 | F50 • F60 | 306 |
| CAPTEUR TPS | 102 | PLAQUE DE POMPE À EAU | 148 | F70 | 314 |
| SONDE À OXYGENE | 103 | THERMOSTAT | 136 | F80 • F100 | 318 |
| SONDE DE PRESSION D'HUILE | 103 | COUVERCLE DE THERMOSTAT | 139 | F115 • F130 | 322 |
| SONDE IAC | 102 | GUIDE DES THERMOSTATS | 137 | F150 • F175 • F200 | 326 |
| COUPE CIRCUIT DE SECURITE | 120 | JOINT DE PLAQUE DE REFROIDISSEMENT | 140 | F225 | 330 |
| KITS | 121 | JOINTS DE THERMOSTAT | 138 | F250 • F300 | 334 |
| DEMARREUR | 110 | RESSORT | 139 | F350 | 340 |
| CABLE DE CONNEXION | 112 | SOUPAPE DE PRESSION DE THERMOSTAT | 139 | PIECES D'EMBASES DE 2 TEMPS | 342 |
| ENTRAÎNEMENT | 112 | TETINE | 139 | 2 | 342 |
| POIGNEE DE LANCEUR | 113 | THERMOSTAT | 136 | 4 • 5 | 344 |
| RESSORT DE LANCEUR | 112 | SALT OFF | 136 | 6 • 8 | 346 |
| TAMBOUR, POULIE | 113 | PIECES MOTEUR | 170 | 9.9 | 348 |
| REGULATEURS ET RECTIFIEURS | 116 | GUIDE DES COURROIES DE DISTRIBUTION | 267 | 13.5 • 15 | 350 |
| SOLENOIDE RELAIS | 114 | JOINTS DE MOTEUR 4 TEMPS | 215 | 20 • 25 • 30 | 352 |
| STARTOR | 121 | GUIDE JOINTS DE MOTEURS | 218 | 40 • 50 | 358 |
| TRIM, TILT & POWER TRIM | 122 | JOINTS DE CULASSE | 215 | 55 | 368 |
| INTERRUPTEUR DE TRIM | 122 | JOINTS DE TÊTE MOTRICE | 217 | 75 • 85 | 370 |
| INSTALLATION ELECTRIQUE | 122 | KIT JOINTS DE CULASSE | 216 | 80 • 90 | 372 |
| KIT EXTRACTEUR | 125 | JOINTS DE MOTEUR 2 TEMPS | 248 | 115 • 130 | 374 |
| MOTEUR DE TRIM | 122 | GUIDE JOINTS DE MOTEURS | 254 | V6 | 378 |
| PIECES VERIN DE TRIM | 125 | JOINT DE CULASSE | 248 | 225 • 250 | 382 |
| POWER TRIM COMPLET | 124 | JOINTS DE COUVRE CULASSE | 255 | VZ200 • VZ205 • VZ250 • VZ300 | 386 |
| VOLANT MOTEUR | 109 | JOINTS DE TÊTE MOTRICE | 252 | GUIDE PIECES D'EMBASE | 387 |
| ÉLECTRIQUE | 109 | KITS JOINT DE CULASSE | 249 | GUIDE ROULEMENTS D'EMBASE | 393 |
| MANUEL SANS DENT | 109 | PIECES MOTEURS DE 4 TEMPS | 170 | SYSTÈME DE PROPULSION | 401 |
| SYSTÈME DE DIRECTION | 126 | F2.5 | 170 | HELICE ALUMINIUM ET INOX 3 ET 4 PALES | 401 |
| BAGUES | 133 | F4 | 174 | GUIDE DES HELICES ET MOYEUX | 402 |
| BOITIER DE COMMANDE | 126 | F5 • F6 | 178 | GUIDE DES PIECES POUR HELICE | 405 |
| BOITIER LATERAL PUSH TO OPEN | 126 | F8 | 181 | HELICES AVEC MOYEU INTERCHANGEABLE | 404 |
| BOITIER LATERAL | 127 | F9.9 | 180 | MOYEU INTERCHANGEABLE | 405 |
| BOITIER POUR CONSOLE | 127 | F13.5 • F15 | 182 | REF --> RO | 406 |
| EMBOUT DE CABLE | 127 | F20 • F25 | 190 | RO --> REF | 420 |
| BRACKET | 131 | F30 • F40 | 196 | | |
| BARRE DE TILT | 132 | F50 • F60 | 202 | | |





GUÍA KITS
MANTENIMIENTO



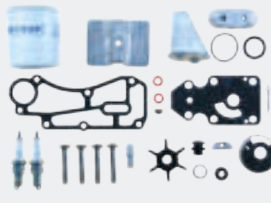

MAINTENANCE
GUIDE & KITS





GUIDA
MANUTENZIONE
E KIT





GUIDE
MAINTENANCE
KITS

| | KIT | REF | | | | | | | |
|------------------|--------------------------------|-------------------|--------------------------------|-----------------------|-------------------------|----------------------------|-------------|--------|-----|
| | RECKITF2.5A | NGKBR6HS | BUJÍA | SPARK PLUG | CANDELE | BOUGIE | 1 | | |
| | | PAF4-04070003 | ÁNODO | ANODE | ANODO | ANODE | 1 | | |
| | | PAF4-04000011 | JUNTA | GASKET | GUARNIZIONE | JOINT | 1 | | |
| | | PAF4-04000006 | JUNTA | GASKET | GUARNIZIONE | JOINT | 1 | | |
| | | PAF4-04120005 | FILTRO COMBUSTIBLE | FUEL FILTER | FILTRO COMBUSTIBILE | FILTRE ESSENCE | 1 | | |
| | | REC90430-08020 | JUNTA DESAGÜE | DRAIN GASKET | GUARNIZIONE DRENAGGIO | JOINT DE VIDANGE | x 2 | | |
| | | PAF4-03000022 | ÁNODO | ANODE | ANODO | ANODE | 1 | | |
| | | PAGB/T91-1.6X12 | PIN BLOQUEADOR | COTTER PIN | COPPIGLIA | GOUPILLE | 1 | | |
| | | PAF2.6-03000013 | PIN | PIN | PIN | PIN | 1 | | |
| | | PAF2.6-03000100 | TURBINA | IMPELLER | GIRANTE | TURBINE | 1 | | |
| | | PAJASOF404-19-033 | TÓRICA | O-RING | O-RING | JOINT TORIQUE | 1 | | |
| | | | RECKITF2.5B | NGKCR6HSB | BUJÍA | SPARK PLUG | CANDELE | BOUGIE | 1 |
| | | | | PAF4-04070003 | ANODO | ANODE | ANODO | ANODE | 1 |
| | | | | PAF4-04000011 | JUNTA | GASKET | GUARNIZIONE | JOINT | 1 |
| PAF4-04000006 | JUNTA | | | GASKET | GUARNIZIONE | JOINT | 1 | | |
| PAF4-04120005 | FILTRO COMBUSTIBLE | | | FUEL FILTER | FILTRO COMBUSTIBILE | FILTRE ESSENCE | 1 | | |
| REC90430-08020 | JUNTA DESAGÜE | | | DRAIN GASKET | GUARNIZIONE DRENAGGIO | JOINT DE VIDANGE | x 2 | | |
| PAF4-03000022 | ÁNODO | | | ANODE | ANODO | ANODE | 1 | | |
| PAGB/T91-1.6X12 | PIN BLOQUEADOR | | | COTTER PIN | COPPIGLIA | GOUPILLE | 1 | | |
| PAF2.6-03000013 | PIN | | | PIN | PIN | PIN | 1 | | |
| PAF2.6-03000100 | TURBINA | | | IMPELLER | GIRANTE | TURBINE | 1 | | |
| | RECKITF4A | | | NGKBR6HS | BUJÍA | SPARK PLUG | CANDELE | BOUGIE | 1 |
| | | | | PAF4-04070003 | ANODO | ANODE | ANODO | ANODE | 1 |
| | | | | PAF4-04000011 | JUNTA | GASKET | GUARNIZIONE | JOINT | 1 |
| | | | | PAF4-03000018 | JUNTA | GASKET | GUARNIZIONE | JOINT | 1 |
| | | PAF4-05000300 | FILTRO COMBUSTIBLE | FUEL FILTER | FILTRO COMBUSTIBILE | FILTRE ESSENCE | 1 | | |
| | | REC90430-08020 | JUNTA DESAGÜE | DRAIN GASKET | GUARNIZIONE DRENAGGIO | JOINT DE VIDANGE | x 2 | | |
| | | PAF4-03000022 | ÁNODO | ANODE | ANODO | ANODE | 1 | | |
| | | PAGB/T91-1.6X12 | PIN BLOQUEADOR | COTTER PIN | SPINOTTO | PIN | 1 | | |
| | | PAF4-03000016 | PIN | PIN | PIN | PIN | 1 | | |
| | | PAF4-03060000 | TURBINA | IMPELLER | GIRANTE | TURBINE | 1 | | |
| | | PAF4-04000030 | MUELLE DEL TUBO DE COMBUSTIBLE | CLAMP | MOLLA TUBO COMBUSTIBILE | COLLIER TUYAU DE CARBURANT | x 2 | | |
| | | PAF4-04000006 | JUNTA | GASKET | GUARNIZIONE | JOINT | 1 | | |
| | | | RECKITF5A | NGKCR6HSB | BUJÍA | SPARK PLUG | CANDELE | BOUGIE | 1 |
| | | | | PAF4-04070003 | ANODO | ANODE | ANODO | ANODE | 1 |
| PAF4-04000011 | JUNTA | | | GASKET | GUARNIZIONE | JOINT | 1 | | |
| PAF4-03000018 | JUNTA | | | GASKET | GUARNIZIONE | JOINT | 1 | | |
| REC68T-24251-00 | FILTRO COMBUSTIBLE | | | FUEL FILTER | FILTRO COMBUSTIBILE | FILTRE ESSENCE | 1 | | |
| REC90430-08020 | JUNTA DESAGÜE | | | DRAIN GASKET | GUARNIZIONE DRENAGGIO | JOINT DE VIDANGE | x 2 | | |
| PAF4-03000022 | ÁNODO | | | ANODE | ANODO | ANODE | 1 | | |
| PAGB/T91-1.6X12 | PIN BLOQUEADOR | | | COTTER PIN | COPPIGLIA | GOUPILLE | 1 | | |
| PAF4-03000016 | PIN | | | PIN | PIN | PIN | 1 | | |
| PAF4-03060000 | TURBINA | | | IMPELLER | GIRANTE | TURBINE | 1 | | |
| PAF4-04000030 | MUELLE DEL TUBO DE COMBUSTIBLE | | | SPRING, FUEL PIPE | MOLLA TUBO COMBUSTIBILE | COLLIER TUYAU DE CARBURANT | x 2 | | |
| PAF4-04000006 | JUNTA | | | GASKET | GUARNIZIONE | JOINT | 1 | | |
| | RECKITF6A | | | NGKBR6HS-10 | BUJÍA | SPARK PLUG | CANDELE | BOUGIE | x 2 |
| | | | | PAF4-04070003 | ANODO | ANODE | ANODO | ANODE | 1 |
| | | PAJASOF40431-025 | TÓRICA | O-RING | O-RING | JOINT TORIQUE | 1 | | |
| | | PAGB/T3452.1-13X2 | TÓRICA | O-RING | O-RING | JOINT TORIQUE | 1 | | |
| | | REC68T-24251-00 | FILTRO COMBUSTIBLE | FUEL FILTER | FILTRO COMBUSTIBILE | FILTRE ESSENCE | 1 | | |
| | | PAF4-04000030 | MUELLE DEL TUBO DE COMBUSTIBLE | SPRING, FUEL PIPE | MOLLA TUBO COMBUSTIBILE | COLLIER TUYAU DE CARBURANT | x 2 | | |
| | | REC09168-12017 | ARANDELA | WHASER | RONDELLA | RONDELLE | 1 | | |
| | | CM68T-45251-00A | ANODO | ANODE | ANODO | ANODE | 1 | | |
| | | REC90430-08020 | JUNTA DESAGÜE | DRAIN GASKET | GUARNIZIONE DRENAGGIO | JOINT DE VIDANGE | x 2 | | |
| | | REC91490-30025 | PIN BLOQUEADOR | COTTER PIN | COPPIGLIA | GOUPILLE | 1 | | |
| | | REC68T-W0078-00 | KIT BOMBA DE AGUA | WATER PUMP REPAIR KIT | KIT POMPA DELL'ACQUA | KIT POMPE À EAU | 1 | | |
| | | | RECKITF6C | NGKCR6HSB | BUJÍA | SPARK PLUG | CANDELE | BOUGIE | 1 |
| | | | | PAF4-04000011 | JUNTA | GASKET | GUARNIZIONE | JOINT | 1 |
| | | | | PAF4-04070003 | ANODO | ANODE | ANODO | ANODE | 1 |
| REC68T-24251-00 | FILTRO COMBUSTIBLE | | | FUEL FILTER | FILTRO COMBUSTIBILE | FILTRE ESSENCE | 1 | | |
| REC90430-08020 | JUNTA DESAGÜE | | | DRAIN GASKET | GUARNIZIONE DRENAGGIO | JOINT DE VIDANGE | x 2 | | |
| CM6L5-45251-02A | ANODO | | | ANODE | ANODO | ANODE | 1 | | |
| PAF4-04000006 | JUNTA | | | GASKET | GUARNIZIONE | JOINT | 1 | | |
| PAJASOF40431-025 | TÓRICA | | | O-RING | O-RING | JOINT TORIQUE | 1 | | |
| PAF4-03000018 | JUNTA | | | GASKET | GUARNIZIONE | JOINT | 1 | | |
| PAF4-03060000 | TURBINA | | | IMPELLER | GIRANTE | TURBINE | 1 | | |
| PAF4-03000016 | PIN | | | PIN | PIN | PIN | 1 | | |
| PAGB/T91-1.6X12 | PIN BLOQUEADOR | | | COTTER PIN | COPPIGLIA | GOUPILLE | 1 | | |





| | KIT | REF | | | | | | |
|---|-----------------------|---|-----------------------|--------------------------------|-----------------------|-------------------------|----------------------------|-------|
|  | RECKITF8D | FT8 D/G (2001-14) | NGKBR6HS-10 | BUJÍA | SPARK PLUG | CANDELE | BOUGIE | x 2 |
| | | FT9.9G (2008-12) | PAF4-04070003 | ANODO | ANODE | ANODO | ANODO | 1 |
| | | FT9.9J (2013 +) | PAJASOF40431-025 | TÓRICA | O-RING | O-RING | JOINT TORIQUE | 1 |
| | | | PAGB/T3452.1-13X2 | TÓRICA | O-RING | O-RING | JOINT TORIQUE | 1 |
| | | | REC68T-24251-00 | FILTRO COMBUSTIBLE | FUEL FILTER | FILTRO COMBUSTIBILE | FILTRE ESSENCE | 1 |
| | | | PAF4-04000030 | MUELLE DEL TUBO DE COMBUSTIBLE | SPRING, FUEL PIPE | MOLLA TUBO COMBUSTIBILE | COLLIER TUYAU DE CARBURANT | x 2 |
| | | | REC09168-12017 | ARANDELA | WHASER | RONDELLA | RONDELLE | 1 |
| | | | CM68T-45251-00A | ANODO | ANODE | ANODO | ANODO | 1 |
| | | | REC90430-08020 | JUNTA DESAGÜE | DRAIN GASKET | GUARNIZIONE DRENAGGIO | JOINT DE VIDANGE | x 2 |
| | | | REC91490-30025 | PIN BLOQUEADOR | COTTER PIN | COPPIGLIA | GOUPILLE | 1 |
| | | | CM61N-45251-01A | ANODO | ANODE | ANODO | ANODO | 1 |
| | | | REC68T-W0078-00 | KIT BOMBA DE AGUA | WATER PUMP REPAIR KIT | KIT POMPA DELL'ACQUA | KIT POMPE À EAU | 1 |
| | | | CM6E0-45251-11A | ANODO | ANODE | ANODO | ANODO | 1 |
| | | | REC5GH-13440-00 | FILTRO DE ACEITE | OIL FILTER | FILTRO OLIO | FILTRE D'HUILE | 1 |
| | |  | RECKITF9.9C | F9.9C (1998-08) | CM66M-11325-00A | ANODO | ANODE | ANODO |
| F15A (1998-07) | PAF15-07010009 | | | ALOJAMIENTO DEL ANODO | SEAL ANODE | ALLOGGIAMENTO ANODO | JOINT D'ANODE | 1 |
| | CM15026A | | | ANODO | ANODE | ANODO | ANODE | 1 |
| | PAF15-07010018 | | | JUNTA | GASKET | GUARNIZIONE | JOINT | 1 |
| | PAJASOF40431-025 | | | TÓRICA | O-RING | O-RING | JOINT TORIQUE | 1 |
| | NGKDP6EA-9 | | | BUJÍA | SPARK PLUG | CANDELE | BOUGIE | x 2 |
| | REC61N-24563-10 | | | FILTRO COMBUSTIBLE | FUEL FILTER | FILTRO COMBUSTIBILE | FILTRE ESSENCE | 1 |
| | PAGB/T3452.1-32.5X1.8 | | | ARANDELA | WHASER | RONDELLA | RONDELLE | 1 |
| | PAF15-04000003 | | | ARANDELA | WHASER | RONDELLA | RONDELLE | 1 |
| | REC90430-08020 | | | JUNTA DESAGÜE | DRAIN GASKET | GUARNIZIONE DRENAGGIO | JOINT DE VIDANGE | x 2 |
| | CM61N-45251-01A | | | ANODO | ANODE | ANODO | ANODO | 1 |
| | TEN01136 | | | ANODO | ANODE | ANODO | ANODO | 1 |
| | REC91490-30025 | | | PIN BLOQUEADOR | COTTER PIN | COPPIGLIA | GOUPILLE | 1 |
| | REC63V-W0078-01 | | | KIT BOMBA DE AGUA | WATER PUMP REPAIR KIT | KIT POMPA DELL'ACQUA | KIT POMPE À EAU | 1 |
| | CM6E0-45251-11A | | | ANODO | ANODE | ANODO | ANODO | 1 |
|  | RECKITF15C | F15C (2007+) | CM6G8-11325-00A | ANODO | ANODE | ANODO | ANODO | x 3 |
| | | | PAF20-05000702 | JUNTA | GASKET | GUARNIZIONE | JOINT | 1 |
| | | | PAGB/T3452.1-13X2 | JUNTA | GASKET | GUARNIZIONE | JOINT | 1 |
| | | | REC5GH-13440-60 | FILTRO DE ACEITE | OIL FILTER | FILTRO OLIO | FILTRE D'HUILE | 1 |
| | | | PAJASOF40431-025 | TÓRICA | O-RING | O-RING | JOINT TORIQUE | 1 |
| | | | NGKDP6EB-9 | BUJÍA | SPARK PLUG | CANDELE | BOUGIE | x 2 |
| | | | PAF15-07010018 | JUNTA | GASKET | GUARNIZIONE | JOINT | 1 |
| | | | REC93210-32738 | TÓRICA | O-RING | O-RING | JOINT TORIQUE | 1 |
| | | | CM6E0-45251-11A | ANODO | ANODE | ANODO | ANODO | 1 |
| | | | PAF15-04000003 | JUNTA | GASKET | GUARNIZIONE | JOINT | 1 |
| | | | TEN01154AL | ANODO | ANODE | ANODO | ANODO | 1 |
| | | | REC91490-30025 | PIN BLOQUEADOR | COTTER PIN | COPPIGLIA | GOUPILLE | 1 |
| | | | REC90430-08020 | JUNTA DESAGÜE | DRAIN GASKET | GUARNIZIONE DRENAGGIO | JOINT DE VIDANGE | x 2 |
| | | | REC6AH-W0078-00 | KIT BOMBA DE AGUA | WATER PUMP REPAIR KIT | KIT POMPA DELL'ACQUA | KIT POMPE À EAU | 1 |
| | | | REC61N-24563-10 | FILTRO COMBUSTIBLE | FUEL FILTER | FILTRO COMBUSTIBILE | FILTRE | 1 |
|  | RECKITF20A | F20A (1998-09) | REC5GH-13440-00 | FILTRO DE ACEITE | OIL FILTER | FILTRO OLIO | FILTRE D'HUILE | 1 |
| | | | CM62Y-11325-00A | ANODO | ANODE | ANODO | ANODE | x 2 |
| | | | PAF15-07010009 | ALOJAMIENTO DEL ANODO | SEAL ANODE | ALLOGGIAMENTO ANODO | JOINT D'ANODE | x 2 |
| | | | PAJASOF40431-025 | TÓRICA | O-RING | O-RING | JOINT TORIQUE | 1 |
| | | | REC40145 | FILTRO COMBUSTIBLE | FUEL FILTER | FILTRO COMBUSTIBILE | FILTRE ESSENCE | 1 |
| | | | PAF4-04000030 | MUELLE DEL TUBO DE COMBUSTIBLE | SPRING, FUEL PIPE | MOLLA TUBO COMBUSTIBILE | COLLIER TUYAU DE CARBURANT | x 2 |
| | | | CM6E0-45251-11A | ANODO | ANODE | ANODO | ANODO | 1 |
| | | | PAF15-04000003 | ARANDELA | WHASER | RONDELLA | RONDELLE | 1 |
| | | | CM61N-45251-01A | ANODO | ANODE | ANODO | ANODO | 1 |
| | | | REC90430-08020 | JUNTA DESAGÜE | DRAIN GASKET | GUARNIZIONE DRENAGGIO | JOINT DE VIDANGE | x 2 |
| | PAGB/T91-1.6X12 | PIN BLOQUEADOR | COTTER PIN | COPPIGLIA | GOUPILLE | 1 | | |
| | NGKDP6EA-9 | BUJÍA | SPARK PLUG | CANDELE | BOUGIE | x 2 | | |
| | REC61N-W0078-11 | KIT BOMBA DE AGUA | WATER PUMP REPAIR KIT | KIT POMPA DELL'ACQUA | KIT POMPE À EAU | 1 | | |
|  | RECKITF20B | F20B (2007+) | PAF4-04070003 | ANODO | ANODE | ANODO | ANODO | x 3 |
| | | | REC6AH-12411-00 | TERMOSTATO | THERMOSTAT | TERMOSTATO | THERMOSTAT | 1 |
| | | | PAF20-05000702 | JUNTA | GASKET | GUARNIZIONE | JOINT | 1 |
| | | | CM15026A | ANODO | ANODE | ANODO | ANODO | 1 |
| | | | REC5GH-13440-60 | FILTRO DE ACEITE | OIL FILTER | FILTRO OLIO | FILTRE D'HUILE | 1 |
| | | | NGKDP6EB-9 | BUJÍA | SPARK PLUG | CANDELE | BOUGIE | x 2 |
| | | | REC61N-24563-10 | FILTRO COMBUSTIBLE | FUEL FILTER | FILTRO COMBUSTIBILE | FILTRE ESSENCE | 1 |
| | | | REC93210-32738 | TÓRICA | O-RING | O-RING | JOINT TORIQUE | 1 |
| | | | PAF15-04000003 | ARANDELA | WHASER | RONDELLA | RONDELLE | 1 |
| | | | REC90430-08020 | JUNTA DESAGÜE | DRAIN GASKET | GUARNIZIONE DRENAGGIO | JOINT DE VIDANGE | x 2 |
| | TEN01154AL | ANODO | ANODE | ANODO | ANODO | 1 | | |
| | REC6AH-W0078-00 | KIT BOMBA DE AGUA | WATER PUMP REPAIR KIT | KIT POMPA DELL'ACQUA | KIT POMPE À EAU | 1 | | |



| | KIT | REF | | | | | | | |
|---|-----------------------|---|-----------------------|-----------------------|---------------------------------|---------------------|-------------|----------------|-----|
|  | RECKITF25A | REC5GH-13440-00 | FILTRO DE ACEITE | OIL FILTER | FILTRO OLIO | FILTRE À HUILE | 1 | | |
| | | PAF15-07000031 | TERMOSTATO | THERMOSTAT | TERMOSTATO | THERMOSTAT | 1 | | |
| | | PAF15-07010022 | JUNTA | GASKET | GUARNIZIONE | JOINT | 1 | | |
| | | CM62Y-11325-00A | ANODO | ANODE | ANODO | ANODO | x 3 | | |
| | | PAF15-07010009 | ALOJAMIENTO DEL ANODO | SEAL ANODE | ALLOGGIAMENTO ANODO | JOINT D'ANODE | x 2 | | |
| | | REC61N-24563-10 | FILTRO COMBUSTIBLE | FUEL FILTER | FILTRO COMBUSTIBILE | FILTRE ESSENCE | 1 | | |
| | | REC93210-32738 | TÓRICA | O-RING | O-RING | JOINT TORIQUE | 1 | | |
| | | NGKDPR6EA-9 | BUJÍA | SPARK PLUG | CANDELE | BOUGIE | x 2 | | |
| | | CM6E0-45251-11A | ANODO | ANODE | ANODO | ANODO | 1 | | |
| | | PAF15-04000003 | ARANDELA | WHASER | RONDELLA | RONDELLE | 1 | | |
| | | CM61N-45251-01A | ANODO | ANODE | ANODO | ANODO | 1 | | |
| | | REC90430-08020 | JUNTA DESAGÜE | DRAIN GASKET | GUARNIZIONE DRENAGGIO | JOINT DE VIDANGE | x 2 | | |
| | | PAGB/T91-1.6X12 | PIN BLOQUEADOR | COTTER PIN | COPPIGLIA | GOUPILLE | 1 | | |
| | | REC61N-W0078-11 | KIT BOMBA DE AGUA | WATER PUMP REPAIR KIT | KIT POMPA DELL'ACQUA | KIT POMPE À EAU | 1 | | |
| | |  | RECKITFT25B | REC5GH-13440-00 | FILTRO DE ACEITE | OIL FILTER | FILTRO OLIO | FILTRE À HUILE | 1 |
| | | | | PAF15-07000031 | TERMOSTATO | THERMOSTAT | TERMOSTATO | THERMOSTAT | 1 |
| | | | | PAF15-07010022 | JUNTA | GASKET | GUARNIZIONE | JOINT | 1 |
| CM62Y-11325-00A | ANODO | | | ANODE | ANODO | ANODO | x 3 | | |
| PAF15-07010009 | ALOJAMIENTO DEL ANODO | | | SEAL ANODE | ALLOGGIAMENTO ANODO | JOINT D'ANODE | x 2 | | |
| REC61N-24563-10 | FILTRO COMBUSTIBLE | | | FUEL FILTER | FILTRO COMBUSTIBILE | FILTRE ESSENCE | 1 | | |
| REC93210-32738 | TÓRICA | | | O-RING | O-RING | JOINT TORIQUE | 1 | | |
| NGKDPR6EA-9 | BUJÍA | | | SPARK PLUG | CANDELE | BOUGIE | x 2 | | |
| CM6E0-45251-11A | ANODO | | | ANODE | ANODO | ANODO | 1 | | |
| PAF15-04000003 | ARANDELA | | | WHASER | RONDELLA | RONDELLE | 1 | | |
| CM67C-45371-00A | ANODO | | | ANODE | ANODO | ANODO | 1 | | |
| REC90430-08020 | JUNTA DESAGÜE | | | DRAIN GASKET | GUARNIZIONE DRENAGGIO | JOINT DE VIDANGE | x 2 | | |
| PAGB/T91-1.6X12 | PIN BLOQUEADOR | | | COTTER PIN | COPPIGLIA | GOUPILLE | 1 | | |
| REC66T-W0078-00 | KIT BOMBA DE AGUA | | | WATER PUMP REPAIR KIT | KIT POMPA DELL'ACQUA | KIT POMPE À EAU | 1 | | |
| CM67C-45251-00A | ANODO | | | ANODE | ANODO | ANODO | 1 | | |
|  | RECKITF25G | | | PAF4-04070003 | ANODO | ANODE | ANODO | ANODE | x 4 |
| | | | | REC6FM-12411-00 | TERMOSTATO | THERMOSTAT | TERMOSTATO | THERMOSTAT | 1 |
| | | REC5GH-13440-60 | FILTRO ACEITE | OIL FILTER | FILTRO OLIO | FILTRE À HUILE | 1 | | |
| | | NGKDPR6EB-9 | BUJÍA | SPARK PLUG | CANDELE | BOUGIE | x 2 | | |
| | | REC6D8-WS24A-00 | FILTRO COMBUSTIBLE | FUEL FILTER | FILTRO COMBUSTIBILE | FILTRE ESSENCE | 1 | | |
| | | PAGB/T3452.1-32.5X1.8 | TÓRICA | O-RING | O-RING | JOINT TORIQUE | 1 | | |
| | | PAF4-04000006 | ARANDELA | WHASER | RONDELLA | RONDELLE | 1 | | |
| | | PAF15-04000003 | ARANDELA | WHASER | RONDELLA | RONDELLE | 1 | | |
| | | CM6E5-45251-00A | ANODO | ANODE | ANODO | ANODE | 1 | | |
| | | CM664-45371-01A | ANODO | ANODE | ANODO | ANODE | 1 | | |
| | | REC90430-08020 | JUNTA DESAGÜE | DRAIN GASKET | GUARNIZIONE DRENAGGIO | JOINT DE VIDANGE | x 2 | | |
| | | PAF25-04050004 | GOMA SELLO DE AGUA | DAMPER WATER PIPE | AMMORTIZZATORE, TUBO DELL'ACQUA | MANCHON TUYAU D'EAU | 1 | | |
| | | REC6L2-44352-00 | TURBINA | IMPELLER | GIRANTE | TURBINE | 1 | | |
| | | PAF25-04050003 | TÓRICA | O-RING | O-RING | JOINT TORIQUE | 1 | | |
| | | PAGB/T91-1.6X12 | PIN BLOQUEADOR | COTTER PIN | COPPIGLIA | GOUPILLE | 1 | | |
| | |  | RECKITF25D | PAF15-07000031 | TERMOSTATO | THERMOSTAT | TERMOSTATO | THERMOSTAT | 1 |
| | | | | PAF15-07010022 | JUNTA | GASKET | GUARNIZIONE | JOINT | 1 |
| PAF4-04070003 | ANODO | | | ANODE | ANODO | ANODE | 1 | | |
| REC5GH-13440-60 | FILTRO ACEITE | | | OIL FILTER | FILTRO OLIO | FILTRE À HUILE | 1 | | |
| CM6BL-11325-00A | ANODO | | | ANODE | ANODO | ANODE | x 2 | | |
| NGKDPR6EB-9 | BUJÍA | | | SPARK PLUG | CANDELE | BOUGIE | x 2 | | |
| REC61N-24563-10 | FILTRO COMBUSTIBLE | | | FUEL FILTER | FILTRO COMBUSTIBILE | FILTRE ESSENCE | 1 | | |
| PAGB/T3452.1-32.5X1.8 | TÓRICA | | | O-RING | O-RING | JOINT TORIQUE | 1 | | |
| CM62Y-11325-00A | ANODO | | | ANODE | ANODO | ANODE | 1 | | |
| PAF15-04000003 | ARANDELA | | | WHASER | RONDELLA | RONDELLE | 1 | | |
| REC90430-08020 | JUNTA DESAGÜE | | | DRAIN GASKET | GUARNIZIONE DRENAGGIO | JOINT DE VIDANGE | x 2 | | |
| CM61N-45251-01A | ANODO | | | ANODE | ANODO | ANODE | 1 | | |
| REC61N-W0078-11 | KIT BOMBA DE AGUA | | | WATER PUMP REPAIR KIT | KIT POMPA DELL'ACQUA | KIT POMPE À EAU | 1 | | |
| PAGB/T91-1.6X12 | PIN BLOQUEADOR | | | COTTER PIN | COPPIGLIA | GOUPILLE | 1 | | |
|  | RECKITFT25F | | | PAF15-07000031 | TERMOSTATO | THERMOSTAT | TERMOSTATO | THERMOSTAT | 1 |
| | | | | PAF15-07010022 | JUNTA | GASKET | GUARNIZIONE | JOINT | 1 |
| | | | | PAF4-04070003 | ANODO | ANODE | ANODO | ANODE | 1 |
| | | REC5GH-13440-60 | FILTRO ACEITE | OIL FILTER | FILTRO OLIO | FILTRE À HUILE | 1 | | |
| | | CM6BL-11325-00A | ANODO | ANODE | ANODO | ANODE | x 2 | | |
| | | NGKDPR6EB-9 | BUJÍA | SPARK PLUG | CANDELE | BOUGIE | x 2 | | |
| | | REC61N-24563-10 | FILTRO COMBUSTIBLE | FUEL FILTER | FILTRO COMBUSTIBILE | FILTRE ESSENCE | 1 | | |
| | | PAGB/T3452.1-32.5X1.8 | TÓRICA | O-RING | O-RING | JOINT TORIQUE | 1 | | |
| | | CM6E0-45251-11A | ANODO | ANODE | ANODO | ANODE | 1 | | |
| | | CM62Y-11325-00A | ANODO | ANODE | ANODO | ANODE | 1 | | |
| | | PAF15-04000003 | ARANDELA | WHASER | RONDELLA | RONDELLE | 1 | | |
| | | REC90430-08020 | JUNTA DESAGÜE | DRAIN GASKET | GUARNIZIONE DRENAGGIO | JOINT DE VIDANGE | x 2 | | |
| | | CM67C-45371-00A | ANODO | ANODE | ANODO | ANODE | 1 | | |
| | | PAGB/T91-1.6X12 | PIN BLOQUEADOR | COTTER PIN | COPPIGLIA | GOUPILLE | 1 | | |
| | | CM67C-45251-00A | ANODO | ANODE | ANODO | ANODE | 1 | | |
| | | REC66T-W0078-00 | KIT BOMBA DE AGUA | WATER PUMP REPAIR KIT | KIT POMPA DELL'ACQUA | KIT POMPE À EAU | 1 | | |

| | KIT | REF | | | | | |
|---|------------------------|--|--------------------------------|-----------------------|-------------------------|----------------------------|------------|
|  | RECKITF30A | PAF15-07000031 | TERMOSTATO | THERMOSTAT | TERMOSTATO | THERMOSTAT | 1 |
| | | PAF15-07010022 | JUNTA | GASKET | GUARNIZIONE | JOINT | 1 |
| | | NGKDPR6EA-9 | BUJÍA | SPARK PLUG | CANDELE | BOUGIE | x 3 |
| | | REC5GH-13440-00 | FILTRO ACEITE | OIL FILTER | FILTRO OLIO | FILTRE À HUILE | 1 |
| | | CM62Y-11325-00A | ANODO | ANODE | ANODO | ANODE | x 4 |
| | | PAF15-07010009 | ALOJAMIENTO DEL ANODO | SEAL ANODE | ALLOGGIAMENTO ANODO | JOINT D'ANODE | x 4 |
| | | REC40145 | FILTRO COMBUSTIBLE | FUEL FILTER | FILTRO COMBUSTIBILE | FILTRE ESSENCE | 1 |
| | | PAF4-04000030 | MUELLE DEL TUBO DE COMBUSTIBLE | SPRING, FUEL PIPE | MOLLA TUBO COMBUSTIBILE | COLLIER TUYAU DE CARBURANT | x 2 |
| | | CM688-45251-01A | ANODO | ANODE | ANODO | ANODE | 1 |
| | | PAF15-04000003 | ARANDELA | WHASER | RONDELLA | RONDELLE | 1 |
| | | REC90430-08020 | JUNTA DESAGÜE | DRAIN GASKET | GUARNIZIONE DRENAGGIO | JOINT DE VIDANGE | x 2 |
| | | CM67C-45251-00A | ANODO | ANODE | ANODO | ANODE | 1 |
| | | CM67C-45371-00A | ANODO | ANODE | ANODO | ANODE | 1 |
| | | REC91490-30025 | PIN BLOQUEADOR | COTTER PIN | COPPIGLIA | GOUPILLE | 1 |
| | | REC66T-W0078-00 | KIT BOMBA DE AGUA | WATER PUMP REPAIR KIT | KIT POMPA DELL'ACQUA | KIT POMPE À EAU | 1 |
| | |  | RECKITF30B | PAF15-07000031 | TERMOSTATO | THERMOSTAT | TERMOSTATO |
| PAF15-07010022 | JUNTA | | | GASKET | GUARNIZIONE | JOINT | 1 |
| PAF4-04070003 | ANODO | | | ANODE | ANODO | ANODE | x 4 |
| REC5GH-13440-60 | FILTRO DE ACEITE | | | OIL FILTER | FILTRO OLIO | FILTRE À HUILE | 1 |
| NGKDPR6EB-9 | BUJÍA | | | SPARK PLUG | CANDELE | BOUGIE | x 3 |
| REC6BG-13915-00 | FILTRO COMBUSTIBLE VST | | | FUEL FILTER VST | FILTRO COMBUSTIBILE VST | FILTRE ESSENCE VST | 1 |
| REC6C5-24251-00 | FILTRO COMBUSTIBLE | | | FUEL FILTER | FILTRO COMBUSTIBILE | FILTRE ESSENCE | 1 |
| REC6D8-WS24A-00 | FILTRO COMBUSTIBLE | | | FUEL FILTER | FILTRO COMBUSTIBILE | FILTRE ESSENCE | 1 |
| PAGB/T3452.1-32.5X1.8 | TÓRICA | | | O-RING | O-RING | JOINT TORIQUE | 1 |
| CM6E0-45251-11A | ANODO | | | ANODE | ANODO | ANODE | 1 |
| CM688-45251-01A | ANODO | | | ANODE | ANODO | ANODE | 1 |
| CM62Y-11325-00A | ANODO | | | ANODE | ANODO | ANODE | 1 |
| PAF15-04000003 | ARANDELA | | | WHASER | RONDELLA | RONDELLE | 1 |
| REC90430-08020 | JUNTA DESAGÜE | | | DRAIN GASKET | GUARNIZIONE DRENAGGIO | JOINT DE VIDANGE | x 2 |
| CM67C-45371-00A | ANODO | | | ANODE | ANODO | ANODE | 1 |
| CM67C-45251-00A | ANODO | | | ANODE | ANODO | ANODE | 1 |
| REC6BG-W0078-00 | KIT BOMBA DE AGUA | WATER PUMP REPAIR KIT | KIT POMPA DELL'ACQUA | KIT POMPE À EAU | 1 | | |
| REC91490-30025 | PIN BLOQUEADOR | COTTER PIN | SPINOTTO | PIN | 1 | | |
|  | RECKITF40B | PAF15-07000031 | TERMOSTATO | THERMOSTAT | TERMOSTATO | THERMOSTAT | 1 |
| | | PAF15-07010022 | JUNTA | GASKET | GUARNIZIONE | JOINT | 1 |
| | | REC3FV-13440-00 | FILTRO DE ACEITE | OIL FILTER | FILTRO OLIO | FILTRE À HUILE | 1 |
| | | CM62Y-11325-00A | ANODO | ANODE | ANODO | ANODE | x 3 |
| | | PAF15-07010009 | ALOJAMIENTO DEL ANODO | SEAL ANODE | ALLOGGIAMENTO ANODO | JOINT D'ANODE | x 3 |
| | | NGKDPR6EA-9 | BUJÍA | SPARK PLUG | CANDELE | BOUGIE | x 3 |
| | | REC40145 | FILTRO COMBUSTIBLE | FUEL FILTER | FILTRO COMBUSTIBILE | FILTRE ESSENCE | 1 |
| | | PAF4-04000030 | MUELLE DEL TUBO DE COMBUSTIBLE | SPRING, FUEL PIPE | MOLLA TUBO COMBUSTIBILE | COLLIER TUYAU DE CARBURANT | x 2 |
| | | CM688-45251-01A | ANODO | ANODE | ANODO | ANODE | 1 |
| | | CM6E0-45251-11A | ANODO | ANODE | ANODO | ANODE | 1 |
| | | PAF15-04000003 | ARANDELA | WHASER | RONDELLA | RONDELLE | 1 |
| | | REC90430-08020 | JUNTA DESAGÜE | DRAIN GASKET | GUARNIZIONE DRENAGGIO | JOINT DE VIDANGE | x 2 |
| | | CM67C-45371-00A | ANODO | ANODE | ANODO | ANODE | 1 |
| | | CM67C-45251-00A | ANODO | ANODE | ANODO | ANODE | 1 |
| | | REC91490-30025 | PIN BLOQUEADOR | COTTER PIN | COPPIGLIA | GOUPILLE | 1 |
| | | REC66T-W0078-00 | KIT BOMBA DE AGUA | WATER PUMP REPAIR KIT | KIT POMPA DELL'ACQUA | KIT POMPE À EAU | 1 |
|  | RECKITF50A | PAF15-07000031 | TERMOSTATO | THERMOSTAT | TERMOSTATO | THERMOSTAT | 1 |
| | | PAF15-07010022 | JUNTA | GASKET | GUARNIZIONE | JOINT | 1 |
| | | PAF4-04070003 | ANODO | ANODE | ANODO | ANODO | x 4 |
| | | REC5GH-13440-60 | FILTRO DE ACEITE | OIL FILTER | FILTRO OLIO | FILTRE À HUILE | 1 |
| | | NGKDPR6EB-9 | BUJÍA | SPARK PLUG | CANDELE | BOUGIE | x 4 |
| | | REC6BG-13915-00 | FILTRO COMBUSTIBLE VST | FUEL FILTER VST | FILTRO COMBUSTIBILE VST | FILTRE VST | 1 |
| | | REC6C5-24251-00 | FILTRO COMBUSTIBLE | FUEL FILTER | FILTRO COMBUSTIBILE | FILTRE ESSENCE | 1 |
| | | REC6D8-WS24A-00 | FILTRO COMBUSTIBLE | FUEL FILTER | FILTRO COMBUSTIBILE | FILTRE ESSENCE | 1 |
| | | PAGB/T3452.1-32.5X1.8 | TÓRICA | O-RING | O-RING | JOINT TORIQUE | 1 |
| | | CM6E0-45251-11A | ANODO | ANODE | ANODO | ANODE | 1 |
| | | CM688-45251-01A | ANODO | ANODE | ANODO | ANODE | 1 |
| | | CM62Y-11325-00A | ANODO | ANODE | ANODO | ANODE | 1 |
| | | PAF15-04000003 | ARANDELA | WHASER | RONDELLA | RONDELLE | 1 |
| | | REC90430-08020 | JUNTA DESAGÜE | DRAIN GASKET | GUARNIZIONE DRENAGGIO | JOINT DE VIDANGE | x 2 |
| | | CM67C-45371-00A | ANODO | ANODE | ANODO | ANODE | 1 |
| | | CM67C-45251-00A | ANODO | ANODE | ANODO | ANODE | 1 |
| REC6BG-W0078-00 | KIT BOMBA DE AGUA | WATER PUMP REPAIR KIT | KIT POMPA DELL'ACQUA | KIT POMPE À EAU | 1 | | |
| REC91490-30025 | PIN BLOQUEADOR | COTTER PIN | COPPIGLIA | GOUPILLE | 1 | | |





| | KIT | REF | | | | | |
|---|-----------------------|---|------------------------|-----------------------|-------------------------|--------------------|------------|
|  | RECKITFT50B | PAF15-07000031 | TERMOSTATO | THERMOSTAT | TERMOSTATO | THERMOSTAT | 1 |
| | | PAF15-07010022 | JUNTA | GASKET | GUARNIZIONE | JOINT | 1 |
| | | REC5GH-13440-00 | FILTRO DE ACEITE | OIL FILTER | FILTRO OLIO | FILTRE À HUILE | 1 |
| | | CM62Y-11325-00A | ANODO | ANODE | ANODO | ANODE | x 5 |
| | | PAF15-07010009 | ALOJAMIENTO DEL ANODO | SEAL ANODE | ALLOGGIAMENTO ANODO | JOINT D'ANODE | x 5 |
| | | NGKDP6EA-9 | BUJÍA | SPARK PLUG | CANDELE | BOUGIE | x 4 |
| | | REC68V-24563-00 | FILTRO COMBUSTIBLE | FUEL FILTER | FILTRO COMBUSTIBILE | FILTRE | 1 |
| | | REC93210-32738 | TÓRICA | O-RING | O-RING | JOINT TORIQUE | 1 |
| | | CM6E0-45251-11A | ANODO | ANODE | ANODO | ANODE | x 3 |
| | | PAF15-04000003 | ARANDELA | WHASER | RONDELLA | RONDELLE | 1 |
| | | REC90430-08020 | JUNTA DESAGÜE | DRAIN GASKET | GUARNIZIONE DRENAGGIO | JOINT DE VIDANGE | x 2 |
| | | CM67F-45371-00A | ANODO | ANODE | ANODO | ANODE | 1 |
| | | REC91490-40030 | PIN BLOQUEADOR | COTTER PIN | COPPIGLIA | GOUPILLE | 1 |
| | | REC6H3-W0078-02 | KIT BOMBA DE AGUA | WATER PUMP REPAIR KIT | KIT POMPA DELL'ACQUA | KIT POMPE À EAU | 1 |
| | |  | RECKITFT50C | PAF15-07000031 | TERMOSTATO | THERMOSTAT | TERMOSTATO |
| PAF15-07010022 | JUNTA | | | GASKET | GUARNIZIONE | JOINT | 1 |
| CM62Y-11325-00A | ANODO | | | ANODE | ANODO | ANODE | x 5 |
| PAF15-07010009 | ALOJAMIENTO DEL ANODO | | | SEAL ANODE | ALLOGGIAMENTO ANODO | JOINT D'ANODE | x 5 |
| NGKDP6EA-9 | BUJÍA | | | SPARK PLUG | CANDELE | BOUGIE | x 4 |
| REC5GH-13440-00 | FILTRO DE ACEITE | | | OIL FILTER | FILTRO OLIO | FILTRE À HUILE | 1 |
| REC61N-24563-10 | FILTRO COMBUSTIBLE | | | FUEL FILTER | FILTRO COMBUSTIBILE | FILTRE ESSENCE | 1 |
| PAGB/T3452.1-32.5X1.8 | TÓRICA | | | O-RING | O-RING | JOINT TORIQUE | 1 |
| CM6E0-45251-11A | ANODO | | | ANODE | ANODO | ANODE | x 3 |
| PAF15-04000003 | ARANDELA | | | WHASER | RONDELLA | RONDELLE | 1 |
| REC90430-08020 | JUNTA DESAGÜE | | | DRAIN GASKET | GUARNIZIONE DRENAGGIO | JOINT DE VIDANGE | x 2 |
| CM67F-45371-00A | ANODO | | | ANODE | ANODO | ANODE | 1 |
| REC91490-40030 | PIN BLOQUEADOR | | | COTTER PIN | COPPIGLIA | GOUPILLE | 1 |
| REC6H3-W0078-02 | KIT BOMBA DE AGUA | | | WATER PUMP REPAIR KIT | KIT POMPA DELL'ACQUA | KIT POMPE À EAU | 1 |
|  | RECKITF50F | | | PAF15-07000031 | TERMOSTATO | THERMOSTAT | TERMOSTATO |
| | | PAF15-07010022 | JUNTA | GASKET | GUARNIZIONE | JOINT | 1 |
| | | CM62Y-11325-00A | ANODO | ANODE | ANODO | ANODE | x 5 |
| | | PAF15-07010009 | ALOJAMIENTO DEL ANODO | SEAL ANODE | ALLOGGIAMENTO ANODO | JOINT D'ANODE | x 5 |
| | | REC5GH-13440-00 | FILTRO DE ACEITE | OIL FILTER | FILTRO OLIO | FILTRE À HUILE | 1 |
| | | NGKDP6EB-9 | BUJÍA | SPARK PLUG | CANDELE | BOUGIE | x 4 |
| | | REC6C5-13915-00 | FILTRO COMBUSTIBLE VST | FUEL FILTER VST | FILTRO COMBUSTIBILE VST | FILTRE VST | 1 |
| | | REC6C5-14984-00 | TÓRICA VST | VST O-RING | O-RING VST | JOINT TORIQUE VST | 1 |
| | | REC6C5-24251-00 | FILTRO COMBUSTIBLE | FUEL FILTER | FILTRO COMBUSTIBILE | FILTRE ESSENCE | 1 |
| | | REC68V-24563-00 | FILTRO COMBUSTIBLE | FUEL FILTER | FILTRO COMBUSTIBILE | FILTRE ESSENCE | 1 |
| | | REC93210-32738 | TÓRICA | O-RING | O-RING | JOINT TORIQUE | 1 |
| | | CM6E0-45251-11A | ANODO | ANODE | ANODO | ANODE | x 2 |
| | | CM688-45251-01A | ANODO | ANODE | ANODO | ANODE | 1 |
| | | PAF15-04000003 | ARANDELA | WHASER | RONDELLA | RONDELLE | 1 |
| | | REC90430-08020 | JUNTA DESAGÜE | DRAIN GASKET | GUARNIZIONE DRENAGGIO | JOINT DE VIDANGE | x 2 |
| | | CM67C-45371-00A | ANODO | ANODE | ANODO | ANODE | 1 |
| | | CM67C-45251-00A | ANODO | ANODE | ANODO | ANODE | 1 |
| | | REC91490-30025 | PIN BLOQUEADOR | COTTER PIN | COPPIGLIA | GOUPILLE | 1 |
| REC63D-W0078-01 | KIT BOMBA DE AGUA | WATER PUMP REPAIR KIT | KIT POMPA DELL'ACQUA | KIT POMPE À EAU | 1 | | |
|  | RECKITFT50G | PAF15-07000031 | TERMOSTATO | THERMOSTAT | TERMOSTATO | THERMOSTAT | 1 |
| | | PAF15-07010022 | JUNTA | GASKET | GUARNIZIONE | JOINT | 1 |
| | | REC5GH-13440-60 | FILTRO DE ACEITE | OIL FILTER | FILTRO OLIO | FILTRE À HUILE | 1 |
| | | CM62Y-11325-00A | ANODO | ANODE | ANODO | ANODE | 1 |
| | | PAF15-07010009 | ALOJAMIENTO DEL ANODO | SEAL ANODE | ALLOGGIAMENTO ANODO | JOINT D'ANODE | 1 |
| | | NGKDP6EB-9 | BUJÍA | SPARK PLUG | CANDELE | BOUGIE | x 4 |
| | | PAF4-04070003 | ANODO | ANODE | ANODO | ANODE | x 4 |
| | | PAGB/T3452.1-13X2 | TÓRICA | O-RING | O-RING | JOINT TORIQUE | x 4 |
| | | REC6C5-13915-00 | FILTRO COMBUSTIBLE VST | FUEL FILTER VST | FILTRO COMBUSTIBILE VST | FILTRE ESSENCE VST | 1 |
| | | REC6C5-14984-00 | TÓRICA VST | VST O-RING | O-RING VST | JOINT TORIQUE VST | 1 |
| | | REC6C5-24251-00 | FILTRO COMBUSTIBLE | FUEL FILTER | FILTRO COMBUSTIBILE | FILTRE ESSENCE | 1 |
| | | REC6D8-WS24A-00 | FILTRO COMBUSTIBLE | FUEL FILTER | FILTRO COMBUSTIBILE | FILTRE ESSENCE | 1 |
| | | PAGB/T3452.1-32.5X1.8 | TÓRICA | O-RING | O-RING | JOINT TORIQUE | 1 |
| | | CM6E0-45251-11A | ANODO | ANODE | ANODO | ANODE | x 3 |
| | | PAF15-04000003 | ARANDELA | WHASER | RONDELLA | RONDELLE | 1 |
| REC90430-08020 | JUNTA DESAGÜE | DRAIN GASKET | GUARNIZIONE DRENAGGIO | JOINT DE VIDANGE | x 2 | | |
| CM67F-45371-00A | ANODO | ANODE | ANODO | ANODE | 1 | | |
| REC91490-40030 | PIN BLOQUEADOR | COTTER PIN | COPPIGLIA | GOUPILLE | 1 | | |
| REC6H3-W0078-02 | KIT BOMBA DE AGUA | WATER PUMP REPAIR KIT | KIT POMPA DELL'ACQUA | KIT POMPE À EAU | 1 | | |





| | KIT | REF | | | | | | | |
|--|------------------------|-----------------------|------------------------|-----------------------|-------------------------|--------------------|-------------|------------|---|
| F50H (2013+) F60A (2002-07) F60C (2005-12) F60F (2013+) | RECKITF60A | PAF15-07010009 | ALOJAMIENTO DEL ANODO | SEAL ANODE | ALLOGGIAMENTO ANODO | JOINT D'ANODE | 1 | | |
| | | REC5GH-13440-60 | FILTRO DE ACEITE | OIL FILTER | FILTRO OLIO | FILTRE À HUILE | 1 | | |
| | | PAF4-04070003 | ANODO | ANODE | ANODO | ANODE | x 4 | | |
| | | PAGB/T3452.1-13X2 | TÓRICA | O-RING | O-RING | JOINT TORIQUE | x 4 | | |
| | | NGKDPR6EB-9 | BUJÍA | SPARK PLUG | CANDELE | BOUGIE | x 4 | | |
| | | REC6C5-13915-00 | FILTRO COMBUSTIBLE VST | FUEL FILTER VST | FILTRO COMBUSTIBILE VST | FILTRE VST | 1 | | |
| | | REC6C5-14984-00 | TÓRICA VST | VST O-RING | O-RING VST | JOINT TORIQUE VST | 1 | | |
| | | REC6C5-24251-00 | FILTRO COMBUSTIBLE | FUEL FILTER | FILTRO COMBUSTIBILE | FILTRE ESSENCE | 1 | | |
| | | REC6D8-WS24A-00 | FILTRO COMBUSTIBLE | FUEL FILTER | FILTRO COMBUSTIBILE | FILTRE ESSENCE | 1 | | |
| | | REC93210-32738 | TÓRICA | O-RING | O-RING | JOINT TORIQUE | 1 | | |
| | | CM6E0-45251-11A | ANODO | ANODE | ANODO | ANODE | x 4 | | |
| | | CM688-45251-01A | ANODO | ANODE | ANODO | ANODE | 1 | | |
| | | PAF15-04000003 | ARANDELA | WHASER | RONDELLA | RONDELLE | 1 | | |
| | | REC90430-08020 | JUNTA DESAGÜE | DRAIN GASKET | GUARNIZIONE DRENAGGIO | JOINT DE VIDANGE | x 2 | | |
| | | CM67C-45371-00A | ANODO | ANODE | ANODO | ANODE | 1 | | |
| | | CM67C-45251-00A | ANODO | ANODE | ANODO | ANODE | 1 | | |
| REC91490-30025 | PIN BLOQUEADOR | COTTER PIN | COPPIGLIA | GOUPILLE | 1 | | | | |
| REC63D-W0078-01 | KIT BOMBA DE AGUA | WATER PUMP REPAIR KIT | KIT POMPA DELL'ACQUA | KIT POMPE À EAU | 1 | | | | |
| FT60B (2003-06) | RECKITF60B | PAF15-07000031 | TERMOSTATO | THERMOSTAT | TERMOSTATO | THERMOSTAT | 1 | | |
| | | PAF15-07010022 | JUNTA | GASKET | GUARNIZIONE | JOINT | 1 | | |
| | | CM62Y-11325-00A | ANODO | ANODE | ANODO | ANODE | x 5 | | |
| | | PAF15-07010009 | ALOJAMIENTO DEL ANODO | SEAL ANODE | ALLOGGIAMENTO ANODO | JOINT D'ANODE | x 5 | | |
| | | REC5GH-13440-60 | FILTRO DE ACEITE | OIL FILTER | FILTRO OLIO | FILTRE À HUILE | 1 | | |
| | | NGKDPR5EA-9 | BUJÍA | SPARK PLUG | CANDELE | BOUGIE | x 4 | | |
| | | REC61N-24563-10 | FILTRO COMBUSTIBLE | FUEL FILTER | FILTRO COMBUSTIBILE | FILTRE ESSENCE | 1 | | |
| | | PAGB/T3452.1-32.5X1.8 | TÓRICA | O-RING | O-RING | JOINT TORIQUE | 1 | | |
| | | CM6E0-45251-11A | ANODO | ANODE | ANODO | ANODE | x 3 | | |
| | | PAF15-04000003 | ARANDELA | WHASER | RONDELLA | RONDELLE | 1 | | |
| | | REC90430-08020 | JUNTA DESAGÜE | DRAIN GASKET | GUARNIZIONE DRENAGGIO | JOINT DE VIDANGE | x 2 | | |
| | | CM67F-45371-00A | ANODO | ANODE | ANODO | ANODE | 1 | | |
| | | REC91490-40030 | PIN BLOQUEADOR | COTTER PIN | COPPIGLIA | GOUPILLE | 1 | | |
| | | REC6H3-W0078-02 | KIT BOMBA DE AGUA | WATER PUMP REPAIR KIT | KIT POMPA DELL'ACQUA | KIT POMPE À EAU | 1 | | |
| | | F70A (2011+) | RECKITF70A | PAF15-07000031 | TERMOSTATO | THERMOSTAT | TERMOSTATO | THERMOSTAT | 1 |
| | | | | PAF15-07010022 | JUNTA | GASKET | GUARNIZIONE | JOINT | 1 |
| CM62Y-11325-00A | ANODO | | | ANODE | ANODO | ANODE | 1 | | |
| REC5GH-13440-60 | FILTRO DE ACEITE | | | OIL FILTER | FILTRO OLIO | FILTRE À HUILE | 1 | | |
| PAF4-04070003 | ANODO | | | ANODE | ANODO | ANODE | x 3 | | |
| PAGB/T3452.1-13X2 | TÓRICA | | | O-RING | O-RING | JOINT TORIQUE | x 3 | | |
| NGKLR7E | BUJÍA | | | SPARK PLUG | CANDELE | BOUGIE | x 4 | | |
| REC6C5-13915-00 | FILTRO COMBUSTIBLE VST | | | FUEL FILTER VST | FILTRO COMBUSTIBILE VST | FILTRE ESSENCE VST | 1 | | |
| REC6C5-24251-00 | FILTRO COMBUSTIBLE | | | FUEL FILTER | FILTRO COMBUSTIBILE | FILTRE ESSENCE | 1 | | |
| REC6D8-WS24A-00 | FILTRO COMBUSTIBLE | | | FUEL FILTER | FILTRO COMBUSTIBILE | FILTRE ESSENCE | 1 | | |
| REC93210-32738 | TÓRICA | | | O-RING | O-RING | JOINT TORIQUE | 1 | | |
| CM6E0-45251-11A | ANODO | | | ANODE | ANODO | ANODE | x 3 | | |
| PAF15-04000003 | ARANDELA | | | WHASER | RONDELLA | RONDELLE | 1 | | |
| REC90430-08020 | JUNTA DESAGÜE | | | DRAIN GASKET | GUARNIZIONE DRENAGGIO | JOINT DE VIDANGE | x 2 | | |
| CM67F-45371-00A | ANODO | | | ANODE | ANODO | ANODE | 1 | | |
| REC91490-30025 | PIN BLOQUEADOR | | | COTTER PIN | COPPIGLIA | GOUPILLE | 1 | | |
| REC6CJ-W0078-00 | KIT BOMBA DE AGUA | WATER PUMP REPAIR KIT | KIT POMPA DELL'ACQUA | KIT POMPE À EAU | 1 | | | | |
| F80A (2000-07) F100A (1997-07) | RECKITF80A | CM68V-11325-01A | ANODO | ANODE | ANODO | ANODE | x 2 | | |
| | | REC5GH-13440-00 | FILTRO DE ACEITE | OIL FILTER | FILTRO OLIO | FILTRE À HUILE | 1 | | |
| | | REC67F-12411-01 | TERMOSTATO | THERMOSTAT | TERMOSTATO | THERMOSTAT | 1 | | |
| | | NGKLR5A-11 | BUJÍA | SPARK PLUG | CANDELE | BOUGIE | x 4 | | |
| | | PAJASOF40431-025 | TÓRICA | O-RING | O-RING | JOINT TORIQUE | 1 | | |
| | | REC61N-24563-10 | FILTRO COMBUSTIBLE | FUEL FILTER | FILTRO COMBUSTIBILE | FILTRE ESSENCE | 1 | | |
| | | PAGB/T3452.1-32.5X1.8 | TÓRICA | O-RING | O-RING | JOINT TORIQUE | 1 | | |
| | | CM6H1-45251-02A | ANODO | ANODE | ANODO | ANODE | 1 | | |
| | | PAF15-04000003 | ARANDELA | WHASER | RONDELLA | RONDELLE | 1 | | |
| | | REC91490-40030 | PIN BLOQUEADOR | COTTER PIN | COPPIGLIA | GOUPILLE | 1 | | |
| | | REC90430-08020 | JUNTA DESAGÜE | DRAIN GASKET | GUARNIZIONE DRENAGGIO | JOINT DE VIDANGE | x 2 | | |
| | | REC67F-W0078-00 | KIT BOMBA DE AGUA | WATER PUMP REPAIR KIT | KIT POMPA DELL'ACQUA | KIT POMPE À EAU | 1 | | |

| | KIT | REF | | | | | |
|---|--------------------|---|--------------------|-----------------------|-----------------------|------------------|-------|
|  | RECKITF80B | CM15026A | ANODO | ANODE | ANODO | ANODE | x 3 |
| | | CM67F-11325-01A | ANODO | ANODE | ANODO | ANODE | 1 |
| | | REC5GH-13440-00 | FILTRO DE ACEITE | OIL FILTER | FILTRO OLIO | FILTRE À HUILE | 1 |
| | | CM67F-11325-01A | ANODO | ANODE | ANODO | ANODE | x 2 |
| | | PAJASOF40431-025 | TÓRICA | O-RING | O-RING | JOINT TORIQUE | 1 |
| | | REC67F-12411-01 | TERMOSTATO | THERMOSTAT | TERMOSTATO | THERMOSTAT | 1 |
| | | NGKLF5A-11 | BUJÍA | SPARK PLUG | CANDELE | BOUGIE | x 4 |
| | | REC6C5-13915-00 | FILTRO COMBUSTIBLE | FUEL FILTER | FILTRO COMBUSTIBILE | FILTRE ESSENCE | 1 |
| | | REC6C5-24251-00 | FILTRO COMBUSTIBLE | FUEL FILTER | FILTRO COMBUSTIBILE | FILTRE ESSENCE | 1 |
| | | REC6D8-WS24A-00 | FILTRO COMBUSTIBLE | FUEL FILTER | FILTRO COMBUSTIBILE | FILTRE ESSENCE | 1 |
| | | PAGB/T3452.1-32.5X1.8 | TÓRICA | O-RING | O-RING | JOINT TORIQUE | 1 |
| | | CM6H1-45251-02A | ANODO | ANODE | ANODO | ANODE | 1 |
| | | PAF15-04000003 | ARANDELA | WHASER | RONDELLA | RONDELLE | 1 |
| | | REC90430-08020 | JUNTA DESAGÜE | DRAIN GASKET | GUARNIZIONE DRENAGGIO | JOINT DE VIDANGE | x 2 |
| | | CM67F-45371-00 | ANODO | ANODE | ANODO | ANODE | 1 |
| | | REC91490-40030 | PIN BLOQUEADOR | COTTER PIN | COPPIGLIA | GOUPILLE | 1 |
| | | REC67F-W0078-00 | KIT BOMBA DE AGUA | WATER PUMP REPAIR KIT | KIT POMPA DELL'ACQUA | KIT POMPE À EAU | 1 |
|  | RECKITF100D | CM15026A | ANODO | ANODE | ANODO | ANODE | x 3 |
| | | REC5GH-13440-00 | FILTRO DE ACEITE | OIL FILTER | FILTRO OLIO | FILTRE À HUILE | 1 |
| | | CM67F-11325-01A | ANODO | ANODE | ANODO | ANODE | x 3 |
| | | PAJASOF40431-025 | TÓRICA | O-RING | O-RING | JOINT TORIQUE | 1 |
| | | REC6D9-12411-00 | TERMOSTATO | THERMOSTAT | TERMOSTATO | THERMOSTAT | 1 |
| | | NGKLF5A-11 | BUJÍA | SPARK PLUG | CANDELE | BOUGIE | x 4 |
| | | REC6C5-13915-00 | FILTRO COMBUSTIBLE | FUEL FILTER | FILTRO COMBUSTIBILE | FILTRE ESSENCE | 1 |
| | | REC6C5-24251-00 | FILTRO COMBUSTIBLE | FUEL FILTER | FILTRO COMBUSTIBILE | FILTRE ESSENCE | 1 |
| | | REC6D8-WS24A-00 | FILTRO COMBUSTIBLE | FUEL FILTER | FILTRO COMBUSTIBILE | FILTRE ESSENCE | 1 |
| | | PAGB/T3452.1-32.5X1.8 | TÓRICA | O-RING | O-RING | JOINT TORIQUE | 1 |
| | | CM6H1-45251-02A | ANODO | ANODE | ANODO | ANODE | 1 |
| | | PAF15-04000003 | ARANDELA | WHASER | RONDELLA | RONDELLE | 1 |
| | | REC90430-08020 | JUNTA DESAGÜE | DRAIN GASKET | GUARNIZIONE DRENAGGIO | JOINT DE VIDANGE | x 2 |
| | | CM67F-45371-00 | ANODO | ANODE | ANODO | ANODE | 1 |
| | | REC91490-40030 | PIN BLOQUEADOR | COTTER PIN | SPINOTTO | PIN | 1 |
| | | REC67F-W0078-00 | KIT BOMBA DE AGUA | WATER PUMP REPAIR KIT | KIT POMPA DELL'ACQUA | KIT POMPE À EAU | 1 |
| | |  | RECKITF100F | PAF4-04070003 | ANODO | ANODE | ANODO |
| PAGB/T3452.1-13X2 | TÓRICA | | | O-RING | O-RING | JOINT TORIQUE | x 4 |
| CM63P-11325-01A | ANODO | | | ANODE | ANODO | ANODE | 1 |
| REC5GH-13440-00 | FILTRO DE ACEITE | | | OIL FILTER | FILTRO OLIO | FILTRE À HUILE | 1 |
| REC6FP-12411-00 | TERMOSTATO | | | THERMOSTAT | TERMOSTATO | THERMOSTAT | 1 |
| NGKLR6E-9N | BUJÍA | | | SPARK PLUG | CANDELE | BOUGIE | x 4 |
| TENO1165 | ANODO | | | ANODE | ANODO | ANODE | 1 |
| REC6C5-24251-00 | FILTRO COMBUSTIBLE | | | FUEL FILTER | FILTRO COMBUSTIBILE | FILTRE ESSENCE | 1 |
| REC6D8-WS24A-00 | FILTRO COMBUSTIBLE | | | FUEL FILTER | FILTRO COMBUSTIBILE | FILTRE ESSENCE | 1 |
| PAGB/T3452.1-32.5X1.8 | TÓRICA | | | O-RING | O-RING | JOINT TORIQUE | 1 |
| CM6H1-45251-02A | ANODO | | | ANODE | ANODO | ANODE | 1 |
| PAF15-04000003 | ARANDELA | | | WHASER | RONDELLA | RONDELLE | 1 |
| REC90430-08020 | JUNTA DESAGÜE | | | DRAIN GASKET | GUARNIZIONE DRENAGGIO | JOINT DE VIDANGE | x 2 |
| CM6E5-45371-01A | ANODO | | | ANODE | ANODO | ANODE | 1 |
| REC91490-40030 | PIN BLOQUEADOR | | | COTTER PIN | COPPIGLIA | GOUPILLE | 1 |
| REC68V-W0078-00 | KIT BOMBA DE AGUA | | | WATER PUMP REPAIR KIT | KIT POMPA DELL'ACQUA | KIT POMPE À EAU | 1 |
|  | RECKITF115A | | | CM15026A | ANODO | ANODE | ANODO |
| | | REC5GH-13440-00 | FILTRO DE ACEITE | OIL FILTER | FILTRO OLIO | FILTRE À HUILE | 1 |
| | | CM67F-11325-01A | ANODO | ANODE | ANODO | ANODE | x 3 |
| | | REC60V-12411-00 | TERMOSTATO | THERMOSTAT | TERMOSTATO | THERMOSTAT | 1 |
| | | NGKLF6A-11 | BUJÍA | SPARK PLUG | CANDELE | BOUGIE | x 4 |
| | | REC6CB-24501-01 | FILTRO COMBUSTIBLE | FUEL FILTER | FILTRO COMBUSTIBILE | FILTRE ESSENCE | 1 |
| | | REC6CB-13016-00 | TÓRICA | O-RING | O-RING | JOINT TORIQUE | 1 |
| | | REC63P-13915-00 | FILTRO COMBUSTIBLE | FUEL FILTER | FILTRO COMBUSTIBILE | FILTRE ESSENCE | 1 |
| | | REC6CB-14984-00 | TÓRICA | O-RING | O-RING | JOINT TORIQUE | 1 |
| | | CM6G5-45251-01A | ANODO | ANODE | ANODO | ANODE | 1 |
| | | REC6D8-WS24A-00 | FILTRO COMBUSTIBLE | FUEL FILTER | FILTRO COMBUSTIBILE | FILTRE ESSENCE | 1 |
| | | PAGB/T3452.1-32.5X1.8 | TÓRICA | O-RING | O-RING | JOINT TORIQUE | 1 |
| | | PAF15-04000003 | ARANDELA | WHASER | RONDELLA | RONDELLE | 1 |
| | | REC90430-08020 | JUNTA DESAGÜE | DRAIN GASKET | GUARNIZIONE DRENAGGIO | JOINT DE VIDANGE | x 2 |
| | | CM6E5-45371-01A | ANODO | ANODE | ANODO | ANODE | 1 |
| | | REC91490-40030 | PIN BLOQUEADOR | COTTER PIN | COPPIGLIA | GOUPILLE | 1 |
| | | REC68V-W0078-00 | KIT BOMBA DE AGUA | WATER PUMP REPAIR KIT | KIT POMPA DELL'ACQUA | KIT POMPE À EAU | 1 |

| | KIT | REF | | | | | | |
|---|-----------------|-------------------|-----------------------|----------------------|-----------------------|-----------------------|-------------------|-----|
|  | RECKITF115B | PAF4-04070003 | ANODO | ANODE | ANODO | ANODE | x 3 | |
| | | F115B (2014+) | PAGB/T3452.1-13X2 | TÓRICA | O-RING | O-RING | JOINT TORIQUE | x 3 |
| | | F130A (2015+) | CM63P-11325-01A | ANODO | ANODE | ANODO | ANODE | 1 |
| | | | REC5GH-13440-00 | FILTRO DE ACEITE | OIL FILTER | FILTRO OLIO | FILTRE À HUILE | 1 |
| | | | CM67F-11325-01A | ANODO | ANODE | ANODO | ANODE | 1 |
| | | | NGKLR6E | BUJÍA | SPARK PLUG | CANDELE | BOUGIE | x 4 |
| | | | REC6CB-13016-00 | TÓRICA | O-RING | O-RING | JOINT TORIQUE | 1 |
| | | | REC63P-13915-00 | FILTRO COMBUSTIBLE | FUEL FILTER | FILTRO COMBUSTIBILE | FILTRE ESSENCE | 1 |
| | | | REC6CB-14984-00 | TÓRICA | O-RING | O-RING | JOINT TORIQUE | 1 |
| | | | REC6D8-WS24A-00 | FILTRO COMBUSTIBLE | FUEL FILTER | FILTRO COMBUSTIBILE | FILTRE ESSENCE | 1 |
| | | | PAGB/T3452.1-32.5X1.8 | TÓRICA | O-RING | O-RING | JOINT TORIQUE | 1 |
| | | | CM6H1-45251-02A | ANODO | ANODE | ANODO | ANODE | 1 |
| | | | PAF15-04000003 | ARANDELA | WHASER | RONDELLA | RONDELLE | 1 |
| | | | REC90430-08020 | JUNTA DESAGÜE | DRAIN GASKET | GUARNIZIONE DRENAGGIO | JOINT DE VIDANGE | x 2 |
| | | | CM6E5-45371-01A | ANODO | ANODE | ANODO | ANODE | 1 |
| | | | REC91490-40030 | PIN BLOQUEADOR | COTTER PIN | COPPIGLIA | GOUPILLE | 1 |
| | | | REC68V-W0078-00 | KIT BOMBA DE AGUA | WATER PUMP REPAIR KIT | KIT POMPA DELL'ACQUA | KIT POMPE À EAU | 1 |
|  | RECKITF150RR | CM63P-11325-11A | ANODO | ANODE | ANODO | ANODE | x 4 | |
| | | F150A (2003+) | CM63P-11325-01A | ANODO | ANODE | ANODO | ANODE | 1 |
| | | F150B (2012+) | CM67F-11325-01A | ANODO | ANODE | ANODO | ANODE | x 3 |
| | | F150D (2015+) | NGKLR5A-11 | BUJÍA | SPARK PLUG | CANDELE | BOUGIE | x 4 |
| | | F150F (2015+) | CM68T-11325-00A | ANODO | ANODE | ANODO | ANODE | x 8 |
| | | REGULAR ROTATION | REC67F-12411-01 | TERMOSTATO | THERMOSTAT | TERMOSTATO | THERMOSTAT | 1 |
| | | | REC63P-12414-00 | JUNTA | GASKET | GUARNIZIONE | JOINT | 1 |
| | | | REC35-822626Q15 | FILTRO DE ACEITE | OIL FILTER | FILTRO OLIO | FILTRE À HUILE | 1 |
| | | | REC63P-14984-00 | TÓRICA VST | VST O-RING | O-RING VST | JOINT TORIQUE VST | 1 |
| | | | REC63P-13915-00 | FILTRO COMBUSTIBLE | FUEL FILTER | FILTRO COMBUSTIBILE | FILTRE ESSENCE | 1 |
| | | | REC65L-24563-00 | FILTRO COMBUSTIBLE | FUEL FILTER | FILTRO COMBUSTIBILE | FILTRE ESSENCE | 1 |
| | | | REC69J-24501-10 | FILTRO COMBUSTIBLE | FUEL FILTER | FILTRO COMBUSTIBILE | FILTRE ESSENCE | 1 |
| | | | REC6P3-WS24A-00 | FILTRO COMBUSTIBLE | FUEL FILTER | FILTRO COMBUSTIBILE | FILTRE ESSENCE | 1 |
| | | | REC6P3-24564-00 | TÓRICA | O-RING | O-RING | JOINT TORIQUE | 1 |
| | | | PAF15-04000003 | ARANDELA | WHASER | RONDELLA | RONDELLE | 1 |
| | | | REC90430-08020 | JUNTA DESAGÜE | DRAIN GASKET | GUARNIZIONE DRENAGGIO | JOINT DE VIDANGE | x 2 |
| | | | REC61A-W0078-A1 | KIT BOMBA DE AGUA | WATER PUMP REPAIR KIT | KIT POMPA DELL'ACQUA | KIT POMPE À EAU | 1 |
| | REC91490-40030 | PIN BLOQUEADOR | COTTER PIN | COPPIGLIA | GOUPILLE | 1 | | |
| | CMY150KITA | KIT ÁNODOS | KIT ANODES | KIT ANODI | KIT ANODES | 1 | | |
|  | RECKITF150CR | TEN01165 | ANODO | ANODE | ANODO | ANODE | 1 | |
| | | F150A (2003+) | CM63P-11325-11A | ANODO | ANODE | ANODO | ANODE | x 4 |
| | | F150B (2012+) | CM63P-11325-01A | ANODO | ANODE | ANODO | ANODE | 1 |
| | | F150D (2015+) | CM67F-11325-01A | ANODO | ANODE | ANODO | ANODE | x 3 |
| | | F150F (2015+) | NGKLR5A-11 | BUJÍA | SPARK PLUG | CANDELE | BOUGIE | x 4 |
| | | COUNTER ROTATION | CM68T-11325-00A | ANODO | ANODE | ANODO | ANODE | x 8 |
| | | | REC67F-12411-01 | TERMOSTATO | THERMOSTAT | TERMOSTATO | THERMOSTAT | 1 |
| | | | REC63P-12414-00 | JUNTA | GASKET | GUARNIZIONE | JOINT | 1 |
| | | | REC35-822626Q15 | FILTRO DE ACEITE | OIL FILTER | FILTRO OLIO | FILTRE À HUILE | 1 |
| | | | REC63P-14984-00 | TÓRICA VST | VST O-RING | O-RING VST | JOINT TORIQUE VST | 1 |
| | | | REC63P-13915-00 | FILTRO COMBUSTIBLE | FUEL FILTER | FILTRO COMBUSTIBILE | FILTRE ESSENCE | 1 |
| | | | REC65L-24563-00 | FILTRO COMBUSTIBLE | FUEL FILTER | FILTRO COMBUSTIBILE | FILTRE ESSENCE | 1 |
| | | | REC69J-24501-10 | FILTRO COMBUSTIBLE | FUEL FILTER | FILTRO COMBUSTIBILE | FILTRE ESSENCE | 1 |
| | | | REC6P3-WS24A-00 | FILTRO COMBUSTIBLE | FUEL FILTER | FILTRO COMBUSTIBILE | FILTRE ESSENCE | 1 |
| | | | REC6P3-24564-00 | TÓRICA | O-RING | O-RING | JOINT TORIQUE | 1 |
| | | | PAF15-04000003 | ARANDELA | WHASER | RONDELLA | RONDELLE | 1 |
| | | | REC90430-08020 | JUNTA DESAGÜE | DRAIN GASKET | GUARNIZIONE DRENAGGIO | JOINT DE VIDANGE | x 2 |
| | REC61A-W0078-A1 | KIT BOMBA DE AGUA | WATER PUMP REPAIR KIT | KIT POMPA DELL'ACQUA | KIT POMPE À EAU | 1 | | |
| | REC91490-40030 | PIN BLOQUEADOR | COTTER PIN | COPPIGLIA | GOUPILLE | 1 | | |
| | CMY150CRKITA | KIT ÁNODOS | KIT ANODES | KIT ANODI | KIT ANODES | 1 | | |



| | KIT | REF | | | | | | | | |
|---|-----------------|---|-----------------|--------------------|-----------------------|-----------------------|-------------------|------------|------------|-----|
|  | RECKITF150G | F150G (2017+) | CM67F-11325-01A | ANODO | ANODE | ANODO | ANODE | x 3 | | |
| | | F175A (2014+) | CM15026A | ANODO | ANODE | ANODO | ANODE | x 2 | | |
| | | F175C (2017+) | CM68T-11325-00A | ANODO | ANODE | ANODO | ANODE | x 2 | | |
| | | F200F (2013+) | REC6DA-12411-01 | TERMOSTATO | THERMOSTAT | TERMOSTATO | THERMOSTAT | 1 | | |
| | | F200G (2013+) | PAF15-04000003 | ARANDELA | WHASER | RONDELLA | RONDELLE | 1 | | |
| | | | REC35-822626Q15 | FILTRO DE ACEITE | OIL FILTER | FILTRO OLIO | FILTRE À HUILE | 1 | | |
| | | | REC6CB-24501-01 | FILTRO COMBUSTIBLE | FUEL FILTER | FILTRO COMBUSTIBILE | FILTRE ESSENCE | 1 | | |
| | | | REC6CB-13016-00 | TÓRICA | O-RING | O-RING | JOINT TORIQUE | 1 | | |
| | | | REC63P-13915-00 | FILTRO COMBUSTIBLE | FUEL FILTER | FILTRO COMBUSTIBILE | FILTRE ESSENCE | 1 | | |
| | | | REC6CB-14984-00 | TÓRICA | O-RING | O-RING | JOINT TORIQUE | 1 | | |
| | | | REC6P3-WS24A-00 | FILTRO COMBUSTIBLE | FUEL FILTER | FILTRO COMBUSTIBILE | FILTRE ESSENCE | 1 | | |
| | | | REC6P3-24564-00 | TÓRICA | O-RING | O-RING | JOINT TORIQUE | 1 | | |
| | | | CM6AW-45251-00A | ANODO | ANODE | ANODO | ANODE | 1 | | |
| | | | REC90430-08020 | JUNTA DESAGÜE | DRAIN GASKET | GUARNIZIONE DRENAGGIO | JOINT DE VIDANGE | x 2 | | |
| | | | CM6J9-45371-01A | ANODO | ANODE | ANODO | ANODE | 1 | | |
| | | | NGKLF6A-11 | BUJÍA | SPARK PLUG | CANDELE | BOUGIE | x 4 | | |
| | | | REC61A-W0078-A1 | KIT BOMBA DE AGUA | WATER PUMP REPAIR KIT | KIT POMPA DELL'ACQUA | KIT POMPE À EAU | 1 | | |
| | REC91490-40030 | PIN BLOQUEADOR | COTTER PIN | COPPIGLIA | GOUPILLE | 1 | | | | |
| | CM6K1-45371-02A | ANODO | ANODE | ANODO | ANODE | 1 | | | | |
|  | RECKITF200A | F200A (2002-07) | REC67F-12411-01 | TERMOSTATO | THERMOSTAT | TERMOSTATO | THERMOSTAT | x 2 | | |
| | | F225A (2002-07) | REC35-822626Q15 | FILTRO DE ACEITE | OIL FILTER | FILTRO OLIO | FILTRE À HUILE | 1 | | |
| | | | CM15026A | ANODO | ANODE | ANODO | ANODE | x 4 | | |
| | | | TEN01156 | ANODO | ANODE | ANODO | ANODE | x 2 | | |
| | | | NGKLF5A-11 | BUJÍA | SPARK PLUG | CANDELE | BOUGIE | x 6 | | |
| | | | CM67F-11325-01A | ÁNODO | ANODE | ANODO | ANODE | x 4 | | |
| | | | REC65L-24563-00 | FILTRO COMBUSTIBLE | FUEL FILTER | FILTRO COMBUSTIBILE | FILTRE ESSENCE | 1 | | |
| | | | REC68V-14984-00 | TÓRICA VST | VST O-RING | O-RING VST | JOINT TORIQUE VST | 1 | | |
| | | | REC68V-13915-00 | FILTRO COMBUSTIBLE | FUEL FILTER | FILTRO COMBUSTIBILE | FILTRE ESSENCE | 1 | | |
| | | | REC69J-24501-10 | FILTRO COMBUSTIBLE | FUEL FILTER | FILTRO COMBUSTIBILE | FILTRE ESSENCE | 1 | | |
| | | | REC6P3-WS24A-00 | FILTRO COMBUSTIBLE | FUEL FILTER | FILTRO COMBUSTIBILE | FILTRE ESSENCE | 1 | | |
| | | | REC6P3-24564-00 | TÓRICA | O-RING | O-RING | JOINT TORIQUE | 1 | | |
| | | | PAF15-04000003 | ARANDELA | WHASER | RONDELLA | RONDELLE | 1 | | |
| | | | CMY200250KITA | KIT ÁNODOS | KIT ANODES | KIT ANODI | KIT ANODES | 1 | | |
| | | | REC90430-08020 | JUNTA DESAGÜE | DRAIN GASKET | GUARNIZIONE DRENAGGIO | JOINT DE VIDANGE | x 2 | | |
| | | | REC91490-40030 | PIN BLOQUEADOR | COTTER PIN | COPPIGLIA | GOUPILLE | 1 | | |
| | | | REC61A-W0078-A1 | KIT BOMBA DE AGUA | WATER PUMP REPAIR KIT | KIT POMPA DELL'ACQUA | KIT POMPE À EAU | 1 | | |
|  | RECKITF200C | F200C (2006-12) | CM15026A | ANODO | ANODE | ANODO | ANODE | x 6 | | |
| | | | REC67F-12411-01 | TERMOSTATO | THERMOSTAT | TERMOSTATO | THERMOSTAT | x 2 | | |
| | | | REC35-822626Q15 | FILTRO DE ACEITE | OIL FILTER | FILTRO OLIO | FILTRE À HUILE | 1 | | |
| | | | TEN01156 | ANODO | ANODE | ANODO | ANODE | x 2 | | |
| | | | NGKLF6A-11 | BUJÍA | SPARK PLUG | CANDELE | BOUGIE | x 6 | | |
| | | | REC63P-13915-00 | FILTRO COMBUSTIBLE | FUEL FILTER | FILTRO COMBUSTIBILE | FILTRE ESSENCE | 1 | | |
| | | | REC6P2-14984-00 | TÓRICA VST | VST O-RING | O-RING VST | JOINT TORIQUE VST | 1 | | |
| | | | REC69J-24501-10 | FILTRO COMBUSTIBLE | FUEL FILTER | FILTRO COMBUSTIBILE | FILTRE ESSENCE | 1 | | |
| | | | REC6P3-WS24A-00 | FILTRO COMBUSTIBLE | FUEL FILTER | FILTRO COMBUSTIBILE | FILTRE ESSENCE | 1 | | |
| | | | REC6P3-24564-00 | TÓRICA | O-RING | O-RING | JOINT TORIQUE | 1 | | |
| | | | PAF15-04000003 | ARANDELA | WHASER | RONDELLA | RONDELLE | 1 | | |
| | | | REC91490-40030 | PIN BLOQUEADOR | COTTER PIN | COPPIGLIA | GOUPILLE | 1 | | |
| | | | REC90430-08020 | JUNTA DESAGÜE | DRAIN GASKET | GUARNIZIONE DRENAGGIO | JOINT DE VIDANGE | x 2 | | |
| | | | CMY200250KITA | KIT ÁNODOS | KIT ANODES | KIT ANODI | KIT ANODES | 1 | | |
| | | | REC61A-W0078-A1 | KIT BOMBA DE AGUA | WATER PUMP REPAIR KIT | KIT POMPA DELL'ACQUA | KIT POMPE À EAU | 1 | | |
| | |  | RECKITF225B | F225B (2012+) | CM15026A | ANODO | ANODE | ANODO | ANODE | x 7 |
| | | | | F200C (2012+) | REC67F-12411-01 | TERMOSTATO | THERMOSTAT | TERMOSTATO | THERMOSTAT | x 2 |
| | REC35-822626Q15 | | | FILTRO DE ACEITE | OIL FILTER | FILTRO OLIO | FILTRE À HUILE | 1 | | |
| | CM67F-11325-01A | | | ÁNODO | ANODE | ANODO | ANODE | x 4 | | |
| | NGKLF6A-11 | | | BUJÍA | SPARK PLUG | CANDELE | BOUGIE | x 6 | | |
| | REC6CB-24501-01 | | | FILTRO COMBUSTIBLE | FUEL FILTER | FILTRO COMBUSTIBILE | FILTRE ESSENCE | 1 | | |
| | REC6CB-13016-00 | | | TÓRICA | O-RING | O-RING | JOINT TORIQUE | 1 | | |
| | REC63P-13915-00 | | | FILTRO COMBUSTIBLE | FUEL FILTER | FILTRO COMBUSTIBILE | FILTRE ESSENCE | 1 | | |
| | REC6P2-14984-00 | | | TÓRICA VST | VST O-RING | O-RING VST | JOINT TORIQUE VST | 1 | | |
| | REC6P3-WS24A-00 | | | FILTRO COMBUSTIBLE | FUEL FILTER | FILTRO COMBUSTIBILE | FILTRE ESSENCE | 1 | | |
| | REC6P3-24564-00 | | | TÓRICA | O-RING | O-RING | JOINT TORIQUE | 1 | | |
| | PAF15-04000003 | | | ARANDELA | WHASER | RONDELLA | RONDELLE | 1 | | |
| | REC91490-40030 | | | PIN BLOQUEADOR | COTTER PIN | COPPIGLIA | GOUPILLE | 1 | | |
| | REC90430-08020 | | | JUNTA DESAGÜE | DRAIN GASKET | GUARNIZIONE DRENAGGIO | JOINT DE VIDANGE | x 2 | | |
| | CMY200250KITA | | | KIT ÁNODOS | KIT ANODES | KIT ANODI | KIT ANODES | 1 | | |
| | REC61A-W0078-A1 | | | KIT BOMBA DE AGUA | WATER PUMP REPAIR KIT | KIT POMPA DELL'ACQUA | KIT POMPE À EAU | 1 | | |

| | KIT | REF | | | | | | |
|---|--------------------|---|-----------------------|---|-----------------------|-------------------|------------|------------|
|  | RECKITF225C | F225C (2009-15) F250A (2006-13) | CM15026A | ANODO | ANODE | ANODO | ANODE | x 7 |
| | | REC67F-12411-01 | TERMOSTATO | THERMOSTAT | TERMOSTATO | THERMOSTAT | x 2 | |
| | | REC35-822626Q15 | FILTRO DE ACEITE | OIL FILTER | FILTRO OLIO | FILTRE À HUILE | 1 | |
| | | CM67F-11325-01A | ANODO | ANODE | ANODO | ANODE | x 4 | |
| | | NGKLF6A-11 | BUJÍA | SPARK PLUG | CANDELE | BOUGIE | x 6 | |
| | | REC6CB-24501-01 | FILTRO COMBUSTIBLE | FUEL FILTER | FILTRO COMBUSTIBILE | FILTRE ESSENCE | 1 | |
| | | REC6CB-13016-00 | TÓRICA | O-RING | O-RING | JOINT TORIQUE | 1 | |
| | | REC63P-13915-00 | FILTRO COMBUSTIBLE | FUEL FILTER | FILTRO COMBUSTIBILE | FILTRE ESSENCE | 1 | |
| | | REC6P2-14984-00 | TÓRICA VST | VST O-RING | O-RING VST | JOINT TORIQUE VST | 1 | |
| | | REC6P3-WS24A-00 | FILTRO COMBUSTIBLE | FUEL FILTER | FILTRO COMBUSTIBILE | FILTRE ESSENCE | 1 | |
| | | REC6P3-24564-00 | TÓRICA | O-RING | O-RING | JOINT TORIQUE | 1 | |
| | | PAF15-04000003 | ARANDELA | WHASER | RONDELLA | RONDELLE | 1 | |
| | | REC91490-40030 | PIN BLOQUEADOR | COTTER PIN | COPPIGLIA | GOUPILLE | 1 | |
| | | REC90430-08020 | JUNTA DESAGÜE | DRAIN GASKET | GUARNIZIONE DRENAGGIO | JOINT DE VIDANGE | x 2 | |
| | | CMY200250KITA | KIT ÁNODOS | KIT ANODES | KIT ANODI | KIT ANODES | 1 | |
| | | REC6P2-W0078-00 | KIT BOMBA DE AGUA | WATER PUMP REPAIR KIT | KIT POMPA DELL'ACQUA | KIT POMPE À EAU | 1 | |
| | |  | RECKITF250D | F225F (2011+) F225B (2009+) F250D (2011+) F300B (2011+) F300C (2018+) | REC6CE-12411-00 | TERMOSTATO | THERMOSTAT | TERMOSTATO |
| TEN01177 | ANODO | | | ANODE | ANODO | ANODE | x 4 | |
| CM68T-11325-00A | ANODO | | | ANODE | ANODO | ANODE | x 2 | |
| TEN01171 | ANODO | | | ANODE | ANODO | ANODE | x 2 | |
| REC6CB-13440-00 | FILTRO DE ACEITE | | | OIL FILTER | FILTRO OLIO | FILTRE À HUILE | 1 | |
| CM67F-11325-01A | ANODO | | | ANODE | ANODO | ANODE | x 8 | |
| NGKLF6A-11 | BUJÍA | | | SPARK PLUG | CANDELE | BOUGIE | x 6 | |
| REC6CB-24501-01 | FILTRO COMBUSTIBLE | | | FUEL FILTER | FILTRO COMBUSTIBILE | FILTRE ESSENCE | 1 | |
| REC6CB-13016-00 | TÓRICA | | | O-RING | O-RING | JOINT TORIQUE | 1 | |
| REC63P-13915-00 | FILTRO COMBUSTIBLE | | | FUEL FILTER | FILTRO COMBUSTIBILE | FILTRE ESSENCE | 1 | |
| REC6CB-14984-00 | TÓRICA VST | | | VST O-RING | O-RING VST | JOINT TORIQUE VST | 1 | |
| REC6P3-24564-00 | TÓRICA | | | O-RING | O-RING | JOINT TORIQUE | 1 | |
| REC6P3-WS24A-00 | FILTRO COMBUSTIBLE | | | FUEL FILTER | FILTRO COMBUSTIBILE | FILTRE ESSENCE | 1 | |
| PAF15-04000003 | ARANDELA | | | WHASER | RONDELLA | RONDELLE | 1 | |
| REC91490-40030 | PIN BLOQUEADOR | | | COTTER PIN | COPPIGLIA | GOUPILLE | 1 | |
| REC90430-08020 | JUNTA DESAGÜE | | | DRAIN GASKET | GUARNIZIONE DRENAGGIO | JOINT DE VIDANGE | x 2 | |
| CMY200250KITA | KIT ÁNODOS | | | KIT ANODES | KIT ANODI | KIT ANODES | 1 | |
| REC6CE-W0078-01 | KIT BOMBA DE AGUA | WATER PUMP REPAIR KIT | KIT POMPA DELL'ACQUA | KIT POMPE À EAU | 1 | | | |
|  | RECKITF300A | F300A (2008-11) | REC6AW-12411-00 | TERMOSTATO | THERMOSTAT | TERMOSTATO | THERMOSTAT | x 2 |
| | | TEN01177 | ANODO | ANODE | ANODO | ANODE | x 8 | |
| | | REC6CB-13440-00 | FILTRO DE ACEITE | OIL FILTER | FILTRO OLIO | FILTRE À HUILE | 1 | |
| | | NGKLF6A-11 | BUJÍA | SPARK PLUG | CANDELE | BOUGIE | x 8 | |
| | | TEN01170 | ANODO | ANODE | ANODO | ANODE | x 2 | |
| | | TEN01173 | ANODO | ANODE | ANODO | ANODE | x 10 | |
| | | TEN01171 | ANODO | ANODE | ANODO | ANODE | x 10 | |
| | | REC63P-13915-00 | FILTRO COMBUSTIBLE | FUEL FILTER | FILTRO COMBUSTIBILE | FILTRE ESSENCE | 1 | |
| | | REC6AW-14984-00 | TÓRICA VST | O-RING VST | O-RING VST | TORIQUE VST | 1 | |
| | | REC6P3-WS24A-00 | FILTRO COMBUSTIBLE | FUEL FILTER | FILTRO COMBUSTIBILE | FILTRE ESSENCE | 1 | |
| | | REC6P3-24564-00 | TÓRICA | O-RING | O-RING | TORIQUE | 1 | |
| | | PAF15-04000003 | ARANDELA | WHASER | RONDELLA | RONDELLE | 1 | |
| | | CMY300350XPKITA | KIT ÁNODOS | KIT ANODES | KIT ANODI | KIT ANODES | 1 | |
| | | REC90430-08020 | JUNTA DESAGÜE | DRAIN GASKET | GUARNIZIONE DRENAGGIO | JOINT DE VIDANGE | x 2 | |
| | | REC91490-40030 | PIN BLOQUEADOR | COTTER PIN | COPPIGLIA | GOUPILLE | 1 | |
| | | REC6AW-W0078-00 | KIT BOMBA DE AGUA | WATER PUMP REPAIR KIT | KIT POMPA DELL'ACQUA | KIT POMPE À EAU | 1 | |
| | |  | RECKITF350A | F350A (2008 +) | REC6AW-12411-00 | TERMOSTATO | THERMOSTAT | TERMOSTATO |
| CM67F-11325-01A | ANODO | | | ANODE | ANODO | ANODE | x 10 | |
| CM63P-11325-01A | ANODO | | | ANODE | ANODO | ANODE | x 3 | |
| NGKLF6A-11 | BUJÍA | | | SPARK PLUG | CANDELE | BOUGIE | x 8 | |
| REC6CB-13440-00 | FILTRO DE ACEITE | | | OIL FILTER | FILTRO OLIO | FILTRE À HUILE | 1 | |
| TEN01172 | ANODO | | | ANODE | ANODO | ANODE | x 2 | |
| TEN01177 | ANODO | | | ANODE | ANODO | ANODE | x 8 | |
| REC6CB-24501-01 | FILTRO COMBUSTIBLE | | | FUEL FILTER | FILTRO COMBUSTIBILE | FILTRE ESSENCE | 1 | |
| REC6CB-13016-00 | TÓRICA VST | | | O-RING VST | O-RING VST | TORIQUE VST | 1 | |
| REC63P-13915-00 | FILTRO COMBUSTIBLE | | | FUEL FILTER | FILTRO COMBUSTIBILE | FILTRE ESSENCE | 1 | |
| REC6CB-14984-00 | TÓRICA VST | | | O-RING VST | O-RING VST | TORIQUE VST | 1 | |
| REC6P3-24564-00 | TÓRICA | | | O-RING | O-RING | TORIQUE | 1 | |
| REC6P3-WS24A-00 | FILTRO COMBUSTIBLE | | | FUEL FILTER | FILTRO COMBUSTIBILE | FILTRE ESSENCE | 1 | |
| CM15026A | ANODO | | | ANODE | ANODO | ANODE | 1 | |
| CMY300350KITA | KIT ÁNODOS | | | KIT ANODES | KIT ANODI | KIT D'ANODES | 1 | |
| TEN01170 | ANODO | | | ANODE | ANODO | ANODE | 1 | |
| TEN01175 | ANODO | | | ANODE | ANODO | ANODE | 1 | |
| TEN01174 | ANODO | ANODE | ANODO | ANODE | 1 | | | |
| CM63P-11325-11A | ANODO | ANODE | ANODO | ANODE | 1 | | | |
| PAF15-04000003 | ARANDELA | WHASER | RONDELLA | RONDELLE | 1 | | | |
| REC90430-08020 | JUNTA DESAGÜE | DRAIN GASKET | GUARNIZIONE DRENAGGIO | JOINT DE VIDANGE | x 2 | | | |
| REC6AW-W0078-00 | KIT BOMBA DE AGUA | WATER PUMP REPAIR KIT | KIT POMPA DELL'ACQUA | KIT POMPE À EAU | 1 | | | |
| REC91490-40030 | PIN BLOQUEADOR | COTTER PIN | COPPIGLIA | GOUPILLE | 1 | | | |

SISTEMA DE ALIMENTACIÓN Y FILTRACIÓN FUEL & FILTRATION SYSTEM

SISTEMA DI ALIMENTAZIONE E FILTRAZIONE SYSTÈME D'ALIMENTATION ET DE FILTRATION

BOMBA DE
COMBUSTIBLE

FUEL PUMP

POMPA BENZINA

POIRE À
CARBURANT

BOMBA DE COMBUSTIBLE

FUEL PUMP

POMPA BENZINA



POIRE À CARBURANT

Fabricada con elastómeros termoplásticos inyectados, resistentes al alcohol y rayos UV.s

Premium quality bulb resistance to alcohol as well as UV and ozone.

Fabbricata con elastomero termoplastico, resistente ai solventi e raggi UV.

Fabriqué avec des élastomères thermo-plastiques injectés, résistant à l'alcool et aux rayons UV.

| REF |  |  |
|---------|---|---|
| GS31187 | 1/4" = 6 mm | 1 |
| GS31090 | 5/16" = 8 mm | 1 |
| GS31095 | 3/8" = 9.5 mm | 1 |



GOLDENSHIP

LÍNEA DE COMBUSTIBLE

FUEL LINE ASSEMBLY

TUBO CARBURANTE



TUYAU CARBURANT

Universal. Manguera resistente al alcohol.

Universal. Alcohol resistant hose.

Universale. Tubo resistente ai solventi.

Universelle. Tuyau résistant à l'alcool.

| REF |  |  |
|------------|---|---|
| GS31096 | 5/16" x 2 m | 1 |
| GS31097 | 3/8" x 2 m | 1 |
| GS31099 | 8 mm x 2 m | 1 |
| SIE18-8013 | 5/16" x 2 m | 1 |
| SIE18-8015 | 3/8" x 2 m | 1 |



SIE18-8013
SIE18-8015

new

| REF | OEM |  |  |
|---------|-----------------|---|---|
| GS31183 | 6Y1-24360-52-00 | 6 mm x 2 m | 1 |
| | 6Y1-24360-52-01 | | |
| | 6Y1-24360-52-02 | | |
| | 6Y1-24360-52-51 | | |
| | 6Y1-24360-52-52 | | |

GOLDENSHIP

new

| REF | OEM |  |  |
|----------------|-----------------|---|---|
| PAF15-09000000 | 6G1-24306-55 | 6 mm x 3m | 1 |
| | 6Y1-24306-55-00 | | |

MANGUERA DE
COMBUSTIBLE

FUEL HOSE

TUBO BENZINA





TUYAU CARBURANT

Manguera «Trident» para líneas de combustible. Con refuerzo termoplástico que le permite excelente flexibilidad y resistencia a los rayos UV. Color gris. Resistente al alcohol. Especialmente indicado para motores fueraborda. Garantía: 3 años

Marine fuel hose (distribution and vent) for outboards. Fuel resistant thermo-plastic formulation with 2 spiral reinforcement provides excellent bendability and resistance to UV, aging and permeation by all marine fuels (gasoline/petrol and diesel) including alcohol blends. Warranty: 3 years

Tubo «Trident» per linea combustibile. Con rinforzo termoplastico che gli permette un'eccellente flessibilità e resistenza ai raggi UV. Colore grigio. Resistente ai solventi. Indicato per i motori fuoribordo. Garanzia: 3 anni

Tuyau «Trident» pour carburant. Avec renfort thermoplastique qui permet une excellente flexibilité et résistance aux rayons UV. Gris. Résistant à l'alcool. Convient particulièrement aux moteurs hors-bord. Garantie: 3 ans

| REF |  |  |  |  |
|-------------|---|---|---|---|
| TRI305-0566 | 5/16" = 7,92 mm | 15 m | 1 | SAEJ1527 |
| TRI305-0386 | 3/8" = 9,53 mm | 15 m | 1 | ISO-8469 B1 CE |



TRIDENT

MADE IN THE USA
CE CERTIFIED

YAMAHA

RECAMBIOS
MARINOS

De goma para diesel y gasolina sin plomo. Ideal para fueraborda. Refuerzos textiles internos. Muy flexible. Contenido aromático 50%

Rubber Hose suitable for loading mineral oils, diesel and unloaded fuel

In gomma per diesel e benzina senza piombo. Ideale per motori fuoribordo. Tessuto interno rinforzato. Molto flessibile.

Caoutchouc pour diesel et essence sans plomb. Idéal pour le hors-bord. Renforts textiles internes. Très flexible

CARBUPOMP/10NL



| REF | Ø (mm) | | | | | |
|---------|--------|--------|-------|---------------|------|-----------|
| GS35031 | 6x12 | 10 bar | 50 mm | -25°C → 80° C | 50 m | ISO R1307 |
| GS35032 | 8x15 | 10 bar | 65 mm | | 50 m | |

H.T. - CARBUPOMP/10NL - WP 10 BAR - R<1M Ø/m - ISO R1307

MUELLE TUBO COMBUSTIBLE

SPRING, FUEL PIPE

MOLLA TUBO COMBUSTIBILE

RESSORT, TUYAU DE CARBURANT

new

| REF | OEM |
|---------------|-------------|
| PAF4-04000030 | 90467-08004 |
| PAF4-05000010 | 90467-13M13 |



ABRAZADERA

CLAMP SMALL

FASCETTE

COLLIER

new

| REF | OEM | |
|-----------------|--------------|------|
| REC650-24351-51 | 650-24351-00 | 6 mm |
| | 650-24351-01 | |
| | 650-24351-50 | |
| | 650-24351-51 | |
| REC6E5-24351-51 | 6E5-24351-00 | 8 mm |
| | 6E5-24351-51 | |



| REF | | |
|--------------------|--------|----|
| REC09401-11425 | 6-8 mm | 1 |
| REC09401-11425BULK | 6-8 mm | 25 |



ADPATADOR LÍNEA DE COMBUSTIBLE

COUPLER

ADATTATORE

RACCORD COUPLEUR

| REF | Ø 11 mm --> Ø 9 mm |
|-----------------|--------------------|
| REC22-8M0001721 | |



COMPONENTES TANQUE Y CONECTORES

FUEL TANK COMPONENTS & CONNECTORS

COMPONENTI SERBATOIO E CONETTORI

COMPOSANTS ET CONNECTEURS DU RÉSERVOIR

TAPÓN CON RESPIRADERO

PLUG WITH BREATHER

SPINA CON RESPIRO

BOUCHON AVEC EVENT

new

| REF | OEM |
|----------------|--------------|
| PAF15-10010000 | 6YJ-24610-01 |
| | 6YJ-24610-00 |



TAPÓN

PLUG

TAPPO

BOUCHON

new

| REF | OEM | |
|---------------|--------------|------------|
| PAF4-04120100 | 67D-24610-00 | F2.5 F4 |
| | 67D-24610-02 | |
| | 67D-24610-03 | |
| | 67D-24610-04 | |
| | 68D-24610-10 | |



RESORTE DE SEGURIDAD PARA TAPÓN

SPRING, PREVENT DESQUAMATING

MOLLA SICURTÀ PER TAPPO

RESSORT DE SÉCURITÉ POUR LE BOUCHON

new

| REF | OEM |
|---------------|--------------|
| PAF4-04120103 | 624-24634-00 |



YAMAHA

RECAMBIOS MARINOS

FILTRO **FILTER** **FILTRO** **FILTRE** new

| REF | OEM |
|---------------|--------------|
| PAF15-1000002 | 6YJ-24167-00 |



MEDIDOR DE COMBUSTIBLE **OLEOMETER ASSY** **MISURATORE DI CARBURANTE** **TUBE D'ASPIRATION POUR RESERVOIR** new

| REF | OEM |
|----------------|--------------|
| PAF15-10020000 | 6YJ-24260-00 |
| PAF15-10000003 | 6YJ-24260-10 |
| | 6Y1-24268-00 |



PAF15-10020000

PAF15-10000003

LLAVE DE CIERRE DE DEPOSITO **KNOB OIL SWITCH** **CHIAVE DE DEPOSITO BLOCCO** **COMMUTATEUR D'HUILE AVEC BOUTON** new

| REF | OEM | Icon |
|-----------------|--------------|------|
| PAF2.6-00000004 | 69M-24575-00 | F2.5 |



CONECTOR DE DEPOSITO **TANK CONNECTOR** **ATTACCO SERBATOIO** **RACCORDS DE RESERVOIR**

Fabricado en latón. Made in machined brass. Fabbricato in ottone. Fait en laiton.

| REF | Icon | Quantity |
|---------|----------|----------|
| GS31068 | 1/4" NPT | 1 |



GOLDENSHIP

Para conectar dos motores a un sólo depósito, o viceversa. To connect two motors to a single tank, or vice versa. Per collegare due motori a un singolo serbatoio o viceversa. Pour connecter deux moteurs à un même réservoir, ou inversement.
 Fabricado en latón. Made in machined brass Fabbricato in ottone. Fait en laiton.

| REF | Icon | Quantity |
|---------|----------|----------|
| GS31069 | 1/4" NPT | 1 |



GOLDENSHIP
MADE IN THE USA

| REF | OEM | Icon | Quantity |
|-----------------|------------------------|---------------|----------|
| GS31074 | 6Y1-24305-05-00 | 6 mm 1/4" | 1 |
| | 6Y1-24305-06, -00 | | |
| | 6YL-24305-01-00 | | |
| | 6G1-24305-00, 01, 02 | | |
| | 6G1-24305-02-00 | | |
| GS31075 | 6G1-24305-03, -00 | 8 mm 5/16" | 1 |
| | 6G1-24305-04, -00 | | |
| | 6G1-24305-05, -00 | | |
| | 6G1-24305-0500 | | |
| | 6Y1-24305-00, -01, -02 | | |
| | 6Y1-24305-05-00 | | |
| | 6Y1-24305-06-00 | | |
| 6YL-24305-01-00 | | | |
| GS31076 | 6E5-24305-05-00 | 10 mm 3/8" | 1 |
| | 6E5-24305-06, -00 | | |
| | 6Y2-24305-05-00 | | |
| | 6Y2-24305-06-00 | | |
| | 6YK-24305-01-00 | | |



GOLDENSHIP
MADE IN THE USA

new

| REF | OEM |  |
|-----------------|--------------|---|
| REC6G1-24304-02 | 6G1-24304-02 | 6 mm |



Conector doble

Double connector

Connettore doppio

Double connecteur

| REF |  |  |
|---------|---|---|
| GS31092 | 8 mm | 1 |





Toma de tanque de combustible.
Fabricado en latón.

Fuel tank connector
Made in machined brass

Filettatura per serbaotio benzina
Fabricato in ottone.

Prise de réservoir de carburant.
Fait en laiton.

| REF |  |  |
|---------|---|---|
| GS31073 | 1/4" NPT | 1 |
| GS31020 | 1/4" NPT | 1 |

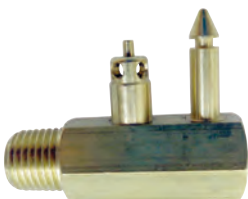

GS31073



GS31020



PASAMAMPAROS

THRU HULL

PASSASCAFO

PASSE-CLOISON

Para atravesar mamparos de hasta 12 mm. Fabricado en latón.

For bulkhead up to 12 mm. Made in machined brass.

Per attraversare paratie fino a 12 mm. Fabricato in ottone.

Pour traverser des cloisons jusqu'à 12 mm. Fait en laiton.

| REF |  |  |
|---------|---|---|
| GS31064 | 3/8" | 1 |



FILTRO DE COMBUSTIBLE Y ELEMENTOS

FUEL FILTERS AND ELEMENTS

FILTRI BENZINA E RACCORDI

FILTRE A ESSENCE ET CARTOUCHE DE RECHANGE

BRACKET

BRACKET

SUPPORTO



TÊTE DE FILTRE À ESSENCE

Con 2 tapones de bronce y 2 tubos de extensión. (2 entradas y 2 salidas).

With 2 brass plugs and 2 extension tubes. (2 inputs & 2 outputs).

Con 2 tappi di bronzo e 2 tubi di estensione. (2 ingressi entrata carburante e 2 uscite carburante).

Avec 2 bouchons en bronze et 2 tubes d'extension. (2 entrées et 2 sorties).

| REF |  |  |
|--------------|---|---|
| REC25000 | 1/4" | AL |
| REC25010 | 1/4" | INOX /SS AISI316 |
| REC25020 | 3/8" | AL |
| REC25030 | 3/8" | INOX /SS AISI316 |
| RECOBBRACKET | 1/4" | Plástico Plastic Plastica Plastique |



REC25000 - REC25020



REC25010 - REC25030



RECOBBRACKET

FILTRO COMBUSTIBLE SEPARADOR DE AGUA

WATER SEPARATING FUEL FILTER

FILTRO SEPARATORE ACQUA-BENZINA

FILTRE À ESSENCE

| REF | MICRON |  |
|-----------------|--------|---|
| REC24942 | 10 | 4 ⁷ / ₁₆ " = 11 cm |
| REC35-802893Q01 | 10 | 3 ³ / ₄ " |
| REC855686 | 28 | 4 ⁷ / ₁₆ " |
| REC35-802893Q | 25 | 3 ³ / ₄ " |
| RACPF5510 | 10 | 4 ⁷ / ₁₆ " |

RACOR

RECMAR



RACPF5510



REC24942



REC35-802893Q01



REC855686



REC35-802893Q

YAMAHA

RECAMBIOS MARINOS

Filtro original.

OEM filter.

Filtro benzina originale.

Filtre à essence original

| REF | MICRON |  |
|--------------|--------|---|
| RM35-802893Q | 10 | 3 3/4" |



FILTRO CON BRACKET

Con 2 tapones de bronce y 1 tubo de extensión.

OEM FILTER WITH BRACKET



With 2 brass plugs & 1 extension tube.

FILTRO BENZINA CON SUPPORTO

Con 2 tappi di bronzo e 1 tubo di estensione.

FILTRE A ESSENCE AVEC SUPPORT

avec 2 bouchons en bronze et 1 tube d'extension

| REF | MICRON |  |  |  |
|----------|--------|---|---|---|
| REC24950 | 25 | 1/4" | 50 GPH | AL |
| REC24952 | 10 | 1/4" | 50 GPH | AL |





FILTRO DECANTADOR DE COMBUSTIBLE COMPLETO CON VASO TRASPARENTE

COMPLET FUEL FILTER WITH TRANSPARENT BOWL

FILTRO DI DECANTAZIONE BENZINA COMPLETO CON VASCHETTA TRASPARENTE

FILTRE SÉPARATEUR D'ESSENCE



| REF | OEM |  |  |
|----------------|--------------|---|---|
| RAC320R-RAC-01 | YMM-2W227-01 | | AL |
| RAC320R-RAC-03 | | RACS3213 | Plástico Plastic Plastica Plastique |

| REF |  |  |  |
|------------|---|---|---|
| RECOFILALU | | | AL |
| RECOFILTER | RECOBELEMENT | 150 l/h | Plástico Plastic Plastica Plastique |



RACOR



| REF | OEM |  | R.O. / OEM | MICRON |  |  |
|----------------|--------------|---|--------------|--------|---|---|
| REC90794-46866 | 907-94469-05 | REC90794-46868 | 907-94469-13 | 10 | 117 l/h | 175 hp |





Ø 8mm

LLAVE PARA FILTRO
FILTER KEY
CHIAVE DA FILTRO
CLÉ A FILTRE



REF
RECYS-225-15



| REF | R.O./OEM | MICRON |  |
|-----------------|--------------|--------|---|
| PAF40-0701000EI | 907-94469-05 | 10 | 70 hp |



new



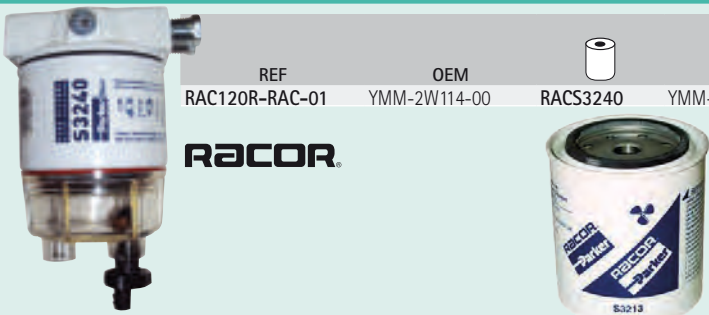

| REF | OEM |  | OEM | MICRON |  |  |
|----------------|--------------|---|--------------|--------|---|---|
| RAC120R-RAC-01 | YMM-2W114-00 | RACS3240 | YMM-2E114-00 | 10 | 114 l/h | 50 -115 hp |

RACOR



new

FILTRO CON BOMBA CEBADORA FILTER WITH PRIMMING PUMP FILTRO CON PEMPETA PER RIEMPIRE FILTRE ESSENCE AVEC POMPE D'AMORCAGE

| REF | OEM |  | OEM | MICRON |  |  |  |
|----------------|--------------|---|------------------|--------|--|---|---|
| RAC490R-RAC-01 | YMM-2W227-01 | RACS3227 | YMM-2E227-00, 01 | 10 | 340 l/h | 3/8" NPTF | 150 hp |

RACOR



LLAVES PARA FILTRO FILTER KEY CHIAVE DA FILTRO CLÉ À FILTRE

| REF |  |
|------------|---|
| RACRK22628 | 65 - 110 mm |

RACOR



RECMAR



RACOR DE LATÓN RACOR MADE IN BRASS RACCORDO IN OTTONE RACCORD EN LAITON

| REF |  |  |  | REF |  |  |  |
|---------|---|---|---|---------|---|---|---|
| GS31065 | 1/4" NPT | 3/8" = 9.5 mm | 1 | GS31066 | 1/4" NPT | 5/16" = 7.9 mm | 2 |
| GS31166 | 1/4" NPT | 5/16" = 7.9 mm | 2 | GS31067 | 1/4" NPT | 3/8" = 9.5 mm | 2 |
| GS31155 | 3/8" NPT | 3/8" = 9.5 mm | 2 | | | | |
| GS31156 | 3/8" NPT | 5/16" = 7.9 mm | 2 | | | | |
| GS31157 | 3/8" NPT | 1/4" = 6.4 mm | 2 | | | | |

GOLDENSHIP



FILTRO COMBUSTIBLE PARA MONTAJE EN LÍNEA

IN-LINE FUEL FILTER

| REF | | | | | GOLDENSHIP |
|---------|---------|---------|-----------------------|---|------------|
| GS31001 | 50 l/h | 6-8 mm | plástico plastic | 1 | |
| GS31002 | 150 l/h | 8-10 mm | plástica plastique | 1 | |



GS31001 GS31002

| REF | | | | GOLDENSHIP |
|---------|-------------|--|---|------------|
| GS30435 | 6, 8, 10 mm | metal + cristal metal + crystal metallo + cristallo métal + cristal | 1 | |



GS30435

| REF | OEM | | | |
|----------|--------------|-------|-------|-----------|
| REC40145 | 65W-24251-10 | 1/4" | 1/4" | plástico |
| REC40155 | | 5/16" | 5/16" | plastic |
| REC40165 | 67F-24251-02 | 3/8" | 3/8" | plástica |
| REC40135 | | 5/16" | 3/8" | plastique |



| REF | OEM | |
|---------------|--------------|--|
| PAF4-04120005 | 6L5-24251-00 | |



| REF | OEM | | |
|---------------|--------------|------|--|
| REC35-80365M | 646-24251-02 | 6 mm | |
| PAF4-05000300 | 646-24251-01 | | |



| REF | OEM | | |
|-----------------|--|-------------------|--|
| REC68T-24251-00 | 68T-24251-00 68T-24251-01 6EE-F4251-00 | F6, F8 (2001+) | |



| REF | OEM | | |
|-----------------|------------------------------|--------|--|
| REC6F5-24563-00 | 6F5-24563-00 | 9.9 hp | |
| REC61N-24563-10 | 61N-24563-10 61n-24563-00 | | |

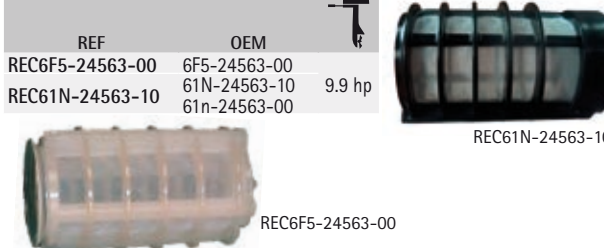

REC6F5-24563-00 REC61N-24563-10

| REF | OEM | | | | |
|-----------------|--|-----------------|----------------|-------|---------------|
| REC6D8-24560-08 | 6D8-24560-08 6D8-24560-09 68V-24560-01 68V-24560-00 | REC68V-24563-00 | REC93210-32738 | 5/16" | F60 - F115 HP |



FILTRO BENZINA PER MONTARE IN LINEA

FILTRE A ESSENCE EN LIGNE

| REF | OEM | | |
|----------------|--------------|------------|--|
| PAF15-07080000 | 61N-24560-00 | 15 - 60 hp | |
| PAF15-07080002 | 61N-24521-00 | | plástico plastic plástica plastique |



| REF | OEM | |
|-----------------|------------------------------|--|
| REC64J-24560-10 | 64J-24560-00 64J-24560-10 | |
| E75, 75AE, AET | (2003-15) | |
| 85 AED, AET | (2003-15) | |
| F40 | (2002-07) | |
| T50, FT50, F50 | (2001-16) | |
| T60, FT60, F60 | (2002-07) | |



| REF | OEM | |
|-----------------|---------------|--|
| REC6BG-13915-00 | 6BG-13915-00 | |
| F30 (2013) | F75 (2005-13) | |
| F40 (2008-13) | F90 (2005-13) | |
| F50 (2005-13) | T50 (2005-13) | |
| F60 (2005-13) | T60 (2005-13) | |
| F70 (2010-13) | | |



| REF | OEM | |
|-----------------|--------------|--|
| REC6C5-24251-00 | 6C5-24251-00 | |
| F30 (2009+) | F75 (2005) | |
| F40 (2006+) | F80 (2008+) | |
| F50 (2005+) | F100 (2005+) | |
| F60 (2005+) | F115 (2014+) | |
| F70 (2011+) | F130 (2015+) | |







| REF | OEM | |
|-----------------|--------------|--|
| REC68V-24563-00 | 68V-24563-00 | |
| EUROPE | F80 | |
| F40 | F100 | |
| F50 | F115 | |



| REF | OEM | |
|-----------------|------------------------------|--|
| REC6D8-WS24A-00 | 6D8-WS24A-00 6D8-24563-00 | |
| F50 - F115 | | |





new

| REF | OEM |  |  |  |  |
|-----------------|--------------|---|---|---|---|
| REC6R3-24560-00 | 6R3-24560-00 | REC61N-24563-10 | REC93210-32738 | 5/16" | 115 -225 HP |



new

| REF | OEM |
|-----------------|--------------|
| REC68F-24563-10 | 68F-24563-10 |



 150-300HP (2004-06)
Z, VZ, LZ

| REF | OEM |
|-----------------|--------------|
| REC65L-24563-00 | 65L-24563-00 |

 F200 (2002-06)
F150 (2004-06)
225FETO (2003)
L/250B (1997-2003)



| REF | OEM |
|-----------------|--------------|
| REC6C5-13915-00 | 6C5-13915-00 |

 F50 (2005-13)
F60 (2005-13)
F70 (2010-13)
F75 (2005-13)

F90 (2005-13)
T50 (2005-13)
T60 (2005-13)





| REF | OEM |
|-----------------|------------------------------|
| REC6P2-WS245-00 | 6P2-WS245-00 6P2-24563-00 |

 F (L) 200C
F (L) 250A

new

| REF | OEM |
|-----------------|--------------|
| REC69J-24501-10 | 69J-24501-10 |

 F150-F225 (2006-14)
F250 (2005-14)



| REF | OEM |
|-----------------|--------------|
| REC68F-24563-00 | 68F-24563-00 |

 (L) Z 150P, Q
(L) Z 175 G
(L) Z 200N/P
(L) Z 250 D/F

new

| REF | OEM |
|-----------------|--|
| REC6P3-WS24A-00 | 6P3-WS24A-00 6P3-WS24A-01 6P3-24563-00 |

 F150 (2007-11)
Z200 (2007)
Z150/175 (2007)
F225 (2007-11)
F200 (2007-11)

F350 (2008-11)
F250 (2009-11)
Z300 (2007)
F300 (2011)



| REF | OEM |
|-----------------|--------------|
| REC69J-24502-00 | 69J-24502-00 |

 LF/FL/F150A,T,D,B (2005+)
LF/FL/F200A,T,B (2004-11)
LF/FL/F225T,A (2004-11)
F75T, B (2005)
F80B,A (2005+)
F90,T,B,A (2013+)
F100D (2005+)



new

| REF | OEM |
|-----------------|--------------|
| REC6P3-24564-00 | 6P3-24564-00 |



| REF | OEM |
|-----------------|--------------|
| REC61A-24563-00 | 61A-24563-00 |

 V6, 3'1L, D-T





GUÍA FILTROS DE COMBUSTIBLE

FUEL FILTER GUIDE

GUIDA FILTRO BENZINA

GUIDE FILTRE À ESSENCE

|  | REF |
|--|-----------------|
| 3A / F2,5A / F4A | PAF4-04120005 |
| 4A / 5C / 6C / 8C | PAF4-05000300 |
| F4B / F5A / F6A / F6C / F8C / FT8D / F9,9J / FT9,9L | REC68T-24251-00 |
| F9,9C / FT9,9D / F15A / F25A / FT25B (-2004) | REC40145 |
| F9,9C (1001584+) / FT9,9D (1001139+) / F15A (1009198+) / F25A & FT25B (1013331+) (2004+) | REC61N-24563-10 |
| F25G | REC6D8-WS24A-00 |
| F30A / F40B | REC40145 |
| FT50B (-2000) | REC61N-24563-10 |
| FT50B (2001+) | REC68V-24563-00 |
| F60A / FT60B (-2003) | REC68V-24563-00 |
| F60A / FT60B (2004+) | REC61N-24563-10 |
| F60-F115 | REC6D8-24560-08 |
| F50F / FT50G / F60C / FT60D (-2006) | REC68V-24563-00 |
| F50F / FT50G / F60C / FT60D (2007+) | REC6D8-WS24A-00 |
| F30B / F40F / F50H / F60F / FT50J / FT60G / F70A | REC6D8-WS24A-00 |
| F80A / F100A (-2001) | REC40165 |
| F80A / F100A (2002+) | REC61N-24563-10 |
| F80B / F100D / F(L)115A (-2006) | REC68V-24563-00 |
| F80B / F100D / F(L)115A (2007+) / F(L)115B | REC6D8-WS24A-00 |
| F100F | REC6D8-WS24A-00 |

|  | REF |
|---|-----------------|
| F(L)150A / F(L)200A / F200B / F(L)225A(-2006) | REC65L-24563-00 |
| F(L)150A / F(L)200A / F200B / F(L)225A (2007+) | REC6P3-WS24A-00 |
| F(L)200C / F(L)250A (-2006) | REC6P2-WS245-00 |
| F(L)200C / F(L)250A (2007+) | REC6P3-WS24A-00 |
| F(L)225B / F225C / F(L)225F (V6 4,2L) / F(L)250D (V6 4,2L) / F(L)300A / F(L)300B(V6 4,2L) / F(L)350A / F(L)200F / F(L)200G / F175A | REC6P3-WS24A-00 |
| 9,9F / 15F / F15C / F20B / 25N / F25D / FT25F / 30D / 40V / 50G / F50A / 60F / 75C / 90A / 100A / F100B / 115C / (L)130B / (L)150F / 175D / (L)200F / 200G / 225D | REC61N-24563-10 |
| 115B | REC6F5-24563-00 |
| 115-225 HP | REC6R3-24560-00 |
| (L)250A | REC61A-24563-00 |
| 225G / 250B | REC65L-24563-00 |
| (L)Z150P / (L)Z150Q / Z175G / (L)Z200N / Z200P (-2004) | REC68F-24563-00 |
| (L)Z150P / (L)Z150Q / Z175G / (L)Z200N / Z200P (2005-06) | REC68F-24563-10 |
| (L)Z150P / (L)Z150Q / Z175G / (L)Z200N / Z200P (2007+) | REC6P3-WS24A-00 |
| (L)Z250D / Z250F (-2003) | REC68F-24563-00 |
| (L)Z250D / Z250F (2004-06) | REC68F-24563-10 |
| (L)Z250D / Z250F (2007+) | REC6P3-WS24A-00 |
| (L)Z300A (-2006) | REC68F-24563-10 |
| (L)Z300A (2007+) | REC6P3-WS24A-00 |

| FILTRO VST | | VST FILTER | FILTRO VST | FILTRE VST | | | | | | | | | | | | | | | | | | | | | | | | | | | | | | | | | | | | | | | | | | | | | | | | | | | | | | | | | | | |
|--|--------------------------|---|--------------------|--------------------|--------------|--|---|--------------------|-----|-----|---------------------|--------------------|--|--|---------------------|--------------------|--|--|--------------------|--------------------|--|--|--------------------|---|--------------------|--|-----------------|---|--------------------------|-----------------|-------------|-----------------|--------------------|--------------|-----------------|-----------------|--------------------|-----------------|-------------|--|--------------------|--|--|---|----------------|-----------------|--|--|-----------------|-----------------|--|--|-----------------|----------------|--|--|----------------|--|--|--|-------------|--|--|
| <table border="1"> <thead> <tr> <th>REF</th> <th>OEM</th> </tr> </thead> <tbody> <tr> <td>REC68V-13915-00</td> <td>68V-13915-00</td> </tr> </tbody> </table> | | REF | OEM | REC68V-13915-00 | 68V-13915-00 |  | <table border="1"> <thead> <tr> <th>REF</th> <th>OEM</th> </tr> </thead> <tbody> <tr> <td>REC68F-13915-00</td> <td>68F-13915-00</td> </tr> </tbody> </table> | | REF | OEM | REC68F-13915-00 | 68F-13915-00 |  | | | | | | | | | | | | | | | | | | | | | | | | | | | | | | | | | | | | | | | | | | | | | | | | | | |
| REF | OEM | | | | | | | | | | | | | | | | | | | | | | | | | | | | | | | | | | | | | | | | | | | | | | | | | | | | | | | | | | | | | | |
| REC68V-13915-00 | 68V-13915-00 | | | | | | | | | | | | | | | | | | | | | | | | | | | | | | | | | | | | | | | | | | | | | | | | | | | | | | | | | | | | | | |
| REF | OEM | | | | | | | | | | | | | | | | | | | | | | | | | | | | | | | | | | | | | | | | | | | | | | | | | | | | | | | | | | | | | | |
| REC68F-13915-00 | 68F-13915-00 | | | | | | | | | | | | | | | | | | | | | | | | | | | | | | | | | | | | | | | | | | | | | | | | | | | | | | | | | | | | | | |
| <table border="1"> <tbody> <tr> <td></td> <td>F115 (2000-09)</td> <td></td> <td></td> </tr> <tr> <td></td> <td>F200 TXR (2002-09)</td> <td></td> <td></td> </tr> <tr> <td></td> <td>LF200 TXR (2002-09)</td> <td></td> <td></td> </tr> <tr> <td></td> <td>F225 TXR (2002-09)</td> <td></td> <td></td> </tr> <tr> <td></td> <td>F225 TUR (2002-09)</td> <td></td> <td></td> </tr> </tbody> </table> | |  | F115 (2000-09) | | | | F200 TXR (2002-09) | | | | LF200 TXR (2002-09) | | | | F225 TXR (2002-09) | | | | F225 TUR (2002-09) | | | <table border="1"> <tbody> <tr> <td></td> <td>HPDI 150 (2000-05)</td> <td></td> <td></td> </tr> <tr> <td></td> <td>V-Max HPDI 150 (2000-09)</td> <td></td> <td></td> </tr> <tr> <td></td> <td>HPDI 225 (2003-09)</td> <td></td> <td></td> </tr> <tr> <td></td> <td>HPDI 250 (2003-09)</td> <td></td> <td></td> </tr> <tr> <td></td> <td>HPDI 300 (2004-09)</td> <td></td> <td></td> </tr> </tbody> </table> | |  | HPDI 150 (2000-05) | | | | V-Max HPDI 150 (2000-09) | | | | HPDI 225 (2003-09) | | | | HPDI 250 (2003-09) | | | | HPDI 300 (2004-09) | | | | | | | | | | | | | | | | | | | | | | |
|  | F115 (2000-09) | | | | | | | | | | | | | | | | | | | | | | | | | | | | | | | | | | | | | | | | | | | | | | | | | | | | | | | | | | | | | | |
| | F200 TXR (2002-09) | | | | | | | | | | | | | | | | | | | | | | | | | | | | | | | | | | | | | | | | | | | | | | | | | | | | | | | | | | | | | | |
| | LF200 TXR (2002-09) | | | | | | | | | | | | | | | | | | | | | | | | | | | | | | | | | | | | | | | | | | | | | | | | | | | | | | | | | | | | | | |
| | F225 TXR (2002-09) | | | | | | | | | | | | | | | | | | | | | | | | | | | | | | | | | | | | | | | | | | | | | | | | | | | | | | | | | | | | | | |
| | F225 TUR (2002-09) | | | | | | | | | | | | | | | | | | | | | | | | | | | | | | | | | | | | | | | | | | | | | | | | | | | | | | | | | | | | | | |
|  | HPDI 150 (2000-05) | | | | | | | | | | | | | | | | | | | | | | | | | | | | | | | | | | | | | | | | | | | | | | | | | | | | | | | | | | | | | | |
| | V-Max HPDI 150 (2000-09) | | | | | | | | | | | | | | | | | | | | | | | | | | | | | | | | | | | | | | | | | | | | | | | | | | | | | | | | | | | | | | |
| | HPDI 225 (2003-09) | | | | | | | | | | | | | | | | | | | | | | | | | | | | | | | | | | | | | | | | | | | | | | | | | | | | | | | | | | | | | | |
| | HPDI 250 (2003-09) | | | | | | | | | | | | | | | | | | | | | | | | | | | | | | | | | | | | | | | | | | | | | | | | | | | | | | | | | | | | | | |
| | HPDI 300 (2004-09) | | | | | | | | | | | | | | | | | | | | | | | | | | | | | | | | | | | | | | | | | | | | | | | | | | | | | | | | | | | | | | |
| <table border="1"> <thead> <tr> <th>REF</th> <th>OEM</th> </tr> </thead> <tbody> <tr> <td>REC66K-13915-00</td> <td>66K-13915-00</td> </tr> </tbody> </table> | | REF | OEM | REC66K-13915-00 | 66K-13915-00 |  | <table border="1"> <thead> <tr> <th>REF</th> <th>OEM</th> </tr> </thead> <tbody> <tr> <td>REC65L-13915-00</td> <td>665L-13915-00</td> </tr> </tbody> </table> | | REF | OEM | REC65L-13915-00 | 665L-13915-00 |  | | | | | | | | | | | | | | | | | | | | | | | | | | | | | | | | | | | | | | | | | | | | | | | | | | |
| REF | OEM | | | | | | | | | | | | | | | | | | | | | | | | | | | | | | | | | | | | | | | | | | | | | | | | | | | | | | | | | | | | | | |
| REC66K-13915-00 | 66K-13915-00 | | | | | | | | | | | | | | | | | | | | | | | | | | | | | | | | | | | | | | | | | | | | | | | | | | | | | | | | | | | | | | |
| REF | OEM | | | | | | | | | | | | | | | | | | | | | | | | | | | | | | | | | | | | | | | | | | | | | | | | | | | | | | | | | | | | | | |
| REC65L-13915-00 | 665L-13915-00 | | | | | | | | | | | | | | | | | | | | | | | | | | | | | | | | | | | | | | | | | | | | | | | | | | | | | | | | | | | | | | |
| <table border="1"> <tbody> <tr> <td></td> <td>HDX150 (1999-05)</td> <td>LX225 (2000-03)</td> <td></td> </tr> <tr> <td></td> <td>LX150 (1999-01)</td> <td>S225 (1999)</td> <td></td> </tr> <tr> <td></td> <td>PX150 (1999)</td> <td>SX225 (2000-03)</td> <td></td> </tr> <tr> <td></td> <td>SX150 (1999-04)</td> <td>V225 (1999)</td> <td></td> </tr> <tr> <td></td> <td>VX150 (2000-04)</td> <td>VX225 (2000-04)</td> <td></td> </tr> <tr> <td></td> <td>LX200 (1999-01)</td> <td>L250 (1999)</td> <td></td> </tr> <tr> <td></td> <td>SX200 (1999-05)</td> <td>LX250 (2000-03)</td> <td></td> </tr> <tr> <td></td> <td>V200 (1999)</td> <td>SX250 (2000-03)</td> <td></td> </tr> <tr> <td></td> <td>VX200 (2000-05)</td> <td>VX250 (2002-04)</td> <td></td> </tr> <tr> <td></td> <td>L225 (1999)</td> <td></td> <td></td> </tr> </tbody> </table> | |  | HDX150 (1999-05) | LX225 (2000-03) | | | LX150 (1999-01) | S225 (1999) | | | PX150 (1999) | SX225 (2000-03) | | | SX150 (1999-04) | V225 (1999) | | | VX150 (2000-04) | VX225 (2000-04) | | | LX200 (1999-01) | L250 (1999) | | | SX200 (1999-05) | LX250 (2000-03) | | | V200 (1999) | SX250 (2000-03) | | | VX200 (2000-05) | VX250 (2002-04) | | | L225 (1999) | | | <table border="1"> <tbody> <tr> <td></td> <td>L225 (1997-98)</td> <td></td> <td></td> </tr> <tr> <td></td> <td>S225 (1997-98)</td> <td></td> <td></td> </tr> <tr> <td></td> <td>L250 (1997-98)</td> <td></td> <td></td> </tr> <tr> <td></td> <td>V200 (1998)</td> <td></td> <td></td> </tr> <tr> <td></td> <td>V225 (1998)</td> <td></td> <td></td> </tr> </tbody> </table> | |  | L225 (1997-98) | | | | S225 (1997-98) | | | | L250 (1997-98) | | | | V200 (1998) | | | | V225 (1998) | | |
|  | HDX150 (1999-05) | LX225 (2000-03) | | | | | | | | | | | | | | | | | | | | | | | | | | | | | | | | | | | | | | | | | | | | | | | | | | | | | | | | | | | | | |
| | LX150 (1999-01) | S225 (1999) | | | | | | | | | | | | | | | | | | | | | | | | | | | | | | | | | | | | | | | | | | | | | | | | | | | | | | | | | | | | | |
| | PX150 (1999) | SX225 (2000-03) | | | | | | | | | | | | | | | | | | | | | | | | | | | | | | | | | | | | | | | | | | | | | | | | | | | | | | | | | | | | | |
| | SX150 (1999-04) | V225 (1999) | | | | | | | | | | | | | | | | | | | | | | | | | | | | | | | | | | | | | | | | | | | | | | | | | | | | | | | | | | | | | |
| | VX150 (2000-04) | VX225 (2000-04) | | | | | | | | | | | | | | | | | | | | | | | | | | | | | | | | | | | | | | | | | | | | | | | | | | | | | | | | | | | | | |
| | LX200 (1999-01) | L250 (1999) | | | | | | | | | | | | | | | | | | | | | | | | | | | | | | | | | | | | | | | | | | | | | | | | | | | | | | | | | | | | | |
| | SX200 (1999-05) | LX250 (2000-03) | | | | | | | | | | | | | | | | | | | | | | | | | | | | | | | | | | | | | | | | | | | | | | | | | | | | | | | | | | | | | |
| | V200 (1999) | SX250 (2000-03) | | | | | | | | | | | | | | | | | | | | | | | | | | | | | | | | | | | | | | | | | | | | | | | | | | | | | | | | | | | | | |
| | VX200 (2000-05) | VX250 (2002-04) | | | | | | | | | | | | | | | | | | | | | | | | | | | | | | | | | | | | | | | | | | | | | | | | | | | | | | | | | | | | | |
| | L225 (1999) | | | | | | | | | | | | | | | | | | | | | | | | | | | | | | | | | | | | | | | | | | | | | | | | | | | | | | | | | | | | | | |
|  | L225 (1997-98) | | | | | | | | | | | | | | | | | | | | | | | | | | | | | | | | | | | | | | | | | | | | | | | | | | | | | | | | | | | | | | |
| | S225 (1997-98) | | | | | | | | | | | | | | | | | | | | | | | | | | | | | | | | | | | | | | | | | | | | | | | | | | | | | | | | | | | | | | |
| | L250 (1997-98) | | | | | | | | | | | | | | | | | | | | | | | | | | | | | | | | | | | | | | | | | | | | | | | | | | | | | | | | | | | | | | |
| | V200 (1998) | | | | | | | | | | | | | | | | | | | | | | | | | | | | | | | | | | | | | | | | | | | | | | | | | | | | | | | | | | | | | | |
| | V225 (1998) | | | | | | | | | | | | | | | | | | | | | | | | | | | | | | | | | | | | | | | | | | | | | | | | | | | | | | | | | | | | | | |
| <table border="1"> <thead> <tr> <th>REF</th> <th>OEM</th> </tr> </thead> <tbody> <tr> <td>REC63P-13915-00</td> <td>63P-13915-00</td> </tr> </tbody> </table> | | REF | OEM | REC63P-13915-00 | 63P-13915-00 |  | <table border="1"> <thead> <tr> <th>REF</th> <th>OEM</th> </tr> </thead> <tbody> <tr> <td>REC60V-24251-01</td> <td>60V-24251-01</td> </tr> </tbody> </table> | | REF | OEM | REC60V-24251-01 | 60V-24251-01 |  | | | | | | | | | | | | | | | | | | | | | | | | | | | | | | | | | | | | | | | | | | | | | | | | | | |
| REF | OEM | | | | | | | | | | | | | | | | | | | | | | | | | | | | | | | | | | | | | | | | | | | | | | | | | | | | | | | | | | | | | | |
| REC63P-13915-00 | 63P-13915-00 | | | | | | | | | | | | | | | | | | | | | | | | | | | | | | | | | | | | | | | | | | | | | | | | | | | | | | | | | | | | | | |
| REF | OEM | | | | | | | | | | | | | | | | | | | | | | | | | | | | | | | | | | | | | | | | | | | | | | | | | | | | | | | | | | | | | | |
| REC60V-24251-01 | 60V-24251-01 | | | | | | | | | | | | | | | | | | | | | | | | | | | | | | | | | | | | | | | | | | | | | | | | | | | | | | | | | | | | | | |
| <table border="1"> <tbody> <tr> <td></td> <td>F150 TXR (2004-09)</td> <td>F300 TXR (2007-09)</td> <td></td> </tr> <tr> <td></td> <td>F150 TLR (2004-09)</td> <td>F300 TUR (2007-09)</td> <td></td> </tr> <tr> <td></td> <td>F150 TJR (2009)</td> <td>F350 TXR (2007-09)</td> <td></td> </tr> <tr> <td></td> <td>LF150 TXR (2004-09)</td> <td>F350 TUR (2007-09)</td> <td></td> </tr> <tr> <td></td> <td>F250 TXR (2005-09)</td> <td>F225 TLR (2007-09)</td> <td></td> </tr> <tr> <td></td> <td>F250 TUR (2005-09)</td> <td></td> <td></td> </tr> </tbody> </table> | |  | F150 TXR (2004-09) | F300 TXR (2007-09) | | | F150 TLR (2004-09) | F300 TUR (2007-09) | | | F150 TJR (2009) | F350 TXR (2007-09) | | | LF150 TXR (2004-09) | F350 TUR (2007-09) | | | F250 TXR (2005-09) | F225 TLR (2007-09) | | | F250 TUR (2005-09) | | | <table border="1"> <tbody> <tr> <td></td> <td>LZ150 (2005)</td> <td>VZ225 (2005-09)</td> <td></td> </tr> <tr> <td></td> <td>VZ150 (2005-10)</td> <td>LZ250 (2005)</td> <td></td> </tr> <tr> <td></td> <td>Z150 (2005)</td> <td>VZ250 (2005-09)</td> <td></td> </tr> <tr> <td></td> <td>VZ175 (2005-10)</td> <td>Z250 (2005)</td> <td></td> </tr> <tr> <td></td> <td>Z175 (2005)</td> <td>LZ300 (2005-06)</td> <td></td> </tr> <tr> <td></td> <td>LZ200 (2005-10)</td> <td>VZ300 (2005-09)</td> <td></td> </tr> <tr> <td></td> <td>VZ200 (2005-09)</td> <td>Z300 (2005-06)</td> <td></td> </tr> <tr> <td></td> <td>Z200 (2005-10)</td> <td></td> <td></td> </tr> </tbody> </table> | |  | LZ150 (2005) | VZ225 (2005-09) | | | VZ150 (2005-10) | LZ250 (2005) | | | Z150 (2005) | VZ250 (2005-09) | | | VZ175 (2005-10) | Z250 (2005) | | | Z175 (2005) | LZ300 (2005-06) | | | LZ200 (2005-10) | VZ300 (2005-09) | | | VZ200 (2005-09) | Z300 (2005-06) | | | Z200 (2005-10) | | | | | | |
|  | F150 TXR (2004-09) | F300 TXR (2007-09) | | | | | | | | | | | | | | | | | | | | | | | | | | | | | | | | | | | | | | | | | | | | | | | | | | | | | | | | | | | | | |
| | F150 TLR (2004-09) | F300 TUR (2007-09) | | | | | | | | | | | | | | | | | | | | | | | | | | | | | | | | | | | | | | | | | | | | | | | | | | | | | | | | | | | | | |
| | F150 TJR (2009) | F350 TXR (2007-09) | | | | | | | | | | | | | | | | | | | | | | | | | | | | | | | | | | | | | | | | | | | | | | | | | | | | | | | | | | | | | |
| | LF150 TXR (2004-09) | F350 TUR (2007-09) | | | | | | | | | | | | | | | | | | | | | | | | | | | | | | | | | | | | | | | | | | | | | | | | | | | | | | | | | | | | | |
| | F250 TXR (2005-09) | F225 TLR (2007-09) | | | | | | | | | | | | | | | | | | | | | | | | | | | | | | | | | | | | | | | | | | | | | | | | | | | | | | | | | | | | | |
| | F250 TUR (2005-09) | | | | | | | | | | | | | | | | | | | | | | | | | | | | | | | | | | | | | | | | | | | | | | | | | | | | | | | | | | | | | | |
|  | LZ150 (2005) | VZ225 (2005-09) | | | | | | | | | | | | | | | | | | | | | | | | | | | | | | | | | | | | | | | | | | | | | | | | | | | | | | | | | | | | | |
| | VZ150 (2005-10) | LZ250 (2005) | | | | | | | | | | | | | | | | | | | | | | | | | | | | | | | | | | | | | | | | | | | | | | | | | | | | | | | | | | | | | |
| | Z150 (2005) | VZ250 (2005-09) | | | | | | | | | | | | | | | | | | | | | | | | | | | | | | | | | | | | | | | | | | | | | | | | | | | | | | | | | | | | | |
| | VZ175 (2005-10) | Z250 (2005) | | | | | | | | | | | | | | | | | | | | | | | | | | | | | | | | | | | | | | | | | | | | | | | | | | | | | | | | | | | | | |
| | Z175 (2005) | LZ300 (2005-06) | | | | | | | | | | | | | | | | | | | | | | | | | | | | | | | | | | | | | | | | | | | | | | | | | | | | | | | | | | | | | |
| | LZ200 (2005-10) | VZ300 (2005-09) | | | | | | | | | | | | | | | | | | | | | | | | | | | | | | | | | | | | | | | | | | | | | | | | | | | | | | | | | | | | | |
| | VZ200 (2005-09) | Z300 (2005-06) | | | | | | | | | | | | | | | | | | | | | | | | | | | | | | | | | | | | | | | | | | | | | | | | | | | | | | | | | | | | | |
| | Z200 (2005-10) | | | | | | | | | | | | | | | | | | | | | | | | | | | | | | | | | | | | | | | | | | | | | | | | | | | | | | | | | | | | | | |

| GUÍA FILTROS VST | | | FUEL FILTER GUIDE | GUIDA FILTRO BENZINA | GUIDE FILTRES VST | | | |
|---|-----------------|--------------|--|----------------------|-------------------|---|-----------------|--------------|
|  | REF | OEM |  | REF | OEM |  | REF | OEM |
| 3A, F4A | PAF4-04120005 | 6L5-24251-00 | 9.9C/D/F 15C/D/F 20/D/F | | | F80A F100A | REC40165 | 67F-24251-02 |
| 4A, F4A 5C 6C/D 8C, F8B F9.9A/B, FT9.9A HPDI | REC35-80365M | 646-24251-02 | 25B/D/J/N/Q/V 30D/GH 40H/QM/X/Y/F, 40A/B/F 45A/F, 50A/B/FT, 50A, 50D/G/H/PRO, 50 55B 60F 70B 75A/C/PRO | REC61N-24563-10 | 61N-24563-10 | F40C F50F, FT50C/G/F 60A/C/FT, 60B/D/F 80B/F 100D/F(L) 115A | REC68V-24563-00 | 68V-24563-00 |
| FT8D | REC68T-24251-00 | 68T-24251-00 | 80A 85A 90A 100A/PROV, 100/115B/C(L) 130B/D 150H/ (L), 150C/ (L), 150F 175B/D(L) 200B(L), 200F/G/PROV, 200/225B/D (1994) | | | 150A(L) 225C(L) 250A | REC61A-24563-00 | 61A-24563-00 |
| 9.9D 15D 20C/D 25D/J/N/Q 30A/D/G 40H/Q 50D/G 55B 60F 70B 75A 80A 85A 90A 100A 115B/C(L) 130B(L) 150C(L) 175B 200B/PRO 200V 225B, (-1993) | REC6F5-24563-00 | 6F5-24563-00 | FT 9.9D, F9.9C/F 15A/F 20A/F 25A/FT, 25B/F 30A/F 40B | REC40145 | 65W-24251-00 | 225G(L) 250B/F(L) 150A/F(L) 200A/F(L) 225A/F(L) 250A | REC65L-24563-00 | 65L-24563-00 |
| | | | | | | HPDI (Fuel Strainer) | REC60V-24251-01 | 60V-24251-01 |

FILTRO DE ACEITE

OIL FILTER

FILTRO OLIO

FILTRE A HUILE

| REF | OEM |
|----------------------|-----------------------|
| REC61A-13411-00 | 61A-13411-00 |
| Z250TR | Z300 AETO |
| DETO | TXR (2004-07) |
| FETO (2003-07) | L250G-GETOX (2006-10) |
| 250B | |
| AETO (1993-06) | |
| L250B | |
| TXR (2000-03) | |
| 225G-GETOL (1999-03) | |



| REF | OEM |
|------------------|-----------------------|
| REC6E5-13411-00 | 6E5-13411-00 |
| V-Z 200T | Z1200F-FETO (1996-10) |
| PETO | 225D-DETOX (2000-03) |
| TLR (2001-07) | 115 B |
| Z150 F | BET (1988-02) |
| TXRA | 130BETO (1991-01) |
| PETOLX (1996-07) | 115CETO |
| 175D | TLR |
| DETO (1996-03) | TXR (1991-13) |



| REF | OEM |
|------------------------|----------------|
| REC6J8-13411-00 | 6J8-13411-00 |
| 25Q-QEO (1990-94) | FETO |
| 50 | L (1989-13) |
| G-GEO-GETOL (1993-07) | 70BETO |
| 50H-HR-MDO (1996-02) | B |
| 40V-MH-MD | BEMO (1989-13) |
| VETO | 25J |
| VE-O (1995-13) | JEQ |
| 40YETO-YETOL (2005-07) | JETO |
| 30DETOL | NEM |
| DEOS | W (1988-13) |
| MH (2011-13) | 20D |
| GOLTRA | EM-ML |
| F | |



| REF | OEM |
|--------------------|----------------|
| REC68F-13440-00 | 68F-13440-00 |
| LZ | TLR (2001-07) |
| LZ300 | Z250 |
| TR | TXR |
| AETO-X-V (2004-07) | DETO |
| Z175TR | X (2003-07) |
| GETO-X (2002-07) | Z150P |
| V | TXR |
| Z200T | PETO (2000-07) |
| PETO | |





| REF | OEM |
|--------------|--------------|
| REC35-80365M | 646-24251-02 |
| L150 | 115 |
| L200 | 130 |
| 225 | |
| 175 | |
| 250 | |



| REF | OEM |
|-----------------|--------------|
| REC6G8-13440-00 | 6G8-13440-00 |



| REF | OEM |
|-----------------|------------------------------|
| REC5GH-13440-60 | 5GH-13440-60 5GH-13440-50 |

| REF | OEM | |
|-----------------|--------------------------|---------------|
| REC35-822626Q15 | 69J-13440-00, 01, 03 | 3/4" x 16NPT |
| REC5GH-13440-00 | 5GH-13440-00, 30, 70 | 20 x 1.5 |
| REC26-13440-00 | N26-13440-00, 02 | 3/4" x 16 NPT |
| REC3FV-13440-00 | 3FV-13440-00, 10, 20, 30 | 20 x 1.5 |



GUÍA FILTROS DE ACEITE OIL FILTER GUIDE GUIDA FILTRO OLIO GUIDE FILTRE A HUILE

| | REF |
|--|-----|
| F8A | |
| F9,9A/B | |
| FT9,9A (1990+) | |
| F9,9C (2000+) | |
| FT9,9D (2000+) | |
| F15A (2000+) | |
| F20A(2000+) | |
| F25A (2000+)/FT25B | |
| F30A | |
| F40A (2000+)/F40B (2001+) | |
| F50A(1999-05)/F50F(-2005)/FT50B (2000+)/FT50C (-2005)/FT50G (-2005) | |
| F60A (-2005)/F60C(-2005)/FT60B (-2005)/FT60D (-2005) | |
| F80A (2000+)/F80B | |
| F100A (2000+)/F100B/F100D | |
| F(L)115A/F115B/F100F | |
| F15C (2007+) | |
| F20B (2007+) | |
| F25D/G FT25F | |
| F30B | |
| F40F | |
| F50A, FT50C, F50F, FT50G, (2006+) | |
| FT60B, F60A, F60C, FT60D (2006+) | |
| F50H/F60F/FT50J/FT60G | |
| F70A/VX | |
| CRUISER/DELUXE (2008-11) | |
| VX SPORT 08/FX HO/FX HO CRUISER 08 | |
| F9,9C (1998), FT9,9D (1999), F15A (1998), F20A (1998), F25A (1998-99), F40A (1999), F40B (2000), F50A (1995-98), FT50B (1996-99), F80A, F100A (1999) | |
| F(L)150A/F175A/F(L)200A/F(L)200C/F(L)200F/F(L)200G/F(L)225A/F(L)225B/F225C/F(L)250A/F(L)250B/FX SHO/FX SHO CRUISER/FX HO CRUISER/FZR/FZS | |
| F(L)300A/F(L)350A/F(L)225F/F(L)250D/F(L)300B | |

WaveRunner Model Part Number Price
 FX140/FX140 CRUISER/FX160/FX160 CRUISER/FX-H.O CRUISER/FX-HIGH OUTPUT/VX 1100SPORT & DELUXE

BOMBA DE INYECCION DE ACEITE

OIL INJECTION PUMP

POMPA INIEZIONE BENZINA

POMPE D'INJECTION D'HUILE

new

| REF | OEM |
|-----------------|--|
| REC6R4-13200-02 | 6R4-13200-00 6R4-13200-01 6R4-13200-02 |

150 - 200 HP
V6
2T/Strokes



new

| REF | OEM |
|-----------------|--------------|
| REC6E5-81900-01 | 6E5-81900-01 |

2T/Strokes

Instalada en el depósito
Installed in the tank
Installato nel serbatoio
Installé dans le réservoir





ACEITE

OIL



OLIO

HUILES

| REF | OEM |  |  | |
|------------|--------------|--|--|-----------|
| REC2TU6 | YMD-63021-01 | 1 L | 6 | 2 STROKES |
| REC2TU3 | YMD-63021-04 | 5 L | 3 | TC-W3 |
| REC5W40U6 | | 1 L | 6 | SAE 5W40 |
| REC5W40U3 | | 5 L | 3 | |
| REC10W30U6 | YMD-63050-01 | 1 L | 6 | SAE 10W30 |
| REC10W30U3 | YMD-63050-04 | 5 L | 3 | |
| REC10W40U6 | YMD-63060-01 | 1 L | 6 | SAE 10W40 |
| REC10W40U3 | YMD-63060-04 | 5 L | 3 | |
| REC25W40U3 | | 5 L | 3 | SAE 25W40 |





| REF | OEM |  |  | |
|------------------|--------------|---|---|-----------|
| RM92-858026QB1U6 | 92-858026QB1 | 1 L | 6 | 2 STROKES |
| RM92-858027QB1U3 | 92-858027QB1 | 3,8 L | 3 | |
| RM92-8M0086220U6 | 92-8M0086220 | 1 L | 6 | SAE 10W30 |
| RM92-8M0086221U3 | 92-8M0086221 | 4 L | 3 | |



BOMBA DE COMBUSTIBLE

FUEL PUMP

POMPA BENZINA

POMPE À ESSENCE

BOMBA DE COMBUSTIBLE MECANICA

FUEL PUMP MECHANICAL

POMPA BENZINA MECCANICA

POMPE À ESSENCE MECANIQUE

| REF | OEM | 2T STROKES | 4T STROKES |
|----------------|--------------|------------|------------|
| PAF20-05050000 | 6AH-24410-00 | | ✓ |

new

F9.9H (2009+)
F13.5B (2007-09)
F15C,E,M (2007+)
F20B,E,M (2007+)

| REF | OEM | 2T STROKES | 4T STROKES |
|-----------------|--------------|------------|------------|
| REC68V-24410-00 | 68V-24410-00 | | ✓ |

new

F100B (2003-10)
F100C (2001-07)
F90 (2003-04)
F75A, T (2003-04)
F100A (2003-06)
F80A (2002-07)
F115A, TR, J (2000-10)

| REF | OEM | 2T STROKES | 4T STROKES |
|-----------------|-----------------|------------|------------|
| REC6E5-24410-03 | 6E5-24410-01-00 | | ✓ |

V4
V6 (1989-03)

| REF | OEM | 2T STROKES | 4T STROKES |
|----------------|--------------|------------|------------|
| PAF15-07140000 | 66M-24410-11 | | ✓ |

F9.9/13.5/15

| REF | OEM | 2T STROKES | 4T STROKES |
|--------------------|------------------------------|------------|------------|
| REC68T-24410-00-00 | 68T-24410-00 68T-24410-01 | | ✓ |

F6A/B/M (2000-09)
F8C/M/E/D/PF/G (2000+)
F9.9F/M/E/G/J/L (2008+)

| REF | OEM | 2T STROKES | 4T STROKES |
|----------------|--------------|------------|------------|
| PAF25-05130000 | 62Y-24410-04 | | ✓ |

F20/25//30/40/45/50/60

| REF | OEM | 2T STROKES | 4T STROKES |
|---------------|--------------|------------|------------|
| PAF4-04090000 | 67D-24410-03 | | ✓ |

F4

| REF | OEM | 2T STROKES | 4T STROKES |
|-----------------|--|------------|------------|
| REC692-24410-00 | 692-24410-00 6A0-24410-00 6A0-24410-05 6A0-24410-03 6A0-24410-04 | | ✓ |

25-85HP

| REF | OEM | 2T STROKES | 4T STROKES |
|-----------------|--|------------|------------|
| REC6A0-24410-04 | 6A0-24410-00 6A0-24410-01 6A0-24410-02 6A0-24410-03 6A0-24410-04 | | ✓ |

20 - 90 HP (1985-92)

| REF | OEM | 2T STROKES | 4T STROKES |
|-----------------|--------------|------------|------------|
| REC6C5-24410-00 | 6C5-24410-00 | | ✓ |

F30B (2009+)
F40A/D/H/F (2006+)
F50F/T/H/J/G (2005+)
F60A/B/C/D/F/G/T (2005+)

YAMAHA

RECAMBIOS MARINOS

BOMBA DE COMBUSTIBLE ELECTRICA

FUEL PUMP ELECTRIC

| REF | OEM |  | 2T STROKES | 4T STROKES |
|-----------------|--------------|---|------------|------------|
| REC68F-13907-01 | 68F-13907-01 | REC66K-14984-00 | ✓ | |

VZ, Z150 (2000-07)
VZ, Z175 (2001-07)
V, L, Z200 (2000-07)



| REF | OEM |  | 2T STROKES | 4T STROKES |
|-----------------|--|---|------------|------------|
| REC63P-13907-03 | 63P-13907-03 63P-13907-02 63P-13907-01 63P-13907-00 | REC63P-14984-00 | | ✓ |

F150 A/AET/AETU/AETX/AET1/AET2/BET/BETX/DET/DET/DETX
F150 TRC/TXRC/TLRC/TR/TLRD/TLR/TLRF/TRG/TXR/TRF (2004+)



| REF | OEM |  | 2T STROKES | 4T STROKES |
|-----------------|--|---|------------|------------|
| REC69J-13907-03 | 69J-13907-03 69J-13907-02 69J-13907-01 69J-13907-00 69J-13907-04 | REC68V-14984-00 | | ✓ |

F200 A/AETX/AETU
F200 TXRA/TXRB/TXRC/TXRD/TR/TXR/TXRF
F225 A/AETU/AETX/AET/TXRA/TXRB/TXRC/TXRD/TXRF
F225 TXR/TR/TURD/TURC (2002-10)



| REF | OEM |  | 2T STROKES | 4T STROKES |
|-----------------|--|---|------------|------------|
| REC69J-24410-02 | 69J-24410-02 69J-24410-01 69J-24410-00 | REC6P2-14984-00 | | ✓ |

F200 A/AETX/AET/CETX
F200 TXRA/TXRB/TXRC/TXRD/TR/TXR/TXRF
F225 A/AETU/AETX/AET/B/BETU/BETX/CET/CETL
F225 TXRA/TXRB/TXRC/TXRD/TXR/TXRF/TR/TURD/TURC
F250 AET/AETX/AETU/A/BET/BETX/BETU
F250 TXR/TURF/TXRF (2002-11)



| REF | OEM |  | 2T STROKES | 4T STROKES |
|-----------------|------------------------------|---|------------|------------|
| REC6AW-13907-00 | 6AW-13907-00 6P2-13907-00 | REC6AW-14984-00 | | ✓ |

F200 C/ CETX (2006-11)
F225 B /BETX/CET/CETL (2006-11)
F225 BETU/BETX/A/AETU/AETX/TURF/TRG/TXRF (2006-11)
F250 A/B/T (2006-11)
F350 AET/AETU/AETX/TRG/TURG (2008-11)



POMPA BENZINA ELETTRICA

POMPE À ESSENCE ELECTRIQUE

| REF | OEM |  | 2T STROKES | 4T STROKES |
|-----------------|------------------------------|---|------------|------------|
| REC66K-13907-00 | 66K-13907-00 65L-13907-00 | REC66K-14984-00 | ✓ | |

225G (1999-02)
250BETO (1997-02)
L/SX250 TXR (2000-02)
225FETO/FETOX (2003)



| REF | OEM |  | 2T STROKES | 4T STROKES |
|-----------------|--------------|---|------------|------------|
| REC67H-13907-00 | 67H-13907-00 | REC66K-14984-00 | ✓ | |

225G/GETOL/FETO (2002-04)
250B/BETO/TXRA (2002-04)



| REF | OEM |  | 2T STROKES | 4T STROKES |
|-----------------|--------------|---|------------|------------|
| REC60V-13907-00 | 60V-13907-00 | REC66K-14984-00 | ✓ | |

Z, LZ 250 (2003-07)
Z, LZ 300 (2003-07)



| REF | OEM |  | 2T STROKES | 4T STROKES |
|-----------------|--|---|------------|------------|
| REC68V-13907-00 | 68V-13907-00 68V-13907-01 68V-13907-02 68V-13907-03 68V-13907-04 | REC68V-14984-00 | ✓ | ✓ |

Z, LZ 250DET/TR/FET (2003-07)
Z, LZ 300AET/TR/TX (2004-07)
LF/FL/F115A,T (2000-06)



| REF | OEM |  | 2T STROKES | 4T STROKES |
|--------------|--------------|---|------------|------------|
| REC866169T01 | 6C5-13907-00 | REC6C5-14984-00 | ✓ | |

F40D/G/H (2006+)
T/FT/F50F/H/T (2005+)
T/FT/F60A/B/C/F/T (2005+)
F70A (2011+)
F75C/T (2005-09)
F80A/B/C (2005+)
F90A/B/T (2005+)
F100D (2005+)



new

MEMBRANAS Y JUNTAS

DIAPHRAGMS & GASKETS

MEMBRANA E GUARNIZIONI

MEMBRANES ET JOINTS

| REF | OEM |
|-----------------|--------------|
| REC6G1-24411-00 | 6G1-24411-00 |

3-15HP



| REF | OEM |
|----------------|--------------|
| PAF25-05130005 | 62Y-24471-00 |

F25>F80HP



| REF | OEM |
|-----------------|--------------|
| REC6E0-24411-00 | 6E0-24411-00 |

4C/5C/AC



| REF | OEM |
|-----------------|--------------|
| REC663-24411-00 | 663-24411-00 |

25>90HP



| REF | OEM |
|-----------------|--------------|
| REC6E0-24471-00 | 6E0-24471-00 |

4HP



| REF | OEM |
|-----------------|--------------|
| REC6J8-24471-00 | 6J8-24471-00 |

30HP



| REF | OEM |
|-----------------|--------------|
| REC6G1-24471-00 | 6G1-24471-00 |

6-8HP



| REF | OEM |
|-----------------|-----------------|
| REC6E5-24411-00 | 6E5-24411-00-00 |

115/150/175/200HP



| REF | OEM |
|-----------------|--------------|
| REC677-24471-01 | 677-24471-01 |

E8D/9.9D/15D



| REF | OEM |
|-----------------|--------------|
| REC6E5-24471-00 | 6E5-24471-00 |

115>250HP



| REF | OEM |
|-----------------|--------------|
| REC63V-24411-00 | 63V-24411-00 |

9.9
13.5
15HP



| REF | OEM |
|-----------------|--------------|
| REC6G1-24431-01 | 6G1-24431-01 |

3A/MSH
6C/CEM/D/DEM/TRV/MSH/CMH
8C/CEM/TRV/MSH/CMH/MH
9.9F
13.5AWH
15F



| REF | OEM |
|-----------------|--------------|
| REC677-24411-02 | 677-24411-02 |

9.9>15HP



| REF | OEM |
|-----------------|--------------|
| REC6E0-24434-00 | 6G1-24431-01 |

4AC/MSH/AS/A
5C/CS/CMH



| REF | OEM |
|-----------------|--------------|
| REC648-24411-00 | 648-24411-00 |

20>70HP



| REF | OEM |
|-----------------|--------------|
| REC6E0-24435-00 | 6E0-24435-00 |

4AC/MSH/AS/A
5C/CS/CMH



| REF | OEM |
|-----------------|--------------|
| REC692-24411-00 | 692-24411-00 |

20>90HP





| REF | OEM |
|-----------------|--------------|
| REC677-24435-01 | 677-24435-01 |

9.9D
15D

20DM/DEO
25NE/NEMO





| REF | OEM |
|---|--|
| REC648-24434-01 | 648-24434-01 |
|  20C/CM 25Q/D/B/BMH 25V/VE E30HMH 30G/H 40V/VM/VE/YE C40 E40 E40X 40X 50G/GEO/GETO/H/D | 55B/BE 60FEO/FETO/TLR E60H 70B/BETO 75CETO/AE E75B 80A/AE 85A/AE 90A/AEO/AET |





| REF | OEM |
|--|--------------|
| REC650-24431-A0 | 650-24431-A0 |
|  25-300HP | |





| REF | OEM |
|---|--|
| REC648-24435-02 | 648-24435-02 |
|  20C/CM 25Q/D/B/BMH 25V/VE E30HMH 30G/H 40V/VM/VE/YE C40 E40 E40X 40X 50G/GEO/GETO/H/D | 55B/BE 60FEO/FETO/TLR E60H 70B/BETO 75CETO/AE E75B 80A/AE 85A/AE 90A/AEO/AET |



| REF | OEM |
|--|--|
| REC6E5-24435-00 | 6E5-24435-00 |
|  100A/TLR 115A/ETN/BET/B/BICET/ TLR 130BETO 140AETO 150AETO/ETN/FETO 175AETO/DETO/BETO 200AETO/ETN | V200/G/BETO 220AET 225DET/BETO 250AET Z300 |





| REF | OEM |
|--|--|
| REC6E5-24434-02 | 6E5-24434-02 |
|  100A/TLR 115A/ETN/BET/B/BICET/ TLR 130BETO 140AETO 150AETO/ETN/FETO 175AETO/DETO/BETO 200AETO/ETN | V200/G/BETO 220AET 225DET/BETO 250AET Z300 |





JUNTAS VST VST GASKETS GUARNIZIONE VST JOINTS VST

| REF | OEM |
|--|--------------|
| REC68V-14984-00 | 68V-14984-00 |
|  Z, LZ 250DET/TR/FET (2003-07) Z, LZ 300AET/TR/TX (2004-07) LF/FL/F115A,T (2000-06) | |

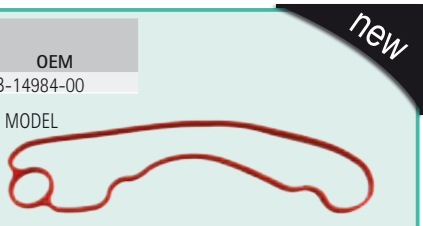

| REF | OEM |
|--|--------------|
| REC6CB-14984-00 | 6CB-14984-00 |
|  F115 + (2012+) NEW MODEL | |





| REF | OEM |
|--|--------------|
| REC63P-14984-00 | 63P-14984-00 |
|  F150 A/AET/AETL/AETX/AET1/AET2/BET/BETX/DET/DET/DETX F150 TRC/TXRC/TLRC/TR/TLRD/TLR/TLRF/TRG/TXR/TRF (2004+) | |



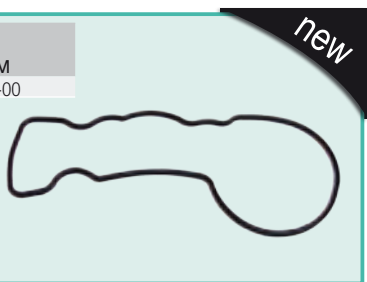

| REF | OEM |
|---|--------------|
| REC6C5-14984-00 | 6C5-14984-00 |
|  F40D/G/H (2006+) T/FT/F50F/H/T (2005+) T/FT/F60A/B/C/F/T (2005+) F70A (2011+) F75C/T (2005-09) F80A/B/C (2005+) F90A/B/T (2005+) F100D (2005+) | |



| REF | OEM |
|--|--------------|
| REC66K-14984-00 | 66K-14984-00 |
|  Z, LZ 250 (2003-07) Z, LZ 300 (2003-07) | |



| REF | OEM |
|--|--------------|
| REC6AW-14984-00 | 6AW-14984-00 |
|  F200 C/ CETX (2006-11) F225 B /BETX/CET/CETL (2006-11) F225 BETU/BETX/A/AETU/AETX/TURF/TRG/ TXRF (2006-11) F350 AET/AETU/AETX/TRG/TURG (2008-11) | |



| REF | OEM |
|--|--------------|
| REC6P2-14984-00 | 62P-14984-00 |
|  F200 A/AETX/AET/CETX F200 TXRA/TXRB/TXRC/TXRD/TR/TXR/TXRF F225 A/AETU/AETX/AET/B/BETU/BETX/CET/CETL F225 TXRA/TXRB/TXRC/TXRD/TXR/TXRF/TR/ TURD/TURC F250 AET/AETX/AETU/A/BET/ BETX/BETU F250 TXR/TURF/TXRF (2002-11) | |

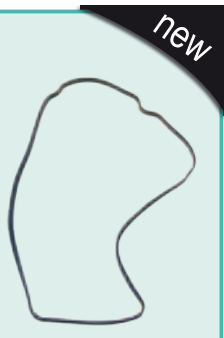

| REF | OEM |
|--|--------------|
| REC6CB-13016-00 | 6CB-13016-00 |
|  F115 + | |

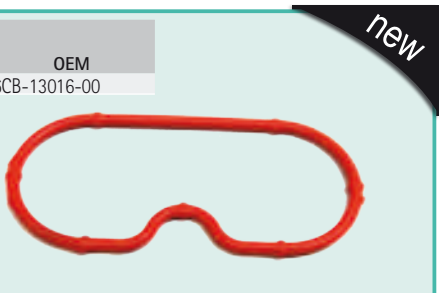

REGULADORES DE PRESION COMBUSTIBLE

FUEL REGULATOR

REGOLATORE BENZINA

REGULATEUR DE PRESSION D'ESSENCE

| REF | OEM |
|-----------------|--------------|
| REC63P-13906-00 | 63P-13906-00 |

F150 (2004+)
63P/64P/6BM/6BN



new

| REF | OEM |
|-----------------|--------------|
| REC6P2-13906-00 | 6P2-13906-00 |

F200 (2006-11)
6AL / 6AM
F225 (2007-11)
6AS/6AT/6BB
F250 (2006-11)
6BR/ 6BS/6P



new

| REF | OEM |
|-----------------|--------------|
| REC69J-13906-00 | 69J-13906-00 |

F200 (2002-07)
60L / 60M
F225 (2005-07)
69J / 69K



new

INYECTORES

INJEKTOR

INIETTORE

INJECTEURS

INJECTOR

INJEKTOR

INIETTORE

INJECTEUR

| REF | OEM |
|-----------------|--------------|
| REC6L5-13761-00 | 65L-13761-00 |



new

| REF | OEM |
|-----------------|--------------|
| REC6D8-13761-00 | 6D8-13761-00 |



new

| REF | OEM |
|-----------------|--------------|
| REC6BG-13761-00 | 6BG-13761-00 |



new

| REF | OEM |
|-----------------|------------------------------|
| REC68V-8A360-00 | 68V-8A360-00 68V-13761-00 |



new

| REF | OEM |
|-----------------|--------------|
| REC6C5-13761-00 | 6C5-13761-00 |



new

| REF | OEM |
|-----------------|--------------|
| REC6P2-13761-00 | 6P2-13761-00 |



new



| REF | OEM |
|-----------------|-----------------|
| REC63P-13761-01 | 63P-13761-00/01 |

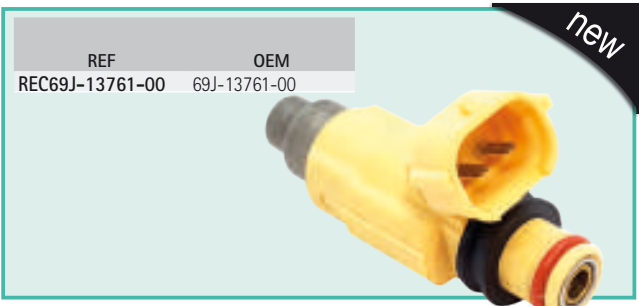

| REF | OEM |
|-----------------|--------------|
| REC69J-13761-00 | 69J-13761-00 |



| REF |
|----------------------|
| STA93008 STA93016 |



| REF |
|---------|
| GE22207 |

| GUÍA INYECTORES Y SENSORES | | GUIDE INJECTORS & SENDERS | | GUIDA INIETTORI E SENSORI | | GUIDE INJECTEURS ET SONDÉS | |
|----------------------------|-------------------|---------------------------|-----------------|---------------------------|--|----------------------------|-----------------|
| | | | | | | TPS | MAP |
| F20 F/G | 6GX & 6HY | 2017+ | REC6FM-13761-00 | | | | |
| F25 G/M | 6FM | 2017+ | REC6FM-13761-00 | | | | |
| F30B | 6BT | 2009+ | REC6BG-13761-00 | | | | |
| F40 A/F | 6BG | 2009 | REC6BG-13761-00 | | | | |
| F40 D/H/G | 6AK & 6CY | 2006+ | REC6C5-13761-00 | | | REC6C5-85885-00 | REC68F-83688-00 |
| F50 F/T/H/G/J | 6C1 & 6C2 | 2005+ | REC6C5-13761-00 | | | REC6C5-85885-00 | REC68F-83688-00 |
| T50 A/B/T | 6C2 | 2005+ | REC6C5-13761-00 | | | REC6C5-85885-00 | REC68F-83688-00 |
| F60 A/B/C/D/E/F/G/T | 6C5 & 6C6 | 2005+ | REC6C5-13761-00 | | | REC6C5-85885-00 | REC68F-83688-00 |
| T60 A/B/T | 6C6 | 2005+ | REC6C5-13761-00 | | | REC6C5-85885-00 | REC68F-83688-00 |
| F70 A | 6CJ | 2011+ | REC6C5-13761-00 | | | REC6C5-85885-00 | REC68F-83688-00 |
| F75 T/B | 6D61 | 2005 | REC6D8-13761-00 | | | REC6C5-85885-00 | REC68F-83688-00 |
| F80 C | 6CK | 2009-12 | REC6D8-13761-00 | | | REC6C5-85885-00 | REC68F-83688-00 |
| F80 B | 6D7 | 2005+ | REC6D8-13761-00 | | | REC6C5-85885-00 | REC68F-83688-00 |
| F100 D | 6D9 | 2005+ | REC6D8-13761-00 | | | REC6C5-85885-00 | REC68F-83688-00 |
| F115 A/T | 68V & 68W | 2000-11 | REC68V-8A360-00 | | | REC68V-85885-00 | REC68V-82380-00 |
| F115A | 68V & 68W | 2012-15 | REC68V-13761-10 | | | REC68V-85885-00 | REC68F-83688-10 |
| F115 B | 6EK & 6EL | 2014+ | REC6EK-13761-00 | | | REC6C5-85885-00 | REC68F-83688-10 |
| F130 A | 6EM | 2015+ | REC6EK-13761-00 | | | | REC68F-83688-10 |
| F150 A/B/C/D/T | 63P & 64P | 2004-05 | REC63P-13761-01 | REC63P-13906-00 | | REC69J-85885-00 | REC63P-82380-00 |
| F150 A/T/B/D | 63P & 64P | 2005+ | REC63P-13761-01 | REC63P-13906-00 | | REC6S1-85885-00 | REC63P-82380-00 |
| F150 B/F | 6BM & 6BN | 2012+ | REC63P-13761-01 | REC63P-13906-00 | | REC6S1-85885-00 | REC63P-82380-00 |
| F150 C/G | 6HP & 6HR | 2017+ | REC6DA-13761-00 | | | | REC68F-83688-10 |
| F175 A/C | 6FA,6HS,6HT | 2014+ | REC6DA-13761-00 | | | | REC68F-83688-10 |
| F200 A/T | 60L & 60M | 2000-05 | REC69J-13761-00 | REC69J-13906-00 | | REC69J-85885-00 | REC68V-82380-00 |
| F200 A/T | 60L & 60M | 2006-07 | REC69J-13761-00 | REC69J-13906-00 | | REC6S1-85885-00 | REC68V-82380-00 |
| F200 C | 6AL & 6AM | 2006 | REC6P2-13761-00 | REC6P2-13906-00 | | | |
| F200 A/B/C | 6AL,6AM,6S19,6S29 | 20012+ | REC6P2-13761-11 | REC6P2-13906-00 | | | |
| F200 B/F | 6DA,6DB,6DV,6DW | 2013+ | REC6DA-13761-00 | | | | REC68F-83688-10 |
| F225 A/T | 69J & 69K | 2000-07 | REC69J-13761-00 | REC69J-13906-00 | | REC69J-85885-00 | REC68V-82380-00 |
| F225 A/B/C | 6AS,6BB & 6AT | 2012-15 | REC6P2-13761-11 | REC6P2-13906-00 | | | |
| F250 A/T | 6P2 & 6P3 | 2006-11 | REC6P2-13761-00 | REC6P2-13906-00 | | | |
| F250 A/T | 6P2 & 6P3 | 2012-13 | REC6P2-13761-11 | REC6P2-13906-00 | | | |
| 225G/F | 250B | 1999-03 | REC6L5-13761-00 | | | | |

CARBURADOR

CARBURATOR

CARBURATORE

CARBURATEUR

CARBURADOR COMPLETO FULL CARBURATOR

CARBURATORE COMPLETO CARBURATEUR COMPLET

| REF | OEM |
|--|--------------|
| REC6F6-14301-06 | 6F6-14301-06 |
|  E40G (2008+) | |





new

| REF | OEM |
|--|--------------|
| REC6B4-14301-00 | 6B4-14301-00 |
|  E15D (2003+) | |



new

| REF | OEM |
|--|--------------|
| PAF2.6-04000200 | 69M-14301-21 |
|  F2.5 ALL (2003+) | |



| REF | OEM |
|--|--------------|
| PAF4-04140000 | 67D-14301-03 |
|  F4 (1998-05) | |



| REF | OEM |
|-----------------|--------------|
| REC6G1-14301-01 | 6G1-14301-01 |

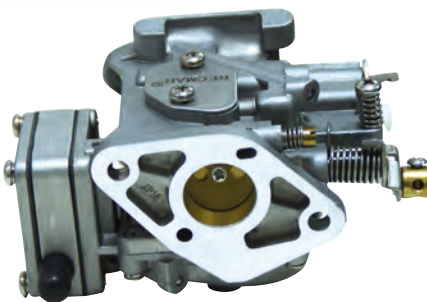

| REF | OEM |
|---|--------------|
| PAF25-05070000 | 65W-14901-12 |
|  F25 ALL (1999-06) | |

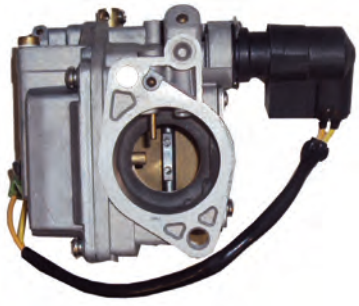



| REF | OEM |
|-----------------|--------------|
| REC61N-14301-04 | 61N-14301-04 |



| REF | OEM |
|-----------------|--------------|
| REC6L5-14301-03 | 6L5-14301-03 |



| REF | OEM | |
|--|--------------|---|
| PAF15-07090000 | 66M-14301-00 | Arranque manual Manual starter Messa in moto manuale Démarrage manuell |
| PAF15-07090000W | 66M-14301-00 | Arranque eléctrico Electric starter Messa in moto elettrica Démarrage électrique |
|  F9.9, F13.5, F15 (1998-07) | | |

PAF15-07090000W

PAF15-07090000

| REF | OEM |
|-----------------|--------------|
| REC6E3-14301-05 | 6E3-14301-05 |



| REF | OEM |
|-----------------|--------------|
| REC66T-14301-60 | 66T-14301-60 |



| REF | OEM |
|-----------------|--------------|
| REC6A1-14301-03 | 6A1-14301-03 |

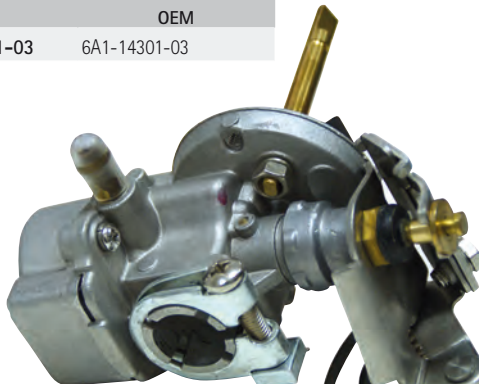

| REF | OEM |
|-----------------|--------------|
| REC63V-14301-00 | 63V-14301-00 |
| REC63W-13610-00 | |

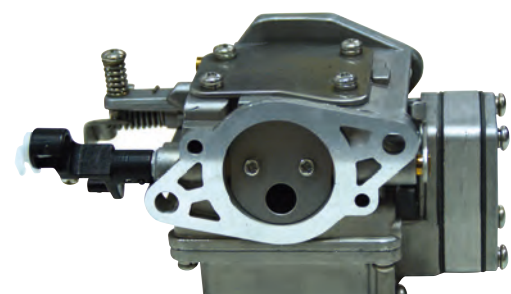



P
99

KIT 3 CARBURADORES

KIT 3 CARBURETORS

KIT 3 CARBURATORI

KIT DE 3 CARBURATEURS

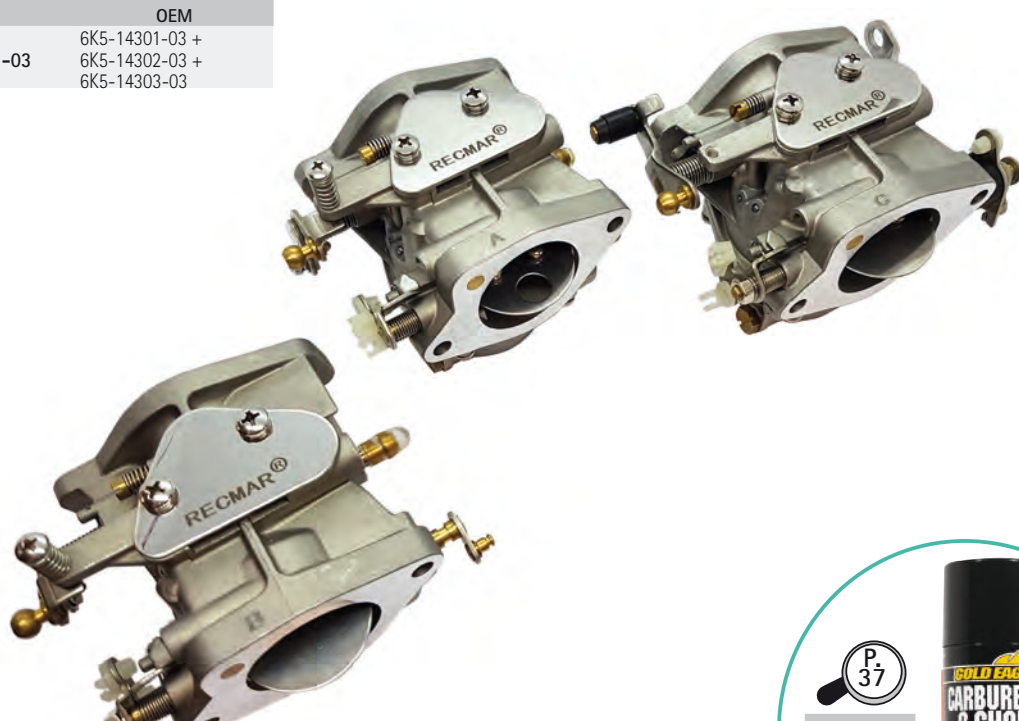

| REF | OEM |
|-----------------|--|
| REC6K5-14301-03 | 6K5-14301-03 + 6K5-14302-03 + 6K5-14303-03 |



P
37

| REF |
|--------|
| GEGC15 |



| | | | CARB | | KIT | |  |  |
|--|------------|---------|-----------------|-----------------|-----------------|-----------------|---|---|
| | | | | | | | | |
| 2B, BMHS, MSHA, MSHB, MSHC, MSHD | 6A1-6A14 | 1985-05 | REC6A1-14301-03 | REC6A1-W0093-01 | | | | |
| 3A, AMHL, MSH | 6L5 | 1988-99 | REC6L5-14301-03 | REC6G1-W0093-00 | REC6G1-14985-00 | REC6G1-14546-00 | | |
| 3A, AMHS, AMHL, AMH, MSHA, MSHB | 6L50-6L59 | 2001-10 | REC6L5-14301-03 | REC6G1-W0093-00 | REC6G1-14985-00 | REC6G1-14546-00 | | |
| AMH, AMHS | 6L5A-6L5F | 2011-15 | REC6L5-14301-03 | REC6G1-W0093-00 | REC6G1-14985-00 | REC6G1-14546-00 | | |
| 4AS | -6,00E+001 | 1994-95 | REC6E3-14301-05 | | REC6E7-14385-00 | | | |
| 4AC | -6,00E+000 | 1994-98 | REC6E3-14301-05 | | REC6E7-14385-00 | | | |
| 4CMHS, CMHL | 6GP1 | 2016 | REC6E3-14301-05 | | REC6E7-14385-00 | | | |
| 5C | -6,00E+003 | 1986-99 | REC6E3-14301-05 | | REC6E7-14385-00 | | | |
| 5CS | -6,00E+004 | 1987-95 | REC6E3-14301-05 | | REC6E7-14385-00 | | | |
| 5CMH | 6M0 | 1994 | REC6E3-14301-05 | | REC6E7-14385-00 | | | |
| 5C, CMHS, CMHL | 6E30-6E39 | 2001-10 | REC6E3-14301-05 | | REC6E7-14385-00 | | | |
| 5CMH, CMHS, CMHL | 6E3A-6E3F | 2011-15 | REC6E3-14301-05 | | REC6E7-14385-00 | | | |
| 6C, CEM | 6H6 | 1984-96 | REC6G1-14301-01 | REC6G1-W0093-00 | REC6G1-14985-00 | REC6G1-14546-00 | | |
| 6D, DEM | 6H8 | 1984-96 | REC6G1-14301-01 | REC6G1-W0093-00 | REC6G1-14985-00 | REC6G1-14546-00 | | |
| 6J | 6H6 | 1986 | REC6G1-14301-01 | REC6G1-W0093-00 | REC6G1-14985-00 | REC6G1-14546-00 | | |
| 6C, MSH, TRV | 6M8 | 1997-98 | REC6G1-14301-01 | REC6G1-W0093-00 | REC6G1-14985-00 | REC6G1-14546-00 | | |
| 6C | 6M80 | 2001 | REC6G1-14301-01 | REC6G1-W0093-00 | REC6G1-14985-00 | REC6G1-14546-00 | | |
| 6D | 6M90-6M91 | 2001-02 | REC6G1-14301-01 | REC6G1-W0093-00 | REC6G1-14985-00 | REC6G1-14546-00 | | |
| 6CMH, CMHS, CMHL, MSHA, MSHB, MSHG, MSHD, MH, MHL, CWH | 6M81-6M89 | 2002-10 | REC6G1-14301-01 | REC6G1-W0093-00 | REC6G1-14985-00 | REC6G1-14546-00 | | |
| CMH, CMHL, CM, MH | 6M8A-6M8B | 2010-12 | REC6G1-14301-01 | REC6G1-W0093-00 | REC6G1-14985-00 | REC6G1-14546-00 | | |
| 8N | 6G1 | 1984 | REC6G1-14301-01 | REC6G1-W0093-00 | REC6G1-14985-00 | REC6G1-14546-00 | | |
| 8C, CEM | 6G1 | 1984-95 | REC6G1-14301-01 | REC6G1-W0093-00 | REC6G1-14985-00 | REC6G1-14546-00 | | |
| 8J | 6G1 | 1986 | REC6G1-14301-01 | REC6G1-W0093-00 | REC6G1-14985-00 | REC6G1-14546-00 | | |
| 8C, TRV, MSH | 6N0 | 1997-98 | REC6G1-14301-01 | REC6G1-W0093-00 | REC6G1-14985-00 | REC6G1-14546-00 | | |
| 8C, MSHZ, MSHA | 6N00-6N09 | 2001-10 | REC6G1-14301-01 | REC6G1-W0093-00 | REC6G1-14985-00 | REC6G1-14546-00 | | |
| 8CMH, CMHS, CMHL | 6N0A-6N0C | 2011-12 | REC6G1-14301-01 | REC6G1-W0093-00 | REC6G1-14985-00 | REC6G1-14546-00 | | |
| 9.9FMH, FMHS, FMHL, FEMH, MHW, MSH, MSHZ, MSHA, MSHB, MSHC | 63V-63V9 | 1995-10 | REC63V-14301-00 | REC63V-W0093-00 | REC63V-14985-00 | REC6G1-14546-00 | | |
| FMH, FMHS, FMHL, MH | 63VA-63VJ | 2011-16 | REC63V-14301-00 | REC63V-W0093-00 | REC63V-14985-00 | REC6G1-14546-00 | | |
| 13.5AWH | 63V | 1998 | REC63V-14301-00 | REC63V-W0093-00 | REC63V-14985-00 | REC6G1-14546-00 | | |
| 13.5AMH, AMHS, AMHL | 66S1-66S2 | 2003-04 | REC63V-14301-00 | REC63V-W0093-00 | REC63V-14985-00 | REC6G1-14546-00 | | |
| 15F.FEMH, FMHS, MHW, MSH, MSHA | 63W-63W1 | 1995-02 | REC63V-14301-00 | REC63V-W0093-00 | REC63V-14985-00 | REC6G1-14546-00 | | |
| E15CMHS | 65F2 | 2003 | REC63V-14301-00 | REC63V-W0093-00 | REC63V-14985-00 | REC6G1-14546-00 | | |
| E15D | 6B4 | 2003+ | REC6B4-14301-00 | REC63V-W0093-00 | REC63V-14985-00 | REC6G1-14546-00 | | |
| 15FMHS, FMHL, FMH, MH, MSHB, MSHC, MSHG | 63W2-63W9 | 2003-10 | REC63V-14301-00 | REC63V-W0093-00 | REC63V-14985-00 | REC6G1-14546-00 | | |
| 15FMHS, FMHL, FMH, MH | 63WA-63WG | 2011-16 | REC63V-14301-00 | REC63V-W0093-00 | REC63V-14985-00 | REC6G1-14546-00 | | |
| 25VE | 61R | 1996 | REC61N-14301-04 | REC61N-W0093-00 | REC6L2-14385-00 | REC61N-14392-00 | | |
| 25VM | 61R | 1997 | REC61N-14301-04 | REC61N-W0093-00 | REC6L2-14385-00 | REC61N-14392-00 | | |
| E25A | 61N | 1998 | REC61N-14301-04 | REC61N-W0093-00 | REC6L2-14385-00 | REC61N-14392-00 | | |
| 25VM | 61R0 | 2001 | REC61N-14301-04 | REC61N-W0093-00 | REC6L2-14385-00 | REC61N-14392-00 | | |
| 30G | 61T | 1996 | REC61N-14301-04 | REC61N-W0093-00 | REC6L2-14385-00 | REC61N-14392-00 | | |
| 30GE | 61T | 1997 | REC61N-14301-04 | REC61N-W0093-00 | REC6L2-14385-00 | REC61N-14392-00 | | |
| 40X, XW | 66T | 1998-00 | REC66T-14301-60 | REC66T-W0093-01 | REC6E5-14385-02 | REC6E5-14546-00 | | |
| 40XMH | 66T4-66T8 | 2003-05 | REC66T-14301-60 | REC66T-W0093-01 | REC6E5-14385-02 | REC6E5-14546-00 | | |
| 40XMH, XMHS, XMHL | 66TG-66TR | 2009-12 | REC66T-14301-60 | REC66T-W0093-01 | REC6E5-14385-02 | REC6E5-14546-00 | | |
| E40X, MLH | 66T | 1998-00 | REC66T-14301-60 | REC66T-W0093-01 | REC6E5-14385-02 | REC6E5-14546-00 | | |
| E40X, XMH, XMHS, XMHL, MLHZ | 66T0-66T8 | 2001-05 | REC66T-14301-60 | REC66T-W0093-01 | REC6E5-14385-02 | REC6E5-14546-00 | | |
| E40X, XMHS, XMHL, XMHL, XMHLX | 66TA-66TR | 2006-12 | REC66T-14301-60 | REC66T-W0093-01 | REC6E5-14385-02 | REC6E5-14546-00 | | |
| E60H, HMHD, HMHDS, HMHDL, ELHB, MHZ, MLHA, HMHDX, HWHD | 69D0-69D9 | 2001-10 | REC6K5-14301-03 | REC6H3-W0093-02 | REC6G1-14985-00 | REC6H3-14590-00 | | |
| E60HMHD, HMHDS, HMHDL, HWDL | 69DA-69DC | 2011-12 | REC6K5-14301-03 | REC6H3-W0093-02 | REC6G1-14985-00 | REC6H3-14590-00 | | |
| E60HE, HM, E-60H | 6K5 | 1996-00 | REC6K5-14301-03 | REC6H3-W0093-02 | REC6G1-14985-00 | REC6H3-14590-00 | | |

JUNTAS CARBURADORES

CARBURETOR GASKETS

GUARNIZIONI CARBURATORI

JOINTS DE CARBURATEUR

| REF | OEM |
|---|--------------|
| REC6H4-14984-00 | 6H4-14984-00 |
|  | 25 - 90 HP |





new

| REF | OEM |
|---|-----------------|
| REC6F5-14483-00 | 6F5-14483-00 |
|  | E40/40J (2003+) |





new

| REF | OEM |
|---|-------------------------|
| REC6F5-14384-00 | 6F5-14384-00 |
|  | E40GMH/JMH 40GWH/JWH |





| REF | OEM |
|---|-------------------------|
| REC6F5-14398-00 | 6F5-14398-00 |
|  | E40GMH/JMH 40GWH/JWH |





| REF | OEM |
|---|------------------------|
| REC677-14384-01 | 677-14384-01 |
|  | E8D/DMH 9.9D 15D |





| REF | OEM |
|---|------------------------|
| REC677-14227-00 | 677-14227-01 |
|  | E8D/DMH 9.9D 15D |





| REF | OEM |
|---|--------------|
| REC6E7-14227-00 | 6E7-14227-00 |
|  | 9.9D 15D |





| REF | OEM |
|---|---|
| REC63V-14984-00 | 63V-14984-00 |
|  | 9.9F/FM/FEM/MS/MH/E9.9DMH 13.5AW 15F/FEM/MSH/FMH/MH E15DMH |



| REF | OEM |
|---|---|
| REC63V-14126-00 | 63V-14126-00 |
|  | 9.9F/FM/FEM/MS/MH/E9.9DMH 13.5AW 15F/FEM/MSH/FMH/MH E15DMH |





| REF | OEM |
|---|--|
| REC6L2-14399-00 | 6L2-14399-00 |
|  | 20DM/D/DEO/MLH E25A 25VE/VM/B/BMH/BWH/HMH/NMH/NE/N/ MLH/D 30G/GE E30HMH |





| REF | OEM |
|---|--|
| REC6L2-14384-00-00 | 6L2-14384-00 |
|  | 20DM/D/DEO/MLH E25A 25VE/VM/B/BMH/BWH/HMH/NMH/NE/N/ MLH/D 30G/GE E30HMH |





| REF | OEM |
|---|-------------------------|
| REC648-14384-01-00 | 648-14384-01 |
|  | 20C/CM 25D/DE 30A |





| REF | OEM |
|---|-----------------------------------|
| REC6H3-14457-01 | 6H3-14457-01 |
|  | 25Q 40V/TLR/H C40T 50G/H |
| | E60H 60F/TR 70B |





| REF | OEM |
|---|---------------------------|
| REC66T-14384-01 | 66T-14384-01 |
|  | E40XM/X/MLH/XW 40XW/XM |





| REF | OEM |
|---|---------------|
| REC66T-14536-01 | 66T-14536-01 |
|  | 40X/E40X/E40M |



| REF | OEM |
|---|--|
| REC676-14984-00-00 | 676-14984-00 |
|  | 75A/AE/AET/AEM E75B 85A/AE/AET/AED |



| REF | OEM |
|---|--|
| REC64D-14384-1 | 64D-14384-01 |
|  | 100A/AETO/TLR 115A/B/BE/CE/BETO 130BETO 140AETO 150CET/ETD/AETO/ CETO 175AETO/BETO/ET 200ETD 200CETO/AET/BET 225BET/AET 175D/DET |
| | 150F/FET/TXR/AET 200AET/TLR/F/FET 225D/DET 115B/CET/TXR/TLR 130BET 250G/GET |



KITS CARBURADORES



CARBURETOR KITS

KIT CARBURATORI

KIT CARBURATEUR



| REF | OEM |
|--|---|
| REC6A1-W0093-01 | 6A1-W0093-01 |
|  2B (1985-1988) |  |



| REF | OEM |
|--|---|
| REC677-W0093-00 | 677-W0093-00 |
|  9.9D (1985) 15D(1985) |  |

| REF | OEM |
|--|---|
| REC6G1-W0093-00 | 6G1-W0093-00 |
|  3A/AMH//MSH/ (1988-07) 6C/CEM/N/J (1984-96) 8C/CEM/N/J (1984-96) |  |



| REF | OEM |
|---|---|
| REC6E7-W0093-01 | 6E7-W0093-04 |
|  9.9D (1990-93) 15D (1990-93) |  |



| REF | OEM |
|---|---|
| REC67D-W0093-00 | 67D-W0093-00 |
|  F4 (1999-02) F4A/AMH/MSH (1998-02) |  |

| REF | OEM |
|--|---|
| REC6L2-W0093-00 | 6L2-W0093-00 |
|  20D/M (1998-11) 25N/M (1988-14) |  |

| REF | OEM |
|---|---|
| REC66M-W0093-01 | 66M-W0093-01 |
|  F9.9C/FT9.9D (1998-08) F15A/ELH/MHZ/PL (1998-07) |  |

| REF | OEM |
|--|---|
| REC689-W0093-02 | 689-W0093-02 |
|  20C/CM (1992-02) 25D/DE (1992-01) 30A (1992) |  |

| REF | OEM |
|---|---|
| REC63V-W0093-00 | 63V-W0093-00 |
|  9.9MH/FMH (1995-12) E9.9 13.5AMH (2003-04) 15FMH/MH (1995-12) E15DMH (2003) |  |

| REF | OEM |
|---|---|
| REC8542561 | 65W-W0093-02 |
|  F20A (2006-09) F25A/E (2006-09) FT/T25B/T (2006-09) F40B (2006-09) F30A (2006-09) |  |

new

| REF | OEM |
|---|---|
| REC6H4-W0093-03 | 6H4-W0093-03 |
|  | 25QEO (1993-1994) 40V/VM/VE (1995-14) C40T/TL (1995-02) 40YET (2005-07) 50H/HR/HM/HW/HE (1995-03) |



| REF | OEM |
|---|--------------------------|
| REC6E9-W0093-02 | 6E9-W0093-02 |
|  | 40G/QE/QE-2/QM (1992-99) |





| REF | OEM |
|---|--|
| REC6H2-W0093-10 | 6H2-W0093-10 |
|  | 25B/BETO (1994-1995) 50G/GE (1993-1998) 60FE/TL/TR (1992-2007) 70B/BE (1992-2014) |

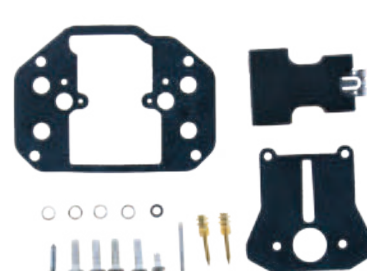

| REF | OEM |
|---|--------------|
| REC6F6-W0093-00 | 6F6-W0093-00 |
|  | E40 (2003) |





| REF | OEM |
|---|--|
| REC61N-W0093-00 | 61N-W0093-00 |
|  | 25VE/VM (1996-01) 25B/BMH/BW (2001-10) E30HMH (2003) 30G/GE (1996-00) 30HMH/HW (2003-12) |



| REF | OEM |
|---|---|
| REC6E9-W0093-03 | 6E9-W0093-03 |
|  | 40QEZ/QWC (1997-98) C40 2Cyl (1995-98) |



| REF | OEM |
|---|----------------------------------|
| REC6H4-W0093-01-00 | 6H4-W0093-01 |
|  | 40H/E (1985-88) 50D (1985-88) |



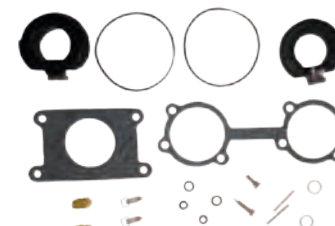

| REF | OEM |
|---|--|
| REC696-W0093-00 | 696-W0093-02 |
|  | E48CMH (2003) 55B/BE/BM (1992-02) E55CMH (2003-05) |
| | Para dos carburadores For two carburetors Contenuto per due carburatori Pour 2 carburateurs |





| REF | OEM |
|---|--|
| REC66T-W0093-01 | 66T-W0093-01 |
|  | 40XMH/XW (2000-13) E40X/MLH/XMH (2000-13) |



| REF | OEM |
|---|--|
| REC84419M | 696-W0093-01 696-W0093-02 |
|  | E48CMH (2003) 55B/BE/BM (1992-02) E55CMH (2003-05) |





new

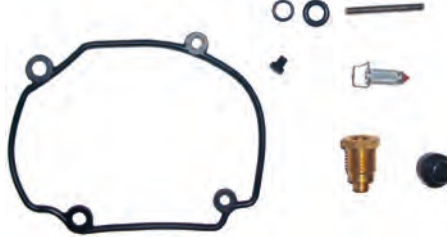

| REF | OEM |
|---|---|
| REC6H1-W0093-01-00 | 6H1-W0093-01 |
|  60FE-T/FEO (1985-91) 70B/BEH/CEL (1985-90) |  |

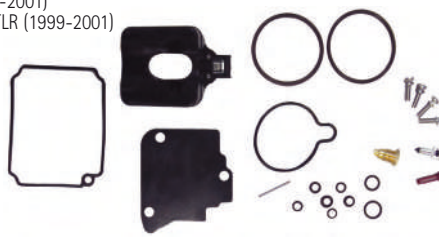

| REF | OEM |
|---|---|
| REC6H3-W0093-02 | 6H3-W0093-02 |
|  E60H/MHZ/MLH/HMHD/HW/ HEHM (1997-14) |  |

| REF | OEM |
|---|--|
| REC6H0-W0093-00 | 6H0-W0093-00 |
|  C80 (1997) |  |



| REF | OEM |
|---|---|
| REC6H1-W0093-10 | 6H1-W0093-10 |
|  75CET (1998-2014) 75TLR (2000-02) 80A (2000-02) 90AE/TR/TL (1992-14) |  |



| REF | OEM |
|--|---|
| REC67F-W0093-00 | |
|  F80A/TLR/ (1999-2001) F100A/TLR/TRZ/TLR (1999-2001) |  |



| REF | OEM |
|---|---|
| REC6E5-W0093-07 | 6E5-W0093-07 |
|  115BE/B (1996-2002) 115C/CET (2007-13) 130B/9BET (2007) |  |



| REF | OEM |
|--|--|
| REC6N6-W0093-02 | 6N6-W0093-02 |
|  115BETO/CETO (1990-91) L/130 BETO (1990-91) |  |

| REF | OEM |
|---|--|
| REC6E5-W0093-08 | 6E5-W0093-08 |
|  115 BE (1997) |  |

| REF | OEM |
|--|--|
| REC6E5-W0093-06 | 6E5-W0093-06 |
|  115B/BETO/CEO/CETO (1992-1995) 130BETO (1993-1995) L150CETO (1992-1995) 175BETO (1992-95) 200BETO (1992-95) 200CETO (1992-93) 225BETO (1993-95) |  |

| REF | OEM |
|--|---|
| REC64D-W0093-00 | 64D-W0093-00 |
|  150A/AET/GET/FET/F (1996-00) 175DET/FET (1996-00) 200F/FET/G/GET (1996-00) 225D/DET (1996-97) |  |

| REF | OEM |
|--|---|
| REC6K7-W0093-09 | 6K7-W0093-09 |
|  225AET (1987-91) PROV200 (1991) 150CET (1990-91) 175 BETO (1990-91) 200BET/ET (1990-91) 225BET(1990-91) |  |

| REF | OEM |
|--|---|
| REC61A-W0093-01 | 61A-W0093-01 |
|  225C/CET (1994-95) 250B (1995-02) 250A/AET (1992-06) |  |

AGUJA CARBURADOR

NEEDLE VALVE

SPILLO CONICO CARBURATORE

SIEGE, POINTEAU ET GICLEUR

| REF | OEM |
|-----------------|--------------|
| REC61N-14392-00 | 62Y-14392-00 |

2.5>60HP



| REF | OEM |
|-----------------|--------------|
| REC6G1-14546-00 | 6G1-14546-01 |

8>40HP



| REF | OEM |
|-----------------|--------------|
| REC626-14390-90 | 626-14390-90 |

9.9D/15D



| REF | OEM |
|-----------------|--------------|
| REC677-14343-68 | 677-14343-68 |

9.9D/15D



| REF | OEM |
|-----------------|--------------|
| REC6E8-14390-12 | 6E8-14390-12 |

9.9-15HP
E8D/9.9D/15D



| REF | OEM |
|-----------------|--------------|
| REC6E5-14546-00 | 6E5-14546-00 |

25-250HP



| REF | OEM |
|-----------------|--------------|
| REC6F5-14390-21 | 6F5-14390-21 |

40G/E40G
40J/E40J



| REF | OEM |
|-----------------|--------------|
| REC6F6-14341-00 | 6F6-14341-00 |

40G/40J
E40G/E40J



| REF | OEM |
|-----------------|--------------|
| REC696-14590-01 | 696-14590-01 |

48-55HP
E48CMH
E55CMH



| REF | OEM |
|-----------------|--------------|
| REC6H3-14590-00 | 6H3-14590-01 |

E60/60FE/TR
70BET/TR
F80-F100



| REF | OEM |
|-----------------|--------------|
| REC688-14947-00 | 688-14947-00 |

75A/AE
85A/AE



| REF | OEM |
|-----------------|------------------------------|
| REC692-14590-01 | 692-14590-00 692-14590-01 |

75A,C,TLR (1990-16)
80A (1984-02)
85A (1990-03)
90A,T (1984-18)



new

TORNILLOS CARBURADOR

BOLT SCREW

VITE CARBURATORE

VIS DE CARBURATEUR

| REF | OEM |
|-----------------|-------------|
| REC624-42542-00 | 90387-06119 |

3>300HP



| REF | OEM |
|-----------------|--------------|
| REC647-14323-00 | 647-14323-00 |

E8D
4A/MS
9.9D
20C

5C
15D
25D
30A



| REF | OEM |
|-----------------|--------------|
| REC6F5-14323-00 | 6F5-14323-01 |

E40G/E40J
40G/40J



| REF | OEM |
|-----------------|--------------|
| REC692-14923-00 | 692-14923-00 |

40>90HP



| REF | OEM | |
|----------------------------------|--------------------------------------|--|
| REC679-14923-00 | 679-14923-00 | |
| 9.9F/M E9.9D 15F/M E15D | 13.5 AM 8N/C/J 6C/D/TR/M 3A | |

| REF | OEM | |
|-----------------------|--------------|--|
| REC663-14923-00 | 663-14923-00 | |
| E48C 55B E55CMH | | |

| REF | OEM | |
|-----------------|--------------|--|
| REC6A0-14325-00 | 6A0-14325-00 | |
| 15>300HP | | |

| REF | OEM | |
|-----------------|--------------|--|
| REC6E5-14328-01 | 6E5-14328-01 | |
| 115>225HP | | |

| REF | OEM | |
|-----------------|--------------|--|
| REC50M-14355-00 | 50M-14355-00 | |
| 20>50HP | | |

| REF | OEM | |
|-----------------|--------------|--|
| REC64D-14394-00 | 64D-14394-00 | |
| 115-225HP | | |

| REF | OEM | |
|-----------------|--------------|--|
| REC66T-14992-00 | 66T-14992-00 | |
| 40X/E40X/E40M | | |

| REF | OEM | |
|-----------------|--------------|--|
| REC6E5-14323-03 | 6E5-14323-03 | |
| 115>250 | | |

VÁLVULA DE LÁMINAS VALVE OF SHEETS VALVOLA CLAPET D'ADMISSION

| REF | OEM | |
|----------------------|--------------|--|
| REC6F6-13610-00 | 6F6-13610-00 | |
| 40G/E40G 40J/E40J | | |

| REF | OEM | |
|---|--------------|--|
| REC688-13610-00 | 688-13610-00 | |
| 75A,C,T / E75 (1990+) 80A (1984-02) 85A (1900+) 90A,TR,TLR (2003+) 2T/Strokes | | |

| REF | OEM | |
|---------------------------------|--------------|--|
| REC63W-13610-00 | 63W-13610-00 | |
| 9.9/15 HP (1995+) 2T/Strokes | | |

PASADOR DE BOYA PIN FLOAT SPINOTTO GALLEGGIANTE AXE DE FLOTTEUR

| REF | OEM | |
|-----------------|--------------|---|
| REC688-14548-00 | 688-14548-00 | 3>90HP |
| REC676-14186-00 | 676-14186-00 | 3>100HP 4AC/M/AS FT/F9.9A/B 5C/CM/CS |
| REC647-14386-10 | 647-14386-10 | T9.9EL 9.9D F8AM/BM 15D |
| PAF25-05070019 | 6H4-14548-00 | 9.9>100HP |
| REC6E5-14386-01 | 6E5-14386-01 | 9.9>200HP |

| REF | OEM | |
|-----------------|--------------|-----------------------|
| REC663-14548-00 | 663-14548-00 | E48C 55B E55CMH |
| REC6E5-14386-02 | 6E5-14386-02 | 115>200HP |



BOYAS

FLOATS

GALLEGGIANTE

FLOTTEUR DE CARBURATEUR

| REF | OEM |
|-----------------|--------------|
| REC6G1-14985-00 | 647-14323-00 |

| | |
|--------|--------|
| 3A/M | 70B |
| E60 | 40N-H |
| 8C-M/T | 50E-D |
| 60F | 6C/M/D |



| REF | OEM |
|-----------------|--------------|
| REC648-14385-00 | 648-14385-00 |

| |
|-----|
| 20C |
| 25D |
| 30A |



| REF | OEM |
|-----------------|--------------|
| REC647-14385-00 | 647-14385-00 |

| |
|------|
| 4AC |
| 5C |
| 9.9D |
| 15D |



| REF | OEM |
|-----------------|--------------|
| REC6F6-14385-00 | 6F6-14385-00 |

| |
|--------|
| 40G/J |
| E40G/J |



| REF | OEM |
|-----------------|--------------|
| REC6E7-14385-00 | 6E7-14385-00 |

| |
|------|
| 4AC |
| 5C |
| E8D |
| 9.9D |
| 15D |



| REF | OEM |
|-----------------|--------------|
| REC676-14985-01 | 676-14985-01 |

| |
|-------|
| 40Q |
| 75A |
| E75B |
| 80A |
| 85A |
| 90A/E |



| REF | OEM |
|-----------------|--------------|
| REC676-14966-00 | 679-14966-00 |

| |
|---------|
| 8>100HP |
|---------|



| REF | OEM |
|-----------------|--------------|
| REC6E5-14385-02 | 6E5-14385-02 |

| | |
|--------|----------|
| 40X | 175D/A |
| E40 | 200A |
| 100A | 200G/F/B |
| 115C | 225D |
| 115A-B | 225A |
| 130B | 250G |
| 150F/A | |



| REF | OEM |
|-----------------|--------------|
| REC63V-14985-00 | 63V-14985-00 |

| |
|--------|
| 9.9F-M |
| 13.5A |
| 15F-M |
| F20 |
| F25 |
| F30 |
| F40 |



| REF | OEM | 2T STROKES | 4T STROKES |
|-----------------|--|---------------|----------------|
| REC6H4-14985-01 | 6H4-14985-00 6H4-14985-01 650-14385-00 6M6-14385-00 | ✓ 25-90 hp | ✓ 75-100 hp |



new

| REF | OEM |
|-----------------|--------------|
| REC6L2-14385-00 | 6L2-14385-00 |

| |
|-----------|
| 13.5>60HP |
|-----------|



CONECTOR DE CARBURADOR

ACCELEROGRAPH CONTROL

CONTROLLO DELL'ACCELEROGRAFO

ATTACHE TIGE D'ACCELERATEUR

| REF | OEM |
|----------------|------------------------------|
| PAF15-07000016 | 661-41262-01 661-41262-02 |



new

ELEMENTO FILTRO DEL CARBURADOR

ELEMENT FILTER (CARB INLET)

FILTRO CARBURATORE

FILTRE DU CARBURATEUR

| REF | OEM |
|-----------------|--------------|
| REC67F-14371-01 | 67F-14371-01 |
| F75 (2003-04) | |
| F80 (2002-03) | |
| F90 (2003-04) | |
| F100 (2002-03) | |



ACCELERADOR

ACCELERATOR

ACCELERATORE

ACCELERATEUR

VARILLA DE ACELERADOR

ROD ACCELERATOR LEVER

ASTA ACCELERATORE

TIGE LEVIER ACCELERATEUR

| REF | OEM |
|-----------------|--------------|
| REC6H3-41217-00 | 6H3-41217-00 |
| 50G/E60H | |
| 60F/T | |
| 70B/T | |



| REF | OEM |
|-----------------|--------------|
| REC692-41256-00 | 692-41256-00 |
| 75A/B | |
| 80A | |
| 85A | |
| 90A | |



| REF | OEM |
|-----------------|--------------|
| REC688-41217-00 | 688-41217-00 |
| 80A | |
| 90A/E | |



| REF | OEM |
|-----------------|--------------|
| REC6G5-41217-00 | 6G5-41217-01 |
| 150/200ETN | |
| 150/200AETO | |
| 175AET-0 | |
| 225AETO | |



SISTEMA ELÉCTRICO ELECTRIC SYSTEM

SISTEMA ELETTRICO SYSTEME ÉLECTRIQUE

SENSORES

SENSORS

SENSORE

CAPTEURS

SENSOR TPS

TPS SENDER

SENSORE TPS

CAPTEUR TPS

| REF | OEM |
|-----------------|--------------|
| REC6C5-85885-00 | 6C5-85885-00 |



| REF | OEM |
|-----------------|--------------|
| REC6S1-85885-00 | 6S1-85885-00 |



| REF | OEM |
|-----------------|--------------|
| REC69J-85885-00 | 69J-85885-00 |



| REF | OEM |
|-----------------|--------------|
| REC68V-85885-00 | 68V-85885-00 |



SENSOR MAP

MAP SENSOR

SENSORE MAP

CAPTEUR MAP

| REF | OEM |
|-----------------|--------------|
| REC68V-82380-00 | 68V-82380-00 |



| REF | OEM |
|-----------------|--------------|
| REC68F-83688-10 | 68F-83688-10 |



| REF | OEM |
|-----------------|--------------|
| REC63P-82380-00 | 63P-82380-00 |



| REF | OEM |
|-----------------|--------------|
| REC68F-83688-00 | 68F-83688-00 |



SENSOR IAC

IAC SENSOR

SENSORE IAC

CAPTEUR IAC

| REF | OEM | 2T STROKES | 4T STROKES |
|----------------|--------------|---------------|---------------|
| REC13650-52G00 | 63P-85886-00 | | ✓ |

F150 --> F350





| REF | OEM | 2T STROKES | 4T STROKES |
|----------------|--------------|---------------|---------------|
| REC13650-56B00 | 65L-85886-00 | | ✓ |

F115, F200, F225
L, Z 150/250 HP
V, VZ, Z 200/300HP



Guía
inyectores y sensores
Guide injectors et
sensors
Guida iniettori e sensori
Guide injecteurs
et sondes

P. 90

| SENSOR TEMPERATURA DEL AGUA | | SENSOR, WATER TEMPERATURE | | SENSORE TEMPERATURA ACQUA | | CAPTEUR DE TEMPERATURE | |
|--|--------------|---|--|---|--------------|---|--|
| REF | OEM | | | REF | OEM | | |
| PAF25-05010201 | 65W-85790-00 | | | PAT40-05000100 | 6AH-82560-00 | | |
| <ul style="list-style-type: none"> F20A (1998-06) F25A,E,M (1998-09) T25 / FT25 (1998-09) | |  | | <ul style="list-style-type: none"> F9.9H (2009+) F13.5B (2007-09) F15C,E,M (2007+) F20B, E, M (2007+) | |  | |

| REF | OEM | 2T STROKES |
|-----------------|--------------|-----------------------|
| REC688-82560-10 | 688-82560-10 | 40 - 300 hp (1984-16) |

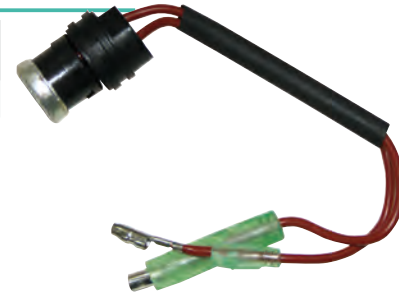

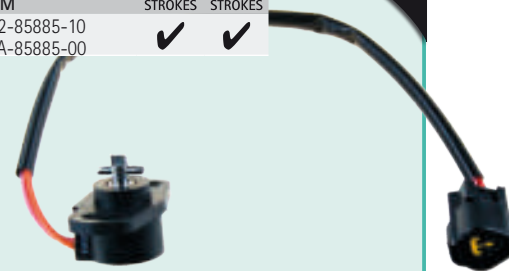
| SENSOR ACCELERACIÓN TS | | SENSOR | | SENSORE ACCELERATORE TS | | CAPTEUR D'ACCELERATEUR TS | |
|------------------------|------------------------------|---|------------|-------------------------|--|---------------------------|--|
| REF | OEM | 2T STROKES | 4T STROKES | | | | |
| REC6X2-85885-10 | 6X2-85885-10 61A-85885-00 | ✓ | ✓ | | | | |
| 80 - 300 HP | |  | | | | | |

| SENSOR PRESIÓN DE ACEITE | | SENSOR, OIL PRESSURE | | SENSORE PRESIONE DELL'OLIO | | SONDE DE PRESSION D'HUILE | |
|--------------------------|------------------------------|---|--|----------------------------|--|---------------------------|--|
| REF | OEM | | | | | | |
| PAF15-07010103 | 65W-82504-00 62Y-82504-10 | | | | | | |
| F9.9 - F40 | |  | | | | | |

| SENSOR DE OXÍGENO | | OXYGEN SENSOR | | SENSORE OSSIGENO | | SONDE À OXYGENE | |
|---|--------------|---|--|--|--------------|--|--|
| REF | OEM | | | REF | OEM | | |
| REC67H-8592A-01 | 67H-8592A-01 | | | REC68F-8592A-00 | 68F-8592A-00 | | |
| <ul style="list-style-type: none"> LX200/5X200 (2001-05) DX150/LX150 (2001-05) SX150/VX150 (2001-05) | |  | | <ul style="list-style-type: none"> 200HP (2001-2007) 150HP (2001-2007) 175HP (2001-2007) L, Z, V-PETO, TLR, NETO | |  | |

BOBINAS

COILS

BOBINE



BOBINES

BOBINA DE LUZ



COIL LIGHTING

BOBINA LUCE



BOBINE D'ÉCLAIRAGE

| REF | OEM | 2T STROKES | 4T STROKES |
|--|--------------|---------------|---------------|
| REC63V-85533-00 | 63V-85533-00 | ✓ | |
|  9,9/15 F/M (1995+) | (1995+) | | |
|  13,5 AM (2003-04) | (2003-04) | | |
|  E9.9/15 (2003) | (2003) | | |



| REF | OEM | 2T STROKES | 4T STROKES |
|---|--------------|---------------|---------------|
| REC66T-85533-00 | 66T-85533-00 | ✓ | |
|  E40 (1998+) | (1998+) | | |
|  40X/M (1998+) | (1998+) | | |



| REF | OEM | 2T STROKES | 4T STROKES |
|---|--------------|---------------|---------------|
| PAF15-07000400 | 66M-85533-00 | | ✓ |
|  F15 ALL (1998-07) | (1998-07) | | |
|  F9.9 ALL (1998-08) | (1998-08) | | |
|  F13.5 ALL (2002-07) | (2002-07) | | |





BOBINA DE IGNICIÓN



IGNITION COIL

BOBINA AVVIAMENTO

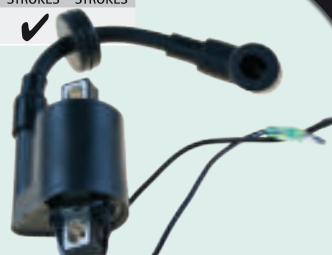

BOBINE D'ALLUMAGE

| REF | OEM | 2T STROKES | 4T STROKES |
|--|--------------|---------------|---------------|
| REC6E0-85570-00 | 6E0-85570-00 | ✓ | |
|  4A/M/C (1996-18) | (1996-18) | | |
|  5C (1996-15) | (1996-15) | | |











| REF | OEM | 2T STROKES | 4T STROKES |
|---|--------------|---------------|---------------|
| REC6H3-85570-10 | 6H3-85470-10 | ✓ | |
|  E60H/M (2001+) | (2001+) | | |
|  60F (1984-91) | (1984-91) | | |
|  70B/C/E (1984-91) | (1984-91) | | |



| REF | OEM | 2T STROKES | 4T STROKES |
|---|------------------------------|---------------|---------------|
| REC6B4-85570-01 | 6B4-85570-00 6B4-85570-01 | ✓ | |
|  E9.9D (2003-13) | (2003-13) | | |
|  E15D (2003+) | (2003+) | | |







| REF | OEM | 2T STROKES | 4T STROKES |
|---|--------------|---------------|---------------|
| REC6R3-85570-01 | 6R3-85570-01 | ✓ | |
|  200 A/E/F (1997-10) | (1997-10) | | |
|  150 F/T (1994-07) | (1994-07) | | |
|  175D (1996-03) | (1996-03) | | |
|  225D (1996-09) | (1996-09) | | |
|  130 B/T (1994-07) | (1994-07) | | |
|  115 C/T (1994-13) | (1994-13) | | |
|  130 BETO (1994-01) | (1994-01) | | |



| REF | OEM | 2T STROKES | 4T STROKES |
|--|--------------|---------------|---------------|
| PAF25-05120000 | 65W-85570-01 | ✓ | |
|  F20A/E (1998-06) | (1998-06) | | |
|  F25A/B/T/M (1998-09) | (1998-09) | | |



| REF | OEM | 2T STROKES | 4T STROKES |
|---|--------------|---------------|---------------|
| PAF15-07000600 | 66M-85570-00 | ✓ | |
|  F15 ALL (1998-07) | (1998-07) | | |
|  F9.9 ALL (1998-08) | (1998-08) | | |
|  F13.5 ALL (2002-07) | (2002-07) | | |





| REF | OEM | 2T STROKES | 4T STROKES |
|-----------------|-------------|---------------|---------------|
| REC6F5-85570-11 | F5-85570-13 | | ✓ |

 F9.9 (2009+)
 F20/25 B/F (2007+)
 F13.5 B/M (2007+)
 F15 C/M/E (2007-09)





| REF | OEM | 2T STROKES | 4T STROKES |
|-----------------|------------------------------|---------------|---------------|
| REC63V-85570-00 | 63V-85570-00 65E-85570-00 | ✓ | |

 9.9/15/13.5 (1995+)
 E15 (2003) 63V & 63W
 E15 (2003) 65F & 65G
 9.9/15 F/M (1995-13)
 13.5A (2003-04)
 E15 (2003)



| REF | OEM | 2T STROKES | 4T STROKES |
|-----------------|--------------|---------------|---------------|
| REC697-85570-00 | 697-85570-00 | ✓ | ✓ |

 50G/ETOL (1995-07)
 75T/L/A/C/B (1997-14)
 85A/E/TDL/X (1997-03)
 55 B/M/ET (1995-02)
 90A/T/ETOL (1997-14)
 60F/T/ETOL (1995-07)
 70B/E/ETOL (1995-14)



| REF | OEM | 2T STROKES | 4T STROKES |
|-----------------|--------------|---------------|---------------|
| REC689-81311-40 | 66M-85570-00 | ✓ | |

 3A (1985-92)
 40Q (1990-98)





| REF | OEM | 2T STROKES | 4T STROKES |
|-----------------|------------------------------|---------------|---------------|
| REC61N-85570-01 | 61N-85570-00 61N-85570-01 | ✓ | |

 20 D, DEM, MLH, MSH, DMH, DWQ, DWH (6L3 - 6L3A) (1994-11)
 E25 A (61N) (1998)
 25B, BMH, BWC, BWHVM (61R0 - 69RG) (2001-15)
 E25 BMH (63P3 - 69PG) (2003-15)
 25 N, NE, MLH, MSH, NMH, NW, MH (6L2 - 6L2G) (1994-15)
 30 G, C30 ELRW (61T - 61T0) (1998-01)
 330 HMH (60B3) (2003)



| REF | OEM | 2T STROKES | 4T STROKES |
|-----------------|------------------------------|---------------|---------------|
| REC6E5-85570-11 | 6E5-85570-11 6E5-85570-10 | ✓ | |

 115HP 4Cil. (1984-91)
 140A/E (1984-89)
 150
 175
 200HP (1984-89)



| REF | OEM | 2T STROKES | 4T STROKES |
|-----------------|--------------|---------------|---------------|
| REC6A1-85570-00 | 6A1-85570-00 | ✓ | |

 2B,C,M (1995-10)



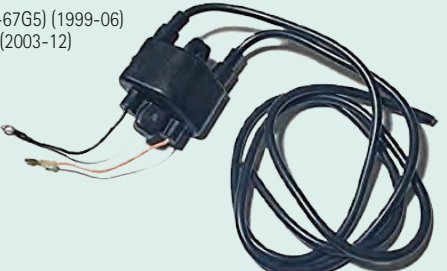

| REF | OEM | 2T STROKES | 4T STROKES |
|-----------------|--------------|---------------|---------------|
| REC67F-85570-00 | 67F-85570-00 | ✓ | |

 F80A/T (67G-67G5) (1999-06)
 F100A/B/C/T (2003-12)



| REF | OEM | 2T STROKES | 4T STROKES |
|-----------------|--------------|---------------|---------------|
| REC697-85570-10 | 697-85570-11 | ✓ | |

 55HP 2 Cil. (1989-94)
 90A/ETN/AETO (1984-88)
 80A (1984-89)



| REF | OEM | 2T STROKES | 4T STROKES |
|-----------------|--------------|---------------|---------------|
| REC66T-85570-00 | 66T-85570-00 | ✓ | |

 E40 (1998+)
 40X/M (1998+)



| REF | OEM | 2T STROKES | 4T STROKES |
|-----------------|--------------|---------------|---------------|
| REC6F6-85530-01 | 6F6-85530-01 | ✓ | |

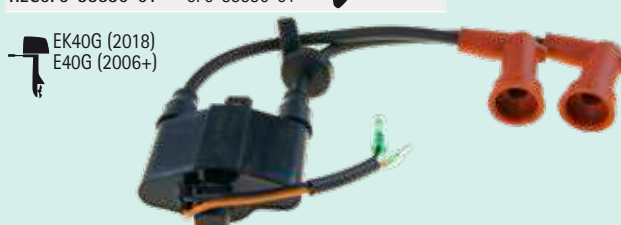

 EK40G (2018)
 E40G (2006+)

new

| REF | OEM | 2T STROKES | 4T STROKES |
|-----------------|-----------------|---------------|---------------|
| REC6E7-85570-19 | 6E7-85570-19-00 | ✓ | |



 9.9/15HP (1988-95)
 20C/D (1985-93)
 25C/D (1985-93)

| REF | OEM | 2T STROKES | 4T STROKES |
|-----------------|--------------|---------------|---------------|
| REC6CB-82310-00 | 6CB-82310-00 | | ✓ |



 F150C, (2017+)
 F175A,C (2014+)
 F200F,B,G,C (2013+)
 F225F,C,B,H,J (2011+)
 F250D,C,F,P (2011+)
 F300B,C,A,D,G (2011+)
 F350A,C (2012-19)

new

BOBINA DE T.C.I. T.C.I. COIL BOBINE T.C.I. BOBINE T.C.I.

| REF | OEM | 2T STROKES | 4T STROKES |
|-----------------|--------------|---------------|---------------|
| PAF2.6-04000600 | 69M-85640-00 | | ✓ |



 F2.5 ALL (2003+)

| REF | OEM | 2T STROKES | 4T STROKES |
|---------------|--------------|---------------|---------------|
| PAF4-04000038 | 67D-85640-00 | | ✓ |



 F4 ALL (1998+)

BOBINA DE CARGA CHARGE COIL BOBINA DI CARICA BOBINE DE CHARGE

| REF | OEM | 2T STROKES | 4T STROKES |
|-----------------|--------------|---------------|---------------|
| REC63V-85520-00 | 63V-85520-00 | ✓ | |

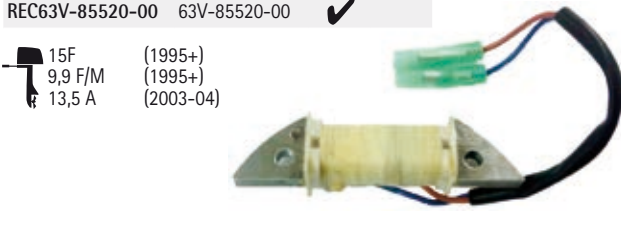

 15F (1995+)
 9,9 F/M (1995+)
 13,5 A (2003-04)

| REF | OEM | 2T STROKES | 4T STROKES |
|-----------------|--------------|---------------|---------------|
| REC66T-85520-00 | 66T-85520-00 | ✓ | |



 E40 (1998+)
 40X/M (1998+)

| REF | OEM | 2T STROKES | 4T STROKES |
|----------------|--------------|---------------|---------------|
| PAF15-07000300 | 66M-85520-00 | | ✓ |



 F15 ALL (1998-07)
 F9.9 ALL (1998-08)
 F13.5 ALL (2002-07)

| REF | OEM | 2T STROKES | 4T STROKES |
|-----------------|--------------|---------------|---------------|
| REC6H3-85520-00 | 6H3-85520-00 | ✓ | |

E60H/M (2001+)
60F (1984-91)
70B/C/E (1984-91)

new

| REF | OEM | 2T STROKES | 4T STROKES |
|-----------------|--------------|---------------|---------------|
| REC6B4-85520-00 | 6B4-85520-00 | ✓ | |

E9.9D / E15D

new

BOBINA DE PULSACIÓN

PULSER COIL

| REF | OEM | 2T STROKES | 4T STROKES |
|----------------|--------------|---------------|---------------|
| PAF20-05000100 | 6AH-85580-00 | | ✓ |

F9.9H (2009+)
F13.5B (2007-09)
F15C/E/M (2007)
F20/F30 (2009+)

new

BOBINE ACCENSIONE

BOBINE PULSEUR

| REF | OEM | 2T STROKES | 4T STROKES |
|-----------------|--------------|---------------|---------------|
| REC63V-85580-01 | 63V-85580-01 | ✓ | |

9,9/15 F/M (2003+)
13,5A (2003-04)

| REF | OEM | 2T STROKES | 4T STROKES |
|-----------------|--------------|---------------|---------------|
| REC6B4-85580-00 | 6B4-85580-00 | ✓ | |

E9.9D / E15D

new

| REF | OEM | 2T STROKES | 4T STROKES |
|-----------------|--------------|---------------|---------------|
| REC66T-85580-00 | 66T-85580-00 | ✓ | |

E40 (1998+)
40X/M (1998+)

| REF | OEM | 2T STROKES | 4T STROKES |
|----------------|--------------|---------------|---------------|
| PAF25-05110000 | 65W-85580-00 | | ✓ |

F25 ALL (1998-09)
F40 E
B (2000-09)
F30 A
ERZ
ML (2001-09)

| REF | OEM | 2T STROKES | 4T STROKES |
|----------------|--------------|---------------|---------------|
| PAF15-07000200 | 66M-85580-00 | | ✓ |

F15 ALL (1998-07)
F9.9 ALL (1998-08)
F13.5 ALL (2002-07)

BUJÍAS

SPARK

CANDELE

BOUGIES

| 2T STROKES | REF CHAMPION | OEM |
|------------|--------------------------|-------------|
| 2 | 1984 CHAL90C | 94703-00001 |
| 3 | 1988 CHAQL86C | 94701-00248 |
| 5 | 1984 CHAQL82C CHAL82C | 94701-00041 |
| 6 | 1986 CHAQL82C CHAL82C | 94701-00041 |
| 8 | 1984 CHAQL82C CHAL82C | 94701-00041 |
| 09/09/19 | 1984 CHAQL82C CHAL82C | 94701-00041 |
| 20 | 1996 CHAQL82C CHAL82C | 94701-00041 |
| 25 | 1999 CHAQL82C CHAL82C | 94701-00041 |
| 30 | 1984 CHAQL82C CHAL82C | 94701-00041 |
| 40 | 1984 CHAQL82C CHAL82C | 94701-00041 |
| 50 | 1995 CHARA8HC | 94701-00041 |
| 70 | 1984 CHAQL78C | 94701-00195 |
| 90B | 1984 CHAQL78C | 94701-00195 |
| 90 | 1984-00 CHAQL78C | 94701-00195 |
| 115 | 1984-05 CHAQL78C | 94701-00195 |
| 130 | 1989 CHAQL78C | 94701-00195 |
| 150 Carb | 1996 CHAQL82C CHAL82C | 94701-00248 |
| 150 EFI | 1999-00 CHAQL78C | 94701-00195 |
| 150 EFI | 2000 CHARC12YC | 94702-00401 |
| 150 MPDI | 2000 CHARC12YC | 94702-00401 |
| 150 VMAX | 1997 CHAQL78C | 94701-00195 |
| 175 | 1984 CHAQL78C | 94701-00195 |

| 2T STROKES | REF CHAMPION | OEM |
|------------|------------------------------|----------------------------|
| 175 VMAX | 1992 CHAQL78C | 94701-00195 |
| 200 LX | 1999 CHAQL78C | 94701-00195 |
| 200 LZ | 1999 CHARC9YC4 | 94702-00399 |
| 200 SX | 1999 CHAQL78C | 94701-00195 |
| 200 VX | 2000 CHAQL78C | 94701-00195 |
| 200 Z | 2000 CHARC9YC4 | 94702-00399 |
| 225 | 2000 CHAQL77JC4 CHAL77JC4 | 94701-00309 94701-00217 |
| 250 | 2000 CHAQL77JC4 CHAL77JC4 | 94701-00309 94701-00217 |

| 4T STROKES | REF CHAMPION | OEM |
|------------|---------------|-------------|
| 2,5F | 2003 CHAQL86C | 94701-00248 |
| 4F | 1999 CHAQL86C | 94701-00248 |
| 9.9Fi | 1996 CHAZ9Y | 94701-00282 |
| 9.9T | 1996 CHAZ9Y | 94701-00282 |
| 15F | 1999 CHARA8HC | 94701-00375 |
| 25F | 1998 CHARA8HC | 94701-00375 |
| 30F | 2001 CHARA8HC | 94701-00375 |
| 40F | 1999 CHARA8HC | 94701-00375 |
| 50F | 1999 CHARA8HC | 94701-00375 |
| 60 | 2002 CHARA8HC | 94701-00375 |



| | REF NGK | OEM |
|---|-------------|----------------|
| 2B | NGKBR5HS | 94702-00249-00 |
| F2,5A/F4A | NGKBR6HS | 94701-00248-00 |
| 3A/F6A/F8C/FT8D/F9,9F/F9,9J/FT9,9G/FT9,9L | NGKBR6HS-10 | 94702-00274-00 |
| F4B/F5A/F6C | NGKCR6HS | 94702-00372-00 |
| 4A/5C/20C/25D/40X | NGKBR7HS | 94701-00110-00 |
| 6C/8C/9,9D/9,9F/15D/15F/20D/25N/25V/25B/30D/40H/40V | NGKBR7HS-10 | 94702-00271-00 |
| F8B | NGKCR5HSB | 94701-00300-00 |
| F9,9A/F9,9B | NGKCR6HS | 94701-00282-00 |
| F9,9C/FT9,9D/F15A/F25A/FT25B/F30A/F40A/F40B/F50A/FT50B/FT50C | NGKDP6EA-9 | 94701-00375-00 |
| F15C/F20B/F25D/F25G/FT25F/F30B/F40F/F50F/F50H/FT50G/FT50J/F60C/F60F/FT60D/FT60G | NGKDP6EB-9 | 94702-00418-00 |
| 40Q | NGKBR8HS | 94701-00195-00 |
| 30G/50D/50G/50H/55B/60F/70B/75A/75C/80A/85A/90A/100A/115A/115B/115C/140A/150A/150C/150F/175A/175B/175D/200A/200B/200F/200G/225D/(L)250A/(L)250G | NGKBR8HS-10 | 94702-00247-00 |
| F60A/FT60B | NGKDP6EA-9 | 94701-00406-00 |
| F70A | NGKLR7E | 94702-00429-00 |
| F80A/F80B/F100A/F100B/F100D/F(L)150A/F(L)200A/F(L)225A | NGKLR5A-11 | 94702-00391-00 |
| 130B/140B/200C/225B/250B/225G (VMAX) | NGKBR9HS-10 | 94701-00309-00 |
| F(L)115B | NGKLR6E | 94702-00437-00 |
| F(L)115A/F175A/F(L)200C/F(L)200F/F(L)200G/F(L)225B/F225C/F(L)250A/F(L)250B/F(L)300A/F(L)350A/F(L)225F/F(L)250D/F(L)300B | NGKLR6A-11 | 94702-00400-00 |
| (L)Z150P/Z150Q (VMAX) | NGKBKR6EKU | 94702-00405-00 |
| Z175G/(L)Z200N/Z200P (VMAX)/(L)Z250D/Z250F (VMAX)/(L)Z300A | NGKBKR7EKU | 94702-00404-00 |
| STERN-DRIVE ESSENCE | NGKBR6FS | 94701-00365-00 |

WAVERUNNER

| | | |
|---|-------------|-------------|
| XL800/XLT800/GP800/WB800/GP800R | NGKBR8ES | 94701-00204 |
| XLT1200/XL1200LTD/GP1200R/GP1300R | NGKBR8ES-11 | 94702-00396 |
| SJ650/650T/650TL/650TX/FX1/PRO TX700/WB700/XL700/WVT700/W.RAIDER 760/WVT760/XL760/WB760/GP760/W.RAIDER 1100/WVT1100/SUV1200/GP1200/XL1200 | NGKBR8HS | 94701-00195 |
| SJ700/W.RAIDER 700 | NGKBR7HS | 94701-00110 |
| FX140/FX140 CRUISER/FX160/FX160 CRUISER/FX1100 HO/HO CRUISER/VX 1100 SPORT & DELUXE | NGKCR9EB | 94702-00409 |



VOLANTE DE MOTOR

FLYWHELL

VOLANTE MOTORE

VOLANT MOTEUR

SIN DIENTES (MANUAL)

WITHOUT TOOTH

SENZA DENTI (MANUALE)

MANUEL SANS DENT

| REF | OEM |
|----------------|--------------|
| PAF20-05000500 | 6AH-85550-00 |



 F9.9H (2009+)

 F13.5B (2007-09)

 F15C,E,M (2007+)

 F20B, E, M (2007+)

| REF | OEM |
|----------------|--------------|
| PAF15-07070000 | 66M-85550-00 |



 F9.9C, M (1998-08)

 FT9.9D (1999-08)

 F13.5A (2002-07)

 F15A,E,M (1998-07)

| REF | OEM |
|----------------|--------------|
| PAF25-05150000 | 65W-85550-01 |



 F20/F25 (A) (1998-08)

 F40B/E/T (2000-09)

 FT/T25 (2000-09)

 F30A/E/M (2001-09)

ELÉCTRICO

ELECTRIC

ELETTRICO

ÉLECTRIQUE

| REF | OEM |
|-----------------|--------------|
| PAF20-05000500W | 6AH-85550-10 |



 F9.9H (2009+)

 F13.5B (2007-09)

 F15C,E,M (2007+)

 F20B, E, M (2007+)

| REF | OEM |
|-----------------|--------------|
| PAF15-07070100W | 66M-85550-10 |



 F9.9C, M (1998-08)

 FT9.9D (1999-08)

 F13.5A (2002-07)

 F15A,E,M (1998-07)

MOTORES DE ARRANQUE

STARTERS

MOTORINI AVVIAMENTO

DEMARREUR

| REF | OEM | | | 2T STROKES | 4T STROKES | |
|------------|--|------------|--------|------------|------------|-----------------|
| PH130-0061 | 6L2-81800-10, 11, 12 682-81800-10, 11, 12 | 12V 0.4 kw | 10 CCW | ✓ | | REC89-825096T01 |
| | 9.9-15HP (1984-97) 25HP (1988-98) 6HP (1984-90) 8HP (1984-90) | | | | | |



| REF | OEM | | | 2T STROKES | 4T STROKES | |
|------------|--------------------------|------------|--------|------------|------------|-----------------|
| PH130-0049 | 689-81800-10, 11, 12, 13 | 12V 0.6 kw | 11 CCW | ✓ | | REC89-825096T01 |
| | 25-40HP 30HP/20HP | | | | | |



| REF | OEM | | | 2T STROKES | 4T STROKES | |
|------------|--|-----|--------|------------|------------|-----------------|
| PH130-0062 | 6J4-81800-00, 01 6G8-81800-10, 11 6F5-81800-10, 11 | 12V | 11 CCW | ✓ | | REC89-825096T01 |
| | 30 HP (1987+) 40-50 HP (1989+) | | | | | |



| REF | OEM | | | 2T STROKES | 4T STROKES | |
|------------|----------------------------|-----|-------|------------|------------|-----------------|
| PH130-0084 | 66M-81800-00, 01, 02 | 12V | 9 CCW | ✓ | | REC89-825096T01 |
| | F9.9, F15, F13.5 (1998-08) | | | | | |



| REF | OEM | | | 2T STROKES | 4T STROKES | |
|------------|---|------------|-------|------------|------------|-----------------|
| PH130-0005 | 6E5-81800-10, 11, 12 | 12V 1.1 kw | 9 CCW | ✓ | ✓ | REC61A-81941-00 |
| | F45 / F50 115-130 HP V4 150-175-200 HP V6 | | | | | |



| REF | OEM | | | 2T STROKES | 4T STROKES | |
|------------|--------------------------------|-----|-------|------------|------------|------------|
| PH130-0028 | 67C-81800-00, 01, 02 | 12V | 9 CCW | | ✓ | PH375-0036 |
| | F30 (2000-09) F40 (2001-09) | | | | | |

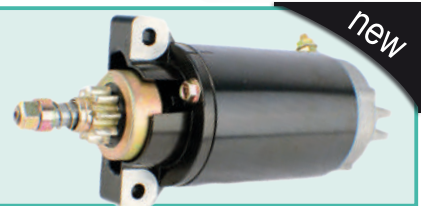

| REF | OEM | | | 2T STROKES | 4T STROKES | |
|------------|----------------------|-----|-------|------------|------------|--|
| PH130-0063 | 6H4-81800-10, 11, 12 | 12V | 9 CCW | ✓ | | |
| | 40-50 HP (1984-1988) | | | | | |



| REF | OEM | | | 2T STROKES | 4T STROKES | |
|------------|---|------------|-------|------------|------------|------------|
| PH130-0051 | 99999-03938 61H-81800-00, 01 6K7-81800-10 6N7-81800-00, 01, 10 | 12V 1.4 kw | 9 CCW | ✓ | | PH375-0047 |
| | 115-250HP V4 | | | | | |



| REF | OEM | | | 2T STROKES | 4T STROKES | |
|------------|--|--|-------|------------|------------|--|
| PH130-0059 | 61A-81800-00, 01 69L-81800-00 69W-81800-00 | 12V | 9 CCW | ✓ | ✓ | REC61A-81941-00 REC89-825096T01 (F40/50/60) |
| | V200 (1998+) F40 (2002-06) F50 (2003-14) | F60 (2003-07) 225 HWP (1994+) 250 HP (1990+) | | | | |



| REF | OEM | | | 2T STROKES | 4T STROKES | |
|------------|--|------------|-------|---------------|---------------|-----------------|
| PH130-0050 | 6H3-81800-10, 11 | 12V 0.6 kw | 9 CCW | ✓ | | REC688-81950-10 |
| | 50HP (1993-14) 60HP (1991+) 70HP (1984-14) | | | | | |

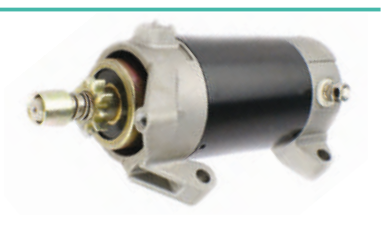

| REF | OEM | | | 2T STROKES | 4T STROKES | |
|------------|---|------------|-------|---------------|---------------|--|
| PH130-0007 | 99999-03249 697-81800-10, 11, 12 676-81800-10 | 12V 1.0 kw | 9 CCW | ✓ | | |
| | 55-60HP 2 cyl | | | | | |



| REF | OEM | | | 2T STROKES | 4T STROKES | |
|------------|---|-----|-------|---------------|---------------|-----------------|
| PH130-0058 | 688-81800-10, 11, 12 | 12V | 9 CCW | ✓ | | REC688-81950-10 |
| | 75 HP (1994-99) 85 HP (1991-96) 90 HP (1984-14) 85HP (1992-03) 80HP (1993-02) | | | | | |

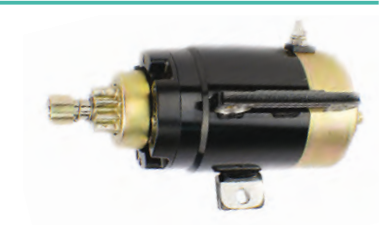

| REF | OEM | | | 2T STROKES | 4T STROKES | |
|------------|--|------------|--------|---------------|---------------|--|
| PH130-0056 | 6CJ-81800-00 6C5-81800-00 68F-81800-00, 01, 03 | 12V 1.4 kw | 13 CCW | ✓ | ✓ | |
| | LZ 150-175 HP (2000+) VZ 150-175 HP (2000+) Z 150-175 HP (2000+) LZ 200-2200 HP (2000+) | | | | | |

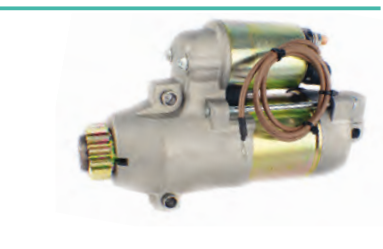

| REF | OEM | | | 2T STROKES | 4T STROKES | |
|------------|-----------------------------------|-----|-------|---------------|---------------|-----------------|
| PH130-0034 | 66M-81800-01, 02 | 12V | 9 CCW | | ✓ | PAF15-05170300W |
| | F9.9 F13.5 F15 HP (2000-08) | | | | | |



| REF | OEM | | | 2T STROKES | 4T STROKES | |
|-----------------|---|-----|----|---------------|---------------|--|
| PAF20-05000900W | 6AH-81800-00, 01 | 12V | 11 | | ✓ | |
| | F13,5 ALL (2007-09) F15 (2007-14) F20 ALL (2007-14) | | | | | |





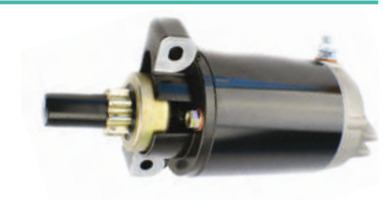

| REF | OEM | | | 2T STROKES | 4T STROKES | |
|------------|---|-----|-------|---------------|---------------|------------|
| PH130-0029 | 65W-81800-00, 01, 02, 03 | 12V | 9 CCW | | ✓ | PH375-0034 |
| | F20 F25HP (1999-09) F30/F40 (2005-09) | | | | | |







| REF | OEM | | | 2T STROKES | 4T STROKES | |
|------------|--|------------|--------|---------------|---------------|--|
| PH130-0057 | 68V-81800-00, 01, 02 | 12V 1.4 kw | 13 CCW | | ✓ | |
| | F80 (2005+) F100 (2005+) F115 (2000+) LF115 (2000+) | | | | | |



| REF | OEM | ⚡ | ☀️ | 2T STROKES | 4T STROKES |
|---|-----------------------------------|---|--------|------------|------------|
| PH130-0055 | 67F-81800-01, 02, 03, 04 | 12V 1.4 kw | 13 CCW | ✓ | ✓ |
|  | F80 HP (1999+) F100 HP (1999+) |  | | | |



| REF | OEM | ⚡ | ☀️ | 2T STROKES | 4T STROKES |
|---|---------------------------|---|--------|------------|------------|
| PH130-0074 | 69J-81800-00, 01 | 12V 1.4 kw | 13 CCW | ✓ | ✓ |
|  | F200, F225 HP (2002-2007) |  | | | |

| REF | OEM | ⚡ | ☀️ | 2T STROKES | 4T STROKES |
|---|--|---|--------|------------|------------|
| PH130-0073 | 63P-81800-00 6BR-81800-00, 01 | 12V 1.4 kw | 13 CCW | ✓ | ✓ |
|  | FL, F150 AET, X, L (2009-11) FL, F200 CETX (2009-11) FL, F225 BET X, U, CET, L (2009-11) FL, F250 AET, X, U, BET, X, U (2009-11) |  | | | |



| REF | OEM | ⚡ | ☀️ | 2T STROKES | 4T STROKES |
|---|--|---|--------|------------|------------|
| PH130-0076 | 60V-81800-00 60X-81800-00 6C9-81800-00 6D0-81800-00 | 12V 1.4 kw | 13 CCW | ✓ | ✓ |
|  | 250HP (2003-07) |  | | | |



MUELLE DE ARRANQUE STARTER SPRING MOLLA AVVIAMENTO RESSORT DE LANCEUR

| REF | OEM | 2T STROKES | 4T STROKES | new |
|---|--------------|---|------------|-----|
| PAF15-07130107 | 63V-15713-00 | ✓ | ✓ | |
|  | 6 - 25 hp |  | | |

| REF | OEM | 2T STROKES | 4T STROKES | new |
|---|----------------------------------|---|------------|-----|
| REC66T-15713-00 | 66T-15713-00 6F5-15713-00, 01 | ✓ | ✓ | |
|  | 25 - 40 hp |  | | |

TRINQUETE TRACCIÓN PAWL, DRIVE CRICCHETO TRAZIONE ENTRAÎNEMENT

| REF | OEM | 2T STROKES | 4T STROKES |
|---|--------------|---|------------|
| PAF15-07130202 | 63V-15741-00 | ✓ | ✓ |
|  | 6 - 40 hp |  | |

| REF | OEM | new |
|--|----------------|---|
| PAF15-07130203 | 63V-15767-00 | |
| PAF15-07130204 | 63V-15784-00 | |
|  | PAF15-07130203 |  |
| | | PAF15-07130204 |

CABLE DE MOTOR DE ARRANQUE A BATERIA CONNECTION LINE, POWER CAVO MOTORE DI AVVIAMENTO A BATTERIA CABLE DE CONNEXION

| REF | OEM | new |
|---|----------------------------------|---|
| PAT85-05000023 | 6C5-82105-01 6HO-82105-02, J2 | |
|  | -60 hp |  |

CABLE DE MOTOR DE ARRANQUE A BATERIA

CONNECTION LINE, POWER

CAVO MOTORE DI AVVIAMENTO A BATTERIA

CABLE DE CONNEXION

| REF | OEM |
|----------------|----------------------------------|
| PAT85-05000023 | 6C5-82105-01 6H0-82105-02, J2 |



new

TIRADOR DE ARRANQUE

STARTER HANDLE ASSY

MANIGLIA AVVIAMENTO

POIGNEE DE LANCEUR

| REF | OEM |
|---------------|------------------------------|
| PAF4-04130100 | 6G1-15755-00 6G1-15779-00 |



new

PLATO Y PLACA DE ARRANQUE MANUAL

PLATE & DRUM, DRIVE

PLACCA E PIATTO DI AVVIAMENTO MANUALE

TAMBOUR, POULIE

| REF | OEM | 2T STROKES | 4T STROKES |
|----------------|--------------|---------------|---------------|
| PAF15-07130201 | 63V-15714-00 | ✓ | ✓ |
| PAF15-07130001 | 63V-15716-00 | ✓ | ✓ |



new

LLAVES DE ARRANQUE

IGNITION STARTER SWITCH

CHIAVI DI ACCENSIONE

CONTACTEUR A CLÉ

MONTAJE EN MANDO DE CONTROL

CONTROL BOX

MONTAGGIO NEL TELECOMANDO

MONTAGE POUR BOITIER DE COMMANDE

| REF | OEM | 2T STROKES | 4T STROKES |
|-----------------|--------------|---------------|---------------|
| PAF15-13000200W | 703-82510-12 | ✓ | ✓ |



MONTAJE EN PANEL

DASH MOUNT

MONTAGGIO NEL PANNELLO

MONTAGE POUR TABLEAU DE BORD

| REF | OEM | 2T STROKES | 4T STROKES |
|-----------------|--------------|---------------|---------------|
| REC61B-82510-02 | 61B-82510-01 | ✓ | |



LLAVE DOBLE INSTALACION

DUAL ENGINE APPLICATION

CHIAVE DOPPIA INSTALLAZIONE

POUR INSTALLATION DOUBLE

| REF | OEM | 2T STROKES | 4T STROKES |
|-----------------|--------------|---------------|---------------|
| REC6K1-82510-07 | 6K1-82510-06 | ✓ | ✓ |



LLAVE CON CHOQUE

PUSH T. CHOKE

CHIAVE CON CONTATTO

AVEC STARTER

| REF | OEM | 2T STROKES | 4T STROKES |
|-----------------|--------------|---------------|---------------|
| REC703-82510-44 | 703-82510-43 | ✓ | ✓ |



LLAVE PARA MANDO POPERO

KEY FOR STERN CONTROL

CHIAVE PER COMANDO A GUIDA

CONTACTEUR A CLE COMPLET

new

| REF | OEM | 2T STROKES | 4T STROKES |
|-----------------|--------------------------|---------------|---------------|
| REC6H3-82510-03 | 6H3-82510-00, 01, 02, 03 | ✓ | ✓ |



55B (1992-00)
E60H (1996-97)
75A (1992-95)
85A (1995)



SOLENOIDE RELE

SOLENOID RELAY

SOLENOIDE RELE

SOLENOIDE RELAIS

| REF | OEM |
|------------|--------------|
| PH375-0034 | 65W-81941-00 |



F20 (1998-09)
F25 (1998-09)
F30 (2001-09)
F40 (2000-09)



| REF | OEM |
|-----------------|--------------|
| REC688-81950-10 | 688-81950-10 |



50G 80A
50D 90A
E60 60F
70B



| REF | OEM |
|-----------------|------------------------------|
| REC61A-81941-00 | 61A-81941-00 6E5-81941-11 |



150 175
200 115
225 130
250 100HP



| REF | OEM |
|-----------------|------------------------------|
| REC89-825096T01 | 6E5-81950-01 6G1-81940-00 |



6 - 90 HP



new

| REF | OEM |
|------------|------------------------------|
| PH375-0042 | 68V-8194A-00 68N-81940-00 |



F40 - F200 (2000-16)
Z / LZ / VZ200 (2004-07)
Z / LZ / VZ250 (2003-07)
Z / LZ / VZ300 (2004-07)



| REF | OEM |
|-----------------|--------------|
| PAF15-05170300W | 6G1-81941-10 |





6 - 90 HP



new

| REF | OEM |
|-----------------|------------------|
| REC61A-81950-01 | 61A-81950-00, 01 |

 50 -250 hp (1990-16) 2 Strokes
 F20, F25 (1998-09) 4 Strokes





| REF | OEM |
|-----------------|--------------|
| REC68V-81950-00 | 68V-81950-00 |

 20 - 300 HP



| REF | OEM |
|-----------------|--------------|
| REC6AW-8194A-00 | 6AW-8194A-00 |

 F30 / F40 (2009+)
 F300 (2008-11)
 F350 (2008+)



| REF | OEM |
|-----------------|--------------|
| REC60E-81950-00 | 60E-81950-00 |

 30 - 115 HP





| REF | OEM |
|-----------------|--------------|
| REC63P-81950-00 | 63P-81950-00 |

 F20 - F300





| REF | OEM |
|-----------------|--------------|
| REC6AW-81950-00 | 6AW-81950-00 |

 F150C/G (2017+)
 F1475C (2017+)
 F200C/G (2013+)
 F225C/F (2011+)
 F250B/D/C (2009+)
 F300A/B/C (2008+)
 F350A/C/T (2008+)



| REF | OEM | ⚡ |
|-----------------|--------------|-----|
| REC60V-81950-00 | 60V-81950-00 | 12V |

 Z250D,T,F (2003-07)
 Z300A,T (2004-07)





| REF | OEM | 2T STROKES | 4T STROKES |
|-----------------|------------------|------------|------------|
| REC6H1-81950-01 | 6H1-81950-00, 01 | ✓ | ✓ |

 30 / 40 / 45 / 50 / 60 HP (1995+)



| REF | OEM |
|------------|------------------------------|
| PH375-0048 | 6E5-8195A-01 6E5-8195C-01 |

 100 (1996-01)
 115 (1991-13)
 130 (1991-07)
 150 (1998-07)
 175 (1996-03)
 200 (1991-10)
 225 (1996-09)
 F100 A/AET/TLR/TRZ (1999-06)
 F100 BET (2003-12)
 F100 CETL (2003)
 40X/E40MLH (1998-03)
 F80A/AET/TLR (1999-06)





| REF | OEM |
|------------|--------------|
| PH375-0047 | 6E5-81950-01 |

 175HP (1991-96)
 200HP (1991-10)
 225HP (1996-09)
 150HP (1996-03)
 115HP (1995-13)
 100HP (1996-01)
 130HP (1991-07)



| REF | OEM | 2T STROKES | 4T STROKES |
|-----------------|--------------|------------|------------|
| REC68F-8195A-00 | 68F-8195A-00 | ✓ | ✓ |

 150 --> 350 HP







REGULADORES Y RECTIFICADORES

REGULATOR AND RECTIFIERS

REGOLATORI E RADDRIZZATORI



REGULATEURS ET RECTIFIEURS

| REF | OEM | 2T STROKES | 4T STROKES |
|-----------------|--------------|---------------|---------------|
| REC6H2-81960-10 | 6H2-81960-10 | ✓ | |

 40
 50
 60
 70







| REF | OEM | 2T STROKES | 4T STROKES |
|-----------------|--|---------------|---------------|
| REC6G1-81970-62 | 664-81970-60, 61, 62 676-81970-00 6E9-81970-70 6G1-81970-00, 60, 61, 62, A0 | | ✓ |

 4 & 5 HP (1 cyl)
 6, 8, 9.9, 15, 20, 25, 30, 40 (2 cyl)
 40, 50, 55, 60, 70 (3 cyl)



| REF | OEM | 2T STROKES | 4T STROKES |
|-----------------|--------------|---------------|---------------|
| REC67F-81960-12 | 67F-81960-00 | | ✓ |

 F75AETL (2003)
 F80A,TLR,TJRA (1999-06)
 F90AET,TRB,TLRB (2003)
 F100A,TLR,BET,CET (1999-12)







| REF | OEM | 2T STROKES | 4T STROKES |
|-----------------|--------------|---------------|---------------|
| REC6H0-81960-00 | 6H0-81960-00 | ✓ | |

 75A, AEM, AEHD
 85A, AE, AED, AEDL, AEDH, AEDX, AET, AETL, AETX
 E115 A, AE, AEL, AMH, AMHL, AET, AETL, AETX

693-6922 (1997-02)
688-688F (1997-15)
61U0-61UG (2001-15)





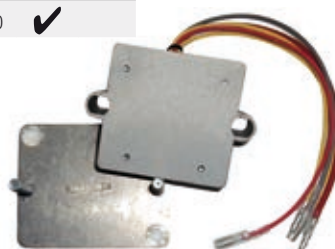

| REF | OEM | 2T STROKES | 4T STROKES |
|-----------------|--------------|---------------|---------------|
| REC6G5-81960-A0 | 6G5-81960-A0 | ✓ | |

 75 (1988-96)
 85 (1989-96)
 90 (1984-91)
 115 (1991-96)
 130 (1988-89)
 150 (1984-89)
 150 (1997)
 175 (1984-89)
 200 (1984-89)





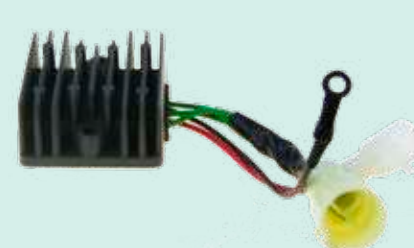

| REF | OEM | 2T STROKES | 4T STROKES |
|-----------------|--------------|---------------|---------------|
| REC6R3-81960-10 | 6R3-81960-10 | ✓ | |

 100A (1991)
 115C (1990-13)
 130B/T (1990-14)
 150C/F/T (1990-13)
 175B/D (1990-05)
 200B/C (1991-93)
 PROV200 (1991-94)
 225B (1990-91)







| REF | OEM | 2T STROKES | 4T STROKES |
|----------------|--------------|---------------|---------------|
| PAT85-05030300 | 6AH-81960-00 | | ✓ |

 F9.9H (2009+)
 F13.5B (2007-09)
 F15C/E/M (2007+)
 F20B/M (2007+)



| REF | OEM | 2T STROKES | 4T STROKES |
|-----------------|-----------------|---------------|---------------|
| REC6P2-81960-03 | 6P2-81960-02,03 | | ✓ |

 F200A/C (2006-15)
 F225A/B/C (2007-15)
 F250A/B/T (2006-13)





| REF | OEM | 2T STROKES | 4T STROKES |
|-----------------|----------------------|---------------|---------------|
| REC63P-81960-02 | 63P-81960-00, 01, 02 | | ✓ |

 F150A,T,B,D,F (2004+)





| REF | OEM | 2T STROKES | 4T STROKES |
|-----------------|------------------------------|---------------|---------------|
| REC61A-81960-04 | 61A-81960-00, 01, 02, 03, 04 | ✓ | |

 225C/G (1994-03)
 250A/B/E/G (1990-10)



| REF | OEM | 2T STROKES | 4T STROKES |
|-----------------|--------------|---------------|---------------|
| REC6G8-81960-A1 | 6G8-81960-A1 | | ✓ |

 F8B (1990-99)
 FT9.9D (1999-08)
 F9.9C/A/B/M (1990-08)
 F13.5A (2005-07)
 F15A/M/E/P (1998-07)



| REF | OEM | 2T STROKES | 4T STROKES |
|----------------|--------------|---------------|---------------|
| PAF15-07060001 | 6J8-81960-00 | ✓ | ✓ |

 6 - 50 HP

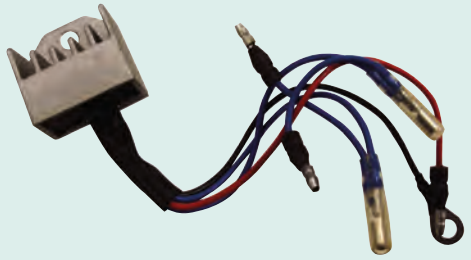

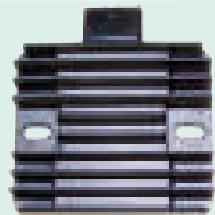

| REF | OEM | 2T STROKES | 4T STROKES |
|------------|------------------------------|---------------|---------------|
| REC881346T | 68V-81960-00 6D3-81960-00 | | ✓ |

 T/FT/F50 (2005-06)
 T/FT/F60C/D/T (2005-06)
 F75B/T (2005)
 F80B (2005-06)
 F100D (2005-06)
 F115A/T (2000-06)



| REF | OEM | 2T STROKES | 4T STROKES |
|-----------------|--------------------------|---------------|---------------|
| REC69J-81960-13 | 69J-81960-10, 11, 12, 13 | | ✓ |

 F200A/T (2003-07)
 F225A/T (2003-07)



| REF | OEM | 2T STROKES | 4T STROKES |
|-----------------|----------------------------------|---------------|---------------|
| REC60V-81960-05 | 60V-81960-00, 01, 02, 03, 04, 05 | ✓ | |

 250D/F/T (2003-07)
 300A/T (2004-07)

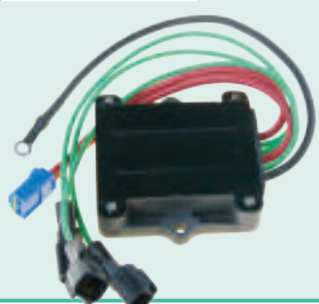
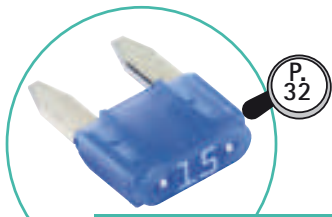
CDI Y CAJAS NEGRAS

CDI & POWER PACK

CDI E CENTRALINA

CDI ET BOITIER ELECTRONIQUE

| REF | OEM | 2T STROKES | 4T STROKES |
|-----------------|--------------|---------------|---------------|
| REC688-85540-00 | 688-85540-00 | ✓ | |

 E75 BMHD, BMHDL
 75 A, AED, AEDL, AEM, AEHD, AET, AETL
 75A
 85, A, AE, AED, AEDL, AEDX, AEHD, AET, AETX
 85A

6925 - 692Y (2003-15)
 692 - 692Y (1997-15)
 692E (2008)
 688 - 688F (1997-15)
 6886 - 6887 (2007-08)







| REF | OEM | 2T STROKES | 4T STROKES |
|-----------------|--|---------------|---------------|
| REC6G9-85540-29 | 6G9-85540-29 6G9-85540-22 6G9-85540-21 6G9-85540-20 | | ✓ |

 F8B (1985-99)
 F9.9B (1985-99)
 2 CYL.







| REF | OEM | 2T STROKES | 4T STROKES |
|----------------|--------------|---------------|---------------|
| PAF20-05000300 | 6AH-85540-00 | | ✓ |

 F9.9H (2009+)
 F13.5 B (2008-09)
 F15C/E/M (2007+)
 F20B/E/M (2007+)



| REF | OEM | 2T STROKES | 4T STROKES |
|-----------------|------------------------------|---------------|---------------|
| REC63D-85540-04 | 63D-85540-00, 01, 02, 03, 04 | | ✓ |

 3 cyl
 C40 (1996-03)
 40V,E,Y (1995+) C50 (2000)
 50H (1995-03)





| REF | OEM | 2T STROKES | 4T STROKES |
|----------------|--------------|---------------|---------------|
| PAF15-07000500 | 66M-85540-10 | | ✓ |

 F9.9C, M (2002-07)
 F13.5 A (2002-07)
 F155A,E,M,P (2002-07)







| REF | OEM | 2T STROKES | 4T STROKES |
|-----------------|--------------|---------------|---------------|
| REC6F6-85540-01 | 6F6-85540-01 | | ✓ |

 E40G (2008-16)







| REF | OEM | 2T STROKES | 4T STROKES |
|-----------------|----------------------|---------------|---------------|
| REC6H3-85540-11 | 6H3-85540-10, 11, 12 | | ✓ |

 3 cyl (1984+)
 60F/E60H,E,M
 70E,B



| REF | OEM | 2T STROKES | 4T STROKES |
|-----------------|--------------------------|---------------|---------------|
| REC6H3-85540-13 | 6H3-85540-10, 11, 12, 13 | | ✓ |

 60F (1984-91)
 70B,E (1984-91)
 E60H,E (2000+)







| REF | OEM | 2T STROKES | 4T STROKES |
|--------------------|----------------------|---------------|---------------|
| REC63V-85540-00-01 | 63V-85540-00, 01, 02 | | ✓ |

 9,9 - 15HP (1995+)
 63V & 63W







| REF | OEM | 2T STROKES | 4T STROKES |
|-----------------|--------------------------|---------------|---------------|
| REC6H2-85540-13 | 6H2-85540-10, 11, 12, 13 | | ✓ |

 50G (1997-07)
 60F,T (1997-10)
 70B,T (1997-17)





| REF | OEM | 2T STROKES | 4T STROKES |
|-----------------|--------------|---------------|---------------|
| REC68T-85540-00 | 68T-85540-00 | | ✓ |

 F6A/B/M (2001-05)
 T/FT/F8C/M (2000+)
 T/FT/F9.9F/M/J (2008+)





| REF | OEM | 2T STROKES | 4T STROKES |
|-----------------|------------------|---------------|---------------|
| REC6A1-85540-01 | 6A1-85540-00, 01 | | ✓ |

 2B,M,C (1995-10)





| REF | OEM | 2T STROKES | 4T STROKES |
|-----------------|--------------------------|---------------|---------------|
| REC6G9-85540-29 | 6G9-85540-20, 21, 22, 29 | | ✓ |

 F8B (1985-99)
 F9.9B, M, E (1985-06)



| REF | OEM | 2T STROKES | 4T STROKES |
|---|--|---------------|---------------|
| REC63V-85540-00-01 | 63V-85540-00,01 | ✓ | |
|  | 9.9, 15HP (1995-08) 13, 5HP (2003-04) | | |





| REF | OEM | 2T STROKES | 4T STROKES |
|---|--------------|---------------|---------------|
| REC6F5-85540-22 | 6F5-85540-22 | ✓ | |
|  | E40 (2003) | | |



| REF | OEM | 2T STROKES | 4T STROKES |
|---|--|---------------|---------------|
| REC61N-85540-00 | 61N-85540-00 | ✓ | |
|  | 25 (1997-07) 30 (1996-08) 200 (1993) | | |





| REF | OEM | 2T STROKES | 4T STROKES |
|---|---|---------------|---------------|
| REC695-85540-11 | 695-85540-11,12 | ✓ | |
|  | E40 (2003) 9.9 (1986-95) 15 (1986-95) 20 (1985-02) 25 (1985-02) | | |





| REF | OEM | 2T STROKES | 4T STROKES |
|---|---|---------------|---------------|
| REC6G0-85540-11 | 6G0-85540-11 | ✓ | |
|  | 175 (1986-89) 200 (1986-89) 150 (1988) 225 (1987-89) | | |





| REF | OEM | 2T STROKES | 4T STROKES |
|---|-----------------|---------------|---------------|
| REC663-85540-15 | 663-85540-11,15 | ✓ | |
|  | 55 (1990-93) | | |





| REF | OEM | 2T STROKES | 4T STROKES |
|---|----------------------|---------------|---------------|
| REC6E0-85540-71 | 6E0-85540-71,70 | ✓ | |
|  | 4 (1984) 5 (1984) | | |



| REF | OEM | 2T STROKES | 4T STROKES |
|---|---|---------------|---------------|
| REC6E5-85540-12 | 6E5-85540-12,11,10 | ✓ | |
|  | 115 (1984-89) 115 (1991-98) 130 (1988-89) | | |



| REF | OEM | 2T STROKES | 4T STROKES |
|---|---|---------------|---------------|
| REC689-85540-21 | 689-85540-21,20 | ✓ | |
|  | 25 (1984-87) 30 (1984-87) 30 (1989-90) 40 (1990) | | |



| REF | OEM | 2T STROKES | 4T STROKES |
|---|--------------------|---------------|---------------|
| REC6G5-85540-12 | 6G5-85540-12,11,10 | ✓ | |
|  | 150HP (1984-89) | | |

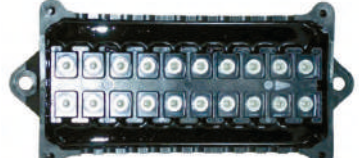

| REF | OEM | 2T STROKES | 4T STROKES |
|---|----------------------------|---------------|---------------|
| REC696-85540-12 | 696-85540-12,11,10 | ✓ | |
|  | 6 (1984-99) 8 (1984-04) | | |



| REF | OEM | 2T STROKES | 4T STROKES |
|---|-------------------------------|---------------|---------------|
| REC66T-85540-00-01 | 66T-85540-01 | ✓ | |
|  | 40X/E40X MLH XW (1998+) | | |



| REF | OEM | 2T STROKES | 4T STROKES |
|-----------------|--------------|------------|------------|
| REC6B4-85540-01 | 6B4-85540-01 | ✓ | |

 E9.9 DMH-5 (2003+)
 E15 DMH -5 (2003+)





| REF | OEM | 2T STROKES | 4T STROKES |
|-----------------|--------------|------------|------------|
| REC688-85540-16 | 688-85540-16 | ✓ | |

 75
 85



| REF | OEM | 2T STROKES | 4T STROKES |
|-----------------|--------------|------------|------------|
| REC6J8-85540-H2 | 6J8-85540-H2 | ✓ | |

 25J/EO/SH (1999)
 30D/ETOL/EOS/MHS
 MHOL, E, L, H
 (1999+)



DESCONECTORES DE SEGURIDAD CUT OFF SWITCHES CHIAVETTA DI SICUREZZA COUPE CIRCUIT DE SECURITE

| REF | OEM |
|-----------------|--------------|
| REC688-82575-01 | 688-82575-01 |

 9.9 --> 250 HP



| REF | OEM |
|-----------------|--------------|
| REC6E9-82575-02 | 6E9-82575-00 |

 E30/GE/BMH (1996-12)
 25V/M/E/B (1996-10)
 6/8C/TRV/MSH (1996-12)



| REF | OEM |
|-----------------|--------------|
| REC69W-82575-00 | 69W-82575-00 |

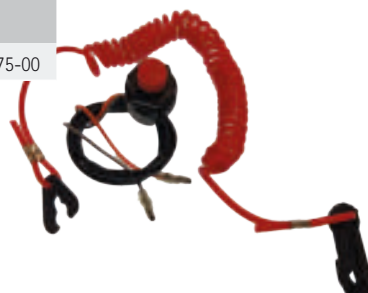

| REF | OEM |
|---------------|--------------|
| PAF4-01090401 | 682-82556-00 |

new



| REF | OEM |
|-----------------|--------------|
| REC66T-82575-01 | 66T-82575-01 |

 E40X
 MLHZ
 X
 MH (2001+)



| REF | OEM |
|-----------------|--------------|
| REC65W-82575-01 | 65W-82575-01 |

 F2.5
 T-F 6-8
 F9.9 -F15
 9.9F-M
 F13.5
 F25 (2002+)





| REF | OEM |
|-----------------|--------------|
| REC6G8-81870-00 | 6G8-81870-00 |

 F8A-B (1986-99)
 F9.9A M,E,B (1985-99)
 9.9F (1995-2000)
 9.9-15-8-6/C-M-D (1984-2002)



| REF | OEM |
|-----------------|--------------|
| REC6A0-82550-01 | 6A0-82550-01 |

 9.9D/15D (1985-93)
 8N/JCEM (1984-96)
 6CEM/6DEM (1984-96)



KITS

Interruptor de encendido para todo tipo de motores fueraborda o intraborda

| REF KIT | CUERDA WIRE CORDA CORDON | |
|----------|--------------------------|---|
| REC40970 | REC40990 | 1 |

KITS

Emergency and stop switch for inboard or outboards.



KIT

Interruttore di accensione per tutti i tipi di motori fuoribordo o entro bordo.

| REF KIT | CUERDA WIRE CORDA CORDON | |
|---------|--------------------------|---|
| GS11290 | GS11291 | 1 |



KITS

Coupe circuit de sécurité pour moteur inboard ou hors-bord

| REF KIT | |
|---------|---|
| GS11292 | 1 |



| REF | |
|---------|---|
| GS11294 | 1 |



STARTOR

| REF | OEM | 2T STROKES | 4T STROKES |
|-----------------|------------------------------|------------|------------|
| REC688-85510-10 | 688-85510-10 688-85510-11 | ✓ | |

- 75 (1988-96)
- 85 (1989-96)
- 90 (1984-90)



| REF | OEM | 2T STROKES | 4T STROKES |
|-----------------|-----------------|------------|------------|
| REC6E5-85510-11 | 6E5-85510-11,10 | ✓ | |

- 115 (1984-89), (1991-98)
- 130 (1988-89)
- 150 (1984-89)



| REF | OEM | 2T STROKES | 4T STROKES |
|-----------------|------------------|------------|------------|
| REC688-85510-01 | 688-85510-00, 01 | ✓ | |

- E75 BMHD, BMHDL (6925 - 692Y) (2003-15)
- 75 A, AED, AEDL, AEM, AEHD, AET, AETL (692 - 692Y) (1997-15)
- 75 A (692E) (2008)
- 85 A, AE, AED, AEDL, AEDX, AEHD, AET, AETX (688 - 688F) (1997-15)
- 85 A (6886 - 6887) (2007-08)



| REF | OEM | 2T STROKES | 4T STROKES |
|----------------|--------------|------------|------------|
| PAF25-05140000 | 65W-85510-10 | ✓ | |

- F20 (1998-06)
- F25 (1998-09)
- T25/FT25 (2000-09)
- F30 (2001-09)
- F40 (2000-09)



| REF | OEM | 2T STROKES | 4T STROKES |
|-----------------|--------------|------------|------------|
| REC6G5-85510-11 | 6G5-85510-10 | ✓ | |

- 200 (1984-89)



| REF | OEM | 2T STROKES | 4T STROKES |
|-----------------|--------------|------------|------------|
| REC6H1-85510-00 | 6H1-85510-00 | ✓ | |

- 80A AE (1990-91)
- 90 AEO AETO (1990-91)

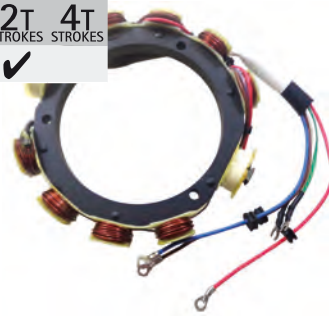

| REF | OEM | 2T STROKES | 4T STROKES |
|----------------|--------------|------------|------------|
| PAF20-05000200 | 6AH-85510-00 | ✓ | |

- F9,9 (2009+)
- F13,5B (2007-09)
- F15C,E,M (2007+)
- F20B,M (2007+)



new

TRIM, TILT & POWER TRIM

INSTALACIÓN ELÉCTRICA

WIRING HARNESS

INSTALLAZIONE ELETTRICA

INSTALLATION ELECTRIQUE

KIT CONVERSIÓN

Sustituye de 2 a 3 cables.

CONVERSION KIT

Converts 3-wire Tilt and Trim motors to 2-Wire design

KIT CONVERSIONE

Sustituisce da 2 a 3 cavi.

FAISCEAU CONVERTISSEUR 3 A 2 FILS

| REF | OEM |
|------------|-----|
| PH200-WH01 | |



INTERRUPTOR POWER TRIM POWER TRIM SWITCH

| REF | OEM |
|-----------------|------------------------------|
| REC6R3-82563-01 | 6R3-82563-00 6R3-82563-01 |

100 - 250 HP

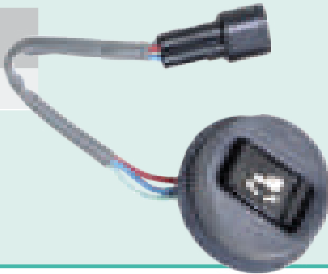

INTERRUTTORE POWER TRIM

| REF | OEM |
|----------------|------------------|
| PAE4-10040100W | 703-82563-00, 01 |

Para mandos 703
For controls 703
Per comandi 703
Pour 703

INTERRUPTEUR DE TRIM

new



TRIM COMPLETO BIDIRECCIONAL

COMPLETE TRIM ASSEMBLY

MOTORINO TRIM COMPLETO

MOTEUR DE TRIM

| REF | OEM | ⚡ | ⚙️ | ⚙️ | 2T STROKES | 4T STROKES |
|-----------------|------------------|-----|----|----|------------|------------|
| REC67C-43880-01 | 67C-43880-00, 01 | 12V | 4 | 2 | | ✓ |

T25 / FT25 (68V0 - 68V9) (2001-09)
T25 / FT25 (6BL1 - 6BL8) (2009-15)
F30 (69H1 - 69H9) (2001-09)
F30 (6BT1 - 6BT8) (2009-15)
F40 (67C0 - 67C8) (2001-09)
F40 (6BG1 - 6BG8) (2009-15)



| REF | OEM | ⚡ | ⚙️ | ⚙️ | 2T STROKES | 4T STROKES |
|------------|--------------------------|-----|----|----|------------|------------|
| PH200-T048 | 6H5-43880-00, 01, 02, 09 | 12V | 4 | 2 | | ✓ |

40-50HP (1984-94)



| REF | OEM | ⚡ | ⚙️ | ⚙️ | 2T STROKES | 4T STROKES |
|------------|--------------|-----|----|----|------------|------------|
| PH200-T029 | 6H1-43880-02 | 12V | 3 | 2 | ✓ | |

40HP (1994)
50-90HP (1992-95)
70-90 (1996)
60-70-90 (1998)
90HP (1992-02)



| REF | OEM | ⚡ | ⚙️ | ⚙️ | 2T STROKES | 4T STROKES |
|------------|--|-----|----|----|------------|------------|
| PH200-T036 | 62Y-43880-01, 02 69W-43880-00, 01 CS3-43880-00 | 12V | 3 | 2 | ✓ | ✓ |

40Y (2005-07)
40V (2003)
C40 (2002)
F40 (2002)
F50 (2002-07)
FT50



| REF | OEM | ⚡ | ⚙️ | ⚙️ | 2T STROKES | 4T STROKES |
|------------|----------------------|-----|----|----|------------|------------|
| PH200-T035 | 62X-43880-00, 01, 09 | 12V | 3 | 2 | ✓ | ✓ |

40V (1995-98)
F45 (1995-99)
50H (1995-98)
F50 (1995-99)
FT50 (1996-00)



| REF | OEM | ⚡ | ⚙️ | ⚙️ | 2T STROKES | 4T STROKES |
|------------|--------------|-----|----|----|------------|------------|
| PH200-T041 | 6H1-43880-00 | 12V | 3 | 2 | ✓ | |

60F (1987-91)
70B (1987-91)
75A (1990-91)
80A (1987-91)
85A (1990-91)
90A (1987-91)



+ relés conversión | relay | rele | relais

| REF | OEM | ⚡ | 🔩 | 🔧 | 2T STROKES | 4T STROKES |
|------------|--------------|-----|---|---|------------|------------|
| PH200-T044 | 67F-43880-00 | 12V | 4 | 2 | | ✓ |

F75 (2003-04)
 F80 (1999-05)
 F90 (2003-04)
 F100 (1999-05)



| REF | OEM | ⚡ | 🔩 | 🔧 | 2T STROKES | 4T STROKES |
|----------------|------------------|---|---|---|------------|------------|
| PAT40-10020500 | 65W-43880-00, 01 | | 4 | 2 | | ✓ |

F20AE, AET, DET (1998-15)
 F25A, AET, AMH, AW, EH, ELH, MHA, DMH, DET (1998-15)
 F45AET/F50TJR (1999)
 25J, JEO, ESH (1999)
 30D, DETO, DMH (1999-10)
 40X/E40X (1998-03)



| REF | OEM | ⚡ | 🔩 | 🔧 | 2T STROKES | 4T STROKES |
|------------|----------------------|-----|---|---|------------|------------|
| PH200-T068 | 6D8-43880-00, 01, 09 | 12V | 4 | 2 | | ✓ |

F75
 F80
 F100

EJE CORTO
 SHORT SHAFT
 ASSE CORTO
 AXE COURT



| REF | OEM | ⚡ | 🔩 | 🔧 | 2T STROKES | 4T STROKES |
|-----------------|------------------|-----|---|---|------------|------------|
| REC6D8-43880-09 | 6D8-43880-00, 09 | 12V | 4 | 2 | | ✓ |

F75TR, TLR, BET (2005)
 F80AET, BET (2005-06)
 F100AET, DET (2005-06)

EJE LARGO
 LONG SHAFT
 ASSE LUNGO
 AXE LONG



| REF | OEM | ⚡ | 🔩 | 🔧 | 2T STROKES | 4T STROKES |
|------------|----------------------------------|---|---|---|------------|------------|
| PH200-T069 | 69J-43880-00, 01 60V-43880-00 | | 3 | 2 | | |

F200
 F225 (2002+)
 F250 (2005+)
 Z300



| REF | OEM | ⚡ | 🔩 | 🔧 | 2T STROKES | 4T STROKES |
|-----------------|----------------------|-----|---|---|------------|------------|
| REC6AW-43880-02 | 6AW-43880-00, 01, 02 | 12V | 2 | 2 | | ✓ |

F300A (2008-11)
 F350A (2008+)

new



| REF | OEM | ⚡ | 🔩 | 🔧 | ∅ | 2T STROKES | 4T STROKES |
|------------|--------------------------------------|-----|---|---|---------|------------|------------|
| PH200-T037 | 688-43880-11 6E5-43880-00, 01, 02 | 12V | 3 | 3 | 68,3 mm | | ✓ |

60 90
 70 115
 75 150
 80 200HP
 85

14 mm



| REF | OEM | ⚡ | 🔩 | 🔧 | 2T STROKES | 4T STROKES |
|------------|----------------------|-----|---|---|------------|------------|
| PH200-T030 | 6G5-43880-00, 01, 02 | 12V | 3 | 2 | | ✓ |

115-200 (1987-95)
 225 (1990-94)



| REF | OEM | ⚡ | 🔩 | 🔧 | 2T STROKES | 4T STROKES |
|------------|--|-----|---|---|------------|------------|
| PH200-T057 | 6AE-43880-00, 01, 03, 04 68W-43880-03 67H-43880-00 | 12V | 4 | 2 | | ✓ |

225
 250HP
 115
 225 (1997-02)



| REF | OEM | ⚡ | 🔩 | 🔧 | 2T STROKES | 4T STROKES |
|------------|------------------|---|---|---|------------|------------|
| PH200-T045 | 6C5-43880-00, 01 | | 3 | 1 | | ✓ |

F40 (2006-10)
 F60 (2006-10)
 F50 (2005-10)
 FT60 (2006-10)
 40-50HP (1985-92)



| REF | OEM | ⚡ | 🔩 | ✂️ | 2T STROKES | 4T STROKES |
|------------|------------------|-----|---|----|------------|------------|
| PH200-T050 | 61A-43880-00, 01 | 12V | 3 | 4 | ✓ | |

🔧 225
250HP



| REF | OEM | ⚡ | 🔩 | ✂️ | 2T STROKES | 4T STROKES |
|-----------------|--|-----|---|----|------------|------------|
| REC63P-43880-22 | 63P-43880-10 63P-43880-11 63P-43880-12 63P-43880-22 | 12V | 3 | 2 | | ✓ |

🔧 F150A/B/C/D/F/G (2012+)
F175A,C (2018+)
F200B,C,F,G (2018+)



POWER TRIM COMPLETO **COMPLETE POWER TRIM ASSEMBLY**

| REF | OEM | 2T STROKES | 4T STROKES |
|------------|---|------------|------------|
| REC18-6865 | 63P-43880-03-00 64E-43880-02-40 68V-43880-03-40 | ✓ | ✓ |

🔧 3 RAM
115-225HP
SHOWA SYSTEM



MOTORINO POWER TRIM COMPLETO **POWER TRIM COMPLET**

| REF | OEM | 2T STROKES | 4T STROKES |
|----------------|--|------------|------------|
| PAT40-10000000 | 65W-43800-02-4D 65W-43800-03-4D 65W-43800-21-4D 65W-43800-22-8D 65W-43800-23-8D 65W-43800-20-4D 65W-43800-01-4D 65W-43800-00-4D | ✓ | ✓ |

🔧 F20 / F25
E40 / 40X
30D



| REF | OEM | 2T STROKES | 4T STROKES |
|-----------------|--|------------|------------|
| REC63P-43800-20 | 63P-4380003, 04, 06, 07, 20 64E-43880-02-40 68V-43880-03-40 | ✓ | ✓ |

🔧 115-220 HP (2003+)
SHOWA SYSTEM



| REF | OEM | 2T STROKES | 4T STROKES |
|----------------|------------------|------------|------------|
| PAF60-06000000 | 6C5-43800-11, 12 | | ✓ |

🔧 F40/ F50/ F60 (2016+)



| REF | OEM | 2T STROKES | 4T STROKES |
|--------------------|---|------------|------------|
| REC6H1-43800-17-8D | 6H1-43800-17-8D 6H1-43800-16-4D 6H1-43800-15-4D 6H1-43800-13-4D 6H1-43800-14-4D | ✓ | |

🔧 50 - 90 HP

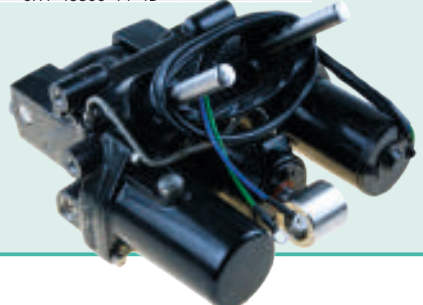

| DESPIECE PISTÓN TRIM | PARTI PISTONE TRIM | PARTI PISTONE TRIM | PIECES VERIN DE TRIM |
|----------------------|---|---------------------------|--|
| REF | OEM | | UN. |
| REC64E-43821-05 | 64E-43821-00, -05 64E4382100, 64E4382105 | TORNILLO CILINDRO EXTREMO | SCREW VITE VIS 2 |
| REC48630-96J03 | 64E-43821-08, 09, 00 64E-43820-08, 09, 00 6AW-4380R-00 | TAPÓN PARA SHOWA SYSTEM | CAP FOR SHOWA SYSTEM TAPPO PER SHOWA SYSTEM NEZ DE VERIN DE TRIM POUR SHOWA SYSTEM 2 |
| 1 REC48630-94900 | 67F-4380R-01, -00 67F-43811-00 61A-43821-00, -01, -09 | TORNILLO CILINDRO EXTREMO | SCREW VITE VIS 2 |
| REC48630-92J00 | 6EK-4380R-00 64E-43821-05 63P-43811-20, -10 64E-43811-02 61A-43811-00 6AW-4380R-01 | TAPÓN PARA SHOWA SYSTEM | CAP FOR SHOWA SYSTEM TAPPO PER SHOWA SYSTEM NEZ DE VERIN DE TRIM POUR SHOWA SYSTEM 2 |
| 2 REC64E-43822-00 | 64E-43822-00 | SELLO | SEAL OIL PARAOLIO JOINT TORIQUE 2 |
| 3 REC64E-4384J-00 | 64E-4384J-00 | SELLO | SEAL OIL PARAOLIO JOINT TORIQUE 2 |
| 4 REC6G5-43864-00 | 6G5-43864-00 | SELLO | SEAL OIL PARAOLIO JOINT TORIQUE 2 |

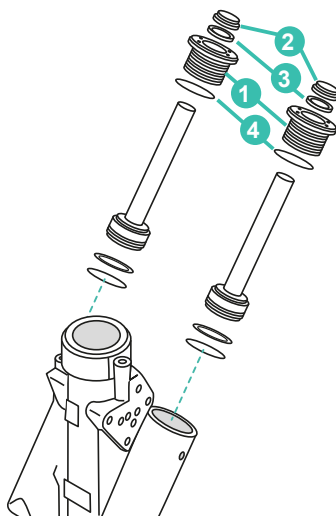

| REF | OEM |
|----------------|---|
| REC48630-94900 | 67F-4380R-01, -00 67F-43811-00 61A-43821-00, -01, -09 |

 F75B/T (2005)
 F80A/B/T (1999-18)
 F100A/C/D (1999-18)
 F200, F225, F250 (2002-12)
 Z200, Z300 (2003-12)
 250G (2006-10)
 F300 (2011-12)



| REF | OEM |
|----------------|---|
| REC48630-92J00 | 6EK-4380R-00 64E-43821-05 63P-43811-20, -10 64E-43811-02 61A-43811-00 6AW-4380R-01 |



| REF | OEM |
|-----------------|--|
| REC64E-43821-05 | 64E-43821-00 64E-43821-05 64E4382100 64E4382105 |



| REF | OEM |
|----------------|--|
| REC48630-96J03 | 64E-43821-08, 09, 00 64E-43820-08, 09, 00 6AW-4380R-00 |

 100 - 300 HP
 F300, F350 (V8) (2008-12)



EXTRACTOR TAPONES DE TRIM TRIM PLUGS EXTRACTOR

| REF | RECTOOLTRIM1 + RECTOOLTRIM2 + RECTOOLTRIM 3 |
|----------------|---|
| RECTOOLTRIMKIT | |



| REF | 1/2" | + RECPIN4 | + RECPIN4.5 | 38 mm |
|--------------|------|-----------|-------------|-------|
| RECTOOLTRIM1 | 1/2" | + RECPIN4 | + RECPIN4.5 | 38 mm |
| RECTOOLTRIM2 | 1/2" | + RECPIN4 | + RECPIN4.5 | 32 mm |
| RECTOOLTRIM3 | 1/2" | + RECPIN6 | | 35 mm |

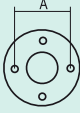

ESTRATTORE PER TAPPI DI TRIM KIT EXTRACTEUR

| TRIM PISTON | TILT PISTON | Icon |
|--------------|--------------|--------------------------|
| RECTOOLTRIM1 | | F25 - F40 |
| RECTOOLTRIM2 | RECTOOLTRIM3 | F115 (2000-14) |
| RECTOOLTRIM2 | RECTOOLTRIM3 | F150 (2004-10) |
| RECTOOLTRIM2 | RECTOOLTRIM1 | F150 (2011+) |
| RECTOOLTRIM2 | RECTOOLTRIM3 | F175 - F200 (2.8L) |
| RECTOOLTRIM1 | RECTOOLTRIM1 | F200 - F250 (3.3L) |
| RECTOOLTRIM1 | RECTOOLTRIM1 | F225 - F300 (4.2L) |
| RECTOOLTRIM2 | RECTOOLTRIM3 | F350 |
| RECTOOLTRIM2 | | F425 |
| RECTOOLTRIM2 | | 55-90 (2-Stroke) (1994+) |
| RECTOOLTRIM2 | RECTOOLTRIM3 | 115-200 + VMAX |
| RECTOOLTRIM1 | RECTOOLTRIM1 | 225 (2-Stroke) |



KITS DE RECAMBIO

Los pines de repuesto no tienen garantía.

| REF | |
|-----------|----------------|
| RECPIN4 | 3 PIN x 4 mm |
| RECPIN4.5 | 3 PIN x 4.5 mm |
| RECPIN6 | 3 PIN x 6 mm |

SPARE KITS

Replacement pins are not guaranteed.



KIT DI RICAMBIO

I perni di ricambio non sono garantiti.

KIT DE RECHANGE

Les pines de remplacement ne sont pas garanties

SISTEMA DE GOBIERNO STEERING SYSTEM

SISTEMA DI GUIDA SYSTÈME DE DIRECTION

MANDOS DE CONTROL

ENGINE CONTROLS

COMANDI DI CONTROLLO

BOITIER DE COMMANDE

MANDO LATERAL (703) PUSH TO OPEN

SIDE CONTROL (703) PUSH TO OPEN

COMANDO LATERALE (703) PUSH TO OPEN

BOITIER LATERAL (703) PUSH TO OPEN

Conector de 7 pins. Sin PowerTrim
Para motores fueraborda Yamaha de 9,9
Electric a 30 Hp. Leva para aceleración en
punto muerto. Utiliza cables 33-C

Connector 7 pins. Without PowerTrim
For outboard engines Yamaha 9,9 Electric to
30 Hp. Lever for neutral engine warm-up.
For 33-C cables

Conettore da 7 pins. Sin PowerTrim
Per motori fuoribordo Yamaha da 9,9
Electric a 30 Hp. Leva per accelerare in un
punto morto. Utilizza cavi 33-C.

Connecteur 7 broches. Sans Trim. Pour
moteur hors-bord Yamaha de 9.9
électrique à 30cv. Utilise des câbles 33C.

| REF | OEM | 2T STROKES | 4T STROKES | |
|------------------------------------|--------------|------------------------|---------------|---|
| REC703-48230-14 PAF15-13000000W | 703-48230-10 | | | |
| | 703-48230-11 | | | |
| | 703-48230-12 | | | |
| | 703-48230-13 | | | |
| | 703-48230-14 | | | |
| | 703-48230-15 | 9.9 - 70 HP (1986+) | ✓ | ✓ |
| | 703-48230-16 | | | |
| | 703-48230-17 | | | |
| | 703-48230-18 | | | |
| | 703-48230-1A | | | |
| | 703-48230-20 | | | |
| 703-48230-21 | | | | |



RECMAR®

Conector de 10 pins. Con PowerTrim
Para motores fueraborda Yamaha de 40
a 250 Hp. Leva para aceleración en punto
muerto. Con interruptor y cableado de
Power Trim. Utiliza cables 33-C

Connector 10 pins. With PowerTrim
Dual function, single lever control, For
outboard Yamaha 40 to 250 Hp. With power
trim switch and wires. For 33-C cables.

Conettore da 10 pins. Con PowerTrim
Per motori fuoribordo Yamaha da 40 a 250
Hp. Leva per accelerare in un punto morto.
Con interruttore e cablaggio di Power Trim.
Utilizza cavi 33-C.

Connecteur 10 broches. Avec Trim
interrupteur et faisceau. Boitier pour
moteur hors-bord Yamaha de 40 à 250cv.
Lever pour se mettre au point mort. Utilise
des câbles 33C.

| REF | OEM | 2T STROKES | 4T STROKES | |
|------------------------------------|--------------|-----------------------|---------------|---|
| REC703-48205-16 PAT85-08010000W | 703-48205-10 | | | |
| | 703-48205-11 | | | |
| | 703-48205-12 | | | |
| | 703-48205-13 | | | |
| | 703-48205-14 | | | |
| | 703-48205-15 | 8 - 300 HP (1984+) | ✓ | ✓ |
| | 703-48205-16 | | | |
| | 703-48205-17 | | | |
| | 703-48205-18 | | | |
| | 703-48205-1A | | | |
| | 703-48205-1B | | | |
| | 703-48205-20 | | | |
| | 703-48205-21 | | | |



RECMAR®



MANDO LATERAL PULL TO OPEN

SIDE CONTROL PULL TO OPEN

COMANDO LATERALE PULL TO OPEN

BOITIER LATERAL PULL TO OPEN

| REF |
|------------------|
| PAF40-13000000E1 |



new

PUSH TO OPEN

| REF | OEM |
|-----------------|--------------|
| PAF15-13000500W | 703-48261-01 |



new

PULL TO OPEN

| REF | OEM |
|-----------------|--------------|
| PAT20-13000500W | 703-48861-11 |



new

MANDO LATERAL

SIDE CONTROL

COMANDO LATERALE

BOITIER LATERAL

Mando a distancia de palanca con doble función (acelerador y cambio). Para motores intraborda e intra-fueraborda. Montaje lateral superpuesto. Utiliza cables 33-C.

Dual function, single lever control, For virtually all stern drive, outboard and inboard engines. Push button for neutral engine warm-up. For 33-C cables.

Comando a distanza di leve con doppia funzione acceleratore e cambio. Per motori entro-bordo e entro-fuoribordo. Montaggio laterale sovrapposto. Utilizza cavi 33-C.

Boitier mono levier bi-fonction accélérateur et inverseur pour moteur inboard et hors-bord. Bouton poussoir pour se mettre au point mort. Utilise des câbles 33C.

| REF | OEM |
|---------|-----------------|
| GS40015 | YMD-RCBOX-00-10 |

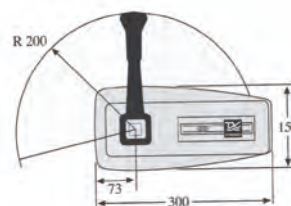

MANDO PARA CONSOLA

CONSOLE CONTROL

COMANDO PER CONSOLLA

BOITIER POUR CONSOLE

| REF | YAMAHA 704 | TRIM |
|-----------------|--------------|------|
| REC704-48205-RO | 704-48205-RO | |
| | 704-48205-P1 | |
| | 704-48205-B1 | |
| | 704-48205-B0 | |
| | 704-48205-RO | |
| | 704-48205-14 | ✓ |
| | 704-48205-11 | |
| | 704-48205-12 | |
| | 704-48205-13 | |
| | 704-48205-15 | |
| | 704-48205-P0 | |



| REF | YAMAHA 704 | TRIM |
|-----------------|--------------|------|
| REC704-48207-RO | 704-48207-RO | |
| | 704-48207-P1 | |
| | 704-48207-39 | |
| | 704-48207-31 | |
| | 704-48207-30 | ✓ |
| | 704-48207-20 | |
| | 704-48207-21 | |
| | 704-48207-22 | |



CONECTORES DE CABLES

CABLE CONNECTOR

CAVO CONNETTORE

EMBOUT DE CABLE

| REF | OEM |
|-----------------|--------------|
| REC663-48344-00 | 663-48344-00 |

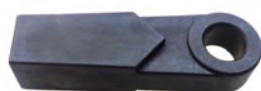

| REF | OEM |
|-----------------|--------------|
| PAF25-07000007W | 703-48345-01 |



INTERRUPTORES PARA MANDOS

INTERRUPTOR POWER TRIM (703)

| REF | OEM |
|----------------|--|
| PAE4-10040100W | 703-82563-00 703-82563-01 703-82563-02 |



SWITCHES FOR ENGINE CONTROLS

POWER TRIM SWITCH (703)

INTERRUTTORI PER CONTROLLO

INTERRUTTORE POWER TRIM (703)

| REF | OEM |
|-----------------|------------------------------|
| REC703-82563-21 | 703-82563-21 703-82563-20 |



INTERRUPTEUR DE CONTRÔLE

COMMUTATEUR DE TRIM (703)

ZUMBADOR ACÚSTICO (703)

| REF | OEM |
|-----------------|--|
| PAF15-13000300W | 703-83383-00 703-83383-01 703-83383-02 703-83383-10 703-83383-11 |



BUZZER ASS'Y (703)

CICALINO (703)

AVERTISSEUR SONORE (703)

INTERRUPTOR PANEL SIMPLE (704)

| REF | OEM |
|-----------------|--|
| REC704-82570-12 | 704-82570-12 704-82570-11 704-82570-10 704-82570-08 6E5-82570-05 |



SWITCH (704)

INTERRUTTORE PANNELLO SIMPLE (704)

| REF | OEM |
|-----------------|--|
| REC704-82563-J2 | 704-82563-J2 704-82563-J1 704-82563-J0 |



TABLEAU DE COMMANDE SIMPLE (704)

| REF | OEM |
|-----------------|--|
| REC704-82563-42 | 704-82563-42 704-82563-41 704-82563-40 |



INTERRUPTOR PANEL COMPLETO O DOBLE ESTACIÓN

| REF | OEM |
|-----------------|--|
| REC6K1-82570-13 | 6K1-82570-13 6K1-82570-12 6K1-82570-11 6K1-82570-10 6K1-82570-08 6K1-82570-07 6K1-82570-06 6K1-82570-05 6K1-82570-04 6K1-82570-03 6K1-82570-02 6K1-82570-00 |



PANEL TWIN STATION

PANNELLO DOPPIA STAZIONE

BOITIER DE DEMARRAGE 2 MOTEURS

CABLE DE ACELERADOR

THROTTLE CABLE

CAVO ACCELERATORE

CÂBLE D'ACCELERATEUR

| REF | OEM |
|-----------------|--------------|
| REC6E0-26301-01 | 6E0-26301-01 |

4AC/A/AS
5C/CS/CMH

| REF | OEM |
|-----------------|--------------|
| REC6B4-26301-00 | 6B4-26301-00 |

E15D
E9.9D

| REF | OEM |
|-----------------|--------------|
| REC677-26301-02 | 677-26301-02 |

E8D
E8DMH

| REF | OEM |
|-----------------|--------------|
| REC61N-26311-00 | 61N-26311-00 |

25B/BM/V
30G/E30H

| REF | OEM |
|-----------------|--------------|
| REC6L2-26301-00 | 6L2-26301-00 |

9.9F/FM
13.5AM
15F/FM
20D/M
25N/NE/NW/D/M

| REF | OEM |
|-----------------|--------------|
| REC6F5-26311-00 | 6F5-26311-00 |

E40G/J
40G/J

| REF | OEM |
|-----------------|--------------|
| REC66T-26301-00 | 66T-26301-00 |

40X/E40X

| REF | OEM |
|-----------------|------------------------|
| REC692-26301-03 | 692-26301-00, 01,02,03 |

55B (1992-00)
75A (1992-00)
85A (1995-98)
E75B (2003-16)
E48C (2003)
E60H (2001+)
E55C (2003-16)
F40J (2016+)

new

CABLES DE CONTROL

CONTROL CABLES

CAVI COMANDO

CÂBLES DE COMMANDE

Recorrido trabajo: 76 mm.
Rosca 10-32"

Travel 3"
Threaded 10-32"

Estensione 76 mm
Filetto 10-32"

Course: 76 mm.
Fil 10-32

| REF | RO | |
|------------|-----------------|--------------|
| PRE3300C05 | YMM-21005-00-00 | 5' / 1,50 m |
| PRE3300C06 | YMM-21006-C8-00 | 6' / 1,80 m |
| PRE3300C07 | YMM-21007-C8-00 | 7' / 2,10 m |
| PRE3300C08 | YMM-21008-C8-00 | 8' / 2,45 m |
| PRE3300C09 | YMM-21009-C8-00 | 9' / 2,75 m |
| PRE3300C10 | YMM-21010-C8-00 | 10' / 3,05 m |
| PRE3300C11 | YMM-21011-C8-00 | 11' / 3,35 m |
| PRE3300C12 | YMM-21012-C8-00 | 12' / 3,65 m |
| PRE3300C13 | YMM-21013-C8-00 | 13' / 3,95 m |
| PRE3300C14 | YMM-21014-C8-00 | 14' / 4,25 m |
| PRE3300C15 | YMM-21015-C8-00 | 15' / 4,60 m |
| PRE3300C16 | YMM-21016-C8-00 | 16' / 4,90 m |
| PRE3300C17 | YMM-21017-C8-00 | 17' / 5,20 m |
| PRE3300C18 | YMM-21018-C8-00 | 18' / 5,50 m |
| PRE3300C19 | YMM-21019-C8-00 | 19' / 5,80 m |
| PRE3300C20 | YMM-21020-C8-00 | 20' / 6,10 m |
| PRE3300C21 | YMM-21021-C8-00 | 21' / 6,40 m |
| PRE3300C22 | YMM-21022-C8-00 | 22' / 6,70 m |
| PRE3300C23 | YMM-21023-C8-00 | 23' / 7,00 m |
| PRE3300C24 | YMM-21024-C8-00 | 24' / 7,30 m |
| PRE3300C25 | YMM-21025-C8-00 | 25' / 7,60 m |
| PRE3300C26 | YMM-21026-C8-00 | 26' / 7,90 m |
| PRE3300C27 | YMM-21027-C8-00 | 27' / 8,25 m |
| PRE3300C28 | YMM-21028-C8-00 | 28' / 8,55 m |
| PRE3300C29 | YMM-21029-C8-00 | 29' / 8,85 m |
| PRE3300C30 | YMM-21030-C8-00 | 30' / 9,15 m |

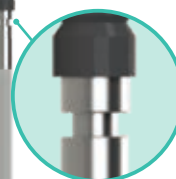
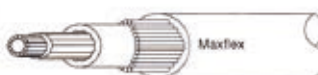

maxflex



VARILLA DE ENLACE **LINK ROD ASSY** **LEVA COLLEGAMENTO** **BARRE D'ACCOUPEMENT COMPLETE**

| REF | OEM |
|-----------------|--------------|
| PAF25-07000300W | 65W-61350-00 |



 F20A FT50G/J
 F25A FT60B/D/G
 FT25B F70A/40X
 F30A
 F40B/C/D
 F50F/H
 F60A/C/F

| REF | OEM |
|-----------------|---------------|
| PAF20-07000100W | 63AH-61350-00 |



 F15C
 F20B

| REF | OEM |
|---------|------------------------------|
| GS41084 | 6E5-61301-00 6E5-61301-01 |



GOLDENSHIP

| REF | OEM |
|-----------------|--------------|
| PAF15-11020000W | 63V-61350-00 |



 9.9F
 15F
 F9.9C
 FT9.9D
 F15A

MANETA ACCELERADOR **LEVER, THROTTLE** **LEVA COLLEGAMENTO** **LEVIER DE COMMANDE**

| REF | OEM |
|---------------|---------------------------------|
| PAF4-01090100 | 6G1-42138-00,01 6EG-G2138-00 |



 new

| REF | OEM |
|----------------|--------------|
| PAF15-01030100 | 65W-42138-00 |



 new

BRACKET

BRACKET ESTRIBOR **RIGHT BRACKET ASSY** **BRACKET TRIBORDO** **ETRIER DROIT**

| REF | OEM | 2T | 4T |
|----------------|-----------------|---------|---------|
| | | STROKES | STROKES |
| PAF15-01010200 | 63V-43112-00-4D | | |
| | 63V-43112-01-4D | ✓ | ✓ |
| | 63V-W4311-00-4D | | |
| | 63V-W4311-03-4D | ✓ | ✓ |
| | 63V-WS431-B6-8D | | |



 new

9.9
 13.5
 15

BRACKET BABOR **LEFT BRACKET ASSY** **BRACKET BABORDO** **ETRIER GAUCHE**

| REF | OEM | 2T | 4T |
|----------------|-----------------|---------|---------|
| | | STROKES | STROKES |
| PAF15-01010100 | 63V-43111-00-4D | | |
| | 63V-43111-01-4D | ✓ | ✓ |
| | 63V-43111-A2-4D | | |



 new

9.9
 13.5
 15

SOPORTE GIRATORIO **BRACKET, ROTARY** **SUPPORTO GIRATORIO** **SUPPORT TOURNANT**

| REF | OEM | 2T | 4T |
|-----------------|-----------------|---------|---------|
| | | STROKES | STROKES |
| PAF15-01010301S | 63V-43311-00-4D | | |
| | 63V-43311-01-4D | ✓ | ✓ |
| | 99999-03116 | | |



 new

9.9
 13.5
 15

| SOPORTE BARRA DE DIRECCIÓN | BOLT, CLAMP BRACKET | SUPPORTO BARRA DIREZIONE | TUBE SUPPORT CABLE DE DIRECTION | | | | | | | | | | | | |
|---|--|---------------------------------|--|--|--|--|---------|---------|----------------|--|---|---|--|--|--|
| <table border="1"> <thead> <tr> <th>REF</th> <th>OEM</th> <th>2T</th> <th>4T</th> </tr> <tr> <th colspan="2"></th> <th>STROKES</th> <th>STROKES</th> </tr> </thead> <tbody> <tr> <td>PAF15-01010001</td> <td>63V-43131-00 63V-43131-10 63v-43131-01</td> <td>✓</td> <td>✓</td> </tr> </tbody> </table> <p>9,9 - 60 Hp</p> | REF | OEM | 2T | 4T | | | STROKES | STROKES | PAF15-01010001 | 63V-43131-00 63V-43131-10 63v-43131-01 | ✓ | ✓ | | | |
| REF | OEM | 2T | 4T | | | | | | | | | | | | |
| | | STROKES | STROKES | | | | | | | | | | | | |
| PAF15-01010001 | 63V-43131-00 63V-43131-10 63v-43131-01 | ✓ | ✓ | | | | | | | | | | | | |
| TUERCA AUTOBLOCANTE | NUT, SELF-LOCKING | BULLONE AUTOBLOCCANTE | ECROU AUTO VERROUILLABLE | | | | | | | | | | | | |
| <table border="1"> <thead> <tr> <th>REF</th> <th>OEM</th> </tr> </thead> <tbody> <tr> <td>PAF15-01010007</td> <td>63V-43145-00 90185-22043 90185-22M11</td> </tr> </tbody> </table> | REF | OEM | PAF15-01010007 | 63V-43145-00 90185-22043 90185-22M11 | | | | | | | | | | | |
| REF | OEM | | | | | | | | | | | | | | |
| PAF15-01010007 | 63V-43145-00 90185-22043 90185-22M11 | | | | | | | | | | | | | | |

| RETÉN INFERIOR DEL BRACKET | BRACKET OIL SEAL | ANELLO BRACCETTO | JOINT INFERIEUR DU SUPPORT | | | | | | | | | | | | |
|---|-------------------------|-------------------------|-----------------------------------|----|--|--|---------|---------|----------------|-------------|---|--|--|--|--|
| <table border="1"> <thead> <tr> <th>REF</th> <th>OEM</th> <th>2T</th> <th>4T</th> </tr> <tr> <th colspan="2"></th> <th>STROKES</th> <th>STROKES</th> </tr> </thead> <tbody> <tr> <td>REC93109-44M00</td> <td>93109-44M00</td> <td>✓</td> <td></td> </tr> </tbody> </table> <p>40 HP</p> | REF | OEM | 2T | 4T | | | STROKES | STROKES | REC93109-44M00 | 93109-44M00 | ✓ | | | | |
| REF | OEM | 2T | 4T | | | | | | | | | | | | |
| | | STROKES | STROKES | | | | | | | | | | | | |
| REC93109-44M00 | 93109-44M00 | ✓ | | | | | | | | | | | | | |

| SOPORTE INFERIOR | SHELL, MOUNT DAMPER | SUPPORTO INFERIORE | SUPPORT SILENT BLOCK | | | | |
|---|------------------------------------|---------------------------|-----------------------------|------------------------------------|--|--|--|
| <table border="1"> <thead> <tr> <th>REF</th> <th>OEM</th> </tr> </thead> <tbody> <tr> <td>PAF15-00000001</td> <td>66M-44551-00-4D 63V-45551-00-4D</td> </tr> </tbody> </table> <p>9,9 13,5 15</p> | REF | OEM | PAF15-00000001 | 66M-44551-00-4D 63V-45551-00-4D | | | |
| REF | OEM | | | | | | |
| PAF15-00000001 | 66M-44551-00-4D 63V-45551-00-4D | | | | | | |

| VARILLA DE BASCULACIÓN | TILT ROD | ASTA BASCULANTE | BARRE DE TILT | | | | | | | | |
|--|--|------------------------|----------------------|--|--|--|-----|-----|-----------------|--------------|--|
| <table border="1"> <thead> <tr> <th>REF</th> <th>OEM</th> </tr> </thead> <tbody> <tr> <td>REC676-43160-02</td> <td>676-43160-00 676-43160-01 676-43160-02</td> </tr> </tbody> </table> <p>40 - 55 HP</p> | REF | OEM | REC676-43160-02 | 676-43160-00 676-43160-01 676-43160-02 | | <table border="1"> <thead> <tr> <th>REF</th> <th>OEM</th> </tr> </thead> <tbody> <tr> <td>REC688-43160-01</td> <td>688-43160-01</td> </tr> </tbody> </table> <p>40 - 90 HP</p> | REF | OEM | REC688-43160-01 | 688-43160-01 | |
| REF | OEM | | | | | | | | | | |
| REC676-43160-02 | 676-43160-00 676-43160-01 676-43160-02 | | | | | | | | | | |
| REF | OEM | | | | | | | | | | |
| REC688-43160-01 | 688-43160-01 | | | | | | | | | | |

| CIRCLIP | CIRCLIP | CIRCLIP | CIRCLIP | | | | |
|--|----------------------------|----------------|----------------|----------------------------|--|--|--|
| <table border="1"> <thead> <tr> <th>REF</th> <th>OEM</th> </tr> </thead> <tbody> <tr> <td>PAGB/T896-9</td> <td>93430-10M00 99080-10600</td> </tr> </tbody> </table> <p>6L5</p> | REF | OEM | PAGB/T896-9 | 93430-10M00 99080-10600 | | | |
| REF | OEM | | | | | | |
| PAGB/T896-9 | 93430-10M00 99080-10600 | | | | | | |

| EJE CONECTOR ACCELERADOR | THROTTLE SHAFT CONNECTOR | ASSE CONNETTORE ACCELERATORE | TIGE DE CONNEXION ACCELERATEUR | | | | |
|---|---------------------------------|-------------------------------------|---------------------------------------|------------------------------|--|--|--|
| <table border="1"> <thead> <tr> <th>REF</th> <th>OEM</th> </tr> </thead> <tbody> <tr> <td>REC688-41211-01</td> <td>688-41211-00 688-41211-01</td> </tr> </tbody> </table> | REF | OEM | REC688-41211-01 | 688-41211-00 688-41211-01 | | | |
| REF | OEM | | | | | | |
| REC688-41211-01 | 688-41211-00 688-41211-01 | | | | | | |

CONECTOR

CONNECTOR

CONNETTORE

CONNECTEUR

| REF | OEM |
|-----------------|--------------|
| REC682-41237-00 | 682-42137-00 |
| REC682-41237-50 | 682-41237-50 |
| REC663-85518-00 | 633-85518-00 |

REC682-41237-00



REC682-41237-50



REC663-85518-00



new

ENGRASADOR INOX 316 M6

OILER M6

INGRASSATORE

GRAISSEUR M6 INOX 316

| REF | OEM |
|-----------------|-------------|
| PAJB/T9740.1-M6 | 93700-06M03 |



new

BUJES

BUSHINGS

BOCCOLE

BAGUES

| REF | OEM |
|----------------|-------------|
| PAF15-01010302 | 90386-22M15 |
| REC90386-25M31 | 90386-25M31 |
| PAF15-01000004 | 90386-30048 |
| PAF25-01000004 | 90386-44M03 |
| PAF25-01000001 | 90386-52M02 |
| REC90386-30M77 | 90386-30M77 |



PAF15-01010302



REC90386-25M31



PAF15-01000004



PAF25-01000004



PAF25-01000001



REC90386-30M77

| REF | OEM | MATERIAL |
|----------------|--------------|----------|
| REC90386-22M13 | 90386-22M13 | NYLON |
| PAT85-01010203 | 90386-10M16 | NYLON |
| PAF25-01010002 | 90386-22M15 | NYLON |
| PAT85-01020005 | 90386-30M77 | NYLON |
| PAT85-00000017 | 90386-18M35 | NYLON |
| REC90386-18M63 | 90386-18M63 | NYLON |
| REC90386-22M98 | 90386-22M98 | NYLON |
| REC90381-20001 | 90381-20001 | NYLON |
| REC90386-38M89 | 90386-38M89 | NYLON |
| PAF15-01000001 | 65F-42537-00 | NYLON |
| PAF25-03000007 | 90387-06M69 | METAL |



REC90386-22M13



PAT85-01010203



PAF25-01010002



PAT85-01020005

new



PAT85-00000017



PAF15-01000001



PAF25-03000007



REC90386-18M63



REC90386-22M98



REC90381-20001



REC90386-38M89

COLLAR

WASHER, BELOW

COLLARE

CALLE

| REF | OEM | | | |
|----------------|-------------|---|---------------|--|
| PAF15-0100006 | 90386-30M60 |  | PAF15-0100006 |  |
| PAT85-01020003 | 90386-30M78 | | | |

new

MANDO ACCELERADOR

STEERING HANDLE ASSY

MANIGLIA

POIGNEE DE DIRECTION

| REF | OEM | | | |
|---------------|------------------------------|---|-----------------|--------------|
| PAF4-01090300 | 68D-G2177-10 6EE-G2177-00 |  | REC6N0-G2177-00 | 6N0-G2177-00 |
| | | | | |

F4-F8

F2.5
6C/T/M/D
8C/T/M

EJE DE CAMBIO

HANDLE GEAR SHIFT ASSY

LEVERAGGIO

COMMANDE D'INVERSION

| REF | OEM | | | |
|-----------------|------------------------------|--|-----------------|------------------------------|
| REC688-44120-12 | 688-44120-11 688-44120-12 |  | REC692-44120-22 | 692-44120-21 692-44120-22 |
| | | | | |

75AE/A
E75B
85A/AE

75AE
80A
90A
90ETN

| REF | OEM | |
|-----------------|--------------|---|
| REC688-44120-22 | 688-44120-22 |  |
| | | |

85AE

MANETAS Y FIJACIONES

STARTER HANDLE AND FIXINGS

MANIGLIE E CHIUSURE

POIGNEE LANCEUR ET DE SERRAGE

| REF | OEM | | |
|-----------------|--------------|---|-----------------|
| REC6L8-G3118-01 | 6L8-G3118-01 |  | REC648-44146-00 |
| | | | |

F4/F6/F-FT8/F6
6C/TRV/M/D
8C/M

25Q/D
30A
20C
40Q/H/E40G/J
50D

| REF | OEM | |
|----------------|-------------|---|
| REC99999-02808 | 99999-02808 |  |
| | | |

| REF | OEM | |
|-----------------|------------------------------|---|
| REC6E0-43118-01 | 6E0-43118-00 6E0-43118-01 |  |
| | | |

| REF | OEM | |
|--------------------|-----------------|---|
| REC663-43118-01-4D | 663-43118-01-4D |  |
| | | |

F20/F25
40X/E40M/E40X/40Q
E8D/55B
E60H/E
E55C
E9.9D/E15D

| REF | OEM | |
|-----------------|--------------|---|
| REC650-44147-00 | 650-44147-00 |  |
| | | |

9.9D/15D
25NE/20DM

40Q
E40G/J
40G/J

SILENBLOCK

SILENBLOCK

SILENBLOCK

SILENT BLOC

| REF | OEM |
|--------------------|-----------------|
| REC63V-44514-01-CA | 63V-44514-01-CA |

 9.9F/FM/MS
 13.5AMH
 15F/FM/MS





| REF | OEM |
|--------------------|-----------------|
| REC66T-44514-00-4D | 66T-44514-00-4D |

 40X
 E40X/M



| REF | OEM |
|-----------------|--------------|
| REC670-44514-00 | 670-44514-00 |

 55B
 E55CMH



| REF | OEM |
|----------------|--------------|
| PAF15-00000002 | 682-44555-30 |

 6 HP
 8 HP
 9.9 HP
 15 HP

new



| REF | OEM |
|--------------------|--------------|
| REC670-44555-00-94 | 62Y-44555-00 |

 E48CM
 E55CM



| REF | OEM |
|----------------|--------------|
| PAF15-00000003 | 66M-44557-00 |

 9.9 HP
 13.5 HP
 15 HP

new



| REF | OEM |
|--------------------|-----------------|
| REC679-44514-00-94 | 679-44514-00-94 |

 40QE/QWC/G/J
 E40G/J



| REF | OEM |
|----------------|-----------------|
| PAF15-02010000 | 66M-44514-00-4D |

 9.9 HP
 13.5 HP
 15 HP

new



| REF | OEM |
|--------------------|-----------------|
| REC682-44514-01-94 | 682-44514-01-94 |

 E9.9DMH
 E15DMH



| REF | OEM |
|--------------------|-----------------|
| REC663-44551-02-8D | 663-44551-02-8D |

 F50DETL
 75CETO
 90AETO/TRH



| REF | OEM |
|-----------------|--------------|
| REC688-44514-00 | 688-44514-00 |

 E60HMHD
 70BETO
 75CETO
 90AETO



| REF | OEM |
|-----------------|--------------|
| REC676-44518-00 | 676-44518-00 |

 E40G/J
 40G/J
 40G



| REF | OEM |
|-----------------|--------------|
| REC688-44555-00 | 688-44555-00 |

 60FE/FET
 70CE/ETN
 E75B
 80A
 85A



SISTEMA DE REFRIGERACIÓN COOLING SYSTEM

SISTEMA DI RAFFREDDAMENTO SYSTÈME DE REFROIDISSEMENT

LÍQUIDO INHIBIDOR DE LA CORROSION

SALT OFF

Diseñado especialmente para eliminar sedimentos de sal de cualquier superficie pintada, de metal, fibra de vidrio, vinilo, caucho, cristal o plástico. Es el método más eficaz para proteger los motores, los aparos de pesca... Genera una capa de polímeros que evita futuras sedimentaciones.

It is specifically formulated to quickly and effectively remove salt deposits from metal, fiberglass, plastic or painted surfaces. It contains special polymers that bond to the treated surface to help prevent the formation of future deposits.

LIQUIDO INIBITORE DELLA CORROSIONE

SALT OFF

Appositamente progettato per rimuovere depositi di sale da qualsiasi superficie verniciata, metallo, fibra di vetro, vinile, gomma, vetro o plastica. È il metodo più efficace per proteggere motori, attrezzi da pesca... Genera uno strato di polimeri che impedisce la futura sedimentazione.

La protection SALT OFF est formulé pour éliminer les dépôts de sel sur toutes les surfaces marines. Utilisable pour le rinçage des moteurs hors bord et inboard et les embases. Il laisse un film de protection spécial pour prévenir des attaques futures du sel.

new



REF
STA94100

Star brite



| REF | Image | Capacity |
|----------|-------|----------|
| STA93900 | | 3,78 L |
| STA93922 | | 650 ml |
| STA93932 | | 1 L |

STA93900



STA93932



STA93922

TERMOSTATO

THERMOSTAT

TERMOSTATO

THERMOSTAT

TERMOSTATO

THERMOSTAT

TERMOSTATO

THERMOSTAT

| REF | OEM | °C |
|-----------------|--------------|-----|
| REC6DA-12411-01 | 6DA-12411-01 | 60° |



| REF | OEM | °C |
|-----------------|--------------|-----|
| REC6FM-12411-00 | 6FM-12411-00 | 60° |



| REF | OEM | °C |
|-----------------|--|-----|
| REC6AH-12411-00 | 69M-12411-01 69M-12411-00 6AH-12411-00 | 60° |



| REF | OEM | °C |
|-----------------|--|----|
| REC6E5-12411-02 | 6E5-12411-00 6E5-12411-01 6E5-12411-02 | 50 |



| REF | OEM | °C |
|-----------------|--------------|-----|
| REC6D9-12411-00 | 6D9-12411-00 | 55° |



new

| REF | OEM | °C |
|-----------------|--------------|-----|
| REC6E5-12411-30 | 6E5-12411-30 | 50° |
| | 6E5-12411-20 | |
| | 6E5-12411-10 | |



| REF | OEM | °C |
|-----------------|--------------|-----|
| REC6CE-12411-00 | 6CE-12411-00 | 52° |



new

| REF | OEM | °C |
|----------------|--------------|-----|
| PAF15-07000031 | 66M-12411-00 | 60° |
| | 66M-12411-01 | |



| REF | OEM | °C |
|-----------------|--------------|-----|
| REC6AW-12411-00 | 6AW-12411-00 | 60° |



new

| REF | OEM | °C |
|-----------------|--------------|-----|
| REC6H3-12411-10 | 6H3-12411-00 | 60° |
| | 6H3-12411-01 | |
| | 6H3-12411-10 | |
| | 6H3-12411-11 | |



| REF | OEM | °C |
|-----------------|--------------|-----|
| REC6FP-12411-00 | 6FP-12411-00 | 60° |



new

| REF | OEM | °C |
|-----------------|--------------|-----|
| REC67F-12411-01 | 67F-12411-00 | 60° |
| | 67F-12411-01 | |



| REF | OEM | °C |
|-----------------|--------------|-----|
| REC6F5-12411-03 | 6F5-12411-00 | 60° |
| | 6F5-12411-01 | |
| | 6F5-12411-02 | |
| | 6F5-12411-03 | |



new

| REF | OEM | °C |
|-----------------|--------------|-----|
| REC60V-12411-00 | 60V-12411-00 | 50° |



GUÍA TERMOSTATO

THERMOSTAT GUIDE

GUIDA TERMOSTATO

GUIDE DES THERMOSTATS

| | REF |
|---|-----------------|
| 3A/ 4A/ 5C/ 6C/ 8C/ 25N (-1993)/ 25NWO | REC6E5-12411-02 |
| 9.9F/ 15F/ 25N(1994+)/30D/ 40V/ 75C/ 90A/ 100A/ 115C/ 130B/ 150F/ 175D/ 200F/G/ 225D/G/ 250A/B/ Z150P/Q/ Z175G/ Z200N/P | REC6E5-12411-30 |
| F2.5A/ F9.9H/ F13.5B/ F15C/ F20B,M | REC6AH-12411-00 |
| 9.9D/ 15D/ 20C/ 25D/ 40Q/ 55B | REC6F5-12411-03 |
| F15C/F20D | REC6AH-12411-00 |
| F25G | REC6FM-12411-00 |
| 50G/ 60F/ 70B | REC6H3-12411-10 |
| F4A/B/ F5A/ F6A/C/ F8B/C/ FT8D/ F9.9B/C/F/J/ FT9.9A/D/G/L/ F15A/ F25A/D/ FT25B/F/ F30A/B/ F40A/B/F/ F50A/F/H/ FT-50B/C/G/J/ F60A/C/F/ FT60B/D/G/ F70A/ F80A/ F100A(2000-) | PAF15-07000031 |

| | REF |
|---|-----------------|
| F80A/B/ F100A(01+)/ F100B/ F(L)150A/ F(L)200A/C/ F(L)225A/B/C/ F(L)250A/B | REC67F-12411-01 |
| F100D | REC6D9-12411-00 |
| F100F | REC6FP-12411-00 |
| F(L)225F/ F(L)250D/ F(L)300B | REC6CE-12411-00 |
| F(L)200F/ F(L)200G/ F175A | REC6DA-12411-01 |
| F(L)300A/ F(L)350A | REC6AW-12411-00 |
| F100B/ F(L)115A/ (L)2250D/F/ Z300A | REC60V-12411-00 |

JUNTAS TERMOSTATO

THERMOSTATO GASKETS

GUARNIZIONI TERMOSTATO

JOINTS DE THERMOSTAT

new

| REF | OEM |
|-----------------|--------------|
| REC63P-12414-00 | 63P-12414-00 |

F150A/B/D/F/T (2004+)



new

| REF | OEM |
|----------------|--------------|
| PAF20-05000702 | 6AH-12414-00 |

F9.9 -F20 (New models)



| REF | OEM |
|---------------|--------------|
| PAF4-04000011 | 68D-E2414-A0 |

F2.5
F4
F5
F6



| REF | OEM |
|-----------------|--------------|
| REC655-12414-A1 | 655-12414-A1 |

20C/CM
E25A
E25BMH
25VE/VM/DE/D/B/BMH/BWH/HMH
30G/GE/A
E30HMH
30HMH/HWH/HWL



| REF | OEM |
|-----------------|--------------|
| REC6G8-12414-A0 | 6G8-12414-A0 |

T8/T9.9
F6/8/9.9
FT8/9.9



| REF | OEM |
|-----------------|--------------|
| REC676-12414-A0 | 676-12414-A1 |

40X/E40X/E40MLH



| REF | OEM |
|-----------------|--------------|
| PAF15-07010022 | 62Y-12414-00 |
| REC6H3-12414-A1 | 6H3-12414-A1 |

F9.9
F60
F30
F13.5
F70
FT9.9
T9.9TLR
FT25
FT50

FT60
F15/20/25/40/45/50
T50TLR
T60TLR
T25TLR



| REF | OEM |
|-----------------|--------------|
| REC6E9-12414-A1 | 6E9-12414-A1 |

40QE/QM/QEZ/QWC/GWH/JWH
E40GMH/JMH



| REF | OEM |
|-----------------|--------------|
| REC682-12414-A1 | 682-12414-A1 |

9.9D/F/FMH/FEMH/MH/MSH
15D
E9.9DMH
13.5AMH
15F/FEMH/FMH/MSH/MH
E15DMH



| REF | OEM |
|-----------------|--------------|
| REC663-12414-00 | 663-12414-A0 |

E48CMHS
55B/BET/BE/BM
E55CMH



| REF | OEM |
|-----------------|--------------|
| REC61A-12414-A0 | 61A-12414-A0 |

20DM/MSH
25J/JETO/NEM/NWC/D/DM
30D/DMH
40V/VMH/VEO
C40MLH/T
50H/HM
225C/CET/FETO/G
250AET/B/TXR/G/GETO



| REF | OEM |
|-----------------|--------------|
| REC688-12414-A1 | 688-12414-A1 |

75CETO/AE
E75B
80AE/A
85AE/A
90AE/TLR
100A/TLR
115BE/B
115A/AETO/CET
130BETO/TLR
150F/TXRA/FETO/C

Z150
175D/DETO/DETO
Z175
225D/DETO
VZ200
Z200
200AET/CETO/F/
FETO/G/GETO



CUBIERTAS TERMOSTATO **THERMOSTATO COVER** **COPERCHIO TERMOSTATO** **COUVERCLE DE THERMOSTAT**

| REF | OEM |  |
|--------------------|-----------------|---|
| REC6E9-12413-00-1S | 6E9-12413-00-1S | REC6E9-12414-A1 |

E40/40J (2003+)



new

| REF | OEM |  |
|--------------------|------------------------------------|---|
| REC682-12413-00-1S | 682-12413-00-1S 682-12413-00-9M | REC682-12414-A1 |

E40/40J (2003+)



new

| REF | OEM |  |
|--------------------|-----------------|---|
| REC688-12413-00-1S | 688-12413-00-1S | REC688-12414-A1 |



new

VÁLVULA ANTIPRESIÓN DE TERMOSTATO **THERMOSTAT, PRESSURE VALVE** **VALVOLA ANTI-PRESSIONE DE TERMOSTATO** **SOUPAPE DE PRESSION DE THERMOSTAT**



| REF | OEM | O-RING | OEM |
|-----------------|--------------|----------------|-------------|
| REC688-12416-00 | 688-12416-00 | REC90480-20M05 | 90480-20M05 |

new

RESORTE **SPRING** **MOLLA** **RESSORT**

| REF | OEM |
|----------------|-------------|
| REC90501-16M11 | 90501-16M11 |

75 / 85 / 90A



new

NIPLE **NIPPLE** **NIPLE** **TETINE**

| REF | OEM |
|----------------|--|
| PAF15-05000009 | 6H3-44391-00 6H3-44391-01 6BL-44391-00 |



new

JUNTAS TAPA, DE REFRIGERACIÓN

GASKET, EXHAUST INNER COVER

GUARNIZIONE COPERCHIO REFRIGERAZIONE

JOINT DE PLAQUE DE REFRIGERISSEMENT

| REF | OEM |
|-----------------|--------------|
| REC6E0-41114-A1 | 6E0-41114-A1 |

4AC/AS/MSH
5C/CS

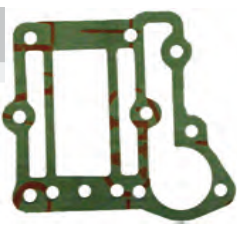

| REF | OEM |
|-----------------|--------------|
| REC6E0-41112-A1 | 6E0-41112-A1 |

4AC/AS/MSH
5C/CS

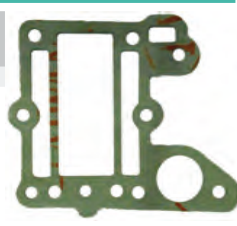

| REF | OEM |
|-----------------|--------------|
| REC6G1-41112-A1 | 6G1-41112-A1 |

6C/T/M/D
8C/M/T

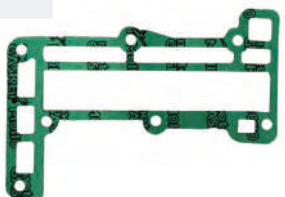

| REF | OEM |
|-----------------|--------------|
| REC6G1-41114-A0 | 6G1-41114-A0 |

6C/T/M/D
8C/M/T

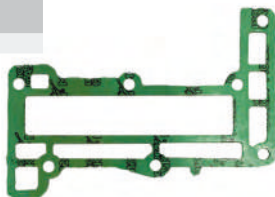

| REF | OEM |
|-----------------|--------------|
| REC6G1-11193-A1 | 6G1-11193-A1 |

6C/M/T/D
8C/M/T

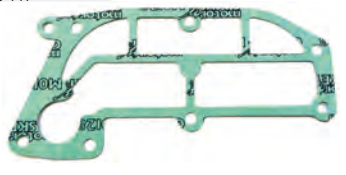

| REF | OEM |
|-----------------|--------------|
| REC6G8-41112-02 | 6G8-41112-02 |

F8B
F9.9A/B
T9.9E



| REF | OEM |
|-----------------|--------------|
| REC6G8-41114-00 | 6G8-41114-00 |

F8B
F9.9A/B
T9.9E

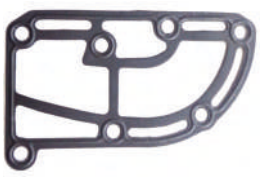

| REF | OEM |
|-----------------|--------------|
| REC677-41112-A0 | 677-41114-A0 |

E8D/DMH



| REF | OEM |
|-----------------|--------------|
| REC6B4-11193-A0 | 6B4-11193-A0 |

E9.9 / E15 (2003+)

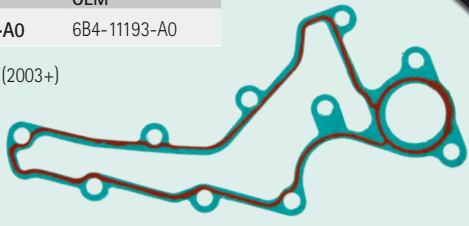

new

| REF | OEM |
|-----------------|--------------|
| REC682-41114-00 | 682-41114-A1 |

9.9D
15D



| REF | OEM |
|-----------------|--------------|
| REC682-41112-00 | 682-41112-A1 |

9.9D
15D

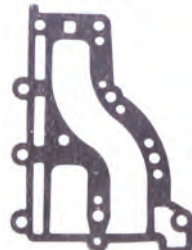

| REF | OEM |
|----------------|--------------|
| PAF15-07010018 | 66M-41114-01 |

F9.9
13.5
F15



| REF | OEM |
|-----------------|--------------|
| REC63V-41112-A0 | 63V-41112-A0 |

9.9F/MSH/MH
13.5AW
15F/MSH/MH
E15DMH



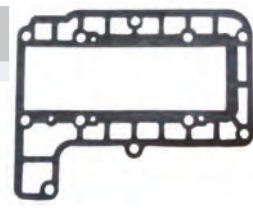

| REF | OEM |
|-----------------|--------------|
| REC664-41114-A0 | 664-41114-A0 |

20C/25D



| REF | OEM |
|-----------------|--------------|
| REC6L2-41114-A1 | 6L2-41114-A1 |

 20D/M
25N/M/D



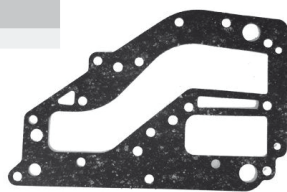

| REF | OEM |
|-----------------|--------------|
| REC6K8-41122-A1 | 6K8-41122-A1 |

 25VE/M/B/BMH
E25A
30HM/HW/G/GE
E30HMH



| REF | OEM |
|-----------------|--------------|
| REC6L2-41112-A3 | 6L2-41112-A2 |

 20D/M
25N/M



| REF | OEM |
|-----------------|--------------|
| REC6K8-41124-A1 | 6K8-41124-A1 |

 25VE/M/B/BMH
E25A
30HM/HW/G/GE
E30HMH

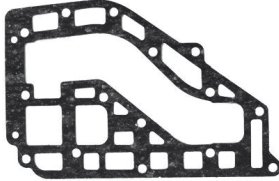

| REF | OEM |
|----------------|--------------|
| PAF25-05010111 | 65W-41114-00 |

 F20/25
T25

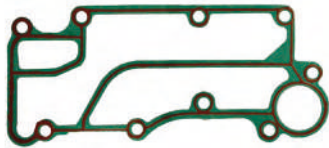

| REF | OEM |
|-----------------|--------------|
| REC689-41112-A0 | 689-41112-A0 |

 30A

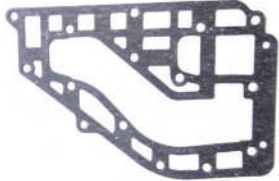

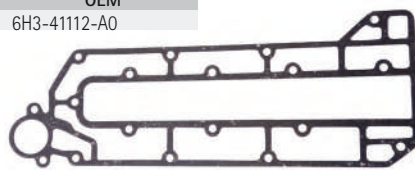

| REF | OEM |
|-----------------|--------------|
| REC6H3-41112-A0 | 6H3-41112-A0 |

 25B
50G/GE
60FE/TLR
E60H
70B/BE/TR



| REF | OEM |
|-----------------|--------------|
| REC689-41114-A0 | 689-41114-A0 |

 30A



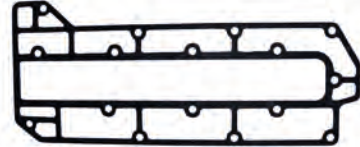

| REF | OEM |
|-----------------|--------------|
| REC6H3-41114-A0 | 6H3-41114-A0 |

 25B
50G/GE
60FE/TLR
E60H
70B/BE/TR



| REF | OEM |
|-----------------|--------------|
| REC67C-41114-00 | 67C-41114-00 |

 F30/40



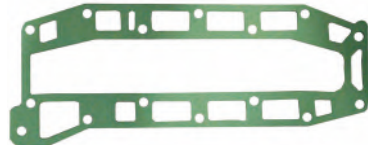

| REF | OEM |
|-----------------|--------------|
| REC6H4-41112-A0 | 6H4-41112-A0 |

 25QEO
40H/M/VE/TLR
C40M/T
50H/DE



| REF | OEM |
|-----------------|--------------|
| REC66T-41114-A0 | 66T-41114-A0 |

 40X
E40X



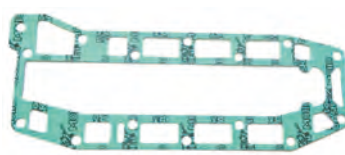

| REF | OEM |
|-----------------|--------------|
| REC6H4-41114-A0 | 6H4-41114-A0 |

 25QEO
40H/M/VE/TLR
C40M/T
50H/DE





| REF | OEM |
|-----------------|--------------|
| REC6F5-41112-A0 | 6F5-41112-A0 |

 40GWH/JMH
E40GMH

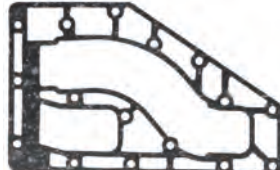

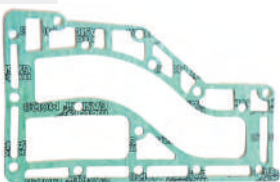

| REF | OEM |
|---|---|
| REC6F5-41114-A0 | 6F5-41114-A0 |
|  40GWH/JMH E40GMH |  |

| REF | OEM |
|---|---|
| REC6E5-41112-A1 | 6E5-41112-A1 |
|  100A/AET/TLR 115B/BE/TLR/CEO/TXR 130BET/TLR |  |

| REF | OEM |
|---|---|
| REC6E9-41114-A0 | 6E9-41114-A0 |
|  40Q |  |

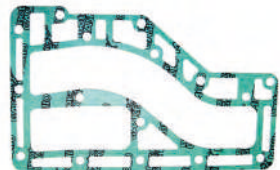
| REF | OEM |
|---|---|
| REC6G5-11382-A1 | 6G5-11382-A1 |
|  115HP-250HP |  |

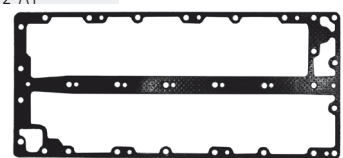

| REF | OEM |
|---|--|
| REC676-41112-A0 | 676-41112-A0 |
|  40Q |  |

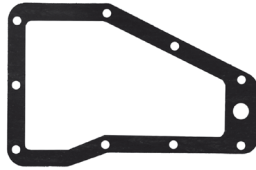
| REF | OEM |
|---|---|
| REC6G5-41112-A1 | 6G5-41112-A1 |
|  150F/FE/TXR/GE/A-CE, 175D/DE/FE 200AET/F/FE/TLR/G/GE/BE 225D/DE/BE |  |

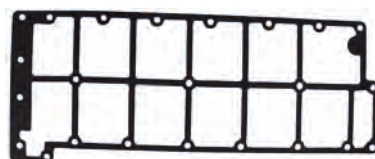
| REF | OEM |
|---|---|
| REC663-41114-00 | 663-41114-A0 |
|  55B E55CMH |  |

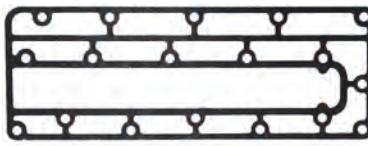
| REF | OEM |
|--|---|
| REC68F-41114-00 | 68F-41114-00 |
|  Z150 175 200HP |  |

| REF | OEM |
|--|---|
| REC688-41112-A0 | 688-41112-A0 |
|  75CET/TLR/AE E75B 80AE 85A/AE 90A/AE/TLR |  |

| REF | OEM |
|---|---|
| REC6G5-41114-A0 | 6G5-41114-A0 |
|  150F/FE/TXR/GE/A-CE, 175D/DE/FE 200AET/F/FE/TLR/G/GE/BE 225D/DE/BE |  |

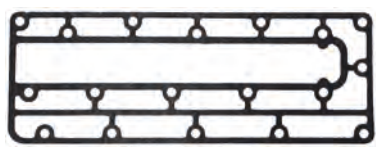
| REF | OEM |
|--|---|
| REC688-41114-A0 | 688-41114-A0 |
|  75CET/TLR/AE E75B 80AE 85A/AE 90A/AE/TLR |  |



| | REF | CEF | OEM | A | B | C |
|---|-----------------|------------|--------------|-------|------|-------|
| 2A/B/C | REC646-44352-01 | CEF500324 | 646-44352-01 | 11,5 | 47,5 | 13,7 |
| F2.5, 3A, MALTA | REC6L5-44352-00 | CEF500322 | 6L5-44352-00 | 10 | 36 | 14,5 |
| 4A/B, F4A, F4B, F5A, F6C, 5C | REC6E0-44352-00 | CEF500325 | 6E0-44352-00 | 11 | 40 | 12,6 |
| F6A/B, F8C, F9.9F, F9.9J | REC68T-44352-00 | CEF500368 | 68T-44352-00 | 11,6 | 53 | 14 |
| E8D | REC662-44352-01 | CEF500321 | 662-44352-01 | 14 | 40 | 22 |
| 6C/D, 8C | REC6G1-44352-00 | CEF500302 | 6G1-44352-00 | 11,9 | 40 | 18 |
| F8, F9.9A/B/D, FT9.9A, 15D/9.9D | REC682-44352-01 | CEF500320 | 682-44352-03 | 13 | 40 | 22 |
| FT8D, 9.9F, F9.9C, FT9.9D, 15F, F15A-C, F20B, FT9.9G/L | REC63V-44352-01 | CEF500363 | 63V-44352-01 | 12,85 | 53 | 14 |
| 20C, 25D, 30A | REC689-44352-02 | CEF500326 | 689-44352-02 | 16,5 | 69,5 | 12,72 |
| 20D, 25N | REC6L2-44352-00 | CEF500384 | 6L2-44352-00 | 13,97 | 51,2 | 19,05 |
| F20A, F25A/D/G, FT25B, 25B/J/V, F30A, 30D/H/G, F40B/F, 40H/X, 50D | REC6H4-44352-02 | CEF500385G | 6H4-44352-02 | 16,1 | 51,2 | 19,05 |
| F40A/C, 40V/F/Y, F45A, 50G/H, 55B, PRO50, F50A/B/F, FT50B/C/G, F50H, FT50J, F60A/C/F, FT60B/D/G, 60F, 70B, F70A | REC6H3-44352-00 | CEF500316 | 6H3-44352-00 | 18,05 | 51,8 | 19 |
| 40Q | REC6F5-44352-00 | CEF500352 | 6F5-44352-00 | 16,04 | 69,8 | 22,1 |
| 60F'04-, 70B'04-, 75A/C, PRO75, 80A, 85A, 90A | REC688-44352-03 | CEF500323 | 688-44352-03 | 20,1 | 58 | 30 |
| F80A/B, F100A/D | REC67F-44352-00 | CEF500364 | 67F-44352-00 | 20 | 58,2 | 34,7 |
| F(L)115A/F(L), 150A, V4/V6, F100F, F175, 200F/G | REC6E5-44352-01 | CEF500371 | 6E5-44352-01 | 22,4 | 89 | 31 |
| F(L)225F, F(L) 250D, F(L)300B | REC6CE-44352-00 | CEF500401N | 6CE-44352-00 | 22,5 | 90 | 36 |
| F300, F350 | REC6AW-44352-00 | CEF500389N | 6AW-44352-00 | 24,6 | 89 | 36 |

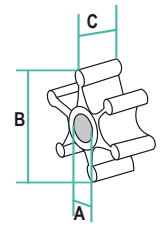

REC646-44352-01



REC6L5-44352-00



REC6E0-44352-00



REC68T-44352-00



REC662-44352-01



REC6G1-44352-00



REC682-44352-01



REC63V-44352-01



REC689-44352-02



REC6L2-44352-00



REC6H4-44352-02



REC6H3-44352-00



REC6F5-44352-00



REC688-44352-03



REC67F-44352-00



REC6E5-44352-01



REC6CE-44352-00



REC6AW-44352-00

KITS DE JUNTAS

GASKETS KIT

KIT GUARNIZIONE

KITS JOINTS

| REF | OEM |
|-----------------|--------------|
| REC6A1-W0001-22 | 6A1-W0001-22 |

2B

| REF | OEM |
|-----------------|--------------|
| REC6A1-W0001-23 | 6A1-W0001-23 |

2B
2MSH

| REF | OEM |
|-----------------|--------------|
| REC6E0-W0001-C1 | 6E0-W0001-C1 |

F4/F5/F6
4AC
MSH
5C/CS/CMH

| REF | OEM |
|-----------------|--------------|
| REC6G1-W0001-C1 | 6G1-W0001-C0 |

6C/CMH/MSH/TRV/D/DMH
8C/MSH/CMH/TRV

| REF | OEM |
|-----------------|--------------|
| REC68T-W0001-20 | 68T-W0001-20 |

F6/F8/F9.9

| REF | OEM |
|-----------------|--------------|
| REC6G9-W0001-C4 | 6G9-W0001-C4 |

F8
F9.9

| REF | OEM |
|-----------------|--------------|
| REC69G-W0001-20 | 69G-W0001-20 |

FT8/T8
FT9.9/T9.9

| REF | OEM |
|-----------------|--------------|
| REC6G9-W0001-C6 | 6G9-W0001-C6 |

F8
F9.9

| REF | OEM |
|-----------------|--------------|
| REC66M-W0001-20 | 66M-W0001-20 |

F9.9
F13.5
F15

| REF | OEM |
|-----------------|--------------|
| REC683-W0001-21 | 683-W0001-C1 |

9.9D/15D

| REF | OEM |
|-----------------|--------------|
| REC63V-W0001-21 | 63V-W0001-21 |

9.9/15F
13.5AWH

YAMAHA

RECAMBIOS MARINOS

| REF | OEM |
|-----------------|---------------|
| REC689-W0001-C2 | 6689-W0001-C2 |

 20C/CM
 25D
 30A

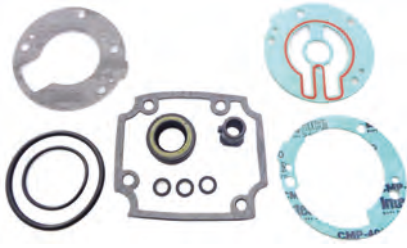

| REF | OEM |
|-----------------|--------------|
| REC6L2-W0001-C3 | 6L2-W0001-C3 |

 25D/NWC/MLH/MSH





| REF | OEM |
|-----------------|--------------|
| REC689-W0001-21 | 689-W0001-21 |

 55B



| REF | OEM |
|-----------------|--------------|
| REC61N-W0001-E1 | 61N-W0001-E1 |

 25V/VM/E25A
 30G/GE



| REF | OEM |
|-----------------|--------------|
| REC698-W0001-21 | 698-W0001-21 |

 E48
 E48CMH
 55B/BM/BET
 E55CMH

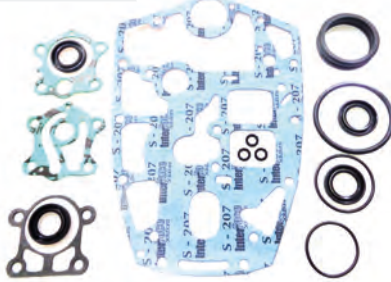

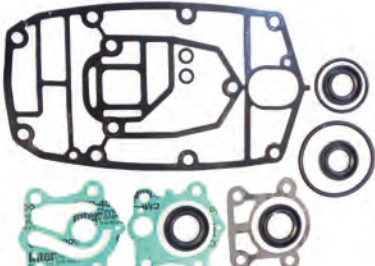

| REF | OEM |
|-----------------|--------------|
| REC6J8-W0001-21 | 6J8-W0001-21 |

 25J
 30D/DMH





| REF | OEM |
|-----------------|--------------|
| REC689-W0001-20 | 689-W0001-20 |

 55BET



| REF | OEM |
|-----------------|--------------|
| REC6H3-W0001-22 | 6H3-W0001-22 |

 25B/BETO
 50G/GEO/GETO
 60FETO/FEDO/FE0/F/TLR
 70B/BETO/BEMO





| REF | OEM |
|-----------------|--------------|
| REC65W-W0001-20 | 65W-W0001-20 |

 F20/25





| REF | OEM |
|-----------------|--------------|
| REC67F-W0001-20 | 67F-W0001-20 |

 F100A/T
 F80A/T





| REF | OEM |
|-----------------|----------------------|
| REC62Y-W0001-22 | 62Y-W0001-20,-21,-22 |

 F40A, ELH/F45AE, AET/F50A, AET, AED, AEDH, AEHT, TJR, TJRB, TLR, TLRA, TLRC, TLRZ, TLHC/FT50B/T50TLR (2000-07)





| REF | OEM |
|-----------------|--------------|
| REC64J-W0001-21 | 64J-W0001-21 |

 FT50, T50



| REF | OEM |
|-----------------|--------------|
| REC6F5-W0001-C0 | 6F5-W0001-C0 |

 40G/E40G



| REF | OEM |
|-----------------|--------------|
| REC69D-W0001-20 | 69D-W0001-20 |

 E60H

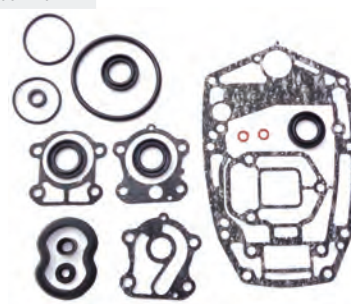

| REF | OEM |
|-----------------|--------------|
| REC66T-W0001-20 | 66T-W0001-20 |

 40X/E40X-MH/XW E40MCH

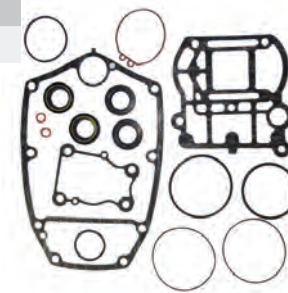

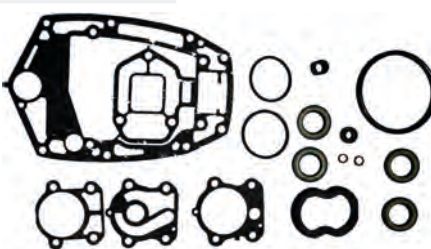

| REF | OEM |
|-----------------|--------------|
| REC6H2-W0001-20 | 6H2-W0001-20 |

 60FETO/TR 70BETO/TR





| REF | OEM |
|-----------------|--------------|
| REC6A0-W0001-21 | 6A0-W0001-21 |

 400E/G





| REF | OEM |
|-----------------|--------------|
| REC688-W0001-22 | 688-W0001-22 |

 75CETO/E75B/AED 85A/AED/AET 90AETO/TR



| REF | OEM |
|-----------------|--------------|
| REC64J-W0001-20 | 64J-W0001-20 |

 F45/50 FT50 T50



| REF | OEM |
|-----------------|--------------|
| REC688-W0001-20 | 688-W0001-20 |

 75A/AE 80A 85A/AE 90A/AEO/AETO/ETN

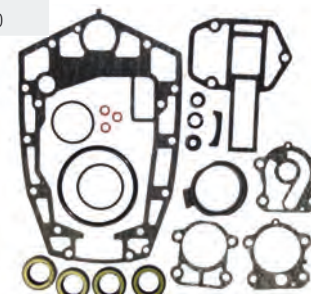

| REF | OEM |
|-----------------|--------------|
| REC68V-W0001-20 | 68V-W0001-20 |

F115

| REF | OEM |
|--------------------|--------------|
| REC69J-W0001-20-00 | 69J-W0001-20 |

F200/225

| REF | OEM |
|-----------------|--|
| REC6E5-W0001-F1 | 6E5-W0001-F1 6E5-W0001-21 6F3-W0001-21 |

115BETO/B/CEO/CETO/TXR
130BETO
E115AE

BOMBA DE AGUA

WATER PUMP

POMPA ACQUA

POMPE À EAU

CUERPO BOMBA DE AGUA

HOUSING, WATER PUMP

CORPO, POMPA ACQUA

CORPS DE POMPE À EAU

| REF | OEM |
|-----------------|--------------|
| PAF2.6-03000014 | 69M-G4311-00 |

F2.5

P. 283

| REF | OEM |
|----------------|--------------|
| PAF20-04040001 | 6AH-44311-00 |

F9.9 / 13.5 / 15/20 F
Última versión
Last version
Ultima versione
Dernière version

P. 293

new

| REF | OEM |
|---------------|--------------|
| PAF4-03000019 | 68D-G4311-01 |

F4

P. 285
P. 343

| REF | OEM |
|-----------------|--------------|
| REC689-44311-00 | 689-44311-03 |

20C/CM
25D/DE
30A

P. 353

| REF | OEM |
|-----------------|-----------------|
| REC63V-44301-00 | 63V-44301-00-00 |

F6/8/15/9.9/13.5
T8/9.9
9.9F/FEM/MH/MSH/FMH
13.5AWH
15F/FMH/MSH/MH

P. 289
P. 291
P. 351

| REF | OEM |
|-----------------|-----------------|
| REC663-44311-02 | 663-44311-02-00 |

25B/BETO
40N/H/E
50G/GEO/GETO
50D
55B/BET
E55CMH
60FEO/FETO/FEDO

60BE/BEM/BET
70CE

P. 357
P. 359
P. 369

| REF | OEM |
|----------------|--------------|
| PAF25-04050001 | 61N-44311-01 |

25V
 30G
 F20
 F25

P. 297
 P. 355



| REF | OEM |
|-----------------|--------------|
| REC688-44311-01 | 688-44311-01 |

60FETO/TR
 E60H-E-M
 70BETO/TR
 75CETO/TLR
 E75B
 75A/AE-T-M-D
 80A/AE-O-T
 85A/AE-D-T
 90A/AETO/AEO/TLR

P. 371
 P. 373



| REF | OEM |
|-----------------|--------------|
| REC63D-44311-01 | 63D-44311-00 |

40V/VM/VE/TLR
 C40M-T
 50H/HR-M/HM
 F40/45/50/60

P. 309
 P. 315



| REF | OEM |
|-----------------|-----------------|
| REC67F-44311-01 | 67F-44311-01-00 |

F80/100

P. 321



| REF | OEM |
|-----------------|--------------|
| REC676-44311-00 | 676-44311-00 |

E40GM/JM
 40GW/JW/G/QE/QWC



| REF | OEM |
|-----------------|--------------|
| REC61A-44311-00 | 6E5-44311-00 |

F80/100/115/150/200/225/250
 150F/FET/TR/AET
 Z150P/TXR
 175D 200F/FETO/G/GETO
 200AET
 225B/DET/G
 250GETO/AET
 Z250DET/FET

P. 325
 P. 329
 P. 333
 P. 339
 P. 377
 P. 381
 P. 385
 P. 386



| REF | OEM |
|----------------|--------------|
| PAT40-04000201 | 66T-44311-00 |

40X/E40X-MLH
 T25/FT25
 F30/F40

P. 305
 P. 301

new



| REF | OEM |
|-----------------|------------------------------|
| REC6CE-44311-01 | 6CE-44311-00 6CE-44311-01 |

F250 (2011+) V6
 F300 (2011+) V6

P. 335

new



| REF | OEM |
|-----------------|--------------|
| REC6H3-44311-00 | 6H3-44311-00 |

FT/T 50/60 HP (1997+)
 60F (1984-99)

new



| REF | OEM |
|-----------------|------------------------------|
| REC6AW-44311-01 | 6AW-44311-00 6AW-44311-01 |

F300 (2008-11) V8
 F350 (2008+) V8

P. 341

new



TAPA DE LA BOMBA

WATER PUMP, COVER

COPERCHIO POMPA

PLAQUE DE POMPE À EAU

| REF | OEM |
|-----------------|--------------|
| REC646-44323-00 | 646-44323-00 |

2B
 2MSH
 2BMH



| REF | OEM |
|-----------------|--------------|
| PAF2.6-03000010 | 69M-G4323-00 |

F2.5





| REF | OEM |
|-----------------|--------------|
| REC6L5-44323-00 | 6L5-44323-00 |

 3A/AMH
3MSH





| REF | OEM |
|--------------------|--------------|
| REC676-44323-00-40 | 676-44323-00 |

 E40GMH/GW/JMH
40JWH/GWH
40QE/G/QM/QE-2/QWC





| REF | OEM |
|-----------------|--------------|
| REC67F-44323-00 | 67F-44323-00 |

 F75/F80/F100



| REF | OEM |
|-----------------|--------------|
| REC66T-44323-00 | 66T-44323-00 |

 40X/E40X/MLH
40XW/XMH
F30/40/T25



| REF | OEM |
|-----------------|--------------|
| REC68T-44323-00 | 68T-44323-00 |

 F6
T8
F9.9
F20/6/9.9/8/13.5
T8/9.9



| REF | OEM |
|-----------------|--------------|
| REC663-44323-00 | 663-44323-00 |

 50G/GEO/GETO
25Q/QEO/B
55B/BE/BM
30DET/DEO/DMH/ELH
60FEO
FETO
FEDO
70BEO/BETO/BEMO/CE
40N/H

50ETN/D/DE
25J/JEO/JETO/ESH
25Q/QEO/E55CMH
30DET/DEO/DMH/D
55B/BM/BET
40E/H
50D/DE
25J/JEO/JETO/ESH



| REF | OEM |
|-----------------|-----------------|
| REC63V-44323-00 | 63V-44323-00-00 |

 9.9F/FMH/FEMH/MSH
F9.9/13.5/15
13.5AWH
15F/FM/MS



| REF | OEM |
|-----------------|-----------------|
| REC688-44323-00 | 688-44323-00-00 |

 60FET/TR
75CETO/AED-T
70BET/TR
75A/AE-M/TLR/CETO/AED-T
E75B

80A/AET/TLR
85A/AE-D-T
90A/AET/ETN/TR



| REF | OEM |
|-----------------|-----------------|
| REC6H3-44323-00 | 6H3-44323-00-00 |

 25B/BETO
F45
50G/GE
T50
F50

FT50
60FE/TLR
FT60
T60
70B/ETN/BE



| REF | OEM |
|--------------------|--------------|
| REC6E5-44323-00-40 | 6E5-44323-00 |

 100A/AETO/TLR
115CET/A/B/BET
C115TLR
130BET
140AET/BET



| REF | OEM |
|-----------------|--------------|
| REC61N-44323-00 | 61N-44323-00 |

 25B/BMH/30H
E30HM
30G
E25A

25VE-M
F20/F25



| REF | OEM |
|-----------------|--------------|
| REC68V-44323-00 | 6EK-44323-00 |

 F115



| REF | OEM |
|-----------------|-------------|
| REC6P2-44323-00 | 6P2-44323-0 |

 Z250
F225/F250



| REF | OEM |
|-----------------|--------------|
| REC6G5-44323-00 | 6G5-44323-01 |

 F150/200/225
Z150/175/250/300
VZ200
250AET/B/GET
225C/CET/D/DET
150F/FET/AET

175D/DET/AET
200F/FET/GE
225G
200AET/BET
150CET
175BET



| REF | OEM |
|-----------------|-----------------|
| REC63D-44323-00 | 63D-44323-00-00 |

 F30/40/45/50/60
40V/VE-M/Y/YE
C40MLH/T
T50
50H/HM-R



**KITS DE REPARACIÓN
BOMBA DE AGUA**

**WATER PUMP
SERVICE KITS**

**KIT RICAMBI
POMPA ACQUA**

**KIT REPARATION DE POMPE
À EAU**

| REF | OEM |
|-----------------|--|
| REC6E0-W0078-A2 | 6E0-W0078-A2 6E0-W0078-00 6E0-W0078-01 6E0-W0078-02 |

new

| REF | OEM |
|-----------------|------------------------------|
| REC69G-W0078-01 | 69G-W0078-01 69G-W0078-00 |

FT/T8 D/P/E/M/G (2005+)
FT/T9.9 E/G/M/L (2008+)

new

| REF | OEM |
|-----------------|--------------|
| REC6A1-W0078-01 | 6A1-W0078-01 |

2B (1985-88)

new

| REF | OEM |
|-----------------|------------------------------|
| REC6AH-W0078-00 | 6AH-W0078-00 6AH-W0078-01 |

F9.9 (2009+)
F13.5B (2007-09)
F15C/E/M (2007+)
F20B/M (2007+)

new

| REF | OEM |
|-----------------|---|
| REC6EE-W0078-01 | 6BX-WG0078-00 6EE-W0078-00 6EE-W0078-01 |

F4B/M (2010+)
F5A/M (2010+)
F6C/M (2010+)

new

| REF | OEM |
|-----------------|--------------|
| REC63V-W0078-01 | 63V-W0078-00 |

9.9F
13.5AWH
15F
F9.9
F15
F13.5

new

| REF | OEM |
|-----------------|------------------------------|
| REC68T-W0078-00 | 68T-W0078-01 68T-W0078-00 |

F6A/B/M (2005-09)
F8C/F/M (2005+)
F9.9 F/M/J (2008+)

new

| REF | OEM |
|-----------------|--------------|
| REC682-W0078-A1 | 682-W0078-A1 |

9.9/15D
F8
F9.9

new

| REF | OEM |
|-----------------|--|
| REC6G1-W0078-A1 | 6G1-W0078-A1 6G1-W0078-00 6N0-W0078-00 6G1-W0078-00 |

6C/D/M/T (1984-14)
8C/N/J/F/T/M (1984-18)

new

| REF | OEM |
|-----------------|------------------------------|
| REC61N-W0078-11 | 61N-W0078-11 61N-W0078-10 |

F20A/D (1998-17)
F25A/E/T/M/D (1998-18)

new

| REF | OEM |
|-----------------|--------------|
| REC689-W0078-04 | 689-W0078-04 |

20CM

| REF | OEM |
|-----------------|--------------|
| REC6BG-W0078-00 | 6BG-W0078-00 |

F30B (2009+)
F40A/F (2009+)

new

| REF | OEM |
|-----------------|--------------|
| REC689-W0078-A6 | 689-W0078-A6 |

20C
25D

| REF | OEM |
|-----------------|--------------|
| REC6CJ-W0078-00 | 6CJ-W0078-00 |

F40G (2011+)
F70A (2011+)

new

| REF | OEM |
|-----------------|--------------|
| REC6L2-W0078-00 | 6L2-W0078-00 |

20NE/NEMO/N/MLH/MSH/NW/NMH/D
20D/DEO/DEM/MSH/DM/MLH
20MSH/DMH/DWO

| REF | OEM |
|-----------------|--------------|
| REC63D-W0078-01 | 63D-W0078-01 |

40V/C40 (1998+)
50H (1997-03)
F45A (1997-00)
F50A/H/F/T (1997+)
F40A/E/Y/D/H (1999+)
F60A/B/C/T (2002+)
F40/45/50/60
40V/NMH/VETO/NMH
C40MLH/T/TLR
40VE/VEO/VES
40Y/YETO
50H/HET/HMH

new

| REF | OEM |
|-----------------|--------------|
| REC6J8-W0078-A2 | 6J8-W0078-A1 |

25J/JEO
30D/DE/DMH

| REF | OEM |
|-----------------|--------------|
| REC679-W0078-A1 | 679-W0078-00 |

40QE

| REF | OEM |
|-----------------|--------------|
| REC6H4-W0078-00 | 6H4-W0078-00 |

25Q/QEO
40N/H/HE
E48CMH
50D/DE/AETN
E55CMH

| REF | OEM |
|-----------------|--------------|
| REC6F5-W0078-A0 | 6F5-W0078-00 |

E40GMH
40GWH

| REF | OEM |
|-----------------|--------------|
| REC66T-W0078-00 | 66T-W0078-01 |

40X
E40X

| REF | OEM |
|-----------------|--------------|
| REC67F-W0078-00 | 67F-W0078-00 |

F80/100

| REF | OEM |
|-----------------|--------------|
| REC663-W0078-01 | 663-W0078-01 |

55B (1992-18)
55BET

new

| REF | OEM |
|-----------------|--------------|
| REC6N6-W0078-02 | 6N6-W0078-00 |

115B/BE/BET/CETO/TRX/CETO
130BET/TLR

| REF | OEM |
|-----------------|--------------|
| REC6K5-W0078-01 | 6K5-W0078-01 |

E60HM
E-60H

| REF | OEM |
|-----------------|--------------|
| REC68V-W0078-00 | 68V-W0078-00 |

F115
FL115
LF115

| REF | OEM |
|-----------------|--------------|
| REC6H3-W0078-02 | 6H3-W0078-00 |

60FE/FET/FEO/FETO
70AETN/B/BEH/BEO/CE

| REF | OEM |
|-----------------|--------------|
| REC65N-W0078-A1 | 65N-W0078-A1 |

D150H/N/NETOL

| REF | OEM |
|-----------------|--------------|
| REC692-W0078-02 | 692-W0078-02 |

60TR/FETO
75AED/AET
75CETO/TLR/E75B
70BETO/TR
80A
85A/AE/AED/AET/AEM
90A/AETO/AEMO/TLR
C90TRZ

| REF | OEM |
|-----------------|--|
| REC6G5-W0078-A1 | 6G5-W0078-00 6G5-W0078-01 6G5-W0078-A1 |

150A/C/E (1984-91)
175A/B (1984-91)
200A/E/B (1984-91)
225A/B (1987-91)

new

new

| REF | OEM |
|-----------------|--------------|
| REC6P2-W0078-00 | 6P2-W0078-00 |

F225C/T (2008-15)
F250B/T/A (2009+)

new

| REF | OEM |
|-----------------|------------------------------|
| REC6CE-W0078-01 | 6CE-W0078-01 6CE-W0078-00 |

F300A/B/C (2001+) V6
F250 C/D (2001+) V6
F225 C/F/L (2011+) V6

| REF | OEM |
|-----------------|--------------|
| REC61A-W0078-A1 | 61A-W0078-01 |

250ETD/AET/AET
150FETO
175FETO
200FETO

new

| REF | OEM |
|-----------------|--------------|
| REC6AW-W0078-00 | 6AW-W0078-00 |

F300A/T (2008-11) V8
F350A/C/T (2008+) V8

| REF | OEM |
|-----------------|--------------|
| REC60X-W0078-00 | 60X-W0078-00 |

Z250FETO
V250TLR
Z300BETO
V300TLR

**GUÍA
KITS DE BOMBA DE AGUA**

**GUIDE OF WATER PUMP
SERVICE KITS**

**GUIDA
KIT POMPA ACQUA**

**GUIDE
KITS POMPES À EAU**

| | | REF | OEM |
|--------|-------------|-----------------|--------------------------|
| 4AC/AS | 1985-96 | REC6E0-W0078-A2 | 6E0-W0078-A2,-00,-01,-02 |
| 5C/CS | 1985-96 | | |
| F9.9 | 6CA1 - 6AC9 | REC6AH-W0078-00 | 6AH-W0078-00 |
| F13.5 | 6AF1 - 6AF3 | | |
| F15 | 6AG1 - 6AG9 | | |
| F15 | 6AGA - 6AGB | | |
| F20 | 6AH1 - 6AH9 | | |
| F20 | 6AHA - 6AHB | | |
| F300 | 6BK1 - 6BK4 | | |
| F300 | 6BJ1 - 6BJ4 | REC6AW-W0078-00 | 6AW-W0078-00 |
| F350 | 6AW1 - 6AW9 | | |
| F350 | 6AX1 - 6AX9 | | |

| | | | REF | OEM |
|------|-------------|---------|-----------------|------------------|
| F30 | 6BT1 - 6BT9 | 2009-16 | REC6BG-W0078-00 | 6BG-W0078-00 |
| F40 | 6BG1 - 6BG9 | 2009-16 | | |
| F40 | 6CY1 - 6CY7 | 2011-16 | REC6CJ-W0078-00 | 6CJ-W0078-00 |
| F70 | 6CJ1 - 6CJ7 | 2011-16 | | |
| F225 | 6CL1 - 6CL4 | 2011-13 | REC6CE-W0078-01 | 6CE-W0078-00,-01 |
| F225 | 6CM1 - 6CM4 | 2011-13 | | |
| F250 | 6CG1 - 6CG4 | 2011-13 | | |
| F250 | 6CH1 - 6CH4 | 2011-13 | | |
| F300 | 6CE1 - 6CE4 | 2011-13 | | |
| F300 | 6CF1 - 6CF4 | 2011-13 | | |

GUÍA BOMBAS DE AGUA

GUIDE WATER PUMP

GUIDA POMPA ACQUA

GUIDE POMPE À EAU

| | | 1 | 2 | 3 | 4 | 5 | 6 | 7 | KIT | |
|-------------------------------------|--|------------------|------------------------------------|-----------------|-----------------|-----------------|-------------------|-----------------|-----------------|-----------------|
| F2.5 | 69F0 > 69F3 60N1 > 60N5 | 2003 | REC6L5-44352-00 | PAF2.6-03000015 | PAF2.6-03000010 | PAF2.6-03000014 | PAJASOF404-19-033 | PAF4-03000021 | PAF2.6-03000013 | |
| F4 | 68R > 68R3 60P1 > 60P2 | 2002-09 | REC6E0-44352-00 | REC6E0-44322-02 | PAF4-03000015 | PAF4-03000019 | PAF4-03000018 | PAF4-03000021 | PAF4-03000016 | |
| F5 | | 2010 | REC6E0-44352-00 | PAF6-03000002 | | PAF6-03000001 | | PAF4-03000021 | PAF4-03000016 | |
| F6B, BMH, A, AM, AW, ML, MH | 6J6 > 6J7 | 2001-09 | REC68T-44352-00 | REC63V-44322-00 | REC68T-44323-00 | REC63V-44301-00 | REC93210-44398 | REC68T-44366-00 | REC664-44338-00 | REC68T-W0078-00 |
| F6A, ML, MS, AM, BM | 60R1 > 60R9 68T > 68T3 60RA > 60RB 6FW1 | 2000-06 | REC68T-44352-00 | REC63V-44322-00 | REC68T-44323-00 | REC63V-44301-00 | REC93210-44398 | REC68T-44366-00 | REC664-44338-00 | REC68T-W0078-00 |
| F6 (1cyl) | | 2010 | REC6E0-44352-00 | PAF6-03000002 | | PAF6-03000001 | PAF4-03000018 | PAF4-03000021 | PAF4-03000016 | |
| F8AM, B, BE, BM | 6G8 | 1986-95 | REC682-44352-01 | REC682-44322-00 | REC682-44323-40 | | REC682-44315-00 | REC682-44365-00 | REC90280-03024 | REC682-W0078-A1 |
| F8C, ML, CM, MS, MH, ML, FM | 6G9 | 2000-15 | REC68T-44352-00 | REC63V-44322-00 | REC68T-44323-00 | REC63V-44301-00 | REC93210-44398 | REC68T-44366-00 | REC664-44338-00 | REC68T-W0078-00 |
| T8 | | 2001-10 | REC63V-44352-01 | REC63V-44322-00 | REC68T-44323-00 | REC63V-44301-00 | REC93210-44398 | REC68T-44366-00 | REC664-44338-00 | |
| F9.9A, AE, AM | 66N>66N8 | 1985-96 | REC682-44352-01 | REC682-44322-00 | REC682-44323-40 | | REC682-44315-00 | REC682-44365-00 | REC90280-03024 | REC682-W0078-A1 |
| F9.9B, BE, BM | 6AU1>6AU6 6DR1>6DR3 | 1985-96 | REC682-44352-01 | REC682-44322-00 | REC682-44323-40 | | REC682-44315-00 | REC682-44365-00 | REC90280-03024 | REC682-W0078-A1 |
| F9.9 | 66R>66R8 | 1985-04 | REC682-44352-01 | REC682-44322-00 | REC682-44323-40 | | REC682-44315-00 | REC682-44365-00 | REC90280-03024 | REC682-W0078-A1 |
| F9.9C, CE, CM, CW, MH | 69C>69C1 | 1998-08 | REC63V-44352-01 | REC63V-44322-00 | REC63V-44323-00 | REC63V-44301-00 | REC93210-44398 | REC647-44366-00 | REC664-44338-00 | REC63V-W0078-01 |
| F9.9F, FE, FM, MH, ML, JE, JM | | 2008-15 | REC63V-44352-01 | REC63V-44322-00 | REC68T-44323-00 | REC63V-44301-00 | REC93210-44398 | REC68T-44366-00 | REC664-44338-00 | REC68T-W0078-00 |
| F9.9D, DE, DM, DW | | 1999-08 | REC63V-44352-01 | REC63V-44322-00 | REC63V-44323-00 | REC63V-44301-00 | REC93210-44398 | REC647-44366-00 | REC664-44338-00 | REC63V-W0078-01 |
| F9.9D, DEP, PLR, TR | 6CA1>6CA8 | 2000-02 | REC63V-44352-01 | REC63V-44322-00 | REC63V-44323-00 | REC63V-44301-00 | REC93210-44398 | REC647-44366-00 | REC664-44338-00 | REC63V-W0078-01 |
| T9.9 | 69V2>69V8 | 1991-99 | REC682-44352-01 | REC682-44322-00 | REC682-44323-40 | | REC682-44315-00 | REC682-44365-00 | REC90280-03024 | REC682-W0078-A1 |
| F9.9HE, HMH | 6P71>6P74 | 2009-15 | REC63V-44352-01 | REC63V-44322-00 | | | | PAF25-04050004 | REC664-44338-00 | REC6AH-W0078-00 |
| T9.9 | 6AF1>6AF3 | 2005-06 | REC63V-44352-01 | REC63V-44322-00 | REC63V-44323-00 | REC63V-44301-00 | REC93210-44398 | REC647-44366-00 | REC664-44338-00 | REC63V-W0078-01 |
| F13.5AE, AM | 66M>66M7 | 2002-07 | REC63V-44352-01 | REC63V-44322-00 | REC63V-44323-00 | REC63V-44301-00 | REC93210-44398 | REC647-44366-00 | REC664-44338-00 | REC63V-W0078-01 |
| F13.5AEP | | 2005-07 | REC63V-44352-01 | REC63V-44322-00 | REC63V-44323-00 | REC63V-44301-00 | REC93210-44398 | REC647-44366-00 | REC664-44338-00 | REC63V-W0078-01 |
| F13.5B, BMH | 6AG1>6AG9 6AGA | 2007-09 | REC63V-44352-01 | REC63V-44322-00 | | | | PAF25-04050004 | REC664-44338-00 | REC6AH-W0078-00 |
| F15A, AE, AM, EL, MH | 65P1>65P5 | 1998-07 | REC63V-44352-01 | REC63V-44322-00 | REC63V-44323-00 | REC63V-44301-00 | REC93210-44398 | REC647-44366-00 | REC664-44338-00 | REC63V-W0078-01 |
| F15 | 6DN1>6DN6 | 2006-11 | REC63V-44352-01 | REC63V-44322-00 | REC68T-44323-00 | | REC93210-49046 | PAF25-04050004 | REC664-44338-00 | |
| F15CE, CM, CW, EL, MH | 6AH1>6AH9 6AHA | 2007-15 | REC63V-44352-01 | REC63V-44322-00 | | | | PAF25-04050004 | REC664-44338-00 | REC6AH-W0078-00 |
| F20AE | 65W>65W9 | 2003-06 | REC6H4-44352-02 | REC61N-44322-00 | REC61N-44323-00 | PAF25-04050001 | PAF25-04050003 | PAF25-04050004 | REC90280-03024 | REC61N-W0078-11 |
| F20DET | 68P1>68P8 | 2011-15 | REC6H4-44352-02 | REC61N-44322-00 | REC61N-44323-00 | PAF25-04050001 | PAF25-04050003 | PAF25-04050004 | REC90280-03024 | REC61N-W0078-11 |
| F20B, BE, BM, BW, EL, MH | | 2007-15 | REC63V-44352-01 | REC63V-44322-00 | | | | PAF25-04050004 | REC664-44338-00 | REC6AH-W0078-00 |
| F25A, AE, AM, AW, EL, MH | | 1998-09 | REC6H4-44352-02 | REC61N-44322-00 | REC61N-44323-00 | PAF25-04050001 | PAF25-04050003 | PAF25-04050004 | REC90280-03024 | REC61N-W0078-11 |
| F25DE, DM, MH | 6BT1>6BT8 | 2009-215 | REC6H4-44352-02 | REC61N-44322-00 | REC61N-44323-00 | PAF25-04050001 | PAF25-04050003 | PAF25-04050004 | REC90280-03024 | REC61N-W0078-11 |
| T25 | 66W>66W1 | 2001-06, 2009 | REC6H4-44352-02 | REC63D-44322-00 | REC66T-44323-00 | | REC93210-59MG7 | REC90280-03M03 | REC66T-W0078-00 | |
| F30 | 60K1 | 2001-05 | REC6H4-44352-02 | REC63D-44322-00 | REC66T-44323-00 | | REC93210-59MG7 | REC90280-03M03 | REC66T-W0078-00 | |
| F30BE | | 2009-15 | REC6H4-44352-02 | REC63D-44322-00 | REC63D-44323-00 | | REC93210-59MG7 | REC663-44366-00 | REC90280-03M03 | REC6BG-W0078-00 |
| F40 A, ELH | 6BG1>6BG8 | 1999-02 | REC6H3-44352-00 | REC63D-44322-00 | REC63D-44323-00 | | REC93210-59MG7 | REC90280-03024 | REC63D-W0078-01 | |
| F40 CET | 6AK1>6AK9 6AKA>6AKB | 2002 | REC6H3-44352-00 | REC63D-44322-00 | REC63D-44323-00 | | REC93210-59MG7 | REC90280-03024 | REC63D-W0078-01 | |
| F40 | 6CY1>6CY6 | 2000-08 | REC6H4-44352-02 | REC63D-44322-00 | REC66T-44323-00 | | REC93210-59MG7 | REC90280-03M03 | REC66T-W0078-00 | |
| F40FE | 62Y | 2009-15 | REC6H4-44352-02 | REC63D-44322-00 | REC63D-44323-00 | | REC93210-59MG7 | REC663-44366-00 | REC90280-03M03 | REC6BG-W0078-00 |
| F40D, DE, HE | 62Y | 2006-15 | REC6H3-44352-00 | REC63D-44322-00 | REC63D-44323-00 | | REC93210-59MG7 | REC663-44366-00 | REC90280-03024 | REC63D-W0078-01 |
| F40GET | 62Y>62Y6 | 2011-15 | REC6H3-44352-00 REC63D-44322-00 | | | | | REC663-44366-00 | REC90280-03M03 | REC6CJ-W0078-00 |
| F45 AET | 60A3 60AA | 1999 | REC6H4-44352-02 | REC61N-44322-00 | REC61N-44323-00 | PAF25-04050001 | PAF25-04050003 | PAF25-04050004 | REC90280-03024 | REC61N-W0078-11 |
| F50TJR | 6C11>6C19 | 2003 | REC6H4-44352-02 | REC61N-44322-00 | REC61N-44323-00 | PAF25-04050001 | PAF25-04050003 | PAF25-04050004 | REC90280-03024 | REC61N-W0078-11 |
| F50 A, AE, TJ, TL | 6C1A>6C1C | 1997-07 | REC6H3-44352-00 | REC63D-44322-00 | REC63D-44323-00 | | REC93210-59MG7 | REC663-44366-00 | REC90280-03024 | REC63D-W0078-01 |
| F50 DETL | 64J | 1995-10 | REC6H3-44352-00 | REC63D-44322-00 | REC63D-44323-00 | | REC93210-59MG7 | REC663-44366-00 | REC90280-03024 | REC63D-W0078-01 |
| F50F, FE, TR, TL | 605-12 | 2005-12 | REC6H3-44352-00 | REC63D-44322-00 | REC63D-44323-00 | | REC93210-59MG7 | REC663-44366-00 | REC90280-03024 | REC63D-W0078-01 |
| F50 HED | 69W1>69W6 | 2013-15 | REC6H3-44352-00 | REC63D-44322-00 | REC63D-44323-00 | | REC93210-59MG7 | REC663-44366-00 | REC90280-03024 | REC63D-W0078-01 |
| F50B, T50TLR | 6C51>6C59 | 1997-99 | REC6H3-44352-00 | REC63D-44322-00 | REC63D-44323-00 | | REC93210-59MG7 | REC663-44366-00 | REC90280-03024 | REC63D-W0078-01 |
| T50 | 6C5A>6C5C | 1996 | REC6H3-44352-00 | REC663-44322-00 | REC6H3-44323-00 | | REC6H3-44315-00 | REC90280-03024 | REC6H3-W0078-02 | |
| F60 AE, TL, TJ | | 2002-07 | REC6H3-44352-00 | REC63D-44322-00 | REC63D-44323-00 | | REC6H3-44315-00 | REC663-44366-00 | REC90280-03M03 | REC63D-W0078-01 |
| F60 A, C, CET, TR, TJR | 6CJ1>6CJ6 | 2005-12 | REC6H3-44352-00 | REC63D-44322-00 | REC63D-44323-00 | | REC6H3-44315-00 | REC663-44366-00 | REC90280-03M03 | REC63D-W0078-01 |
| F60 B, FET | 6D61 | 2013-15 | REC6H3-44352-00 | REC63D-44322-00 | REC63D-44323-00 | | REC6H3-44315-00 | REC663-44366-00 | REC90280-03M03 | REC63D-W0078-01 |
| T60 | 67G0>67G5 | 2003-11 | REC6H3-44352-00 | REC663-44322-00 | REC6H3-44323-00 | | REC6H3-44315-00 | REC90280-03M03 | REC6H3-W0078-02 | |
| F70A, AET | 6D71>6D79 6D7A>6D7C | 2011-15 | REC6H3-44352-00 REC63D-44322-00 | | | | | REC663-44366-00 | REC90280-03M03 | REC6CJ-W0078-00 |
| F75BET, TR, TLR | | 2005 | REC67F-44352-00 | REC67F-44322-00 | REC67F-44323-00 | REC67F-44311-01 | REC688-44315-00 | REC90280-04M04 | REC67F-W0078-00 | |
| F80A, AET, TLR, TJR | 67F>67F5 | 1999-03 | REC67F-44352-00 | REC67F-44322-00 | REC67F-44323-00 | REC67F-44311-01 | REC688-44315-00 | REC90280-04M04 | REC67F-W0078-00 | |
| F80B, BET | 6D91>6D99 6D9A>6D9C | 2005-15 | REC67F-44352-00 | REC67F-44322-00 | REC67F-44323-00 | REC67F-44311-01 | REC688-44315-00 | REC90280-04M04 | REC67F-W0078-00 | |
| F90 | 68V, 68V0, 68W0 | 2003-11 | REC67F-44352-00 | REC67F-44322-00 | REC67F-44323-00 | REC67F-44311-01 | REC688-44315-00 | REC90280-04M04 | REC67F-W0078-00 | |
| F100A, AET, TLR, TRZ | | 1999-06 | REC67F-44352-00 | REC67F-44322-00 | REC67F-44323-00 | REC67F-44311-01 | REC688-44315-00 | REC90280-04M04 | REC67F-W0078-00 | |

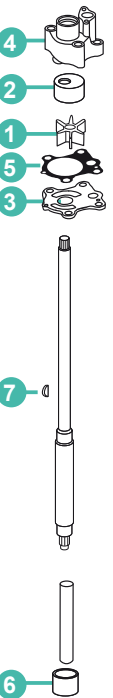



| | | | 1 | 2 | 3 | 4 | 5 | 6 | 7 | KIT |
|-----------------------------------|------------------------|------------------|-----------------|-----------------|--------------------|-----------------|-----------------|-----------------|----------------|-----------------|
| F100DET | 68V, 68VO, 68W0 | 2005-15 | REC67F-44352-00 | REC67F-44322-00 | REC67F-44323-00 | REC67F-44311-01 | REC688-44315-00 | | REC90280-04M04 | REC67F-W0078-00 |
| F115A (68V/68VO) | | 2000-01 | REC6E5-44352-01 | REC61A-44322-02 | REC6E5-44323-00-40 | REC6E5-44311-00 | REC93210-86M38 | REC6E5-44366-00 | REC90280-04M05 | REC6N6-W0078-02 |
| F115TLR (68V) | 68V1>68V9 68VA>68VF | 2000 | REC6E5-44352-01 | REC61A-44322-02 | REC6E5-44323-00-40 | REC6E5-44311-00 | REC93210-86M38 | REC6E5-44366-00 | REC90280-04M05 | REC6N6-W0078-02 |
| F115TLR/ TRZ/ TXR | 68W1>68W9 68WA>68WF | 2000-01 | REC6E5-44352-01 | REC61A-44322-02 | REC6E5-44323-00-40 | REC6E5-44311-00 | REC93210-86M38 | REC6E5-44366-00 | REC90280-04M05 | REC6N6-W0078-02 |
| LF115TXR (68W/68W0) | 6EK1>6EK2 6EL1>6EL2 | 2000-01 | REC6E5-44352-01 | REC61A-44322-02 | REC6E5-44323-00-40 | REC6E5-44311-00 | REC93210-86M38 | REC6E5-44366-00 | REC90280-04M05 | REC6N6-W0078-02 |
| F115A, AET, TJR6EM1 | | 2002-15 | REC6E5-44352-01 | REC61A-44322-02 | REC68V-44323-00 | REC61A-44311-00 | REC93210-86M38 | REC6E5-44365-00 | REC90280-04M05 | REC68V-W0078-00 |
| LF/FL115A, AET, TX, TR, B, BET | | 2002-15 | REC6E5-44352-01 | REC61A-44322-02 | REC68V-44323-00 | REC61A-44311-00 | REC93210-86M38 | REC6E5-44365-00 | REC90280-04M05 | REC68V-W0078-00 |
| FL/FL115B, BET | | 2014-15 | REC6E5-44352-01 | REC61A-44322-02 | REC68V-44323-00 | REC61A-44311-00 | REC93210-86M38 | REC6E5-44365-00 | REC90280-04M05 | REC68V-W0078-00 |
| F130A, AET | | 2015 | REC6E5-44352-01 | REC61A-44322-02 | REC68V-44323-00 | REC61A-44311-00 | REC93210-86M38 | REC6E5-44365-00 | REC90280-04M05 | REC68V-W0078-00 |
| F150/FL150 | | 2004-12 | REC6E5-44352-01 | REC61A-44322-02 | REC6G5-44323-00 | REC61A-44311-00 | REC93210-86M38 | REC6E5-44365-00 | REC90280-04M05 | REC61A-W0078-A1 |
| F200/FL200 | | 2002-11 | REC6E5-44352-01 | REC61A-44322-02 | REC6G5-44323-00 | REC61A-44311-00 | REC93210-86M38 | REC6E5-44365-00 | REC90280-04M05 | REC61A-W0078-A1 |
| VF200 | 6BB2>6BB9 | 2009-11 | REC6E5-44352-01 | REC61A-44322-02 | | REC61A-44311-00 | REC93210-86M38 | REC6E5-44365-00 | | |
| F225/FL225 | 6CL1>6CL4 6CM1>6CM4 | 2002-10 | REC6E5-44352-01 | REC61A-44322-02 | REC6G5-44323-00 | REC61A-44311-00 | REC93210-86M38 | REC6E5-44365-00 | REC90280-04M05 | REC61A-W0078-A1 |
| F225/FL225 | | 2007-09 (20") | REC6E5-44352-01 | REC61A-44322-02 | REC6P2-44323-00 | REC61A-44311-00 | REC93210-86M38 | REC6E5-44365-00 | REC90280-04M05 | REC6P2-W0078-00 |
| F225CET | | 2009-15 | REC6E5-44352-01 | REC61A-44322-02 | REC6P2-44323-00 | REC61A-44311-00 | REC93210-86M38 | REC6E5-44365-00 | REC90280-04M05 | REC6P2-W0078-00 |
| LF/FL/F225CA, FET | 6BR1>6BR3 6BS1>6BS3 | 2011-13 | REC6CE-44352-00 | | | | | | | |
| VF225 | 6P2A 6P23>6P29 | 2009-11 | REC6E5-44352-01 | REC61A-44322-02 | | REC61A-44311-00 | REC93210-86M38 | REC6E5-44365-00 | | |
| F250/FL250 | 6P33>6P39 | 2005 | REC6E5-44352-01 | REC61A-44322-02 | REC6G5-44323-00 | REC61A-44311-00 | REC93210-86M38 | REC6E5-44365-00 | REC90280-04M05 | REC61A-W0078-A1 |
| FL/F250BET | 6CG1>6CG4 6CH1>6CH4 | 2001-11 | REC6E5-44352-01 | REC61A-44322-02 | REC6P2-44323-00 | REC61A-44311-00 | REC93210-86M38 | REC6E5-44365-00 | REC90280-04M05 | REC6P2-W0078-00 |
| F250A, AET, TR, TUR | | 2007-13 | REC6E5-44352-01 | REC61A-44322-02 | REC6P2-44323-00 | REC61A-44311-00 | REC93210-86M38 | REC6E5-44365-00 | REC90280-04M05 | REC6P2-W0078-00 |
| LF/FL250A, AET, TR, TX | 6CF1>6CF4 6CF1>6CF4 | 2007-12 | REC6E5-44352-01 | REC61A-44322-02 | REC6P2-44323-00 | REC61A-44311-00 | REC93210-86M38 | REC6E5-44365-00 | REC90280-04M05 | REC6P2-W0078-00 |
| LF/FL/F250CA, DET | 6B11>6B14 6BK1>6BK4 | 2011-13 | REC6CE-44352-00 | | | | | | | |
| VF250 | 6AW1>6AW9 | 2009-10 | REC6E5-44352-01 | REC61A-44322-02 | | REC61A-44311-00 | REC93210-86M38 | REC6E5-44365-00 | REC90280-04M05 | |
| F300/FL- 300BET, CA | 6AX1>6AX9 | 2011-13 | REC6CE-44352-00 | | | | | | | |
| F300/FL300AET | | 2008-11 | CEF500389N | | | | | | | REC6AW-W0078-00 |
| F350AET, CB, TRG, TUR | | 2008-15 | CEF500389N | | | | | | | REC6AW-W0078-00 |
| LF/FL350AET, CB, TRG, TUR | | 2008-15 | CEF500389N | | | | | | | REC6AW-W0078-00 |

2T
STROKESGUÍA
BOMBAS DE AGUAGUIDE
WATER PUMPGUIDA
POMPA ACQUAGUIDE
POMPE À EAU

| | | | 1 | 2 | 3 | 4 | 5 | 6 | 7 | KIT |
|------------------------------|----------------------|---------|-----------------|-----------------|-----------------|-----------------|-----------------|-----------------|-----------------|-----------------|
| 2B | 6A1 | 1985-99 | | | REC646-44323-00 | | | | | REC6A1-W0078-01 |
| 2B, MSHA | 6A11>6A12 6F89 | 2002-10 | REC646-44352-01 | | REC646-44323-00 | | | | | |
| 4AC, AS | 6E0>6E1 | 1985-96 | REC6E0-44352-00 | REC6E0-44322-02 | PAF4-03000015 | | | PAF4-03000021 | | REC6E0-W0078-A2 |
| 5C, CS | 6E3>6E4 | 1985-96 | REC6E0-44352-00 | REC6E0-44322-02 | PAF4-03000015 | | | PAF4-03000021 | | REC6E0-W0078-A2 |
| 6 D /DEM | 6H8 | 1984-96 | REC6G1-44352-00 | REC6G1-44322-02 | REC6G1-44323-00 | | REC6G1-44315-A0 | REC647-44366-00 | REC90280-03024 | REC6G1-W0078-A1 |
| 6 J / C / CEM | 6H6 | 1984-96 | REC6G1-44352-00 | REC6G1-44322-02 | REC6G1-44323-00 | | REC6G1-44315-A0 | REC647-44366-00 | REC90280-03024 | REC6G1-W0078-A1 |
| 8 N / J / C / CEM | 6G1 | 1984-96 | REC6G1-44352-00 | REC6G1-44322-02 | REC6G1-44323-00 | | REC6G1-44315-A0 | REC647-44366-00 | REC90280-03024 | REC6G1-W0078-A1 |
| 9.9D | 6,00E+007 | 1984-95 | REC682-44352-01 | REC682-44322-00 | REC682-44323-40 | | REC682-44315-00 | REC682-44365-00 | REC90280-03024 | REC682-W0078-A1 |
| 9.9F, FEM, FM, MH, MS | 63V | 1995-00 | REC63V-44352-01 | REC63V-44322-00 | REC63V-44323-00 | REC63V-44301-00 | REC93210-44398 | REC647-44366-00 | REC664-44338-00 | REC63V-W0078-01 |
| 13.5AWH | 63V | 1998 | REC63V-44352-01 | REC63V-44322-00 | REC63V-44323-00 | REC63V-44301-00 | REC93210-44398 | REC647-44366-00 | REC664-44338-00 | REC63V-W0078-01 |
| 15D | 6,00E+008 | 1984-95 | REC682-44352-01 | REC682-44322-00 | REC682-44323-40 | | REC682-44315-00 | REC682-44365-00 | REC90280-03024 | REC682-W0078-A1 |
| 15F, FEM, MH, MS | 63W | 1995-00 | REC63V-44352-01 | REC63V-44322-00 | REC63V-44323-00 | REC63V-44301-00 | REC93210-44398 | REC647-44366-00 | REC664-44338-00 | REC63V-W0078-01 |
| 20D, DE, DM, MLH, MSH, DW | 6L3>6L39 | 1998-11 | REC6L2-44352-00 | REC6L2-44322-00 | | | REC93210-45161 | PAF25-04050004 | PAF25-04000015 | REC6L2-W0078-00 |
| 20C | 6A9 / 6A90 / 6A91 | 1997-02 | REC689-44352-02 | REC689-W4432-01 | REC689-44323-00 | REC689-44311-00 | REC689-44324-A0 | REC689-44366-00 | REC664-44338-00 | REC689-W0078-A6 |
| 20CM | 6A9 | 1992 | REC689-44352-02 | REC689-W4432-01 | REC689-44323-00 | REC689-44311-00 | REC689-44324-A0 | REC689-44366-00 | REC664-44338-00 | REC689-W0078-A6 |
| 25D | 6950 | 2001 | REC689-44352-02 | REC689-W4432-01 | REC689-44323-00 | REC689-44311-00 | REC689-44324-A0 | REC689-44366-00 | REC664-44338-00 | REC689-W0078-A6 |
| 25 | | 1984-85 | REC689-44352-02 | REC689-W4432-01 | REC689-44323-00 | REC689-44311-00 | REC689-44324-A0 | REC689-44366-00 | REC664-44338-00 | REC689-W0078-04 |
| 25D, N, NE, MLH, MSH, NMH | 6L2>6L29 | 1998-10 | REC6L2-44352-00 | REC6L2-44322-00 | | | REC93210-45161 | PAF25-04050004 | PAF25-04000015 | REC6L2-W0078-00 |
| 25NMH, NW, MH | 6L2A>6L2F | 2011-15 | REC6L2-44352-00 | REC6L2-44322-00 | | | REC93210-45161 | PAF25-04050004 | PAF25-04000015 | REC6L2-W0078-00 |
| 25 J, JEO | 6K9 | 1987-94 | REC6H4-44352-02 | REC663-44322-00 | REC663-44323-00 | REC663-44311-02 | REC663-44315-A0 | REC663-44366-00 | REC90280-03024 | REC6J8-W0078-A2 |
| C25 | | 1990-97 | REC689-44352-02 | REC689-W4432-01 | REC689-44323-00 | REC689-44311-00 | REC689-44324-A0 | REC689-44366-00 | REC664-44338-00 | REC689-W0078-A6 |
| CV25 | | 1990 | REC689-44352-02 | REC689-W4432-01 | REC689-44323-00 | REC689-44311-00 | REC689-44324-A0 | REC689-44366-00 | REC664-44338-00 | REC689-W0078-A6 |
| 30 | | 1984-85 | REC689-44352-02 | REC689-W4432-01 | REC689-44323-00 | REC689-44311-00 | REC689-44324-A0 | REC689-44366-00 | REC664-44338-00 | REC689-W0078-04 |
| 30 | | 1986 | REC689-44352-02 | REC689-W4432-01 | REC689-44323-00 | REC689-44311-00 | REC689-44324-A0 | REC689-44366-00 | REC664-44338-00 | REC689-W0078-A6 |
| 30D | | 1986-94 | REC6H4-44352-02 | REC663-44322-00 | REC663-44323-00 | REC663-44311-02 | REC663-44315-A0 | REC663-44366-00 | REC90280-03024 | REC682-W0078-A1 |
| 30D, DE, DMH | 6J8 | 1986-94 | REC6H4-44352-02 | REC663-44322-00 | REC663-44323-00 | REC663-44311-02 | REC663-44315-A0 | REC663-44366-00 | REC90280-03024 | REC6J8-W0078-A2 |
| C30 | | 1990-92 | REC689-44352-02 | REC689-W4432-01 | REC689-44323-00 | REC689-44311-00 | REC689-44324-A0 | REC689-44366-00 | REC664-44338-00 | REC689-W0078-A6 |
| C30 | | 1993-97 | REC6H4-44352-02 | REC61N-44322-00 | REC61N-44323-00 | PAF25-04050001 | PAF25-04050003 | PAF25-04050004 | REC90280-03024 | REC61N-W0078-11 |
| 40 | | 1984-87 | REC6H4-44352-02 | REC663-44322-00 | REC663-44323-00 | REC663-44311-02 | REC663-44315-A0 | REC663-44366-00 | REC90280-03024 | REC6H4-W0078-00 |
| 40 | | 1988-94 | REC6H4-44352-02 | REC663-44322-00 | REC663-44323-00 | | REC663-44315-A0 | REC663-44366-00 | REC90280-03024 | REC6H4-W0078-00 |

| | | | 1 | 2 | 3 | 4 | 5 | 6 | 7 | KIT |
|------------------------------|------------------------------------|-----------|-----------------|-----------------|--------------------|-----------------|-----------------|-----------------|----------------|-----------------|
| 40 | | 1995-05 | REC6H3-44352-00 | REC63D-44322-00 | REC63D-44323-00 | REC63D-44311-01 | REC93210-59MG7 | REC663-44366-00 | REC90280-03024 | REC63D-W0078-01 |
| E40GMH | 6F62 | 2003 | REC6F5-44352-00 | REC676-44322-00 | REC676-44323-00-40 | REC676-44311-00 | REC676-44315-00 | REC663-44366-00 | REC90280-04M00 | REC6F5-W0078-A0 |
| 40GWH | 6F62 | 2003 | REC6F5-44352-00 | REC676-44322-00 | REC676-44323-00-40 | REC676-44311-00 | REC676-44315-00 | REC663-44366-00 | REC90280-04M00 | REC6F5-W0078-A0 |
| C40 | | 1990-91 | REC6F5-44352-00 | REC676-44322-00 | REC676-44323-00-40 | REC676-44311-00 | REC676-44315-00 | REC663-44366-00 | REC90280-04M00 | REC6F5-W0078-A0 |
| C40 | | 1992-97 | REC6F5-44352-00 | REC676-44322-00 | REC676-44323-00-40 | REC676-44311-00 | REC676-44315-00 | REC663-44366-00 | REC90280-04M00 | REC679-W0078-A1 |
| 40QE | 6R6 | 1990 | REC6F5-44352-00 | REC676-44322-00 | REC676-44323-00-40 | REC676-44311-00 | REC676-44315-00 | REC663-44366-00 | REC90280-04M00 | REC679-W0078-A1 |
| EK40JMH | 6H95 | 2006 | REC6F5-44352-00 | REC676-44322-00 | REC676-44323-00-40 | REC676-44311-00 | REC676-44315-00 | REC663-44366-00 | REC90280-04M00 | REC679-W0078-A1 |
| C40MLH | 63B>63B2 | 2000-03 | REC6H3-44352-00 | REC63D-44322-00 | REC63D-44323-00 | REC63D-44311-01 | REC93210-59MG7 | REC663-44366-00 | REC90280-03024 | REC63D-W0078-01 |
| C40T, TLRZ | 63D>63D6 | 1996-03 | REC6H3-44352-00 | REC63D-44322-00 | REC63D-44323-00 | REC63D-44311-01 | REC93210-59MG7 | REC663-44366-00 | REC90280-03024 | REC63D-W0078-01 |
| P40 | | 1998 | REC6H3-44352-00 | REC63D-44322-00 | REC63D-44323-00 | REC63D-44311-01 | REC93210-59MG7 | REC663-44366-00 | REC90280-03024 | REC63D-W0078-01 |
| 40V, VE | 63D>63D6 | 1996-03 | REC6H3-44352-00 | REC63D-44322-00 | REC63D-44323-00 | REC63D-44311-01 | REC93210-59MG7 | REC663-44366-00 | REC90280-03024 | REC63D-W0078-01 |
| 40V, VE, VEO, VES | 63C>63C9 63CA>63CF | 1997-15 | REC6H3-44352-00 | REC63D-44322-00 | REC63D-44323-00 | REC63D-44311-01 | REC93210-59MG7 | REC663-44366-00 | REC90280-03024 | REC63D-W0078-01 |
| 40V, VMH | 63B>63BF | 1995-15 | REC6H3-44352-00 | REC63D-44322-00 | REC63D-44323-00 | REC63D-44311-01 | REC93210-59MG7 | REC663-44366-00 | REC90280-03024 | REC63D-W0078-01 |
| 50 | | 1984-87 | REC6H4-44352-02 | REC663-44322-00 | REC663-44323-00 | REC663-44311-02 | REC663-44315-A0 | REC663-44366-00 | REC90280-03024 | REC6H4-W0078-00 |
| 50 | | 1988-94 | REC6H4-44352-02 | REC663-44322-00 | REC663-44323-00 | REC663-44311-02 | REC663-44315-A0 | REC663-44366-00 | REC90280-03024 | REC6H4-W0078-00 |
| 50HMD0, H | 62W,63G | 1995-00 | REC6H3-44352-00 | REC63D-44322-00 | REC63D-44323-00 | REC63D-44311-01 | REC93210-59MG7 | REC663-44366-00 | REC90280-03024 | REC63D-W0078-01 |
| 50H, HEM, HWH/ CS0TLR | 62X>62X5 | 2000-03 | REC6H3-44352-00 | REC63D-44322-00 | REC63D-44323-00 | REC63D-44311-01 | REC93210-59MG7 | REC663-44366-00 | REC90280-03024 | REC63D-W0078-01 |
| C50 | | 1998-01 | REC6H3-44352-00 | REC63D-44322-00 | REC63D-44323-00 | REC63D-44311-01 | REC93210-59MG7 | REC663-44366-00 | REC90280-03024 | REC63D-W0078-01 |
| PRO 50 | | 1987 | REC6H4-44352-02 | REC663-44322-00 | REC663-44323-00 | REC663-44311-02 | REC663-44315-A0 | REC663-44366-00 | REC90280-03024 | REC6H4-W0078-00 |
| PRO 50 | | 1988-90 | REC6H4-44352-02 | REC663-44322-00 | REC663-44323-00 | REC663-44311-02 | REC663-44315-A0 | REC663-44366-00 | REC90280-03024 | REC6H4-W0078-00 |
| P50 | | 1991-93 | REC6H4-44352-02 | REC663-44322-00 | REC663-44323-00 | REC663-44311-02 | REC663-44315-A0 | REC663-44366-00 | REC90280-03024 | REC6H4-W0078-00 |
| P50 | | 1995-96 | REC6H3-44352-00 | REC689-W4432-01 | REC63D-44323-00 | REC63D-44311-01 | REC93210-59MG7 | REC663-44366-00 | REC90280-03024 | REC63D-W0078-01 |
| 55B, BET, BM | 697 | 1992-00 | REC6H3-44352-00 | REC663-44322-00 | REC663-44323-00 | REC663-44311-02 | REC663-44315-A0 | REC663-44366-00 | REC90280-03M03 | REC663-W0078-01 |
| 55B, BET, BM | 6970>6971 | 1989 | REC6H3-44352-00 | REC663-44322-00 | REC663-44323-00 | REC663-44311-02 | REC663-44315-A0 | REC663-44366-00 | REC90280-03M03 | REC663-W0078-01 |
| 60 | | 2001-03 | REC6H3-44352-00 | REC663-44322-00 | REC6H3-44323-00 | | REC6H3-44315-00 | REC663-44366-00 | REC90280-03M03 | REC6H3-W0078-02 |
| 60 | | 2004-05 | REC688-44352-03 | REC688-44322-00 | REC688-44323-00 | REC688-44311-01 | REC688-44315-00 | REC663-44366-00 | REC90280-04M04 | REC692-W0078-02 |
| C60 | | 1996-01 | REC6H3-44352-00 | REC663-44322-00 | REC6H3-44323-00 | | REC6H3-44315-00 | REC663-44366-00 | REC90280-03M03 | REC6H3-W0078-02 |
| E60 | | 1995-96 | REC6H3-44352-00 | REC663-44322-00 | REC6H3-44323-00 | | REC6H3-44315-00 | REC663-44366-00 | REC90280-03M03 | REC6H3-W0078-02 |
| E-60H/ E60HMH | 6K5 | 1997-00 | REC6H3-44352-00 | | REC6H3-44323-00 | | REC6H3-44315-00 | REC663-44366-00 | REC90280-03M03 | REC6K5-W0078-01 |
| P60 | | 1991 | REC6H3-44352-00 | REC663-44322-00 | REC6H3-44323-00 | | REC6H3-44315-00 | REC663-44366-00 | REC90280-03M03 | REC6H3-W0078-02 |
| P60 | | 1992-99 | REC6H3-44352-00 | REC663-44322-00 | REC6H3-44323-00 | | REC6H3-44315-00 | REC663-44366-00 | REC90280-03M03 | REC6H3-W0078-02 |
| 70 | | 1984-03 | REC6H3-44352-00 | REC663-44322-00 | REC6H3-44323-00 | | REC6H3-44315-00 | REC663-44366-00 | REC90280-03M03 | REC6H3-W0078-02 |
| 70 | | 2004-09 | REC688-44352-03 | REC688-44322-00 | REC688-44323-00 | REC688-44311-01 | REC688-44315-00 | REC663-44366-00 | REC90280-04M04 | REC692-W0078-02 |
| C70 | | 2000-01 | REC6H3-44352-00 | REC663-44322-00 | REC6H3-44323-00 | | REC6H3-44315-00 | REC663-44366-00 | REC90280-03M03 | REC6H3-W0078-02 |
| C75 | | 1994-99 | REC688-44352-03 | REC688-44322-00 | REC688-44323-00 | REC688-44311-01 | REC688-44315-00 | REC663-44366-00 | REC90280-04M04 | REC692-W0078-02 |
| E75 | | 1995-00 | REC688-44352-03 | | REC688-44323-00 | REC688-44311-01 | REC688-44315-00 | REC663-44366-00 | REC90280-04M04 | REC692-W0078-02 |
| P75 | | 1996-99 | REC688-44352-03 | REC688-44322-00 | REC688-44323-00 | REC688-44311-01 | REC688-44315-00 | REC663-44366-00 | REC90280-04M04 | REC692-W0078-02 |
| 75CETO, TLR | 67P1>67P9 | 2003-2011 | REC688-44352-03 | REC688-44322-00 | REC688-44323-00 | REC688-44311-01 | REC688-44315-00 | REC663-44366-00 | REC90280-04M04 | REC692-W0078-02 |
| 75CETO | 67PA>67PE | 2012-15 | REC688-44352-03 | REC688-44322-00 | REC688-44323-00 | REC688-44311-01 | REC688-44315-00 | REC663-44366-00 | REC90280-04M04 | REC692-W0078-02 |
| 75A, AE | 692>692B 692A>692C | 1997-07 | REC688-44352-03 | REC688-44322-00 | REC688-44323-00 | REC688-44311-01 | REC688-44315-00 | REC663-44366-00 | REC90280-04M04 | REC692-W0078-02 |
| 80A, AEO, AEM | 6H0>6H01 | 1997-02 | REC688-44352-03 | REC688-44322-00 | REC688-44323-00 | REC688-44311-01 | REC688-44315-00 | REC663-44366-00 | REC90280-04M04 | REC692-W0078-02 |
| C80 | | 1997 | REC688-44352-03 | REC688-44322-00 | REC688-44323-00 | REC688-44311-01 | REC688-44315-00 | REC663-44366-00 | REC90280-04M04 | REC692-W0078-02 |
| 85A, AED, AET | 688>6882 | 1997-03 | REC688-44352-03 | REC688-44322-00 | REC688-44323-00 | REC688-44311-01 | REC688-44315-00 | REC663-44366-00 | REC90280-04M04 | REC692-W0078-02 |
| 85A | 688 | 1990 | REC682-44352-01 | REC682-44322-00 | REC682-44323-40 | | REC682-44315-00 | REC682-44365-00 | REC90280-03024 | REC682-W0078-A1 |
| C85 | | 1989-97 | REC688-44352-03 | REC688-44322-00 | REC688-44323-00 | REC688-44311-01 | REC688-44315-00 | REC663-44366-00 | REC90280-04M04 | REC692-W0078-02 |
| CV85 | | 1989-91 | REC688-44352-03 | REC688-44322-00 | REC688-44323-00 | REC688-44311-01 | REC688-44315-00 | REC663-44366-00 | REC90280-04M04 | REC692-W0078-02 |
| 90AEO | 6H1 | 1992 | REC682-44352-01 | REC682-44322-00 | REC682-44323-40 | | REC682-44315-00 | REC682-44365-00 | REC90280-03024 | REC682-W0078-A1 |
| 90A, AE, TR, TLR, FE, BET | 6H1>6H39 6H1A>6H3F 6H2C>6H2J | 1997-15 | REC688-44352-03 | REC688-44322-00 | REC688-44323-00 | REC688-44311-01 | REC688-44315-00 | REC663-44366-00 | REC90280-04M04 | REC692-W0078-02 |
| B90 | | 1997-99 | REC688-44352-03 | REC688-44322-00 | REC688-44323-00 | REC688-44311-01 | REC688-44315-00 | REC663-44366-00 | REC90280-04M04 | REC692-W0078-02 |
| C90 | | 1997-01 | REC688-44352-03 | REC688-44322-00 | REC688-44323-00 | REC688-44311-01 | REC688-44315-00 | REC663-44366-00 | REC90280-04M04 | REC692-W0078-02 |
| 100A/ AETO | 64W | 1996 | REC6E5-44352-01 | REC61A-44322-02 | REC6E5-44323-00-40 | REC61A-44311-00 | REC6E5-44315-A0 | REC6E5-44366-00 | REC90280-04M05 | REC6N6-W0078-02 |
| 100A/ TLR | 64W/ 64W0 | 1997-01 | REC6E5-44352-01 | REC6E5-44322-00 | REC6E5-44323-00-40 | REC6E5-44311-00 | REC93210-86M38 | REC6E5-44366-00 | REC90280-04M05 | REC6N6-W0078-02 |
| 115B/ BE | 6E5/ 6E50/ 6E51 | 1998-02 | REC6E5-44352-01 | REC6E5-44322-00 | REC6E5-44323-00-40 | REC6E5-44311-00 | REC93210-86M38 | REC6E5-44366-00 | REC90280-04M05 | REC6N6-W0078-02 |
| 115B/ BE/ BETO | 6,00E+005 | 1993-96 | REC6E5-44352-01 | REC61A-44322-02 | REC6E5-44323-00-40 | REC61A-44311-00 | REC6E5-44315-A0 | REC6E5-44366-00 | REC90280-04M05 | REC6N6-W0078-02 |
| 115BE | 6E5 | 1997 | REC6E5-44352-01 | REC6E5-44322-00 | REC6E5-44323-00-40 | REC6E5-44311-00 | REC93210-86M38 | REC6E5-44366-00 | REC90280-04M05 | REC6N6-W0078-02 |
| 115C | 6N6 6N61 | 2000-02 | REC6E5-44352-01 | REC6E5-44322-00 | REC6E5-44323-00-40 | REC6E5-44311-00 | REC93210-86M38 | REC6E5-44366-00 | REC90280-04M05 | REC6N6-W0078-02 |
| 115CEO/ CETO | 6N6 | 1993-96 | REC6E5-44352-01 | REC61A-44322-02 | REC6E5-44323-00-40 | REC61A-44311-00 | REC6E5-44315-A0 | REC6E5-44366-00 | REC90280-04M05 | REC6N6-W0078-02 |
| 115CET/ CETO/ TR/ TLR | 6N6-6N69 6N6A-6N6E | 1997-13 | REC6E5-44352-01 | REC6E5-44322-00 | REC6E5-44323-00-40 | REC6E5-44311-00 | REC93210-86M38 | REC6E5-44366-00 | REC90280-04M05 | REC6N6-W0078-02 |
| 115TXRZ | 6N60 | 2001 | REC6E5-44352-01 | REC6E5-44322-00 | REC6E5-44323-00-40 | REC6E5-44311-00 | REC93210-86M38 | REC6E5-44366-00 | REC90280-04M05 | REC6N6-W0078-02 |
| C115-115TLR | 6N6/6E5 | 1998-00 | REC6E5-44352-01 | REC6E5-44322-00 | REC6E5-44323-00-40 | REC6E5-44311-00 | REC93210-86M38 | REC6E5-44366-00 | REC90280-04M05 | REC6N6-W0078-02 |
| C115 | | 1991-92 | REC6E5-44352-01 | REC6E5-44322-00 | REC6E5-44323-00-40 | REC6E5-44311-00 | REC93210-86M38 | REC6E5-44366-00 | REC90280-04M05 | REC6N6-W0078-02 |
| C115 | | 1993-00 | REC6E5-44352-01 | REC61A-44322-02 | REC6E5-44323-00-40 | REC61A-44311-00 | REC93210-86M38 | REC6E5-44366-00 | REC90280-04M05 | REC6N6-W0078-02 |
| P115 | 62A | 1993-96 | REC6E5-44352-01 | REC61A-44322-02 | REC6E5-44323-00-40 | REC61A-44311-00 | REC93210-86M38 | REC6E5-44366-00 | REC90280-04M05 | REC6N6-W0078-02 |
| 115 | 6N6/6E5 | 1984-94 | REC6E5-44352-01 | REC61A-44322-02 | REC6E5-44323-00-40 | REC6E5-44311-00 | REC93210-86M38 | REC6E5-44366-00 | REC90280-04M05 | REC6N6-W0078-02 |
| 130 BETO | 6N7/ 6N70/ 6N77 | 1997-07 | REC6E5-44352-01 | REC61A-44322-02 | REC6E5-44323-00-40 | REC6E5-44311-00 | REC93210-86M38 | REC6E5-44366-00 | REC90280-04M05 | REC6N6-W0078-02 |
| 130TLR | 6N7 | 2000 | REC6E5-44352-01 | REC61A-44322-02 | REC6E5-44323-00-40 | REC6E5-44311-00 | REC93210-86M38 | REC6E5-44366-00 | REC90280-04M05 | REC6N6-W0078-02 |
| L130BETO | 6N4 | 1993-96 | REC6E5-44352-01 | REC61A-44322-02 | REC6E5-44323-00-40 | REC61A-44311-00 | REC6E5-44315-A0 | REC6E5-44366-00 | REC90280-04M05 | REC6N6-W0078-02 |

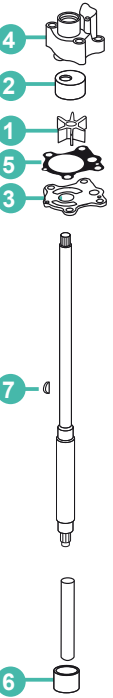



ÁNODO

ANODE



ANODI

ANODE

YAMAHA

| ZN | (KG) | AL | (KG) | OEM |
|---------|------|----------|-------|--------------|
| CM15026 | 0,01 | CM15026A | 0,005 | 6E5-11325-00 |

100 -225 hp





| ZN | (KG) | AL | (KG) | OEM |
|----------------|------|-----------------|-------|--------------|
| CM67C-45251-00 | 0,12 | CM67C-45251-00A | 0,047 | 67C-45251-00 |



| ZN | (KG) | OEM |
|----------------|------|--------------|
| CM6U4-45251-00 | 0,27 | 6U4-45251-00 |

Serie TD





| ZN | (KG) | AL | (KG) | OEM |
|-----------|------|-----------------|--------|--------------|
| CM3082523 | 0,03 | CM689-11325-00A | 0,0069 | 689-11325-00 |





| ZN | (KG) | AL | (KG) | OEM |
|----------------|------|-----------------|------|--------------|
| CM6G5-45251-01 | 0,91 | CM6G5-45251-01A | 0,37 | 6G5-45251-01 |

MALTA 2/4, 3.5 HP
2B/3, A/4, A/5C, 150/200 HP





| ZN | (KG) | AL | (KG) | OEM |
|----------------|------|-----------------|------|------------|
| CM6H1-45251-02 | 0,49 | CM6H1-45251-02A | 0,20 | 6H14525102 |

TOP 700





| ZN | (KG) | AL | (KG) | OEM |
|----------------|------|-----------------|------|--------------|
| CM68V-11325-01 | 0,07 | CM68V-11325-01A | 0,03 | 68V-11325-01 |



| ZN | (KG) | OEM |
|---------------|------|--------------|
| CM41106-ZW000 | 0,03 | 41106-ZW-000 |

2-25 HP



| ZN | (KG) | AL | (KG) | OEM |
|----------------|------|-----------------|------|--------------|
| CM68T-45251-00 | 0,10 | CM68T-45251-00A | 0,04 | 68T-45251-00 |



| ZN | (KG) | AL | (KG) | OEM |
|----------------|------|-----------------|------|--------------|
| CM688-45251-01 | 0,03 | CM688-45251-01A | 0,01 | 688-45251-01 |

Serie 2-115
60, 85, 115 HP



| ZN | (KG) | AL | (KG) | OEM |
|----------------|------|-----------------|------|--------------|
| CM6E5-45251-00 | 0,14 | CM6E5-45251-00A | 0,05 | 6E5-45251-00 |





| ZN | (KG) | AL | (KG) | OEM |
|----------------|------|-----------------|------|--------------|
| CM6H1-45251-01 | 0,56 | CM6H1-45251-01A | 0,23 | 6H1-45251-01 |



| ZN | (KG) | AL | (KG) | OEM |
|----------------|------|-----------------|------|-----------------|
| CM6E0-45251-11 | 0,10 | CM6E0-45251-11A | 0,04 | 6E0-45251-11-00 |

40 hp



| ZN | (KG) |
|----------|------|
| CM825171 | 0,29 |

30-50 hp



| ZN | (KG) | AL | (KG) | OEM |
|----------------|------|-----------------|------|--------------|
| CM62Y-11325-00 | 0,02 | CM62Y-11325-00A | 0,01 | 62Y-11325-00 |

40-200 hp

RECAMBIOS MARINOS

| ZN |  (KG) | OEM |
|----------------|--|--|
| CM6G1-45251-03 | 0,17 | 6G1-45251-03 6GH-45251-00 6N0-WG525-00 |

6C - 6D - 8C



| ZN |  (KG) | AL |  (KG) | OEM |
|---------|---|----------|--|--------------|
| CM15008 | 0,014 | CM15008A | 0,006 | 66M-11325-00 |

9.9hp



| ZN |  (KG) | OEM |
|---------|--|-----|
| CM42121 | 0,03 | |

6 - 9.9 hp



| ZN |  (KG) | OEM |
|----------------|---|--------------|
| CM6G1-45251-02 | 0,03 | 6G1-45251-02 |

6 - 8 hp



| ZN |  (KG) | OEM |
|----------------|--|--------------|
| CM6E8-45251-00 | 0,06 | 6E8-45251-00 |

9.9 hp



| ZN |  (KG) | OEM |
|----------------|---|--------------|
| CM6U0-45251-00 | 1,5 | 6U0-45251-00 |

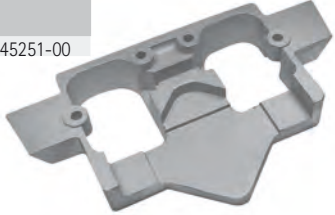

| ZN |  (KG) | OEM |
|----------------|--|--------------|
| CM6E8-45251-01 | 0,15 | 6E8-45251-02 |

9.9 - 15 hp



| ZN |  (KG) | OEM |
|----------------|--|--------------|
| CM6T4-45836-00 | 1,44 | 6T4-45836-00 |

V8



| ZN |  (KG) | OEM |
|----------------|--|--------------|
| CM6G8-45251-01 | 0,20 | 6G8-45251-00 |

9.9 hp



| ZN |  (KG) | OEM |
|----------------|---|--------------|
| CM6T5-45373-00 | 1,07 | 6T5-45373-00 |

130 - 260 hp



| ZN |  (KG) | OEM |
|----------------|--|--------------|
| CM66M-45371-00 | 0,08 | 66M-45371-00 |

9.9 hp - 4T





| ZN |  (KG) | OEM |
|----------------|---|--------------|
| CM67F-11325-00 | 0,06 | 67F-11325-00 |

80 - 100 hp





| ZN |  (KG) | OEM |
|----------------|---|--------------|
| CM63D-45251-01 | 0,54 | 63D-45251-01 |



| ZN |  (KG) | AL |  (KG) | OEM |
|----------------|--|-----------------|--|--------------|
| CM6L5-45251-02 | 0,06 | CM6L5-45251-02A | 0,03 | 6L5-45251-02 |

3,5 hp



| ZN |  (KG) | AL |  (KG) | OEM |
|----------------|---|-----------------|--|--------------|
| CM6G8-11325-00 | 0,02 | CM6G8-11325-00A | 0,004 | 6G8-11325-00 |

2.5 - 9.0 hp



| ZN | KG (KG) | OEM |
|----------------|---------|--------------|
| CM6E5-45371-10 | 0,23 | 6E5-45371-10 |

60 - 225 hp

| ZN | KG (KG) | AL | KG (KG) | OEM |
|----------|---------|-----------|---------|-----|
| CM82795M | 0,19 | CM82795MA | 0,07 | |

25, 30 hp

| ZN | KG (KG) | AL | KG (KG) | OEM |
|----------------|---------|-----------------|---------|--------------|
| CM67C-45371-00 | 0,21 | CM67C-45371-00A | 0,09 | 67C-45371-00 |

F25 - F40 - F50 - F60

| ZN | KG (KG) | AL | KG (KG) | OEM |
|----------------|---------|-----------------|---------|--------------|
| CM688-45371-02 | 0,48 | CM688-45371-02A | 0,19 | 688-45371-02 |

60 - 90 hp

| ZN | KG (KG) | AL | KG (KG) | OEM |
|---------|---------|----------|---------|--------------|
| CM85007 | 0,01 | CM85007A | 0,004 | 688-11325-00 |

25-90 hp

| ZN | KG (KG) | AL | KG (KG) | OEM |
|----------------|---------|-----------------|---------|--------------|
| CM679-45251-00 | 0,56 | CM679-45251-00A | 0,213 | 679-45251-00 |

55 hp

| ZN | KG (KG) | AL | KG (KG) | OEM |
|-------------|---------|-----------------|---------|--------------|
| CM61A-45371 | 0,63 | CM61A-45371-00A | 0,25 | 61A-45371-00 |

250 hp

| ZN | KG (KG) | AL | KG (KG) | OEM |
|----------------|---------|-----------------|---------|--------------|
| CM6J9-45371-01 | 0,50 | CM6J9-45371-01A | 0,20 | 6J9-45371-01 |

150, 200 hp

| ZN | KG (KG) | AL | KG (KG) | OEM |
|----------------|---------|-----------------|---------|--------------|
| CM61N-45251-01 | 0,26 | CM61N-45251-01A | 0,10 | 61N-45251-01 |

4T, 9.9, 15F, 25 hp

| ZN | KG (KG) | AL | KG (KG) | OEM |
|----------------|---------|-----------------|---------|--------------|
| CM6K1-45371-02 | 0,50 | CM6K1-45371-02A | 0,21 | 6J9-45371-02 |

150, 200 hp

CONTRAROTACIÓN
COUNTERROTATION
CONTROROTANTE
CONTRE ROTATION

| ZN | KG (KG) | AL | KG (KG) | OEM |
|----------------|---------|-----------------|---------|---------------|
| CM664-45371-01 | 0,28 | CM664-45371-01A | 0,11 | 664-45371-01A |

20, 25, 30 hp

| ZN | KG (KG) | AL | KG (KG) | OEM |
|----------------|---------|-----------------|---------|--------------|
| CM69L-45371-00 | 0,52 | CM69L-45371-00A | 0,21 | 69L-45371-00 |

| ZN |  (KG) | OEM |
|----------------|--|--------------|
| CM6T5-45371-00 | 0,52 | 6T5-45371-00 |



130 - 160 hp



| ZN |  (KG) | AL |  (KG) | OEM |
|----------------|--|-----------------|--|--------------|
| CM6AW-45373-00 | 1,09 | CM6AW-45373-00A | 0,42 | 6AW-45373-00 |

300 - 350 hp



| ZN |  (KG) | AL |  (KG) | OEM |
|-----------------|--|-----------------|--|--------------|
| REC6E5-45371-01 | 0,42 | CM6E5-45371-01A | 0,17 | 6E5-45371-01 |

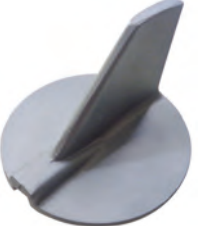

115 - 225 HP (V-4 - V6)



| ZN |  (KG) | AL |  (KG) | OEM |
|----------------|--|-----------------|--|--------------|
| CM6AW-45251-00 | 0,66 | CM6AW-45251-00A | 0,25 | 6AW-45251-00 |

200 - 350 hp





| ZN |  (KG) | AL |  (KG) | OEM |
|----------------|--|-----------------|--|--------------|
| CM6K1-45371-00 | 0,42 | CM6K1-45371-00A | 0,17 | 6K1-45371-00 |

115 - 225 HP (V-4 - V6)

CONTRAROTACIÓN
COUNTERROTATION
CONTROROTANTE
CONTRE ROTATION



| ZN |  (KG) | AL |  (KG) | OEM |
|----------------|--|-----------------|--|--------------|
| CM6AW-45619-00 | 0,27 | CM6AW-45619-00A | 0,103 | 6AW-45619-00 |

300 - 350 hp



| ZN |  (KG) | AL |  (KG) | OEM |
|----------------|--|-----------------|--|--------------|
| CM63P-11325-11 | 0,02 | CM63P-11325-11A | 0,008 | 63P-11325-11 |



150 - 300 hp



| ZN |  (KG) | AL |  (KG) | OEM |
|----------------|--|-----------------|--|--------------|
| CM6BL-11325-00 | 0,02 | CM6BL-11325-00A | 0,007 | 6BL-11325-00 |

BLOC
F20 / T,F25



| ZN |  (KG) | AL |  (KG) | OEM |
|----------------|--|-----------------|--|--------------|
| CM67F-11325-01 | 0,044 | CM67F-11325-01A | 0,017 | 67F-11325-01 |



75 - 350 hp



| ZN |  (KG) | OEM |
|----------------|--|--------------|
| CM61A-11325-00 | 0,02 | 61A-11325-00 |

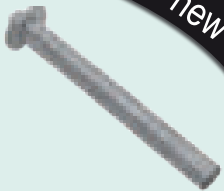

BLOC
V6



| ZN |  (KG) | AL |  (KG) | OEM |
|----------------|--|-----------------|--|--------------|
| CM67F-45371-00 | 0,407 | CM67F-45371-00A | 0,156 | 67F-45371-00 |



50 - 225 hp



| ZN |  (KG) | AL |  (KG) | OEM |
|----------------|--|-----------------|--|------------------------------|
| CM63P-11325-01 | 0,022 | CM63P-11325-01A | 0,008 | 63P-11325-00 63P-11325-01 |

F150 - F350 (2004+)



| ZN |  (KG) | AL |  (KG) | OEM |
|----------------|--|-----------------|--|--------------|
| CM68T-11325-00 | 0,011 | CM68T-11325-00A | 0,004 | 68T-11325-00 |

BLOC
6 - 300 hp



KITS DE ÁNODOS

ANODES KIT

KIT ANODI

KIT ANODES

| | |
|--------------|------------|
| AL | MG |
| CMY150KITA | CMY150KITM |
| 150 - 200 hp | |



new

| | |
|---------------|---------------|
| AL | MG |
| CMY200250KITA | CMY200250KITM |
| 200 - 250 hp | |



new

| | |
|---|--------------|
| AL | MG |
| CMY150CRKITA | CMY150CRKITM |
| 150, 200 hp | |
| CONTRAROTACIÓN COUNTERROTATION CONTROROTANTE CONTRE ROTATION | |



new

| | |
|-----------------|---------------|
| AL | MG |
| CMYHP200300KITA | CMY200300KITM |
| 200 - 300 hp | |



new

| | |
|---------------|---------------|
| AL | MG |
| CMY300350KITA | CMY300350KITM |
| 300 - 350 hp | |



new

| | |
|------------------|-------------|
| AL | MG |
| CMY4060KITA | CMY4060KITM |
| 4T 40 - 60 hp | |



new

| | |
|-----------------|-----------------|
| AL | MG |
| CMY300350XPKITA | CMY300350XPKITM |
| 300 - 350 hp | |



new

| | |
|-------------|-------------|
| AL | MG |
| CMY6090KITA | CMY6090KITM |
| 60 - 90 hp | |



new

| | |
|-------------|-------------|
| AL | MG |
| CMY4050KITA | CMY4050KITM |
| 40 - 50 hp | |



new

| | |
|--------------|--------------|
| AL | MG |
| CMY80100KITA | CMY80100KITM |
| 80 - 100 hp | |



new

ÁNODO

ANODE

ANODI

ANODE



| ZN | OEM | KG |
|----------|--------------|------|
| TEN01109 | 677-45251-00 | 0,02 |

2 - 25 hp

| ZN | OEM | KG |
|----------|------------------------------|------|
| TEN01132 | 67C-45251-00 63D-45251-10 | 0,12 |

T25, F30, F40, F50, F60, hp

| ZN | OEM | KG |
|----------|--------------|------|
| TEN01110 | 688-45251-01 | 0,04 |

60 - 85 - 115 hp

| ZN | OEM | KG |
|----------|--------------|------|
| TEN01142 | 68T-45251-00 | 0,10 |

F8C - 68T (2000) - 4T

| ZN | OEM | KG |
|----------|-----|-------|
| TEN01111 | | 0,210 |

Serie 2 - 115 hp
70 - 85 hp

| ZN | OEM | KG |
|----------|--------------|------|
| TEN01147 | 688-11325-00 | 0,01 |

25 - 90 hp

| ZN | OEM | KG |
|----------|-----------------|------|
| TEN01165 | 63P-11325-21-00 | 0,03 |

| ZN | OEM | KG |
|----------|--------------|------|
| TEN01152 | 6E5-11325-00 | 0,01 |

100 - 225 hp

| ZN | OEM | KG |
|----------|--------------|------|
| TEN01148 | 6G8-11325-00 | 0,01 |

2.5 - 9 hp

| ZN | OEM | KG |
|----------|--------------|------|
| TEN01146 | 67F-11325-00 | 0,07 |

80 - 100 hp

| ZN | OEM | KG |
|----------|--------------|------|
| TEN01149 | 62Y-11325-00 | 0,02 |

40- 200 hp

| ZN | OEM | KG |
|------------|--------------|------|
| TEN01146-1 | 67F-11325-01 | 0,05 |

80 - 100 hp

| ZN | OEM | KG |
|----------|--------------|------|
| TEN01150 | 6J8-11325-00 | 0,02 |

20- 25 hp

| ZN | OEM | KG |
|----------|--------------|------|
| TEN01151 | 66M-11325-00 | 0,01 |

9.9 hp

| ZN | OEM | KG |
|----------|--------------|------|
| TEN01168 | 61A-11325-00 | 0,02 |

| ZN | KG | AL | KG | OEM |
|----------|------|-----------|------|--------------|
| TEN01135 | 0,27 | TEN01135A | 0,11 | 61N-45251-01 |

4T - 9,9 - 15F - 25 hp

YAMAHA

RECAMBIOS MARINOS

| ZN | OEM | KG (kg) |
|----------|--------------|---------|
| TEN01137 | 6G8-45251-00 | 0,20 |

9.9 hp

| ZN | OEM | KG (kg) |
|----------|--------------|---------|
| TEN01118 | 6G1-45251-03 | 0,175 |

6C - 6D - 8C HP

| ZN | OEM | KG (kg) |
|----------|------------------------------|---------|
| TEN01138 | 6AV-45251-00 6V3-45251-01 | 0,28 |

TD

| ZN | OEM | KG (kg) |
|----------|--------------|---------|
| TEN01122 | 6T4-45836-00 | 1,49 |

V8

| ZN | KG (kg) | AL | KG (kg) | OEM |
|----------|---------|-----------|---------|---------------------------------|
| TEN01123 | 0,10 | TEN01123A | 0,04 | 6E0-45251-11-00 65W-45251-00 |

40 hp

| ZN | KG (kg) | AL | KG (kg) | OEM |
|----------|---------|-----------|---------|--------------|
| TEN01100 | 0,21 | TEN01100A | 0,08 | 664-45371-01 |

20 - 25 - 30 HP

| ZN | OEM | KG (kg) |
|----------|--------------|---------|
| TEN01105 | 6E5-45251-00 | 0,15 |

115 - 225 hp

| ZN | KG (kg) | AL | KG (kg) | OEM |
|----------|---------|-----------|---------|--------------|
| TEN01101 | 0,46 | TEN01101A | 0,17 | 679-45371-00 |

55 HP 10x1,25

| ZN | OEM | KG (kg) |
|----------|--------------|---------|
| TEN01106 | 6E8-45251-00 | 0,045 |

9.9 hp

| ZN | OEM | KG (kg) |
|----------|-----|---------|
| TEN01102 | | 0,62 |

55 HP 10x1,25

| ZN | OEM | KG (kg) |
|----------|--------------|---------|
| TEN01116 | 6E8-45251-02 | 0,14 |

9.9 - 15 hp

| ZN | KG (kg) | AL | KG (kg) | OEM |
|----------|---------|-----------|---------|--------------|
| TEN01103 | 0,39 | TEN01103A | 0,15 | 6L6-45371-00 |

115 - 225 HP
V4 - V6

| ZN | OEM | KG (kg) |
|----------|--------------|---------|
| TEN01136 | 66M-45371-00 | 0,09 |

9.9 4T hp

| ZN | KG (kg) | AL | KG (kg) | OEM |
|----------|---------|-----------|---------|--------------|
| TEN01104 | 0,43 | TEN01104A | 0,17 | 688-45371-02 |

60 - 90 hp

| ZN | OEM | KG (kg) |
|----------|--------------|---------|
| TEN01153 | 6E5-45371-00 | 0,337 |

60 - 225 hp

| ZN | KG (kg) | AL | KG (kg) | OEM |
|----------|---------|-----------|---------|--------------|
| TEN01104 | 0,43 | TEN01104A | 0,17 | 688-45371-02 |

60 - 90 hp

| ZN | OEM | KG (kg) |
|----------|--------------|---------|
| TEN01119 | 6T5-45371-00 | 0,58 |

130 - 205 - 230 - 260 hp

| ZN | OEM | KG (kg) |
|----------|------------------------------|---------|
| TEN01131 | 63D-45251-00 63D-45251-01 | 0,57 |

H.C. 48

| ZN | KG (kg) | AL | KG (kg) | OEM |
|----------|---------|------------|---------|--------------|
| TEN01124 | 0,68 | TEN01124AL | 0,27 | 61A-45371-00 |

250A hp

| ZN | KG (kg) | AL | KG (kg) | OEM |
|----------|---------|------------|---------|--------------|
| TEN01154 | 0,69 | TEN01154AL | 0,69 | 6AH-45251-00 |

| ZN | OEM | KG (kg) |
|----------|-----|---------|
| TEN01130 | | 0,27 |

25 - 30 hp

| ZN | OEM | KG (kg) |
|----------|--------------|---------|
| TEN01129 | 6E5-45251-00 | 0,24 |

75 HP - XR6

| ZN | KG (kg) | AL | KG (kg) | OEM |
|----------|------------|------------|---------|--------------|
| TEN01133 | DX220 0,63 | TEN01133AL | 0,26 | 6J9-45371-01 |
| TEN01134 | SX220 0,63 | | | 6K1-45371-02 |

150 - 200 HP

| ZN | OEM | KG (kg) |
|----------|--------------|---------|
| TEN01157 | 6U0-45251-00 | 1,50 |

TD

| ZN | OEM | KG (kg) |
|----------|--------------|---------|
| TEN01140 | 67F-45371-00 | 0,40 |

80 - 100 HP 4T

| ZN | OEM | KG (kg) |
|----------|-----|---------|
| TEN01107 | | 0,03 |

9.9 hp

| ZN | KG (kg) | AL | KG (kg) | OEM |
|----------|---------|------------|---------|--------------|
| TEN01141 | 0,22 | TEN01141AL | 0,09 | 67F-45371-00 |

F40 - F50 - F60 4T

| ZN | OEM | KG (kg) |
|----------|--------------|---------|
| TEN01108 | 6G1-45251-02 | 0,04 |

6 - 8 hp

| ZN | OEM | KG (kg) |
|----------|--------------|---------|
| TEN01143 | 6J9-45371-00 | 0,56 |

150 - 225 HP

| ZN | OEM | KG (kg) |
|----------|--------------|---------|
| TEN01169 | 6AW-45619-00 | 0,30 |

| ZN | (KG) | AL | (KG) | OEM |
|----------|------|------------|------|--------------|
| TEN01155 | 1,05 | TEN01155AL | 0,4 | 6AW-45373-00 |



| ZN | OEM | (KG) |
|------------|-----------|------|
| TEN01112-1 | 6AW-45251 | 0,65 |

200 - 350 hp

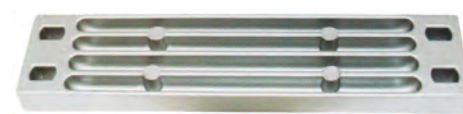

| ZN | OEM | (KG) |
|----------|--------------|------|
| TEN01158 | 6U4-45373-00 | 0,33 |



| ZN | OEM | (KG) |
|----------|--------------|------|
| TEN01162 | 682-11325-00 | 0,02 |



| ZN | OEM | (KG) |
|----------|--------------|------|
| TEN01117 | 6L5-45251-02 | 0,07 |

Malta 3,5 HP
+ 2B - 3A - 4A - 5C



| ZN | OEM | (KG) |
|----------|-----------------|------|
| TEN01164 | 63P-11325-11-00 | 0,02 |



| ZN | OEM | (KG) |
|----------|--------------|------|
| TEN01166 | 676-11325-00 | 0,03 |



| ZN | OEM | Ø (mm) | (KG) |
|----------|--------------|--------|------|
| TEN01127 | 676-45251-00 | 20 | 0,02 |
| TEN01128 | 682-45251-00 | 24 | 0,02 |



| ZN | OEM | (KG) |
|----------|-----------------|------|
| TEN01167 | 63P-11325-01-00 | 0,02 |



| ZN | OEM | (KG) |
|----------|--------------|------|
| TEN01161 | 6BL-11325-00 | 0,02 |



| ZN | (KG) | AL | (KG) | OEM |
|----------|------|------------|------|--------------|
| TEN01115 | 0,46 | TEN01115AL | 0,18 | 6H1-45251-02 |

TOP 700



| ZN | OEM | (KG) |
|----------|--------------|------|
| TEN01163 | 68T-11325-00 | 0,02 |



| ZN | OEM | (KG) |
|----------|--------------|------|
| TEN01125 | 6H1-45251-01 | 1,20 |

150 - 200 hp



| ZN | (KG) | AL | (KG) | OEM |
|----------|------|------------|------|------------------------------|
| TEN01112 | 0,90 | TEN01112AL | 0,36 | 6G5-45251-01 6G5-45251-02 |



| ZN | OEM | (KG) |
|----------|--------------|------|
| TEN01120 | 6T5-45373-00 | 0,77 |

130 - 205 - 230 - 260 hp



| ZN | OEM | (KG) |
|----------|--------------|------|
| TEN01113 | 6H1-45251-03 | 0,55 |

60 - 90 hp



| ZN | OEM | KG (kg) |
|----------|-----|------------|
| TEN01126 | | 0,29 |

30 - 40 hp



| ZN | OEM | KG (kg) |
|----------|--------------|------------|
| TEN01159 | 6U4-45251-00 | 0,60 |



| ZN | OEM | KG (kg) |
|----------|--------------|------------|
| TEN01121 | 689-11325-00 | 0,02 |

W30 - W8 25/2/3 hp



| ZN | OEM | KG (kg) |
|-----------|--------------|------------|
| TEN01160T | N51-11325-01 | 0,60 |



| ZN | KG (kg) | AL | KG (kg) | OEM |
|----------|------------|------------|------------|--------------|
| TEN01156 | 0,03 | TEN01156AL | 0,02 | 68V-11325-02 |



| ZN | KG (kg) | AL | KG (kg) | OEM |
|------------|------------|--------------|------------|--------------|
| TEN01156-1 | 0,07 | TEN01156/1AL | 0,03 | 68V-11325-01 |



| ZN | OEM | KG (kg) | Ø (mm) | (mm) | |
|----------|-----|------------|-----------|------|----|
| TEN01114 | | 0,09 | 20 | 39 | M8 |



| ZN | OEM | KG (kg) |
|----------|--------------|------------|
| TEN01139 | 6T5-45251-00 | 0,35 |



| ZN | OEM | KG (kg) | Ø (mm) | (mm) |
|----------|--------------|------------|-----------|------|
| TEN01170 | 6AW-1132S-00 | 0,035 | 14 | 40 |
| TEN01171 | 6AQ-1132N-00 | 0,030 | 14 | 38 |

300 - 350 hp

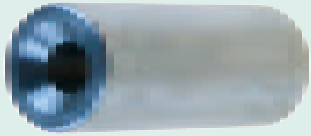

new

| ZN | OEM | KG (kg) | Ø (mm) | (mm) |
|----------|--------------|------------|-----------|------|
| TEN01172 | 6AW-1132R-00 | 0,022 | 16 | 20 |

300 - 350 hp



new

| ZN | OEM | KG (kg) | Ø (mm) | (mm) |
|----------|--------------|------------|-----------|------|
| TEN01173 | 6AW-1132L-00 | 0,026 | 19 | 15 |

300 - 350 hp



new

| ZN | OEM | KG (kg) |
|----------|--------------|------------|
| TEN01174 | 6AW-1132U-00 | 0,06 |

300 - 350 hp



new

| ZN | OEM | KG (kg) |
|----------|--------------|------------|
| TEN01175 | 6AW-1132T-00 | 0,06 |

300 - 350 hp



new

| ZN | OEM | KG (kg) |
|----------|--------------|------------|
| TEN01176 | 6AW-1132M-00 | 0,12 |

300 - 350 hp



new

| | | |
|----------|--------------|-------|
| ZN | OEM | (kg) |
| TEN01177 | 6AW-1132P-00 | 0,034 |

300 - 350 hp



new

| | | |
|----------|--------------|------|
| ZN | OEM | (kg) |
| TEN01145 | 69L-45371-00 | 0,66 |



| | | | | |
|----------|------|------------|------|--------------|
| ZN | (kg) | AL | (kg) | OEM |
| TEN01144 | 0,41 | TEN01144AL | | 6K1-45371-00 |



KITS DE ÁNODOS ANODES KIT KIT DE ANODI KIT ANODES

| |
|---------------------|
| ZN |
| TENKITYAMAHA150-200 |

150 - 200 hp



new

| |
|---------------------|
| ZN |
| TENKITYAMAHA200-300 |

200 - 300 hp



new

| |
|----------------------|
| ZN |
| TENKITYAMAHA150-200C |

150, 200 hp

CONTRAROTACIÓN
COUNTERROTATION
CONTROROTANTE
CONTRE ROTATION



new

| |
|-------------------|
| ZN |
| TENKITYAMAHA40-60 |

40 - 60 hp



new

| |
|---------------------|
| ZN |
| TENKITYAMAHA200-250 |

200 - 250 hp



new

| |
|-------------------|
| ZN |
| TENKITYAMAHA60-90 |

60 - 90 hp



new

TAPA DE ÁNODO (66M) COVER ANODE (66M) COPERCHIO ANODO (66M) COUVERCLE DU ANODE (66M)

| | |
|----------------|-----------------|
| REF | OEM |
| PAF15-07010011 | 66M-11327-00-94 |



new

GUÍA DE ÁNODOS

ANODES APPLICATION

GUIDA ANODI

GUIDE DES ANODES

| | TECNOSEAL | | CANADA METAL | |
|--|--------------|------------|--------------|---------------------------------|
| | OEM | ZN AL | ZN | AL |
| CILINDRO CYLINDER CILINDRO MOTEURS | | | | |
| F2.5A, 2B, 3A, F4A, 4A, 5C (1989+), F4B, F5A, F6C | 6L5-45251-03 | TEN01117 | | CM6L5-45251-02 CM6L5-45251-02A |
| 4A, 5C (-1989), F8A/B, F9.9A/B | 677-45251-00 | TEN01109 | | CM43107M |
| 4A, 5C, F8A/B/, 6C/D, 8C, F9.9A/B(1989+), 9.9D, 15/6C/D, 8C (1990+) | 6E0-45251-12 | TEN01123 | TEN01123AL | CM6E0-45251-11 CM6E0-45251-11A |
| 6C/D, 8C (-1989) | 6GH-45251-00 | TEN01118 | | CM6G1-45251-03 |
| F6A/B, F8C, F9.9F, F9.9J | 6N0-WG525-00 | TEN01108 | | CM6G1-45251-02 |
| F8A/B, 9.9D, F9.9B, 15D, F9.9A(-1994) | 68T-45251-00 | TEN01142 | | CM68T-45251-00 CM68T-45251-00A |
| F9.9A, FT9.9A (1994+) | 6E8-45251-02 | TEN01116 | | CM6E8-45251-01 |
| FT8, 9.9F, F9.9C, FT9.9D, FT9.9G, FT9.9L, 15F, F15A, F20A, F25A, 25B/V, F25D, 30G/H, 40V/X, F30A, F40A/B/C, F50A/F, 50H, FT25B/C (2000+) | 6G8-45251-01 | TEN01137 | | CM6G8-45251-01 |
| F15C, F20B | 61N-45251-01 | TEN01135 | TEN01135AL | CM61N-45251-01 CM61N-45251-01A |
| FT25F, F30B, F40F, F60A/C, FT60B, 40V/X, 50H, F40A, F50A/B(-1999), F50H, F60F | 6AH-45251-00 | TEN01154 | TEN01154AL | |
| F25G | 67C-45251-00 | TEN01132 | | CM67C-45251-00 |
| F50H, F60F, FT50J, FT60G | 6G8-45251-01 | TEN01148 | | CM6G8-11325-00 |
| F(L)300A, F(L)350A | 65W-45251-00 | TEN01123 | TEN01123AL | CM6E0-45251-11 CM6E0-45251-11A |
| | 6AW-45373-00 | TEN01155 | TEN01155AL | CM6AW-45373-00 CM6AW-45373-00A |
| TRIM | | | | |
| F9.9C, F15A | 66M-45371-00 | TEN01136 | | CM66M-45371-00 |
| 40Q, 50G, 55B, PRO50 | 679-45371-00 | TEN01101 | TEN01101AL | |
| 20C/D, 25D/N, 30A/D, 40H/V/X, 50D/H, F40A, F45A, F50A(-2000) | 664-45371-01 | TEN01100 | TEN01100AL | CM664-45371-01 CM664-45371-01A |
| FT25B/C, F30A, FT25F, F25G, F30B, F40F, F40A/B/C, F50A/F, F50H, F60A/C, F60F | 67C-45371-00 | TEN01141 | TEN01141AL | CM67C-45371-00 CM67C-45371-00A |
| 60F, 70B, 75A/C, PRO75, 80A, 85A, 90A, FT50B(-2000), FTC/G, FT50J, FT60B/D, FT60G, F70A, F80A/B, F100A/D | 67F-45371-00 | TEN01104 | TEN01104AL | CM688-45371-02 CM688-45371-02A |
| 100A, 115A/B/C, 130B, 140A/B, F100B/F, F115A/B, 150A, 175A, 200A, PROV100 | 6E5-45371-01 | TEN01103 | TEN01103AL | REC6E5-45371-01 CM6E5-45371-01A |
| 150A, 175A, 200A(1998+), 150C/F, 175B/D, 200B/F/G, 225A/B/D/F, PROV200, F150A, Z150P/Q, Z175G/H, Z200N, F200F, F(L)200G | 6J9-45371-01 | TEN01133 | TEN01133AL | CM6J9-45371-01 CM6J9-45371-01A |
| 150A, 175A, 200A | 6K1-45371-00 | TEN01144 | TEN01144AL | CM6K1-45371-00 CM6K1-45371-00A |
| LF150A, L150C/F, L200B/F, LZ150P, LZ200N | 6K1-45371-02 | TEN01134 | | CM6K1-45371-02 CM6K1-45371-02A |
| FL115A, FL115B, L130B, L140B | 6L6-45371-00 | TEN01103 | | REC6E5-45371-01 CM6E5-45371-01A |
| (L)225C/G, (L)250A/B, F(L)200A, F(L)200C, F(L)225A, F(L)225B, F(L)250A, F(L)250B, F(L)225F, F(L)250C, F(L)300B | 61A-45371-00 | TEN01124 | TEN01124AL | CM61A-45371 CM61A-45371-00A |
| Z200P, (L)Z250D/F, (L)Z300A | 69L-45371-00 | TEN01145 | | CM69L-45371-00 CM69L-45371-00A |
| BRACKET | | | | |
| FT8D, FT9.9D, F15A/C, F20A/B, F25A/G(PT model), FT25B, F30A, 30D, F40B/C, 40X/V, FT50C, 50H, F60A, FT60B, F70A | 65W-45251-00 | TEN01123 | TEN01123AL | CM6E0-45251-11 CM6E0-45251-11A |
| 25B/Q, 40H, 50D/G, 55B, 60F, 70B, 75A/C, 80A, 85A, 90A, F80A/B, F100A/D, F(L)115B, PRO50/75 (1990+) | 6H1-45251-03 | TEN01115 | TEN01115AL | CM6H1-45251-02 CM6H1-45251-02A |
| 40H, 50D, 60F, 70B, 80A, 90A(1989+) | 99999-03935 | TEN01113 | | CM6H1-45251-01 |
| 40H, 50D, 60F, 70B, 80A, 90A(-1989) | 688-45251-01 | TEN01110 | | CM688-45251-01 CM688-45251-01A |
| 25B, FT25B, F30A, 40V, F40A/B, F45A, FT50A/B, 50G/H, PRO50, 55B, 60F, 70B | 663-45251-00 | TEN01110 | | CM688-45251-01 CM688-45251-01A |
| 40V, F40A, F45A, 50H, F50A, FT50B | 63D-45251-01 | TEN01131 | | CM63D-45251-01 CM63D-45251-01A |
| 115A, 140A, 150A, 175A, 200A, 220A | 6E5-45251-00 | TEN01105 | | CM6E5-45251-00 CM6E5-45251-00A |
| 100A, 115B/C, F(L)115A, (L)130B, (L)140B | 6G5-45251-02 | TEN01112 | TEN01112AL | CM6G5-45251-01 CM6G5-45251-01A |
| PROV100, 150, 200, Vmax | 6AW-45251-00 | TEN01112-1 | | CM6AW-45251-00 CM6AW-45251-00A |
| (L)F150A, (L)150A/C/F, 175A/B/D/F | 6AW-45251-00 | TEN01112-1 | | CM6AW-45251-00 CM6AW-45251-00A |
| (L)200A/B/F/G, (L)225A/B/C/D/G, (L)250A/B | 6AW-45251-00 | TEN01112-1 | | CM6AW-45251-00 CM6AW-45251-00A |
| (L)Z150P/Q, Z175G/H/(L), Z200N/P | 6AW-45251-00 | TEN01112-1 | | CM6AW-45251-00 CM6AW-45251-00A |
| Z250D/F, F(L)200A, F200B, F(L)200C | 6AW-45251-00 | TEN01112-1 | | CM6AW-45251-00 CM6AW-45251-00A |
| F(L)225A, F(L)225B, F225C, F(L)250A | 6AW-45251-00 | TEN01112-1 | | CM6AW-45251-00 CM6AW-45251-00A |
| F(L)250B, (L)Z300A, F(L)300A, F(L)350A | 6AW-45251-00 | TEN01112-1 | | CM6AW-45251-00 CM6AW-45251-00A |
| F(L)225F, F(L)250D, F(L)300B | 6AW-45251-00 | TEN01112-1 | | CM6AW-45251-00 CM6AW-45251-00A |
| F(L)200F, F(L)200G | 6AW-45251-00 | TEN01112-1 | | CM6AW-45251-00 CM6AW-45251-00A |
| F300A, F350A (V8) | | | | |
| TAPA TERMOSTATO THERMOSTAT COVER | 6AW-1132R-00 | TEN01172 | | |
| COPERCHIO TERMOSTATO COUVERCLE DU THERMOSTAT | | | | |
| PARA REGULADOR FOR REGULATOR PER REGOLATORE POUR REGULATEUR | 6E5-11325-00 | TEN01152 | | CM15026 CM15026A |
| BLOQUE BLOCK BLOCCO MOTEUR | 6AW-1132P-00 | TEN01177 | | |
| BLOQUE BLOCK BLOCCO BLOQUE | 63P-11325-01 | TEN01167 | | CM63P-11325-01 |
| TAPA ESCAPE EXHAUST COVER COPERCHIO SCARICO PLAQUE D'ECHAPPEMENT | 6AW-1132M-00 | TEN01176 | | |
| ESCAPE EXHAUST SCARICO ECHAPPEMENT | 99999-03946 | TEN01171 | | |
| ESCAPE EXHAUST SCARICO ECHAPPEMENT | 6AW-1132L-00 | TEN01173 | | |
| PLACA ESCAPE EXHAUST PLATE PIASTRA SCARICO PLAQUE D'ECHAPPEMENT | 6AW-1132T-00 | TEN01175 | | |
| PLACA ESCAPE EXHAUST PLATE PIASTRA SCARICO PLAQUE D'ECHAPPEMENT | 6AW-1132S-00 | TEN01170 | | |
| ANODO PLACA ESCAPE | 63P-11325-11 | TEN01164 | | CM63P-11325-11 |
| COLAS (DIESEL) STERN DRIVE (DIESEL) PIEDI (DIESEL) EMBASE (DIESEL) | | | | |
| Intermedio Intermediate Intermedio Intermediaire - ME422 | 6U0-45251-00 | TEN01157 | | CM6U0-45251-00 |
| TRP Drive (Trasero Rear Posteriore Arrière) - ME422 | 6U4-45251-00 | TEN01159 | | CM6U4-45251-00 |
| TRP Drive (Frontal Front Anteriore Avant) - ME422 | 6U4-45373-00 | TEN01158 | | |

PARTES DEL MOTOR ENGINE PARTS

PARTI MOTORE PIECES MOTEUR

DESPIECE MOTOR
DE 4 TIEMPOS

ENGINE PARTS
4 STROKES

PARTI MOTORI
4 TEMPI

PIECES MOTEURS
DE 4 TEMPS

4T F2.5 AMH/MLH/MSH/MHA (2003+)
STROKES

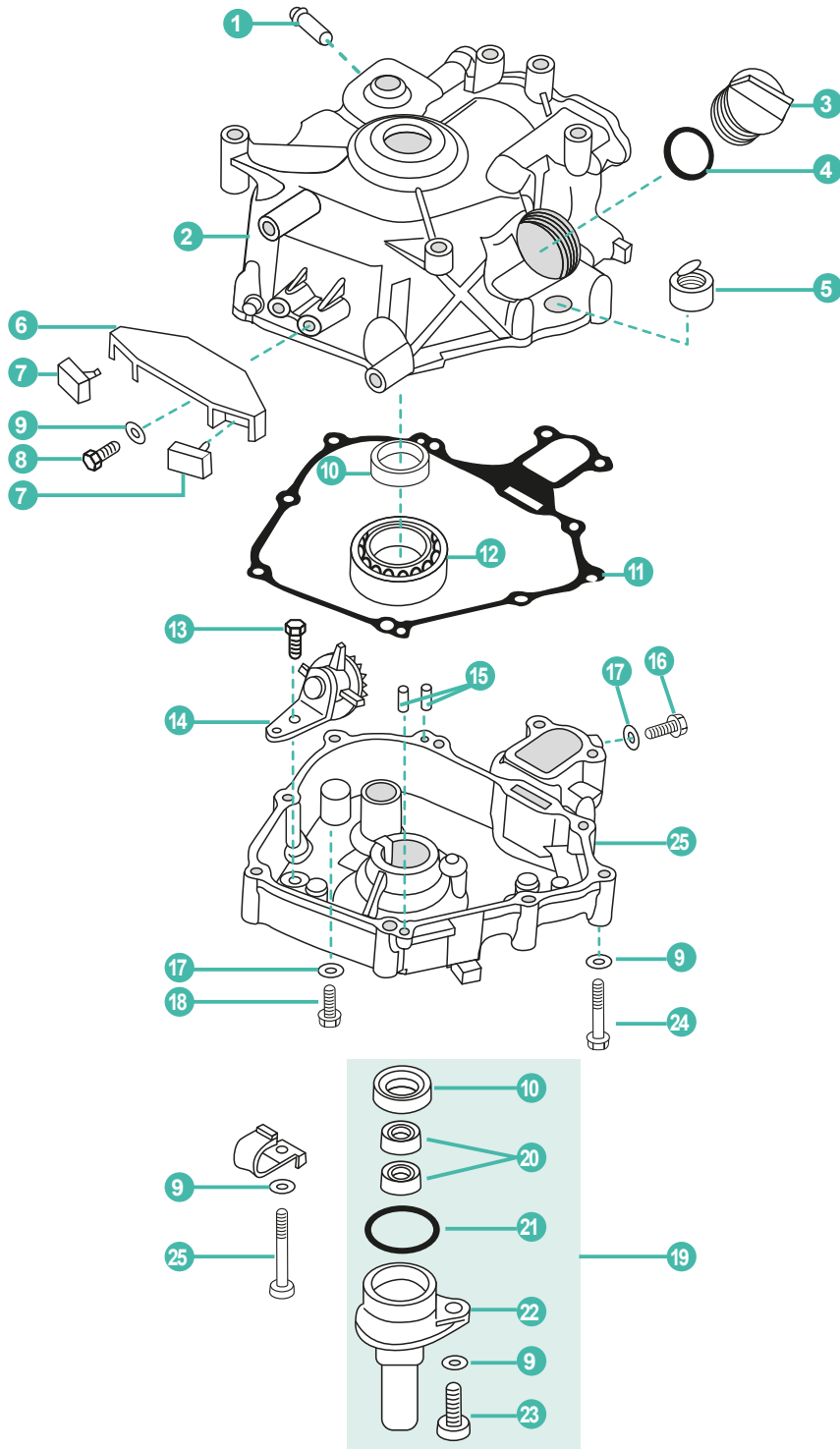

YAMAHA

RECAMBIOS
MARINOS

| | REF | OEM | | | | | UN. |
|----|--------------------|-----------------|--------------------------|---------------------------|------------------------------|----------------------------------|-----|
| 1 | PAT15-04010202 | 6H1-14485-00 | PIPA DE AGUA | PIPE, WATER | TUBO | RACCORD TUYAU D'EAU | 1 |
| 2 | PAF2.6-04010100 | 69M-E1311-00-1 | CARCASA MOTOR | CRANK CASE | COPERCHIO MOTORE | VILEBREQUIN | 1 |
| 3 | PAF15-07050004 | 69M-E5363-00 | TAPÓN ACEITE | PLUG, OIL | TAPPO OLIO | BOUCHON REMPLISSAGE D'HUILE | 1 |
| 4 | PAJASOF40431-025 | 93210-24M79 | ARO TÓRICO | O-RING | O-RING | JOINT TORIQUE | 1 |
| 5 | PAF2.6-04010102 | 69M-15361-00 | INDICADOR NIVEL | GAUGE, LEVEL | INDICATORE LIVELLO | JAUGE DE NIVEAU | 1 |
| 6 | PAF2.6-04000008 | 69M-G2743-00 | SOPORTE MOTOR | BRACKET, DAMPER | SUPPORTO MOTORE | SUPPORT | 1 |
| 7 | PAF2.6-04000009 | 6G8-44532-00 | GOMA SOPORTE | RUBBER BLOCK, DAMPER | GOMMA SUPPORTO | SILENT BLOC | 2 |
| 8 | PAGB/T5783-M6X20 | 97095-06020 | TORNILLO | SCREW | VITE | VIS | 2 |
| 9 | PAGB/T97.1-6 | 92995-06600 | ARANDELA | WASHER | RONDELLA | RONDELLE | 11 |
| 10 | PAF2.6-04010001 | 93102-20108 | RETÉN | OIL SEAL | PARAOLIO | JOINT | 2 |
| 11 | PAF2.6-04000004 | 69M-11351-A0 | JUNTA CÁRTER | CRANK CASE COMPLEX GASKET | GUARNIZIONE COPPA L'OLLIO | JOINT DE CARTER | 1 |
| 12 | PAGB/T276-62/22/P6 | 93306-272Y2 | RODAMIENTO | BALL BEARING | CUSCINETTO | ROULEMENT À BILLE | 1 |
| 13 | PAGB/T5783-M6X12 | 95817-06012 | TORNILLO | SCREW | VITE | VIS | 1 |
| 14 | PAF2.6-04050100 | 69M-E3102-00 | PIÑÓN | GEAR UNIT ASSY | PIGNONE | PIGNON | 1 |
| 15 | PAF15-00000013 | 93604-12M07 | PIN | PIN | SPINOTTO | GOUPILLE FENDUE | 2 |
| 16 | PAGB/T5783-M8X14 | 97095-08014 | TORNILLO | SCREW | VITE | VIS | 1 |
| 17 | PAF4-04000006 | 90201-08818-00 | ARANDELA | WASHER | RONDELLA | RONDELLE | 2 |
| 18 | PAF4-04000001 | 90105-08M76 | TORNILLO DRENAJE | BOLT, DISCHARGING OIL | VITE DRENAGGIO | VIS DE VIDANGE | 1 |
| 19 | PAF2.6-04060000 | 69M-E5396-00-5B | RETÉN Y CUERPO, COMPLETO | OIL SEAL SHELL ASSY | GUARNIZIONE E CORPO COMPLETO | LOGEMENT JOINT D'HUILE, COMPLÈTE | 1 |
| 20 | PAF2.6-04060002 | 93210-09004 | RETÉN | OIL SEAL | PARAOLIO | JOINT | 2 |
| 21 | PAF4-04060002 | 93210-35537 | ARO TÓRICO | O RING | O-RING | JOINT TORIQUE | 1 |
| 22 | PAF2.6-04060001 | 69M-E5396-00 | CUERPO DEL RETÉN | SHELL, OIL SEAL | GUARNIZIONE CORPO | LOGEMENT JOINT D'HUILE | 1 |
| 23 | PAGB/T5783-M5X12 | 90465-08M99 | TORNILLO | SCREW | VITE | VIS | 1 |
| 24 | PAGB/T5783-M5X12 | 97013-06045 | TORNILLO | SCREW | VITE | VIS | 8 |
| 25 | PAF2.6-04050001 | 69M-E5111-00-1S | CARTER | CRANKCASE COVER | CARTER | CARTER | 1 |



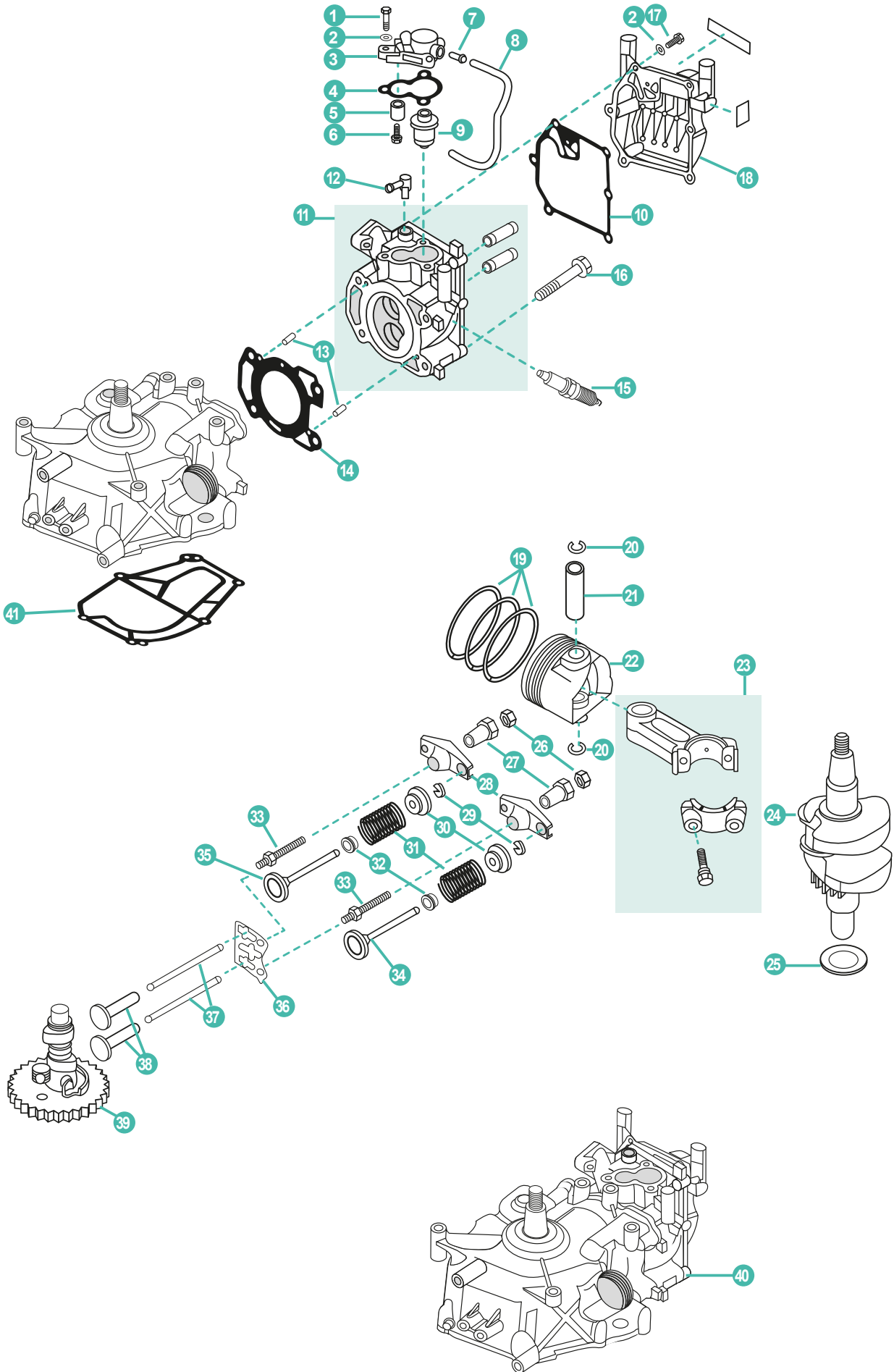

| | REF | OEM | | | | UN. | |
|----|------------------|------------------|-----------------------|--------------------------|----------------------------------|-------------------------------|---|
| 1 | PAGB/T5783-M6X20 | 97095-06020 | TORNILLO | SCREW | VITE | VIS | 3 |
| 2 | PAGB/T97.1-6 | 92995-06600 | ARANDELA | WASHER | RONDELLA | RONDELLE | 9 |
| 3 | PAF2.6-04000501 | 69M-E2413-00-1S | TAPA TERMOSTATO | COVER, THERMOSTAT | COPERCHIO TERMOSTATO | COUVERCLE THERMOSTAT | 1 |
| 4 | PAF4-04000011 | 68D-E2414-A0 | JUNTA TAPA TERMOSTATO | GASKET, THERMOSTAT COVER | GUARNIZIONE COPERCHIO TERMOSTATO | JOINT COUVERCLE DE THERMOSTAT | 1 |
| 5 | PAF4-04070003 | 68D-E1325-00 | ÁNODO | ANODE | ANODO | ANODE | 1 |
| 6 | PAGB/T818-M5X25 | 97880-05025 | TORNILLO | SCREW | VITE | VIS | 1 |
| 7 | PAF4-04010102 | 650-24378-00 | PIPA | PIPE, JOINT | TUBO | RACCORD TUYAU D'EAU | 1 |
| 8 | PAF2.6-04000007 | 90445-09808 | TUBO DE AGUA | WATER TUBE | TUBO DELL'ACQUA | DURITE D'EAU | 1 |
| 9 | REC6AH-12411-00 | 69M-12411-01 | TERMOSTATO | THERMOSTAT | TERMOSTATO | THERMOSTAT | 1 |
| 10 | PAF2.6-04000005 | 69M-11193-A0 | JUNTA TAPA BALANCINES | GASKET, CYLINDER COVER | GUARNIZIONE COPERCHIO PUNTERIE | JOINT DE CACHE CULBUTEUR | 1 |
| 11 | PAF2.6-04040100 | 69M-E1111-00-1S | CULATA COMPLETA | CYLINDER HEAD ASSY | TESTATA COMPLETA | CULASSE COMPLETE | 1 |
| 12 | PAF15-04000005 | 676-11372-00 | NIPLE | NIPPLE | TUBO | RACCORD D'EAU | 1 |
| 13 | PAF15-00000013 | 93604-12M07 | PIN | PIN, DOWEL | SPINOTTO | GOUPILLE FENDUE | 2 |
| 14 | PAF2.6-04000001 | 69M-11181-00 | JUNTA CULATA | GASKET, CYLINDER HEAD | GUARNIZIONE TESTATA | JOINT DE CULASSE | 1 |
| 15 | NGKBR6HS | 94702-00248 | BUJÍA F2.5A | SPARK PLUG F2.5A | CANDELA F2.5A | BOUGIE F2.5A | 1 |
| | NGKCR6HSB | 94702-00372 | BUJÍA F2.5B | SPARK PLUG F2.5B | CANDELA F2.5B | BOUGIE F2.5B | 1 |
| 16 | PAF4-04000034 | 90105-08M36 | TORNILLO | SCREW | VITE | VIS | 4 |
| 17 | PAGB/T5783-M6X16 | 90105-06039 | TORNILLO | SCREW | VITE | VIS | 6 |
| 18 | PAF2.6-04000006 | 69M-E1191-00-1S | TAPA BALANCINES | COVER, CYLINDER HEAD | COPERCHIO PUNTERIE | CACHE CULBUTEUR | 1 |
| 19 | REC69M-E1603-01 | 69M-E1603-01 | KIT SEGMENTOS | PISTON RING KIT | KIT FASCIA | KIT DE SEGMENTS | 1 |
| 20 | PAF2.6-04020006 | 93450-13130 | CIRCLIP | CIRCLIP | CIRCLIP | CIRCLIP | 2 |
| 21 | PAF2.6-04020005 | 69M-E1633-00 | PIN, PISTÓN | PIN, PISTON | SPINOTTO PISTONE | AXE DE PISTON | 1 |
| 22 | PAF2.6-04020001 | 69M-E1631-01-96 | PISTÓN | PISTON | PISTONE | PISTON | 1 |
| 23 | PAF2.6-04020100 | 69M-11650-00 | BIELA | ROD, CONNECTING | BIELLA | BIELLE | 1 |
| 24 | PAF2.6-04030000 | 69M-11400-00 | CIGÜEÑAL | CRANK ASSY | ALBERO MOTORE | VILEBREQUIN | 1 |
| 25 | PAF2.6-04000003 | 90201-23008 | ARANDELA | WASHER | RONDELLA | RONDELLE | 1 |
| 26 | PA166F-010011 | 7FK-12158-00 | TUERCA | LOCK NUT | DADO | ÉCROU | 2 |
| 27 | PA166F-010010 | 7FK-12165-00 | TUERCA BALANCÍN | PIVOT, ROCKER ARM | DADO BILANCERE | PIVOT CULBUTEUR | 2 |
| 28 | PA166F-010009 | 67D-12151-00 | BALANCÍN | ARM, VALVE ROCKER | BILANCERE | CULBUTEUR | 2 |
| 29 | PAF8-05030007 | 7NJ-12118-00 | SEGURO DE VÁLVULA | CLAMP, VALVE | BLOCCAGGIO DI VALVOLA | CLAVETTE DE SOUPAPE | 2 |
| 30 | PAF8-05030006 | 7NJ-12117-00 | RETÉN DE RESORTE | SPRING, VALVE RETAINER | VALVOLA DI RITEGNO | JOINT DE RESSORT | 2 |
| 31 | PAF4-04080008 | 68D-E2113-00 | MUELLE DE VÁLVULA | SPRING, VALVE STEM | MOLLA DI VALVOLA | RESSORT DE SOUPAPE | 2 |
| 32 | PA166F-010003 | 51Y-12119-00 | RETÉN DE VÁLVULA | SEAT, VALVE STEM | TENUTA | JOINT QUEUE DE SOUPAPE | 2 |
| 33 | PA166F-010008 | 67D-12157-00 | TORNILLO BALANCÍN | BOLT, ROCKER ARM | VITE PUNTERIE | VIS DE BRAS A BASCULE | 2 |
| 34 | PA166F-010001 | 67D-12111-00 | VÁLVULA ADMISIÓN | VALVE, INTAKE | VALVOLA ASPIRAZIONE | SOUPAPE D ADMISSION | 1 |
| 35 | PA166F-010002 | 67D-12121-00 | VÁLVULA ESCAPE | VALVE, EXHAUST | VALVOLA SCARICO | SOUPAPE D'ÉCHAPPEMENT | 1 |
| 36 | PAF2.6-04040001 | 69M-E2155-00 | PLETINA EMPUJADORES | PLATE, PUSH ROD | PIASTRA, ASTA DI SPINTA | PLAQUE DE POUSSOIRS | 1 |
| 37 | PAF2.6-04000002 | 69M-12154-00 | VARILLA EMPUJADOR | ROD, VALVE PUSH | ASTICELLA DI SPINTA | TIGE DE CULBUTEUR | 2 |
| 38 | PA166F-000001 | JA9-12153-00 | EMPUJADOR | LIFTER, VALVE | ASTA | POUSSOIR | 2 |
| 39 | PAF2.6-04000100 | 69M-12170-01 | ÁRBOL DE LEVAS | CAMSHAFT ASSY | ALBERO A CAMME | ARBRE À CAMES | 1 |
| 40 | POWERHEAD2.6 | 69M-WE0090-01-1S | MOTOR | POWER HEAD | MOTORE | TÊTE MOTRICE | 1 |
| 41 | PAF2.6-00000003 | 69M-45113-A0 | JUNTA BASE MOTOR | GASKET ENGINE | GUARNIZIONE BASE MOTORE | JOINT MOTEUR | 1 |

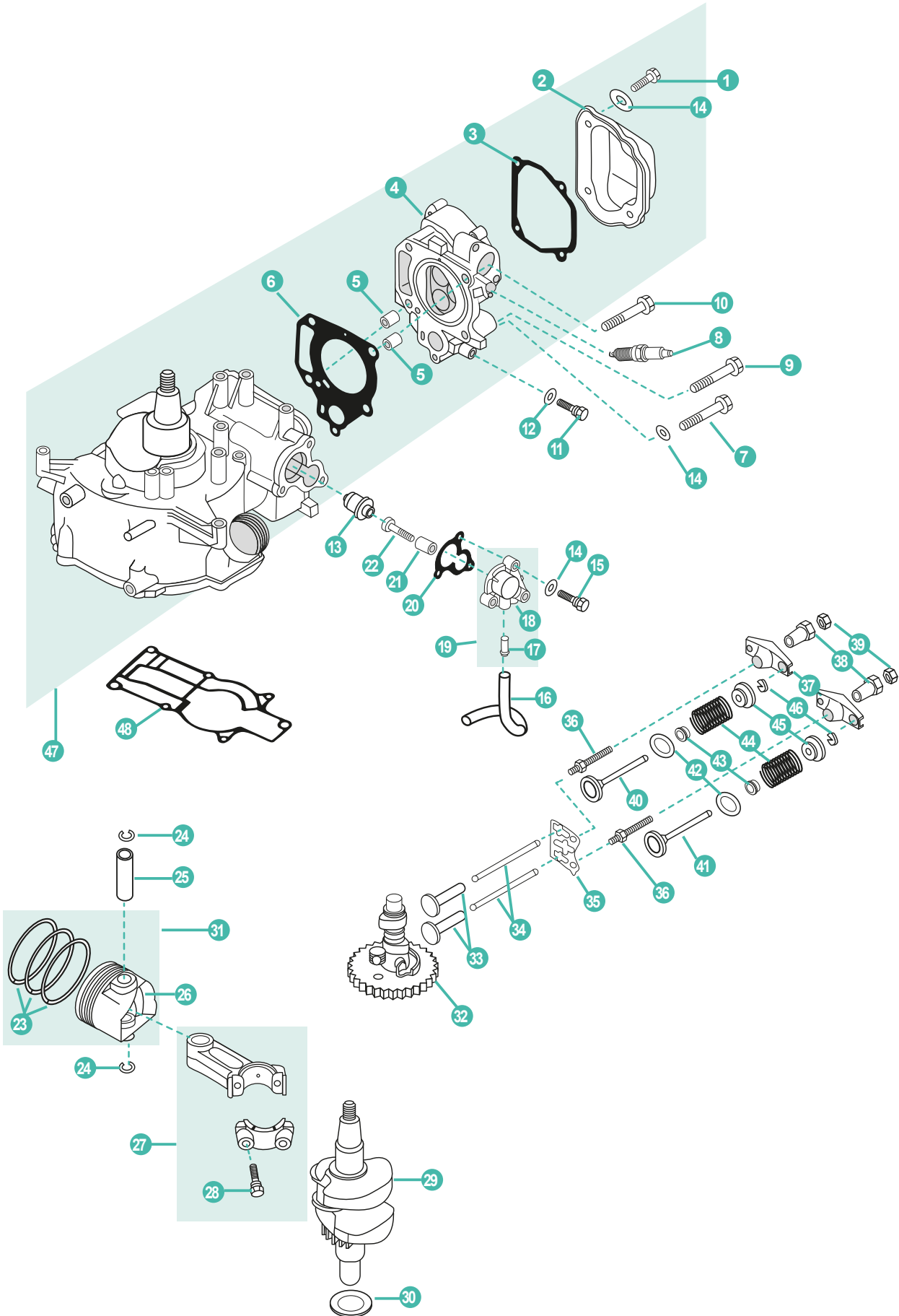

| | REF | OEM | | | | UN. | |
|----|------------------|-----------------|------------------------------|----------------------------|----------------------------------|---------------------------------|---|
| 1 | PAGB/T5783-M6X16 | 90105-06M14 | TORNILLO | SCREW | VITE | VIS | 4 |
| 2 | PAF4-04000018 | 67D-11191-00 | TAPA BALANCINES | COVER, CYLINDER HEAD | COPERCHIO PUNTERIE | CACHE CULBUTEUR | 1 |
| 3 | PAF4-04000017 | 68D-E1193-A0 | JUNTA TAPA | GASKET, COVER | GAURNIZIONE COPERCHIO | JOINT COUVERCLE | 1 |
| 4 | PAF4-04080101 | 68D-E1111-10-1S | CULATA | CYLINDER, HEAD | TESTATA | CULASSE | 1 |
| 5 | PAF4-04000003 | 99510-10114 | PIN | PIN, HOLLOW | SPINOTTO | GOUPILLE FENDUE | 2 |
| 6 | PAF4-04000014 | 67D-11181-A0 | JUNTA CULATA | GASKET, CYLINDER HEAD | GUARNIZIONE TESTATA | JOINT DE CULASSE | 1 |
| 7 | PAGB/T5782-M6X45 | 90105-06M25 | TORNILLO | SCREW | VITE | VIS | 1 |
| 8 | NGKBPR7HS | 94702-00248 | BUJÍA | SPARK PLUG | CANDELA | BOUGIE | 1 |
| 9 | PAF4-04000034 | 90105-08M36-00 | TORNILLO | SCREW | VITE | VIS | 3 |
| 10 | PAF4-04000033 | 90105-08046-00 | TORNILLO | SCREW | VITE | VIS | 1 |
| 11 | PAGB/T5783-M8X14 | 97095-08014-00 | TORNILLO | SCREW | VITE | VIS | 1 |
| 12 | PAF4-04000006 | 90430-08800-00 | ARANDELA | WASHER, PLATE | RONDELLA | RONDELLE | 1 |
| 13 | REC6AH-12411-00 | 69M-12411-01 | TERMOSTATO | TEHRMOSTAT | TERMOSTATO | THERMOSTAT | 1 |
| 14 | PAGB/T97.1-6 | 92995-06600 | ARANDELA | WASHER, PLATE | RONDELLA | RONDELLE | 8 |
| 15 | PAGB/T5783-M6X20 | 97095-06020-00 | TORNILLO | SCREW | VITE | VIS | 3 |
| 16 | PAF4-04000012 | 90445-09807 | TUBO | PIPE, RETURN | TUBO | DURITE D'EAU | 1 |
| 17 | PAF4-04010102 | 650-24378-00 | PIPA DE AGUA | PIPE, WATER | TUBO | RACCORD TUYAU D'EAU | 1 |
| 18 | PAF4-04070001 | 67D-12413-00-1S | TAPA TERMOSTATO | COVER, THERMOSTAT | COPERCHIO TERMOSTATO | COUVERCLE THERMOSTAT | 1 |
| 19 | PAF4-04070100 | 68D-E2413-001S | TAPA TERMOSTATO COMPLETA | COVER ADN SPLIE WATER ASSY | TAPPO TERMOSTATO COMPLETO | COUVERCLE DE THERMOSTAT COMPLET | 1 |
| 20 | PAF4-04000011 | 68D-E2414-A0 | JUNTA TAPA TERMOSTATO | GASKET, THERMOSTAT | GUARNIZIONE COPERCHIO TERMOSTATO | JOINT COUVERCLE DE THERMOSTAT | 1 |
| 21 | PAF4-04070003 | 68D-E1325-00 | ÁNODO | ANODE | ANODO | ANODE | 1 |
| 22 | PAGB/T818-M5X25 | 97880-05025-00 | TORNILLO | SCREW, PANHEAD | VITE | BOULON | 1 |
| 23 | REC68D-E1603-00 | 68D-E1603-00 | KIT SEGMENTOS DE PISTÓN | PISTON RING KIT | KIT FASCIA PISTONE | KIT DE SEGMENTS | 1 |
| 24 | PAF4-04020006 | 93450-14088 | CIRCLIP | CIRCLIP | CIRCLIP | CIRCLIP | 2 |
| 25 | PAF4-04020005 | 68D-E1633-00 | PIN, PISTÓN | PIN, PISTON | SPINOTTO PISTONE | AXE DE PISTON | 1 |
| 26 | PAF4-04020001 | 68D-E1631-00-96 | PISTÓN | PISTON | PISTONE | PISTON | 1 |
| 27 | PAF4-04020100 | 67D-11650-00 | BIELA | ROD, CONNECTING | BIELLA | BIELLE | 1 |
| 28 | PAF4-04020103 | 67D-11654-00 | TORNILLO | SCREW | VITE | VIS | 2 |
| 29 | PAF4-04030000 | 67D-11400-00 | CIGÜEÑAL | CRANK ASSY | ALBERO MOTORE | VILEBREQUIN | 1 |
| 30 | PAF4-04000004 | 90201-266P2 | ARANDELA | WASHER, PLATE | RONDELLA | RONDELLE | 1 |
| 31 | PAF4-04020200 | 68D-E1631-00-96 | PISTÓN | PISTON ASSY | PISTONE | PISTON | 1 |
| 32 | PAF4-04040000 | 68D-E2170-00 | ÁRBOL DE LEVAS | CAMSHAFT ASSY | ALBERO A CAMME | ARBRE À CAMES | 1 |
| 33 | PA166F-000001 | JA9-12153-00 | EMPUJADOR DE VÁLVULA | LIFTER, VALVE PUSH | ALZA VALVOLA | POUSSOIR | 2 |
| 34 | PAF4-04000015 | 67D-12154-00 | VARILLA EMPUJADOR DE VÁLVULA | ROD, VALVE PUSH | ASTA, ALZA VALVOLA | TIGE DE CULBUTEUR | 2 |
| 35 | PAF4-04080009 | 68D-E2155-00 | PLETINA EMPUJADORES | PLATE, PUSH ROD | PIASTRA, ASTA DI SPINTA | PLAQUE DE POUSSOIRS | 1 |
| 36 | PA166F-010008 | 67D-12157-00 | TORNILLO | SCREW | VITE | VIS | 2 |
| 37 | PA166F-010009 | 67D-12151-00 | BALANCIÓN | VALVE ROCKER | BILANCERE | CULBUTEUR | 2 |
| 38 | PA166F-010010 | 7FK-12165-00 | TUERCA BALANCIÓN | PIVOT, ROCKER ARM | DADO BILANCERE | ECROU DU CULBUTEUR | 2 |
| 39 | PA166F-010011 | 7FK-12158-00 | TUERCA | LOCKNUT | DADO | ECROU | 1 |
| 40 | PAF4-04080005 | 67D-12111-00 | VÁLVULA ADMISIÓN | VALVE, INTAKE | VALVOLA ASPIRAZIONE | SOUPAPE D ADMISSION | 1 |
| 41 | PAF4-04080006 | 67D-12121-00 | VÁLVULA ESCAPE | VALVE, EXHAUST | VALVOLA SCARICO | SOUPAPE D'ECHAPPEMENT | 1 |
| 42 | PAF4-04080007 | 68T-12116-00 | ARANDELA ASIENTO | SEAT, VALVE SPRING | RONDELLA BASAMENTO | SIEGE RESSORT DE SOUPAPE | 2 |
| 43 | PAPS2700.04.03 | 51Y-12119-00 | RETÉN DE VÁLVULA | SEAT, VALVE STEM | GOMMINO VALVOLA | JOINT QUEUE DE SOUPAPE | 2 |
| 44 | PAF4-04080008 | 68D-E2113-00 | MUELLE | SPRING, VALVE INNER | MOLLA | RESSORT DE SOUPAPE | 2 |
| 45 | PAF8-05030006 | 7NJ-12117-00 | RETÉN RESORTE | SPRING, VALVE RETAINER | VALVOLA DI RITEGNO | JOINT DE RESSORT | 2 |
| 46 | PAF8-05030007 | 7NJ-12118-00 | SEGURO DE VÁLVULA | CLAMP, VALVE | BLOCCAGGIO DI VALVOLA | CLAVETTE DE SOUPAPE | 2 |
| 47 | PAF4-04000000 | 680-WE090-11-15 | MOTOR | POWER HEAD 4-5 | MOTORE | TÊTE MOTRICE | 1 |
| 48 | PAF4-00000006 | 67D-45113-A0 | JUNTA BASE MOTOR | GASKET ENGINE | GUARNIZIONE BASE MOTORE | JOINT MOTEUR | 1 |

4T F4A/MSHAC/AMH/MLHB-S/MH/MLHE (2002-09)

STROKES

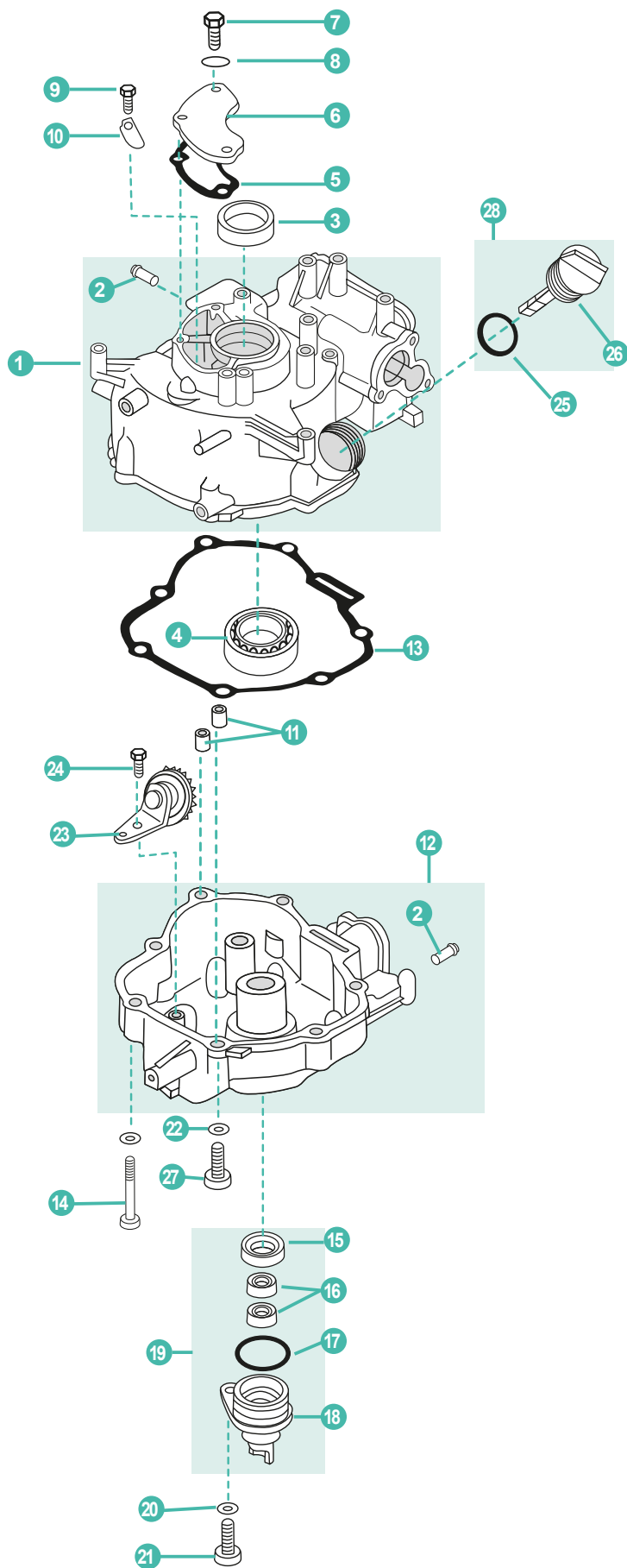

| | REF | OEM | | | | UN. | |
|----|------------------|-----------------|-----------------------|-----------------------|----------------------------|---------------------------------|---|
| 1 | PAF4-04010100 | 68D-E1311-02-15 | CARCASA DE MOTOR | CRANK CASE | COPERCHIO MOTORE | VILEBREQVIN | 1 |
| 2 | PAF4-04010102 | 650-24378-00 | PIPA DE AGUA | PIPE, WATER | TUBO | RACCORD TUYAU D'EAU | 2 |
| 3 | PAF4-04010004 | 93102-25090 | RETÉN | OIL SEAL | PARAOLIO | JOINT | 1 |
| 4 | PAGB/T276-6004C2 | 93306-205YD | RODAMIENTO | BALL BEARING | CUSCINETTO | ROULEMENT À BILLE | 1 |
| 5 | PAF4-04000009 | 68D-E1169-A0 | JUNTA | BREATHER GASKET | GUARNIZIONE | JOINT | 1 |
| 6 | PAF4-04000010 | 68D-E1168-00 | TAPA | COVER | COPERCHIO | COUVERCLE | 1 |
| 7 | PAGB/T5783-M6X14 | 90119-06M80-00 | TORNILLO | SCREW | VITE | VIS | 3 |
| 8 | PAGB/T97.1-6 | 92885-06600 | ARANDELA | WASHER | RONDELLA | RONDELLE | 3 |
| 9 | PAGB/T818-M4X6 | 98503-04066-00 | TORNILLO | SCREW | VITE | VIS | 1 |
| 10 | PAF4-04010003 | 68D-E5346-00 | VÁLVULA | VALVE | VALVOLA | SOUPAPE | 1 |
| 11 | PAF4-04000003 | 99510-10114 | PIN | HOLLOWPIN | SPINOTTO | GOUPILLE FENDUE | 2 |
| 12 | PAF4-04050200 | 68D-E5111-00-1S | CARTER | COVER, CRANK CASE | CARTER | CARTER | 1 |
| 13 | PAF4-04000002 | 68D-11351-A0 | JUNTA CARTER | CRANK CASE COMPLEX | GUARNIZIONE CARTER | JOINT DE CARTER | 1 |
| 14 | PAGB/T5787-1986 | 97575-08550-00 | TORNILLO | SCREW | VITE | VIS | 7 |
| 15 | PAF2.6-04010001 | 93102-20108 | RETÉN | OIL SEAL | PARAOLIO | JOINT | 1 |
| 16 | PAF4-04060004 | 93102-10004 | RETÉN | OIL SEAL | PARAOLIO | JOINT | 2 |
| 17 | PAF4-04060002 | 93210-35537 | TÓRICA | O-RING | O-RING | JOINT TORIQUE | 1 |
| 18 | PAF4-04060001 | 68D-E5396-00-5B | CUERPO DEL RETÉN | SHELL, OIL SEAL | GUARNIZIONE CORPO | LOGEMENT JOINT D'HUILE | 1 |
| 19 | PAF4-04060000 | 6EE-E5396-00-CA | CUERPO RETÉN COMPLETO | OIL SEAL, SHELL ASSY | CORPO GUARNIZIONE COMPLETO | LOGEMENT JOINT D'HUILE, COMPLET | 1 |
| 20 | PAGB/T97.1-8 | 92955-08600-00 | ARANDELA | WASHER, PLATE | RONDELLA | RONDELLE | 8 |
| 21 | PAGB/T5783-M8X20 | 97095-08020-00 | TORNILLO | BOLT, HEXAGON | VITE | BOULON | 1 |
| 22 | PAF4-04000006 | 90201-08818 | ARANDELA | WASHER | RONDELLA | RONDELLE | 1 |
| 23 | PAF4-04050100 | 68D-E3102-00 | PIÑÓN COMPELTO | GEAR UNIT ASSY | PIGNONE | PIGNON | 1 |
| 24 | PAGB/T5783-M6X12 | 95817-06012-00 | TORNILLO | SCREW | VITE | VIS | 1 |
| 25 | PAF4-04000008 | 93210-24M79 | TÓRICA | O-RING | O-RING | JOINT TORIQUE | 1 |
| 26 | PAF4-04000007 | 68D-E5362-00 | TAPÓN MEDIDOR NIVEL | PLUG WITH DIPSTICK | TAPPO LIVELLO | BOUCHON AVEC JAUGE D'HUILE | 1 |
| 27 | PAF4-04000001 | 97095-08020-00 | TORNILLO DRENAJE | BOLT, DISCHARGING OIL | VITE DRENAGGIO | VIS DE VIDANGE | 1 |
| 28 | PAF4-04000036 | 6EE-E5362-00 | TAPÓN COMPLETO | PLUG ASSY | TAPPO COMPLETO | BOUCHON COMPLET | 1 |



4T F4B-M • F5A • F6C-M
STROKES



REC10W30U3
REC10W30U6
REC10W40U3
REC10W40U6

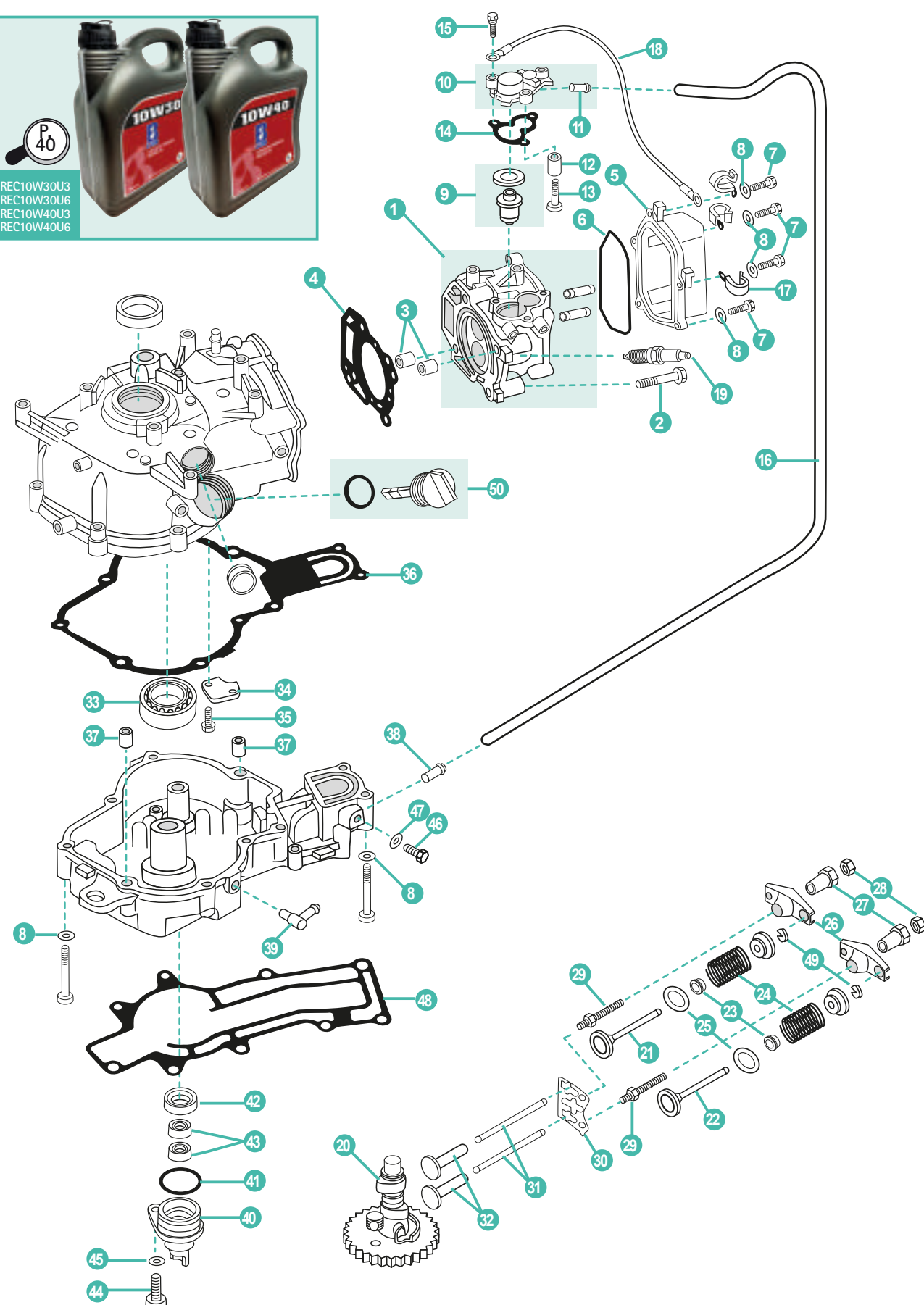

YAMAHA

RECAMBIOS
MARINOS

| | REF | OEM | | | | | UN. |
|----|----------------------|-----------------|-------------------------|--------------------------|----------------------------------|-------------------------------|-----|
| 1 | PAF6-04050100 | 6BX-E1111-00-1S | CULATA COMPLETA | CYLINDER HEAD ASSY | TESTATA COMPLETA | CULASSE COMPLETE | 1 |
| 2 | PAF4-04000034 | 90105-08M36 | TORNILLO | SCREW | VITE | VIS | 4 |
| 3 | PAF4-04000003 | 99510-10114 | PIN CENTRADOR | HOLLOW PIN | SPINOTTO DI CENTRAGGIO | PIN DE CENTRAGE | 2 |
| 4 | PAF6-04000002 | 6BX-11181-00 | JUNTA CULATA | GASKET, CYLINDER HEAD | GUARNIZIONE TESTATA | JOINT DE CULASSE | 1 |
| 5 | PAF6-04000004 | 6BX-E1191-00-5B | TAPA CULATA DE CILINDRO | COVER CYLINDER HEAD | COPERCHIO TESTA CILINDRO | CACHE CULBUTEUR | 1 |
| 6 | PAF6-04000005 | 6BX-11356-00 | RETÉN DE ACEITE | SEAL RING | PARAOLIO | JOINT CACHE CULBUTEUR | 1 |
| 7 | PAGB/T5783-M6X20 | 97095-06020 | TORNILLO | SCREW | VITE | VIS | 5 |
| 8 | PAGB/T97.1-6 | 92995-06600 | ARANDELA | WASHER | RONDELLA | RONDELLE | 15 |
| 9 | PAF15-07000031 | 66M-12411-01 | TERMOSTATO | THERMOSTAT | TERMOSTATO | THERMOSTAT | 1 |
| 10 | PAF4-04070000 | 68D-E2413-00-1S | TAPA TERMOSTATO | COVER, THERMOSTAT | COPERCHIO TERMOSTATO | COUVERCLE THERMOSTAT | 1 |
| 11 | PAF4-04010102 | 650-24378-00 | NIPLE | NIPPLE | RACCORDO | RACCORD | 1 |
| 12 | PAF4-04070003 | 68D-E1325-00 | ÁNODO | ANODE | ANODO | ANODE | 1 |
| 13 | PAGB/T818-M5X25 | 97880-05025 | TORNILLO | SCREW | VITE | VIS | 1 |
| 14 | PAF4-04000011 | 68D-E2414-A0 | JUNTA TAPA TERMOSTATO | GASKET, THERMOSTAT COVER | GUARNIZIONE COPERCHIO TERMOSTATO | JOINT COUVERCLE DE THERMOSTAT | 1 |
| 15 | PAGB/T5783-M6X20 | 90119-06MA2 | TORNILLO | SCREW | VITE | VIS | 3 |
| 16 | PAF6-04000020 | 6BX-F4323-00 | TUBO | TUBE | TUBO | DURITE D'EAU | 1 |
| 17 | PAT36-04000023 | 90465-06M86 | BRIDA | CLAMP | FLANGIA | COLLIER | 1 |
| 18 | PAF6-04000009 | 6G0-82519-00 | CABLE MASA | WIRE LEAD | PORTA CAVO | CABLE | 1 |
| 19 | NGKCR6HSB | 94702-00372 | BUJÍA | SPARK PLUG | CANDELA | BOUGIE | 1 |
| 20 | PAF6-04030000 | 6BX-E2170-00 | ÁRBOL DE LEVAS | CAMSHAFT ASSY | ALBERO A CAMME | ARBRE À CAMES | 1 |
| 21 | PAF6-04050001 | 6BX-12111-00 | VÁLVULA ADMISIÓN | VALVE, INTAKE | VALVOLA ASPIRAZIONE | SOUPEPE D ADMISSION | 1 |
| 22 | PAF6-04050002 | 6AU-12121-00 | VÁLVULA ESCAPE | VALVE, EXHAUST | VALVOLA SCARICO | SOUPEPE D'ÉCHAPPEMENT | 1 |
| 23 | PAF166-010003 | 51Y-12119-00 | RETÉN DE ACEITE | SEAL RING | PARAOLIO | JOINT D'HUILE | 2 |
| 24 | PAF6-04050003 | 60R-12113-00 | RESORTE DE VÁLVULA | SPRING, VALVE | MOLLA VALVOLA | RESSORT | 2 |
| 25 | PAF4-04080007 | 68T-12116-00 | RETÉN RESORTE | SPRING, VALVE RETAINER | VALVOLA DI RITEGNO | JOINT DE RESSORT | 2 |
| 26 | PA166F-010009 | 67D-12151-00 | BRAZO DE BALANCÍN | ARM, VALVE ROCKER | BILANCERE | CULBUTEUR | 2 |
| 27 | PA166F-010010 | 7FK-12165-00 | TUERCA BALANCÍN | PIVOT, ROCKER ARM | DADO BILANCERE | PIVOT CULBUTEUR | 2 |
| 28 | PA166F-010011 | 7FK-12158-00 | TUERCA | LOCK NUT | DADO | ÉCROU | 2 |
| 29 | PA166F-010008 | 67D-12157-00 | PERNO | BOLT | PERNO | BOULON | 2 |
| 30 | PAF6-04050004 | 6BX-E2155-00 | PLETINA EMPUJADORES | PLATE, PUSH ROD | PIASTRA, ASTA DI SPINTA | PLAQUE DE POUSSOIRS | 1 |
| 31 | PAF6-04000003 | 6BX-12154-00 | VARILLA EMPUJADOR | ROD, VALVE PUSH | ASTICELLA DI SPINTA | TIGE DE CULBUTEUR | 2 |
| 32 | PA166F-000001 | JA9-12153-00 | EMPUJADOR DE VÁLVULA | LIFTER, VALVE PUSH | ALZA VALVOLA | POUSSOIR | 2 |
| 33 | PANTN6205C3 | 93306-205B2 | RODAMIENTO | BALL BEARING | CUSCINETTO | ROULEMENT À BILLE | 1 |
| 34 | PAF6-04010004 | 6BX-E1168-00 | CUBIERTA DE RESPIRADERO | OIL BAFFLE PLATE | DIAFRAMMA OLIO | JOINT DE CARTER D'HUILE | 1 |
| 35 | PAGB/T5783-M5X10 | 97013-05010 | PERNO | BOLT | PERNO | BOULON | 2 |
| 36 | PAF6-04000001 | 6BX-11351-00 | JUNTA BASE MOTOR | GASKET ENGINE | GUARNIZIONE BASE MOTORE | JOINT MOTEUR | 1 |
| 37 | PAF4-04000003 | 99510-10114 | PIN CENTRADOR | HOLLOW PIN | SPINOTTO DI CENTRAGGIO | PIN DE CENTRAGE | 2 |
| 38 | PAF4-04010102 | 650-24378-00 | PIPA DE AGUA | PIPE, WATER | TUBO | RACCORD TUYAU D'EAU | 1 |
| 39 | PAF15-04000005 | 676-11372-00 | NIPLE DE MANGUERA | WATER NIPPLE | RACCORDO COMPLETO | RACCORD D'EAU | 1 |
| 40 | PAF4-04060001 | 68D-E5396-00-5B | CAJA DE SELLO DE ACEITE | SHELL, OIL SEAL | GUARNIZIONE CORPO OLIO | LOGEMENT JOINT D'HUILE | 1 |
| 41 | PAGB/T345.2-D32.5XD1 | 93210-35537 | TÓRICA | O-RING | O-RING | JOINT TORIQUE | 1 |
| 42 | PAF2.6-04010001 | 93102-20108 | RETÉN DE ACEITE | SEAL RING | PARAOLIO | JOINT SPI | 1 |
| 43 | PAF4-04060004 | 93102-10004 | RETÉN DE ACEITE | SEAL RING | PARAOLIO | JOINT SPI | 2 |
| 44 | PAGB/T5783-M8X20 | 97095-08020 | PERNO | BOLT | PERNO | BOULON | 1 |
| 45 | PAGB/T97.1-8 | 92995-08600 | ARANDELA | WASHER | RONDELLA | RONDELLE | 1 |
| 46 | PAGB/T5783-M8X14 | 97095-08014 | PERNO | BOLT | PERNO | BOULON | 1 |
| 47 | PAF4-04000006 | 90430-08800 | JUNTA | GASKET | GUARNIZIONE | JOINT | 1 |
| 48 | PAF6-00000001 | 6BX-45113-00 | JUNTA | GASKET | GUARNIZIONE | JOINT | 1 |
| 49 | PAF8-05030007 | 7NJ-12118-00 | CLIP | CLIP | CLIP | CLIP | 1 |
| 50 | PAF4-04000010 | 68D-E5362-00 | TAPÓN COMPLETO | PLUG ASSY | TAPPO COMPLETO | BOUCHON COMPLET | 1 |

4T F6A/M/B • FT/T/F8C/M/D/P/E/F • F9.9F • FT9.9G • F9.9J • FT9.9L
STROKES

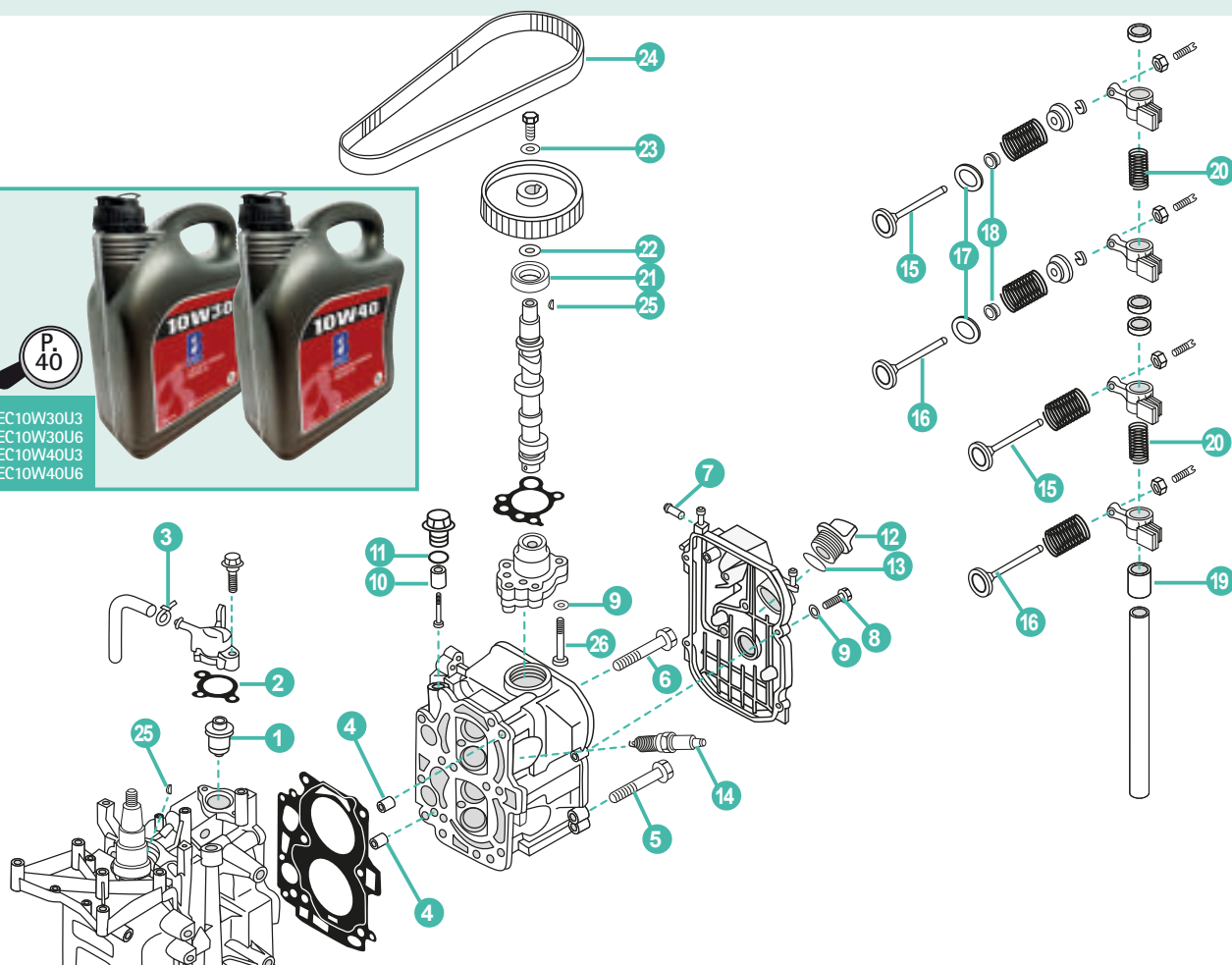

| | REF | OEM | | | | UN. | |
|----|-------------------|--------------|-----------------------|--------------------|------------------------|-----------------------------|---|
| 1 | PAF15-07000031 | 66M-12411-01 | TERMOSTATO | THERMOSTAT | TERMOSTATO | THERMOSTAT | 1 |
| 2 | REC6G8-12414-A0 | 60R-E2414-A0 | JUNTA | GASKET | GUANIZIONE | JOINT | 1 |
| 3 | PAHT-2.5X60 | 90465-11M10 | BRIDA | CLAMP | FLANGIA | COLLIER | 1 |
| 4 | PAF15-07000001 | 99510-10114 | PIN CENTRADOR | HOLLOW PIN | SPINOTTO DI CENTRAGGIO | PIN DE CENTRAGE | 2 |
| 5 | PAF4-04000034 | 90105-08M36 | TORNILLO | SCREW | VITE | VIS | 2 |
| 6 | PAF15-07000028 | 90105-08M78 | TORNILLO | SCREW | VITE | VIS | 4 |
| 7 | PAF4-04010102 | 650-24378-00 | PIPA DE AGUA | PIPE, WATER | TUBO | RACCORD TUYAU D'EAU | 1 |
| 8 | PAGB/T5783-M6X20 | 97095-06020 | TORNILLO | BOLT | VITE | BOULON | 4 |
| 9 | PAGB/T97.1-6 | 92995-06600 | ARANDELA | WASHER | RONDELLA | RONDELLE | 7 |
| 10 | CM6G8-11325-00A | 6G8-11325-00 | ÁNODO | ANODE | ANODO | ANODE | 1 |
| 11 | PAGB/T3452.1-13X2 | 93210-13M63 | TÓRICA | O-RING | O-RING | JOINT TORIQUE | 1 |
| 12 | PAF15-07050004 | 69M-E5363-00 | TAPÓN ACEITE | PLUG, OIL | TAPPO OLIO | BOUCHON REMPLISSAGE D'HUILE | 1 |
| 13 | PAF4-04000008 | 93210-24M79 | TÓRICA | O-RING | O-RING | JOINT TORIQUE | 1 |
| 14 | NGKBR6HS-10 | 94702-00274 | BUJÍA | SPARK PLUG | CANDELA | BOUGIE | 2 |
| 15 | PA166F-010001 | 67D-12111-00 | VÁLVULA ADMISIÓN | VALVE, INTAKE | VALVOLA ASPIRAZIONE | SOUPAPE D ADMISSION | 2 |
| 16 | PAF4-04080006 | 67D-12121-00 | VÁLVULA ESCAPE | VALVE, EXHAUST | VALVOLA SCARICO | SOUPAPE D'ECHAPPEMENT | 2 |
| 17 | PAF4-04080007 | 68T-12116-00 | ARANDELA DE ASIENTO | SEAT, VALVE SPRING | RONDELLA BASAMENTO | SIEGE RESSORT DE SOUPAPE | 2 |
| 18 | PA166F-010003 | 51Y-12119-00 | RETÉN DE ACEITE | SEAL RING | PARAOLIO | JOINT D'HUILE | 4 |
| 19 | PAF15-07040012 | 90387-13M56 | CASQUILLO | BUSHER | BOCCOLA | BAGUE | 1 |
| 20 | PAF15-07040014 | 90501-12M40 | RESORTE DE COMPRESIÓN | SPRING, ROCKER | MOLLA | RESSORT ROCKER | 2 |
| 21 | PAF15-07040008 | 93102-18M21 | RETÉN DE ACEITE | SEAL RING | PARAOLIO | JOINT D'HUILE | 1 |
| 22 | PAF15-07040017 | 90201-13201 | ARANDELA | WASHER | RONDELLA | RONDELLE | 1 |
| 23 | PAGB/T5287-6 | 90201-06M94 | ARANDELA | WASHER | RONDELLA | RONDELLE | 1 |
| 24 | REC68T-46241-00 | 60R-G6241-00 | CORREA | BELT | CINGHIA | COURROIE DISTRIBUTION | 1 |
| 25 | PAGB/T1099-3X5X13 | 90280-03M01 | CHAVETA | KEY WOODRUFF | CHIAVETTA | CLAVETTE | 2 |
| 26 | PAGB/T5783-M6X30 | 97095-06030 | PERNO | BOLT | VITE | BOULON | 3 |

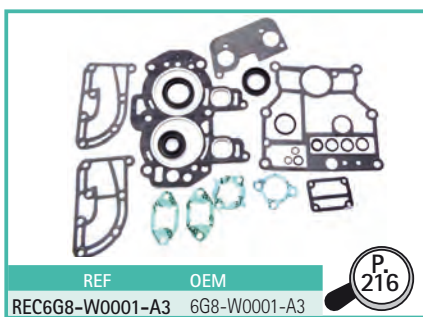
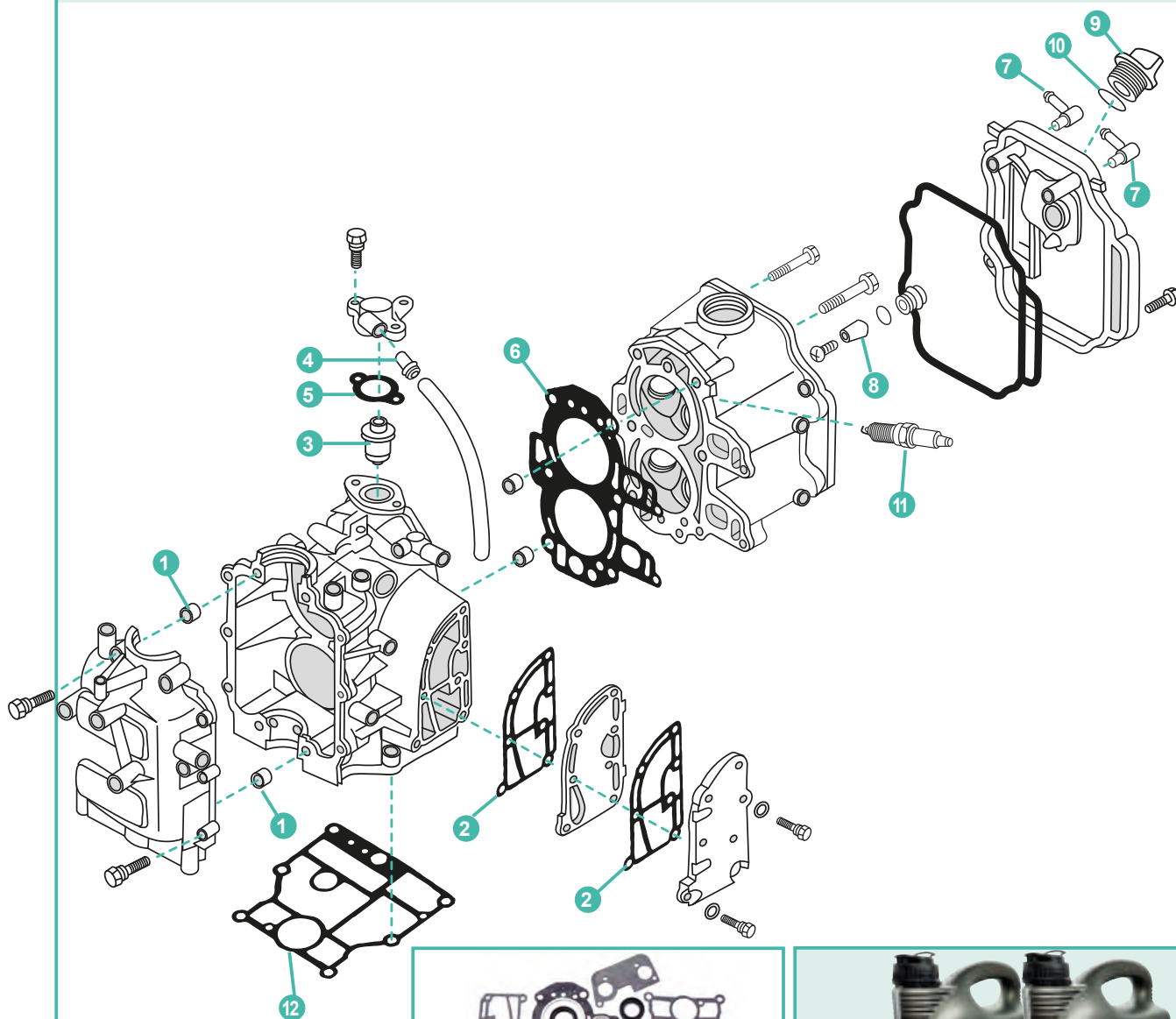

| REF | OEM |
|-----------------|--------------|
| REC6G8-W0001-A3 | 6G8-W0001-A3 |



| |
|------------|
| REC10W30U3 |
| REC10W30U6 |
| REC10W40U3 |
| REC10W40U6 |

| | REF | OEM | | | | | UN. |
|----|------------------|--------------|-----------------------|--------------------------|----------------------------------|-------------------------------|-----|
| 1 | PAF15-07000001 | 91810-03014 | PIN | PIN | PIN | PIN | 2 |
| 2 | REC6G8-41112-02 | 6G8-41112-02 | JUNTA | GASKET | GUARNIZIONE | JOINT | 2 |
| 3 | REC6AH-12411-00 | 6G8-12411-00 | TERMOSTATO | THERMOSTAT | TERMOSTATO | THERMOSTAT | 1 |
| 4 | PAF15-07010006 | 6E5-24377-00 | PIPA DE AGUA | PIPE, WATER | TUBO | RACCORD TUYAU D'EAU | 1 |
| 5 | REC6G8-12414-A0 | 6G8-12414-00 | JUNTA TAPA TERMOSTATO | GASKET, THERMOSTAT COVER | GUARNIZIONE COPERCHIO TERMOSTATO | JOINT COUVERCLE DE THERMOSTAT | 1 |
| 6 | REC6G8-11181-A1 | 6G8-11181-00 | JUNTA CULATA | GASKET, CYLINDER HEAD | GUARNIZIONE TESTATA | JOINT DE CULASSE | 1 |
| 7 | PAF15-04000005 | 676-11372-00 | NIPLA | HOSE NIPLA | TUBO | TUYAU | 2 |
| 8 | CM6G8-11325-00 | 6G8-11325-00 | ÁNODO | ANODE | ANODO | ANODE | 1 |
| 9 | PAF15-07050004 | 6G8-15363-00 | TAPÓN ACEITE | PLUG, OIL | TAPPO OLIO | BOUCHON REMPLISSAGE D'HUILE | 1 |
| 10 | PAJASOF40431-025 | 93210-24M79 | TÓRICA | O-RING | O-RING | JOINT TORIQUE | 1 |
| 11 | NGKCR6HS | 94701-00282 | BUJÍA | SPARK PLUG | CANDELA | BOUGIE | 2 |
| 12 | REC6G8-11351-A0 | 6G8-11351-00 | JUNTA BASE MOTOR | GASKET ENGINE | GUARNIZIONE BASE MOTOR | JOINT MOTEUR | 1 |

4T F9.9 (2004-06) • F9.9C • F13.5 (2003-06) • F15 (2003-07) • F15A

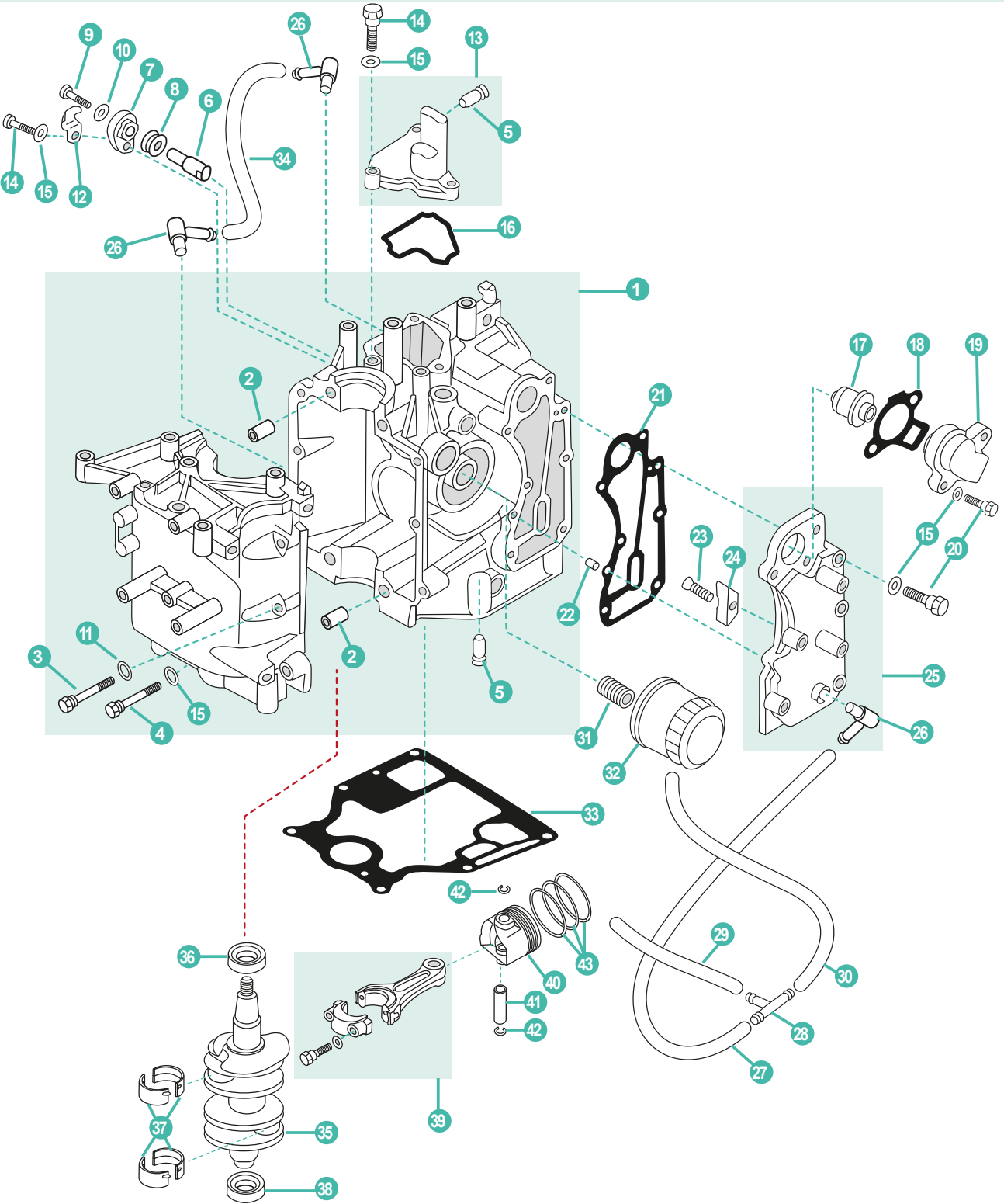

| REF | OEM |
|-----------------|--------------|
| REC66M-W0093-01 | 66M-W0093-01 |

P. 95

| REF | OEM |
|-----------------|--------------|
| REC66M-W0001-01 | 66M-W0001-01 |

P. 216

P. 40

REC10W30U3
REC10W30U6
REC10W40U3
REC10W40U6

| | REF | OEM | | | | UN. | |
|----|------------------|-----------------|-------------------------------|-----------------------------|--|------------------------------------|----|
| 1 | PAF15-07010000 | 66M-15100-02-15 | BLOQUE MOTOR COMPLETO | CRANKCASE ASSY | BLOCCO MOTORE COMPLETO | CARTER BLOC MOTEUR | 1 |
| 2 | PAF15-07000001 | 99510-10114 | PIN CENTRADOR | HOLLOW PIN | SPINOTTO DI CENTRAGGIO | PIN DE CENTRAGE | 2 |
| 3 | PAGB/T5783-M5X12 | 93102-25090 | TORNILLO | SCREW | VITE | VIS | 6 |
| 4 | PAGB/T5783-M5X12 | 93306-205YD | TORNILLO | SCREW | VITE | VIS | 4 |
| 5 | PAF15-07010006 | 6E5-24377-00 | PIPA DE AGUA | PIPE, WATER | TUBO | RACCORD TUYAU D'EAU | 2 |
| 6 | PAF15-07010008 | 66M-11325-00 | ÁNODO | ANODE | ANODO | ANODE | 1 |
| 7 | PAF15-07010011 | 66M-11327-00-94 | TAPA ÁNODO | COVER, ANODE | COPERTURA ANODO | COUVERCLE DU ANODE | 1 |
| 8 | PAF15-07010009 | 66M-11328-00 | ALOJAMIENTO ÁNODO | GROMMET, ANODE | ALLOGGIAMENTO ANODO | JOINT D'ANODE | 1 |
| 9 | PAGB/T5783-M5X12 | 97095-0512 | TORNILLO | SCREW | VITE | VIS | 1 |
| 10 | PAGB/T97.1-8 | 92995-05600 | ARANDELA | WASHER | RONDELLA | RONDELLE | 1 |
| 11 | PAGB/T97.1-8 | 97595-06520 | ARANDELA | WASHER | RONDELLA | RONDELLE | 4 |
| 12 | PAF15-07010012 | 66M-12535-00 | EMPAQUETADORA DE ÁNODO | PLATE, ANODE | PIASTRA ANODO | PLAQUE D'ANODE | 1 |
| 13 | PAF15-07010200 | 66M-11168-001S | TAPA | COVER, BREATHER | COPERCHIO | COUVERCLE | 1 |
| 14 | PAGB/T5783-M5X12 | 97575-08550-00 | TORNILLO | SCREW | VITE | VIS | 4 |
| 15 | PAGB/T97.1-8 | 93102-20108 | ARANDELA | WASHER | RONDELLA | RONDELLE | 17 |
| 16 | PAF15-07010014 | 66M-11357-00 | JUNTA TAPA | GASKET, COVER | GAURNIZIONE COPERCHIO | JOINT COUVERCLE | 1 |
| 17 | PAF15-07000031 | 66M-12411-01 | TERMOSTATO | THERMOSTAT | TERMOSTATO | THERMOSTAT | 1 |
| 18 | PAF15-07010022 | 62Y-12414-00 | JUNTA TAPA TERMOSTATO | GASKET, THERMOSTAT COVER | GUARNIZIONE COPERCHIO TERMOSTATO | JOINT COUVERCLE DE THERMOSTAT | 1 |
| 19 | PAF15-07010021 | 6H3-12413-001S | TAPA TERMOSTATO | COVER, THERMOSTAT | COPERCHIO TERMOSTATO | COUVERCLE DE THERMOSTAT | 1 |
| 20 | PAGB/T5783-M5X12 | 90201-08818 | TORNILLO | SCREW | VITE | VIS | 7 |
| 21 | PAF15-07010018 | 66M-41114-01 | JUNTA EXTERIR, TAPA DE ESCAPE | GASKET, EXHAUST OUTER COVER | GUARNIZIONE ESTERIORE, COPERCHIO SCARICO | JOINT DE COUVERCLE EXT ECHAPPEMENT | 1 |
| 22 | PAF15-07000013 | 93604-12M07 | PIN | OPIN | SPINOTTO | LEVIER D'ENTRAINEMENT | 2 |
| 23 | PAGB/T5783-M5X12 | 68D-E5362-00 | TORNILLO | SCREW | VITE | VIS | 1 |
| 24 | PAF15-07010026 | 6E5-11325-00 | ÁNODO | ANODE | ANODO | ANODE | 1 |
| 25 | PAF15-07010019 | 66M-41113-20-1S | TAPA ESCAPE COMPLETA | OUTTER COVER, EXHAUST | COPERCHIO SCARICO COMPLETA | COUVERCLE ECHAPPEMENT EXTERIEUR | 1 |
| 26 | PAF15-04000005 | 676-11372-00 | NIPLE DE MANGUERA | NIPPLE | TUBO | RACCORD D'EAU | 3 |
| 27 | PAF15-05000012 | 90445-09061 | TUBO | HOSE A | TUBO | DURITE D'EAU | 1 |
| 28 | PAF15-05000011 | 688-24378-00 | CONECTOR DE 3 VÍAS | THREE-WAY PIPE | CONNETTORE T | TE | 1 |
| 29 | PAF15-05000013 | 90445-09086 | TUBO | HOSE B | TUBO | DURITE D'EAU | 1 |
| 30 | PAF15-05000014 | 90445-09104 | TUBO | HOSE C | TUBO | DURITE D'EAU | 1 |
| 31 | PAF15-07010003 | 90401-20M00 | TORNILLO | SCREW | VITE | VIS | 1 |
| 32 | PAF15-07010023 | 5GH-13440-00 | FILTRO ACEITE | OIL FILTER | FILTRO DELL'OLIO | FILTRE À HUILE | 1 |
| | REC5GH-13440-00 | 5GH-13440-00 | FILTRO ACEITE | OIL FILTER | FILTRO DELL'OLIO | FILTRE À HUILE | 1 |
| 33 | PAF15-00000014 | 66M-11351-10 | JUNTA BASE MOTOR | GASKET ENGINE | GUARNIZIONE BASE MOTORE | JOINT MOTEUR | 1 |
| 34 | PAF15-07010007 | 90445-10M46 | TUBO | HOSE, RETURN OIL | TUBO | TUYAU | 1 |
| 35 | PAF15-07030000 | 66M-11411-00 | CIGÜEÑAL | CRANK ASSY | ALBERO MOTORE | VILEBREQUIN | 1 |
| 36 | PAF15-07030006 | 93102-35M51 | RETÉN DE ACEITE | OIL SEAL | PARAOLIO | JOINT D'HUILE | 1 |
| 37 | PAF15-07010024 | 66M-11416-00 | COJINETE BANCADA | MAIN BEARING | CUSCINETTO | PALIER DE VILEBREQUIN | 4 |
| 38 | PAF15-07030007 | 93102-25M52 | RETÉN DE ACEITE | OIL SEAL | PARAOLIO | JOINT D'HUILE | 1 |
| 39 | PAF15-07020100 | 66M-11650-00 | BIELA | ROD, CONNECTING | BIELLA | BIELLE | 2 |
| 40 | PAF15-07020001 | 66M-11631-00-96 | PISTÓN | PISTON | PISTONE | PISTON | 2 |
| 41 | PAF15-07020006 | 634-11633-00 | BULÓN | PIN, PISTON | BULLONE | AXE DE PISTON | 2 |
| 42 | PAF15-07020005 | 93450-15023 | CIRCLIP | CIRCLIP | CIRCLIP | CIRCLIP | 4 |
| 43 | REC66N-11603-00 | 66N-11603-00 | KIT SEGMENTOS DE PISTÓN | PISTON RING KIT | KIT FASCIA PISTONE | KIT DE SEGMENTS | 2 |

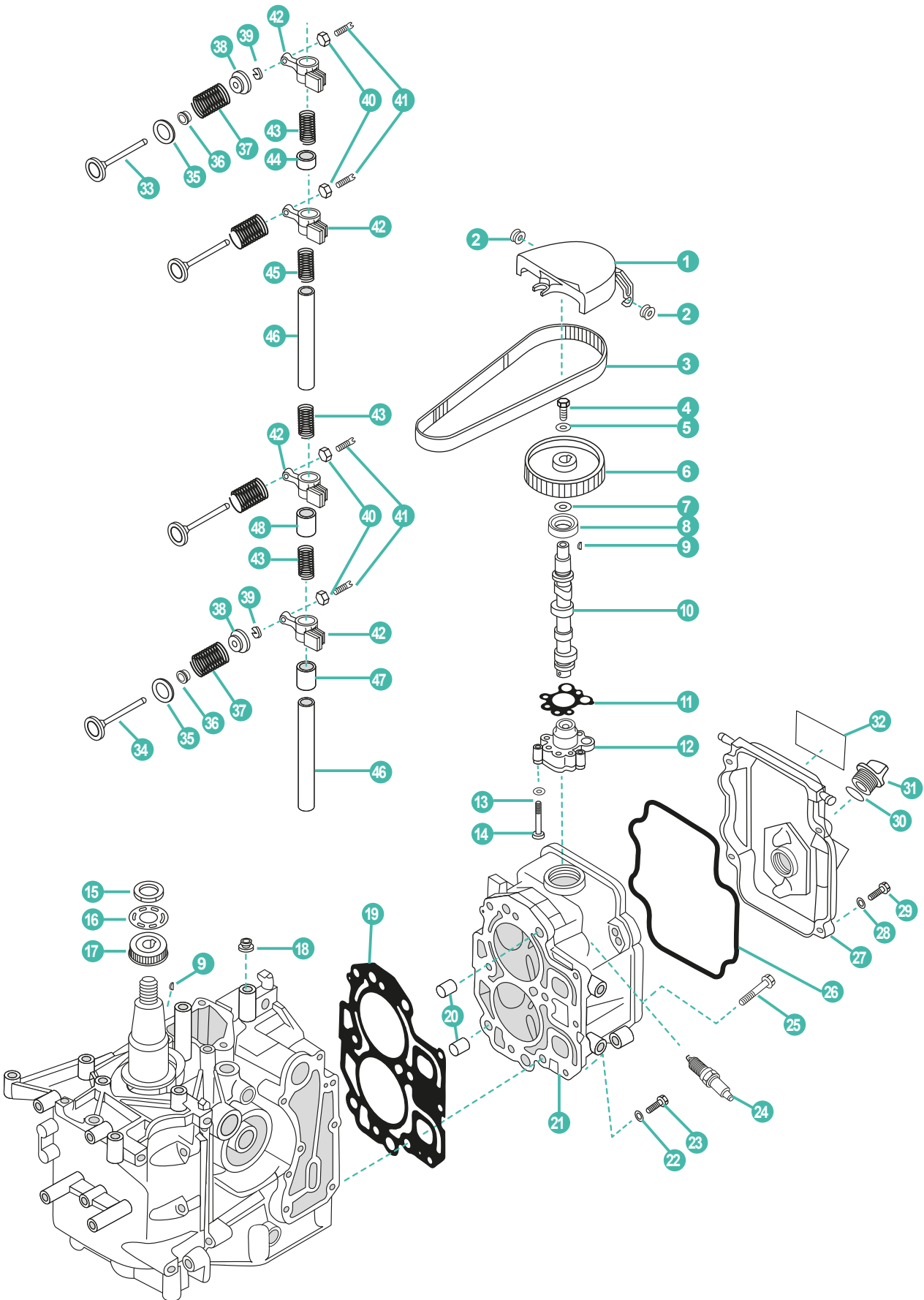

| | REF | OEM | | | | | UN. |
|----|-------------------|-----------------|---------------------|------------------------|------------------------|-----------------------------|-----|
| 1 | PAF15-07000024 | 66M-46297-00 | TAPA | COVER, DUST | COPERCHIO | COUVERCLE | 1 |
| 2 | PAF15-07050003 | 90480-10M16 | GOMA | RING RUBBER A | GOMMINO | BAGUE DE COUVERCLE | 2 |
| 3 | REC66M-46241-00 | 66M-46241-00 | CORREA DISTRIBUCIÓN | BELT TIMING | CINGHIA DISTRIBUZIONE | COURROIE DISTRIBUTION | 1 |
| 4 | PAGB/T5783-M5X12 | 97013-06016 | TORNILLO | BOLT | VITE | VIS | 1 |
| 5 | PAGB/T5287-6 | 90201-06M94 | ARANDELA | BIG WASHER | RONDELLA | RONDELLE | 1 |
| 6 | PAF15-07040018 | 66M-11537-00-94 | POLEA DE CORREA | BELT PULLEY, DRIVEN | PULEGGIA | POULIE DE COURROIE | 1 |
| 7 | PAF15-07040017 | 90201-13201 | ARANDELA | WASHER | RONDELLA | RONDELLE | 1 |
| 8 | PAF15-07040008 | 93102-18M21 | RETÉN DE ACEITE | OIL SEAL | PARAOLIO | JOINT D'HUILE | 1 |
| 9 | PAGB/T1099-3X5X13 | 90280-03M01 | CHAVETA | KEY, WOODRUFF | CHIAVETTA | CLAVETTE | 2 |
| 10 | PAF15-07040200 | 66M-12170-00 | ÁRBOL DE LEVAS | CAMSHAFT ASSY | ALBERO A CAMME | ARBRE À CAMES | 1 |
| 11 | PAF15-07040016 | 66M-13329-10 | JUNTA | MAT, AIRPROOF | GUARNIZIONE | JOINT | 1 |
| 12 | PAF15-07040500 | 66M-13300-10 | BOMBA ACEITE | OIL PUMP ASSY | POMPA DELL'OLIO | POMPE À HUILE | 1 |
| 13 | PAGB/T97.1-8 | 92995-06600 | ARANDELA | WASHER | RONDELLA | RONDELLE | 3 |
| 14 | PAGB/T5783-M5X12 | 97095-06035 | TORNILLO | BOLT | VITE | VIS | 3 |
| 15 | PAF15-07030005 | 90170-28M37 | TUERCA | NUT | GHIERA | ÉCROU | 1 |
| 16 | PAF15-07030004 | 66M-11557-00 | ARANDELA | WASHER | RONDELLA | RONDELLE | 1 |
| 17 | PAF15-07030003 | 66M-11536-10 | POLEA DENTADA | BELT PULLEY, TIMING | PULEGGIA | POULIE | 1 |
| 18 | PAF15-07010027 | 90480-12072 | GOMA | RUBBER RING | GOMMINO | BAGUE DE COUVERCLE | 1 |
| 19 | PAF15-07000100 | 66M-11181-10 | JUNTA CULATA | GASKET, CYLINDER HEAD | GUARNIZIONE TESTATA | JOINT DE CULASSE | 1 |
| 20 | PAF15-07000001 | 99510-10114 | PIN CENTRADOR | HOLLOW PIN | SPINOTTO DI CENTRAGGIO | PIN DE CENTRAGE | 2 |
| 21 | PAF15-07040000 | 66M-11111-01-1S | CULATA | CYLINDER HEAD ASSY | TESTATA | CULASSE | 1 |
| 22 | PAGB/T97.1-6 | 92990-06600 | ARANDELA | WASHER | RONDELLA | RONDELLE | 3 |
| 23 | PAGB/T5783-M6X25 | 97513-06525 | TORNILLO | BOLT | VITE | VIS | 3 |
| 24 | NGKDP7EA-9 | 94701-00375 | BUJÍA | SPARK PLUG | CANDELA | BOUGIE | 2 |
| 25 | PAF15-07000028 | 90105-08M78 | TORNILLO | BOLT, FLANGE | VITE | VIS | 6 |
| 26 | PAF15-07050002 | 66M-11356-00 | JUNTA TAPA | SEAL, CYLINDER COVER | GAURNIZIONE COPERCHIO | JOINT COUVERCLE | 1 |
| 27 | PAF15-07050001 | 66M-11191-00-1S | TAPA BALANCINES | COVER, CYLINDER HEAD | COPERCHIO PUNTERIE | CACHE CULBUTEUR | 1 |
| 28 | PAGB/T5783-M5X12 | 92995-06600 | ARANDELA | WASHER, PLATE | RONDELLA | RONDELLE | 7 |
| 29 | PAGB/T5783-M6X20 | 97595-06520 | TORNILLO | BOLT | VITE | VIS | 4 |
| 30 | PAF4-04000008 | 93210-24M79 | TÓRICA | O-RING | O-RING | TORIQUE | 1 |
| 31 | PAF15-07050004 | 6G8-15363-00 | TAPÓN ACEITE | PLUG, OIL | TAPPO OLIO | BOUCHON REMPLISSAGE D'HUILE | 1 |
| 32 | PAF15-10030001 | 66M-12138-60 | ADHESIVO 4 | MARK 4 | ADESIVO 4 | AUTOCOLLANT 4 | 1 |
| 33 | PAF15-07040001 | 66M-12111-00 | VÁLVULA ADMISIÓN | VALVE, INTAKE | VALVOLA ASPIRAZIONE | SOUPAPE D ADMISSION | 2 |
| 34 | PAF15-07040002 | 66M-12121-00 | VÁLVULA ESCAPE | VALVE, EXHAUST | VALVOLA SCARICO | SOUPAPE D'ÉCHAPPEMENT | 2 |
| 35 | PAF15-07040004 | 66M-12116-00 | ARANDELA DE ASIENTO | SEAT, VALVE SPRING | RONDELLA BASAMENTO | SIEGE RESSORT DE SOUPAPE | 4 |
| 36 | PAPS2700.04.03 | 51Y-12119-00 | RETÉN | SEAL, VALVESTEM | GUARNIZIONE | JOINT D'HUILE | 4 |
| 37 | PAF15-07040005 | 66M-12113-00 | MUELLE | SPRING, VALVE | MOLLA | RESSORT | 4 |
| 38 | PAF15-07050006 | 30X-12117-00 | RETÉN RESORTE | SPRING, VALVE RETAINER | VALVOLA DI RITEGNO | JOINT DE RESSORT | 4 |
| 39 | PAF15-07040007 | 30X-12118-00 | SEGURO DE VÁLVULA | CLAMP, VALVE | BLOCCAGGIO DI VALVOLA | CLAVETTE DE SOUPAPE | 8 |
| 40 | PAF15-07040304 | 62Y-12158-00 | TUERCA | LOCK NUT | DADO | ÉCROU | 4 |
| 41 | PAF15-07040303 | 62Y-12159-00 | TORNILLO REGULADOR | SCREW, VALVE ADJUSTING | VITE REGOLATORE | VIS POINTEAU | 4 |
| 42 | PAF15-07040301 | 66M-12151-10 | BALANCÍN | VALVE ROCKER | BILANCERE | CULBUTEUR | 4 |
| 43 | PAF15-07040014 | 90501-12M40 | MUELLE | SPRING, ROCKER | MOLLA | RESSORT | 3 |
| 44 | PAF15-07040009 | 90387-13001 | CASQUILLO | BUSHER | GOMMINO | DOUILLE | 1 |
| 45 | PAF15-07040013 | 90501-12M41 | MUELLE | SPRING, ROCKER A | MOLLA | RESSORT | 1 |
| 46 | PAF15-07040015 | 66M-12146-00 | EJE DE BALANCÍN | SHAFT, ROCKER | ASSE BILANCERE | AXE DE CULBUTEUR | 2 |
| 47 | PAF15-07040012 | 90387-13M56 | CASQUILLO B | BUSHER B | GOMMINO B | BAGUE B | 1 |
| 48 | PAF15-07040011 | 90387-13002 | CASQUILLO A | BUSHER A | GOMMINO A | BAGUE A | 1 |
| 49 | PAF15-07000000 | 66M-W009B-15-1S | MOTOR COMPLETO | POWER HEAD COMPLETE | MOTORE COMPLETO | MOTEUR COMPLET | 1 |

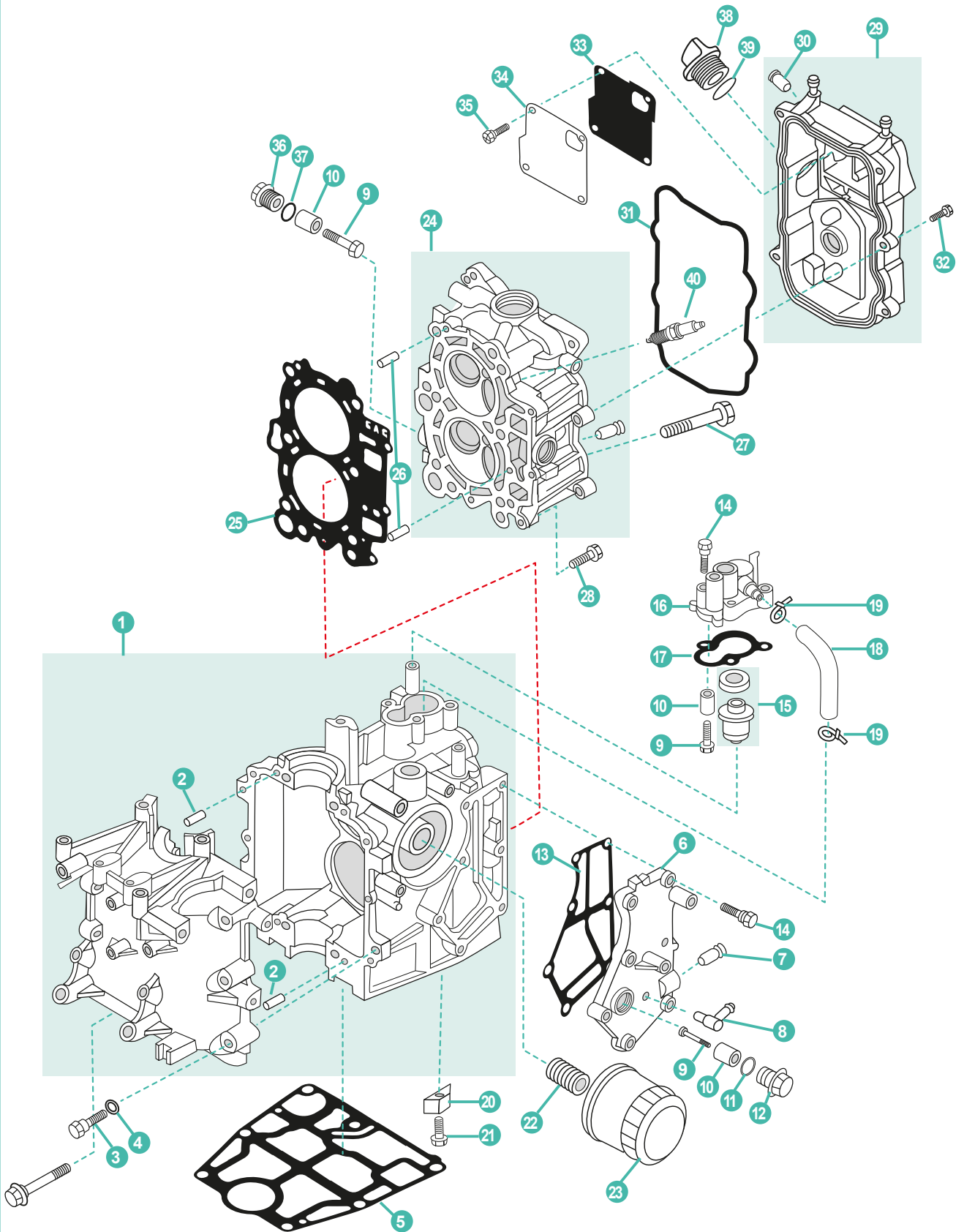

| | REF | OEM | | | | UN. | |
|----|-------------------|-----------------|-------------------------|--------------------------|----------------------------|-----------------------------|---|
| 1 | PAF20-05010000 | 6AH-15100-00 | CÁRTER COMPLETO | CRANKCASE ASSY | CARTER COMPLETO | CARTER BLOC MOTEUR | 1 |
| 2 | REC93606-12019 | 93606-12019 | PIN CENTRADOR | HOLLOW PIN | SPINOTTO DI CENTRAGGIO | PIN DE CENTRAGE | 4 |
| 3 | PAF20-05010007 | 97013-06040 | PERNO | BOLT | BULLONE | BOULON | 6 |
| 4 | PAGB/T97.1-6 | 92903-06600 | ARANDELA | WASHER | RONDELLA | RONDELLE | 6 |
| 5 | REC6AH-11351-00 | 6AH-11351-10 | JUNTA DE ESCAPE | EXHAUST GASKET | GUARNIZIONE DI SCARICO | JOINT D'ÉCHAPPEMENT | 1 |
| 6 | PAF20-05000600 | 6AH-41113-01-1S | CUBIERTA DE ESCAPE | EXHAUST COVER | COPERCHIO SCARICO | COUVERCLE D'ÉCHAPPEMENT | 1 |
| 7 | PAF4-04010102 | 6E9-24378-00 | PIPA DE AGUA | PIPE, WATER | TUBO | RACCORD TUYAU D'EAU | 1 |
| 8 | PAF15-04000005 | 6H1-11372-00 | NIPLE DE MANGUERA | NIPPLE | TUBO | RACCORD D'EAU | 1 |
| 9 | PAGB/T818-M5X25 | 98980-05025 | TORNILLO | SCREW | VITE | VIS | 4 |
| 10 | CM6G8-11325-00A | 6G8-11325-00 | ÁNODO | ANODE | ANODO | ANODE | 4 |
| 11 | PAGB/T3452.1-13X2 | 93210-13M63 | ANILLO | O-RING | O-RING | TORIQUE | 1 |
| 12 | PAF20-05030009 | 6G8-11197-A0 | TAPÓN | CAP | TAPPO | BOUCHON | 1 |
| 13 | PAF20-05000602 | 6AH-41114-00 | JUNTA DE ESCAPE | EXHAUST GASKET | GUARNIZIONE DI SCARICO | JOINT D'ÉCHAPPEMENT | 1 |
| 14 | PAGB/T5783-M6X25 | 90119-06MA3 | TORNILLO | SCREW | VITE | VIS | 3 |
| 15 | REC6AH-12411-00 | 6AH-12411-00 | TERMOSTATO | THERMOSTAT | TERMOSTATO | THERMOSTAT | 1 |
| 16 | PAF20-05000700 | 6AH-12413-00-1S | TAPA TERMOSTATO | COVER, THERMOSTAT | COPERCHIO TERMOSTATO | COUVERCLE DE THERMOSTAT | 1 |
| 17 | PAF20-05000702 | 6AH-12414-00 | JUNTA | GASKET | GUARNIZIONE | JOINT | 1 |
| 18 | PAF20-05000016 | 6AH-12481-00 | TUBO DE AGUA | WATER TUBE | TUBO DELL'ACQUA | DURITE D'EAU | 1 |
| 19 | PAHT2.5X50 | 90465-11M10 | BRIDA | CLAMP | FLANGIA | COLLIER | 2 |
| 20 | CM15026A | 6E5-11325-00 | ÁNODO | ANODE | ANODO | ANODE | 1 |
| 21 | PAGB/T820-M4X12 | 98780-04016 | TORNILLO | SCREW | VITE | VIS | 1 |
| 22 | PAF15-07010003 | 6C5-12858-00 | PERNO | STUD | BULLONE | BOULON | 1 |
| 23 | REC5GH-13440-60 | 5GH-13440-60 | FILTRO ACEITE | OIL FILTER | FILTRO DELL'OLIO | FILTRE À HUILE | 1 |
| 24 | PAF20-05030100 | 6AH-11111-10-1S | CULATA | CYLINDER HEAD | TESTATA | CULASSE | 1 |
| 25 | REC6AG-11181-00 | 6AG-11181-10 | JUNTA CULATA | GASKET, CYLINDER HEAD | GUARNIZIONE TESTATA | JOINT DE CULASSE | 1 |
| 26 | REC93606-12019 | 93606-12019 | PIN CENTRADOR | HOLLOW PIN | SPINOTTO DI CENTRAGGIO | PIN DE CENTRAGE | 2 |
| 27 | PAF20-05000002 | 90105-090006 | TORNILLO | SCREW | VITE | VIS | 6 |
| 28 | PAF8-05000022 | 90119-06MA3 | TORNILLO | SCREW | VITE | VIS | 3 |
| 29 | PAF20-05040000 | 6AH-11191-001S | TAPA DE CULATA COMPLETA | CYLINDER HEAD COVER ASSY | COPERCHIO TESTATA COMPLETA | CACHE CULBUTEUR COMPLÈTE | 1 |
| 30 | PAF20-05040005 | 6AH-11372-00 | NIPLE DE MANGUERA | NIPPLE | TUBO | RACCORD D'EAU | 1 |
| 31 | PAF20-05040002 | 6AH-11356-00 | RETÉN DE ACEITE | OIL SEAL | PARAOLIO | JOINT D'HUILE | 1 |
| 32 | PAGB/T5783-M6X20 | 97595-06520 | PERNO | STUD | BULLONE | BOULON | 5 |
| 33 | PAF20-05040003 | 6AH-11168-00 | CUBIERTA DE RESPIRADERO | COVER, BREATHER | COPERCHIO | PLAQUE | 1 |
| 34 | PAF20-05040004 | 6AH-11169-00 | JUNTA DE CUBIERTA | GASKET, BREATHER | GUARNIZIONE COPERCHIO | JOINT DE PLAQUE | 1 |
| 35 | PAGB/T818-M4X10 | 97607-04210 | TORNILLO | SCREW | VITE | VIS | 4 |
| 36 | PAF20-05030009 | 6G8-11197-A0 | TAPÓN | CAP | TAPPO | BOUCHON | 2 |
| 37 | PAGB/T3452.1-13X2 | 93210-13M63 | ANILLO | O-RING | O-RING | TORIQUE | 2 |
| 38 | PAF15-07050004 | 6G8-15363-00 | TAPÓN DE ACEITE | OIL CAP | TAPPO OLIO | BOUCHON REMPLISSAGE D'HUILE | 1 |
| 39 | PAJASOF40431-025 | 93210-24M79 | ANILLO | O-RING | O-RING | TORIQUE | 1 |
| 40 | NGKDPR6EB-9 | 94702-00418 | BUJÍA | SPARK PLUG | CANDELA | BOUGIE | 2 |



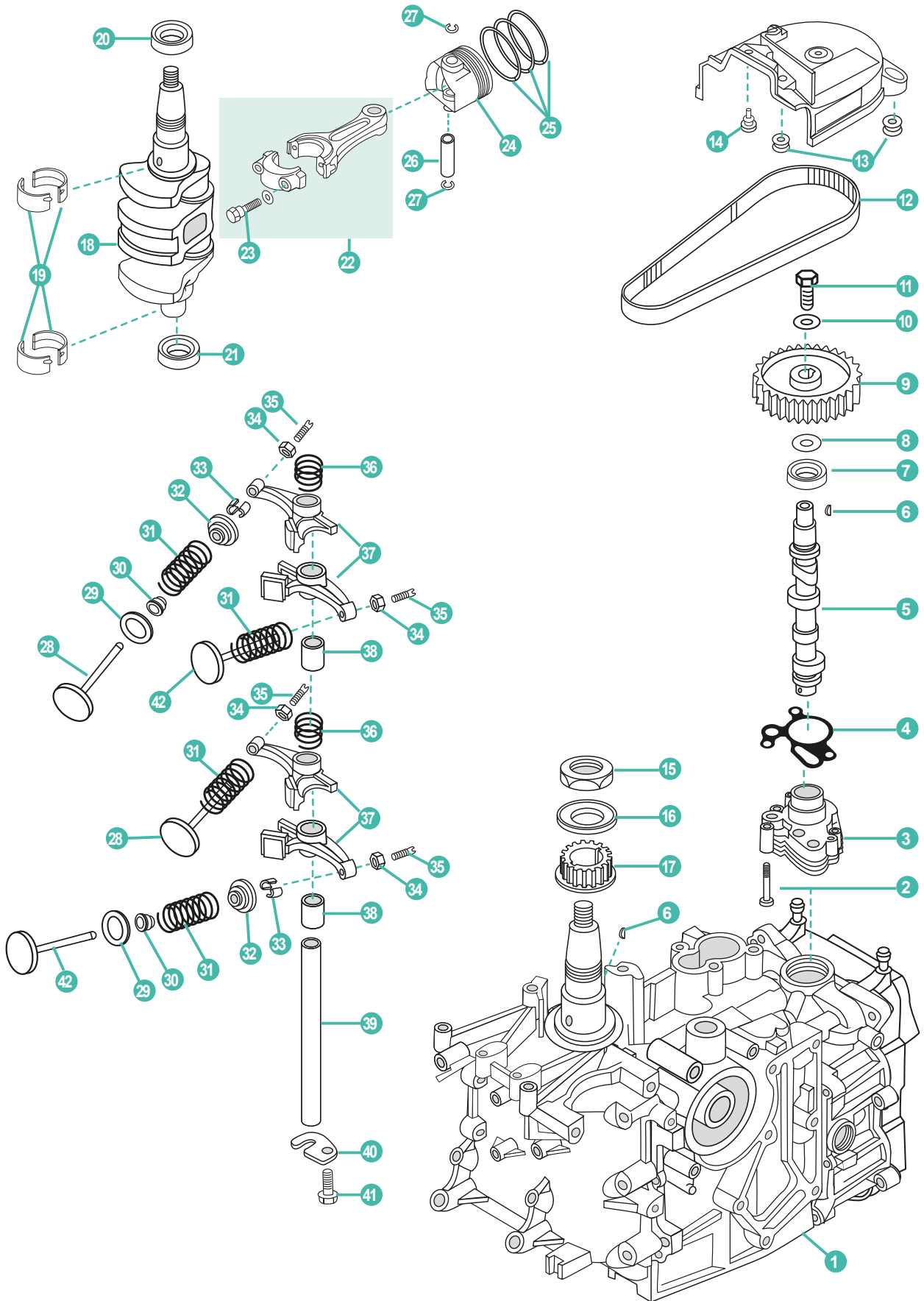

| | REF | OEM | | | | UN. | |
|----|-------------------|-----------------|-----------------------------|------------------------|---------------------------|--------------------------|---|
| 1 | PAF20-0500000 | 6AH-W009B-02-15 | CILINDRO BLOQUE COMPLETO | POWER HEAD ASSY | BLOCCO COMPLETO | TÊTE MOTRICE | 1 |
| 2 | PAGB/T5783-M6X35 | 90105-06035 | TORNILLO | SCREW | VITE | VIS | 3 |
| 3 | PAF20-05030400 | 6AH-13300-00 | BOMBA DE ACEITE | OIL PUMP | POMPA DELL'OLIO | POMPE À HUILE | 1 |
| 4 | PAF20-05030010 | 6AH-13329-10 | JUNTA TAPA | GASKET, COVER | GAURNIZIONE COPERCHIO | JOINT COUVERCLE | 1 |
| 5 | PAF20-05030200 | 6AH-12170-00 | ÁRBOL DE LEVAS | CAMSHAFT ASSY | ALBERO A CAMME | ARBRE À CAMES | 1 |
| 6 | PAGB/T1099-3X5X13 | 90280-03M01 | CUÑA | KEY WOODRUFF | CHIAVETTA | CLAVETTE | 2 |
| 7 | PAF20-05030005 | 93102-22010 | RETÉN DE ACEITE | OIL SEAL | PARAOLIO | JOINT D'HUILE | 1 |
| 8 | PAF20-05030011 | 90201-15423 | ARANDELA | WASHER | RONDELLA | RONDELLE | 1 |
| 9 | PAF20-05030012 | 6AH-11537-00 | POLEA DE CORREA | BELT PULLEY, DRIVEN | PULEGGIA CINGHIA | POULIE DE COURROIE | 1 |
| 10 | PAF20-05030013 | 90201-08784 | ARANDELA | WASHER | RONDELLA | RONDELLE | 1 |
| 11 | PAGB/T5783-M8X25 | 90105-081A7 | TORNILLO | SCREW | VITE | VIS | 1 |
| 12 | PAF20-05000003 | 6AH-46241-00 | CORREA | BELT | CINGHIA | COURROIE | 1 |
| 13 | PAF20-05000034 | 90480-10627 | TAPÓN | CAP | TAPPO | BOUCHON | 3 |
| 14 | PAF20-05000036 | 90480-06M19 | TAPÓN | CAP | TAPPO | BOUCHON | 1 |
| 15 | PAF20-05000029 | 90170-30003 | TUERCA | NUT | DADO | ÉCROU | 1 |
| 16 | PAF20-05000028 | 6AH-11557-00 | ARANDELA | WASHER | RONDELLA | RONDELLE | 1 |
| 17 | PAF20-05000027 | 6AH-11536-00 | ENGRANAJE DE DISTRIBUCIÓN | BELT PULLEY, TIMING | PULEGGIA DE DISTRIBUZIONE | POULIE DE DISTRIBUTION | 1 |
| 18 | PAF20-05020004 | 6AH-11411-00 | CIGÜEÑAL | CRANK ASSY | ALBERO MOTORE | VILEBREQUIN | 1 |
| 19 | PAF20-05010003 | 6AH-11416-00 | COJINETE BANCADA | MAIN BEARING | CUSCINETTO | PALIER DE VILEBREQUIN | 1 |
| 20 | PAF25-05050021 | 93102-37004 | RETÉN DE ACEITE | OIL SEAL | PARAOLIO | JOINT D'HUILE | 1 |
| 21 | PAF15-07030006 | 93102-25014 | RETÉN DE ACEITE | OIL SEAL | PARAOLIO | JOINT D'HUILE | 1 |
| 22 | PAF20-05020200 | 6AH-11650-10 | BIELA | ROD, CONNECTING | BIELLA | BIELLE | 2 |
| 23 | PAF25-05020204 | 6AH-11654-00 | TORNILLO | SCREW | VITE | VIS | 2 |
| 24 | PAF20-05020001 | 6AH-11631-00 | PISTÓN STD | PISTON STD | PISTONE STD | PISTON STD | 2 |
| 25 | PAF20-05020100 | 6AH-11603-00 | KIT SEGMENTOS DE PISTÓN STD | PISTON RING KIT STD | KIT FASCIA PISTONE STD | KIT SEGMENTS STD | 2 |
| 26 | PAF20-05020003 | 137-11633-10 | PIN, PISTÓN | PIN, PISTON | SPINOTTO PISTONE | AXE DE PISTON | 2 |
| 27 | PAF20-05020002 | 93450-17129 | CIRCLIP | CIRCLIP | CIRCLIP | CIRCLIP | 4 |
| 28 | PAF20-05030001 | 6AH-12111-00 | VÁLVULA ADMISIÓN | VALVE, INTAKE | VALVOLA ASPIRAZIONE | SOUPAPE D ADMISSION | 2 |
| 29 | PAF20-05030003 | 62Y-12116-00 | ARANDELA DE ASIENTO | SEAT, VALVE SPRING | RONDELLA BASAMENTO | SIEGE RESSORT DE SOUPAPE | 4 |
| 30 | PA166F-010003 | 51Y-12119-00 | RETÉN DE ACEITE | OIL SEAL | PARAOLIO | JOINT D'HUILE | 4 |
| 31 | PAF20-05030004 | 3YF-12113-00 | MUELLE DE VÁLVULA | SPRING, VALVE STEM | MOLLA DI VALVOLA | RESSORT DE SOUPAPE | 4 |
| 32 | PAF15-07040006 | 30X-12117-00 | RETÉN RESORTE | SPRING, VALVE RETAINER | VALVOLA DI RITEGNO | JOINT DE RESSORT | 4 |
| 33 | PAF15-07040007 | 30X-12118-00 | SEGURO DE VÁLVULA | CLAMP, VALVE | BLOCCAGGIO DI VALVOLA | CLAVETTE DE SOUPAPE | 8 |
| 34 | PAF15-07040304 | 62Y-12158-00 | TUERCA | LOCK NUT | DADO | ÉCROU | 4 |
| 35 | PAF15-07040303 | 64J-12159-00 | TORNILLO REGULADOR | SCREW, VALVE ADJUSTING | VITE REGOLATORE | VIS POINTEAU | 4 |
| 36 | PAF20-05030007 | 90501-120A5 | RESORTE DE COMPRESIÓN | SPRING, ROCKER | MOLLA | RESSORT ROCKER | 2 |
| 37 | PAF20-05030301 | 6AH-12151-00 | BRAZO DE BALANCÍN | ARM, VALVE ROCKER | BILANCERE | CULBUTEUR | 4 |
| 38 | PAF20-05030006 | 90387-13006 | ESPACIADOR | COLLAR | DISTANZIALE | ENTRETOISE | 2 |
| 39 | PAF15-07040015 | 66M-12146-00 | EJE DE BALANCÍN | SHAFT, ROCKER | ASSE DE BILANCERE | AXE DE CULBUTEUR | 1 |
| 40 | PAF20-05030008 | 6AH-12279-00 | PLACA | PLATE | PIASTRA | PLAQUE | 1 |
| 41 | PAGB/T5783-M6X12 | 97013-06012 | TORNILLO | SCREW | VITE | VIS | 1 |
| 42 | PAF20-05030002 | 6AH-12121-10 | VÁLVULA ESCAPE | VALVE, EXHAUST | VALVOLA SCARICO | SOUPAPE D'ECHAPPEMENT | 2 |

4T FT • F20 • F25 (1998-08)

STROKES

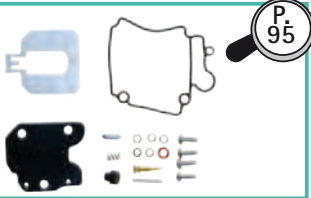

| REF | OEM |
|------------|--------------|
| REC8542561 | 65W-W0093-02 |

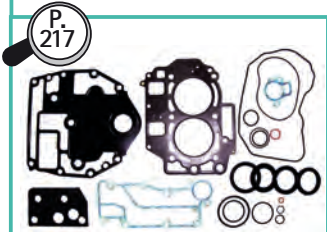
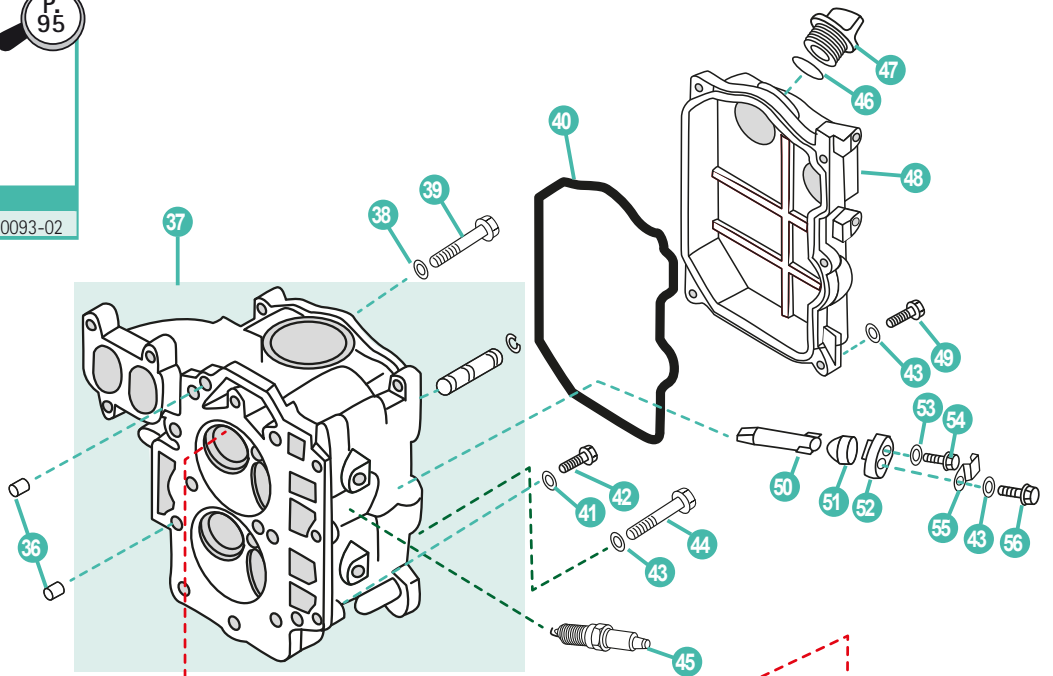

| REF | OEM |
|-----------------|--------------|
| REC65W-W0001-00 | 65W-W0001-02 |

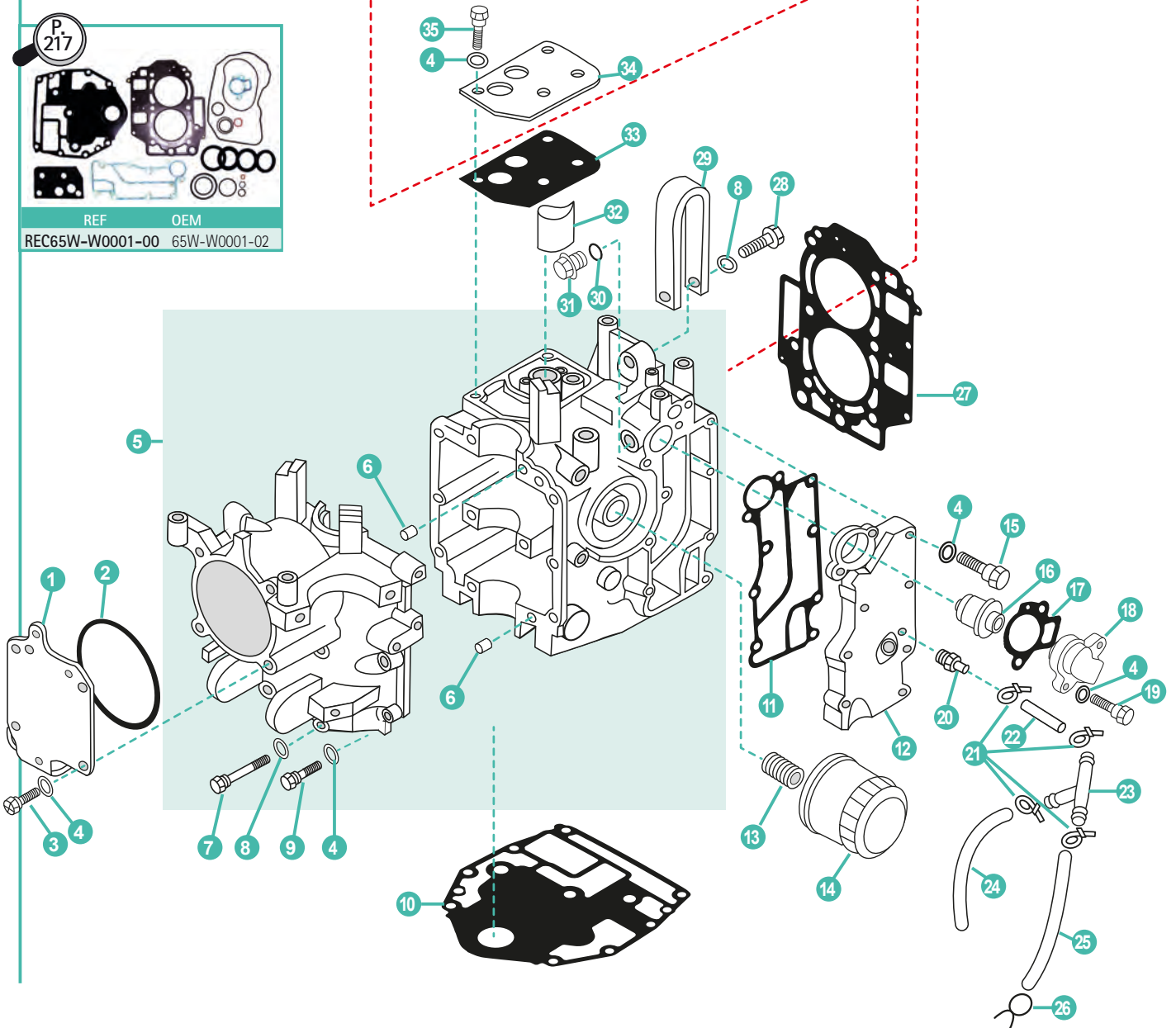

| | REF | OEM | | | | UN. | |
|----|----------------------|-----------------|--------------------------------|-----------------------------|--|------------------------------------|----|
| 1 | PAF25-05000007 | 65W-15121-00 | TAPA | COVER | COPERCHIO | COUVERCLE | 1 |
| 2 | PAGBT3452.1-97.5X1.8 | 65W-15663-00 | JUNTA | SEAL | GUARNIZIONE | JOINT | 1 |
| 3 | PAGB/T5783-M6X20 | 65W-12228-00 | TORNILLO | BOLT, HEXAGON | VITE | VIS | 4 |
| 4 | PAGB/T97.1-8 | 66M-11356-00 | ARANDELA | WASHER 6 | RONDELLA | RONDELLE | 17 |
| 5 | PAF25-05010000 | 65W-15100-00-94 | BLOQUE MOTOR COMPLETO | CRANKCASE ASSY | BLOCCO MOTORE COMPLETO | CARTER BLOC MOTEUR | 1 |
| 6 | PAF25-00000014 | 99530-08012 | PIN CENTRADOR | HOLLOW PIN | SPINOTTO DI CENTRAGGIO | PIN DE CENTRAGE | 2 |
| 7 | PAGB/T5782-M8X80 | 90119-08M01 | TORNILLO | BOLT, HEXAGON | VITE | VIS | 6 |
| 8 | PAGB/T97.1-8 | 97595-06520 | ARANDELA | WASHER | RONDELLA | RONDELLE | 7 |
| 9 | PAGB/T5782-M6X35 | 90119-06MA5 | TORNILLO | BOLT, HEXAGON | VITE | VIS | 6 |
| 10 | PAF25-00000013 | 65W-11351-00 | JUNTA BASE MOTOR | GASKET ENGINE | GUARNIZIONE BASE MOTORE | JOINT MOTEUR | 1 |
| 11 | PAF25-05010111 | 65W-41114-00 | JUNTA EXTERIOR, TAPA DE ESCAPE | GASKET, EXHAUST OUTER COVER | GUARNIZIONE ESTERIORE, COPERCHIO SCARICO | JOINT DE COUVERCLE EXT ECHAPPEMENT | 1 |
| 12 | PAF25-05010112 | 65W-41113-01-94 | TAPA EXTERIOR DE ESCAPE | OUTTER COVER, EXHAUST | COPERCHIO SCARICO | COUVERCLE D'ECHAPPEMENT | 1 |
| 13 | PAF15-07010003 | 90401-20M00 | TORNILLO | BOLT, UNION | VITE | VIS | 1 |
| 14 | PAF25-05000100 | 5GH-13440-00 | FILTRO ACEITE | OIL FILTER | FILTRO DELL'OLIO | FILTRE À HUILE | 1 |
| 14 | REC5GH-13440-00 | 5GH-13440-00 | FILTRO ACEITE | OIL FILTER | FILTRO DELL'OLIO | FILTRE À HUILE | 1 |
| 15 | PAGB/T5783-M6X35 | 90119-06MAS | TORNILLO | BOLT | VITE | VIS | 7 |
| 16 | PAF15-07000031 | 6G8-12411-02 | TERMOSTATO | THERMOSTAT | TERMOSTATO | THERMOSTAT | 1 |
| 17 | PAF15-07010022 | 62Y-12414-00 | JUNTA TAPA TERMOSTATO | GASKET, THERMOSTAT COVER | GUARNIZIONE COPERCHIO TERMOSTATO | JOINT COUVERCLE DE THERMOSTAT | 1 |
| 18 | PAF15-07010021 | 6H3-12413-00-9M | TAPA TERMOSTATO | COVER, THERMOSTAT | COPERCHIO TERMOSTATO | COUVERCLE DE THERMOSTAT | 1 |
| 19 | PAGB/T5783-M6X25 | 90119-06MA5 | TORNILLO | BOLT | VITE | VIS | 2 |
| 20 | PAF25-05010113 | 62Y-11372-01 | NIPLE DE MANGUERA | NIPPLE | TUBO | RACCORD D'EAU | 1 |
| 21 | PAHT-2.5x60 | 90465-11M10 | BRIDA | CLAMP | FLANGIA | COLLIER | 5 |
| 22 | PAF25-03000008 | 90445-09068 | TUBO DE AGUA | WATER TUBE | TUBO DELL'ACQUA | DURITE D'EAU | 1 |
| 23 | PAF15-05000011 | 688-24378-00 | CONECTOR DE 3 VÍAS | THREE-WAY PIPE | CONNETTORE T | TE | 1 |
| 24 | PAF25-03000009 | 90445-09095 | TUBO DE AGUA | WATER TUBE | TUBO DELL'ACQUA | DURITE D'EAU | 1 |
| 25 | PAF25-03000011 | 90445-09105 | TUBO DE AGUA | WATER TUBE | TUBO DELL'ACQUA | DURITE D'EAU | 1 |
| 26 | PAF4-04000030 | 90467-09M09 | MUELLE TUBO COMBUSTIBLE B | SPRING, FUEL PIPE B | MOLLA TUBO COMBUSTIBILE B | RESSORT, TUYAU DE CARBURANT | 1 |
| 27 | PAF25-05040000 | 65W-11181-30 | JUNTA CULATA | GASKET, CYLINDER HEAD | GUARNIZIONE TESTATA | JOINT DE CULASSE | 1 |
| 28 | PAGB/T5782-M8X35 | 65W-08M87 | TORNILLO | BOLT, HEXAGON | VITE | VIS | 1 |
| 29 | PAF25-05010106 | 66W-11119-00 | SOPORTE | HANGER, ENGINE | SUPPORTO | CROCHET LEVAGE MOTEUR | 1 |
| 30 | PAF15-04000003 | 90430-14M09 | ARANDELA | WASHER | RONDELLA | RONDELLE | 1 |
| 31 | PAF15-04000002 | 90340-14M06 | TORNILLO DRENAJE | BOLT, DISCHARGING OIL | VITE DRENAGGIO | VIS DE VIDANGE | 1 |
| 32 | PAF25-05010107 | 65W-13286-00 | FILTRO ACEITE | OIL FILTER | FILTRO DELL'OLIO | FILTRE À HUILE | 1 |
| 33 | PAF25-05010108 | 65W-11169-00 | JUNTA DE CUBIERTA | GASKET, BREATHER | GUARNIZIONE COPERCHIO | JOINT DE PLAQUE | 1 |
| 34 | PAF25-05010103 | 65W-11168-00 | CUBIERTA DE RESPIRADERO | COVER, BREATHER | COPERCHIO | PLAQUE | 1 |
| 35 | PAGB/T5783-M6X20 | 65W-12228-00 | TORNILLO | BOLT, HEXAGON | VITE | VIS | 4 |
| 36 | PAF25-00000014 | 99530-08012 | PIN CENTRADOR | HOLLOW PIN | SPINOTTO DI CENTRAGGIO | PIN DE CENTRAGE | 2 |
| 37 | PAF25-05050100 | 65W-11111-02-94 | CULATA | CYLINDER HEAD | TESTATA | CULASSE | 1 |
| 38 | PAF25-05050007 | 90430-06014 | JUNTA | GASKET | GUARNIZIONE | JOINT | 1 |
| 39 | PAF25-05050006 | 90109-06M65 | TORNILLO | BOLT | VITE | VIS | 1 |
| 40 | PAF25-05000004 | 65W-11356-00 | JUNTA TAPA | GASKET, COVER | GAURNIZIONE COPERCHIO | JOINT COUVERCLE | 1 |
| 41 | PAGB/T97.1-8 | 97595-06520 | ARANDELA | WASHER, PLATE | RONDELLA | RONDELLE | 10 |
| 42 | PAGB/T5783-M6X25 | 90119-06MA3 | TORNILLO | BOLT, HEXAGON | VITE | VIS | 6 |
| 43 | PAF25-05000003 | | ARANDELA | WASHER, PLATE | RONDELLA | RONDELLE | 10 |
| 44 | PAF25-05000002 | 90119-09M00 | TORNILLO | BOLT, FLANGE | VITE | VIS | 9 |
| 45 | NGKDPR7EA-9 | 94701-00375 | BUJÍA | SPARK-PLUG | CANDELA | BOUGIE | 2 |
| 46 | PAJASOF40431-025 | 93210-24M79 | TÓRICA | O-RING | O-RING | TORIQUE | 1 |
| 47 | PAF15-07050004 | 6G8-15363-00 | TAPÓN ACEITE | PLUG, OIL | TAPPO OLIO | BOUCHON REMPLISSAGE D'HUILE | 1 |
| 48 | PAF25-05000005 | 65W-11191-00-94 | TAPA BALANCINES | COVER, CYLINDER HEAD | COPERCHIO PUNTERIE | CACHE CULBUTEUR | 1 |
| 49 | PAGB/T5783-M6X20 | 90119-06MA3 | TORNILLO | BOLT, HEXAGON | VITE | VIS | 5 |
| 50 | PAF25-02010005 | 62Y-11325-00 | ÁNODO | ANODE | ANODO | ANODE | 2 |
| 51 | PAF15-07010009 | 66M-11328-00 | ALOJAMIENTO ÁNODO | GROMMET, ANODE | ALLOGGIAMENTO ANODO | JOINT D'ANODE | 2 |
| 52 | PAF15-07010011 | 66M-11327-00-94 | TAPA | COVER, ANODE | COPERTURA ANODO | COUVERCLE DU ANODE | 2 |
| 53 | PAGB/T97.1-5 | 92995-05600 | ARANDELA | WASHER, PLATE | RONDELLA | RONDELLE | 2 |
| 54 | PAGB/T5783-M5X12 | 97095-05012 | TORNILLO | BOLT, HEXAGON | VITE | VIS | 2 |
| 55 | PAF15-07010012 | 66M-12535-00 | PLETINA | PLATE, ANODE | PIASTRA ANODO | PLAQUE | 2 |
| 56 | PAGB/T5783-M6X20 | 97095-06020 | TORNILLO | BOLT, HEXAGON | VITE | VIS | 2 |

| | REF | OEM | | | | UN. | |
|----|-------------------|-----------------|---------------------------|-------------------------|---------------------------|-----------------------------|---|
| 1 | POWERHEAD20-25 | | MOTOR | COMPLETE, POWER | BLOCCO COMPLETO | TÊTE MOTRICE | 1 |
| 2 | PAF25-05020002 | 93102-35M47 | RETÉN | OIL-SEAL | GUARNIZIONE | JOINT D'HUILE | 1 |
| 3 | PAF25-05010302-1 | 62Y-11416-00 | COJINETE BANCADA BROWN | MAIN BEARING BROWN | CUSCINETTO BROWN | PALIER DE VILEBREQUIN BROWN | 6 |
| 3 | PAF25-05010302-2 | 62Y-11416-10 | COJINETE BANCADA BLACK | MAIN BEARING BLACK | CUSCINETTO BLACK | PALIER DE VILEBREQUIN BLACK | 6 |
| 4 | PAF25-05000026 | 90170-35M47 | TUERCA | LOCK NUT | DADO | ÉCROU | 1 |
| 5 | PAF25-05020301 | 65W-11642-11 | PISTÓN, CONTRA | PISTON, BALANCE | PISTONE, CONTRO | PISTON D'EQUILIBRAGE | 1 |
| 6 | PAF25-05020310 | 65W-11665-00 | BIELA, CONTRO | CON-ROD ASSY, BALANCE | BIELLA, CONTRO | BIELLE D'EQUILIBRAGE | 1 |
| 7 | PAF25-05020003 | 93102-43M42 | RETÉN | OIL SEAL | PARAOLIO | JOINT SPI | 1 |
| 8 | PAF25-05020001 | 65W-11411-01 | CIGÜEÑAL | CRANK ASSY | ALBERO MOTORE | VILEBREQUIN | 1 |
| 9 | PAF25-05020203-1 | 62Y-11656-00 | COJINETE BIELA | BEARING, CONNECTING ROD | CUSCINETTO BIELLA | PALIER DE BIELLE | 2 |
| 9 | PAF25-05020203-2 | 62Y-11656-00 | COJINETE BIELA | BEARING, CONNECTING ROD | CUSCINETTO BIELLA | PALIER DE BIELLE | 2 |
| 10 | PAF4-04000019 | 90280-04M06 | CUÑA | KEY WOODRUFF | CHIAVETTA | CLAVETTE | 1 |
| 11 | PAF25-05020204 | 62Y-11654-00 | TORNILLO | BOLT, CONNECTING ROD | VITE | VIS | 2 |
| 12 | PAF25-05020200 | 67C-11650-00 | BIELA | CONNECTING ROD | BIELLA | BIELLE | 2 |
| 13 | PAF25-05020106 | 93450-17129 | CLIP | CIRCLIP | CLIP | CIRCLIP | 4 |
| 14 | PAF25-05020105 | 62Y-11633-00 | PIN, PISTÓN | PIN, PISTON | SPINOTTO PISTONE | AXE DE PISTON | 2 |
| 15 | PAF25-05020101 | 65W-11631-00-96 | PISTÓN | PISTON | PISTONE | PISTON | 2 |
| 16 | REC67C-11603-00 | 67C-11603-00 | KIT SEGMENTOS DE PISTÓN | PISTON RING KIT | KIT FASCIA PISTONE | KIT SEGMENTS | 2 |
| 17 | PAF25-05020100 | 65W-11631-00-96 | PISTÓN COMPLETO | PISTON ASSY | PISTONE COMPLETO | PISTON COMPLÈTE | 2 |
| 18 | PAGB/T5782-M6X125 | 97013-06035 | TORNILLO | BOLT | VITE | VIS | 4 |
| 19 | PAGB/T97.1-8 | 66M-11328-00 | ARANDELA | WASHER, PLATE | RONDELLA | RONDELLE | 4 |
| 20 | PAF25-05050400 | 65W-13300-00 | BOMBA ACEITE COMPLETA | OIL PUMP ASSY | POMPA DELL'OLIO COMPLETA | POMPE À HUILE COMPLÈTE | 1 |
| 21 | PAF25-05050014 | 93210-14515 | TÓRICA B | O-RING B | O-RING B | JOINT TORIQUE B | 1 |
| 22 | PAF25-05050013 | 93210-12MG9 | TÓRICA A | O-RING A | O-RING A | JOINT TORIQUE A | 1 |
| 23 | PAF25-05050015 | 93210-33MH2 | TÓRICA C | O-RING C | O-RING C | JOINT TORIQUE C | 1 |
| 24 | PAF25-05050200 | 65W-12171-10 | ÁRBOL DE LEVAS | CAMSHAFT ASSY | ALBERO A CAMME | ARBRE À CAMES | 1 |
| 25 | PAF25-05050016 | 93605-14143 | PIN CENTRADOR | HOLLOW PIN | SPINOTTO DI CENTRAGGIO | PIN DE CENTRAGE | 1 |
| 26 | PAF25-05050021 | 93102-37M40 | RETÉN | OIL SEAL | PARAOLIO | JOINT SPI | 1 |
| 27 | PAF25-05050017 | 65W-11537-01 | POLEA DE CORREA | BELT PULLEY, DRIVEN | PULEGGIA CINGHIA | POULIE DE COURROIE | 1 |
| 28 | PAF25-05050018 | 90201-10M06 | ARANDELA | WASHER, PLATE | RONDELLA | RONDELLE | 1 |
| 29 | PAGB/T97.1-8 | 97595-06520 | ARANDELA | WASHER, PLATE | RONDELLA | RONDELLE | 1 |
| 30 | REC65W-46241-00 | 65W-46241-00 | CORREA DISTRIBUCIÓN | BELT, TIMING | CINGHIA DISTRIBUZIONE | COURROIE DISTRIBUTION | 1 |
| 31 | PAF25-05000022 | 65W-11476-00 | MUELLE | BUSH, SPRING | MOLLA | RESSORT | 1 |
| 32 | PAF25-05000021 | 65W-11536-10 | ENGRANAJE DE DISTRIBUCIÓN | BELT PULLEY, TIMING | PULEGGIA DE DISTRIBUZIONE | POULIE DE DISTRIBUTION | 1 |
| 33 | PAF25-05050300 | 65W-12151-00 | BALANCÍN COMPLETO | ROCKET ASSY | BILANCERE COMPLETO | CULBUTEUR COMPLÈTE | 4 |
| 34 | PAF25-05050002 | 62Y-12121-00 | VÁLVULA ESCAPE | VALVE, EXHAUST | VALVOLA SCARICO | SOUPAPE D'ÉCHAPPEMENT | 2 |
| 35 | PAF25-05050001 | 67C-12111-00 | VÁLVULA ADMISIÓN | VALVE, INTAKE | VALVOLA ASPIRAZIONE | SOUPAPE D'ADMISSION | 2 |
| 36 | PAF25-05050003 | 62Y-12116-00 | ARANDELA ASIENTO | SEAT, VALVE SPRING | RONDELLA BASAMENTO | SIEGE RESSORT DE SOUPAPE | 4 |
| 37 | PAF166-010003 | 51Y-12119-00 | RETÉN DE ACEITE | OIL SEAL | PARAOLIO | JOINT D'HUILE | 4 |
| 38 | PAF25-05050005 | 51Y-12114-00 | MUELLE DE VÁLVULA | SPRING, VALVE STEM | MOLLA DI VALVOLA | RESSORT DE SOUPAPE | 4 |
| 39 | PAF15-07040006 | 30X-12117-00 | RETÉN RESORTE | SPRING, VALVE RETAINER | VALVOLA DI RITEGNO | JOINT DE RESSORT | 4 |
| 40 | PAF15-07040007 | 30X-12118-00 | SEGURO DE VÁLVULA | CLAMP, VALVE | BLOCCAGGIO DI VALVOLA | CLAVETTE DE SOUPAPE | 8 |
| 41 | PAF15-07040303 | 62Y-12159-00 | TORNILLO REGULADOR | SCREW, VALVE ADJUSTING | VITE REGOLATORE | VIS POINTEAU | 4 |
| 42 | PAF15-07040304 | 62Y-12158-00 | TUERCA | NUT | GHIERA | ÉCROU | 4 |
| 43 | PAF25-05050301 | 65W-12151-00 | BALANCÍN | VALVE ROCKER | BILANCERE | CULBUTEUR | 4 |
| 44 | PAF25-05050008 | 65W-12146-00 | EJE DE BALANCÍN | SHAFT, ROCKER | ASSE BILANCERE | AXE DE CULBUTEUR | 1 |
| 45 | PAF25-05050009 | 62Y-12238-00 | PLETINA | PLATE, BOLT STOPPER | PIASTRINA | PLAQUE | 2 |
| 46 | PAF25-05050011 | 62Y-12216-00 | RESORTE | SPRING | MOLLA | RESSORT | 1 |
| 47 | PAF25-05050012 | 62Y-12231-00 | PLETINA | PLATE B, BOLT STOPPER | PIASTRINA | PLAQUE | 1 |
| 48 | PAF25-05050019 | 90109-08M63 | TORNILLO | BOLT | VITE | VIS | 3 |

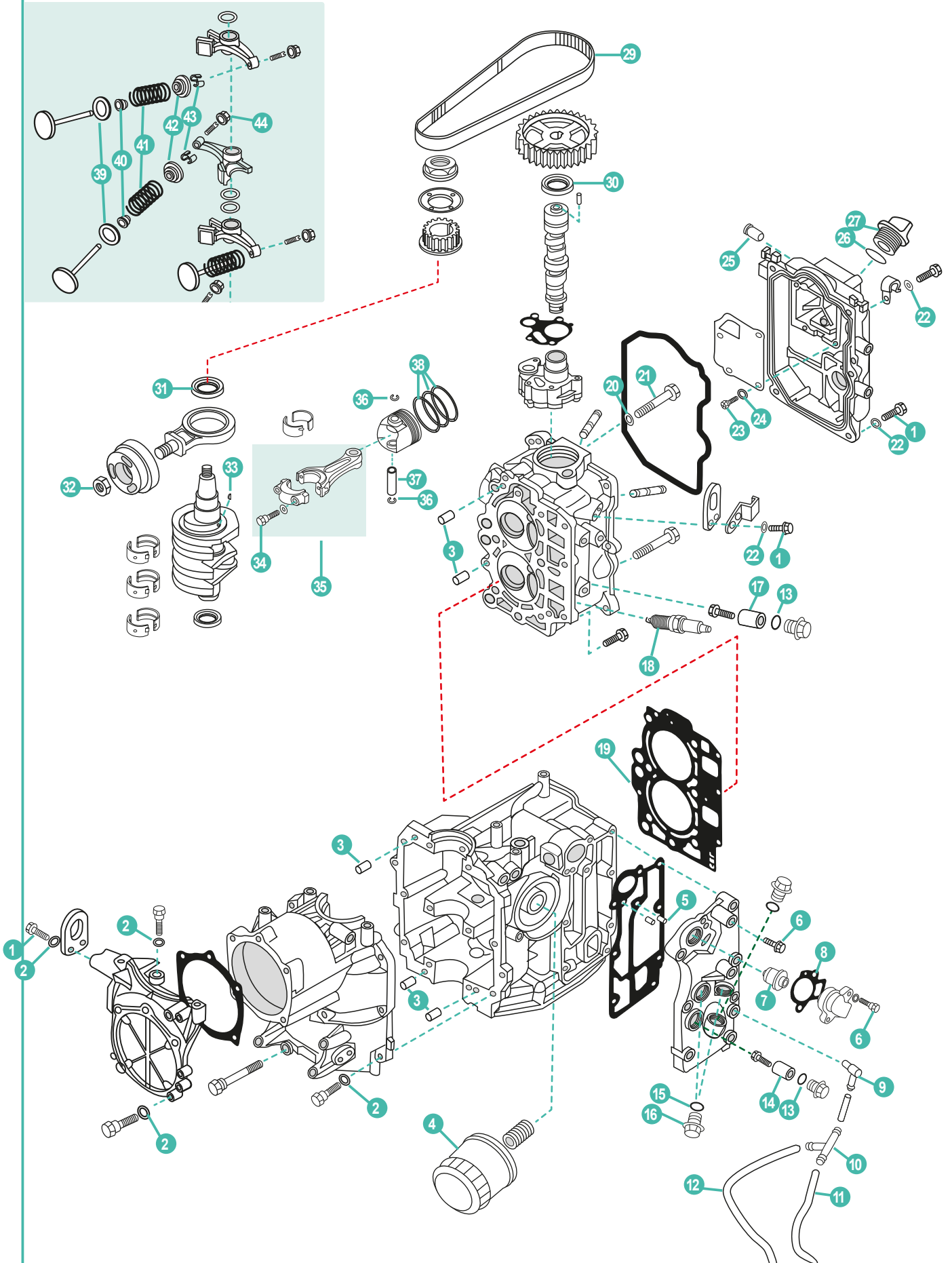

| | REF | OEM | | | | UN. | |
|----|-------------------|--------------|----------------------------|--------------------------|-------------------------------------|----------------------------------|----|
| 1 | PAGB/T5783-M6X20 | 97095-06020 | TORNILLO | SCREW | VITE | VIS | 9 |
| 2 | PAGB/T97.1-6 | 92995-06600 | ARANDELA | WASHER | RONDELLA | RONDELLE | 16 |
| 3 | REC93606-12019 | 93606-12019 | PIN CENTRADOR | HOLLOW PIN | SPINOTTO DI CENTRAGGIO | PIN DE CENTRAGE | 5 |
| 4 | REC5GH-13440-60 | 5GH-13440-20 | FILTRO ACEITE | OIL FILTER | FILTRO DELL'OLIO | FILTRE À HUILE | 1 |
| 5 | PAF25-04000007 | 93604-10M03 | PIN CENTRADOR | HOLLOW PIN | SPINOTTO DI CENTRAGGIO | PIN DE CENTRAGE | 2 |
| 6 | PAGB/T5783-M6X30 | 90119-06MA5 | TORNILLO | SCREW | VITE | VIS | 8 |
| 7 | PAF15-07000031 | 6G8-12411-03 | TERMOSTATO | THERMOSTAT | TERMOSTATO | THERMOSTAT | 1 |
| 8 | PAF15-07010022 | 62Y-12414-00 | JUNTA TAPA TERMOSTATO | GASKET, THERMOSTAT COVER | GUARNIZIONE COPERCHIO TERMOSTATO | JOINT COUVERCLE DE THERMOSTAT | 1 |
| 9 | PAF15-04000005 | 676-11372-00 | NIPLE DE MANGUERA | NIPPLE | TUBO | RACCORD D'EAU | 1 |
| 10 | PAF15-05000011 | 688-24378-00 | CONECTOR DE 3 VÍAS | THREE-WAY PIPE | CONNETTORE T | TE | 1 |
| 11 | PAF25-03000011 | 90445-09251 | TUBO DE AGUA | WATER TUBE | TUBO DELL'ACQUA | DURITE D'EAU | 1 |
| 12 | PAF25-03000009 | 90445-09104 | TUBO DE AGUA | WATER TUBE | TUBO DELL'ACQUA | DURITE D'EAU | 1 |
| 13 | PAGB/T3452.1-13X2 | 93210-13M63 | TÓRICA | O-RING | O-RING | JOINT TORIQUE | 1 |
| 14 | CM6G8-11325-00A | 6G8-11325-00 | ÁNODO | ANODE | ANODO | ANODE | 1 |
| 15 | PAF15-04000003 | 90430-14115 | TÓRICA | O-RING | O-RING | JOINT TORIQUE | 2 |
| 16 | PAF15-04000002 | 90340-14M06 | TORNILLO DRENAJE | BOLT, DISCHARGING OIL | VITE DRENAGGIO | BOUCHON DE VIDANGE | 2 |
| 17 | CM6BL-11325-00A | 6BL-11325-00 | ÁNODO | ANODE | ANODO | ANODE | 2 |
| 18 | NGKDP6EB-9 | 94702-00418 | BUJÍA | SPARK PLUG | CANDELE | BOUGIE | 2 |
| 19 | REC6BL-11181-00 | 6BL-11181-00 | JUNTA CULATA | GASKET, CYLINDER HEAD | GUARNIZIONE TESTATA | JOINT DE CULASSE | 1 |
| 20 | PAF25-05050007 | 90430-06014 | JUNTA | GASKET | GUARNIZIONE | JOINT | 1 |
| 21 | PAF25-05050006 | 90109-06M65 | PERNO | STUD | BULLONE | BOULON | 1 |
| 22 | PAGB/T96-6 | 92995-06600 | ARANDELA | WASHER | RONDELLA | RONDELLE | 8 |
| 23 | PAGB/T818-M4X10 | 98507-04010 | TORNILLO | SCREW | VITE | VIS | 4 |
| 24 | PAGB/T97.1-4 | 92907-04600 | ARANDELA | WASHER | RONDELLA | RONDELLE | 4 |
| 25 | PAF20-05040005 | 62Y-14485-00 | PIPA DE AGUA | PIPE, WATER | TUBO | RACCORD TUYAU D'EAU | 1 |
| 26 | PAJASOF40431-025 | 93210-24M79 | TÓRICA | O-RING | O-RING | JOINT TORIQUE | 1 |
| 27 | PAF15-07050004 | 6G8-15363-00 | TAPÓN ACEITE | PLUG, OIL | TAPPO OLIO | BOUCHON REMPLISSAGE D'HUILE | 1 |
| 28 | PAF15-07010015 | 90465-08M83 | BRIDA | CLAMP | FLANGIA | COLLIER | 1 |
| 29 | REC6C5-46241-00 | 6C5-46241-00 | CORREA DISTRIBUCIÓN | BELT, TIMING | CINGHIA DISTRIBUZIONE | COURROIE DISTRIBUTION | 1 |
| 30 | PAF25-05050021 | 93102-37M40 | RETÉN DE ACEITE | OIL SEAL | PARAOLIO | JOINT SPI | 1 |
| 31 | PAF25-05020003 | 93102-43M42 | RETÉN DE ACEITE | OIL SEAL | PARAOLIO | JOINT SPI | 1 |
| 32 | PAF25-05000026 | 90170-20137 | TUERCA | LOCK NUT | DADO | ÉCROU | 1 |
| 33 | PAGB/T1099-3X5X13 | 90280-03M01 | CUÑA | KEY WOODRUFF | CHIAVETTA | CLAVETTE | 1 |
| 34 | PAF25-05020204 | 6C5-11654-00 | TORNILLO | SCREW | VITE | VIS | 2 |
| 35 | PAF25-05020200 | 6C5-11650-00 | BIELA COMPELTA | ROD, CONNECTING ASSY | BIELLA COMPLETA | BIELLE COMPLÈTE | 2 |
| 36 | PAF25-05020106 | 93450-17129 | CIRCLIP | CIRCLIP | CIRCLIP | CIRCLIP | 4 |
| 37 | PAF25-05020105 | 62Y-11633-00 | PIN, PISTÓN | PIN, PISTON | SPINOTTO PISTONE | AXE DE PISTON | 2 |
| 38 | REC67C-11603-00 | 67C-11603-00 | KIT SEGMENTOS DE PISTÓN | PISTON RING KIT | KIT FASCIA PISTONE | KIT SEGMENTS | 2 |
| 39 | PAF25-05050003 | 62Y-12116-00 | ARANDELA ASIENTO | SEAT, VALVE SPRING | RONDELLA BASAMENTO | SIEGE RESSORT DE SOUPAPE | 4 |
| 40 | PA166F-010003 | 51Y-12119-00 | RETÉN DE ACEITE | OIL SEAL | PARAOLIO | JOINT D'HUILE | 4 |
| 41 | PAF25-05050005 | 51Y-12114-00 | MUELLE DE VÁLVULA | SPRING, VALVE STEM | MOLLA DI VALVOLA | RESSORT DE SOUPAPE | 4 |
| 42 | PAF15-07040006 | 30X-12117-00 | RETÉN RESORTE | SPRING, VALVE RETAINER | VALVOLA DI RITEGNO | JOINT DE RESSORT | 4 |
| 43 | PAF15-07040007 | 30X-12118-00 | SEGURO DE VÁLVULA | CLAMP, VALVE | BLOCCAGGIO DI VALVOLA | CLAVETTE DE SOUPAPE | 8 |
| 44 | PAF15-07040304 | 62Y-12158-00 | TUERCA | NUT | GHIERA | ÉCROU | 1 |



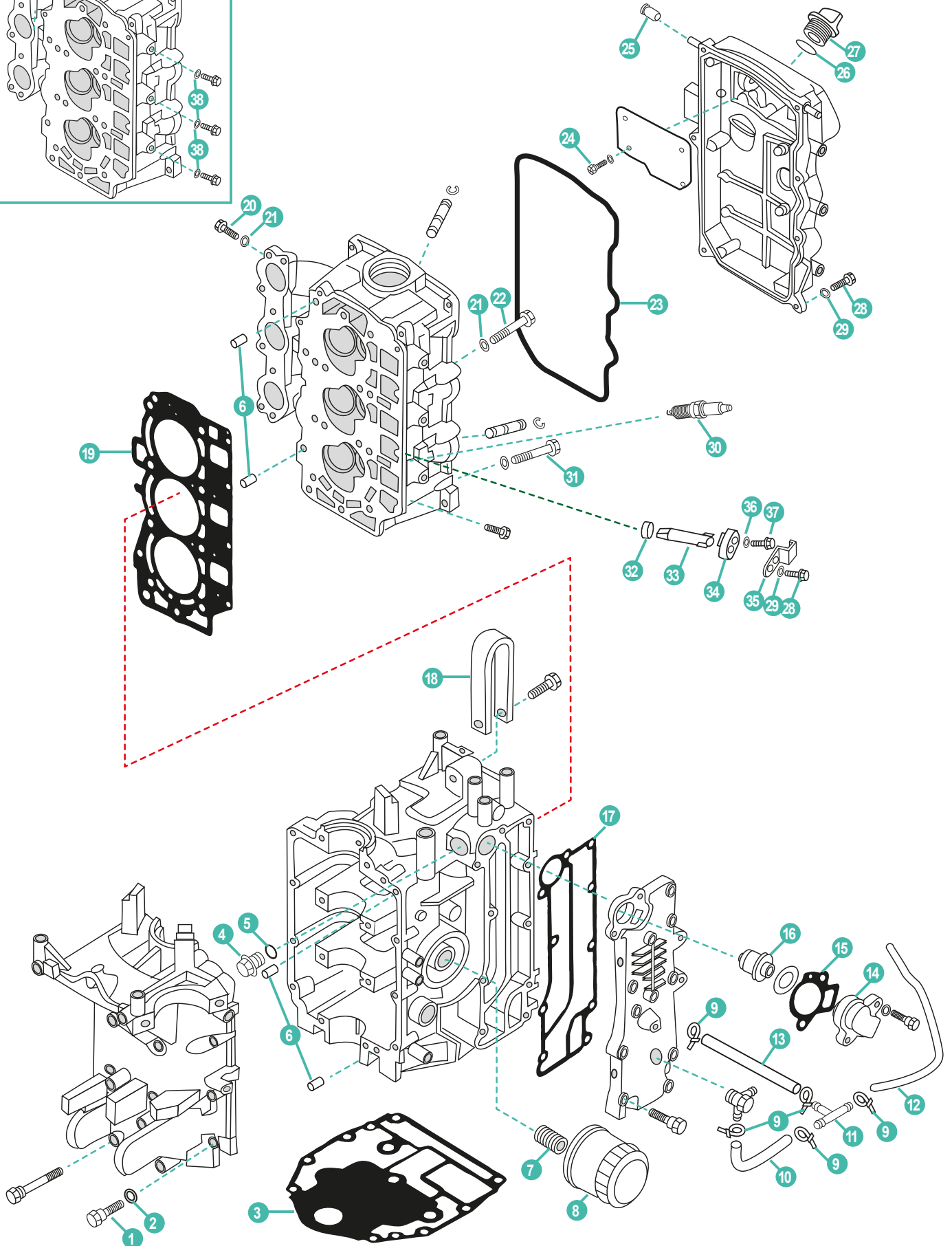
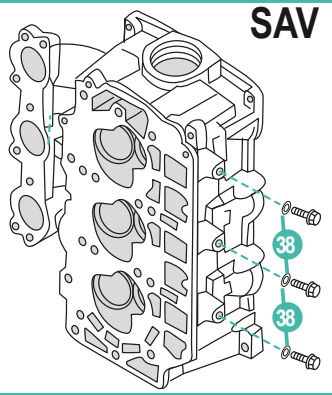

| | REF | OEM | | | | | UN. |
|----|------------------|-----------------|--------------------------------|-----------------------------|--|------------------------------------|-----|
| 1 | PAF15-07000030 | 97013-06035 | TORNILLO | STUD | BULLONE | BOULON | 8 |
| 2 | PAGB/T97.1-6 | 92903-06600 | ARANDELA | WASHER | RONDELLA | RONDELLE | 8 |
| 3 | REC67C-11351-00 | 67C-11351-01 | JUNTA BASE MOTOR | GASKET ENGINE | GUARNIZIONE BASE MOTORE | JOINT MOTEUR | 1 |
| 4 | PAF15-04000002 | 90340-14M06 | TORNILLO DRENAJE | BOLT, DISCHARGING OIL | VITE DRENAGGIO | BOUCHON DE VIDANGE | 1 |
| 5 | PAF15-04000003 | 90430-14115 | TÓRICA | O-RING | O-RING | JOINT TORIQUE | 1 |
| 6 | PAF25-00000014 | 99530-08012 | PIN CENTRADOR | HOLLOW PIN | SPINOTTO DI CENTRAGGIO | PIN DE CENTRAGE | 4 |
| 7 | PAF15-07010003 | 90401-20M00 | PERNO | STUD | BULLONE | BOULON | 1 |
| 8 | REC5GH-13440-00 | 5GH-13440-00 | FILTRO ACEITE | OIL FILTER | FILTRO DELL'OLIO | FILTRE À HUILE | 1 |
| 9 | PAHT-2.5X60 | 90465-11M10 | BRIDA | CLAMP | FLANGIA | COLLIER | 5 |
| 10 | PAF25-03000008 | 90445-09068 | TUBO DE AGUA | WATER TUBE | TUBO DELL'ACQUA | DURITE D'EAU | 1 |
| 11 | PAF15-05000011 | 688-24378-00 | CONECTOR DE 3 VÍAS | THREE-WAY PIPE | CONNETTORE T | TE | 1 |
| 12 | PAF15-05000014 | 90445-09104 | TUBO DE AGUA | WATER TUBE | TUBO DELL'ACQUA | DURITE D'EAU | 1 |
| 13 | PAF25-03000009 | 90445-09095 | TUBO DE AGUA | WATER TUBE | TUBO DELL'ACQUA | DURITE D'EAU | 1 |
| 14 | PAF15-07010021 | 6H3-12413-00-1S | TAPA TERMOSTATO | COVER, THERMOSTAT | COPERCHIO TERMOSTATO | COUVERCLE DE THERMOSTAT | 1 |
| 15 | PAF15-07010022 | 62Y-12414-00 | JUNTA TAPA TERMOSTATO | GASKET, THERMOSTAT COVER | GUARNIZIONE COPERCHIO TERMOSTATO | JOINT COUVERCLE DE THERMOSTAT | 1 |
| 16 | PAF15-07000031 | 6G8-12411-03 | TERMOSTATO | THERMOSTAT | TERMOSTATO | THERMOSTAT | 1 |
| 17 | REC67C-41114-00 | 67C-41114-10 | JUNTA EXTERIOR, TAPA DE ESCAPE | GASKET, EXHAUST OUTER COVER | GUARNIZIONE ESTERIORE, COPERCHIO SCARICO | JOINT DE COUVERCLE EXT ECHAPPEMENT | 1 |
| 18 | PAF25-05010106 | 65W-11119-00 | SOPORTE | HANGER, ENGINE | SUPPORTO | CROCHET LEVAGE MOTEUR | 1 |
| 19 | REC67C-11181-01 | 67C-11181-01 | JUNTA CULATA | GASKET, CYLINDER HEAD | GUARNIZIONE TESTATA | JOINT DE CULASSE | 1 |
| 20 | PAGB/T5783-M6X10 | 97095-06010 | TORNILLO | SCREW | VITE | VIS | 3 |
| 21 | PAF25-05050007 | 90430-06014 | JUNTA | GASKET | GUARNIZIONE | JOINT | 3 |
| 22 | PAF25-05050006 | 90109-06M65 | PERNO | STUD | BULLONE | BOULON | 1 |
| 23 | REC67C-11356-00 | 67C-11356-00 | JUNTA TAPA | GASKET, COVER | GUARNIZIONE COPERCHIO | JOINT COUVERCLE | 1 |
| 24 | PAGB/T818-M4X10 | 98507-04010 | TORNILLO | SCREW | VITE | VIS | 4 |
| 25 | PAF40-05070002 | 62Y-14485-00 | PIPA DE AGUA | PIPE, WATER | TUBO | RACCORD TUYAU D'EAU | 1 |
| 26 | PAJASOF40431-025 | 93210-24M79 | TÓRICA | O-RING | O-RING | JOINT TORIQUE | 1 |
| 27 | PAF15-07050004 | 6G8-15363-00 | TAPÓN ACEITE | PLUG, OIL | TAPPO OLIO | BOUCHON REMPLISSAGE D'HUILE | 1 |
| 28 | PAGB/T5783-M6X20 | 97095-06020 | TORNILLO | SCREW | VITE | VIS | 7 |
| 29 | PAGB/T97.1-6 | 92995-06600 | ARANDELA | WASHER | RONDELLA | RONDELLE | 7 |
| 30 | NGKDPR6EA-9 | 94701-00375 | BUJÍA | SPARK PLUG | CANDELA | BOUGIE | 3 |
| 31 | PAF25-05000002 | 90119-09M00 | TORNILLO | SCREW | VITE | VIS | 8 |
| 32 | PAF15-07010009 | 66M-11328-00 | TAPÓN | PLUG | TAPPO | BOUCHON | 3 |
| 33 | CM62Y-11325-00A | 62Y-11325-00 | ÁNODO | ANODE | ANODO | ANODE | 3 |
| 34 | PAF15-07010011 | 66M-11327-00-94 | TAPA ÁNODO | COVER, ANODE | COPERTURA ANODO | COUVERCLE D'ANODE | 3 |
| 35 | PAF15-07010012 | 66M-12535-00 | PLETINA DEL ÁNODO | PLATE, ANODE | PIASTRA ANODO | PLAQUE D'ANODE | 3 |
| 36 | PAGB/T97.1-5 | 92995-05600 | ARANDELA | WASHER | RONDELLA | RONDELLE | 3 |
| 37 | PAGB/T818-M5X12 | 97095-05012 | TORNILLO | SCREW | VITE | VIS | 3 |
| 38 | PAF4-04000006 | 90430-08143 | JUNTA | GASKET | GUARNIZIONE | JOINT | 3 |

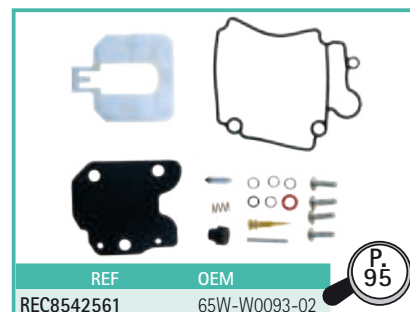
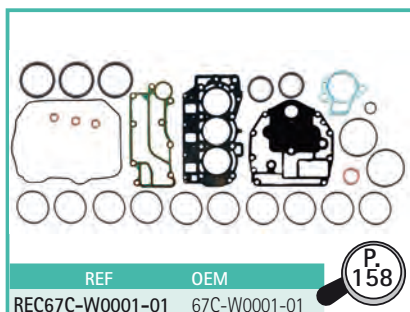

| | REF | OEM | | | | UN. | |
|----|------------------|-----------------|---------------------------|-------------------------------|---------------------------|-----------------------------|----|
| 1 | PAF25-05020003 | 93102-43M42 | RETÉN DE ACEITE | OIL SEAL | PARAOLIO | JOINT SPI | 1 |
| 2 | PAF25-05010302-1 | 62Y-11416-00 | COJINETE BANCADA BROWN | MAIN BEARING BROWN | CUSCINETTO BROWN | PALIER DE VILEBREQUIN BROWN | 8 |
| | PAF25-05010302-2 | 62Y-11416-10 | COJINETE BANCADA BLACK | MAIN BEARING BLACK | CUSCINETTO BLACK | PALIER DE VILEBREQUIN BLACK | 8 |
| 3 | PAF25-05020002 | 93102-35M47 | RETÉN DE ACEITE | OIL SEAL | PARAOLIO | JOINT SPI | 1 |
| 4 | PAF25-05000024 | 90280-04M06 | CUÑA | KEY WOODRUFF | CHIAVETTA | CLAVETTE | 1 |
| 5 | PAF25-05020204 | 62Y-11654-00 | TORNILLO | SCREW | VITE | VIS | 2 |
| 6 | PAF25-05020200 | 62Y-11650-10 | BIELA COMPLETA | ROD, CONNECTING ASSY | BIELLA COMPLETA | BIELLE COMPLÈTE | 3 |
| 7 | PAF25-05020203-1 | 62Y-11656-00 | COJINETE DE BIELA BROWN | BEARING, CONNECTING ROD BROWN | CUSCINETTO BIELLA BROWN | PALIER DE BIELLE BROWN | 6 |
| | PAF25-05020203-2 | 62Y-11656-10 | COJINETE DE BIELA BLACK | BEARING, CONNECTING ROD BLACK | CUSCINETTO BIELLA BLACK | PALIER DE BIELLE BLACK | 6 |
| 8 | PAF25-05020106 | 93450-17129 | CIRCLIP | CIRCLIP | CIRCLIP | CIRCLIP | 6 |
| 9 | PAF25-05020105 | 62Y-11633-00 | PIN, PISTÓN | PIN, PISTON | SPINOTTO PISTONE | AXE DE PISTON | 3 |
| 10 | PAF25-05020101 | 65W-11631-00-96 | PISTÓN | PISTON | PISTONE | PISTON | 3 |
| 11 | REC67C-11603-00 | 67C-11603-00 | KIT SEGMENTOS DE PISTÓN | PISTON RING KIT | KIT FASCIA PISTONE | KIT SEGMENTS | 3 |
| 12 | PAF25-05020100 | 65W-11631-00-96 | KIT PISTÓN | PISTON KIT | KIT PISTONE | KIT PISTON | 3 |
| 13 | PAF25-05050014 | 93210-14515 | TÓRICA | O-RING | O-RING | JOINT TORIQUE | 1 |
| 14 | PAF25-05050013 | 93210-12MG9 | TÓRICA | O-RING | O-RING | JOINT TORIQUE | 1 |
| 15 | PAF25-05050015 | 93210-33MH2 | TÓRICA | O-RING | O-RING | JOINT TORIQUE | 1 |
| 16 | PAF25-05000021 | 65W-11536-10 | ENGRANAJE DE DISTRIBUCIÓN | BELT PULLEY, TIMING | PULEGGIA DE DISTRIBUZIONE | POULIE DE DISTRIBUTION | 1 |
| 17 | PAF25-05000022 | 65W-11476-00 | RESORTE | SPRING | MOLLA | RESSORT | 1 |
| 18 | REC65W-46241-00 | 65W-46241-00 | CORREA DISTRIBUCIÓN | BELT, TIMING | CINGHIA DISTRIBUZIONE | COURROIE DISTRIBUTION | 1 |
| 19 | PAF25-05050018 | 90201-10M06 | ARANDELA | WASHER | RONDELLA | RONDELLE | 1 |
| 20 | PAF40-05040006 | 67C-11537-01 | POLEA DE CORREA | BELT PULLEY, DRIVEN | PULEGGIA CINGHIA | POULIE DE COURROIE | 1 |
| 21 | PAF25-05050021 | 93102-37M40 | RETÉN DE ACEITE | OIL SEAL | PARAOLIO | JOINT SPI | 1 |
| 22 | PAF25-05050016 | 93605-14143 | PIN CENTRADOR | HOLLOW PIN | SPINOTTO DI CENTRAGGIO | PIN DE CENTRAGE | 1 |
| 23 | PAF25-05050002 | 62Y-12121-00 | VÁLVULA ESCAPE | VALVE, EXHAUST | VALVOLA SCARICO | SOUPAPE D'ÉCHAPPEMENT | 3 |
| 24 | PAF25-05050001 | 67C-12111-00 | VÁLVULA ADMISIÓN | VALVE, INTAKE | VALVOLA ASPIRAZIONE | SOUPAPE D'ADMISSION | 3 |
| 25 | PAF25-05050003 | 62Y-12116-00 | ARANDELA ASIENTO | SEAT, VALVE SPRING | RONDELLA BASAMENTO | SIEGE RESSORT DE SOUPAPE | 6 |
| 26 | PAPS2700.04.03 | 51Y-12119-00 | RETÉN DE ACEITE | OIL SEAL | PARAOLIO | JOINT SPI | 6 |
| 27 | PAF25-05050005 | 51Y-12114-00 | MUELLE DE VÁLVULA | SPRING, VALVE STEM | MOLLA DI VALVOLA | RESSORT DE SOUPAPE | 6 |
| 28 | PAF15-07040006 | 30X-12117-00 | RETÉN RESORTE | SPRING, VALVE RETAINER | VALVOLA DI RITEGNO | JOINT DE RESSORT | 6 |
| 29 | PAF15-07040007 | 30X-12118-00 | SEGURO DE VÁLVULA | CLAMP, VALVE | BLOCCAGGIO DI VALVOLA | CLAVETTE DE SOUPAPE | 12 |
| 30 | PAF25-05050301 | 65W-12151-00 | BRAZO DE BALANCÍN | ARM, VALVE ROCKER | BILANCERE | CULBUTEUR | 6 |
| 31 | PAF15-07040303 | 62Y-12159-00 | TORNILLO REGULADOR | SCREW, VALVE ADJUSTING | VITE REGOLATORE | VIS POINTEAU | 6 |
| 32 | PAF15-07040304 | 62Y-12158-00 | TUERCA | LOCK NUT | DADO | ÉCROU | 6 |
| 33 | PAF25-05050019 | 90109-08M63 | TORNILLO | SCREW | VITE | VIS | 4 |
| 34 | PAF25-05050011 | 62Y-12216-00 | RESORTE | SPRING | MOLLA | RESSORT | 1 |

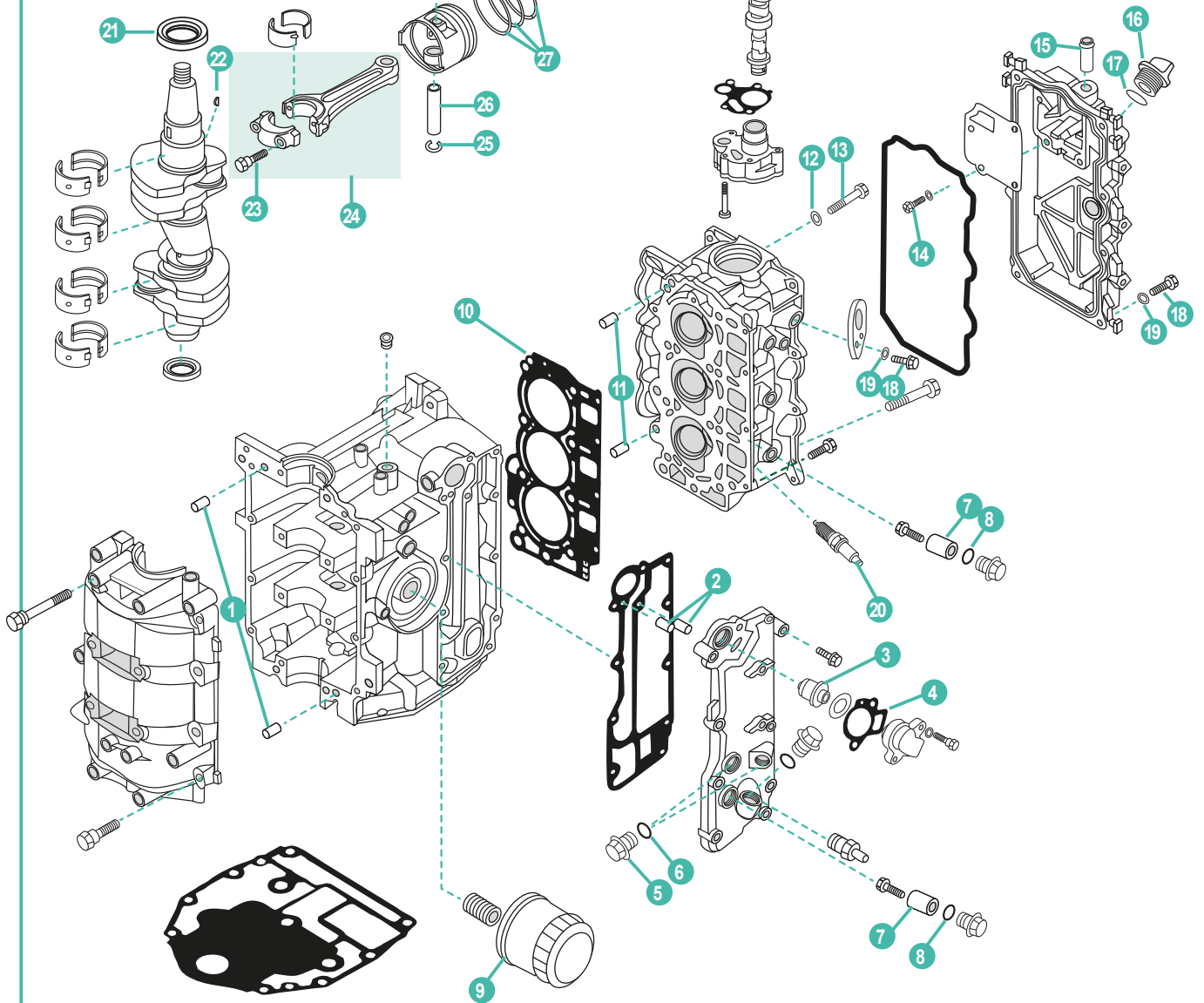
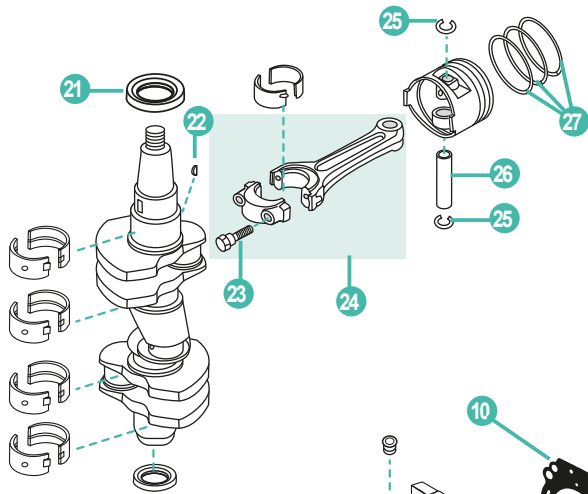
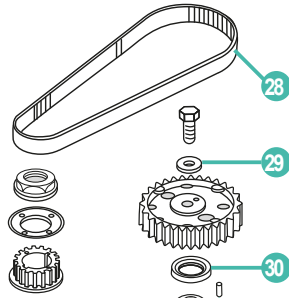
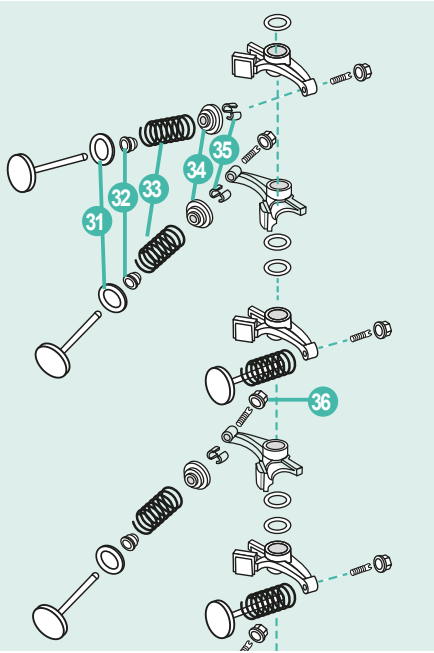

| | REF | OEM | | | | | UN. |
|----|-------------------|--------------|----------------------------|--------------------------|-------------------------------------|-----------------------------------|-----|
| 1 | REC93606-12019 | 93606-12019 | PIN CENTRADOR | HOLLOW PIN | SPINOTTO DI CENTRAGGIO | PIN DE CENTRAGE | 4 |
| 2 | PAF15-00000013 | 93604-10M03 | PIN CENTRADOR | HOLLOW PIN | SPINOTTO DI CENTRAGGIO | PIN DE CENTRAGE | 2 |
| 3 | PAF15-07000031 | 6G8-12411-03 | TERMOSTATO | THERMOSTAT | TERMOSTATO | THERMOSTAT | 1 |
| 4 | PAF15-07010022 | 62Y-12414-00 | JUNTA TAPA TERMOSTATO | GASKET, THERMOSTAT COVER | GUARNIZIONE COPERCHIO TERMOSTATO | JOINT COUVERCLE DE THERMOSTAT | 1 |
| 5 | PAF15-04000002 | 90340-14M06 | TORNILLO DRENAJE | BOLT, DISCHARGING OIL | VITE DRENAGGIO | VIS DE VIDANGE | 2 |
| 6 | PAF15-04000003 | 90430-14115 | TÓRICA | O-RING | O-RING | JOINT TORIQUE | 2 |
| 7 | CM6G8-11325-00A | 6G8-11325-00 | ÁNODO | ANODE | ANODO | ANODE | 2 |
| 8 | PAGB/T3452.1-13X2 | 93210-13M63 | TÓRICA | O-RING | O-RING | JOINT TORIQUE | 5 |
| 9 | REC5GH-13440-60 | 5GH-13440-50 | FILTRO ACEITE | OIL FILTER | FILTRO DELL'OLIO | FILTRE À HUILE | 1 |
| 10 | REC6BG-11181-00 | 6BG-11181-00 | JUNTA CULATA | GASKET, CYLINDER HEAD | GUARNIZIONE TESTATA | JOINT DE CULASSE | 1 |
| 11 | PAF25-00000014 | 99530-08012 | PIN CENTRADOR | HOLLOW PIN | SPINOTTO DI CENTRAGGIO | PIN DE CENTRAGE | 2 |
| 12 | PAF25-05050007 | 90430-06014 | JUNTA | GASKET | GUARNIZIONE | JOINT | 1 |
| 13 | PAF25-05050006 | 90109-06M65 | PERNO | STUD | BULLONE | BOULON | 1 |
| 14 | PAGB/T818-M4X10 | 98507-04010 | TORNILLO | SCREW | VITE | VIS | 4 |
| 15 | PAF40-05070002 | 62Y-14485-00 | PIPA DE AGUA | PIPE, WATER | TUBO | RACCORD TUYAU D'EAU | 1 |
| 16 | PAF15-07050004 | 6G8-15363-00 | TAPÓN ACEITE | PLUG, OIL | TAPPO OLIO | BOUCHON DE REMPLISSAGE D'HUILE | 1 |
| 17 | PAF4-04000008 | 93210-24M79 | TÓRICA | O-RING | O-RING | JOINT TORIQUE | 1 |
| 18 | PAGB/T5783-M6X20 | 97095-06020 | PERNO | STUD | BULLONE | BOULON | 9 |
| 19 | PAGB/T97.1-6 | 92995-06600 | ARANDELA | WASHER | RONDELLA | RONDELLE | 9 |
| 20 | NGKDPR6EB-9 | 94702-00418 | BUJÍA | SPARK PLUG | CANDELA | BOUGIE | 3 |
| 21 | PAF25-05020003 | 93102-43M42 | RETÉN DE ACEITE | OIL SEAL | PARAOLIO | JOINT D'HUILE | 1 |
| 22 | PAGB/T1099-3X5X13 | 90280-03017 | CUÑA | KEY WOODRUFF | CHIAVETTA | CLAVETTE | 1 |
| 23 | PAF25-05020204 | 6C5-11654-00 | TORNILLO | SCREW | VITE | VIS | 2 |
| 24 | PAF25-05020200 | 6C5-11650-10 | BIELA COMPLETA | ROD, CONNECTING ASSY | BIELLA COMPLETA | BIELLE COMPLÈTE | 3 |
| 25 | PAF25-05020106 | 93450-17129 | CIRCLIP | CIRCLIP | CIRCLIP | CIRCLIP | 6 |
| 26 | PAF25-05020105 | 62Y-11633-00 | PIN, PISTÓN | PIN, PISTON | SPINOTTO PISTONE | AXE DE PISTON | 3 |
| 27 | REC67C-11603-00 | 67C-11603-00 | KIT SEGMENTOS DE PISTÓN | PISTON RING KIT | KIT FASCIA PISTONE | KIT DE SEGMENTS | 3 |
| 28 | REC6C5-46241-00 | 6C5-46241-00 | CORREA | BELT | CINGHIA | COURROIE DISTRIBUTION | 1 |
| 29 | PAF25-05050018 | 90201-10144 | ARANDELA | WASHER | RONDELLA | RONDELLE | 1 |
| 30 | PAF25-05050021 | 93102-37M40 | RETÉN DE ACEITE | OIL SEAL | PARAOLIO | JOINT D'HUILE | 1 |
| 31 | PAF25-05050003 | 62Y-12116-00 | ARANDELA ASIENTO | SEAT, VALVE SPRING | RONDELLA BASAMENTO | SIEGE RESSORT DE SOUPAPE | 6 |
| 32 | PA166F-010003 | 51Y-12119-00 | RETÉN DE ACEITE | OIL SEAL | PARAOLIO | JOINT D'HUILE | 6 |
| 33 | PAF25-05050005 | 51Y-12114-00 | MUELLE DE VÁLVULA | SPRING, VALVE STEM | MOLLA DI VALVOLA | RESSORT DE SOUPAPE | 6 |
| 34 | PAF15-07040006 | 30X-12117-00 | RETÉN RESORTE | SPRING, VALVE RETAINER | VALVOLA DI RITEGNO | JOINT DE RESSORT | 6 |
| 35 | PAF15-07040007 | 30X-12118-00 | SEGURO DE VÁLVULA | CLAMP, VALVE | BLOCCAGGIO DI VALVOLA | CLAVETTE DE SOUPAPE | 12 |
| 36 | PAF15-07040304 | 62Y-12158-00 | TUERCA | LOCK NUT | DADO | ÉCROU | 1 |



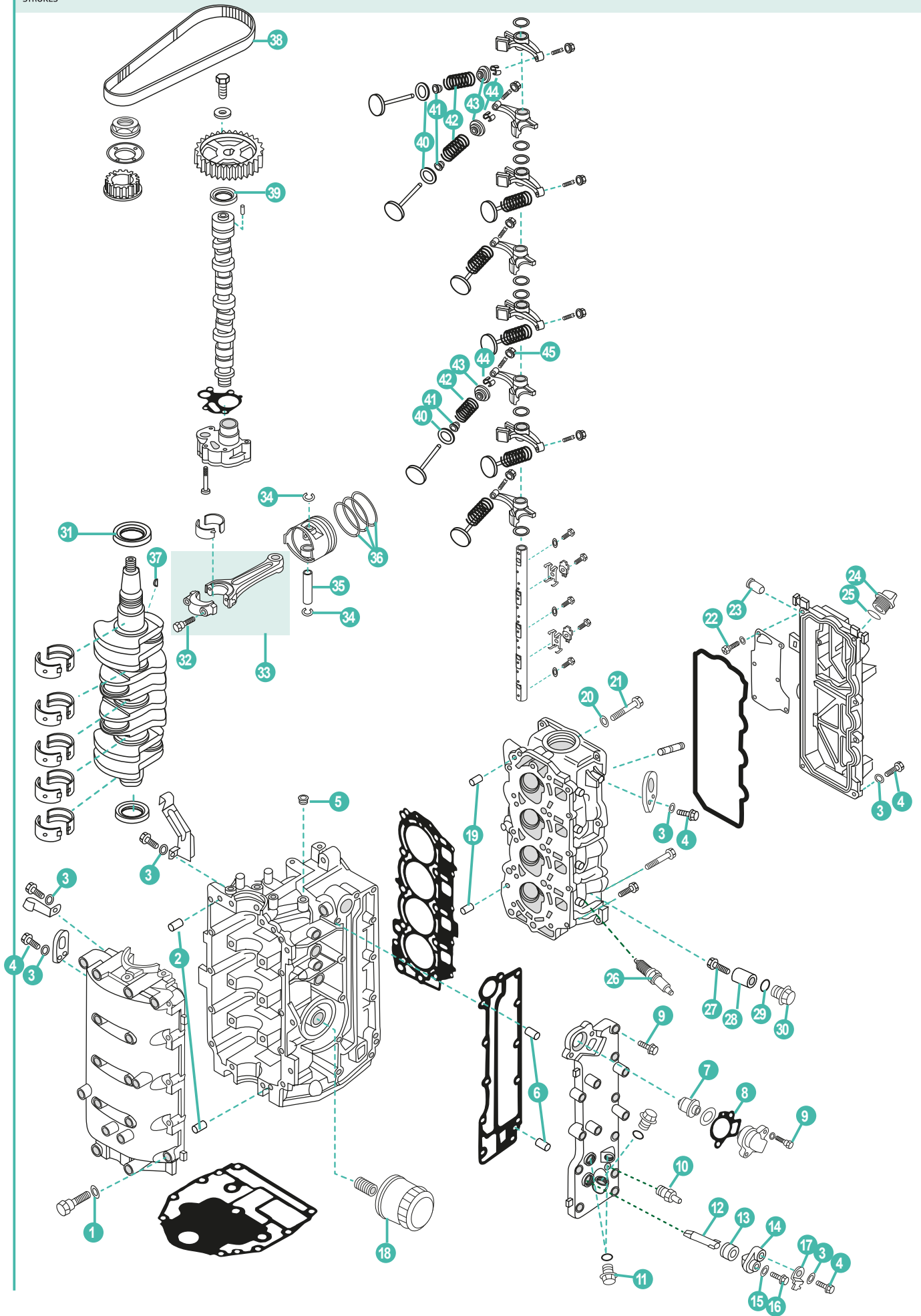

| | REF | OEM | | | | UN. | |
|----|-------------------|-----------------|----------------------------|--------------------------|-------------------------------------|----------------------------------|----|
| 1 | PAGB/T848-6 | 92903-06600 | ARANDELA | WASHER | RONDELLA | RONDELLE | 10 |
| 2 | REC93606-12019 | 93606-12019 | PIN CENTRADOR | HOLLOW PIN | SPINOTTO DI CENTRAGGIO | PIN DE CENTRAGE | 4 |
| 3 | PAGB/T97.1-6 | 92995-06600 | ARANDELA | WASHER | RONDELLA | RONDELLE | 14 |
| 4 | PAGB/T5783-M6X20 | 97095-06020 | PERNO | STUD | BULLONE | BOULON | 12 |
| 5 | PAF15-07010004 | 90344-51003 | TAPÓN | CAP | TAPPO | BOUCHON | 1 |
| 6 | PAF25-04000007 | 93604-10M03 | PIN CENTRADOR | HOLLOW PIN | SPINOTTO DI CENTRAGGIO | PIN DE CENTRAGE | 2 |
| 7 | PAF15-07000031 | 6G8-12411-03 | TERMOSTATO | THERMOSTAT | TERMOSTATO | THERMOSTAT | 1 |
| 8 | REC6H3-12414-A1 | 62Y-12414-00 | JUNTA TAPA TERMOSTATO | GASKET, THERMOSTAT COVER | GUARNIZIONE COPERCHIO TERMOSTATO | JOINT COUVERCLE DE THERMOSTAT | 1 |
| 9 | PAGB/T5782-M6X35 | 90119-06MA5 | TORNILLO | SCREW | VITE | VIS | 12 |
| 10 | PAF25-05010113 | 62Y-12481-10 | NIPLE DE MANGUERA | NIPPLE | TUBO | RACCORD D'EAU | 1 |
| 11 | PAF15-04000002 | 90340-14M06 | TORNILLO DRENAJE | BOLT, DISCHARGING OIL | VITE DRENAGGIO | VIS DE VIDANGE | 2 |
| 12 | CM62Y-11325-00A | 62Y-11325-00 | ÁNODO | ANODE | ANODO | ANODE | 1 |
| 13 | PAF15-07010009 | 66M-11328-00 | TAPÓN | CAP | TAPPO | BOUCHON | 1 |
| 14 | PAF15-07010011 | 66M-11327-00-94 | TAPA ÁNODO | COVER, ANODE | COPERTURA ANODO | COUVERCLE DU ANODE | 1 |
| 15 | PAGB/T97.1-8 | 92995-05600 | ARANDELA | WASHER | RONDELLA | RONDELLE | 1 |
| 16 | PAGB/T818-M5X12 | 97095-05012 | PERNO | STUD | BULLONE | BOULON | 1 |
| 17 | PAF15-07010012 | 66M-12535-00 | EMPAQUETADURA DE ÁNODO | PLATE, ANODE | PIASTRA ANODO | PLAQUE D'ANODE | 14 |
| 18 | REC5GH-13440-60 | 5GH-13440-20 | FILTRO ACEITE | OIL FILTER | FILTRO DELL'OLIO | FILTRE À HUILE | 1 |
| 19 | PAF25-00000014 | 99530-08012 | PIN CENTRADOR | HOLLOW PIN | SPINOTTO DI CENTRAGGIO | PIN DE CENTRAGE | 2 |
| 20 | PAF25-05050007 | 90430-06014 | JUNTA | GASKET | GUARNIZIONE | JOINT | 1 |
| 21 | PAF25-05050006 | 90109-06M65 | PERNO | STUD | BULLONE | BOULON | 1 |
| 22 | PAGB/T818-M4X10 | 98507-04010 | TORNILLO | SCREW | VITE | VIS | 6 |
| 23 | PAF40-05070002 | 62Y-14485-00 | PIPA DE AGUA | PIPE, WATER | TUBO | RACCORD TUYAU D'EAU | 1 |
| 24 | PAF15-07050004 | 6G8-15363-00 | RETÉN DE ACEITE | OIL SEAL | PARAOLIO | JOINT D'HUILE | 1 |
| 25 | PAF4-04000008 | 93210-24M79 | TÓRICA | O-RING | O-RING | JOINT TORIQUE | 1 |
| 26 | NGK DPR6EB-9 | 94702-00418 | BUJÍA | PLUG SPARK | CANDELA | BOUGIE | 4 |
| 27 | PAGB/T818-M5X25 | 97880-05025 | TORNILLO | SCREW | VITE | VIS | 4 |
| 28 | CM6G8-11325-00A | 6G8-11325-00 | ÁNODO | ANODE | ANODO | ANODE | 4 |
| 29 | PAGB/T3452.1-13X2 | 93210-13M63 | TÓRICA | O-RING | O-RING | JOINT TORIQUE | 4 |
| 30 | PAF20-05030009 | 6G8-11197-01 | TAPÓN | CAP | TAPPO | BOUCHON | 4 |
| 31 | PAF25-05020003 | 93102-43M42 | RETÉN DE ACEITE | OIL SEAL | PARAOLIO | JOINT SPI | 1 |
| 32 | PAF25-05020204 | 6C5-11654-00 | TORNILLO | SCREW | VITE | VIS | 2 |
| 33 | PAF25-05020200 | 6C5-11650-00 | BIELA COMPLETA | ROD, CONNECTING ASSY | BIELLA COMPLETA | BIELLE COMPLÈTE | 4 |
| 34 | PAF25-05020106 | 93450-17129 | CIRCLIP | CIRCLIP | CIRCLIP | CIRCLIP | 8 |
| 35 | PAF25-05020105 | 62Y-11633-00 | PIN, PISTÓN | PIN, PISTON | SPINOTTO PISTONE | AXE DE PISTON | 4 |
| 36 | REC67C-11603-00 | 67C-11603-00 | KIT SEGMENTOS DE PISTÓN | PISTON RING KIT | KIT FASCIA PISTONE | KIT DE SEGMENTS | 4 |
| 37 | PAGB/T1099-3X5X13 | 90280-03M01 | CHAVETA | KEY WOODRUFF | CHIAVETTA | CLAVETTE | 1 |
| 38 | REC6C5-46241-00 | 6C5-46241-00 | CORREA DISTRIBUCIÓN | BELT, TIMING | CINGHIA DISTRIBUZIONE | COURROIE DISTRIBUTION | 1 |
| 39 | PAF25-05050021 | 93102-37M40 | RETÉN DE ACEITE | OIL SEAL | PARAOLIO | JOINT SPI | 1 |
| 40 | PAF25-05050003 | 62Y-12116-00 | ARANDELA ASIENTO | SEAT, VALVE SPRING | RONDELLA BASAMENTO | SIEGE RESSORT DE SOUPAPE | 8 |
| 41 | PAPS2700.04.03 | 51Y-12119-00 | RETÉN DE ACEITE | OIL SEAL | PARAOLIO | JOINT SPI | 8 |
| 42 | PAF25-05050005 | 51Y-12114-00 | MUELLE DE VÁLVULA | SPRING, VALVE STEM | MOLLA DI VALVOLA | RESSORT DE SOUPAPE | 8 |
| 43 | PAF15-07040006 | 30X-12117-00 | RETÉN RESORTE | SPRING, VALVE RETAINER | VALVOLA DI RITEGNO | JOINT DE RESSORT | 8 |
| 44 | PAF15-07040007 | 30X-12118-00 | SEGURO DE VÁLVULA | CLAMP, VALVE | BLOCCAGGIO DI VALVOLA | CLAVETTE DE SOUPAPE | 16 |
| 45 | PAF15-07040304 | 62Y-12158-00 | TUERCA | LOCK NUT | DADO | ÉCROU | 1 |



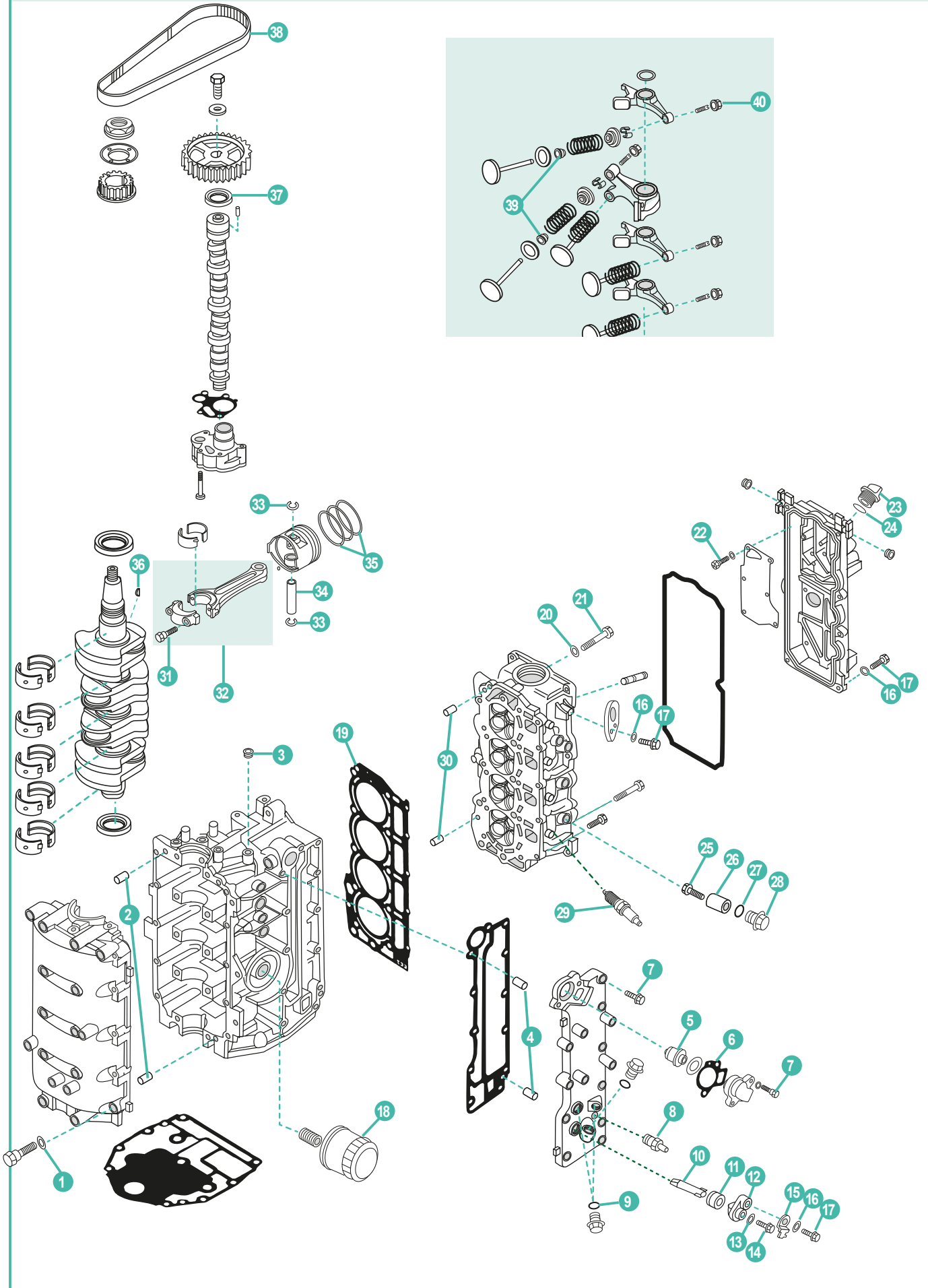

| | REF | OEM | | | | | UN. |
|----|-------------------|-----------------|----------------------------|--------------------------|-------------------------------------|----------------------------------|-----|
| 1 | PAGB/T848-6 | 92903-06600 | ARANDELA | WASHER | RONDELLA | RONDELLE | 10 |
| 2 | REC93606-12019 | 90606-12019 | PIN CENTRADOR | HOLLOW PIN | SPINOTTO DI CENTRAGGIO | PIN DE CENTRAGE | 4 |
| 3 | PAF15-07010004 | 90344-51003 | TAPÓN | CAP | TAPPO | BOUCHON | 1 |
| 4 | PAF25-04000007 | 93604-10M03 | PIN CENTRADOR | HOLLOW PIN | SPINOTTO DI CENTRAGGIO | PIN DE CENTRAGE | 2 |
| 5 | PAF15-07000031 | 6G8-12411-03 | TERMOSTATO | THERMOSTAT | TERMOSTATO | THERMOSTAT | 1 |
| 6 | REC6H3-12414-A1 | 62Y-12414-00 | JUNTA TAPA TERMOSTATO | GASKET, THERMOSTAT COVER | GUARNIZIONE COPERCHIO TERMOSTATO | JOINT COUVERCLE DE THERMOSTAT | 1 |
| 7 | PAGB/T5782-M6X35 | 90119-06MA5 | ARANDELA | WASHER | RONDELLA | RONDELLE | 12 |
| 8 | PAF25-05010113 | 62Y-12481-10 | NIPLE DE MANGUERA | NIPPLE | TUBO | RACCORD D'EAU | 1 |
| 9 | PAF15-04000002 | 90340-14M06 | TORNILLO DRENAJE | BOLT, DISCHARGING OIL | VITE DRENAGGIO | VIS DE VIDANGE | 2 |
| 10 | CM62Y-11325-00A | 62Y-11325-00 | ÁNODO | ANODE | ANODO | ANODE | 1 |
| 11 | PAF15-07010009 | 66M-11328-00 | TAPÓN | CAP | TAPPO | BOUCHON | 1 |
| 12 | PAF15-07010011 | 66M-11327-00-94 | TAPA ÁNODO | COVER, ANODE | COPERTURA ANODO | COUVERCLE DU ANODE | 1 |
| 13 | PAGB/T97.1-8 | 92995-05600 | ARANDELA | WASHER | RONDELLA | RONDELLE | 1 |
| 14 | PAGB/T818-M5X12 | 97095-05012 | PERNO | STUD | BULLONE | BOULON | 1 |
| 15 | PAF15-07010012 | 66M-12535-00 | EMPAQUETADURA DE ÁNODO | PLATE, ANODE | PIASTRA ANODO | PLAQUE D'ANODE | 1 |
| 16 | PAGB/T97.1-6 | 92995-06600 | ARANDELA | WASHER | RONDELLA | RONDELLE | 1 |
| 17 | PAGB/T5783-M6X20 | 97095-06020 | PERNO | STUD | BULLONE | BOULON | 3 |
| 18 | REC5GH-13440-60 | 5GH-13440-50 | FILTRO ACEITE | OIL FILTER | FILTRO DELL'OLIO | FILTRE À HUILE | 1 |
| 19 | REC6CJ-11181-00 | 6CJ-11181-00 | JUNTA CULATA | GASKET, CYLINDER HEAD | GUARNIZIONE TESTATA | JOINT DE CULASSE | 1 |
| 20 | PAF25-05050007 | 90430-06014 | JUNTA | GASKET | GUARNIZIONE | JOINT | 1 |
| 21 | PAF25-05050006 | 90109-06M65 | PERNO | STUD | BULLONE | BOULON | 1 |
| 22 | PAGB/T818-M4X10 | 98507-04010 | TORNILLO | SCREW | VITE | VIS | 6 |
| 23 | PAF15-07050004 | 6G8-15363-00 | TAPÓN ACEITE | PLUG, OIL | TAPPO OLIO | BOUCHON REMPLISSAGE D'HUILE | 1 |
| 24 | PAF4-04000008 | 93210-24M79 | TÓRICA | O-RING | O-RING | JOINT TORIQUE | 1 |
| 25 | PAGB/T818-M5X25 | 97880-05025 | TORNILLO | SCREW | VITE | VIS | 3 |
| 26 | CM6G8-11325-00A | 6G8-11325-00 | ÁNODO | ANODE | ANODO | ANODE | 3 |
| 27 | PAGB/T3452.1-13X2 | 93210-13M63 | TÓRICA | O-RING | O-RING | JOINT TORIQUE | 3 |
| 28 | PAF20-05030009 | 6G8-11197-01 | TAPÓN | CAP | TAPPO | BOUCHON | 3 |
| 29 | NGKLR7E | 94702-00429 | BUJÍA | SPARK PLUG | CANDELA | BOUGIE | 4 |
| 30 | PAF25-00000014 | 99530-08012 | PIN CENTRADOR | HOLLOW PIN | SPINOTTO DI CENTRAGGIO | PIN DE CENTRAGE | 2 |
| 31 | PAF25-05020204 | 6C5-11654-00 | TORNILLO | SCREW | VITE | VIS | 2 |
| 32 | PAF25-05020200 | 6C5-11650-10 | BIELA COMPLETA | ROD, CONNECTING ASSY | BIELLA COMPLETA | BIELLE COMPLÈTE | 4 |
| 33 | PAF25-05020106 | 93450-17129 | CIRCLIP | CIRCLIP | CIRCLIP | CIRCLIP | 8 |
| 34 | PAF25-05020105 | 62Y-11633-00 | PIN, PISTÓN | PIN, PISTON | SPINOTTO PISTONE | AXE DE PISTON | 4 |
| 35 | REC67C-11603-00 | 67C-11603-00 | KIT SEGMENTOS DE PISTÓN | PISTON RING KIT | KIT FASCIA PISTONE | KIT DE SEGMENTS | 4 |
| 36 | PAGB/T1099-3X5X13 | 90280-03M01 | CHAVETA | KEY WOODRUFF | CHIAVETTA | CLAVETTE | 1 |
| 37 | PAF25-05050021 | 93102-37M40 | RETÉN DE ACEITE | OIL SEAL | PARAOLIO | JOINT SPI | 1 |
| 38 | REC6C5-46241-00 | 6C5-46241-00 | CORREA DISTRIBUCIÓN | BELT, TIMING | CINGHIA DISTRIBUZIONE | COURROIE DISTRIBUTION | 1 |
| 39 | PAPS2700.04.03 | 51Y-12119-00 | RETÉN DE ACEITE | OIL SEAL | PARAOLIO | JOINT SPI | 16 |
| 40 | PAF15-07040304 | 62Y-12158-00 | TUERCA | LOCK NUT | DADO | ÉCROU | 8 |



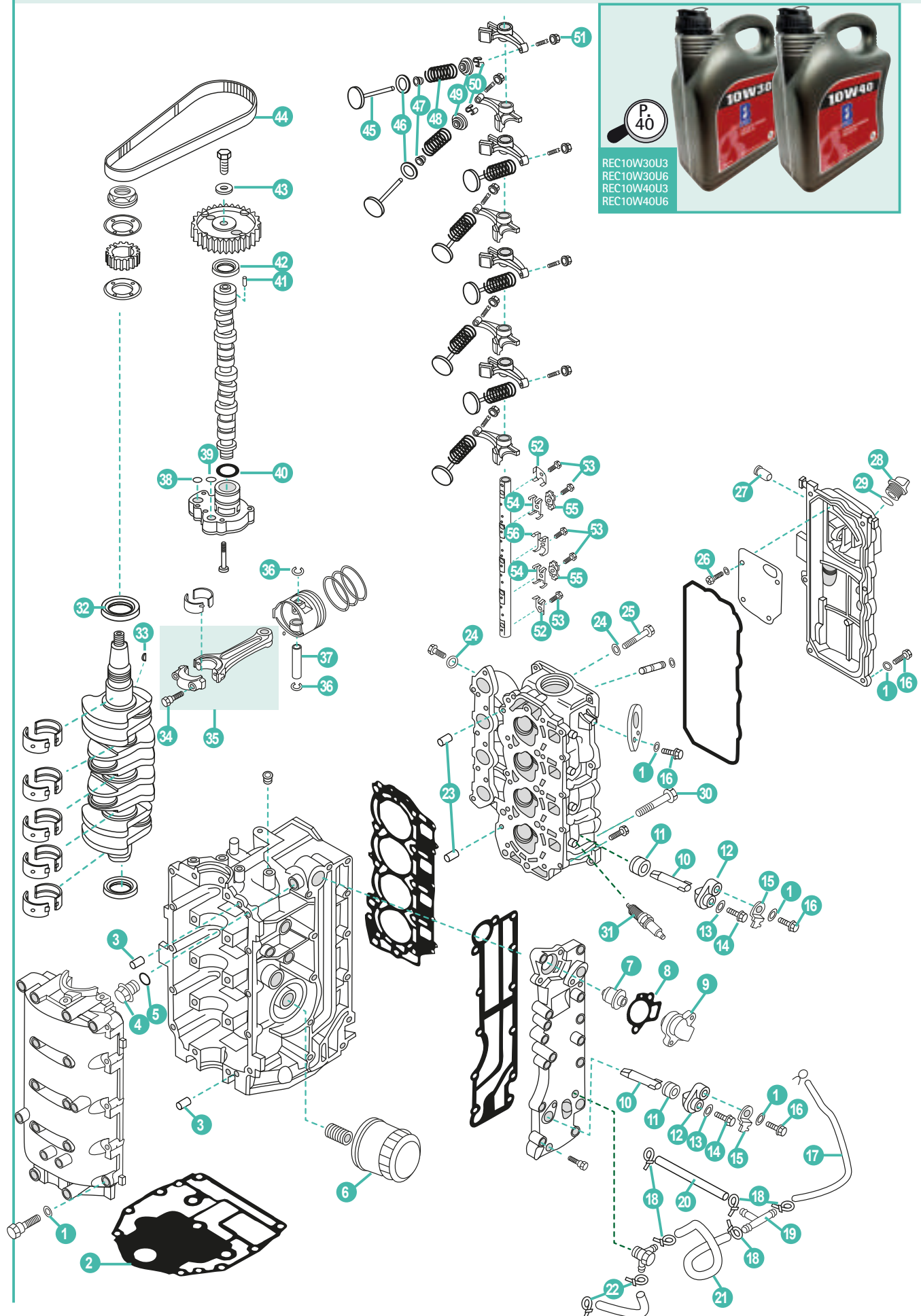

| | REF | OEM | | | | | UN. |
|----|------------------|-----------------|-------------------------|-----------------------------|----------------------------------|-------------------------------|-----|
| 1 | PAGB/T97.1-6 | 92903-06600 | ARANDELA | WASHER | RONDELLA | RONDELLE | 22 |
| 2 | REC67C-11351-00 | 67C-11351-01 | JUNTA BASE MOTOR | GASKET ENGINE | GUARNIZIONE BASE MOTORE | JOINT MOTEUR | 1 |
| 3 | REC93606-12019 | 93606-12019 | PIN CENTRADOR | HOLLOW PIN | SPINOTTO DI CENTRAGGIO | PIN DE CENTRAGE | 4 |
| 4 | PAF15-04000002 | 90340-14M06 | TORNILLO DRENAJE | BOLT, DISCHARGING OIL | VITE DRENAGGIO | VIS DE VIDANGE | 1 |
| 5 | PAF15-04000003 | 90430-14115 | TÓRICA | O-RING | O-RING | JOINT TORIQUE | 1 |
| 6 | REC5GH-13440-00 | 5GH-13440-10 | FILTRO ACEITE | OIL FILTER | FILTRO DELL'OLIO | FILTRE À HUILE | 1 |
| 7 | PAF15-07000031 | 6G8-12411-03 | TÓRICA | O-RING | O-RING | JOINT TORIQUE | 1 |
| 8 | REC6H3-12414-A1 | 62Y-12414-00 | JUNTA TAPA TERMOSTATO | GASKET, THERMOSTAT COVER | GUARNIZIONE COPERCHIO TERMOSTATO | JOINT COUVERCLE DE THERMOSTAT | 1 |
| 9 | PAF15-07010021 | 6H3-12413-00-1S | TAPA TERMOSTATO | COVER, THERMOSTAT | COPERCHIO TERMOSTATO | COUVERCLE DE THERMOSTAT | 1 |
| 10 | CM62Y-11325-00A | 62Y-11325-00 | ÁNODO | ANODE | ANODO | ANODE | 2 |
| 11 | PAF15-07010009 | 66M-11328-00 | TAPÓN | CAP | TAPPO | BOUCHON | 2 |
| 12 | PAF15-07010011 | 66M-11327-00-94 | TAPA ÁNODO | COVER, ANODE | COPERTURA ANODO | COUVERCLE DU ANODE | 2 |
| 13 | PAGB/T97.1-5 | 92995-05600 | ARANDELA | WASHER | RONDELLA | RONDELLE | 1 |
| 14 | PAGB/T818-M5X12 | 97095-05012 | PERNO | STUD | BULLONE | BOULON | 1 |
| 15 | PAF15-07010012 | 66M-12535-00 | EMPAQUETADORA DE ÁNODO | PLATE, ANODE | PIASTRA ANODO | PLAQUE D'ANODE | 1 |
| 16 | PAGB/T5783-M6X20 | 97095-06020 | PERNO | STUD | BULLONE | BOULON | 12 |
| 17 | PAF15-05000014 | 90445-09104 | TUBO DE AGUA | WATER TUBE | TUBO DELL'ACQUA | DURITE D'EAU | 1 |
| 18 | PAHT-2.5X60 | 90465-11M10 | BRIDA | CLAMP | FLANGIA | COLLIER | 5 |
| 19 | PAF15-05000011 | 688-24378-00 | CONECTOR DE 3 VÍAS | THREE-WAY PIPE | CONNETTORE T | TE | 1 |
| 20 | PAF25-03000009 | 90445-09095 | TUBO DE AGUA | WATER TUBE | TUBO DELL'ACQUA | DURITE D'EAU | 1 |
| 21 | PAF25-03000008 | 90445-09068 | TUBO DE AGUA | WATER TUBE | TUBO DELL'ACQUA | DURITE D'EAU | 1 |
| 22 | PAHT-2.5X60 | 90465-11M10 | BRIDA | CLAMP | FLANGIA | COLLIER | 2 |
| 23 | PAF25-00000014 | 99530-08012 | PIN CENTRADOR | HOLLOW PIN | SPINOTTO DI CENTRAGGIO | PIN DE CENTRAGE | 2 |
| 24 | PAF25-05050007 | 90430-06014 | JUNTA | GASKET | GUARNIZIONE | JOINT | 5 |
| 25 | PAF25-05050006 | 90109-06M65 | TORNILLO | SCREW | VITE | VIS | 1 |
| 26 | PAGB/T818-M4X10 | 98507-04010 | TORNILLO | SCREW | VITE | VIS | 4 |
| 27 | PAF40-05070002 | 62Y-14485-00 | PIPA DE AGUA | PIPE, WATER | TUBO | RACCORD TUYAU D'EAU | 1 |
| 28 | PAF15-07050004 | 6G8-15363-00 | TAPÓN ACEITE | PLUG, OIL | TAPPO OLIO | BOUCHON REMPLISSAGE D'HUILE | 1 |
| 29 | PAJASOF40431-025 | 93210-24M79 | TÓRICA | O-RING | O-RING | JOINT TORIQUE | 1 |
| 30 | PAF25-05000002 | 90119-09M00 | TORNILLO CON ARANDELA | BOLT, FLANGE | VITE CON RONDELLA | VIS DE BRIDE | 10 |
| 31 | NGKDPR6EA-9 | 94701-00375 | BUJÍA | SPARK PLUG | CANDELA | BOUGIE | 4 |
| 32 | PAF25-05020003 | 93102-43M42 | RETÉN DE ACEITE | OIL SEAL | PARAOLIO | JOINT SPI | 1 |
| 33 | PAF4-04000019 | 90280-04M06 | CUÑA | KEY WOODRUFF | CHIAVETTA | CLAVETTE | 1 |
| 34 | PAF25-05020204 | 6C5-11654-00 | TORNILLO | SCREW | VITE | VIS | 2 |
| 35 | PAF25-05020200 | 6C5-11650-00 | BIELA COMPLETA | ROD, CONNECTING ASSY | BIELLA COMPLETA | BIELLE COMPLÈTE | 4 |
| 36 | PAF25-05020106 | 93450-17129 | CIRCLIP | CIRCLIP | CIRCLIP | CIRCLIP | 8 |
| 37 | PAF25-05020105 | 62Y-11633-00 | PIN, PISTÓN | PIN, PISTON | SPINOTTO PISTONE | AXE DE PISTON | 4 |
| 38 | PAF25-05050014 | 93210-14515 | PISTÓN, CONTRA | PISTON, BALANCE | PISTONE, CONTRO | PISTON D'EQUILIBRAGE | 1 |
| 39 | PAF25-05050013 | 93210-12MG9 | TÓRICA | O-RING | O-RING | JOINT TORIQUE | 1 |
| 40 | PAF25-05050015 | 93210-33MH2 | TÓRICA | O-RING | O-RING | JOINT TORIQUE | 1 |
| 41 | PAF25-05050016 | 93605-14143 | PIN CENTRADOR | HOLLOW PIN | SPINOTTO DI CENTRAGGIO | PIN DE CENTRAGE | 1 |
| 42 | PAF25-05050021 | 93102-37M40 | RETÉN DE ACEITE | OIL SEAL | PARAOLIO | JOINT SPI | 1 |
| 43 | PAF25-05050018 | 90201-10M06 | ARANDELA | WASHER | RONDELLA | RONDELLE | 1 |
| 44 | REC62Y-46241-00 | 62Y-46241-00 | CORREA DISTRIBUCIÓN | BELT, TIMING | CINGHIA DISTRIBUZIONE | COURROIE DISTRIBUTION | 1 |
| 45 | PAF25-05050002 | 62Y-12121-00 | VÁLVULA ESCAPE | VALVE, EXHAUST | VALVOLA SCARICO | SOUPAPE D'ÉCHAPPEMENT | 4 |
| 46 | PAF25-05050003 | 62Y-12116-00 | ARANDELA ASIENTO | SEAT, VALVE SPRING | RONDELLA BASAMENTO | SIEGE RESSORT DE SOUPAPE | 8 |
| 47 | PAPS2700.04.03 | 51Y-12119-00 | RETÉN DE ACEITE | OIL SEAL | PARAOLIO | JOINT SPI | 8 |
| 48 | PAF25-05050005 | 51Y-12114-00 | MUELLE DE VÁLVULA | SPRING, VALVE STEM | MOLLA DI VALVOLA | RESSORT DE SOUPAPE | 8 |
| 49 | PAF15-07040006 | 30X-12117-00 | RETÉN RESORTE | SPRING, VALVE RETAINER | VALVOLA DI RITEGNO | JOINT DE RESSORT | 8 |
| 50 | PAF15-07040007 | 30X-12118-00 | SEGURO DE VÁLVULA | CLAMP, VALVE | BLOCCAGGIO DI VALVOLA | CLAVETTE DE SOUPAPE | 16 |
| 51 | PAF15-07040304 | 62Y-12158-00 | TUERCA | LOCK NUT | DADO | ÉCROU | 8 |
| 52 | PAF25-05050009 | 62Y-12238-00 | PLACA TOPE DE PERNO | PLATE, BOLT STOPPER | PIASTRA DE VITE | PLAQUE DE FIXATION | 2 |
| 53 | PAF25-05050019 | 90109-08M63 | TORNILLO | SCREW | VITE | VIS | 5 |
| 54 | PAF25-05050011 | 62Y-12216-00 | RESORTE | SPRING | MOLLA | RESSORT | 14 |
| 55 | PAF25-05050012 | 62Y-12231-00 | TOPE DE GUÍA | PLATE, BOLT STOPPER | PIASTRA DE GUIDA | PLAQUE DE FIXATION | 2 |
| 56 | PAF40-05040003 | 62Y-12279-00 | PLACA EJE DE BALANCINES | FIXED PLATE B, ROCKER SHAFT | PIASTRA, ASSE BILANCERE | PLAQUE ARBRE DE CULBUTEUR | 1 |

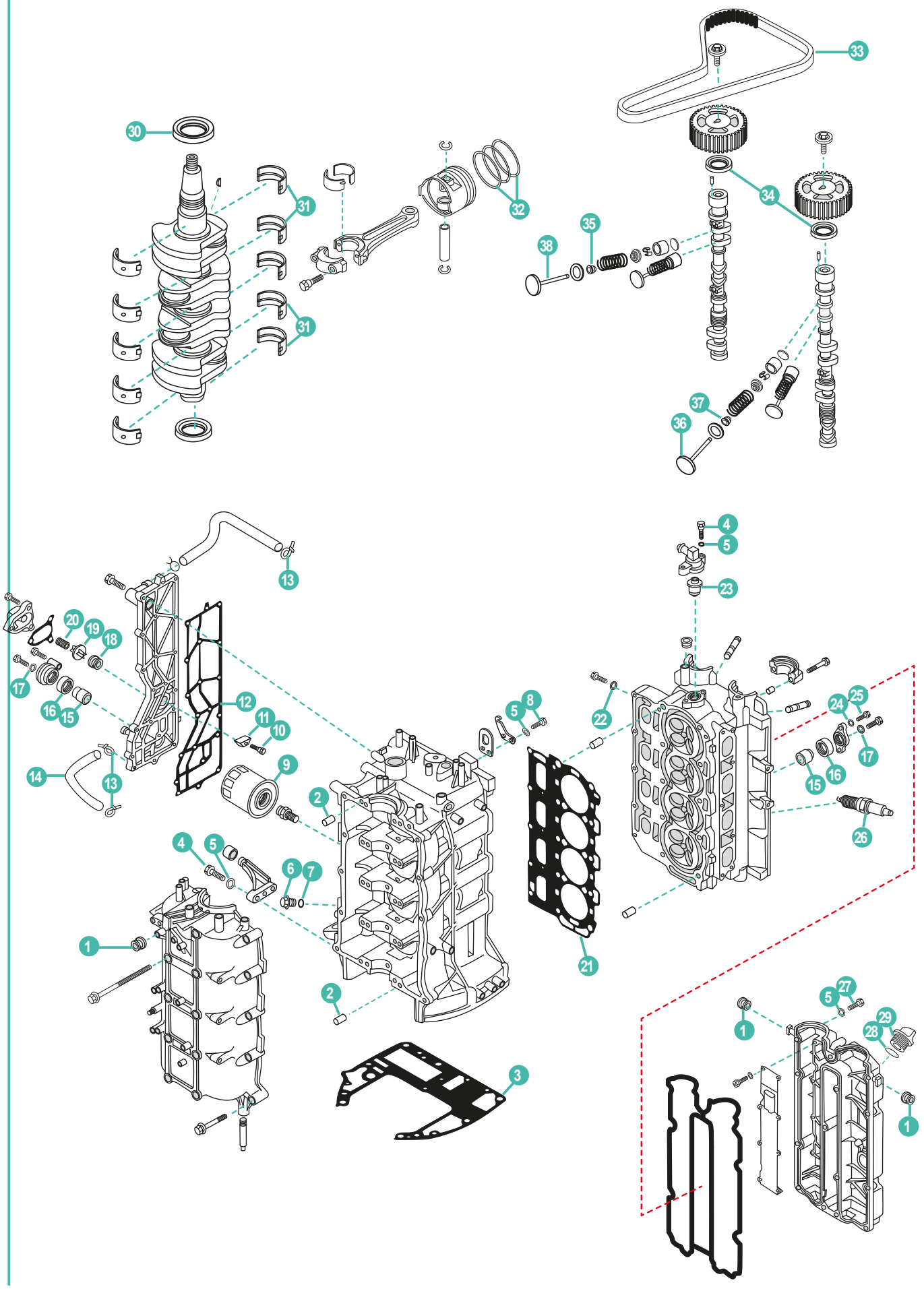

| | REF | OEM | | | | UN. | |
|----|------------------|--------------|------------------------------------|----------------------------|-------------------------------|-----------------------------|----|
| 1 | PAF15-07010027 | 90480-12072 | TAPÓN | CAP | TAPPO | BOUCHON | 3 |
| 2 | REC93606-12019 | 93606-12019 | PIN CENTRADOR | HOLLOW PIN | SPINOTTO DI CENTRAGGIO | PIN DE CENTRAGE | 24 |
| 3 | REC68V-11351-00 | 68V-11351-00 | JUNTA BASE MOTOR | GASKET ENGINE | GUARNIZIONE BASE MOTORE | JOINT MOTEUR | 1 |
| 4 | PAGB/T5782-M6X25 | 97095-06025 | TORNILLO | SCREW | VITE | VIS | 6 |
| 5 | PAGB/T97.1-6 | 92995-06600 | ARANDELA | WASHER | RONDELLA | RONDELLE | 24 |
| 6 | PAF15-04000002 | 90340-14M06 | TORNILLO DRENAJE | BOLT, DISCHARGING OIL | VITE DRENAGGIO | VIS DE VIDANGE | 1 |
| 7 | PAF15-04000003 | 90430-14115 | TÓRICA | O-RING | O-RING | JOINT TORIQUE | 1 |
| 8 | PAGB/T5783-M6X20 | 97095-06020 | TORNILLO | SCREW | VITE | VIS | 4 |
| 9 | REC5GH-13440-00 | 5GH-13440-00 | FILTRO ACEITE | OIL FILTER | FILTRO DELL'OLIO | FILTRE À HUILE | 1 |
| 10 | PAGB/T820-M4X12 | 98780-04016 | TORNILLO | SCREW | VITE | VIS | 3 |
| 11 | CM15026A | 6E5-11325-00 | ÁNODO | ANODE | ANODO | ANODE | 3 |
| 12 | REC67F-41114-A2 | 6D8-41114-A0 | JUNTA | GASKET | GUARNIZIONE | JOINT | 1 |
| 13 | PAHT-2.5X60 | 90465-11M10 | BRIDA | CLAMP | FLANGIA | COLLIER | 3 |
| 14 | PAF40-05000053 | 90445-10M40 | TUBO | TUBE | TUBO | DURITE | 1 |
| 15 | CM68V-11325-01A | 68V-11325-02 | ÁNODO | ANODE | ANODO | ANODE | 2 |
| 16 | REC67F-11328-00 | 67F-11328-00 | TAPÓN | CAP | TAPPO | BOUCHON | 2 |
| 17 | REC90430-06M03 | 90430-06M03 | JUNTA | GASKET | GUARNIZIONE | JOINT | 2 |
| 18 | REC90480-20M05 | 90480-20M05 | TAPÓN | CAP | TAPPO | BOUCHON | 1 |
| 19 | REC60H-12416-00 | 6G5-12416-00 | VÁLVULA CONTROL DE PRESIÓN | VALVE, PRESSURE CONTROL | VALVOLA ANTIPRESSIONE | SOUPAPE DE DEPRESSION | 1 |
| 20 | REC90501-16M11 | 90501-16M11 | RESORTE | SPRING | MOLLA | RESSORT | 1 |
| 21 | REC67F-11181-03 | 67F-11181-02 | JUNTA CULATA | GASKET, CYLINDER HEAD | GUARNIZIONE TESTATA | JOINT DE CULASSE | 1 |
| 22 | PAF4-04000006 | 90430-08143 | JUNTA | GASKET | GUARNIZIONE | JOINT | 4 |
| 23 | REC67F-12411-01 | 67F-12411-01 | TERMOSTATO | THERMOSTAT | TERMOSTATO | THERMOSTAT | 1 |
| 24 | PAGB/T97.1-8 | 92995-08600 | ARANDELA | WASHER | RONDELLA | RONDELLE | 4 |
| 25 | PAGB/T5783-M8X25 | 97075-08025 | PERNO | STUD | BULLONE | BOULON | 4 |
| 26 | NGKLF5A-11 | 94702-00391 | BUJÍA | SPARK PLUG | CANDELA | BOUGIE | 4 |
| 27 | REC90101-06M56 | 97095-06030 | TORNILLO | SCREW | VITE | VIS | 14 |
| 28 | PAJASOF40431-025 | 93210-24M79 | TÓRICA | O-RING | O-RING | JOINT TORIQUE | 1 |
| 29 | PAF15-07050004 | 6G8-15363-00 | TAPÓN ACEITE | PLUG, OIL | TAPPO OLIO | BOUCHON REMPLISSAGE D'HUILE | 1 |
| 30 | REC93102-48009 | 93102-48009 | RETÉN DE ACEITE | OIL SEAL | PARAOLIO | JOINT SPI | 1 |
| 31 | REC67F-11416-00 | 67F11416-00 | COJINETE PLANO 1 VERDE | MAIN BEARING 1 GREEN | CUSCINETTO 1 VERDE | PALIER 1 VERT | 4 |
| | REC67F-11416-10 | 67F11416-10 | COJINETE PLANO 1 AZUL | MAIN BEARING 1 BLJE | CUSCINETTO 1 BLJE | PALIER 1 BLEU | 4 |
| | REC67F-11416-20 | 67F11416-20 | COJINETE PLANO 1 ROJO | MAIN BERING 1 RED | CUSCINETTO 1 ROSSO | PALIER 1 ROUGE | 4 |
| 32 | REC6D8-11603-10 | 6D8-11603-01 | KIT SEGMENTOS DE PISTÓN 200-300 | PISTON RING KIT 200-300 | KIT FASCIA PISTONE 200-300 | KIT DE SEGMENTS 200-300 | 4 |
| | REC6D8-11604-10 | 6D8-11604-01 | KIT SEGMENTOS DE PISTÓN 0.25mm O/S | PISTON RING KIT 0.25mm O/S | KIT FASCIA PISTONE 0.25mm O/S | KIT DE SEGMENTS 0.25 mm O/S | 4 |
| 33 | REC67F-46241-00 | 67F-46241-00 | CORREA | BELT | CINGHIA | COURROIE DISTRIBUTION | 1 |
| 34 | REC93102-38008 | 93102-38M59 | RETÉN DE ACEITE | OIL SEAL | PARAOLIO | JOINT SPI | 2 |
| 35 | RECK0A-A3722-00 | K0A-A3722-00 | RETÉN DE ACEITE | OIL SEAL | PARAOLIO | JOINT SPI | 8 |
| 36 | REC68V-12111-00 | 68V-12111-00 | VÁLVULA ADMISIÓN | VALVE, INTAKE | VALVOLA ASPIRAZIONE | SOUPAPE D ADMISSION | 8 |
| 37 | RECK0A-A3721-00 | K0A-A3721-00 | RETÉN DE ACEITE | OIL SEAL | PARAOLIO | JOINT SPI | 8 |

4T F80B/C, F100/B/D, F115A

| | REF | OEM | | | | UN. | |
|----|-----------------|--------------|---------------------------------|-----------------------------|---------------------------------|------------------------------------|---|
| 36 | REC6D8-12111-00 | 6D8-12111-00 | VÁLVULA DE ADMISIÓN Ø96,75mm | VALVE, INTAKE Ø96,75mm | VALVOLA ASPIRAZIONE Ø96,75mm | SOUPAPE D ADMISSION Ø96,75mm | 8 |
| 38 | REC6D8-12121-10 | 6D8-12121-10 | VÁLVULA DE ESCAPE Ø98,95 mm | VALVE, EXHAUST Ø98,95 mm | VALVOLA SCARICO Ø98,95 mm | SOUPAPE D'ECHAPPEMENT Ø98,95 mm | 8 |

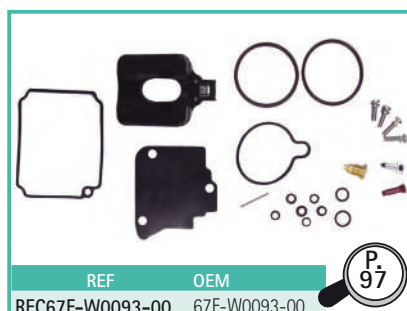
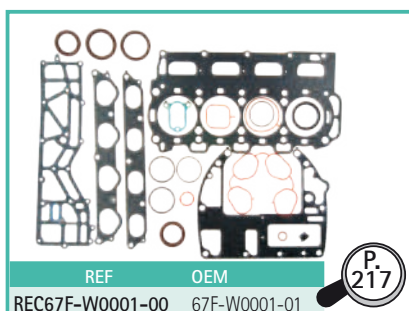

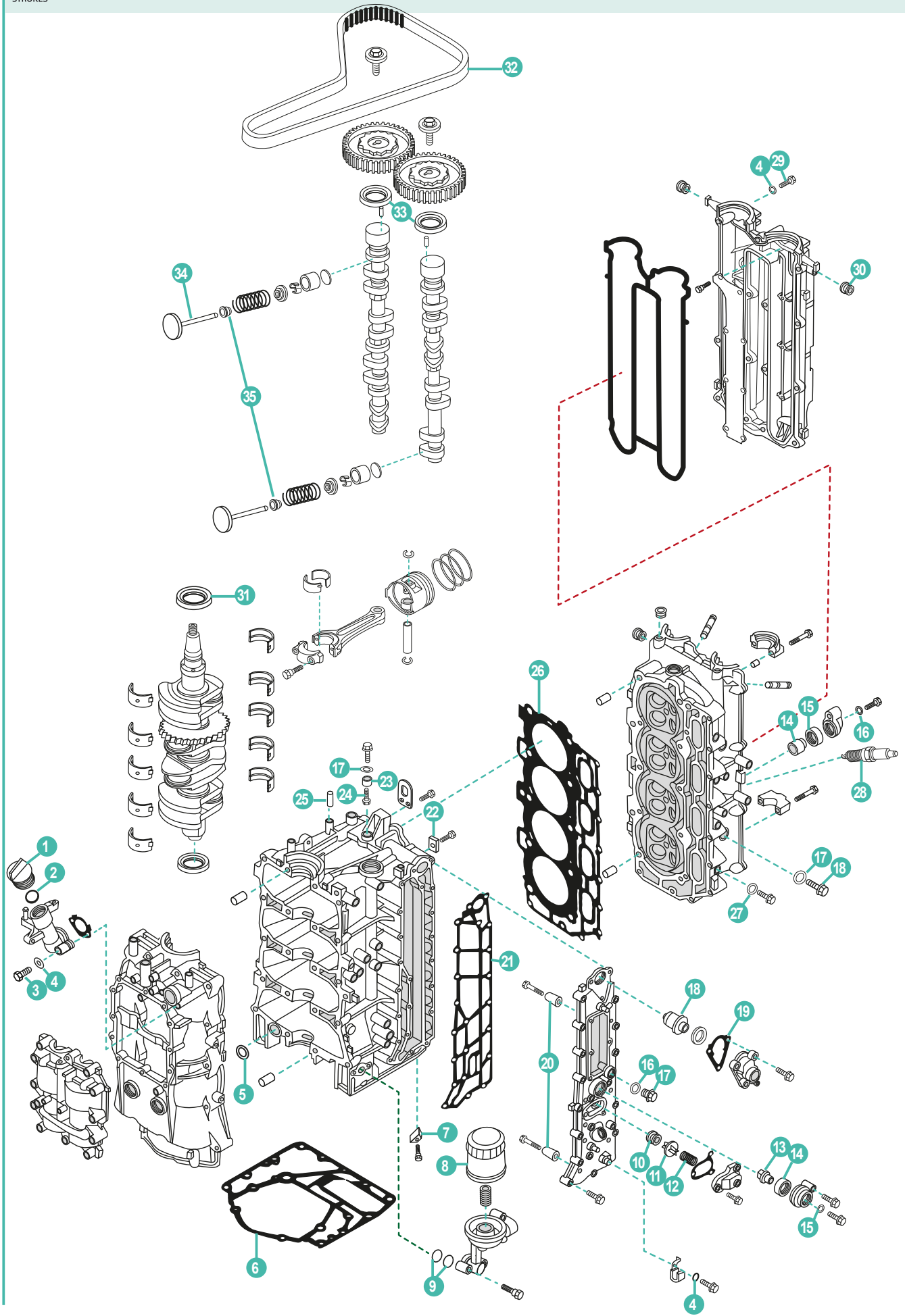

| | REF | OEM | | | | UN. | |
|----|------------------|--------------|------------------------------|---------------------------|----------------------------------|---------------------------------|----|
| 1 | PAF15-07050004 | 6G8-15363-00 | TAPÓN ACEITE | PLUG, OIL | TAPPO OLIO | BOUCHON REMPLISSAGE D'HUILE | 1 |
| 2 | PAJASOF40431-025 | 93210-24M79 | TÓRICA | O-RING | O-RING | JOINT TORIQUE | 1 |
| 3 | REC97095-06045 | 97095-06045 | TORNILLO | SCREW | VITE | VIS | 2 |
| 4 | PAGB/T97.1-6 | 92995-06600 | ARNADELA | WASHER | RONDELLA | RONDELLE | 15 |
| 5 | REC93210-25552 | 93210-25552 | TÓRICA | O-RING | O-RING | JOINT TORIQUE | 1 |
| 6 | REC63P-11351-01 | 63P-11351-00 | JUNTA BASE MOTOR | GASKET ENGINE | GUARNIZIONE BASE MOTORE | JOINT MOTEUR | 1 |
| 7 | CM63P-11325-01A | 63P-11325-01 | ÁNODO | ANODE | ANODO | ANODE | 1 |
| 8 | REC35-822626Q15 | 69J-13440-01 | FILTRO ACEITE | OIL FILTER | FILTRO DELL'OLIO | FILTRE À HUILE | 1 |
| 9 | REC93210-19MJ1 | 93210-19MJ1 | TÓRICA | O-RING | O-RING | JOINT TORIQUE | 2 |
| 10 | REC90480-20M05 | 90480-20M05 | TAPÓN | CAP | TAPPO | BOUCHON | 1 |
| 11 | REC60H-12416-00 | 6G5-12416-00 | VÁLVULA DE PRESIÓN | VALVE, PRESSURE CONTROL | VALVOLA ANTIPRESSIONE | SOUPAPE DE DEPRESSION | 1 |
| 12 | REC90501-16M11 | 90501-16M11 | RESORTE | SPRING | MOLLA | RESSORT | 1 |
| 13 | CM67F-11325-01A | 67F-11325-01 | ÁNODO | ANODE | ANODO | ANODE | 2 |
| 14 | REC67F-11328-00 | 67F-11328-00 | TAPÓN | CAP | TAPPO | BOUCHON | 2 |
| 15 | REC90430-06M03 | 90430-06M03 | JUNTA | GASKET | GUARNIZIONE | JOINT | 2 |
| 16 | PAF15-04000003 | 90430-14115 | JUNTA | GASKET | GUARNIZIONE | JOINT | 1 |
| 17 | PAF15-04000002 | 90340-14M06 | TORNILLO DRENAJE | BOLT, DISCHARGING OIL | VITE DRENAGGIO | VIS DE VIDANGE | 1 |
| 18 | REC67F-12411-01 | 67F-12411-01 | TERMOSTATO | THERMOSTAT | TERMOSTATO | THERMOSTAT | 1 |
| 19 | REC63P-12414-00 | 63P-12414-00 | JUNTA TAPA TERMOSTATO | GASKET, THERMOSTAT COVER | GUARNIZIONE COPERCHIO TERMOSTATO | JOINT COUVERCLE DE THERMOSTAT | 1 |
| 20 | CM68T-11325-00A | 68T-11325-00 | ÁNODO | ANODE | ANODO | ANODE | 8 |
| 21 | REC63P-41114-A3 | 63P-41114-A1 | JUNTA | GASKET | GUARNIZIONE | JOINT | 1 |
| 22 | CM63P-11325-11A | 63P-11325-11 | ÁNODO | ANODE | ANODO | ANODE | 4 |
| 23 | TEN01165 | 63P-11325-21 | ÁNODO | ANODE | ANODO | ANODE | 1 |
| 24 | PAGB/T818-M5X16 | 98780-05016 | TORNILLO | SCREW | VITE | VIS | 1 |
| 25 | REC93606-12019 | 93606-12019 | PIN CENTRADOR | HOLLOW PIN | SPINOTTO DI CENTRAGGIO | PIN DE CENTRAGE | 1 |
| 26 | REC63P-11181-00 | 63P-11181-00 | JUNTA CULATA | GASKET, CYLINDER HEAD | GUARNIZIONE TESTATA | JOINT DE CULASSE | 1 |
| 27 | PAF4-04000006 | 90430-08143 | JUNTA | GASKET | GUARNIZIONE | JOINT | 4 |
| 28 | NGKFR5A-11 | 94702-00391 | BUJÍA | SPARK PLUG | CANDELA | BOUGIE | 4 |
| 29 | PAGB/T5783-M6X30 | 97095-06030 | TORNILLO | SCREW | VITE | VIS | 13 |
| 30 | PAF15-07010027 | 90480-12072 | TAPÓN | CAP | TAPPO | BOUCHON | 5 |
| 31 | REC93102-60004 | 93102-60004 | RETÉN DE ACEITE | OIL SEAL | PARAOILIO | JOINT SPI | 1 |
| 32 | REC63P-46241-00 | 63P-46241-00 | CORREA DISTRIBUCIÓN | BELT, TIMING | CINGHIA DISTRIBUZIONE | COURROIE DISTRIBUTION | 1 |
| 33 | REC93102-38008 | 93102-38008 | RETÉN DE ACEITE | OIL SEAL | PARAOILIO | JOINT SPI | 2 |
| 34 | REC69J-12111-00 | 69J-12111-00 | VÁLVULA ADMISIÓN Ø92.5 mm | VALVE, INTAKE Ø92.5 mm | VALVOLA ASPIRAZIONE Ø92.5 mm | SOUPAPE D ADMISSION Ø92.5 mm | 8 |
| 35 | REC69J-12119-00 | 69J-12119-00 | RETÉN DE ACEITE | OIL SEAL | PARAOILIO | JOINT SPI | 16 |



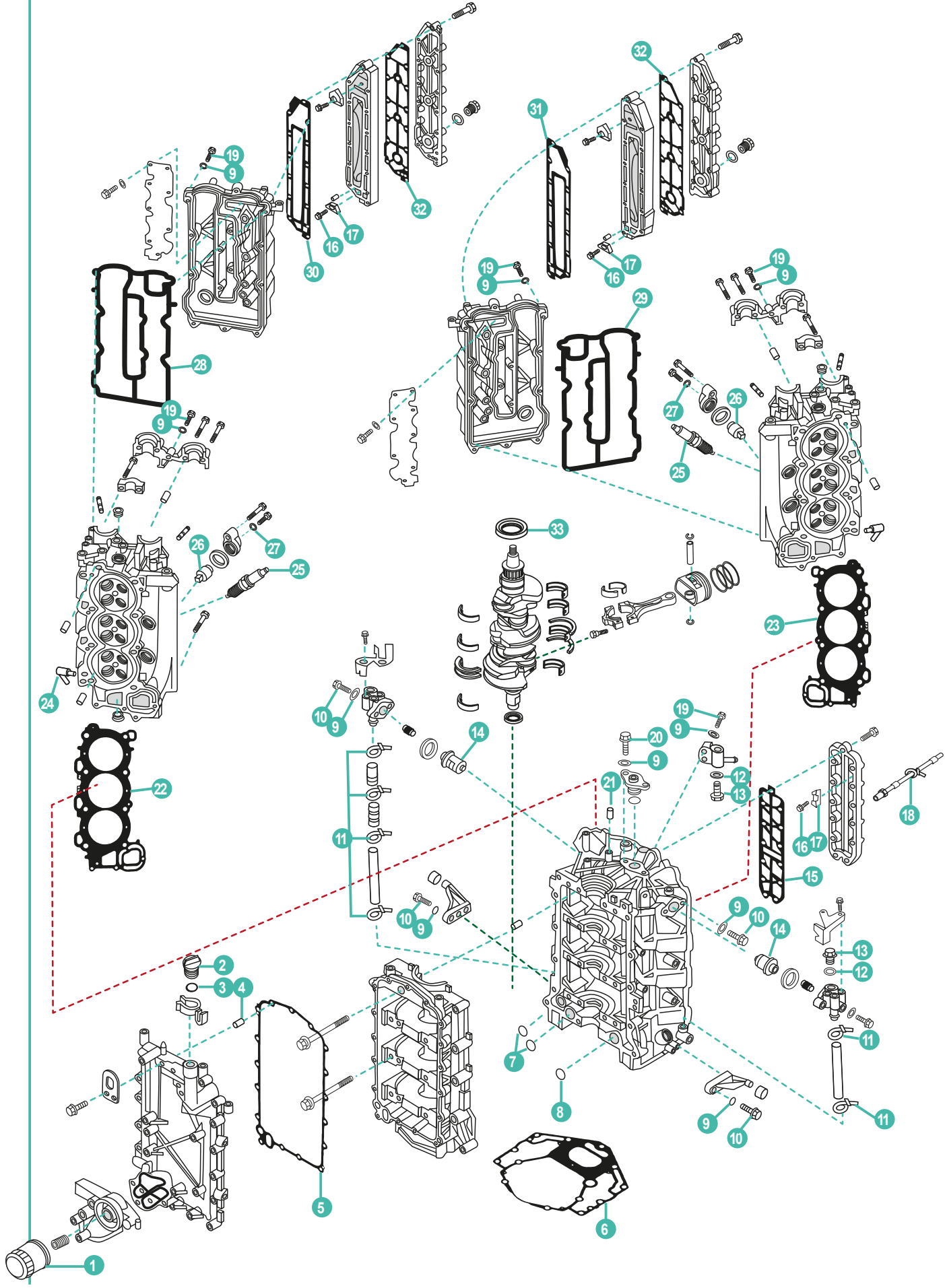

| | REF | OEM | | | | | UN. |
|----|------------------|--------------|------------------------|-------------------------------|----------------------------------|-----------------------------|-----|
| 1 | REC35-822626Q15 | 69J-13440-01 | FILTRO ACEITE | OIL FILTER | FILTRO DELL'OLIO | FILTRE À HUILE | 1 |
| 2 | PAF15-07050004 | 6G8-15363-00 | TAPÓN ACEITE | PLUG, OIL | TAPPO OLIO | BOUCHON REMPLISSAGE D'HUILE | 1 |
| 3 | PAJASOF40431-025 | 93210-24M79 | TÓRICA | O-RING | O-RING | JOINT TORIQUE | 1 |
| 4 | REC93606-12019 | 93606-12019 | PIN CENTRADOR | HOLLOW PIN | SPINOTTO DI CENTRAGGIO | PIN DE CENTRAGE | 2 |
| 5 | REC69J-15451-00 | 69J-15451-00 | JUNTA | GASKET | GUANIZIONE | JOINT | 1 |
| 6 | REC69J-11351-11 | 69J-11351-11 | JUNTA BASE MOTOR | GASKET ENGINE | GUARNIZIONE BASE MOTORE | JOINT MOTEUR | 1 |
| 7 | REC93210-19MJ1 | 93210-19MJ1 | TÓRICA | O-RING | O-RING | JOINT TORIQUE | 2 |
| 8 | REC93210-25552 | 93210-25552 | TÓRICA | O-RING | O-RING | JOINT TORIQUE | 1 |
| 9 | PAGB/T97.1-6 | 92995-06600 | ARANDELA | WASHER | RONDELLA | RONDELLE | 28 |
| 10 | PAGB/T5782-M6X25 | 97095-06025 | TORNILLO | SCREW | VITE | VIS | 8 |
| 11 | REC09401-11425 | 90465-11M59 | BRIDA | CLAMP | FLANGIA | COLLIER | 6 |
| 12 | PAF15-04000003 | 90430-14115 | JUNTA | GASKET | GUARNIZIONE | JOINT | 2 |
| 13 | PAF15-04000002 | 90340-14M06 | TORNILLO DRENAJE | BOLT, DISCHARGING OIL | VITE DRENAGGIO | VIS DE VIDANGE | 2 |
| 14 | REC67F-12411-01 | 67F-12411-01 | TERMOSTATO | THERMOSTAT | TERMOSTATO | THERMOSTAT | 2 |
| 15 | REC6P2-1131B-00 | 6P2-1131B-00 | JUNTA (NO SERIE A) | GASKET (NO SERIAL A) | GUARNIZIONE (NO SERIE A) | JOINT (NO SÉRIE A) | 1 |
| 16 | PAGB/T820-M4X12 | 98780-04015 | TORNILLO | SCREW | VITE | VIS | 6 |
| 17 | CM15026A | 6E5-11325-00 | ÁNODO | ANODE | ANODO | ANODE | 6 |
| 18 | PAHT-2.5X60 | 90465-11M10 | BRIDA | CLAMP | FLANGIA | COLLIER | 1 |
| 19 | PAGB/T5783-M6X30 | 97095-06030 | TORNILLO | SCREW | VITE | VIS | 18 |
| 20 | PAGB/T5783-M6X20 | 97095-06020 | TORNILLO | SCREW | VITE | VIS | 2 |
| 21 | REC93606-12019 | 93606-12019 | PIN CENTRADOR | HOLLOW PIN | SPINOTTO DI CENTRAGGIO | PIN DE CENTRAGE | 1 |
| 22 | REC6P2-11181-00 | 6P2-11181-00 | JUNTA CULATA 1 | GASKET, CYLINDER HEAD 1 | GUARNIZIONE TESTATA 1 | JOINT DE CULASSE 1 | 1 |
| 23 | REC6P2-11182-00 | 6P2-11182-00 | JUNTA CULATA 2 | GASKET, CYLINDER HEAD 2 | GUARNIZIONE TESTATA 2 | JOINT DE CULASSE 2 | 1 |
| 24 | PAF15-04000005 | 676-11372-00 | NIPLE DE MANGUERA | NIPPLE | TUBO | RACCORD D'EAU | 1 |
| 25 | NGKLF6A-11 | 94702-00400 | BUJÍA | SPARK PLUG | CANDELA | BOUGIE | 6 |
| 26 | CM67F-11325-01A | 67F-11325-01 | ÁNODO | ANODE | ANODO | ANODE | 2 |
| 27 | REC90430-06M03 | 90430-06M03 | JUNTA | GASKET | GUARNIZIONE | JOINT | 2 |
| 28 | REC6P2-11193-00 | 6P2-11193-00 | JUNTA TAPA DE CULATA 1 | GASKET, CYLINDER HEAD COVER 1 | GUARNIZIONE, COPERCHIO TESTATA 1 | JOINT DE CACHE CULBUTEUR 1 | 1 |
| 29 | REC6P2-11194-00 | 6P2-11194-00 | JUNTA TAPA DE CULATA 2 | GASKET, CYLINDER HEAD COVER 2 | GUARNIZIONE, COPERCHIO TESTATA 2 | JOINT DE CACHE CULBUTEUR 2 | 1 |
| 30 | REC6P2-41122-00 | 6P2-41122-00 | JUNTA | GASKET | GUARNIZIONE | JOINT | 1 |
| 31 | REC6P2-41112-00 | 6P2-41112-00 | JUNTA | GASKET | GUARNIZIONE | JOINT | 1 |
| 32 | REC6P2-41114-00 | 6P2-41114-00 | JUNTA | GASKET | GUARNIZIONE | JOINT | 2 |
| 33 | REC93102-63004 | 93102-63008 | RETÉN DE ACEITE | OIL SEAL | PARAOLIO | JOINT SPI | 1 |
| 34 | PAPS2700.04.03 | 51Y-12119-00 | RETÉN DE ACEITE | OIL SEAL | PARAOLIO | JOINT SPI | 24 |
| 35 | REC93102-38008 | 93102-38008 | RETÉN DE ACEITE | OIL SEAL | PARAOLIO | JOINT SPI | 4 |
| 36 | REC6P2-46241-02 | 6P2-46241-01 | CORREA DISTRIBUCIÓN | BELT, TIMING | CINGHIA DISTRIBUZIONE | COURROIE DISTRIBUTION | 1 |

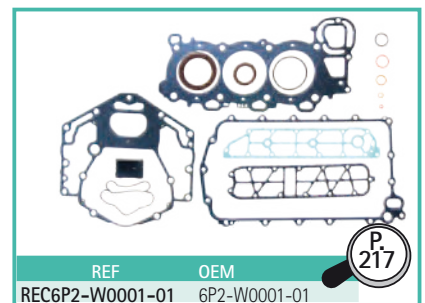
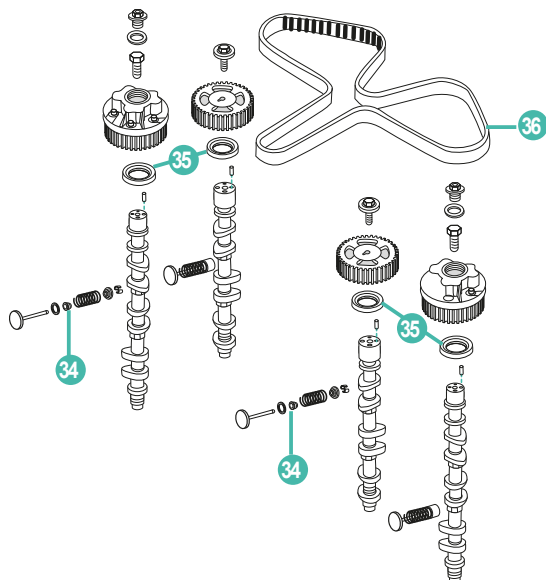

4T F300A • F350A
STROKES



REC10W30U3
REC10W30U6
REC10W40U3
REC10W40U6

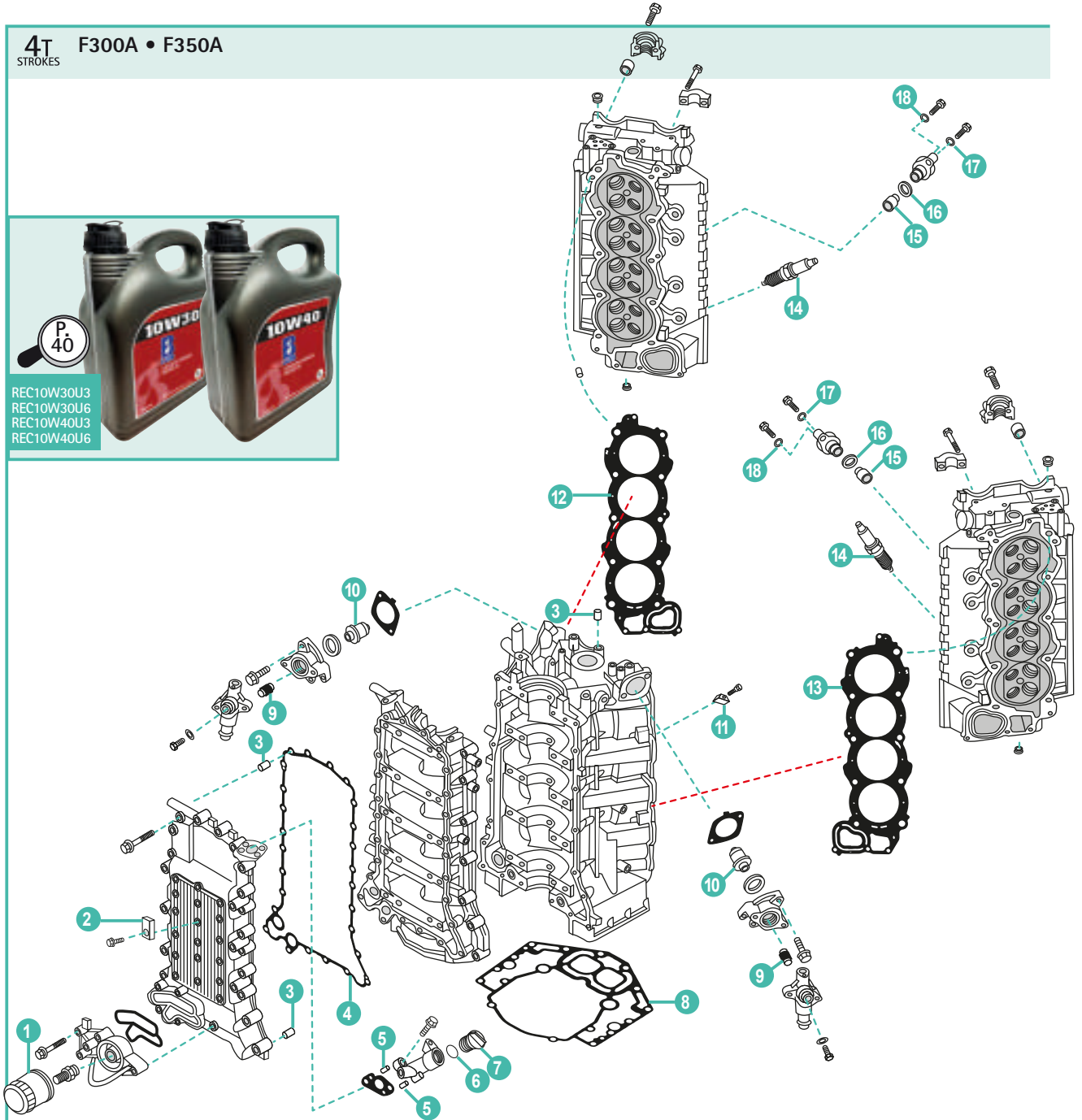

| | REF | OEM | | | | UN. | |
|----|------------------|--------------|-------------------|---------------------------|---------------------------|-----------------------------|---|
| 1 | REC N26-13440-00 | N26-13440-00 | FILTRO ACEITE | OIL FILTER | FILTRO DELL'OLIO | FILTRE À HUILE | 1 |
| 2 | CM63P-11325-01A | 63P-11325-01 | ÁNODO | ANODE | ANODO | ANODE | 3 |
| 3 | REC93606-12019 | 93606-12019 | PIN CENTRADOR | HOLLOW PIN | SPINOTTO DI CENTRAGGIO | PIN DE CENTRAGE | 5 |
| 4 | REC6AW-15451-00 | 6AW-15451-00 | JUNTA CÁRTER | CRANK CASE COMPLEX GASKET | GUARNIZIONE COPPA L'OLLIO | JOINT DE CACHE CULBUTEUR | 1 |
| 5 | PAF25-04000007 | 93604-08062 | PIN CENTRADOR | HOLLOW PIN | SPINOTTO DI CENTRAGGIO | PIN DE CENTRAGE | 2 |
| 6 | PAJASOF40431-025 | 93210-24M79 | TÓRICA | O-RING | O-RING | JOINT TORIQUE | 1 |
| 7 | PAF15-07050004 | 6G8-15363-00 | TAPÓN ACEITE | PLUG, OIL | TAPPO OLIO | BOUCHON REMPLISSAGE D'HUILE | 1 |
| 8 | REC6AW-11351-00 | 6AW-11351-00 | JUNTA BASE MOTOR | GASKET ENGINE | GUARNIZIONE BASE MOTORE | JOINT DE TETE MOTRICE | 1 |
| 9 | TEN01172 | 6AW-1132R-00 | ÁNODO | ANODE | ANODO | ANODE | 2 |
| 10 | REC6AW-12411-00 | 6AW-12411-00 | TERMOSTATO | THERMOSTAT | TERMOSTATO | THERMOSTAT | 2 |
| 11 | TEN01177 | 6AW-1132P-00 | ÁNODO | ANODE | ANODO | ANODE | 8 |
| 12 | REC6AW-11182-00 | 6AW-11182-00 | JUNTA DE CULATA 2 | HEAD GASKET 2 | GUARNIZIONE TESTATA 2 | JOINT DE CULASSE 2 | 1 |
| 13 | REC6AW-11181-00 | 6AW-11181-00 | JUNTA DE CULATA 1 | HEAD GASKET 1 | GUARNIZIONE TESTATA 1 | JOINT DE CULASSE 1 | 1 |
| 14 | NGK LFR6A-11 | 94702-00400 | BUJÍA | SPARK PLUG | CANDELE | BOUGIE | 8 |
| 15 | TEN01170 | 6AW-11325-00 | ÁNODO | ANODE | ANODO | ANODE | 2 |
| 16 | REC67F-11328-00 | 67F-11328-00 | TAPÓN | CAP | TAPPO | BOUCHON | 2 |
| 17 | REC90430-06M03 | 90430-06M03 | JUNTA | GASKET | GUARNIZIONE | JOINT | 2 |
| 18 | PAGB/T97.1-8 | 92995-08600 | ARANDELA | WASHER | RONDELLA | RONDELLE | 2 |

4T
STROKES

JUNTAS DE MOTOR
4 TIEMPOS

ENGINE GASKET
4 STROKES

GUARNIZIONI DE
MOTORE 4 TEMPI

JOINTS DE MOTEUR
4 TEMPS

JUNTAS DE CULATA

CYLINDER HEAD GASKET

GUARNIZIONE DE TESTATA

JOINTS DE CULASSE

| REF | OEM |
|-----------------|--------------|
| PAF2.6-04000001 | 69M-11181-00 |

F2.5 (2003+)



P. 173

| REF | OEM |
|---------------|--------------|
| PAF4-04000014 | 67D-11181-A0 |

F4 (1998-2009)



P. 175

| REF | OEM |
|---------------|--------------|
| PAF6-04000002 | 6BX-11181-00 |

F4B/M (2010+)
F5A/M (2010+)
F6C/M (2010+)



new

P. 176

| REF | OEM |
|-----------------|--------------|
| REC6G8-11181-A1 | 6G8-11181-A1 |

F8/9.9 (1985-05)



P. 181

| REF | OEM |
|----------------|--------------|
| PAF15-07000100 | 66M-11181-10 |

F9.9/13.5/15 (1998-08)

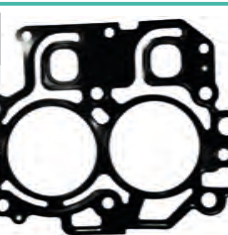

P. 185

| REF | OEM |
|-----------------|--------------|
| REC6AG-11181-00 | 6AG-11181-00 |

F9.9/15/20 (2007+)



P. 187

| REF | OEM |
|-----------------|--------------|
| REC6BL-11181-00 | 6BL-11181-00 |

F20/25
FT25
T25 (2009+)



P. 195

| REF | OEM |
|----------------|--------------|
| PAF25-05040000 | 65W-11181-30 |

F20/25
T25
F45/50 (1998-09)

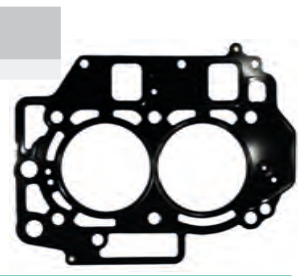

P. 191

| REF | OEM |
|-----------------|--------------|
| REC67C-11181-01 | 67C-11181-01 |

F30/40 (2000-09)

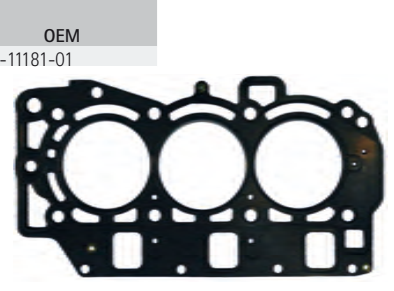

P. 197

| REF | OEM |
|-----------------|--------------|
| REC6BG-11181-00 | 6BG-11181-00 |

F30/40 (2009+)

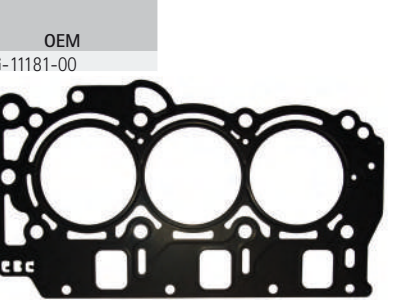

P. 201

| REF | OEM |
|-----------------|--------------|
| REC6CJ-11181-00 | 6CJ-11181-00 |

F40GE/70 (2011+)

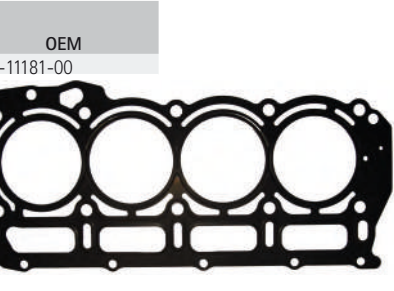

P. 205

| REF | OEM |
|-----------------|--------------|
| REC67F-11181-03 | 67F-11181-03 |

F75/80/100/115 (1999+)

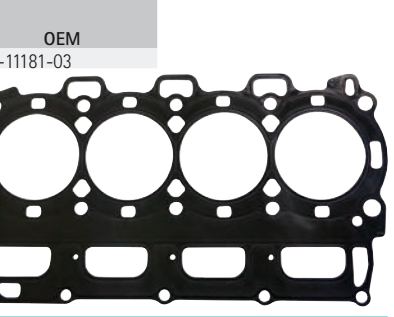

P. 209

| REF | OEM |
|-----------------|--------------|
| REC63P-11181-00 | 63P-11181-00 |

F150
FL150 (2004+)

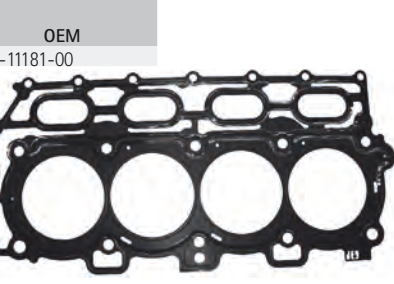

P. 211

YAMAHA

RECAMBIOS
MARINOS

| REF | OEM |
|-----------------|--------------|
| REC6DA-11181-00 | 6DA-11181-00 |

F175/200
FL200 (2013+)

| REF | OEM |
|-----------------|--------------|
| REC6CB-11181-00 | 6CB-11181-00 |

F225/250/300
LF-FL225/250/300 (2011+)

| REF | OEM |
|-----------------|--------------|
| REC6P2-11182-00 | 6P2-11182-00 |
| REC6P2-11181-00 | 6P2-11181-00 |

F200/225/250
FL-LF 200/225/250 (2006-13)

P. 213

REC6P2-11182-00

REC6P2-11181-00

| REF | OEM |
|-----------------|--------------|
| REC6AW-11181-00 | 6AW-11181-00 |
| REC6AW-11182-00 | 6AW-11182-00 |

F300/FL300
(2008+)

P. 214

BABOR | PORT | BABORDO | GAUCHE
ESTRIBOR | STD | TRIBORDO | DROIT

REC6AW-11181-00

REC6AW-11182-00

| REF | OEM |
|-----------------|--------------|
| REC69J-11182-03 | 69J-11182-03 |
| REC69J-11181-03 | 69J-11181-03 |

F200/225
FL200/225 (2002-07)

BABOR | PORT | BABORDO | GAUCHE
ESTRIBOR | STD | TRIBORDO | DROIT

REC69J-11182-03

REC69J-11181-03

4T
STROKES

KITS JUNTAS DE CULATA **CYLINDER HEAD GASKET KIT**

| REF | OEM |
|-----------------|--------------|
| REC6G8-W0001-A3 | 6G8-W0001-A3 |

F9.9 (1996-06)
F8BM (1996-99)

KIT GUARNIZIONE TESTATA **KITS JOINTS DE CULASSE**

| REF | OEM |
|-----------------|--------------|
| REC66M-W0001-01 | 66M-W0001-01 |

F15 (2001-04)
F13.5 (2002-04)
FT 9.9/T9.9 (2001-04)
F9.9 (2001-04)

| REF | OEM |
|-----------------|--------------|
| REC65W-W0001-00 | 65W-W0001-00 |

F20/25 (1998-01)
T25/FT25 (2000-01)

| REF | OEM |
|-----------------|------------------------------|
| REC6P2-W0001-01 | 6P2-W0001-00 6P2-W0001-01 |

FL/LF/F250 AET/TX
6P22 / 6P32 (2006)
FL/F200C 6AL1-6AM6 (2006-11)
FL/F225B/C 6AS1-6BBA (2007-11)
LF/FL/F250A/B/T 6BR2-6P36 (2007-11)

| REF | OEM |
|-----------------|------------------------------|
| REC67C-W0001-01 | 67C-W0001-00 67C-W0001-01 |

F30 ALL
F40ALL (2000-09)

| REF | OEM |
|-----------------|--------------|
| REC67F-W0001-00 | 67F-W0001-00 |

F75 (2003-17)
F80 (1999-03)
F100 (1999-03)
F90 (2003-17)
F115 (2000-15)

4T
STROKES

JUNTAS BASE DE MOTOR CYLINDER GASKET

| REF | OEM |
|-----------------|--------------|
| PAF2.6-00000003 | 69M-45113-A0 |

F2.5

| REF | OEM |
|---------------|--------------|
| PAF6-00000001 | 6BX-45113-A0 |

F4/F5/F6

| REF | OEM |
|---------------|--------------|
| PAF4-00000006 | 67D-45113-A0 |

F4

GUARNIZIONE BASE MOTORE JOINTS DE TÊTE MOTRICE

| REF | OEM |
|----------------|--------------|
| PAF15-00000014 | 66M-11351-10 |

T/FT9.9
F9.9
F15
F13.5

| REF | OEM |
|-----------------|--------------|
| REC6G8-11351-A0 | 6G8-11351-A0 |

T/FT 9.9
F9.9
F8

| REF | OEM |
|----------------|--------------|
| PAF25-00000013 | 65W-11351-10 |





F20
F25
T/FT25

YAMAHA

RECAMBIOS
MARINOS



| REF | OEM |
|-----------------|--------------|
| REC6AH-11351-00 | 6AH-11351-10 |



 F9.9
 F13.5
 F15
 F20

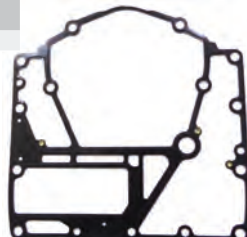





| REF | OEM |
|-----------------|--------------|
| REC63P-11351-01 | 63P-11351-01 |

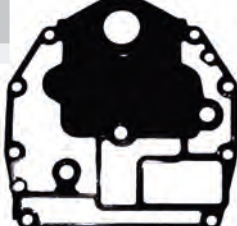

 F150
 F175
 F200



| REF | OEM |
|-----------------|--------------|
| REC67C-11351-00 | 67C-11351-01 |



 F40
 T/FT50
 F50
 T/FT60
 F30
 F60





| REF | OEM |
|-----------------|--------------|
| REC69J-11351-11 | 69J-11351-11 |



 F200
 F225
 F250



| REF | OEM |
|-----------------|--------------|
| REC68V-11351-00 | 68V-11351-00 |

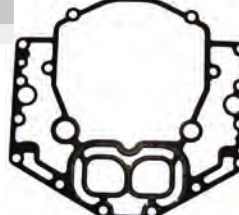

 F75
 F80
 F90
 F115
 F100

| REF | OEM |
|-----------------|--------------|
| REC6AW-11351-00 | 6AW-11351-00 |



 F300
 F350

4T
STROKES

| GUÍA JUNTAS DE MOTOR | | ENGINE GASKET GUIDE | | GUIDA GUARNIZIONE MOTORE | | GUIDE JOINTS DE MOTEURS | |
|---|---------|---|------------------------------------|--------------------------|--|---|--|
|  | CYL | JUNTA CULATA CYLINDER HEAD GASKET GUARNIZIONE TESTATA JOINT DE CULASSE | | KIT | | JUNTA BASE MOTOR CYLINDER GASKET GUARNIZIONE BASE MOTORE JOINT DE TETE MOTRICE | |
| | | | | | | | |
| F2.6A/M | 2003 | 1 | PAF2.6-04000001 | | | PAF2.6-00000003 | |
| F4A/M | 1998 | 1 | PAF4-04000014 | | | PAF4-00000006 | |
| F8A/B | 1985-99 | 2 | REC6G8-11181-A1 | REC6G8-W0001-A3 | | REC6G8-11351-A0 | |
| F9.9A/B | 1985-99 | 2 | REC6G8-11181-A1 | REC6G8-W0001-A3 | | REC6G8-11351-A0 | |
| F9.9C | 2001-07 | 2 | PAF15-07000100 | REC66M-W0001-01 | | PAF15-00000014 | |
| F9.9H | 2008 | 2 | REC6AG-11181-00 | | | REC6AH-11351-00 | |
| FT9.9D, F13.5 A | 2001-07 | 2 | PAF15-07000100 | REC66M-W0001-01 | | PAF15-00000014 | |
| F13.5B, F15C/E/M | 2008 | 2 | REC6AG-11181-00 | | | REC6AH-11351-00 | |
| F15A/E/M/P | 2001-07 | 2 | PAF15-07000100 | REC66M-W0001-01 | | PAF15-00000014 | |
| F20B/E/M | 2008 | 2 | REC6AG-11181-00 | | | REC6AH-11351-00 | |
| F20D | 2011 | 2 | REC6BL-11181-00 | | | | |
| F20A | 1998 | 2 | PAF25-05040000 | REC65W-W0001-00 | | PAF25-00000013 | |
| T25/F25A/A/E/M | 1998-09 | 2 | PAF25-05040000 | REC65W-W0001-00 | | PAF25-00000013 | |
| T25/F25D/M/F | 2009 | 2 | REC6BL-11181-00 | | | | |
| F30A/E/TR, F40B/E/TR | 2000-09 | 3 | REC67C-11181-01 | REC67C-W0001-01 | | REC67C-11351-00 | |
| F30B, F40F | 2009 | 3 | REC6BG-11181-00 | | | | |
| F40G, F70A | 2011 | 4 | REC6CJ-11181-00 | | | | |
| F80A/B/C/TLR | 1999 | 4 | REC67F-11181-03 | REC67F-W0001-00 | | REC68V-11351-00 | |
| F100A/B/D/TLR | 1999 | 4 | REC67F-11181-03 | REC67F-W0001-00 | | REC68V-11351-00 | |
| F115A/TX/TLR | 2000 | 4 | REC67F-11181-03 | REC67F-W0001-00 | | REC68V-11351-00 | |
| F150A/T/B | 2004 | 4 | REC63P-11181-00 | | | REC63P-11351-01 | |
| F17A | 2014 | 4 | REC6DA-11181-00 | | | REC63P-11351-01 | |
| F200A/TX/TR | 2002-07 | 6 | REC69J-11181-03 REC69J-11182-03 | | | REC69J-11351-11 | |
| F200A/C, F225A/B/C | 2007 | 6 | REC6P2-11181-00 REC6P2-11182-00 | REC6P2-W0001-01 | | REC69J-11351-11 | |
| F200B/F/G/CA | 2013 | 4 | REC6DA-11181-00 | | | REC63P-11351-01 | |
| F225A/TR/TX/TUR | 2002-07 | 6 | REC69J-11181-03 REC69J-11182-03 | | | REC69J-11351-11 | |
| F225CA/F, F250CA/D | 2011 | 6 | REC6CB-11181-00 | | | | |
| F250A/B/T | 2009 | 6 | REC6P2-11181-00 REC6P2-11182-00 | REC6P2-W0001-01 | | REC69J-11351-11 | |
| F300A/TR, F350A/C/T | 2008 | 8 | REC6AW-11181-00 REC6AW-11182-00 | | | REC6AW-11351-00 | |
| F300B/CA | 2011 | 6 | REC6CB-11181-00 | | | | |

CIGÜEÑAL

CRANKSHAFT

ALBERO MOTORE

VILEBREQUIN

4T
STROKES

GUÍA CIGÜEÑAL COMPLETO

GUIDE CRANKSHAFT ASSY

GUIDA ALBERO MOTORE COMPLETO

GUIDE VILEBREQUIN COMPLET

| 4T STROKES | | | 4T STROKES | | |
|------------|---------|-----------------|-------------|---------|----------------|
| | REF | REF | | REF | REF |
| F2.5 | 2003-13 | PAF2.6-04030000 | F15 | 2007-19 | PAF20-05020004 |
| F4 | 1998-09 | PAF4-04030000 | F20/AE/S/TL | 2003-06 | PAF25-05020001 |
| F9.9 | 1998-09 | PAF15-07030000 | F20 | 2007-19 | PAF20-05020004 |
| F9.9 | 2009-19 | PAF20-05020004 | T25E/TL/R/B | 2000-09 | PAF25-05020001 |
| F13.5 | 1999-07 | PAF15-07030000 | F25 | 1999-09 | PAF25-05020001 |
| F13.5 | 2007-09 | PAF20-05020004 | F45AET | 1999 | PAF25-05020001 |
| F15 | 1998-07 | PAF15-07030000 | F50TJR | 1999 | PAF25-05020001 |

PISTONES

PISTONS

PISTONI

PISTONS





4T
STROKES

KITS DE PISTONES





PISTON KITS

KIT PISTONE





KIT PISTON

| | STD | |
|---|----------------------------|-----------------|
| | REF | OEM |
|  | PAF2.6-04020001 | 69M-E1631-01-96 |
|  | REC69M-E1603-01 | 69M-E1 603-01 |
|  | PAF2.6-04020005 | 69M-E1633-00 |
|  | F2.5AMH/MLH/MH/MSH (2004+) | |

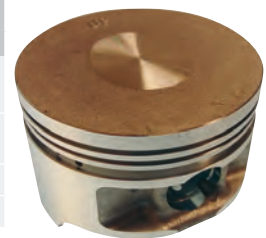





| | STD | |
|---|---|--------------|
| | REF | OEM |
|  | PAF20-05020001 | 6AH-11631-00 |
|  | PAF20-05020100 | 6AH-11603-00 |
|  | PAF20-05020003 | 137-11633-10 |
|  | PAF20-05020002 | 93450-17129 |
|  | F9.9 HMH, HE (2009+) F13.5 B, BMH (2007-09) F15 CMH, MH, ELH, CWH, CE (2007+) F20 BMH, ELH, BE, MH (2007+) | |







| | STD | |
|---|----------------------------------|-----------------|
| | REF | OEM |
|  | PAF4-04020200 | 68D-E1631-00-96 |
|  | REC68D-E1603-00 | 68D-E1603-00 |
|  | PAF4-04020005 | 68D-E1633-00 |
|  | PAF4-04020006 | 93450-14088 |
|  | F4A/MSHA/AMH/MLHB-D/MH (2002-09) | |



| | STD | |
|---|--|-----------------|
| | REF | OEM |
|  | PAF25-05020100 | 65W-11631-00-96 |
|  | REC67C-11603-00 | 67C-11603-00 |
|  | PAF25-05020105 | 62Y-11633-00 |
|  | PAF25-05020106 | 93450-17129 |
|  | F20AES/AET/AE-S (2003-06) F25ELH/AE/AW/A/AET/MHZ/MHA/AM/AEH/A-ES/ T25ELRZ-T/FT25B (1998-09) F30A/ERZ/MLH/AET/ELHB/AMH/TR/AWH/ETL (2001-09) F40B/ELH/BE/ERZ/ERA/BMH/BWH (2000-09) | |



| | STD | |
|---|---|-----------------|
| | REF | OEM |
|  | PAF15-07020001 | 66M-11631-00-96 |
|  | REC66N-11603-00 | 66N-11603-00 |
|  | PAF15-07020006 | 634-11633-00 |
|  | PAF15-07020005 | 93450-15023 |
|  | F9.9C/CE/CMH/CWH/D (1998-08) F13.5AMH/AEH/AEP (2000-07) FT/F15A/PR/PLR/AEP/ELH/MH/AE/AM (2000-07) | |



YAMAHA

RECAMBIOS MARINOS

DESPIECE MOTOR
DE 2 TIEMPOS

ENGINE PARTS
2 STROKES

PARTI DEL MOTORE
2 TEMPI

PIECES MOTEUR
2 TEMPS

2T
STROKES 2B • 2MSH

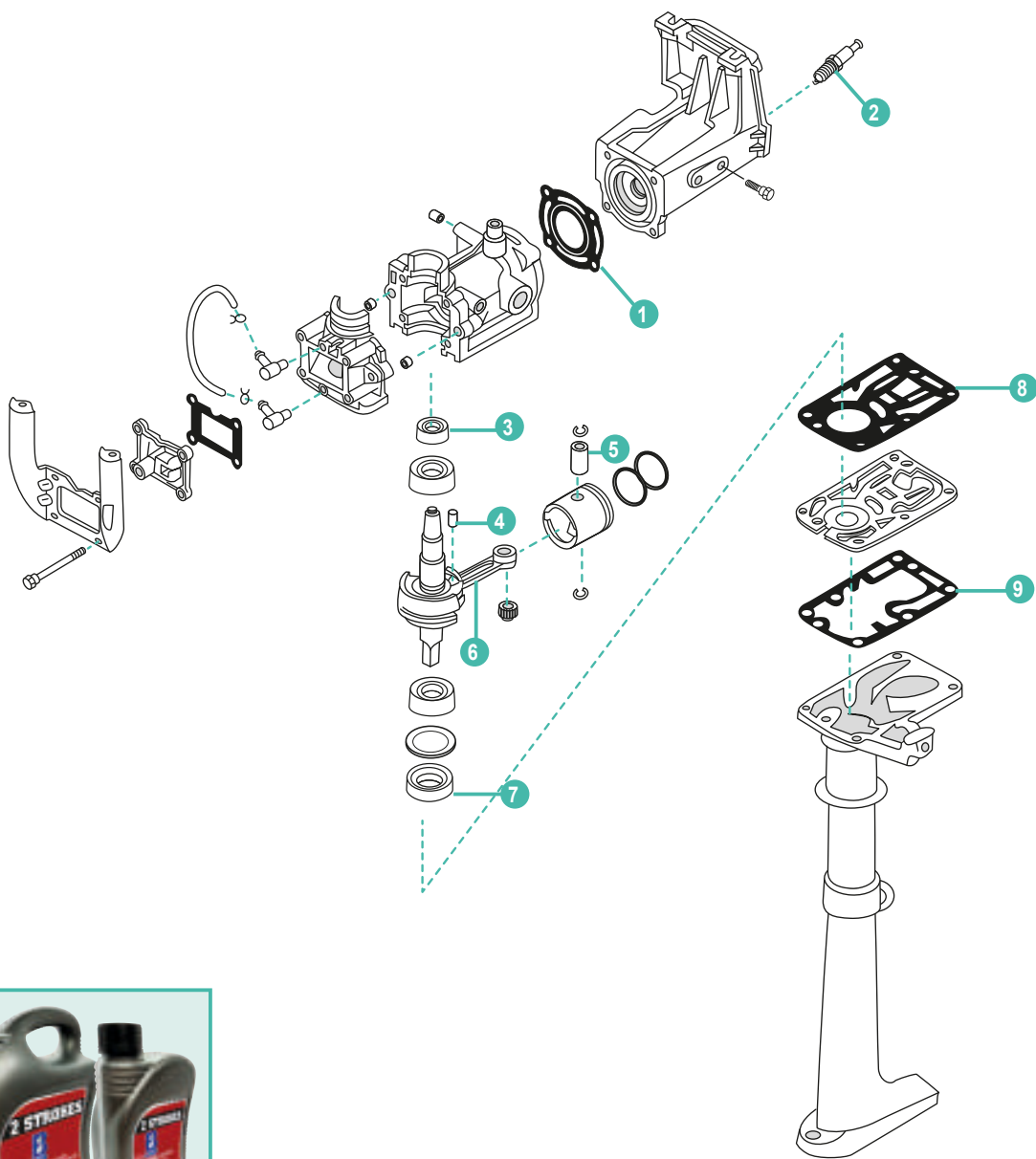

YAMAHA



REC2TU3
REC2TU6

| | REF | OEM | | | | UN. | |
|---|-----------------|--------------|----------------------|-----------------------|---------------------------|---------------------------|---|
| 1 | REC6F8-11181-A0 | 6F8-11181-A1 | JUNTA CULATA | GASKET, CYLINDER HEAD | GUARNIZIONE TESTATA | JOINT DE CULASSE | 1 |
| 2 | NGKB7HS | 94702-00040 | BUJÍA | SPARK PLUG | CANDELA | BOUGIE | 1 |
| 3 | PAF2.6-04010001 | 93102-20070 | RETÉN DE ACEITE | OIL SEAL | PARAOLIO | JOINT SPI | 1 |
| 4 | REC646-11681-00 | 646-11681-00 | PIN DE BIELA | PIN, CRANK | SPINOTTO BIELLA | PIN DE BIELLE | 1 |
| 5 | REC646-11633-00 | 646-11633-00 | PIN, PISTÓN | PIN, PISTON | SPINOTTO PISTONE | AXE DE PISTON | 1 |
| 6 | REC646-11651-02 | 646-11651-02 | BIELA | CONNECTING ROD | BIELLA | BIELLE | 1 |
| 7 | REC93102-15M32 | 93102-15M32 | RETÉN DE ACEITE | OIL SEAL | PARAOLIO | JOINT SPI | 1 |
| 8 | REC6A1-14613-A0 | 6A1-14613-A0 | JUNTA TUBO DE ESCAPE | GASKET, EXHAUST PIPE | GUARNIZIONE, TUBO SCARICO | JOINT, PIPE D'ECHAPPEMENT | 1 |
| 9 | REC646-14623-A1 | 646-14623-A1 | JUNTA | GASKET | GUARNIZIONE | JOINT | 1 |

2T
STROKES

4ACMH • 4A • 4AS • 4MSH • 4KZ • 4AC • 5C • 5CS • 5ACMH

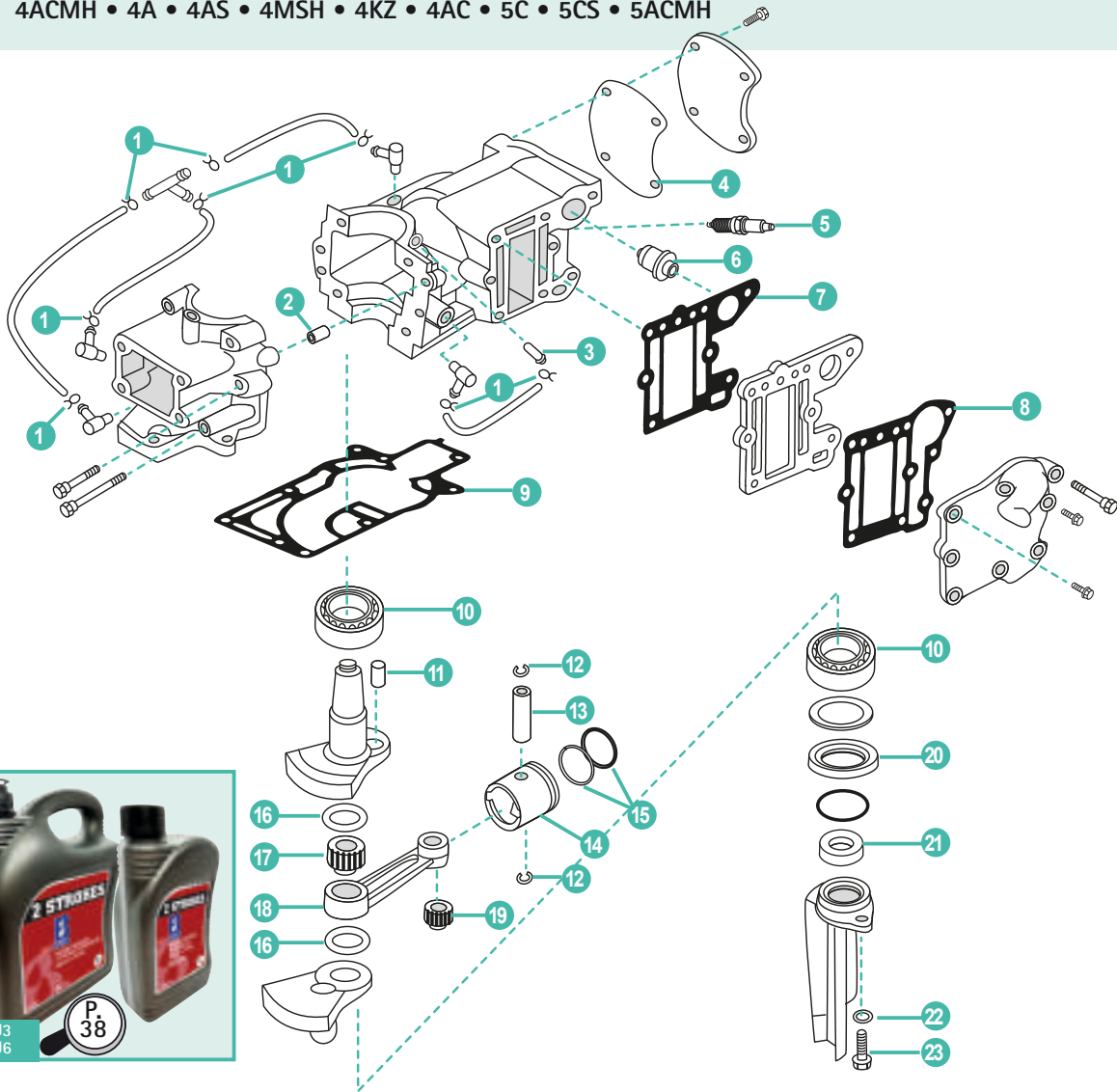

YAMAHA

RECAMBIOS
MARINOS

| REF | OEM | | | | | UN. | |
|-----|---------------------|-----------------|--------------------------------|-----------------------------|--|------------------------------------|---|
| 1 | PAHT-2.5X60 | 90467-06016 | CLIP ABRAZADERA | CLIP | CLIP FASCETTA | COLLIER | 8 |
| 2 | REC93606-12019 | 93606-12019 | PIN CENTRADOR | HOLLOW PIN | SPINOTTO DI CENTRAGGIO | PIN DE CENTRAGE | 2 |
| 3 | REC624-14485-00 | 624-14485-00 | PIPA DE AGUA | PIPE, WATER | TUBO | RACCORD TUYAU D'EAU | 1 |
| 4 | REC6E0-11193-A1 | 6E0-11193-A1 | JUNTA TAPA | GASKET, COVER | GAURNIZIONE COPERCHIO | JOINT COUVERCLE | 1 |
| 5 | NGKBR7HS | 94702-00272 | BUJÍA | SPARK PLUG | CANDELA | BOUGIE | 1 |
| 6 | REC6E5-12411-02 | 6E5-12411-01 | TERMOSTATO | THERMOSTAT | TERMOSTATO | THERMOSTAT | 1 |
| 7 | REC6E0-41112-A1 | 6E0-41112-A1 | JUNTA DE ESCAPE | EXHAUST GASKET | GUARNIZIONE DI SCARICO | JOINT D'ÉCHAPPEMENT | 1 |
| 8 | REC6E0-41114-A1 | 6E0-41114-A1 | JUNTA EXTERIOR, TAPA DE ESCAPE | GASKET, EXHAUST OUTER COVER | GUARNIZIONE ESTERIORE, COPERCHIO SCARICO | JOINT DE COUVERCLE EXT ÉCHAPPEMENT | 1 |
| 9 | REC6E0-45113-A1 | 6E0-45113-A1 | JUNTA BASE MOTOR | GASKET ENGINE | GUARNIZIONE BASE MOTORE | JOINT MOTEUR | 1 |
| 10 | REC93306-204U0 | 93306-204U0 | RODAMIENTO | BEARING | CUSCINETTO | PALIER DE VILEBREQUIN | 2 |
| 11 | REC6G1-11681-00 | 6G1-11681-00 | PIN DE CIGÜEÑAL | PIN, CRANK | SPINOTTO AALBERO MOTORE | PIN DE VILEBREQUIN | 1 |
| 12 | REC93450-13022 | 93450-13022 | CIRCLIP | CIRCLIP | CIRCLIP | CIRCLIP | 2 |
| 13 | REC6G1-11633-00 | 6G1-11633-00 | PIN, PISTÓN | PIN, PISTON | SPINOTTO PISTONE | AXE DE PISTON | 1 |
| 14 | REC6E0-11631-00-98K | 6E0-11631-00-98 | PISTON | PISTON STD | PISTONE | PISTON | 1 |
| 15 | REC6G1-11610-00 | 6G1-11610-00 | KIT SEGMENTOS DE PISTÓN | PISTON RING KIT | KIT FASCIA PISTONE | KIT SEGMENTS | 1 |
| | REC6J1-11610-00 | 6J1-11610-00 | KIT SEGMENTOS DE PISTÓN 5C | PISTON RING KIT 5C | KIT FASCIA PISTONE 5C | KIT SEGMENTS 5C | |
| 16 | REC90209-18112 | 90209-18112 | ARANDELA | WASHER | RONDELLA | RONDELLE | 2 |
| 17 | REC93310-418V1 | 93310-418V1 | COJINETE DE BIELA | BEARING, CONNECTING ROD | CUSCINETTO BIELLA | PALIER DE BIELLE | 1 |
| 18 | REC6E0-11651-01 | 6E0-11651-01 | COJINETE DE BIELA | BEARING, CONNECTING ROD | CUSCINETTO BIELLA | PALIER DE BIELLE | 1 |
| 19 | REC93310-112V0 | 93310-112V0 | RODAMIENTO | BEARING | CUSINETTO | PALIER | 1 |
| 20 | REC93101-20M29 | 93101-20M29 | RETÉN DE ACEITE | OIL SEAL | PARAOLIO | JOINT SPI | 1 |
| 21 | REC93101-10M25 | 93101-10M25 | RETÉN DE ACEITE | OIL SEAL | PARAOLIO | JOINT SPI | 1 |
| 22 | PAGB/T97.1-6 | 92995-06600 | ARANDELA | WASHER | RONDELLA | RONDELLE | 1 |
| 23 | PAGB/T5783-M6X16 | 97095-06016 | TORNILLO | BOLT | VITE | VIS | 1 |

2T
STROKES

6CMH • 6CWH • 6MSH • 6DMH • 6MH • 6D
8CMH • 8CWH • 8MSH • 8MH • 8D

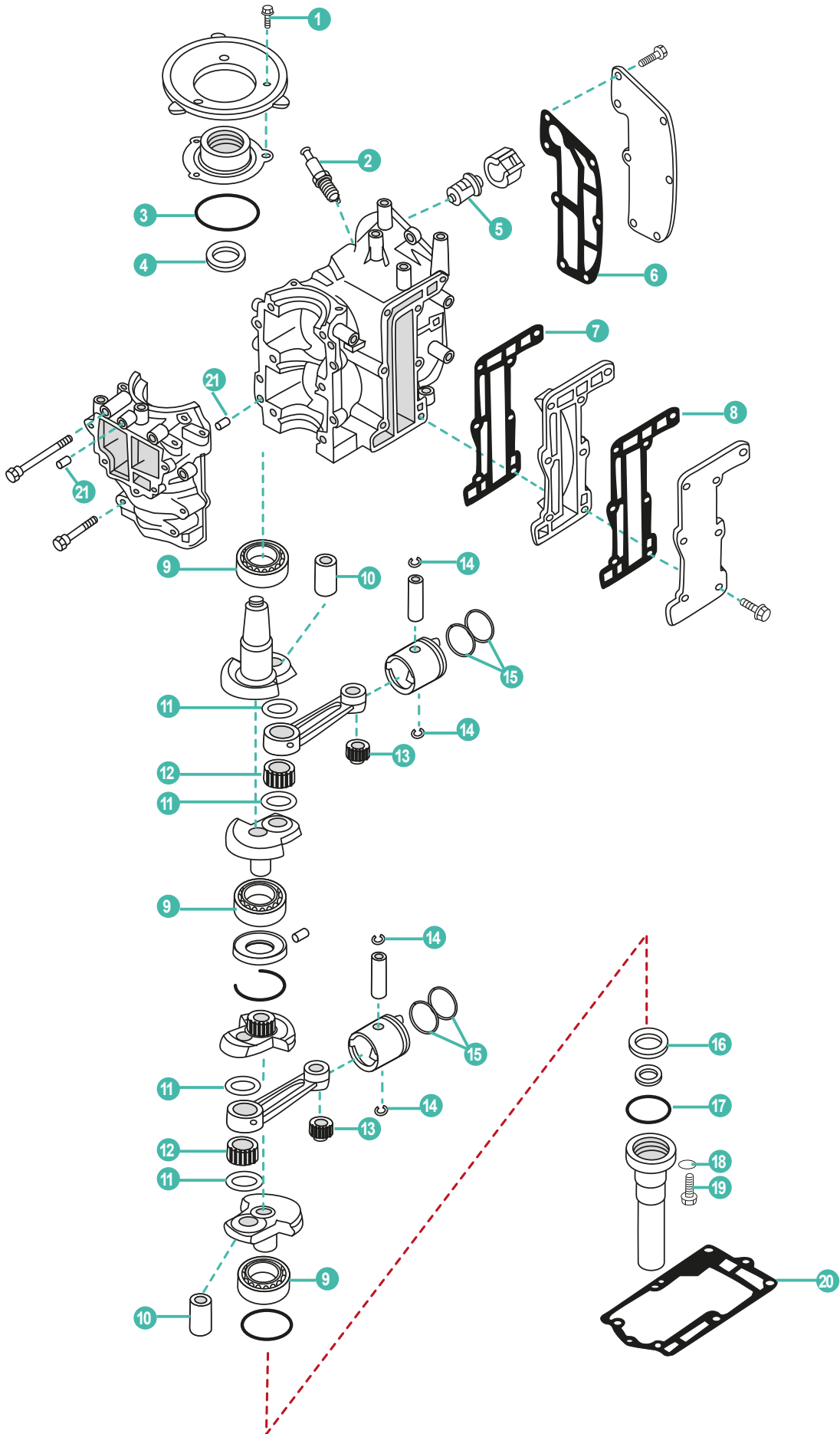

YAMAHA

RECAMBIOS
MARINOS

| | REF | OEM | | | | | UN. |
|----|------------------|--------------|-----------------------------------|--------------------------------|---|---------------------------------------|-----|
| 1 | PAGB/T5783-M5x12 | 97013-06016 | TORNILLO | BOLT | VITE | VIS | 3 |
| 2 | NGKBR7HS-10 | 94702-00271 | BUJÍA | SPARK PLUG | CANDELA | BOUGIE | 2 |
| 2 | NGKBR6HS-10 | 94702-00274 | BUJÍA | SPARK PLUG | CANDELA | BOUGIE | 2 |
| 3 | REC93210-54M54 | 93210-54M54 | TÓRICA | O-RING | O-RING | JOINT TORIQUE | 1 |
| 4 | REC93102-20M25 | 93102-20M25 | RETÉN DE ACEITE | OIL SEAL | PARAOLIO | JOINT SPI | 1 |
| 5 | REC6E5-12411-02 | 6E5-12411-01 | TERMOSTATO | THERMOSTAT | TERMOSTATO | THERMOSTAT | 1 |
| 6 | REC6G1-11193-A1 | 6G1-11193-A1 | JUNTA TAPA TERMOSTATO | GASKET, THERMOSTAT COVER | GUARNIZIONE COPERCHIO TERMOSTATO | JOINT COUVERCLE DE THERMOSTAT | 1 |
| 7 | REC6G1-41112-A1 | 6G1-41112-A1 | JUNTA EXTERIOR, TAPA DE ESCAPE | GASKET, EXHAUST OUTER COVER | GUARNIZIONE ESTERIORE, COPERCHIO SCARICO | JOINT DE COUVERCLE EXT ECHAPPEMENT | 1 |
| 8 | REC6G1-41114-A0 | 6G1-41114-A0 | JUNTA DE ESCAPE | EXHAUST GASKET | GUARNIZIONE DI SCARICO | JOINT D'ECHAPPEMENT | 1 |
| 9 | REC93306-204U0 | 93306-204U0 | RODAMIENTO | BALL BEARING | CUSCINETTO | ROULEMENT À BILLE | 3 |
| 10 | REC6G1-11681-00 | 6G1-11681-00 | PIN | PIN | SPINOTTO | LEVIER D'ENTRAINEMENT | 2 |
| 11 | REC90209-18112 | 90209-18112 | ARANDELA | WASHER | RONDELLA | RONDELLE | 4 |
| 12 | REC93310-418V1 | 93310-418V1 | COJINETE DE BIELA | BEARING, CONNECTING ROD | CUSCINETTO BIELLA | PALIER DE BIELLE | 2 |
| 13 | REC93310-112V0 | 93310-112V0 | COJINETE DE BIELA | BEARING, CONNECTING ROD | CUSCINETTO BIELLA | PALIER DE BIELLE | 2 |
| 14 | REC93450-13022 | 93450-13022 | CIRCLIP | CIRCLIP | CIRCLIP | CIRCLIP | 4 |
| 15 | REC6G1-11610-00 | 6N0-E1603-00 | KIT SEGMENTOS DE PISTÓN | PISTON RING SET | KIT FASCIA PISTONE | KIT SEGMENTS | 2 |
| 16 | REC93101-20M34 | 93101-20M34 | RETÉN DE ACEITE | OIL SEAL | PARAOLIO | JOINT SPI | 1 |
| 17 | REC93210-42159 | 93210-42159 | TÓRICA | O-RING | O-RING | JOINT TORIQUE | 1 |
| 18 | PAGB/T97.1-6 | 92995-06600 | ARANDELA | WASHER | RONDELLA | RONDELLE | 1 |
| 19 | PAGB/T5783-M6X16 | 97095-06016 | TORNILLO | BOLT | VITE | VIS | 1 |
| 20 | REC6G1-45113-A1 | 6G1-45113-A1 | JUNTA BASE MOTOR | GASKET ENGINE | GUARNIZIONE BASE MOTORE | JOINT MOTEUR | 1 |
| 21 | PAF25-04000007 | 93604-08062 | PIN CENTRADOR | HOLLOW PIN | SPINOTTO DI CENTRAGGIO | PIN DE CENTRAGE | 6 |

REC2TU3
REC2TU6REF OEM
REC6G1-W0093-00 6G1-W0093-00

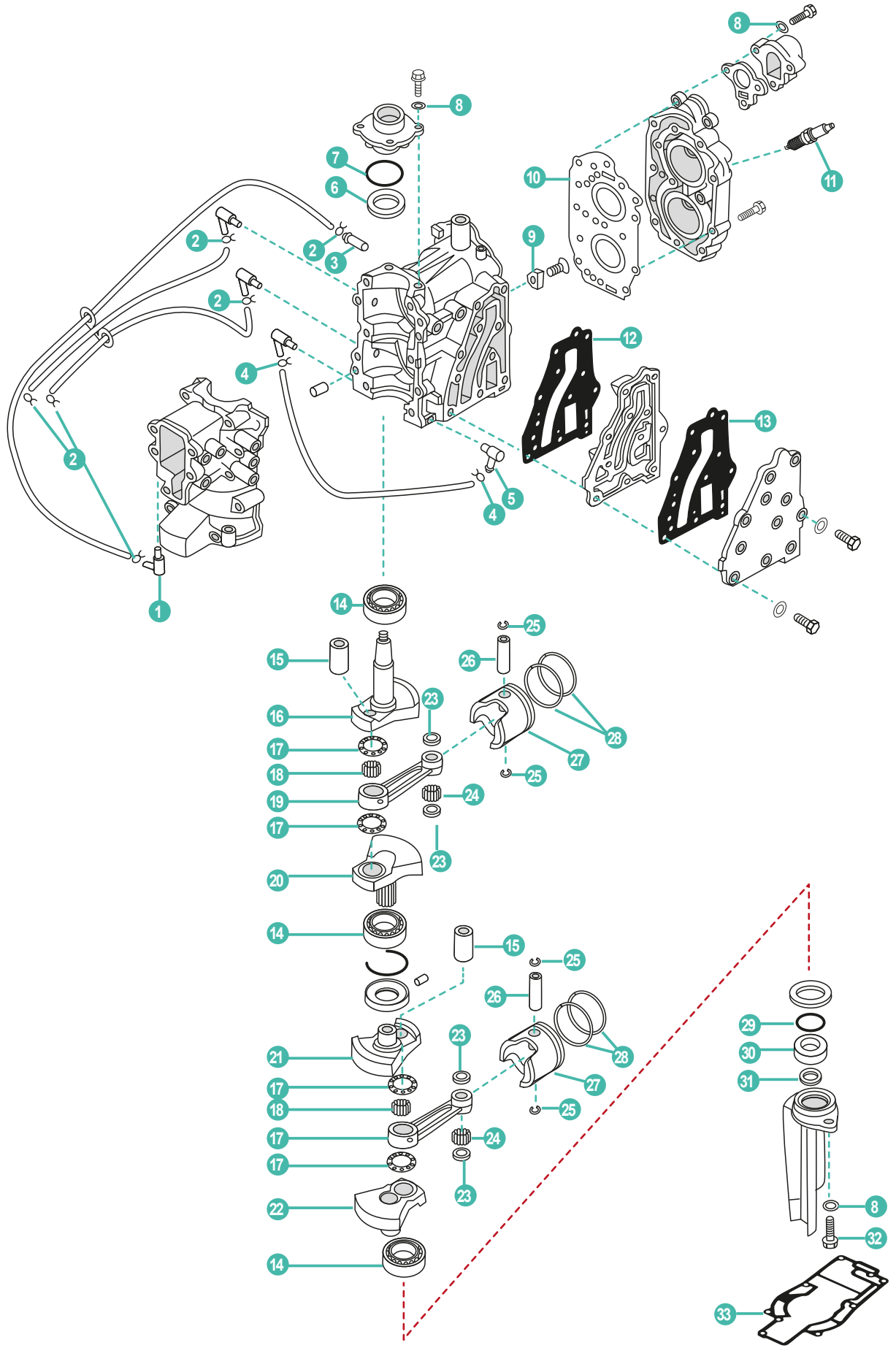

| | REF | OEM | | | | UN. | |
|----|------------------|-----------------|-----------------------------------|--------------------------------|---|---------------------------------------|----|
| 1 | REC650-11370-00 | 650-11370-01 | NIPLE DE MANGUERA | NIPPLE | TUBO | RACCORD D'EAU | 1 |
| 2 | PAHT-2.5X60 | 90467-06016 | PRESILLA | CLIP | CLIP | CLIP | 6 |
| 3 | REC624-14485-00 | 624-14485-00 | PIPA DE AGUA | PIPE, WATER | TUBO | RACCORD TUYAU D'EAU | 1 |
| 4 | PAF4-04000030 | 90467-09M09 | PRESILLA | CLIP | CLIP | CLIP | 2 |
| 5 | PAF15-04000005 | 676-11372-00 | NIPLE DE MANGUERA | NIPPLE | TUBO | RACCORD D'EAU | 1 |
| 6 | REC93102-20M25 | 93102-20M25 | RETÉN DE ACEITE | OIL SEAL | PARAOLIO | JOINT SPI | 1 |
| 7 | REC93210-42159 | 93210-42159 | TÓRICA | O-RING | O-RING | JOINT TORIQUE | 1 |
| 8 | PAGB/T97.1-6 | 92995-06600 | ARANDELA | WASHER | RONDELLA | RONDELLE | 6 |
| 9 | TEN01166 | 664-11325-00 | ÁNODO | ANODE | ANODO | ANODE | 1 |
| 10 | REC677-11181-A0 | 677-11181-A1 | JUNTA CULATA | GASKET, CYLINDER HEAD | GUARNIZIONE TESTATA | JOINT DE CULASSE | 1 |
| 11 | NGKB7HS-10 | 94702-00217 | BUJÍA | SPARK PLUG | CANDELA | BOUGIE | 2 |
| 12 | REC677-41112-A0 | 677-41112-A1 | JUNTA DE ESCAPE | EXHAUST GASKET | GUARNIZIONE DI SCARICO | JOINT D'ECHAPPEMENT | 1 |
| 13 | REC677-41112-A0 | 677-41114-A1 | JUNTA EXTERIOR, TAPA DE ESCAPE | GASKET, EXHAUST OUTER COVER | GUARNIZIONE ESTERIORE, COPERCHIO SCARICO | JOINT DE COUVERCLE EXT ECHAPPEMENT | 1 |
| 14 | REC93306-204U0 | 93306-240U0 | RODAMIENTO | BALL BEARING | CUSCINETTO | ROULEMENT À BILLE | 3 |
| 15 | REC6G1-11681-00 | 6G1-11681-00 | PIN | PIN | SPINOTTO | LEVIER D'ENTRAINEMENT | 2 |
| 16 | REC677-11412-02 | 677-11412-02 | CIGÜEÑAL 1 | CRANK 1 | ALBERO MOTORE 1 | VILEBREQUIN 1 | 1 |
| 17 | REC90209-18112 | 90209-18112 | ARANDELA | WASHER | RONDELLA | RONDELLE | 4 |
| 18 | REC93310-418U0 | 93310-418U0 | COJINETE DE BIELA | BEARING, CONNECTING ROD | CUSCINETTO BIELLA | PALIER DE BIELLE | 2 |
| 19 | REC6E0-11651-01 | 6E0-11651-01 | BIELA | CONNECTING ROD | BIELLA | BIELLE | 2 |
| 20 | REC677-11422-02 | 677-11422-02 | CIGÜEÑAL 2 | CRANK 2 | ALBERO MOTORE 2 | VILEBREQUIN 2 | 1 |
| 21 | REC677-11432-02 | 677-11432-02 | CIGÜEÑAL 3 | CRANK 3 | ALBERO MOTORE 3 | VILEBREQUIN 3 | 1 |
| 22 | REC677-11442-02 | 677-11442-02 | CIGÜEÑAL 4 | CRANK 4 | ALBERO MOTORE 4 | VILEBREQUIN 4 | 1 |
| 23 | REC90201-12565 | 90201-12565 | ARANDELA PLANA | WASHER PLATE | RONDELLA PIANA | RONDELLE | 4 |
| 24 | REC93602-14118 | 93602-14118 | COJINETE DE BIELA | BEARING, CONNECTING ROD | CUSCINETTO BIELLA | PALIER DE BIELLE | 56 |
| 25 | REC93450-13022 | 93450-13022 | CIRCLIP | CIRCLIP | CIRCLIP | CIRCLIP | 4 |
| 26 | REC6G1-11633-00 | 6G1-11633-00 | PIN, PISTÓN | PIN, PISTON | SPINOTTO PISTONE | AXE DE PISTON | 2 |
| | REC677-11631-00K | 677-11631-00-97 | PISTÓN STD | PISTON STD | PISTONE STD | PISTON STD | |
| 27 | REC677-11635-00K | 677-11635-00 | PISTÓN 0.25mm O/S | PISTON 0.25mm O/S | PISTONE 0.25mm O/S | PISTON 0.25mm O/S | 2 |
| | REC677-11636-00K | 677-11636-00 | PISTÓN 0.50mm O/S | PISTON 0.50mm O/S | PISTONE 0.50mm O/S | PISTON 0.50mm O/S | |
| | REC647-11610-00 | 647-11610-00 | KIT SEGMENTOS STD | PISTON RING SET STD | KIT FASCE STD | KIT SEGMENTS STD | |
| 28 | REC647-11610-10 | 647-11610-10 | KIT SEGMENTOS 0.25mm O/S | PISTON RING SET 0.25mm O/S | KIT FASCE 0.25mm O/S | KIT SEGMENTS 0.25mm O/S | 2 |
| | REC647-11610-20 | 647-11610-20 | KIT SEGMENTOS 0.50mm O/S | PISTON RING SET 0.50mm O/S | KIT FASCE 0.50mm O/S | KIT SEGMENTS 0.50mm O/S | |
| 29 | REC93210-42M70 | 93210-42M70 | TÓRICA | O-RING | O-RING | JOINT TORIQUE | 1 |
| 30 | REC93101-20M29 | 93101-20M29 | RETÉN DE ACEITE | OIL SEAL | PARAOLIO | JOINT SPI | 1 |
| 31 | REC93101-14M01 | 93101-14M01 | RETÉN DE ACEITE | OIL SEAL | PARAOLIO | JOINT SPI | 1 |
| 32 | PAGB/T5783-M6X16 | 97095-06016 | PERNO | STUD | BULLONE | BOULON | 2 |
| 33 | REC677-45113-A0 | 677-45113-A0 | JUNTA BASE MOTOR | GASKET ENGINE | GUARNIZIONE BASE MOTORE | JOINT MOTEUR | 1 |

REC2TU3
REC2TU6REF OEM
REC677-W0093-00 677-W0093-00

2T
STROKES

9.9F/FM/FEM/MHV • 9.9FMH/MSH • 13.5AMH • 15F/FEM/FM/MH/MSH • 15FW/MHH

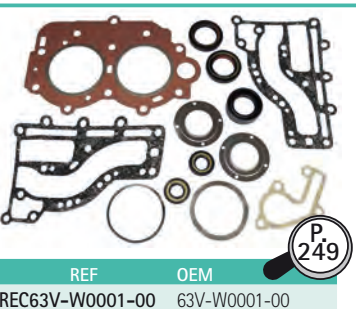
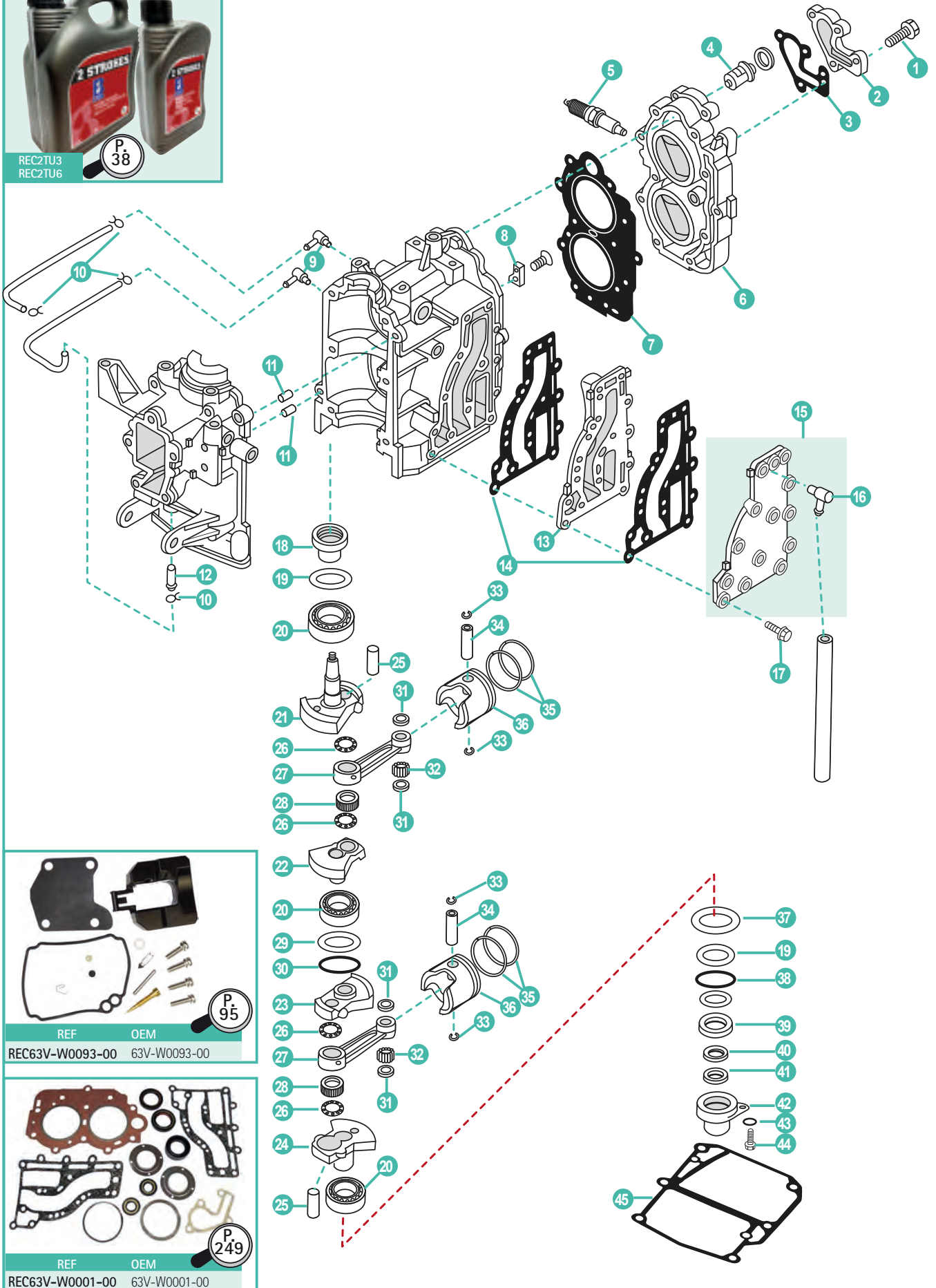

YAMAHA

RECAMBIOS
MARINOS

| | REF | OEM | | | | UN. | |
|----|--------------------|-----------------|--------------------------|----------------------------|----------------------------------|-------------------------------|----|
| 1 | PAGB/T5783-M6X20 | 90119-06MA2 | TORNILLO | BOLT | VITE | VIS | 4 |
| 2 | REC682-12413-00-1S | 682-12413-00-1S | TAPA TERMOSTATO | COVER, THERMOSTAT | COPERCHIO TERMOSTATO | COUVERCLE DE THERMOSTAT | 1 |
| 3 | REC682-12414-A1 | 682-12414-A1 | JUNTA TAPA TERMOSTATO | GASKET, THERMOSTAT COVER | GUARNIZIONE COPERCHIO TERMOSTATO | JOINT COUVERCLE DE THERMOSTAT | 1 |
| 4 | REC6E5-12411-30 | 6E5-12411-30 | TERMOSTATO | THERMOSTAT | TERMOSTATO | THERMOSTAT | 1 |
| 5 | NGKB7HS-10 | 94702-00271 | BUJÍA | SPARK PLUG | CANDELA | BOUGIE | 2 |
| 6 | REC6E7-11111-01-1S | 6E7-11111-01-1S | CULATA | HEAD CYLINDER | TESTATA | CULASSE | 1 |
| 7 | REC63V-11181-A1 | 63V-11181-A2 | JUNTA CULATA | GASKET, CYLINDER HEAD | GUARNIZIONE TESTATA | JOINT DE CULASSE | 1 |
| 8 | TEN01162 | 682-11325-00 | ÁNODO DE ZINC | ZINC ANODE | ANODO ZINCO | ANODE ZINC | 1 |
| 9 | REC650-14485-03 | 650-14485-03 | NIPLE DE MANGUERA | NIPPLE | TUBO | RACCORD D'EAU | 2 |
| 10 | PAHT-2.5X60 | 90467-06016 | BRIDA | CLAMP | FLANGIA | COLLIER | 4 |
| 11 | REC93606-12019 | 93606-12019 | PIN CENTRADOR | HOLLOW PIN | SPINOTTO DI CENTRAGGIO | PIN DE CENTRAGE | 2 |
| 12 | REC624-14485-00 | 624-14485-00 | PIPA DE AGUA | PIPE, WATER | TUBO | RACCORD TUYAU D'EAU | 1 |
| 13 | REC63V-41111-00-1S | 63V-41111-00-1S | PLACA ESCAPE | INNER COVER, EXHAUST | PIASTRA SCARICO | PLAQUE D'ECHAPPEMENT | 1 |
| 14 | REC63V-41112-A0 | 63V-41112-A0 | JUNTA TAPA | GASKET, COVER | GAURNIZIONE COPERCHIO | JOINT COUVERCLE | 2 |
| 15 | REC63V-41113-00-1S | 63V-41113-00-1S | CUBIERTA DE ESCAPE | EXHAUST COVER | COPERCHIO SCARICO | COUVERCLE D'ECHAPPEMENT | 1 |
| 16 | PAF15-04000005 | 676-11372-00 | NIPLE DE MANGUERA | NIPPLE | TUBO | RACCORD D'EAU | 1 |
| 17 | PAGB/T5783-M6X30 | 90119-06M04 | TORNILLO | BOLT | VITE | VIS | 13 |
| 18 | REC93110-23M00 | 93110-23M00 | RETÉN DE ACEITE | OIL SEAL | PARAOLIO | JOINT SPI | 1 |
| 19 | REC63V-11445-00 | 63V-11445-00 | ESPACIADOR | COLLAR | DISTANZIALE | ENTRETOISE | 2 |
| 20 | REC93306-205U7 | 93306-205U7 | RODAMIENTO | BALL BEARING | CUSCINETTO | ROULEMENT À BILLE | 3 |
| 21 | REC63V-11412-00 | 63V-11412-00 | CIGÜEÑAL 1 | CRANK 1 | ALBERO MOTORE 1 | VILEBREQUIN 1 | 1 |
| 22 | REC63V-11422-00 | 63V-11422-00 | CIGÜEÑAL 2 | CRANK 2 | ALBERO MOTORE 2 | VILEBREQUIN 2 | 1 |
| 23 | REC63V-11432-00 | 63V-11432-00 | CIGÜEÑAL 3 | CRANK 3 | ALBERO MOTORE 3 | VILEBREQUIN 3 | 1 |
| 24 | REC63V-11442-00 | 63V-11442-00 | CIGÜEÑAL 4 | CRANK 4 | ALBERO MOTORE 4 | VILEBREQUIN 4 | 1 |
| 25 | REC682-11681-00 | 682-11681-00 | PIN | PIN | SPINOTTO | PIN | 2 |
| 26 | REC90209-20159 | 90209-20M23 | ARANDELA | WASHER | RONDELLA | RONDELLE | 4 |
| 27 | REC650-11651-04 | 650-11651-00 | BIELA | CONNECTING ROD | BIELLA | BIELLE | 2 |
| 28 | REC93310-620V5 | 93310-620V5 | COJINETE DE BIELA | BEARING, CONNECTING ROD | CUSCINETTO BIELLA | PALIER DE BIELLE | 2 |
| 29 | REC63V-11515-02 | 63V-11515-02 | ARILLO | SEAL LABYRINTH | GUARNIZIONE | JOINT | 1 |
| 30 | REC93440-52009 | 93440-52008 | CLIP | CLIP | CLIP | CLIP | 1 |
| 31 | REC90201-14377 | 9020-14377 | ARANDELA | WASHER | RONDELLA | RONDELLE | 4 |
| 32 | REC93602-14104 | 93602-14104 | AGUJAS DE RODAMIENTO | PIN DOWEL | SPILLO CUSCINETTO | AIGUILLE DE PALIER | 50 |
| 33 | REC93450-15023 | 93450-15023 | CIRCLIP | CIRCLIP | CIRCLIP | CIRCLIP | 4 |
| 34 | REC634-11633-00 | 634-11633-00 | PIN, PISTÓN | PIN, PISTON | SPINOTTO PISTONE | AXE DE PISTON | 2 |
| | REC682-11610-01 | 682-11610-01 | KIT SEGMENTOS STD | PISTON RING SET STD | KIT FASCE STD | KIT SEGMENTS STD | |
| 35 | REC682-11610-11 | 682-11610-11 | KIT SEGMENTOS 0.25mm O/S | PISTON RING SET 0.25mm O/S | KIT FASCE 0.25mm O/S | KIT SEGMENTS 0.25mm O/S | 2 |
| | REC682-11610-21 | 682-11610-21 | KIT SEGMENTOS 0.50mm O/S | PISTON RING SET 0.50mm O/S | KIT FASCE 0.50mm O/S | KIT SEGMENTS 0.50mm O/S | |
| | REC6E7-11631-00K | 6E7-11631-00-97 | PISTÓN STD | PISTON STD | PISTONE STD | PISTON STD | |
| 36 | REC6E7-11635-00K | 6E7-11635-00 | PISTÓN 0.25mm O/S | PISTON 0.25mm O/S | PISTONE 0.25mm O/S | PISTON 0.25mm O/S | 2 |
| | REC6E7-11636-00K | 6E7-11636-00 | PISTÓN 0.50mm O/S | PISTON 0.50mm O/S | PISTONE 0.50mm O/S | PISTON 0.50mm O/S | |
| 37 | REC90201-46M29 | 90201-46M29 | ARANDELA | WASHER | RONDELLA | RONDELLE | 1 |
| 38 | REC93210-46M16 | 93210-46M16 | TÓRICA | O-RING | O-RING | JOINT TORIQUE | 1 |
| 39 | REC93102-25M48 | 93102-25M48 | RETÉN DE ACEITE | OIL SEAL | PARAOLIO | JOINT D'HUILE | 1 |
| 40 | REC93101-25018 | 93101-250-18 | RETÉN DE ACEITE | OIL SEAL | PARAOLIO | JOINT D'HUILE | 1 |
| 41 | REC93101-13018 | 93101-13018 | RETÉN DE ACEITE | OIL SEAL | PARAOLIO | JOINT D'HUILE | 2 |
| 42 | REC63V-15396-01-CA | 63V-15396-01-CA | CUERPO DEL RETÉN | SHELL, OIL SEAL | GUARNIZIONE CORPO | LOGEMENT JOINT SPI | 1 |
| 43 | PAGB/T97.1-8 | 92995-06600 | ARANDELA | WASHER | RONDELLA | RONDELLE | 1 |
| 44 | PAGB/T5783-M6X16 | 97095-06016 | TORNILLO | BOLT | VITE | VIS | 1 |
| 45 | REC63V-45113-A1 | 63V-45113-A1 | JUNTA BASE MOTOR | GASKET ENGINE | GUARNIZIONE BASE MOTORE | JOINT DE TETE MOTRICE | 1 |

2T
STROKES

25B/BMH/BWH/VE/B07 • E25BMH/HMH • 30G/HMH/W/HWL/HWC • E30HMH

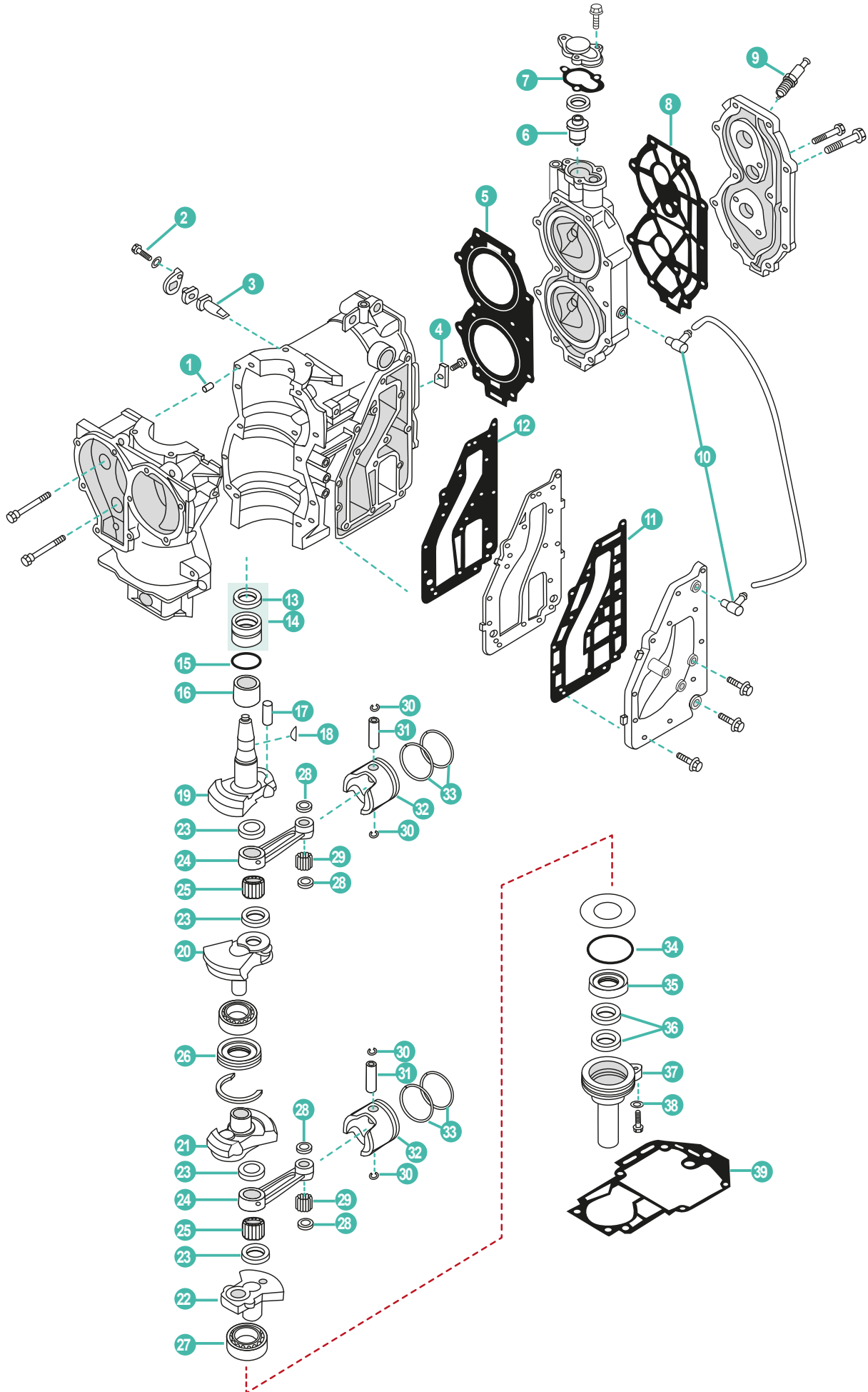

YAMAHA

RECAMBIOS
MARINOS

| | REF | OEM | | | | | UN. |
|----|--------------------|-----------------|--------------------------------|-----------------------------|--|------------------------------------|-----|
| 1 | REC93606-12019 | 93606-12019 | PIN CENTRADOR | HOLLOW PIN | SPINOTTO DI CENTRAGGIO | PIN DE CENTRAGE | 2 |
| 2 | PAGB/T5783-M5X12 | 97013-06016 | TORNILLO | BOLT | VITE | VIS | 1 |
| 3 | TEN01150 | 6J8-11325-00 | ÁNODO DE ZINC | ZINC ANODE | ANODO DI ZINCO | ANODE ZINC | 1 |
| 4 | TEN01121 | 689-11325-00 | ÁNODO DE ZINC | ZINC ANODE | ANODO DI ZINCO | ANODE ZINC | 1 |
| 5 | REC61N-11181-00 | 61N-11181-A1 | JUNTA CULATA | GASKET, CYLINDER HEAD | GUARNIZIONE TESTATA | JOINT DE CULASSE | 1 |
| 6 | REC6E5-12411-02 | 6E5-12411-01 | TERMOSTATO | THERMOSTAT | TERMOSTATO | THERMOSTAT | 1 |
| 7 | REC655-12414-A1 | 655-12414-A1 | JUNTA TAPA TERMOSTATO | GASKET, THERMOSTAT COVER | GUARNIZIONE COPERCHIO TERMOSTATO | JOINT COUVERCLE DE THERMOSTAT | 1 |
| 8 | REC61T-11193-A0 | 61T-11193-A1 | JUNTA TAPA DE CULATA | GASKET, CYLINDER HEAD COVER | GUARNIZIONE COPERCHIO TESTATA | JOINT COUVERCLE DE CULASSE | 1 |
| 9 | NGKBR7HS-10 | 94702-00271 | BUJÍA | SPARK PLUG | CANDELA | BOUGIE | 2 |
| | NGKB7HS-10 | 94702-00217 | BUJÍA | SPARK PLUG | CANDELA | BOUGIE | 2 |
| 10 | PAF15-04000005 | 676-11372-00 | NIPLE DE MANGUERA | NIPPLE | TUBO | RACCORD D'EAU | 2 |
| 11 | REC6K8-41124-A1 | 6K8-41124-A1 | JUNTA EXTERIOR, TAPA DE ESCAPE | GASKET, EXHAUST OUTER COVER | GUARNIZIONE ESTERIORE, COPERCHIO SCARICO | JOINT DE COUVERCLE EXT ECHAPPEMENT | 1 |
| 12 | REC6K8-41122-A1 | 6K8-41122-A1 | JUNTA DE ESCAPE | EXHAUST GASKET | GUARNIZIONE DI SCARICO | JOINT D'ECHAPPEMENT | 1 |
| 13 | REC93102-32M07 | 93102-32M07 | RETÉN DE ACEITE | OIL SEAL | PARAOILIO | JOINT SPI | 1 |
| 14 | REC93399-99951 | 93399-99951 | RODAMIENTO | BEARING | CUSCINETTO | ROULEMENT À BILLE | 1 |
| 15 | REC93210-46M16 | 93210-46M16 | TÓRICA | O-RING | O-RING | JOINT TORIQUE | 1 |
| 16 | REC90387-32002 | 90387-32002 | COLLAR | COLLAR | COLLARE | COLLIER | 1 |
| 17 | REC689-11681-00 | 689-11681-01 | PIN | PIN | SPINOTTO | PIN | 2 |
| 18 | REC90280-05049 | 90280-05049 | CHAVETA | KEY WOODRUFF | CHIAVETTA | CLAVETTE | 1 |
| 19 | REC6G0-11412-00 | 69P-11412-00 | CIGÜEÑAL 1 | CRANK 1 | ALBERO MOTORE 1 | VILEBREQUIN 1 | 1 |
| 20 | REC6G0-11422-00 | 69P-11422-00 | CIGÜEÑAL 2 | CRANK 2 | ALBERO MOTORE 2 | VILEBREQUIN 2 | 1 |
| 21 | REC6G0-11432-00 | 69P-11432-00 | CIGÜEÑAL 3 | CRANK 3 | ALBERO MOTORE 3 | VILEBREQUIN 3 | 1 |
| 22 | REC6G0-11442-00 | 69P-11442-00 | CIGÜEÑAL 4 | CRANK 4 | ALBERO MOTORE 4 | VILEBREQUIN 4 | 1 |
| 23 | REC90209-24M03 | 90209-24M03 | ARANDELA | WASHER | RONDELLA | RONDELLE | 4 |
| 24 | REC689-11651-00 | 689-11651-00 | BIELA | ROD CONNECTING | BIELLA | BIELLE | 2 |
| 25 | REC93310-624U5 | 93310-62406 | COJINETE DE BIELA | BEARING, CONNECTING ROD | CUSCINETTO BIELLA | PALIER DE BIELLE | 2 |
| 26 | REC61N-11515-00 | 61N-11515-00 | ARO | SEAL, LABYRINTH | O-RING | JOINT | 1 |
| 27 | REC93306-305U3 | 93306-305U3 | RODAMIENTO | BEARING | CUSCINETTO | PALIER | 1 |
| 28 | REC90201-20M27 | 90201-20M27 | ARANDELA PLANA | WASHER, PLATE | RONDELLA PIANA | RONDELLE | 4 |
| 29 | REC93602-20M02 | 93602-20M02 | AGUJA PASADOR | NEEDLE PIN | SPILLO | AIGUILLE | 68 |
| | REC93602-18M12 | 93602-18M12 | AGUJAS PASADOR 25N/M & 20D/M | NEEDLE PIN 25N/M & 20D/M | SPILLO 25N/M & 20D/M | AIGUILLE 25N/M & 20D/M | |
| 30 | REC688-11634-00 | 688-11634-00 | CIRCLIP | CIRCLIP | CIRCLIP | CIRCLIP | 4 |
| 31 | REC689-11633-00 | 689-11633-00 | PIN, PISTÓN | PIN, PISTON | SPINOTTO PISTONE | AXE DE PISTON | 2 |
| | REC61N-11631-00K | 61N-11631-00-95 | PISTÓN STD | PISTON STD | PISTONE STD | PISTON STD | 2 |
| 32 | REC61N-11635-00K | 61N-11635-00 | PISTÓN 0.25mm O/S | PISTON 0.25mm O/S | PISTONE 0.25mm O/S | PISTON 0.25mm O/S | 2 |
| | REC61N-11636-00K | 61N-11636-00 | PISTÓN 0.50mm O/S | PISTON 0.50mm O/S | PISTONE 0.50mm O/S | PISTON 0.50mm O/S | 2 |
| | REC61N-11603-00 | 61N-11603-00 | KIT SEGMENTOS STD | PISTON RING SET STD | KIT FASCE STD | KIT SEGMENTS STD | 2 |
| 33 | REC61N-11604-00 | 61N-11604-00 | KIT SEGMENTOS 0.25mm O/S | PISTON RING SET 0.25mm O/S | KIT FASCE 0.25mm O/S | KIT SEGMENTS 0.25mm O/S | |
| | REC61N-11605-00 | 61N-11605-00 | KIT SEGMENTOS 0.50mm O/S | PISTON RING SET 0.50mm O/S | KIT FASCE 0.50mm O/S | KIT SEGMENTS 0.50mm O/S | |
| 34 | REC93210-58M21 | 93210-58M21 | TÓRICA | O-RING | O-RING | JOINT TORIQUE | 1 |
| 35 | REC93102-25008 | 93102-25008 | RETÉN DE ACEITE | OIL SEAL | PARAOILIO | JOINT SPI | 1 |
| 36 | REC93101-16001 | 93101-16001 | RETÉN DE ACEITE | OIL SEAL | PARAOILIO | JOINT SPI | 2 |
| 37 | REC689-15396-01-CA | 689-15396-01-5B | CUERPO DEL RETÉN | SHELL, OIL SEAL | GUARNIZIONE CORPO | LOGEMENT JOINT SPI | 1 |
| 38 | PAGB/T97.1-8 | 92995-06600 | ARANDELA | WASHER | RONDELLA | RONDELLE | 1 |
| 39 | REC61T-45113-A0 | 689-45113-A1 | JUNTA BASE MOTOR | GASKET ENGINE | GUARNIZIONE BASE MOTORE | JOINT DE TETE MOTRICE | 1 |

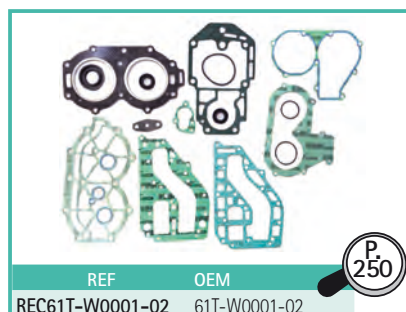

2T
STROKES

25HP J/JEO/ESH • 30HP D/DEO/DETO • 30ELH/ELA • 30DMHO/DMSH • 30ERZ/DEL • 30MLH (1986-13)

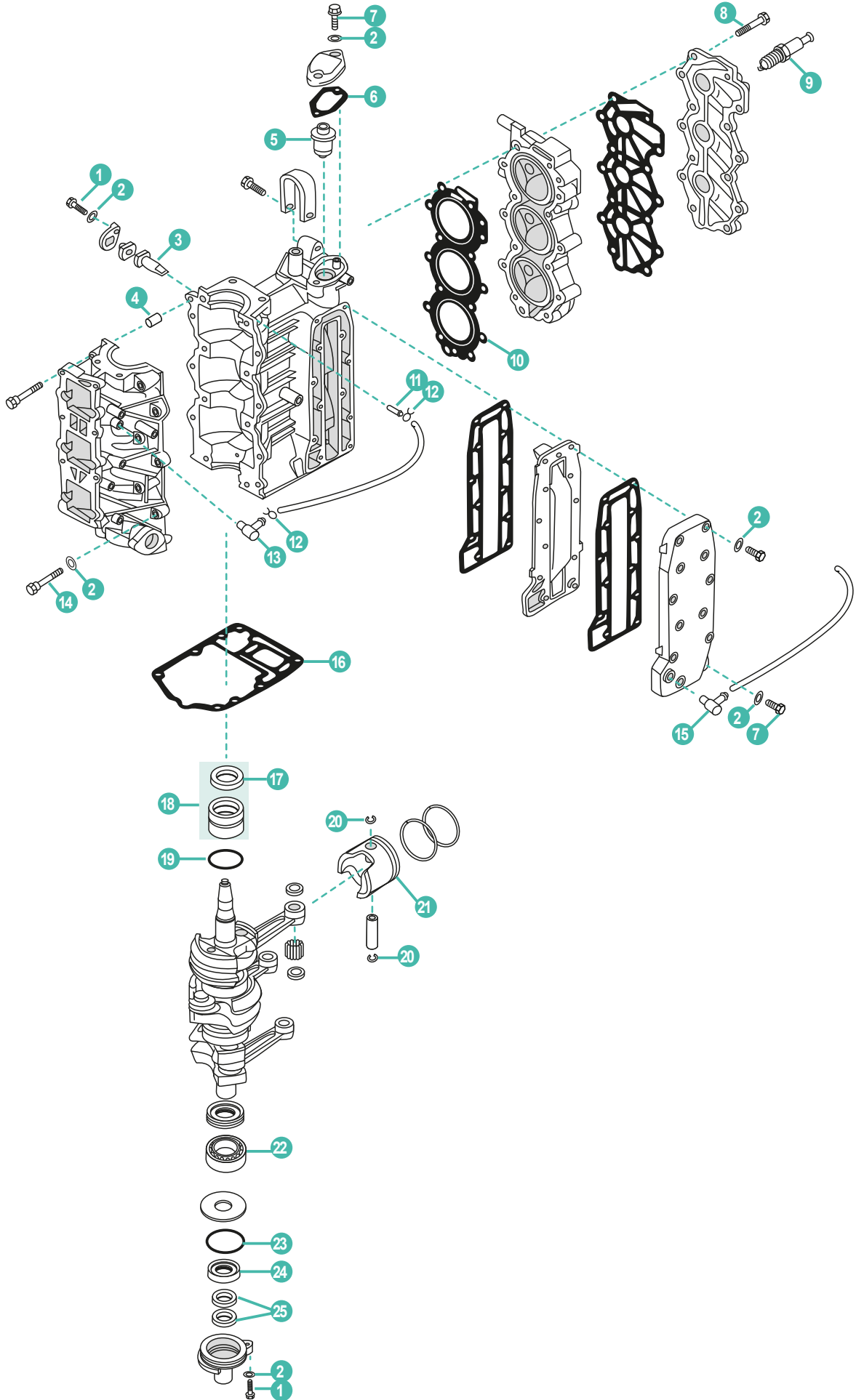

YAMAHA

RECAMBIOS
MARINOS

| | REF | OEM | | | | | UN. |
|----|------------------|-----------------|--------------------------|--------------------------|-------------------------------------|----------------------------------|-----|
| 1 | PAGB/T5783-M6X16 | 97095-06016 | TORNILLO | BOLT | VITE | VIS | 4 |
| 2 | PAGB/T97.1-6 | 92990-06600 | ARANDELA PLANA | FLAT WASHER | RONDELLA PIANA | RONDELLE PLANE | 24 |
| 3 | TEN01150 | 6J8-11325-00 | ÁNODO | ANODE | ANODO | ANODE | 2 |
| 4 | REC93606-12019 | 93606-12019 | PIN CENTRADOR | HOLLOW PIN | SPINOTTO DI CENTRAGGIO | PIN DE CENTRAGE | 2 |
| 5 | REC6E5-12411-02 | 6E5-12411-01 | TERMOSTATO | THERMOSTAT | TERMOSTATO | THERMOSTAT | 1 |
| 6 | REC61A-12414-A0 | 61A-12414-A0 | JUNTA TAPA TERMOSTATO | GASKET, THERMOSTAT COVER | GUARNIZIONE COPERCHIO TERMOSTATO | JOINT COUVERCLE DE THERMOSTAT | 1 |
| 7 | PAGB/T5782-M6X25 | 97095-06025 | TORNILLO | BOLT | VITE | VIS | 3 |
| 8 | REC90119-08M21 | 90119-08M21 | TORNILLO CON ARANDELA | BOLT, FLANGE | VITE CON RONDELLA | VIS DE BRIDE | 14 |
| 9 | NGKBR7HS-10 | 94702-00271 | BUJÍA | SPARK PLUG | CANDELA | BOUGIE | 3 |
| 10 | REC6J8-11181-A2 | 6J8-11181-A1 | JUNTA CULATA | GASKET, CYLINDER HEAD | GUARNIZIONE TESTATA | JOINT DE CULASSE | 1 |
| 11 | REC624-14485-00 | 624-14485-00 | PIPA DE AGUA | PIPE, WATER | TUBO | RACCORD TUYAU D'EAU | 1 |
| 12 | PAHT-2.5X60 | 90467-06016 | PRESILLA | CLAMP | CLIP | COLLIER | 2 |
| 13 | REC650-11370-00 | 650-11370-00 | NIPLA DE MANGUERA | NIPPLE | TUBO | RACCORD D'EAU | 1 |
| 14 | PAGB/T5783-M6X30 | 970-95-06030 | TORNILLO | BOLT | VITE | VIS | 6 |
| 15 | PAF15-04000005 | 676-11372-00 | NIPLA DE MANGUERA | NIPPLE | TUBO | RACCORD D'EAU | 1 |
| 16 | REC6J8-45113-00 | 6J8-45113-A0 | JUNTA BASE MOTOR | GASKET ENGINE | GUARNIZIONE BASE MOTORE | JOINT DE TETE MOTRICE | 1 |
| 17 | REC93102-26M27 | 93102-26M27 | RETÉN DE ACEITE | OIL SEAL | PARAOLIO | JOINT SPI | 1 |
| 18 | REC93311-632U7 | 93311-632U7 | COJINETE DE RODILLOS | BEARING CYL | CUSCINETTO CILINDRO | ROULEMENT | 1 |
| 19 | REC93210-42159 | 93210-42159 | TÓRICA | O-RING | O-RING | JOINT TORIQUE | 1 |
| 20 | PAF25-05020106 | 93450-17129 | CIRCLIP | CIRCLIP | CIRCLIP | CIRCLIP | 6 |
| 21 | REC6J8-11631-02 | 6J8-11631-02-97 | PISTÓN STD | PISTO STD | PISTONE STD | PISTON STD | 3 |
| 22 | REC93306-305U3 | 93306-305U3 | RODAMIENTO | BALL BEARING | CUSCINETTO | ROULEMENT À BILLE | 1 |
| 23 | PAF15-06080003 | 93210-56M80 | TÓRICA | O-RING | O-RING | JOINT TORIQUE | 1 |
| 24 | REC93101-25M35 | 93101-25M28 | RETÉN DE ACEITE | OIL SEAL | PARAOLIO | JOINT SPI | 1 |
| 25 | REC93104-16M01 | 93104-16M04 | RETÉN DE ACEITE | OIL SEAL | PARAOLIO | JOINT SPI | 2 |



2T
STROKES

E40X • 40XMH • E40XMH/XW/XWT

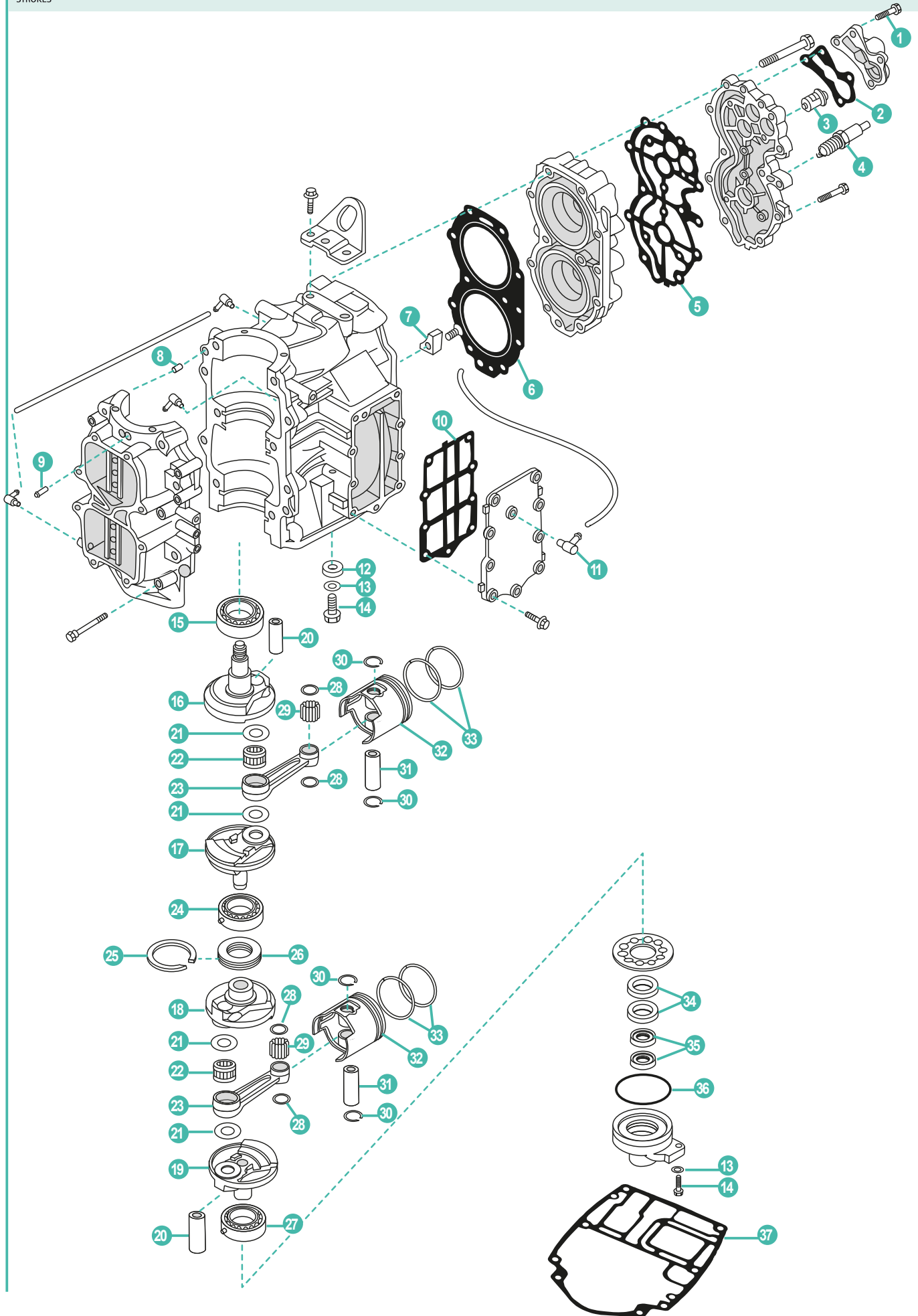

YAMAHA

RECAMBIOS
MARINOS

| | REF | OEM | | | | UN. | |
|----|------------------|-----------------|--------------------------|----------------------------|----------------------------------|-------------------------------|----|
| 1 | PAGB/T5782-M6X35 | 90119-06MA5 | TORNILLO | BOLT WITH WASHER | VITE | VIS | 4 |
| 2 | REC676-12414-A0 | 676-12414-A0 | JUNTA TAPA TERMOSTATO | GASKET, THERMOSTAT COVER | GUARNIZIONE COPERCHIO TERMOSTATO | JOINT COUVERCLE DE THERMOSTAT | 1 |
| 3 | REC6E5-12411-02 | 6E5-12411-01 | TERMOSTATO | THERMOSTAT | TERMOSTATO | THERMOSTAT | 1 |
| 4 | NGKBR7HS | B7H-S0000-00-00 | BUJÍA | SPARK PLUG | CANDELA | BOUGIE | 2 |
| 5 | REC66T-11193-A0 | 66T-11193-A0 | JUNTA DE CULATÍN | HEAD VOER GASKET | GUARNIZIONE TESTATA | JOIN DE COUVRE CULASSE | 1 |
| 6 | REC66T-11181-00 | 66T-11181-A2 | JUNTA CULATA | GASKET, CYLINDER HEAD | GUARNIZIONE TESTATA | JOINT DE CULASSE | 1 |
| 7 | TEN01166 | 676-11325-00 | ÁNODO | ANODE | ANODO | ANODE | 1 |
| 8 | PAF15-00000014 | 93608-12063 | PIN CENTRADOR | HOLLOW PIN | SPINOTTO DI CENTRAGGIO | PIN DE CENTRAGE | 2 |
| 9 | REC624-14485-00 | 624-14485-00 | PIPA DE AGUA | PIPE, WATER | TUBO | RACCORD TUYAU D'EAU | 1 |
| 10 | REC66T-41114-A0 | 66T-41114-A0 | JUNTA TAPA | GASKET, COVER | GUARNIZIONE COPERCHIO | JOINT COUVERCLE | 1 |
| 11 | PAF15-04000005 | 676-11372-00 | NIPLE DE MANGUERA | NIPPLE | TUBO | RACCORD D'EAU | 1 |
| 12 | TEN01127 | 676-45251-00 | ÁNODO | ANODE | ANODO | ANODE | 1 |
| 13 | PAGB/T97.1-8 | 92995-06600 | ARANDELA | WASHER | RONDELLA | RONDELLE | 2 |
| 14 | PAGB/T5783-M6X20 | 97095-06020 | TORNILLO | BOLT | VITE | VIS | 2 |
| 15 | REC93306-307U0 | 93306-307U0 | RODAMIENTO | BEARING | CUSCINETTO | ROULEMENT À BILLE | 1 |
| 16 | REC66T-11412-00 | 66T-11412-00 | CIGÜEÑAL 1 | CRANK 1 | ALBERO MOTORE 1 | VILEBREQUIN 1 | 1 |
| 17 | REC66T-11422-00 | 66T-11422-00 | CIGÜEÑAL 2 | CRANK 2 | ALBERO MOTORE 2 | VILEBREQUIN 2 | 1 |
| 18 | REC66T-11432-00 | 66T-11432-00 | CIGÜEÑAL 3 | CRANK 3 | ALBERO MOTORE 3 | VILEBREQUIN 3 | 1 |
| 19 | REC66T-11442-00 | 66T-11442-00 | CIGÜEÑAL 4 | CRANK 4 | ALBERO MOTORE 4 | VILEBREQUIN 4 | 1 |
| 20 | REC66T-11681-00 | 66T-11681-00 | PIN | PIN | SPINOTTO | PIN D'ENTRAÎNEMENT | 2 |
| 21 | REC90209-27M07 | 90209-27M07 | ARANDELA | WASHER | RONDELLA | RONDELLE | 4 |
| 22 | REC93310-727U0 | 93310-727U0 | RODAMIENTO | BEARING | CUSCINETTO | ROULEMENT | 2 |
| 23 | REC6F5-11651-00 | 6F5-11651-00 | BIELA | ROD CONNECTING | BIELLA | BIELLE | 2 |
| 24 | REC93332-000UE | 93332-000UE | RODAMIENTO | BEARING | CUSCINETTO | ROULEMENT À BILLE | 1 |
| 25 | REC93440-68M03 | 93440-68M03 | CIRCLIP | CIRCLIP | CIRCLIP | CIRCLIP | 1 |
| 26 | REC6F5-11515-00 | 6F5-11515-00 | ARILLO | SEAL, LABERYNTH | GUARNIZIONE TONDA | JOINT | 1 |
| 27 | REC93306-306V5 | 9306-306V5 | RODAMIENTO | BEARING | CUSCINETTO | ROULEMENT | 1 |
| 28 | REC90201-20417 | 90201-20417 | ARANDELA | WASHER PLATE | RONDELLA | RONDELLE | 4 |
| 29 | REC93603-21111 | 93603-21111 | AGUJAS DE RODAMIENTO | PIN, DOWEL | SPINOTTO CENTRAGGIO | AIGUILLE | 56 |
| 30 | REC663-11634-00 | 633-11634-00 | JUNTA | CLIP | GUARNIZIONE | JOINT | 4 |
| 31 | REC6F5-11633-00 | 6F5-11633-00 | PIN, PISTÓN | PIN, PISTON | SPINOTTO PISTONE | AXE DE PISTON | 2 |
| | REC66T-11631-01K | 66T-11631-01-93 | PISTÓN STD | PISTON STD | PISTONE STD | PISTON STD | |
| 32 | REC66T-11635-01K | 66T-11635-01 | PISTÓN 0.25mm O/S | PISTON 0.25mm O/S | PISTONE 0.25mm O/S | PISTON 0.25mm O/S | 2 |
| | REC66T-11636-01K | 66T-11636-01 | PISTÓN 0.50mm O/S | PISTON 0.50mm O/S | PISTONE 0.50mm O/S | PISTON 0.50mm O/S | |
| | REC66T-11603-00 | 66T-11603-00 | KIT SEGMENTOS STD | PISTON RING SET STD | KIT FASCE STD | KIT SEGMENTS STD | |
| 33 | REC66T-11604-00 | 66T-11604-00 | KIT SEGMENTOS 0.25mm O/S | PISTON RING SET 0.25mm O/S | KIT FASCE 0.25mm O/S | KIT SEGMENTS 0.25mm O/S | 2 |
| | REC66T-11605-00 | 66T-11605-00 | KIT SEGMENTOS 0.50mm O/S | PISTON RING SET 0.50mm O/S | KIT FASCE 0.50mm O/S | KIT SEGMENTS 0.50mm O/S | |
| 34 | REC93102-30M56 | 93102-30M56 | RETÉN DE ACEITE | OIL SEAL | PARAOILIO | JOINT SPI | 2 |
| 35 | REC93101-16001 | 93101-16001 | RETÉN DE ACEITE | OIL SEAL | PARAOILIO | JOINT SPI | 2 |
| 36 | REC93210-65M50 | 93210-65M50 | TÓRICA | O-RING | O-RING | JOINT TORIQUE | 1 |
| 37 | REC66T-45113-A0 | 66T-45113-A00 | JUNTA BASE MOTOR | GASKET ENGINE | GUARNIZIONE BASE MOTORE | JOINT DE TETE MOTRICE | 1 |

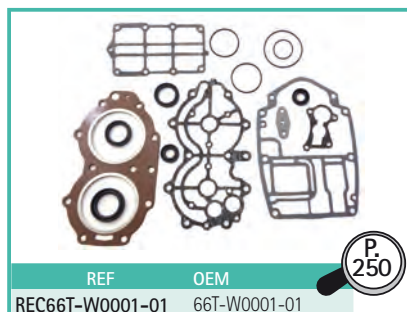

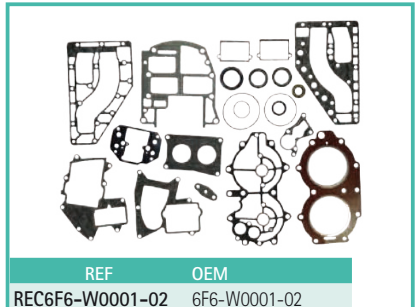
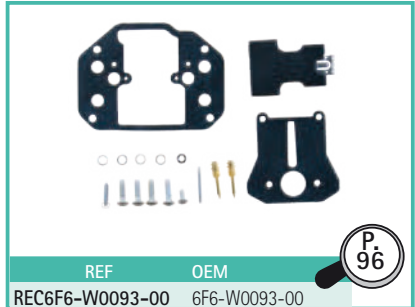
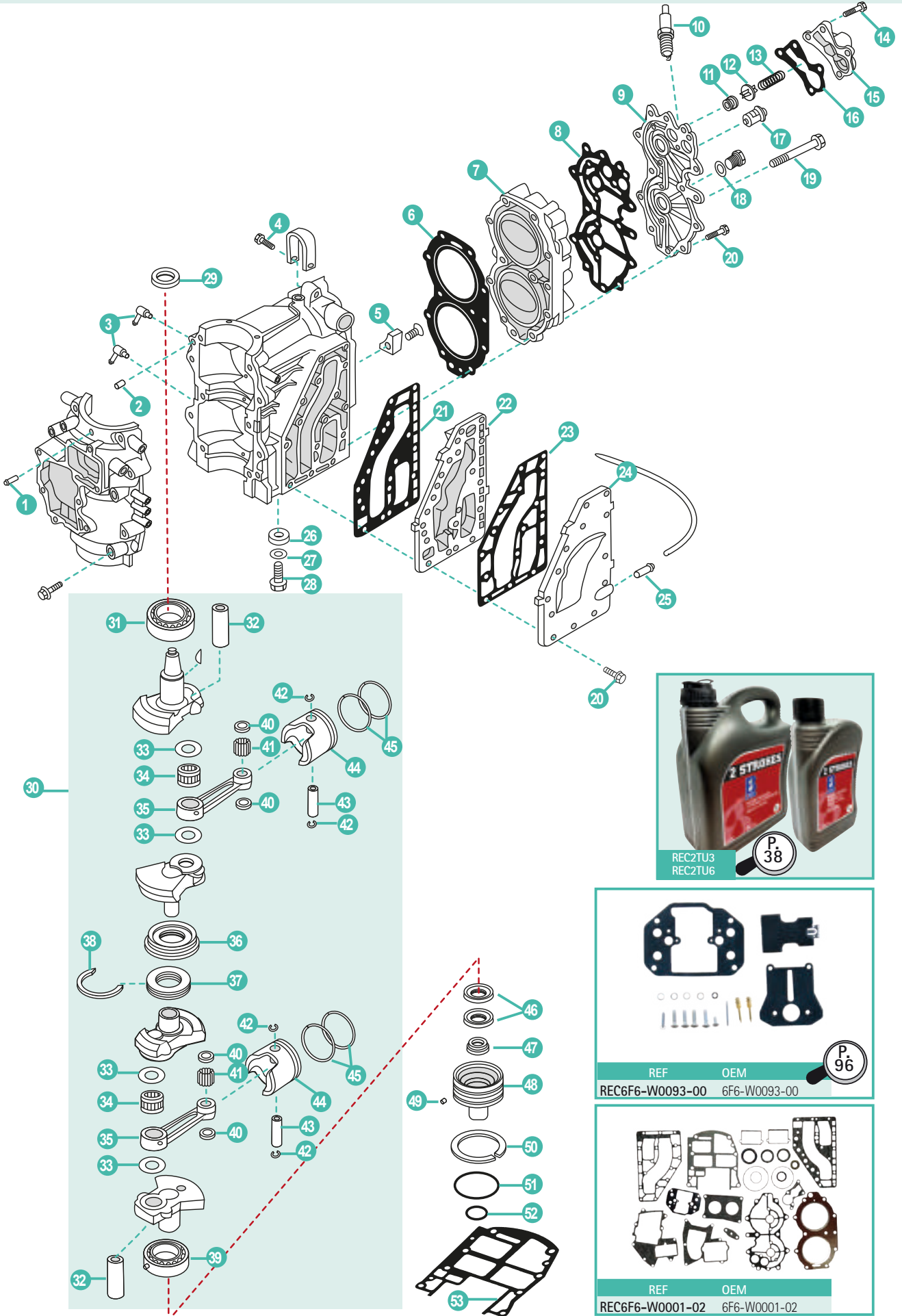

| | REF | OEM | | | | | UN. |
|----|--------------------|-----------------|--------------------------------|-----------------------------|--|------------------------------------|-----|
| 1 | PAT15-04010202 | 624-14485-00 | PIPA DE AGUA | PIPE, WATER | TUBO | RACCORD TUYAU D'EAU | 1 |
| 2 | PAF25-00000014 | 93608-12063 | PIN CENTRADOR | HOLLOW PIN | SPINOTTO DI CENTRAGGIO | PIN DE CENTRAGE | 2 |
| 3 | REC650-11370-00 | 650-11370-01 | NIPLE DE MANGUERA | NIPPLE | TUBO | RACCORD D'EAU | 2 |
| 4 | PAGB/T5783-M8X35 | 90101-08001 | TORNILLO | BOLT | VITE | VIS | 1 |
| 5 | TEN01166 | 676-11325-00 | ÁNODO | ANODO | ANODO | ANODE | 1 |
| 6 | REC6F5-11181-A2 | 6F5-11181-A1 | JUNTA CULATA | GASKET, CYLINDER HEAD | GUARNIZIONE TESTATA | JOINT DE CULASSE | 1 |
| 7 | REC6F6-11111-00-1S | 6F6-11111-00-1S | CULATA DE CILINDRO | CYLINDER HEAD | TESTA CILINDRO | CULASSE | 1 |
| 8 | REC6F6-11193-A1 | 6F6-11193-A1 | JUNTA TAPA | GASKET, COVER | GUARNIZIONE COPERCHIO | JOINT DE COUVRE CULASSE | 1 |
| 9 | REC6F6-11191-00-1S | 6F6-11191-00-1S | TAPA CULATA DE CILINDRO | HEAD CYLINDER COVER | COPERCHIO TESTATA CILINDRO | CUVERCLE DE CULASSE | 1 |
| 10 | NGKB7HS | 94702-00040 | BUJÍA | SPARK PLUG | CANDELA | BOUGIE | 2 |
| 11 | REC90480-18065 | 90480-18065 | TAPÓN | PLUG | TAPPO | BOUCHON | 1 |
| 12 | REC663-12416-00 | 663-12416-00 | VÁLVULA DE PRESIÓN | VALVE, PRESS CONTROL | VALVOLA DI PRESSIONE | SOUPAPE DE PRESSION | 1 |
| 13 | REC90501-14M02 | 90501-14M02 | RESORTE DE COMPRESIÓN | SPRING COMPRESSION | MOLLA DI COMPRESIONE | RESSORT | 1 |
| 14 | PAGB/T5783-M6X30 | 90119-06MA4 | TORNILLO CON ARANDELA | BOLT, FLANGE | VITE CON RONDELLA | VIS DE BRIDE | 4 |
| 15 | REC6E9-12413-00-1S | 6E9-12413-00-1S | TAPA TERMOSTATO | COVER, THERMOSTAT | COPERCHIO TERMOSTATO | COUVERCLE THERMOSTAT | 1 |
| 16 | REC6E9-12414-A1 | 6E9-12414-A1 | JUNTA TAPA TERMOSTATO | GASKET, THERMOSTAT COVER | GUARNIZIONE COPERCHIO TERMOSTATO | JOINT COUVERCLE DE THERMOSTAT | 1 |
| 17 | REC6F5-12411-03 | 6F5-12411-02 | TERMOSTATO | THERMOSTAT | TERMOSTATO | THERMOSTAT | 1 |
| 18 | PAF15-04000003 | 90430-14115 | JUNTA | GASKET | GUARNIZIONE | JOINT | 1 |
| 19 | PAGB/T5783-M6X25 | 90119-08MA5 | TORNILLO | BOLT | VITE | VIS | 11 |
| 20 | PAGB/T5783-M6X25 | 90119-06MA3 | TORNILLO CON ARANDELA | BOLT, FLANGE | VITE CON RONDELLA | VIS DE BRIDE | 20 |
| 21 | REC6F5-41112-A0 | 6F5-41112-A0 | JUNTA DE ESCAPE | EXHAUST GASKET | GUARNIZIONE DI SCARICO | JOINT D'ECHAPPEMENT | 1 |
| 22 | REC6F5-41111-01-1S | 6F5-41111-01-1S | CUBIERTA INTERIOR DE ESCAPE | INNER EXHAUST COVER | COPERCHIO INTERIORE SCARICO | COUVERCLE INTERIEUR D'ECHAPPEMENT | 1 |
| 23 | REC6F5-41114-A0 | 6F5-41114-A0 | JUNTA EXTERIOR, TAPA DE ESCAPE | GASKET, EXHAUST OUTER COVER | GUARNIZIONE ESTERIORE, COPERCHIO SCARICO | JOINT DE COUVERCLE EXT ECHAPPEMENT | 1 |
| 24 | REC6F5-41113-A0-1S | 6F5-41113-01-1S | CUBIERTA EXTERIOR DE ESCAPE | OUTTER EXHAUST COVER | COPERCHIO ESTERNO SCARICO | COUVERCLE EXTERIEUR D'ECHAPPEMENT | 1 |
| 25 | PAF4-04010102 | 650-24378-00 | PIPA DE AGUA | PIPE, WATER | TUBO | RACCORD TUYAU D'EAU | 1 |
| 26 | TEN01127 | 676-45251-00 | ÁNODO | ANODE | ANODO | ANODE | 1 |
| 27 | PAGB/T97.1-6 | 92995-06600 | ARANDELA | WASHER | RONDELLA | RONDELLE | 1 |
| 28 | PAGB/T5783-M6X16 | 97095-06016 | TORNILLO | BOLT | VITE | VIS | 1 |
| 29 | REC93102-35M18 | 93102-35M18 | RETÉN DE ACEITE | OIL SEAL | PARAOILIO | JOINT SPI | 1 |
| 30 | REC6F6-11400-02 | 6F6-11400-01 | CIGÜEÑAL COMPLETO | CRANK ASSY | ALBERO MOTORE COMPLETO | VILEBREQUIN COMPLET | 1 |
| 31 | REC93306-307U0 | 93306-307U0 | RODAMIENTO | BALL BEARING | CUSCINETTO | ROULEMENT À BILLE | 1 |
| 32 | REC6F5-11681-00 | 6F5-11681-00 | PIN | PIN | SPINOTTO | PIN D'ENTRAINEMENT | 2 |
| 33 | REC90209-27M07 | 90209-27M07 | ARANDELA DE SEPARACIÓN | WASHER | RONDELLA DISTANZIALE | RONDELLE | 14 |
| 34 | REC93310-727V7 | 93310-727V7 | COJINETE DE BIELA | BEARING, CONNECTING ROD | CUSCINETTO BIELLA | PALIER DE BIELLE | 2 |
| 35 | REC6F5-11651-00 | 6F5-11651-00 | BIELA | ROD, CONNECTING | BIELLA | BIELLE | 2 |
| 36 | REC93332-000UE | 93332-000UE | COJINETE | BEARING | CUSCINETTO | PALIER | 1 |
| 37 | REC6F5-11515-00 | 6F5-11515-00 | SELLO LABERINTO | LABERINTH SEAL | GUARNIZIONE SIGILLATA | JOINT | 1 |
| 38 | REC93440-68M03 | 93440-68M03 | CIRCLIP | CIRCLIP | CIRCLIP | CIRCLIP | 1 |
| 39 | REC93306-306V1 | 93306-303V1 | COJINETE | BEARING | CUSCINETTO | PALIER | 1 |
| 40 | REC90201-20417 | 90201-20417 | ARANDELA PLANA | FLAT WASHER | RONDELLA PIANA | RONDELLE | 4 |
| 41 | REC93603-21111 | 93603-21111 | AGUJA PASADOR | NEEDLE PIN | SPILLO | CLAVETTE | 56 |
| 42 | REC663-11634-00 | 663-11634-00 | CIRCLIP | CIRCLIP | CIRCLIP | CIRCLIP | 4 |
| 43 | REC6F5-11633-00 | 6F5-11633-00 | PIN, PISTÓN | PIN, PISTON | SPINOTTO PISTONE | AXE DE PISTON | 2 |
| | REC6F6-11631-00K | 6F6-11631-00-95 | PISTÓN STD | PISTON STD | PISTONE STD | PISTON STD | |
| 44 | REC6F6-11635-00K | 6F6-11635-00 | PISTÓN 0.25mm O/S | PISTON 0.25mm O/S | PISTONE 0.25mm O/S | PISTON 0.25mm O/S | 2 |
| | REC6F6-11636-00K | 6F6-11636-00 | PISTÓN 0.50mm O/S | PISTON 0.50mm O/S | PISTONE 0.50mm O/S | PISTON 0.50mm O/S | |
| | REC6F5-11610-00 | 6F6-11610-00 | KIT SEGMENTOS STD | PISTON RING SET STD | KIT FASCE STD | KIT SEGMENTS STD | |
| 45 | REC6F5-11610-10 | 6F6-11610-010 | KIT SEGMENTOS 0.25mm O/S | PISTON RING SET 0.25mm O/S | KIT FASCE 0.25mm O/S | KIT SEGMENTS 0.25mm O/S | 2 |
| | REC6F5-11610-20 | 6F6-11610-020 | KIT SEGMENTOS 0.50mm O/S | PISTON RING SET 0.50mm O/S | KIT FASCE 0.50mm O/S | KIT SEGMENTS 0.50mm O/S | |
| 46 | REC93101-30M33 | 93101-30M33 | RETÉN DE ACEITE | OIL SEAL | PARAOILIO | JOINT SPI | 2 |
| 47 | REC93104-16M01 | 93104-16M01 | RETÉN DE ACEITE | OIL SEAL | PARAOILIO | JOINT SPI | 1 |
| 48 | REC6F5-15396-01-5B | 6F5-15396-01-5B | CUERPO DEL RETÉN | SHELL, OIL SEAL | GUARNIZIONE CORPO | LOGEMENT JOINT SPI | 1 |
| 49 | PAGB/T879.4-3X20 | 91690-30010 | PASADOR DE RESORTE | PIN, SPRING | SPINOTO DI RITORNO | GOUVILLE FENDUE | 1 |
| 50 | REC93440-68M03 | 93440-68M03 | CIRCLIP | CIRCLIP | CIRCLIP | CIRCLIP | 1 |
| 51 | REC93210-65M50 | 93210-65M50 | TÓRICA | O-RING | O-RING | JOINT TORIQUE | 1 |
| 52 | REC93210-22M02 | 93210-22M02 | TÓRICA | O-RING | O-RING | JOINT TORIQUE | 1 |
| 53 | REC6F5-45113-A0 | 6F5-45113-A0 | JUNTA BASE MOTOR | GASKET ENGINE | GUARNIZIONE BASE MOTORE | JOINT DE TETE MOTRICE | 1 |

2T
STROKES

25Q/QEO · 40A/C · 40ELR · 40H/HE · 40MLHZ · 40O/OS · 40TLR · 40V/VE/VEO/VETO/VMHO · 40YETO/Z
50D/DE · 50H/HEDO/HETO/HMHD/HWHDLO/HRDO · 50MTO

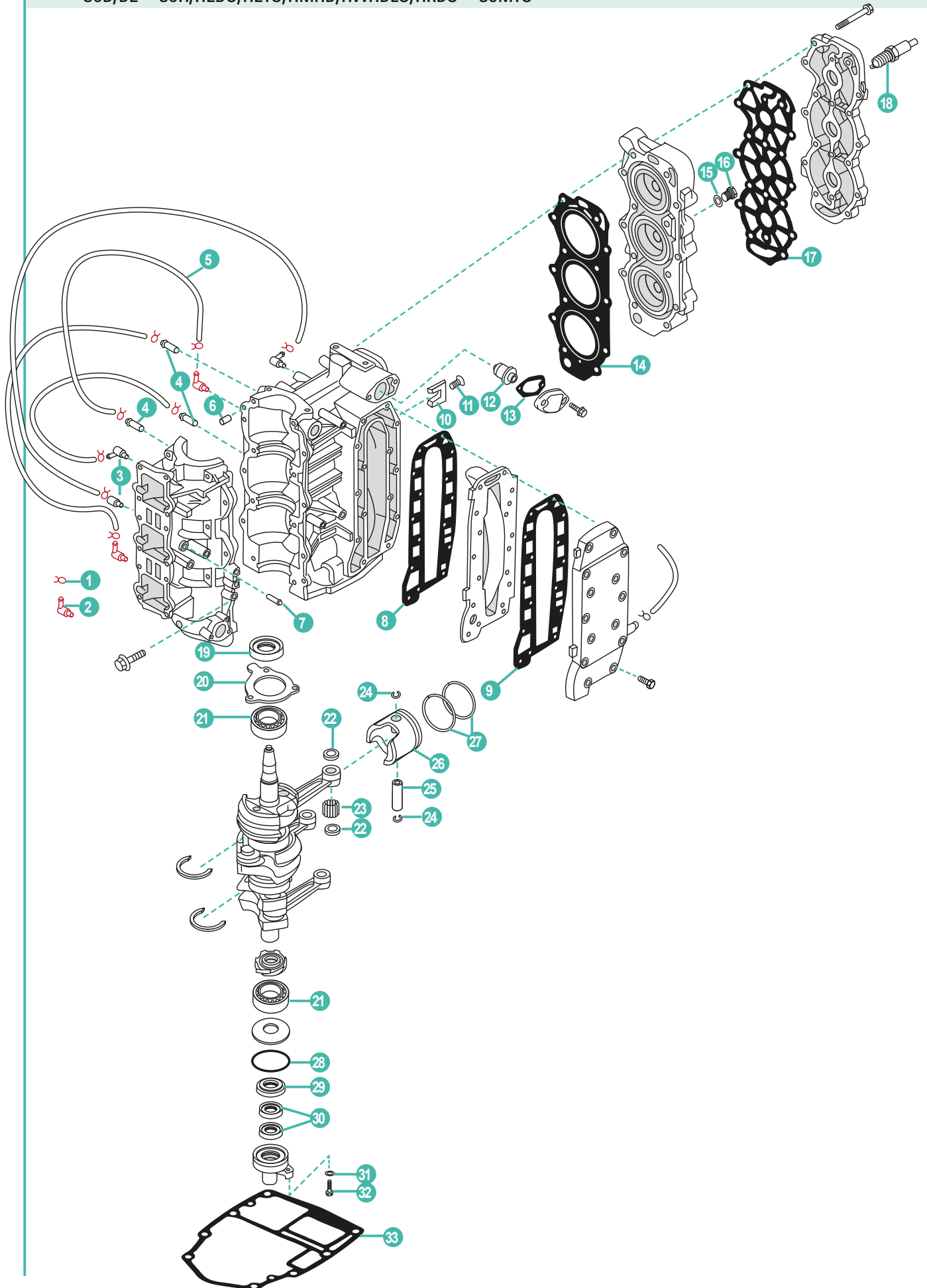

YAMAHA

RECAMBIOS
MARINOS

| | REF | OEM | | | | UN. | |
|----|------------------|-----------------|---------------------------------------|--------------------------------|---|---------------------------------------|----|
| 1 | PAHT-2.5X60 | 90467-06016 | CLIP | CLIP | CLIP | CLIP | 8 |
| 2 | REC688-11370-00 | 688-11370-01 | NIPL DE MANGUERA | NIPPLE | TUBO | RACCORD D'EAU | 2 |
| 3 | REC650-11370-00 | 650-11370-01 | NIPL DE MANGUERA | NIPPLE | TUBO | RACCORD D'EAU | 2 |
| 4 | REC624-14485-00 | 624-14485-00 | PIPA DE AGUA | PIPE, WATER | TUBO | RACCORD TUYAU D'EAU | 3 |
| 5 | PAF2.6-04000015 | 90445-07MA3 | TUBO L200 | HOSE L200 | TUBO L200 | TUYAU L200 | 1 |
| 6 | REC93606-12019 | 93606-12019 | PIN CENTRADOR | HOLLOW PIN | SPINOTTO DI CENTRAGGIO | PIN DE CENTRAGE | 2 |
| 7 | PAF4-04010102 | 650-24378-00 | PIPA DE AGUA | PIPE, WATER | TUBO | RACCORD TUYAU D'EAU | 1 |
| 8 | REC6H4-41112-A0 | 6H4-41112-A0 | JUNTA DE ESCAPE | EXHAUST GASKET | GUARNIZIONE DI SCARICO | JOINT D'ECHAPPEMENT | 1 |
| 9 | REC6H4-41114-A0 | 6H4-41114-A0 | JUNTA EXTERIOR, TAPA DE ESCAPE | GASKET, EXHAUST OUTER COVER | GUARNIZIONE ESTERIORE, COPERCHIO SCARICO | JOINT DE COUVERCLE EXT ECHAPPEMENT | 1 |
| 10 | TEN01147 | 688-11325-00 | ÁNODO | ANODE | ANODO | ANODE | 2 |
| 11 | PAGB/T820-M4X12 | 98780-04016 | TORNILLO | SCREW | VITE | VIS | 2 |
| 12 | REC6E5-12411-30 | 6E5-12411-30 | TERMOSTATO | THERMOSTAT | TERMOSTATO | THERMOSTAT | 1 |
| 13 | REC61A-12414-A0 | 6J8-12414-A0 | JUNTA TAPA TERMOSTATO | GASKET, THERMOSTAT COVER | GUARNIZIONE COPERCHIO TERMOSTATO | JOINT COUVERCLE DE THERMOSTAT | 1 |
| 14 | REC63D-11181-A1 | 63D-11181-A2 | JUNTA CULATA | GASKET, CYLINDER HEAD | GUARNIZIONE TESTATA | JOINT DE CULASSE | 1 |
| 15 | PAF15-04000003 | 90430-14115 | JUNTA | GASKET | GAURNIZIONE | JOINT | 1 |
| 16 | PAF15-04000002 | 90340-14M00 | TAPÓN | PLUG | TAPPO | BOUCHON | 1 |
| 17 | REC63D-11193-A0 | 63D-11193-A0 | JUNTA TAPA | GASKET, COVER | GUARNIZIONE COPERCHIO | JOINT COUVERCLE | 1 |
| 18 | NGKBR8HS-10 | 94702-00247 | BUJÍA | SPARK PLUG | CANDELA | BOUGIE | 3 |
| 18 | NGKBR7HS-10 | 94702-00271 | BUJÍA | SPARK PLUG | CANDELA | BOUGIE | |
| 19 | REC93102-23096 | 93102-23096 | RETÉN DE ACEITE | OIL SEAL | PARAOLIO | JOINT SPI | 1 |
| 20 | REC6H4-15369-A1 | 6H4-15369-A1 | JUNTA DE CUERPO | GASKET, OIL SEAL HOUSING | GUARNIZIONE CORPO | JOINT | 1 |
| 21 | REC93306-305U8 | 93306-305-U8 | RODAMIENTO | BEARING | CUSCINETTO | PALIER | 2 |
| 22 | REC6H4-11641-00 | 6H4-11641-00 | ARANDELA | WASHER | RONDELLA | RONDELLE | 6 |
| 23 | REC93602-20M02 | 93602-20M02 | AGUJA DE RODAMIENTO | BEARING NEEDLE | SPILLO DE CUSCINETTO | CLAVETTE DE PALIER | 93 |
| 24 | REC6H4-11634-01 | 6H4-11634-01 | CIRCLIP | CIRCLIP | CIRCLIP | CIRCLIP | 6 |
| 25 | REC648-11633-00 | 648-11633-00 | PIN, PISTÓN | PIN, PISTON | SPINOTTO PISTONE | AXE DE PISTON | 3 |
| | REC6H4-11631-01K | 6H4-11631-01-95 | PISTÓN STD | PISTON STD | PISTONE STD | PISTON STD | |
| 26 | REC6H4-11635-01K | 6H4-11635-01 | PISTÓN 0.25mm O/S | PISTON 0.25mm O/S | PISTONE 0.25mm O/S | PISTON 0.25mm O/S | 3 |
| | REC6H4-11636-01K | 6H4-11636-01 | PISTÓN 0.50mm O/S | PISTON 0.50mm O/S | PISTONE 0.50mm O/S | PISTON 0.50mm O/S | |
| | REC63D-11603-00 | 63D-11603-00 | KIT SEGMENTOS STD | PISTON RING SET STD | KIT FASCE STD | KIT SEGMENTS STD | |
| 27 | REC63D-11605-00 | 63D-11605-00 | KIT SEGMENTOS DE PISTÓN 0.50mm O/S | PISTON RING SET 0.50mm O/S | KIT FASCE 0.50mm O/S | KIT SEGMENTS 0.50mm O/S | 3 |
| | REC93210-58M21 | 93210-58M21 | TÓRICA | O-RING | O-RING | JOINT TORIQUE | |
| 28 | REC93210-58M21 | 93210-58M21 | TÓRICA | O-RING | O-RING | JOINT TORIQUE | 1 |
| 29 | REC93102-25M28 | 93102-25M28 | RETÉN DE ACEITE | OIL SEAL | PARAOLIO | JOINT SPI | 1 |
| 30 | REC93104-16M01 | 93104-16M01 | RETÉN DE ACEITE | OIL SEAL | PARAOLIO | JOINT SPI | 2 |
| 31 | PAGB/T5783-M5X12 | 92995-06600 | ARANDELA | WASHER | RONDELLA | RONDELLE | 1 |
| 32 | PAGB/T5783-M6X20 | 97095-06020 | TORNILLO | BOLT | VITE | VIS | 1 |
| 33 | REC6H4-45113-00 | 6H4-45113-00 | JUNTA BASE MOTOR | GASKET ENGINE | GUARNIZIONE BASE MOTORE | JOINT DE TETE MOTRICE | 1 |

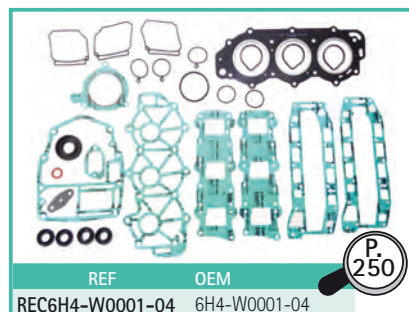
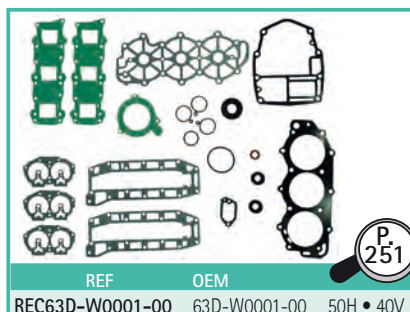

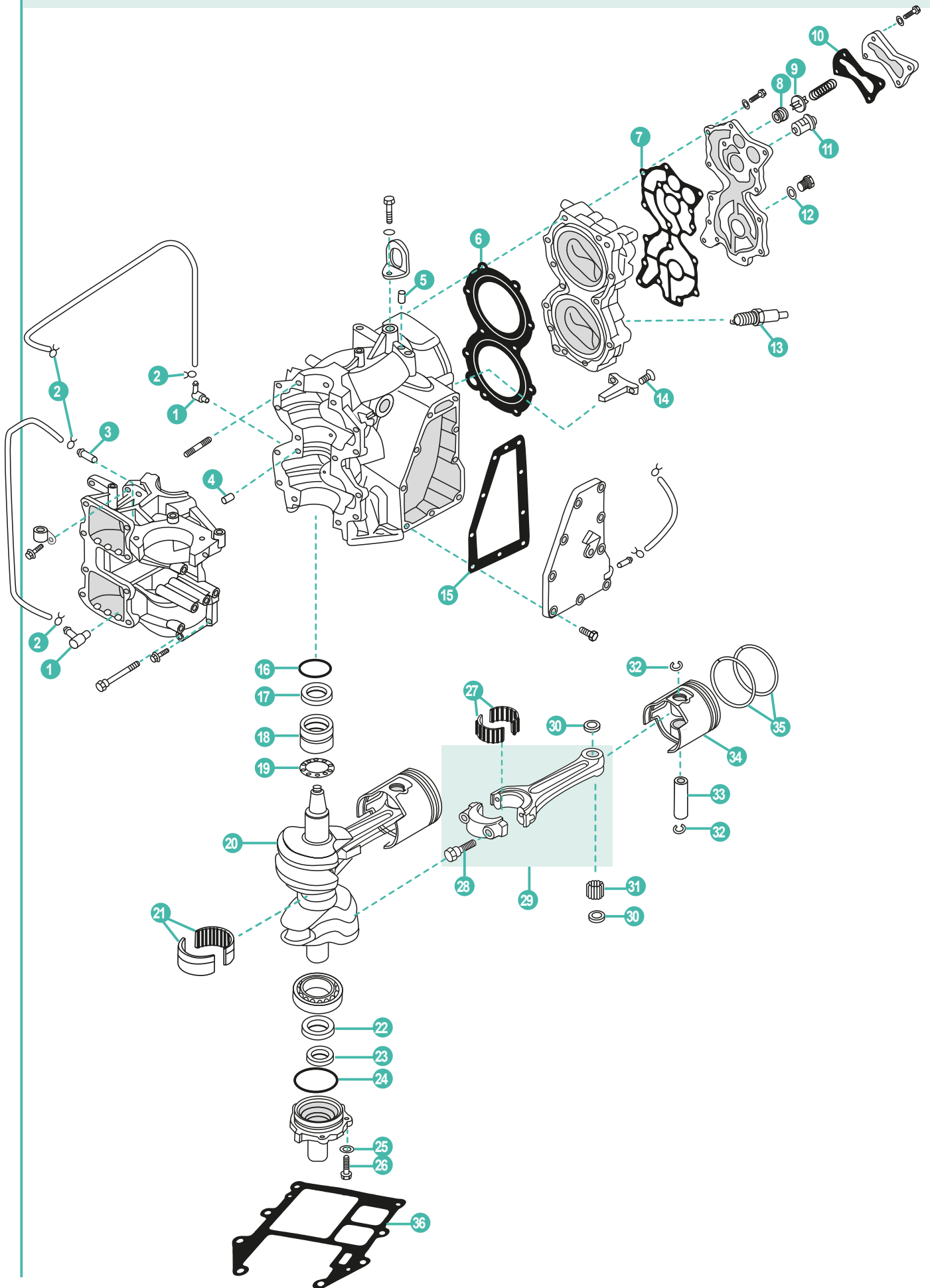

| | REF | OEM | | | | UN. | |
|----|------------------|-----------------|------------------------------------|----------------------------|----------------------------------|-------------------------------|----|
| 1 | REC650-11370-00 | 650-11370-01 | NIPLE DE MANGUERA | NIPPLE | TUBO | RACCORD D'EAU | 2 |
| 2 | PAHT-2.5X60 | 90467-06016 | PRESILLA | CLIP | CLIP | CLIP | 4 |
| 3 | REC624-14485-00 | 624-14485-00 | PIPA DE AGUA | PIPE, WATER | TUBO | RACCORD TUYAU D'EAU | 1 |
| 4 | PAF25-00000014 | 93608-12063 | PIN CENTRADOR | HOLLOW PIN | SPINOTTO DI CENTRAGGIO | PIN DE CENTRAGE | 1 |
| 5 | PAF25-04000007 | 93604-08062 | PIN CENTRADOR | HOLLOW PIN | SPINOTTO DI CENTRAGGIO | PIN DE CENTRAGE | 1 |
| 6 | REC697-11181-A1 | 697-11181-A2 | JUNTA CULATA | GASKET, CYLINDER HEAD | GUARNIZIONE TESTATA | JOINT DE CULASSE | 1 |
| 7 | REC663-11193-00 | 663-11193-A0 | JUNTA TAPA | GASKET, COVER | GUARNIZIONE COPERCHIO | JOINT DE COUVRE CULASSE | 1 |
| 8 | REC90480-18065 | 90480-18065 | TAPÓN | GROMMET | TAPPO | BOUCHON | 1 |
| 9 | REC663-12416-00 | 663-12416-00 | VÁLVULA DE PRESIÓN | VALVE, PRESSURE CONTROL | VALVOLA DI PRESSIONE | SOUPAPE DE PRESION | 1 |
| 10 | REC663-12414-00 | 663-12414-A0 | JUNTA TAPA TERMOSTATO | GASKET, THERMOSTAT COVER | GUARNIZIONE COPERCHIO TERMOSTATO | JOINT COUVERCLE DE THERMOSTAT | 1 |
| 11 | REC6F5-12411-03 | 6F5-12411-02 | TERMOSTATO | THERMOSTAT | TERMOSTATO | THERMOSTAT | 1 |
| 12 | PAF15-04000003 | 90430-14115 | JUNTA | GASKET | GUARNIZIONE | JOINT | 1 |
| | NGKB8HS-10 | 94702-00160 | BUJÍA 55E | SPARK PLUG 55E | CANDELA 55E | BOUGIE 55E | |
| 13 | NGKB7HS | 94702-00040 | BUJÍA E48 | SPARK PLUG E48 | CANDELA E48 | BOUGIE E48 | 2 |
| | NGKB8HS | 94702-00041 | BUJÍA E55C | SPARK PLUG E55C | CANDELA E55C | BOUGIE E55C | |
| 14 | PAGB/T820-M4X12 | 98780-04015 | TORNILLO CABEZA PLANA | SCREW, FLAT HEAD | VITE TESTA PLANA | VIS | 2 |
| 15 | REC663-41114-00 | 663-41114-A0 | JUNTA DE ESCAPE | EXHAUST GASKET | GUARNIZIONE DI SCARICO | JOINT D'ECHAPPEMENT | 1 |
| 16 | REC93210-42159 | 93210-42159 | TÓRICA | O-RING | O-RING | JOINT TORIQUE | 1 |
| 17 | REC93102-32M07 | 93102-32M07 | RETÉN DE ACEITE | OIL SEAL | PARAOLIO | JOINT SPI | 1 |
| 18 | REC93311-632U1 | 93311-632U1 | COJINETE DE RODILLOS | BEARING | CUSCINETTO A RULLI | ROULEMENT À BILLE | 1 |
| 19 | REC663-11561-00 | 663-11561-00 | ARANDELA PLANA | CHIM, RANK | SPESSORE | | 1 |
| 20 | REC663-11411-00 | 663-11411-01 | CIGÜEÑAL | CRANK SHAFT | ALBERO MOTORE | VILEBREQUIN | 1 |
| 21 | REC93311-832U4 | 93311-832U4 | COJINETE DE RODILLOS | BEARING | CUSCINETTO A RULLI | ROULEMENT À BILLE | 1 |
| 22 | REC93102-28135 | 93102-28135 | RETÉN DE ACEITE | OIL SEAL | PARAOLIO | JOINT SPI | 1 |
| 23 | REC93104-18049 | 93104-18049 | RETÉN DE ACEITE | OIL SEAL | PARAOLIO | JOINT SPI | 1 |
| 24 | REC93210-62269 | 93210-62269 | TÓRICA | O-RING | O-RING | JOINT TORIQUE | 1 |
| 25 | PAGB/T97.1-6 | 92995-06600 | ARANDELA | WASHER | RONDELLA | RONDELLE | 3 |
| 26 | PAGB/T5783-M6X16 | 97095-06016 | PERNO | BOLT | PERNO | BOULON | 3 |
| 27 | REC93310-730V8 | 93310-730V8 | COJINETE DE RODILLOS | BEARING | CUSCINETTO A RULLI | ROULEMENT À BILLE | 2 |
| 28 | REC90109-08022 | 90109-08022 | PERNO | BOLT | PERNO | BOULON | 2 |
| 29 | REC688-11650-03 | 688-11650-03 | BIELA COMPLETA | CONNECTING ROD ASSY | BIELLA COMPLETA | BIELLE COMPLÈTE | 2 |
| 30 | REC90201-20417 | 90201-20417 | ARANDELA PLANA | WASHER | RONDELLA PIANA | RONDELLE | 4 |
| 31 | REC93603-21111 | 93603-21111 | AGUJA DE RODAMIENTO | BEARING NEEDLE | SPILLO DE CUSCINETTO | CLAVETTE DE PALIER | 56 |
| 32 | REC688-11634-00 | 688-11634-00 | CIRCLIP | CIRCLIP | CIRCLIP | CIRCLIP | 4 |
| 33 | REC663-11633-00 | 663-11633-00 | PIN, PISTÓN | PIN, PISTON | SPINOTTO PISTONE | AXE DE PISTON | 2 |
| | REC688-11631-03K | 688-11631-03-94 | PISTÓN STD | PISTON STD | PISTONE STD | PISTON STD | |
| 34 | REC688-11635-03K | 688-11635-03 | PISTÓN 0.25mm O/S | PISTON 0.25mm O/S | PISTONE 0.25mm O/S | PISTON 0.25mm O/S | 2 |
| | REC688-11636-03K | 688-11636-03 | PISTÓN 0.50mm O/S | PISTON 0.50mm O/S | PISTONE 0.50mm O/S | PISTON 0.50mm O/S | |
| | REC688-11603-A0 | 688-11603-A0 | KIT SEGMENTOS STD | PISTON RING SET STD | KIT FASCE STD | KIT SEGMENTS STD | |
| 35 | REC688-11605-A0 | 688-11605-A0 | KIT SEGMENTOS DE PISTÓN 0.50mm O/S | PISTON RING SET 0.50mm O/S | KIT FASCE 0.50mm O/S | KIT SEGMENTS 0.50mm O/S | 2 |
| 36 | REC696-45113-00 | 696-45113-00 | JUNTA BASE MOTOR | GASKET ENGINE | GUARNIZIONE BASE MOTORE | JOINT DE TETE MOTRICE | 1 |



REC2TU3
REC2TU6

P
38

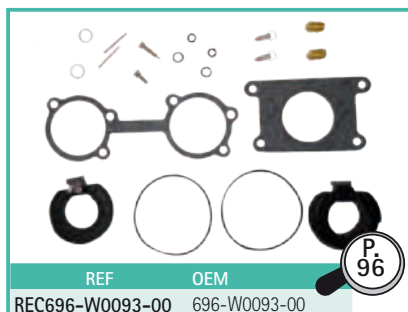

REF OEM
REC696-W0093-00 696-W0093-00

P
96

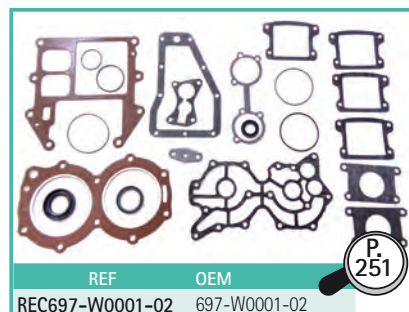

REF OEM
REC697-W0001-02 697-W0001-02

P
251

2T
STROKES

50G/GEO/GETO • 60F/FEDO/FEHT/FEO/FET/FETO • 60TDR/TLR-B/TR-Z • 70B/BEHDO/BEMO/BEO/BETO • 70TDR/TR

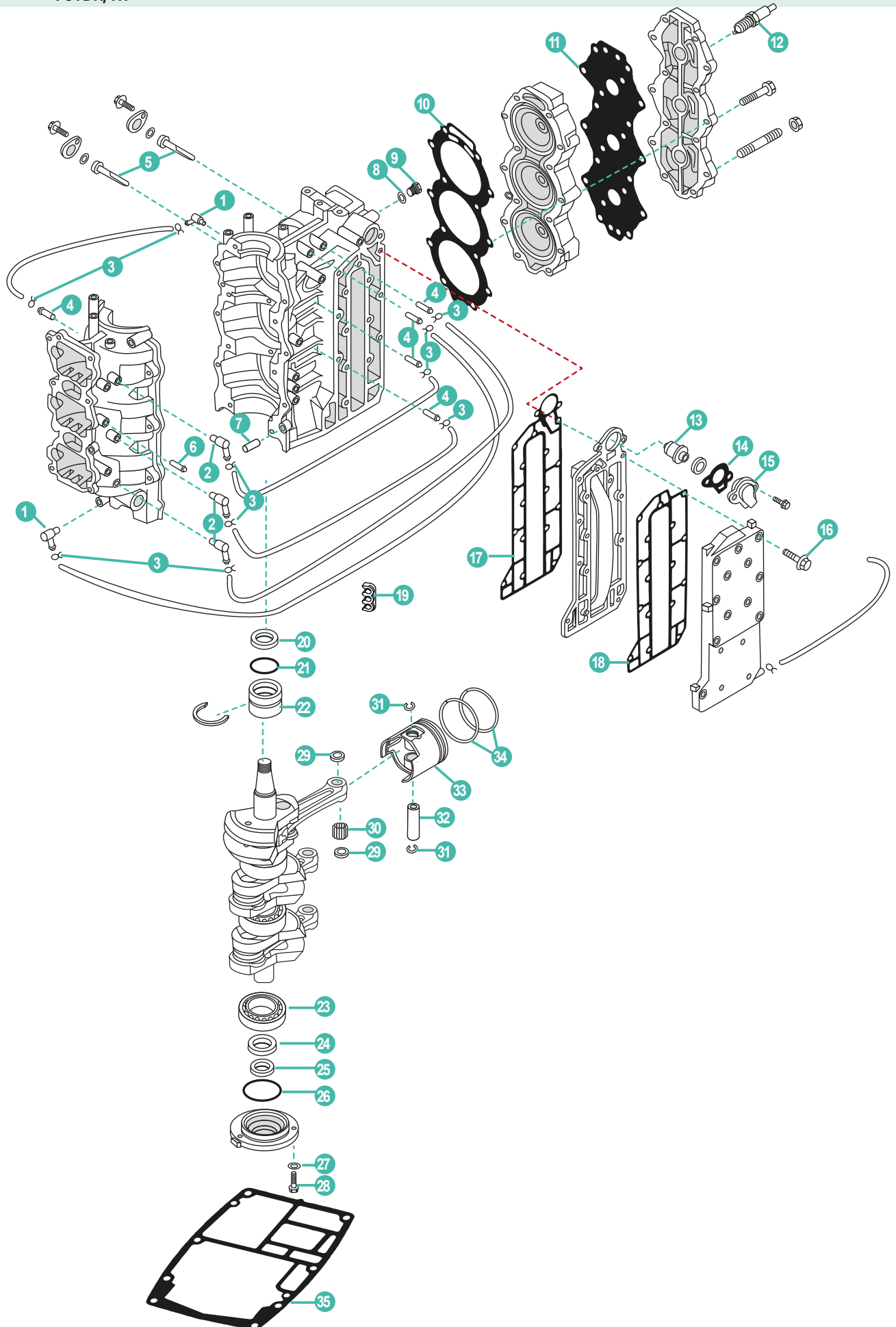

YAMAHA

RECAMBIOS
MARINOS

| | REF | OEM | | | | UN. | |
|----|------------------|-----------------|---------------------------------------|--------------------------------|---|---------------------------------------|----|
| 1 | REC688-11370-00 | 688-11370-01 | NIPLE DE MANGUERA | NIPPLE | TUBO | RACCORD D'EAU | 2 |
| 2 | REC650-11370-00 | 650-11370-01 | NIPLE DE MANGUERA | NIPPLE | TUBO | RACCORD D'EAU | 3 |
| 3 | PAHT-2.5X60 | 90467-06016 | CLIP | CLIP | CLIP | CLIP | 10 |
| 4 | REC624-14485-00 | 624-14485-00 | PIPA DE AGUA | PIPE, WATER | TUBO | RACCORD TUYAU D'EAU | 5 |
| 5 | CM6H3-11325-01A | 6H3-11325-01 | ÁNODO | ANODE | ANODO | ANODE | 2 |
| 6 | PAF4-04010102 | 650-24378-00 | PIPA DE AGUA | PIPE, WATER | TUBO | RACCORD TUYAU D'EAU | 4 |
| 7 | PAF25-00000014 | 93608-12063 | PIN CENTRADOR | HOLLOW PIN | SPINOTTO DI CENTRAGGIO | PIN DE CENTRAGE | 2 |
| 8 | PAF15-04000003 | 90430-14115 | JUNTA | GASKET | GUARNIZIONE | JOINT | 1 |
| 9 | PAF15-04000002 | 90340-14M00 | TAPÓN | PLUG STRAIGHT SREW | TAPPO | BOUCHON | 1 |
| 10 | REC6H3-11181-A0 | 6H3-11181-A2 | JUNTA CULATA | GASKET, CYLINDER HEAD | GUARNIZIONE TESTATA | JOINT DE CULASSE | 1 |
| 11 | REC6H3-11193-A1 | 6H3-11193-A1 | JUNTA CULATÍN | GASKET COVER | GUARNIZIONE COPERCHIO | JOINT DE COUVRE CULASSE | 1 |
| 12 | NGKBR8HS-10 | 94702-00247 | BUJÍA | SPARK PLUG | CANDELA | BOUGIE | 3 |
| 13 | REC6H3-12411-10 | 6H3-12411-10 | TERMOSTATO | THERMOSTAT | TERMOSTATO | THERMOSTAT | 1 |
| 14 | REC6H3-12414-A1 | 6H3-12414-A1 | JUNTA TAPA TERMOSTATO | GASKET, THERMOSTAT COVER | GUARNIZIONE COPERCHIO TERMOSTATO | JOINT COUVERCLE DE THERMOSTAT | 1 |
| 15 | PAF15-07010021 | 6H3-12413-00-1S | TAPA TERMOSTATO | COVER, THERMOSTAT | COPERCHIO TERMOSTATO | COUVERCLE DE THERMOSTAT | 1 |
| 16 | PAGB/T5782-M6X35 | 90119-06MA5 | TORNILLO | BOLT | VITE | VIS | 16 |
| 17 | REC6H3-41112-A0 | 6H3-41112-A0 | JUNTA DE ESCAPE | EXHAUST GASKET | GUARNIZIONE DI SCARICO | JOINT D'ECHAPPEMENT | 1 |
| 18 | REC6H3-41114-A0 | 6H3-41114-A0 | JUNTA EXTERIOR, TAPA DE ESCAPE | GASKET, EXHAUST OUTER COVER | GUARNIZIONE ESTERIORE, COPERCHIO SCARICO | JOINT DE COUVERCLE EXT ECHAPPEMENT | 1 |
| 19 | PAF25-05000016 | 90464-07M05 | ABRAZADERA | CLAMP | FASCETTA | COLLIER | 1 |
| 20 | REC93102-36M24 | 93102-36M24 | RETÉN DE ACEITE | OIL SEAL | PARAOLIO | JOINT SPI | 1 |
| 21 | REC93210-46M16 | 93210-46M16 | TÓRICA | O-RING | O-RING | JOINT TORIQUE | 1 |
| 22 | REC93311-636U6 | 93311-636U6 | RODAMIENTO | BEARING | CUSCINETTO | ROULEMENT À BILLE | 1 |
| 23 | REC93306-306V1 | 93306-306V1 | RODAMIENTO | BEARING | CUSCINETTO | ROULEMENT À BILLE | 1 |
| 24 | REC93102-30M23 | 93102-30M23 | RETÉN DE ACEITE | OIL SEAL | PARAOLIO | JOINT SPI | 1 |
| 25 | REC93106-18M01 | 93106-18M01 | RETÉN DE ACEITE | OIL SEAL | PARAOLIO | JOINT SPI | 1 |
| 26 | REC93210-65M50 | 93210-65M50 | TÓRICA | O-RING | O-RING | JOINT TORIQUE | 1 |
| 27 | PAGB/T97.1-8 | 92995-06600 | ARANDELA | WASHER | RONDELLA | RONDELLE | 3 |
| 28 | PAGB/T5783-M6X20 | 97095-06020 | TORNILLO | BOLT | VITE | VIS | 3 |
| 29 | REC90201-20417 | 90201-20417 | ARANDELA | WASHER | RONDELLA | RONDELLE | 6 |
| 30 | REC93603-18M09 | 93603-18M09 | AGUJA DE RODAMIENTO | BEARING NEEDLE | SPILLO DE CUSCINETTO | CLAVETTE DE PALIER | 84 |
| 31 | REC688-11634-00 | 688-11634-00 | CIRCLIP | CIRCLIP | CIRCLIP | CIRCLIP | 6 |
| 32 | REC6H3-11633-00 | 6H3-11633-00 | PIN, PISTÓN | PIN, PISTON | SPINOTTO PISTONE | AXE DE PISTON | 3 |
| | REC6H3-11631-01K | 6H3-11631-01-96 | PISTÓN STD | PISTON STD | PISTONE STD | PISTON STD | |
| 33 | REC6H3-11635-01K | 6H3-11635-01 | PISTÓN 0.25mm O/S | PISTON 0.25mm O/S | PISTONE 0.25mm O/S | PISTON 0.25mm O/S | 3 |
| | REC6H3-11636-01K | 6H3-11636-01 | PISTÓN 0.50mm O/S | PISTON 0.50mm O/S | PISTONE 0.50mm O/S | PISTON 0.50mm O/S | |
| | REC6K5-11601-02 | 6K5-11601-02 | KIT SEGMENTOS STD | PISTON RING SET STD | KIT FASCE STD | KIT SEGMENTS STD | |
| 34 | REC6K5-11601-12 | 6K5-11601-12 | KIT SEGMENTOS DE PISTÓN 0.25mm O/S | PISTON RING SET 0.25mm O/S | KIT FASCE 0.25mm O/S | KIT SEGMENTS 0.25mm O/S | 3 |
| | REC6K5-11601-22 | 6K5-11601-22 | KIT SEGMENTOS DE PISTÓN 0.50mm O/S | PISTON RING SET 0.50mm O/S | KIT FASCE 0.50mm O/S | KIT SEGMENTS 0.50mm O/S | |
| 35 | REC6H3-45113-00 | 6H3-45113-00 | JUNTA BASE MOTOR | GASKET ENGINE | GUARNIZIONE BASE MOTORE | JOINT DE TETE MOTRICE | 1 |

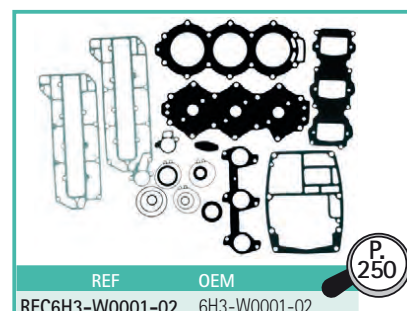
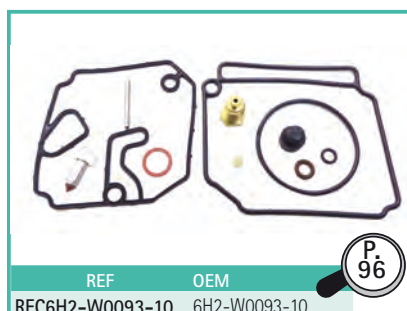

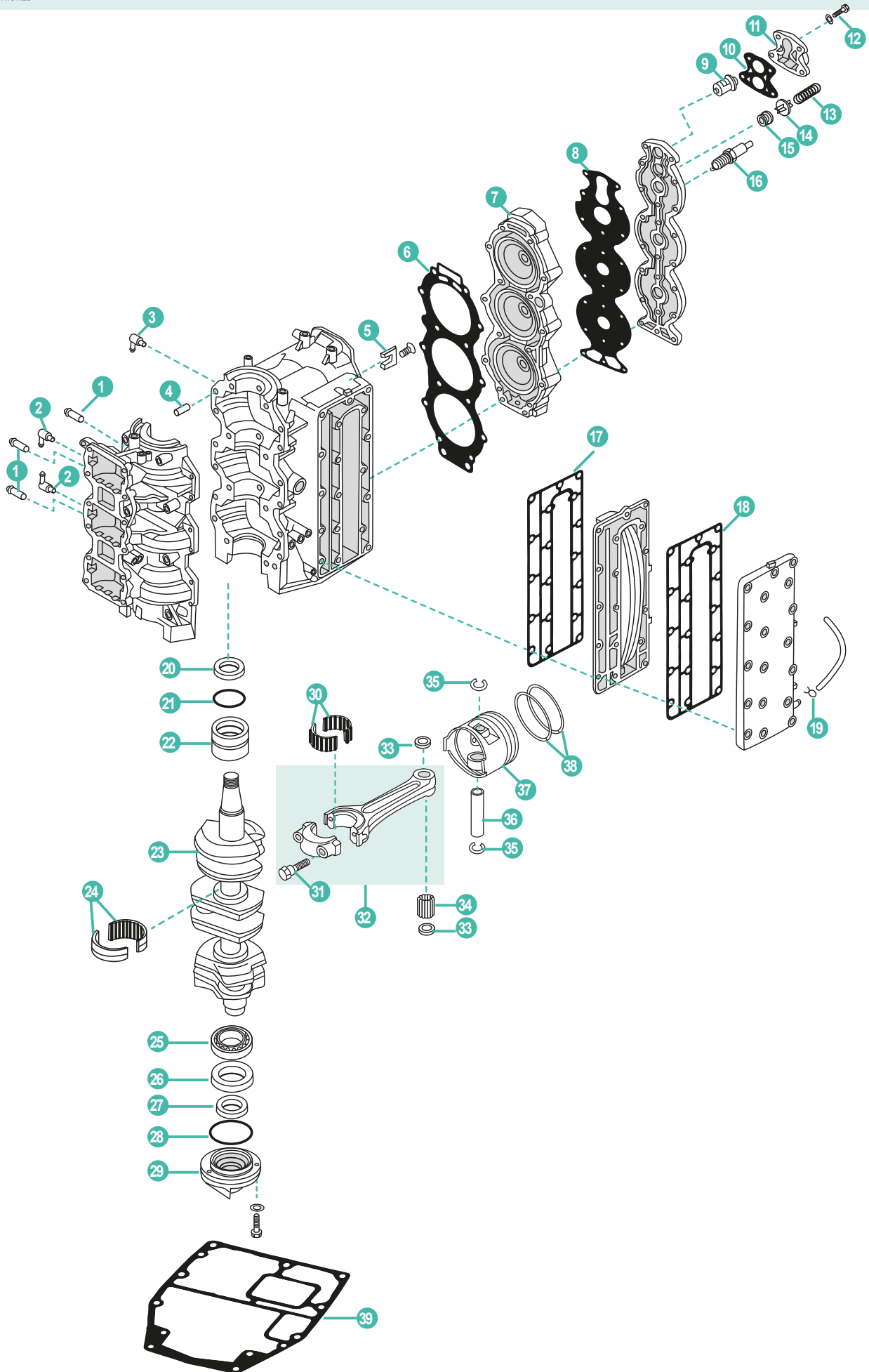

| | REF | OEM | | | | UN. | |
|----|--------------------|-----------------|------------------------------------|-----------------------------|--|------------------------------------|----|
| 1 | REC624-14485-00 | 624-14485-00 | PIPA DE AGUA | PIPE, WATER | TUBO | RACCORD TUYAU D'EAU | 4 |
| 2 | REC688-11370-00 | 688-11370-01 | NIPLE DE MANGUERA | NIPPLE | TUBO | RACCORD D'EAU | 2 |
| 3 | REC650-11370-00 | 650-11370-01 | NIPLE DE MANGUERA | NIPPLE | TUBO | RACCORD D'EAU | 1 |
| 4 | PAF25-00000014 | 93608-12063 | PIN CENTRADOR | HOLLOW PIN | SPINOTTO DI CENTRAGGIO | PIN DE CENTRAGE | 2 |
| 5 | TEN01147 | 688-11325-00 | ÁNODO | ANODE | ANODO | ANODE | 2 |
| 6 | REC688-11181-A1 | 688-11181-A1 | JUNTA CULATA | GASKET, CYLINDER HEAD | GUARNIZIONE TESTATA | JOINT DE CULASSE | 1 |
| 7 | REC688-11111-02-1S | 688-11111-02-1S | CULATA | CYLINDER HEAD | TESTATA | CULASSE | 1 |
| 8 | REC688-11193-A1 | 688-11193-A1 | JUNTA TAPA | GASKET, COVER | GUARNIZIONE COPERCHIO | JOINT DE COUVRE CULASSE | 1 |
| 9 | REC6E5-12411-30 | 688-12411-10 | TERMOSTATO | THERMOSTAT | TERMOSTATO | THERMOSTAT | 1 |
| 10 | REC688-12414-A1 | 688-12414-A1 | JUNTA TAPA TERMOSTATO | GASKET, THERMOSTAT COVER | GUARNIZIONE COPERCHIO TERMOSTATO | JOINT COUVERCLE DE THERMOSTAT | 1 |
| 11 | REC688-12413-00-1S | 688-12413-00-1S | TAPA TERMOSTATO | COVER, THERMOSTAT | COPERCHIO TERMOSTATO | COUVERCLE DE THERMOSTAT | 1 |
| 12 | PAGB/T5783-M6X35 | 90119-06MA5 | TORNILLO | BOLT, WITH WASHER | VITE | VIS | 4 |
| 13 | REC90501-16M11 | 90501-16M11 | MUELLE | SPRING COMPRESSION | MOLLA | RESSORT | 1 |
| 14 | REC688-12416-00 | 688-12416-00 | VÁLVULA CONTROL DE PRESIÓN | VALVE, PRESSURE CONTROL | VALVOLA ANTIPRESSIONE | SOUPAPE DE DEPRESSION | 1 |
| 15 | REC90480-20M05 | 90480-20M05 | JUNTA GOMA | GROMMET | GUARNIZIONE GOMMA | JOINT | 1 |
| 16 | NGKB8HS-10 | 90472-00247 | BUJÍA | SPARK PLUG | CANDELA | BOUGIE | 3 |
| 17 | REC688-41112-A0 | 688-41112-A0 | JUNTA DE ESCAPE | EXHAUST GASKET | GUARNIZIONE DI SCARICO | JOINT D'ECHAPPEMENT | 1 |
| 18 | REC688-41114-A0 | 688-41114-A0 | JUNTA EXTERIOR, TAPA DE ESCAPE | GASKET, EXHAUST OUTER COVER | GUARNIZIONE ESTERIORE, COPERCHIO SCARICO | JOINT DE COUVERCLE EXT ECHAPPEMENT | 1 |
| 19 | PAF4-04000030 | 90467-08004 | PRESILLA | CLAMP | CLIP | CLIP | 1 |
| 20 | REC93102-36M02 | 93102-36M02 | RETÉN DE ACEITE | OIL SEAL | PARAOLIO | JOINT SPI | 1 |
| 21 | REC93210-46M16 | 93210-46M16 | TÓRICA | O-RING | O-RING | JOINT TORIQUE | 1 |
| 22 | REC93310-636U4 | 93310-636U4 | RODAMIENTO | BEARING | CUSCINETTO | PALIER | 1 |
| 23 | REC688-11411-00 | 688-11411-01 | CIGÜEÑAL | CRANK ASSY | ALBERO MOTORE | VILEBREQUIN | 1 |
| 24 | REC93310-835U8 | 93310-835U8 | RODAMIENTO | BEARING | CUSCINETTO | ROULEMENT À BILLE | 2 |
| 25 | REC93306-206U5 | 93306-206U5 | RODAMIENTO | BEARING | CUSCINETTO | ROULEMENT À BILLE | 1 |
| 26 | REC93102-30M05 | 93102-30M05 | RETÉN DE ACEITE | OIL SEAL | PARAOLIO | JOINT SPI | 1 |
| 27 | REC93104-20M02 | 93104-20M02 | RETÉN DE ACEITE | OIL SEAL | PARAOLIO | JOINT SPI | 1 |
| 28 | REC93210-62269 | 93210-62269 | TÓRICA | O-RING | O-RING | JOINT TORIQUE | 1 |
| 29 | REC6H1-15359-01-94 | 6H1-15359-01-94 | CUERPO DEL RETÉN | SHELL, OIL SEAL | GUARNIZIONE CORPO | LOGEMENT JOINT D'HUILE | 1 |
| 30 | REC93310-730V8 | 93310-730V8 | COJINETE DE BIELA | BEARING, CONNECTING ROD | CUSCINETTO BIELLA | PALIER DE BIELLE | 3 |
| 31 | REC90109-08022 | 90109-08022 | TORNILLO | BOLT | VITE | VIS | 2 |
| 32 | REC688-11650-03 | 688-11650-03 | BIELA | CONNECTING ROD ASSY | BEILLA | BIELLE | 3 |
| 33 | REC90201-20417 | 90201-20417 | ARANDELA | WASHER PLATE | RONDELLA | RONDELLE | 6 |
| 34 | REC93603-21111 | 93603-21111 | AGUJA DE RODAMIENTO | BEARING NEEDLE | SPILLO DE CUSCINETTO | CLAVETTE DE PALIER | 84 |
| 35 | REC688-11634-00 | 688-11634-00 | CIRCLIP | CIRCLIP | CIRCLIP | CIRCLIP | 6 |
| 36 | REC663-11633-00 | 663-11633-00 | PIN, PISTÓN | PIN, PISTON | SPINOTTO PISTONE | AXE DE PISTON | 3 |
| 37 | REC688-11631-03K | 688-11631-03-94 | PISTÓN STD | PISTON STD | PISTONE STD | PISTON STD | 3 |
| 38 | REC688-11603-A0 | 688-11603-A0 | KIT SEGMENTOS STD | PISTON RING SET STD | KIT FASCE STD | KIT SEGMENTS STD | 3 |
| | REC688-11605-A0 | 688-11605-A0 | KIT SEGMENTOS DE PISTÓN 0.50mm O/S | PISTON RING SET 0.50mm O/S | KIT FASCE 0.50mm O/S | KIT SEGMENTS 0.50mm O/S | 3 |
| 39 | REC688-45113-A0 | 688-45113-A0 | JUNTA BASE MOTOR | GASKET ENGINE | GUARNIZIONE BASE MOTORE | JOINT DE TETE MOTRICE | 1 |

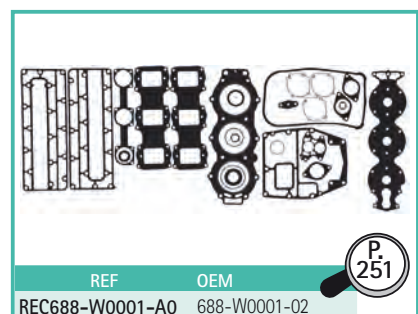

2T
STROKES

100A/AETO • 100TLR • 115AEL/B/BETO/BE-TR/C/CEO/CETO • C115TLR • 130B/BETO • 130TLR/TLRZ • 140A • 140B

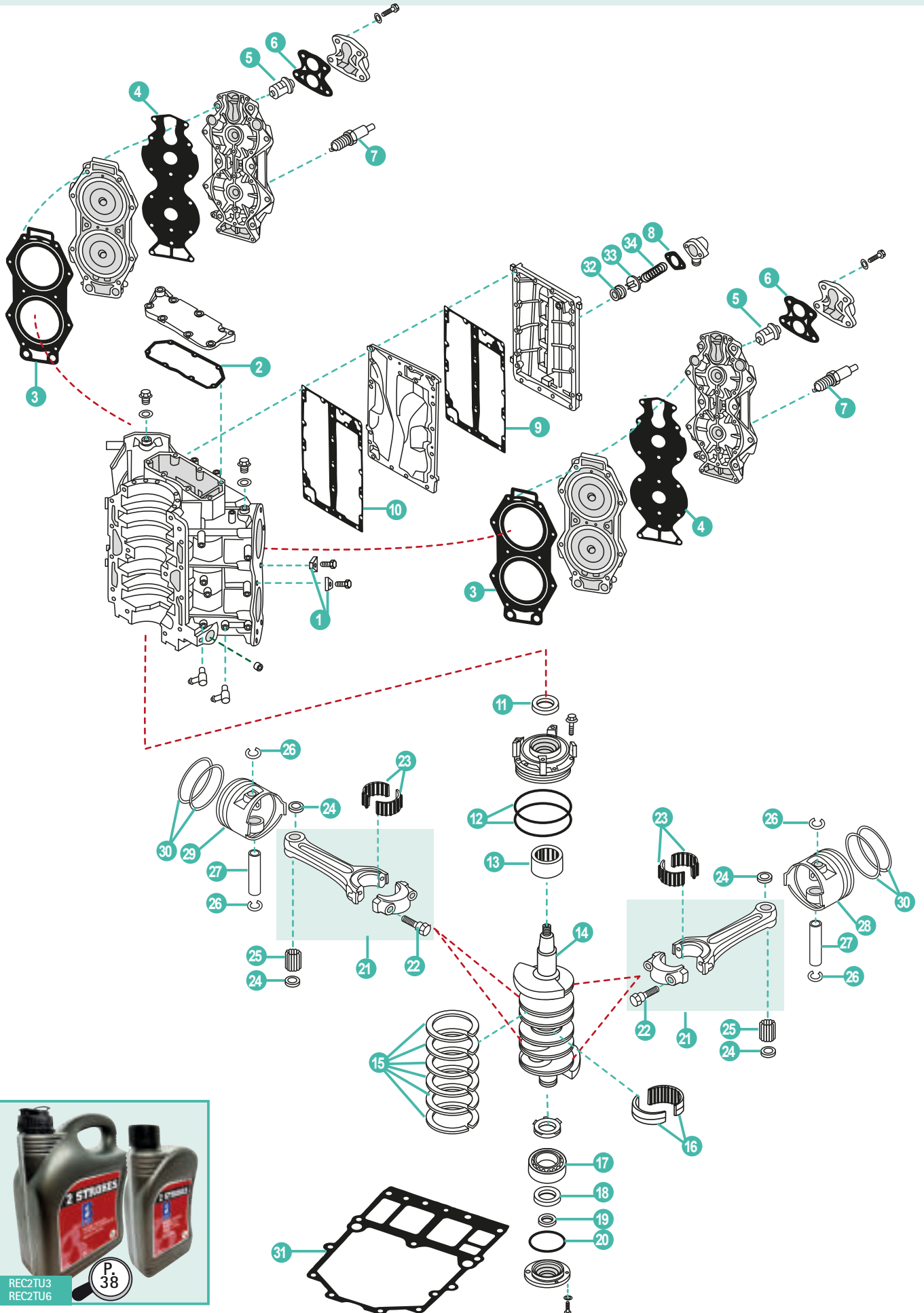

YAMAHA

RECAMBIOS
MARINOS

| | REF | OEM | | | | UN. | |
|----|------------------|-----------------|------------------------------------|-----------------------------|--|------------------------------------|---|
| 1 | TEN01152 | 6E5-11325-00 | ÁNODO | ANODE | ANODO | ANODE | 4 |
| 2 | REC6E5-11381-A1 | 6E5-11381-A2 | JUNTA | GASKET | GUARNIZIONE | JOINT | 1 |
| 3 | REC6E5-11181-A0 | 6E5-11181-A2 | JUNTA CULATA | GASKET, CYLINDER HEAD | GUARNIZIONE TESTATA | JOINT DE CULASSE | 2 |
| 4 | REC6E5-11193-A0 | 6E5-11193-A0 | JUNTA CULATÍN | GASKET, HEAD COVER | GUARNIZIONE COPERCHIO TESTA | JOINT DE COUVRE CULASSE | 2 |
| 5 | REC6E5-12411-30 | 6E5-12411-30 | TERMOSTATO | THERMOSTAT | TERMOSTATO | THERMOSTAT | 2 |
| 6 | REC688-12414-A1 | 688-12414-A1 | JUNTA TAPA TERMOSTATO | GASKET, THERMOSTAT COVER | GUARNIZIONE COPERCHIO TERMOSTATO | JOINT COUVERCLE DE THERMOSTAT | 2 |
| 7 | NGKBR8HS-10 | 94702-00247 | BUJÍA 100, 115 | SPARK PLUG 100, 115 | CANDELA 100, 115 | BOUGIE 100, 115 | 4 |
| | NGKBR9HS-10 | 94702-00309 | BUJÍA 130 | SPARK PLUG 130 | CANDELA 130 | BOUGIE 130 | |
| 8 | REC6G5-11382-A1 | 6G5-11382-A1 | JUNTA | GASKET | GUARNIZIONE | JOINT | 1 |
| 9 | REC6E5-41112-A1 | 6E5-41112-A1 | JUNTA EXTERIOR, TAPA DE ESCAPE | GASKET, EXHAUST OUTER COVER | GUARNIZIONE ESTERIORE, COPERCHIO SCARICO | JOINT DE COUVERCLE EXT ECHAPPEMENT | 1 |
| 10 | REC6E5-41112-A1 | 6E5-41112-A1 | JUNTA DE ESCAPE | EXHAUST GASKET | GUARNIZIONE DI SCARICO | JOINT D'ECHAPPEMENT | 1 |
| 11 | REC93102-40M14 | 93102-40M14 | RETÉN DE ACEITE | OIL SEAL | PARAOLIO | JOINT SPI | 1 |
| 12 | REC93211-04001 | 93211-04001 | TÓRICA | O-RING | O-RING | JOINT TORIQUE | 2 |
| 13 | REC93311-940U3 | 93311-940U3 | RODAMIENTO | BALL BEARING | CUSCINETTO | ROULEMENT À BILLE | 1 |
| 14 | REC6N7-11411-00 | 6N7-11411-00 | CIGÜEÑAL | CRANKSHAFT | ALBERO MOTORE | VILEBREQUIN | 1 |
| 15 | REC6E5-11447-00 | 6E5-11447-00 | ARO | SEAL, CRANK | O-RING | JOINT TORIQUE | 6 |
| 16 | REC93310-954U1 | 93310-954U1 | RODAMIENTO | BALL BEARING | CUSCINETTO | ROULEMENT À BILLE | 1 |
| 17 | REC93306-208U0 | 93306-208U0 | RODAMIENTO | BALL BEARING | CUSCINETTO | ROULEMENT À BILLE | 1 |
| 18 | REC93102-35M13 | 93102-35M13 | RETÉN DE ACEITE | OIL SEAL | PARAOLIO | JOINT SPI | 1 |
| 19 | REC93101-22M15 | 93101-22M15 | RETÉN DE ACEITE | OIL SEAL | PARAOLIO | JOINT SPI | 1 |
| 20 | REC93210-74M35 | 93210-74M35 | TÓRICA | O-RING | O-RING | JOINT TORIQUE | 1 |
| 21 | REC6R5-11650-10 | 6R5-116950-0 | BIELA | CONNECTING ROD ASSY | BIELLA | BIELLE | 4 |
| 22 | REC90109-08M71 | 90109-08M71 | TORNILLO | BOLT | VITE | VIS | 8 |
| 23 | REC93310-836V2 | 93310-836V2 | COJINETE DE BIELA | BEARING, CONNECTING ROD | CUSCINETTO BIELLA | PALIER DE BIELLE | 4 |
| 24 | REC90201-23M01 | 90201-23M01 | ARANDELA | WASHER | RONDELLA | RONDELLE | 8 |
| 24 | REC90201-21M75 | 90201-21M75 | ARANDELA | WASHER | RONDELLA | RONDELLE | 8 |
| 25 | REC93310-32337 | 93310-323V6 | AGUJA DE RODAMIENTO | BEARING NEEDLE | SPILLO DE CUSCINETTO | CLAVETTE DE PALIER | 4 |
| 26 | REC6R5-11634-00 | 6R5-11634-10 | CIRCLIP | CIRCLIP | CIRCLIP | CIRCLIP | 8 |
| 27 | REC6R5-11633-00 | 6R5-11633-10 | PIN, PISTÓN | PIN, PISTON | SPINOTTO PISTONE | AXE DE PISTON | 4 |
| 28 | REC6R5-11642-01K | 6R5-11642-11-93 | PISTÓN STD 2 | PISTON STD 2 | PISTONE STD 2 | PISTON STD 2 | 2 |
| 29 | REC6R5-11631-11K | 6R5-11361-11-93 | PISTÓN STD 1 | PISTON STD 1 | PISTONE STD 1 | PISTON STD 1 | 2 |
| | REC64D-11603-01 | 64D-11603-01 | KIT SEGMENTOS DE PISTÓN STD | PISTON RING SET STD | KIT FASCE STD | KIT SEGMENTS STD | |
| 30 | REC64D-11604-01 | 64D-11604-01 | KIT SEGMENTOS DE PISTÓN 0.25mm O/S | PISTON RING SET 0.25mm O/S | KIT FASCE 0.25mm O/S | KIT SEGMENTS 0.25mm O/S | 4 |
| | REC64D-11605-01 | 64D-11605-01 | KIT SEGMENTOS DE PISTÓN 0.50mm O/S | PISTON RING SET 0.50mm O/S | KIT FASCE 0.50mm O/S | KIT SEGMENTS 0.50mm O/S | |
| 31 | REC6G5-45113-A1 | 6G5-45113-A1 | JUNTA BASE MOTOR | GASKET ENGINE | GUARNIZIONE BASE MOTORE | JOINT DE TETE MOTRICE | 1 |
| 32 | REC90480-20M05 | 90480-20M05 | JUNTA GOMA | GROMMET | GUARNIZIONE GOMMA | JOINT | 1 |
| 33 | REC60H-12416-00 | 60H-12416-00 | VÁLVULA CONTROL DE PRESIÓN | VALVE, PRESSURE CONTROL | VALVOLA ANTIPRESSIONE | SOUPAPE DE DEPRESSION | 1 |
| 34 | REC90501-16M11 | 90501-16M11 | MUELLE | SPRING COMPRESSION | MOLLA | RESSORT | 1 |

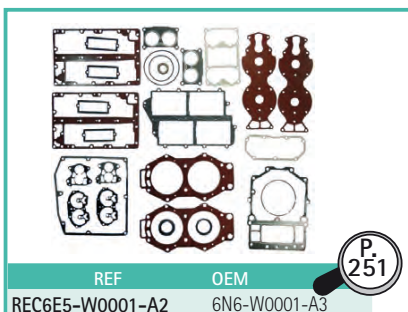

2T
STROKES

150AET • 150F/FETO • 150L/SL150 • 150TR/150TXRA • D150H • 175D/DETO • S175 • L175 • 175D/DETO
• S175 -L175 • 200AET • 200G/GETO • 200F/FETO • L200 • 200TLR • 225D/DET/DETO • L225A • L225B

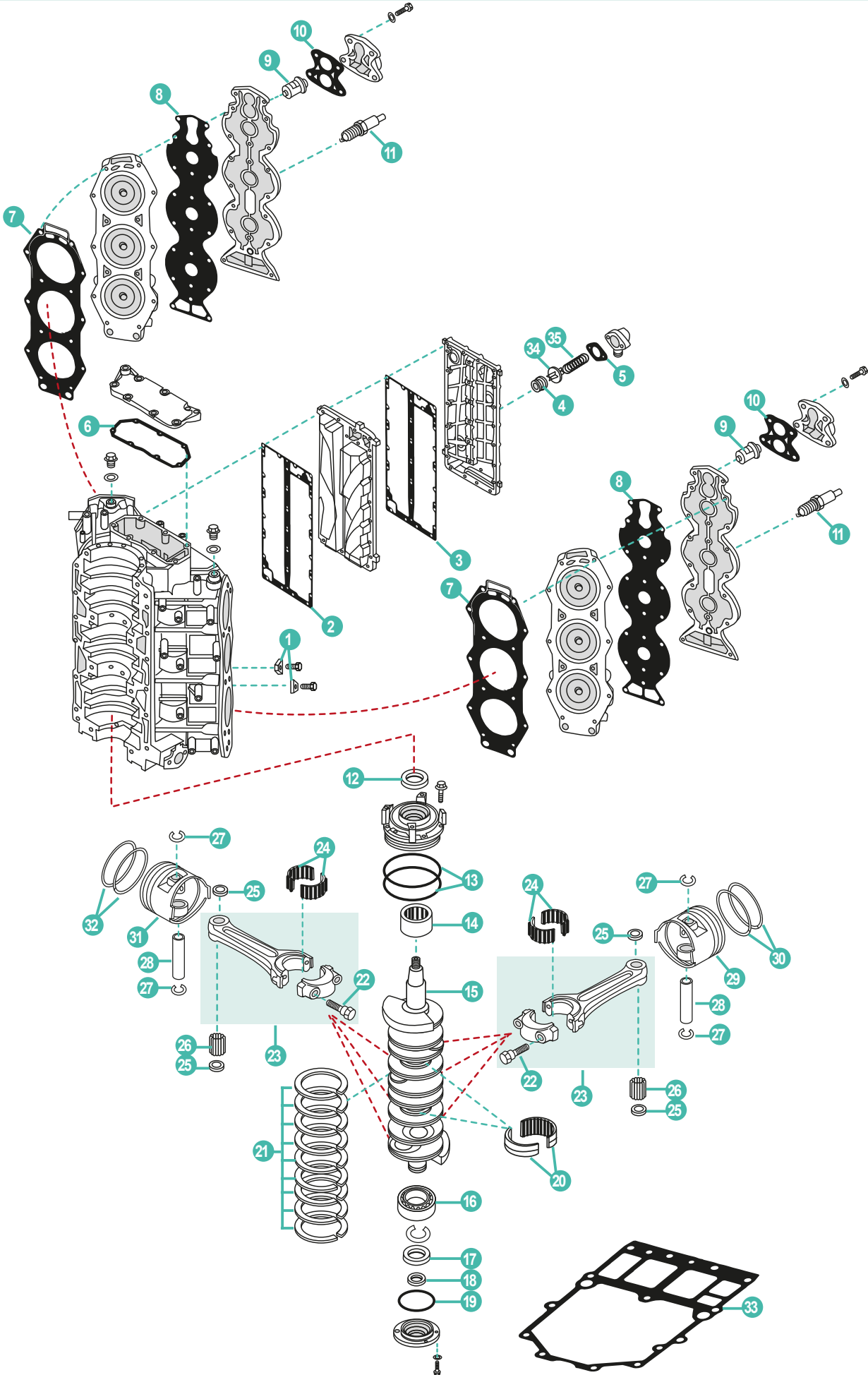

YAMAHA

RECAMBIOS
MARINOS

| | REF | OEM | | | | UN. | |
|----|------------------|-----------------|------------------------------------|-----------------------------|--|------------------------------------|----|
| 1 | TEN01152 | 6E5-11325-00 | ÁNODO | ANODE | ANODO | ANODE | 8 |
| 2 | REC6G5-41112-A1 | 6G5-41112-A1 | JUNTA DE ESCAPE | EXHAUST GASKET | GUARNIZIONE DI SCARICO | JOINT D'ECHAPPEMENT | 1 |
| 3 | REC6G5-41114-A0 | 6G5-41114-A0 | JUNTA EXTERIOR, TAPA DE ESCAPE | GASKET, EXHAUST OUTER COVER | GUARNIZIONE ESTERIORE, COPERCHIO SCARICO | JOINT DE COUVERCLE EXT ECHAPPEMENT | 1 |
| 4 | REC90480-20M05 | 90480-20M05 | JUNTA DE GOMA | GROMMET | GUARNIZIONE GOMMA | JOINT | 1 |
| 5 | REC6G5-11382-A1 | 6G5-11382-A1 | JUNTA | GASKET | GUARNIZIONE | JOINT | 1 |
| 6 | REC6E5-11381-A1 | 6E5-11381-A2 | JUNTA | GASKET | GUARNIZIONE | JOINT | 1 |
| 7 | REC6G5-11181-A2 | 6G5-11181-A3 | JUNTA CULATA | GASKET, CYLINDER HEAD | GUARNIZIONE TESTATA | JOINT DE CULASSE | 2 |
| 8 | REC6G5-11193-A0 | 6F5-11193-A0 | JUNTA TAPA | GASKET, COVER | GUARNIZIONE COPERCHIO | JOINT DE COUVRE CULASSE | 2 |
| 9 | REC6E5-12411-30 | 6E5-12411-30 | TERMOSTATO | THERMOSTAT | TERMOSTATO | THERMOSTAT | 2 |
| 10 | REC688-12414-A1 | 688-12414-A1 | JUNTA TAPA TERMOSTATO | GASKET, THERMOSTAT COVER | GUARNIZIONE COPERCHIO TERMOSTATO | JOINT COUVERCLE DE THERMOSTAT | 2 |
| 11 | NGKBR8HS-10 | 94702-00271 | BUJÍA | SPARK PLUG | CANDELA | BOUGIE | 6 |
| 12 | REC93102-40M14 | 93102-40M14 | RETÉN DE ACEITE | OIL SEAL | PARAOLIO | JOINT SPI | 1 |
| 13 | REC93211-04001 | 93211-04001 | TÓRICA | O-RING | O-RING | JOINT TORIQUE | 2 |
| 14 | REC93311-940U3 | 93311-940U3 | RODAMIENTO | BEARING | CUSCINETTO | ROULEMENT À BILLE | 1 |
| | REC93311-940V0 | 93311-940V0 | RODAMIENTO CIGÜEÑAL (6Do) | CRANKSHAFT BEARING (6Do) | CUSCINETTO ALBERO MOTORE (6Do) | ROULEMENT DE VILEBREQUIN (6Do) | 1 |
| 15 | REC6G5-11411-02 | 6G5-11411-02 | CIGÜEÑAL | CRANKSHAFT | ALBERO MOTORE | VILEBREQUIN | 1 |
| 16 | REC93306-208U0 | 93306-208U0 | RODAMIENTO | BEARING | CUSCINETTO | ROULEMENT | 1 |
| 17 | REC93102-35M13 | 93102-35M13 | RETÉN DE ACEITE | OIL SEAL | PARAOLIO | JOINT SPI | 1 |
| 18 | REC93101-22M15 | 93101-22M15 | RETÉN DE ACEITE | OIL SEAL | PARAOLIO | JOINT SPI | 1 |
| 19 | REC93210-74M35 | 93210-74M35 | TÓRICA | O-RING | O-RING | JOINT TORIQUE | 1 |
| 20 | REC93310-954U1 | 93310-954U1 | RODAMIENTO | BEARING | CUSCINETTO | ROULEMENT À BILLE | 1 |
| | REC93310-959U0 | 93310-959U0 | RODAMIENTO CIGÜEÑAL (6Do) | CRANKSHAFT BEARING (6Do) | CUSCINETTO ALBERO MOTORE (6Do) | ROULEMENT DE VILEBREQUIN (6Do) | 1 |
| 21 | REC6E5-11447-00 | 6E5-11447-00 | ARILLO | SEAL, CRANK | O-RING | JOINT | 9 |
| 22 | REC90109-08022 | 90109-08022 | TORNILLO | BOLT | VITE | VIS | 2 |
| 23 | REC6R5-11650-10 | 6F5-11650-11 | BIELA | CONNECTING ROD ASSY | BIELLA | BIELLE | 6 |
| 24 | REC93310-836V2 | 93310-836V2 | COJINETE DE BIELA | BEARING, CONNECTING ROD | CUSCINETTO BIELLA | PALIER DE BIELLE | 6 |
| 25 | REC90201-23M01 | 90201-23M01 | ARANDELA | WASHER PLATE | RONDELLA | RONDELLE | 12 |
| | REC90201-21M75 | 90201-21M75 | ARANDELA (61A) | WASHER (61A) | RONDELLA (61A) | RONDELLE (61A) | 12 |
| 26 | REC93310-32337 | 93310-32337 | AGUJA DE RODAMIENTO | BEARING NEEDLE | SPILLO DE CUSCINETTO | CLAVETTE DE PALIER | 6 |
| | REC93310-32668 | 93310-32668 | AGUJA DE RODAMIENTO (250G) | BEARING NEEDLE (250G) | SPILLO DE CUSCINETTO (250G) | CLAVETTE DE PALIER (250G) | 6 |
| 27 | REC6R5-11634-00 | 6R5-11634-10 | CIRCLIP | CIRCLIP | CIRCLIP | CIRCLIP | 12 |
| 28 | REC6R5-11633-00 | 6R5-11633-10 | PIN, PISTÓN | PIN, PISTON | SPINOTTO PISTONE | AXE DE PISTON | 6 |
| 29 | REC64D-11642-00K | 64D-11642-02-90 | PISTON STD 2 | PISTON STD 2 | PISTONE STD 2 | PISTON STD 2 | 3 |
| | REC64D-11603-01 | 64D-11603-02 | KIT SEGMENTOS DE PISTÓN STD | PISTON RING SET STD | KIT FASCE STD | KIT SEGMENTS STD | 3 |
| 30 | REC64D-11604-01 | 64D-11604-01 | KIT SEGMENTOS DE PISTÓN 0.25mm O/S | PISTON RING SET 0.25mm O/S | KIT FASCE 0.25mm O/S | KIT SEGMENTS 0.25mm O/S | 3 |
| | REC64D-11605-01 | 64D-11605-02 | KIT SEGMENTOS DE PISTÓN 0.50mm O/S | PISTON RING SET 0.50mm O/S | KIT FASCE 0.50mm O/S | KIT SEGMENTS 0.50mm O/S | 3 |
| 31 | REC64D-11631-00K | 64D-11631-02-90 | PISTON STD 1 | PISTON STD 1 | PISTONE STD 1 | PISTON STD 1 | 3 |
| | REC64D-11603-01 | 64D-11603-02 | KIT SEGMENTOS DE PISTÓN STD | PISTON RING SET STD | KIT FASCE STD | KIT SEGMENTS STD | 3 |
| 32 | REC64D-11604-01 | 64D-11604-02 | KIT SEGMENTOS DE PISTÓN 0.25mm O/S | PISTON RING SET 0.25mm O/S | KIT FASCE 0.25mm O/S | KIT SEGMENTS 0.25mm O/S | 3 |
| | REC64D-11605-01 | 64D-11605-02 | KIT SEGMENTOS DE PISTÓN 0.50mm O/S | PISTON RING SET 0.50mm O/S | KIT FASCE 0.50mm O/S | KIT SEGMENTS 0.50mm O/S | 3 |
| 33 | REC6G5-45113-A1 | 6G5-45113-A1 | JUNTA BASE MOTOR | GASKET ENGINE | GUARNIZIONE BASE MOTORE | JOINT DE TETE MOTRICE | 1 |
| 34 | REC60H-12416-00 | 60H-12416-00 | VÁLVULA CONTROL DE PRESIÓN | VALVE, PRESSURE CONTROL | VALVOLA ANTIPRESSIONE | SOUPAPE DE DEPRESSION | 1 |
| 35 | REC90501-16M11 | 90501-16M11 | MUELLE | SPRING COMPRESSION | MOLLA | RESSORT | 1 |

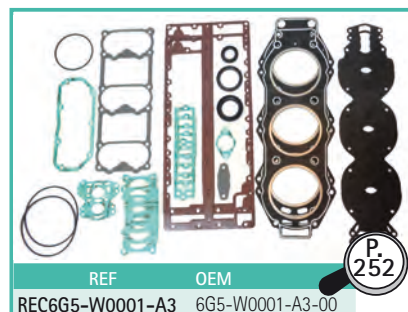

JUNTAS DE MOTOR
2 TIEMPOS

ENGINE GASKET
2 STROKES

GUARNIZIONI
MOTORE 2 TEMPI

JOINTS DE MOTEUR
2 TEMPS

2T
STROKES

JUNTAS DE CULATA

CYLINDER HEAD GASKET

GUARNIZIONE DE TESTATA

JOINT DE CULASSE

| REF | OEM |
|-----------------|--------------|
| REC6F8-11181-A0 | 6F8-11181-A1 |



2CMH (2003+)



| REF | OEM |
|-----------------|--------------|
| REC6H4-11181-00 | 6H4-11181-A2 |



25Q
40N/H
50E/D (1984-94)



| REF | OEM |
|-----------------|--------------|
| REC677-11181-A0 | 677-11181-A1 |



E8D/DMH (1997-03)



| REF | OEM |
|-----------------|--------------|
| REC61N-11181-00 | 61N-11181-A2 |



25VE/VM
E25A/BMH
30G
E30HMH/H (1996-12)



| REF | OEM |
|-----------------|--------------|
| REC63V-11181-A1 | 63V-11181-A1 |



9.9F/MH/MSH
E9.9D
15F/FMH/MSH
E15D
13.5 AWH/AMH (1995+)



| REF | OEM |
|-----------------|--------------|
| REC689-11181-00 | 689-11181-A2 |



30A (1990-92)



| REF | OEM |
|-----------------|--------------|
| REC6E7-11181-00 | 6E7-11181-A2 |



9.9D
15D (1988-96)



| REF | OEM |
|-----------------|--------------|
| REC6J8-11181-A2 | 6J8-11181-A2 |



30D
25J (1986+)



| REF | OEM |
|-----------------|--------------|
| REC6L2-11181-A1 | 6L2-11181-A3 |



20D/M
25D/M/N (1988+)



| REF | OEM |
|-----------------|--------------|
| REC6F5-11181-A2 | 6F5-11181-A2 |



40GWH/JWH
E40GMH/JMH (2003)



| REF | OEM |
|-----------------|--------------|
| REC695-11181-00 | 695-11181-A1 |



20C
25D (1986-02)



| REF | OEM |
|-----------------|--------------|
| REC63D-11181-A1 | 63D-11181-A2 |



40V
C40/EL/TLR/Y
50H/TLR/TR
(1995+)



| REF | OEM |
|-----------------|--------------|
| REC6H3-11181-A0 | 6H3-11181-A2 |



25B
50G
60T
E60
60FE
70B/ET/CE (1984+)



| REF | OEM |
|-----------------|--------------|
| REC6R7-11181-A0 | 6R7-11181-A1 |



40G (1993)



| REF | OEM |
|-----------------|--------------|
| REC676-11181-01 | 676-11181-A2 |

40QE/QM/QWC (1990-98)

| REF | OEM |
|-----------------|--------------|
| REC6G5-11181-A2 | 6G5-11181-A3 |

150A/E/C/AET
175AET/B/D
200AET/B/C/FETGE
225AET/BETO/D

| REF | OEM |
|-----------------|--------------|
| REC66T-11181-00 | 66T-11181-A0 |

40X
E40X/M (1998-09)

| REF | OEM |
|-----------------|--------------|
| REC60V-11181-00 | 60V-11181-00 |

Z250
VZ250
LZ250 (2003-07)

| REF | OEM |
|-----------------|--------------|
| REC697-11181-A1 | 697-11181-A2 |

E55CMH
E48CMH
55BET
55B/BE/BM (1990-05)

| REF | OEM |
|-----------------|--------------|
| REC68F-11181-00 | 68F-11181-00 |

Z/VZ/LZ200 (2001-07)
Z/VZ/LZ150 (2000-07)
Z/VZ175 (2001-07)

| REF | OEM |
|-----------------|--------------|
| REC688-11181-A1 | 688-11181-A2 |

75A/AE/CET
80A/AE
85A/AE
90A/AE/TR (1986-14)

| REF | OEM |
|-----------------|--------------|
| REC6D0-11181-00 | 6D0-11181-00 |

VZ/LZ/Z300 (2004-07)

| REF | OEM |
|-----------------|--------------|
| REC6E5-11181-A0 | 6E5-11181-A2 |

100A
115A/E/B/C
C115T 130B
140A (1984+)

| REF | OEM |
|-----------------|--------------|
| REC61A-11181-A0 | 69L-11181-00 |

225G/F (1194-03)
250A/B/F (1992-06)

2T
STROKES

KITS
JUNTAS DE CULATA

**CYLINDER HEAD GASKET
KIT**

| REF | OEM |
|-----------------|--------------|
| REC63V-W0001-00 | 63V-W0001-01 |

9.9-15F/FMH/FEMH/MSH (1995-00)
13.5AWH (1998)

KIT
GUARNIZIONE TESTATA

KITS
JOINT DE CULASSE

| REF | OEM |
|-----------------|------------------------------|
| REC6E7-W0001-A1 | 6E7-W0001-00 6E7-W0001-A1 |

9.9D
15D

| REF | OEM |
|-----------------|--------------|
| REC61T-W0001-02 | 61T-W0001-02 |

 E25A, 25VM, 30G/GE/A

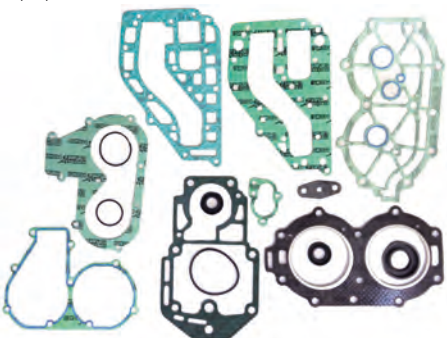

| REF | OEM |
|-----------------|--------------|
| REC695-W0001-A2 | 695-W0001-01 |

 25D/DE (1985-92)
20CM/C (1985-92)

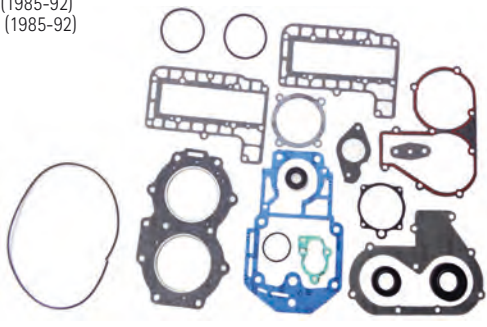

| REF | OEM |
|-----------------|--------------|
| REC6H3-W0001-02 | 6H3-W0001-02 |

 25B/BETO (1994-95)
50G/GEO/GETOL (1994-98)
60FEO/FETO/FEDO/TLR/FEHTO/TR (1994-2007)

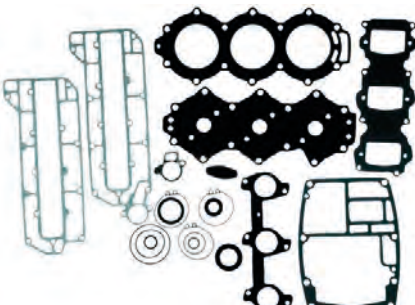

| REF | OEM |
|--------------------|--------------|
| REC6R6-W0001-02-00 | 6R6-W0001-02 |

 40QE-2 (1995-97)
40QM (1996)
40QWC (1998)

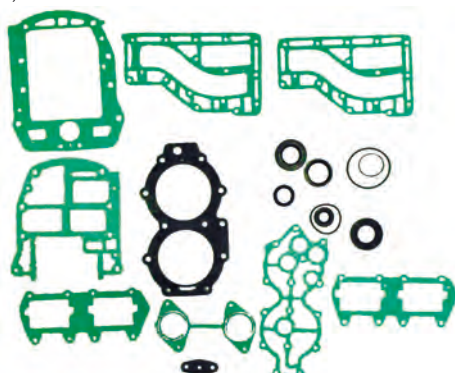

| REF | OEM |
|-----------------|--------------|
| REC6H4-W0001-04 | 6H4-W0001-04 |

 25QEO (1992-94)
40HE (1992-94)
50DE/DEMTO (1992-94)

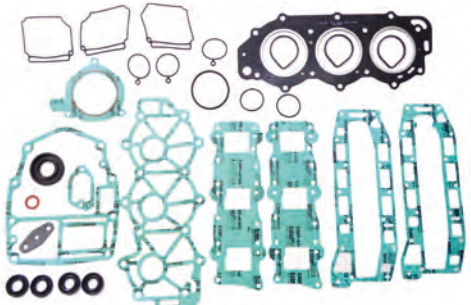

| REF | OEM |
|-----------------|--------------|
| REC66T-W0001-01 | 66T-W0001-01 |

 E40X/XMH/XW/
MLHZ (2001-13)

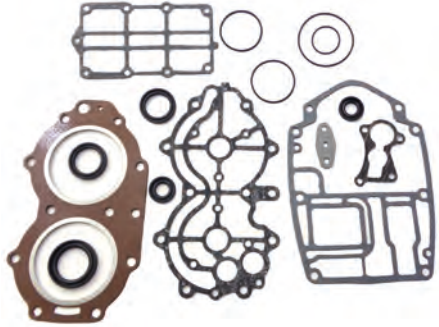

| REF | OEM |
|-----------------|--------------|
| REC6L2-W0001-03 | 6L2-W0001-A2 |

 25NE (1988-93)
20DM (1988-93)
25NEMO (1991-92)
20D/DEO (1989-92)

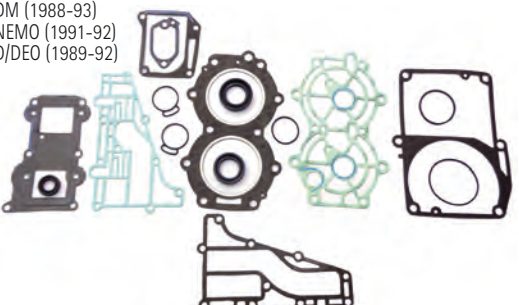

| REF | OEM |
|-----------------|--------------|
| REC6H4-W0001-A1 | 6H4-W0001-01 |

 40N (1984)
40H (1985-98)
50D (1985-98)
50ETN (1984)

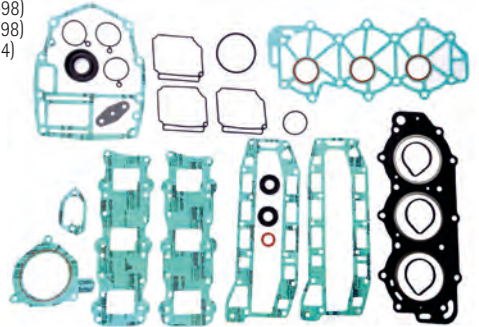

| REF | OEM |
|-----------------|--------------|
| REC6F6-W0001-02 | 6F6-W0001-02 |

new

 E40GMH/S/L
 E40JMH
 E40JWH
 40GWH
 40JWH



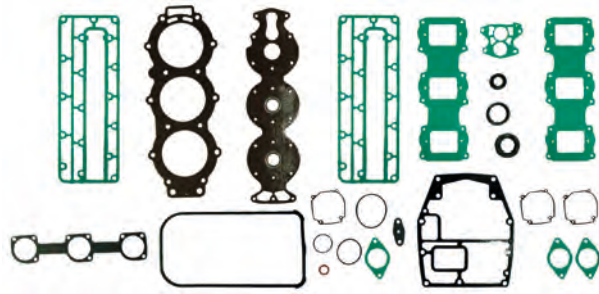

| REF | OEM |
|-----------------|--------------|
| REC688-W0001-A0 | 688-W0001-A0 |

 75A/AE (1990-91)
 85A/AE (1990-91)



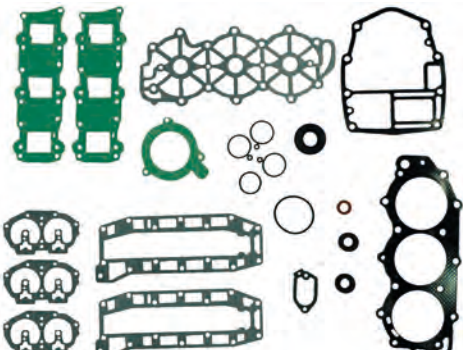

| REF | OEM |
|-----------------|--------------|
| REC63D-W0001-00 | 63D-W0001-00 |

 50H/HRDO/HMDH/HETO (1995-03)
 40V/MMH/VETO/MLH/MHO/VE/VEO (1995-13)
 40VEMHD/TLRZ/YETO (1997-07)
 C40T/TLR (1995-02)



| REF | OEM |
|--------------------|--------------|
| REC6H1-W0001-00-00 | 6H1-W0001-A1 |

 80A/AE (1984-91)
 80AEO (1992-93)
 90A/AEO/AETO/ETN (1984-91)
 90AEO (1992)

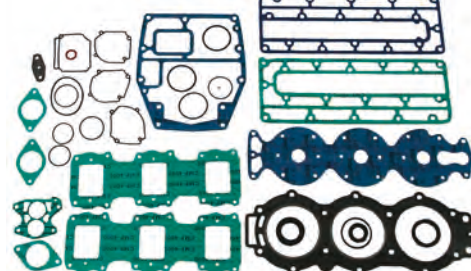

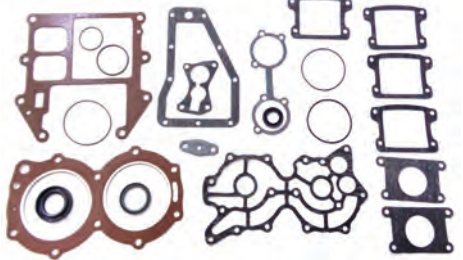

| REF | OEM |
|-----------------|--------------|
| REC697-W0001-02 | 697-W0001-A0 |

 55BET (1990)



| REF | OEM |
|-----------------|--------------|
| REC6E5-W0001-A2 | 6E5-W0001-A2 |

 L130BETO (1991-99)
 115CEO/CETO (1991-96)
 100A/AETO/TLR (1996-00)

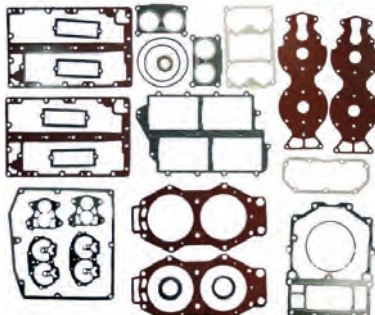

| REF | OEM |
|-----------------|--------------|
| REC6K5-W0001-02 | 6K5-W0001-02 |

 E60H/MHZ/HE/HM (1996-02)

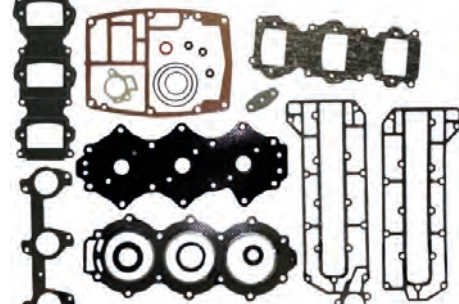

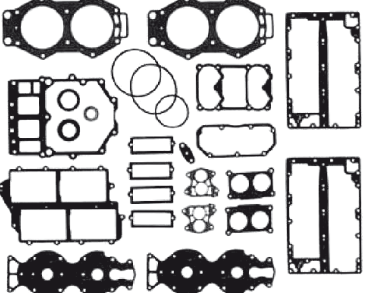

| REF | OEM |
|--------------------|--------------|
| REC6F3-W0001-04-00 | 6F3-W0001-A4 |

 115BETO (1991-93)
 115B (1988-00)
 115ETN (1984)
 115A (1987)
 140AETO/BETO (1984-89)
 115BE (1992)



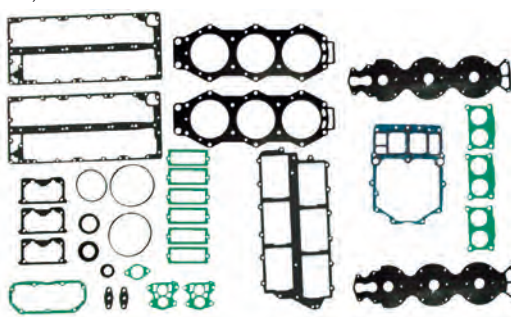

| REF | OEM |
|-----------------|--------------|
| REC6R3-W0001-03 | 6R3-W0001-A3 |

 L/150 CETO (1990-95)
 L/200 BETO (1993-95)
 175BETO/ET (1990-95)
 L200ETD (1990)
 150CED/ETD (1990)
 200ET (1990)



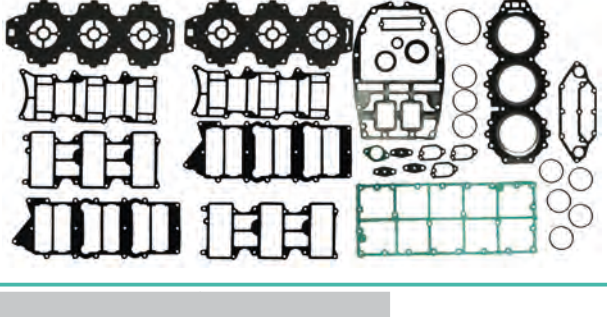

| REF | OEM |
|-----------------|--------------|
| REC61A-W0001-01 | 61A-W0001-A1 |

 250ETD (1990)
 250AETO/AET/B (1990-96)
 L250A/AET/AETO (1992-96)
 225C (1994-95)
 L225CETO (1994)



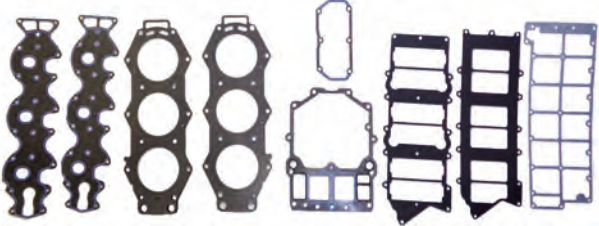

| REF | OEM |
|-----------------|--------------|
| REC68F-W0001-01 | 68F-W0001-01 |

 LZ200 (2004-10)
 VZ200 (2004)
 Z200 (2004-10)
 Z
 VZ200TLRC/PETO/TLR2D/PETOL/TXRC/
 NETO-L/TR/NETOX/Z175GETO/GETOX/TR/TXR (2004-07)



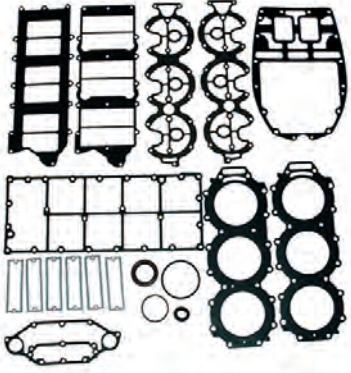

| REF | OEM |
|-----------------|--------------|
| REC6D0-W0001-00 | 6D0-W0001-00 |

 Z300AETO/TR
 LZ300AETO/TR (2004-07)



| REF | OEM |
|-----------------|--------------|
| REC6G5-W0001-A3 | 6G5-W0001-03 |

 200CETO (1992-93)
 PROV200 (1991-94)
 225BET/BETO (1991-95)
 150A/AETO/AETL/AETX (1998-02)

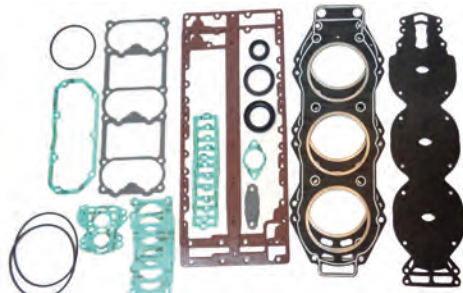



| REF | OEM |
|-----------------|--------------|
| REC6E0-45113-A1 | 6E0-45113-A1 |

 4A/AC/AS/MSH
 5C/CS/CMH



| REF | OEM |
|-----------------|--------------|
| REC6G1-45113-A1 | 6G1-45113-A1 |

 8N/C/J/T/M
 6C/J/D/T/M

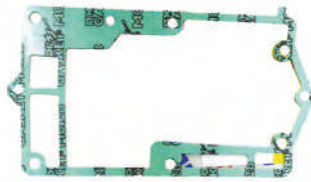

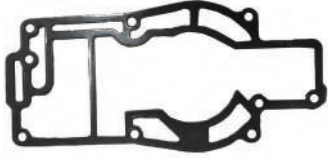

| REF | OEM |
|-----------------|--------------|
| REC677-45113-A0 | 677-45113-A0 |

 E8D/DMH



| REF | OEM |
|-----------------|--------------|
| REC6B4-11351-A1 | 6B4-11351-A1 |

 9.9/15 HP D 6B3-6B4 (2003)





2T
STROKES

JUNTAS BASE DE MOTOR

CYLINDER GASKET

GUARNIZIONE BASE MOTORE

JOINTS DE TETE MOTRICE

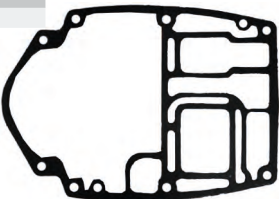

| REF | OEM |
|---|--|
| REC63V-45113-A1 | 63V-45113-A1 |
|  | 9.9FEM/F/MSH/FMH/MH 13.5 AW/AMH 15F/FEM/MSH/FMH/MH |
|  | |

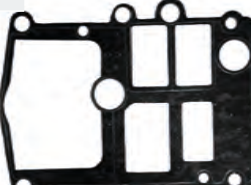
| REF | OEM |
|---|--------------|
| REC66T-45113-A0 | 66T-45113-A0 |
|  | 40X/E40X |
|  | |

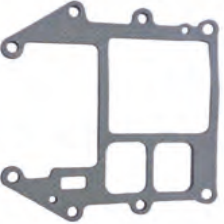
| REF | OEM |
|---|--------------|
| REC682-11351-A0 | 682-11351-A0 |
|  | 9.9D 15D |
|  | |

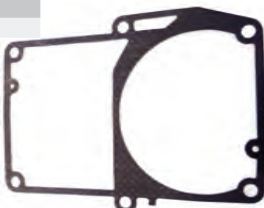
| REF | OEM |
|---|----------------|
| REC696-45113-00 | 696-45113-A0 |
|  | 55B/E55 E48 |
|  | |

| REF | OEM |
|---|----------------|
| REC6L2-45113-A2 | 6L2-45113-A1 |
|  | 20D 25D/N/M |
|  | |

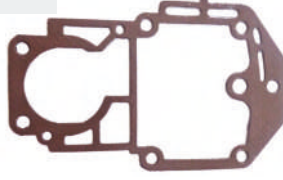

| REF | OEM |
|--|---|
| REC6H3-45113-00 | 6H3-45113-A0 |
|  | 60FE/TLR/F, 50G/GE E60H 70B/BE/CE/TR |
|  | |

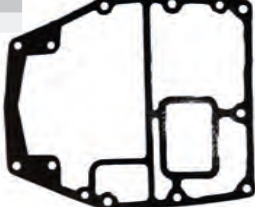
| REF | OEM |
|---|--------------------|
| REC61T-45113-A0 | 61T-45113-A0 |
|  | 25VE/BMH 30G/HW |
|  | |

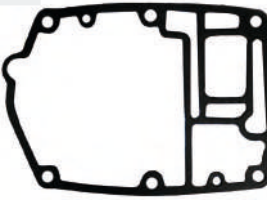

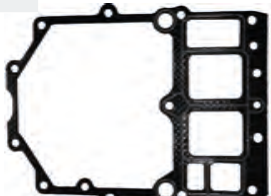
| REF | OEM |
|---|--|
| REC688-45113-A0 | 688-45113-A0 |
|  | 75A/AE/CE/TL 85A/AE 80A/AE 90A/AE/ETN |
|  | |

| REF | OEM |
|---|-----------------------|
| REC6J8-45113-00 | 6J8-45113-A0 |
|  | 25J 30D/DMH/DE/E/M |
|  | |

| REF | OEM |
|---|---|
| REC6G5-45113-A1 | 6G5-45113-A2 |
|  | 115ETN/A/B 130BE 150ETN/AET/CET/F/TXR/G 140AET/BET 175AET/BET/DE 150BET 200ETN/AET/CET/BET/AF/G 220AET 225AET/BET/D |
|  | |

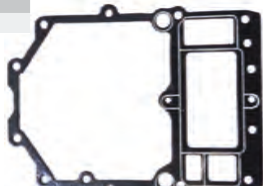
| REF | OEM |
|---|---------------------------------|
| REC6H4-45113-00 | 6H4-45113-A0 |
|  | 25Q 40N/H/E/M/T/Y 50D/H/T |
|  | |

| REF | OEM |
|---|---------------------|
| REC6E5-45113-A2 | 6E5-45113-A0 |
|  | 115B/ET 140AE/BE |
|  | |

| REF | OEM |
|---|-----------------------|
| REC6F5-45113-A0 | 6F5-45113-A0 |
|  | E40G/E40J/40G/40J/40Q |
|  | |

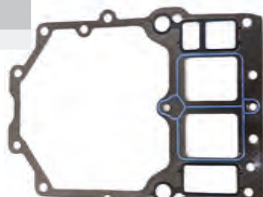
| REF | OEM |
|---|--|
| REC68F-45113-01 | 68F-45113-01 |
|  | Z/VZ150 Z/VZ175 VZ-Z200/200A/F/J 150F/A Z200 |
|  | |

2T
STROKES

| REF | OEM |
|-----------------|--------------|
| REC60V-45113-02 | 60V-45113-02 |

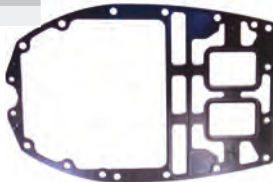

LZ/Z/NZ
250D/T/F
300A/B/T (2004-07)

| REF | OEM |
|-----------------|--------------|
| REC61A-45113-A0 | 61A-45113-A0 |

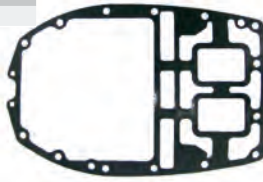

Z/NZ250
Z300

| GUÍA JUNTAS DE MOTOR | | ENGINE GASKET GUIDE | GUIDA GUARNIZIONE MOTORE | GUIDE JOINTS DE MOTEURS |
|----------------------|---------|---|--------------------------|-------------------------|
| 🔧 | CYL | JUNTA CULATA CYLINDER HEAD GASKET GUARNIZIONE TESTAT JOINT DE CULASSE | | KIT JOINTS |
| | | JUNTA BASE MOTOR CYLINDER GASKET GUARNIZIONE BASE MOTORE JOINT DE TETE MOTRICE | | |
| 2CMH | 2010 | 1 | REC6F8-11181-A0 | REC646-14623-A1 |
| E8D/DMH | 1997-03 | 2 | REC677-11181-A0 | REC677-45113-A0 |
| 9.9D | 1988-96 | 2 | REC6E7-11181-00 | REC682-45113-A0 |
| 9.9F/FM/MSH/E9.9D | 1995 | 2 | REC63V-11181-A1 | REC63V-45113-A1 |
| 13.5AWH/AMH | 1995 | 2 | REC63V-11181-A1 | REC63V-45113-A1 |
| 15D | 1988-95 | 2 | REC6E7-11181-00 | REC682-45113-A0 |
| 15F/FMH/MSH/E15D | 1995 | 2 | REC63V-11181-A1 | REC63V-45113-A1 |
| 20C | 1986-02 | 2 | REC695-11181-00 | REC61T-45113-A0 |
| 20D/20DM | 1988 | 2 | REC6L2-11181-A1 | REC6L2-45113-A2 |
| 25DE/M/N | 1998 | 2 | REC6L2-11181-A1 | REC6L2-45113-A2 |
| 25DE/M/N | 1986-02 | 2 | REC695-11181-00 | REC61T-45113-A0 |
| 25VE/VM/BMH/E25A | 1996-12 | 2 | REC61N-11181-00 | REC61T-45113-A0 |
| 25Q/QEO | 1990-94 | 3 | REC6H4-11181-00 | REC6H4-45113-00 |
| 25J/JEO/JETO | 1987-99 | 3 | REC6J8-11181-A2 | REC6J8-45113-00 |
| 25B/BETO | 1994-95 | 3 | REC6H3-11181-A0 | REC6H3-45113-00 |
| 25B/BMH | 1996-10 | 2 | REC61N-11181-00 | REC61T-45113-A0 |
| 30A | 1990-92 | 2 | REC689-11181-00 | REC61T-45113-A0 |
| 30G/E30HMH/H | 1996-12 | 2 | REC61N-11181-00 | REC61T-45113-A0 |
| 30D | 1986 | 3 | REC6J8-11181-A2 | REC6J8-45113-00 |
| 40QE/QM/QWC | 1990-98 | 2 | REC676-11181-01 | REC6R6-45113-A0 |
| 40N/H | 1984-94 | 3 | REC6H4-11181-00 | REC6H4-45113-00 |
| 40G | 1993 | 2 | REC6R7-11181-A0 | REC6R6-45113-A0 |
| 40X/E40/M/X | 1998 | 2 | REC66T-11181-00 | REC66T-45113-A0 |
| 40/E40GMH/JMH | 2003 | 2 | REC6F5-11181-A2 | REC6F5-45113-A0 |
| 40V/C40/EL/TLR/Y-YE | 1995 | 3 | REC63D-11181-A1 | REC6H4-45113-00 |
| E48 | 2003 | 2 | REC697-11181-A1 | REC697-45113-00 |
| 50H/TLR/TR | 1995 | 3 | REC63D-11181-A1 | REC6H4-45113-00 |
| 50G/GEO/GETO | 1993-02 | 3 | REC6H3-11181-A0 | REC6H3-45113-00 |
| 50E/D | 1984-94 | 3 | REC6H4-11181-00 | REC6H4-45113-00 |
| 55B/E55 | 1990-05 | 2 | REC697-11181-A1 | REC697-45114-00 |
| 60FE/T/E60 | 1984 | 3 | REC6H3-11181-A0 | REC6H3-45113-00 |
| 70B/ET/CE | 1984 | 3 | REC6H3-11181-A0 | REC6H3-45113-00 |
| 70A/AE/CET | 1986 | 3 | REC688-11181-A1 | REC688-45113-A0 |
| 80A/AE | 1986 | 3 | REC688-11181-A1 | REC688-45113-A0 |
| 85A/AE | 1986 | 3 | REC688-11181-A1 | REC688-45113-A0 |
| 90A/AE/TR | 1986 | 3 | REC688-11181-A1 | REC688-45113-A0 |
| 100A | 1984 | 4 | REC6E5-11181-A0 | REC6E5-45113-A2 |
| 115A/B/E/C/C115T | 1984 | 4 | REC6E5-11181-A0 | REC6E5-45113-A2 |
| 130B | 1984 | 4 | REC6E5-11181-A0 | REC6E5-45113-A2 |
| 140A | 1984 | 4 | REC6E5-11181-A0 | REC6E5-45113-A2 |
| LZ150/NZ150/Z150 | 2004-05 | 6 | REC68F-11181-00 | REC68F-45113-01 |
| 150A/E/C/FET | 1984-10 | 6 | REC6G5-11181-A2 | REC6G5-45113-A1 |
| VZ175/Z175 | 2004-10 | 6 | REC68F-11181-00 | REC68F-45113-01 |
| 175D/B/AET | 1984-10 | 6 | REC6G5-11181-A2 | REC6G5-45113-A1 |
| LZ200/NZ200/Z200 | 2004-10 | 6 | REC68F-11181-00 | REC68F-45113-01 |
| 200B/C/AET/GE/FET | 1984 | 6 | REC6G5-11181-A2 | REC6G5-45113-A1 |
| 225D/BET/AET | 1984 | 6 | REC6G5-11181-A2 | REC6G5-45113-A1 |
| 225C/G | 1990 | 6 | REC61A-11181-A0 | REC61A-45113-A0 |
| 250A/E/B | 1990-06 | 6 | REC61A-11181-A0 | REC61A-45113-A0 |
| Z-LZ250DET/TUR/TR | 2003-07 | 6 | REC60V-11181-00 | REC60V-45113-02 |
| 250TR/FET/HETO | 2003-07 | 6 | REC60V-11181-00 | REC60V-45113-02 |
| V250TLR/TR | 2003 | 6 | REC60V-11181-00 | REC60V-45113-02 |
| Z-LZ300 | 2004-07 | 6 | REC6D0-11181-00 | REC6D0-45113-02 |

JUNTAS DE CULATÍN

GASKET, HEAD COVER

GUARNIZIONI COPERCHIO
TESTATA

JOINT DE COUVRE CULASSE

| REF | OEM |
|---|-------------------------------------|
| REC6L2-11193-A1 | 6L2-11193-A1 |
|  | 20D/DM/DEO 25NE/NEMO/NWC/ MSH |



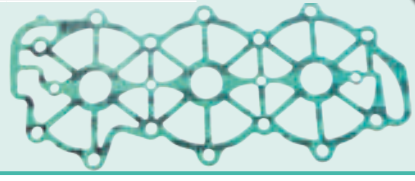

| REF | OEM |
|---|----------------------------------|
| REC63D-11193-A0 | 63D-11193-A0 |
|  | 50H/T (1995+) 40V/M/Y (1995+) |





new

| REF | OEM |
|---|--|
| REC6H3-11193-A1 | 6H3-11193-A1 |
|  | 25B/BETO 50G/GEO/GETO 60FEO/FETO/FEDO/TLR E60H/ HMH/MLH 70B//BEO/BEMO/BETO/TR |





| REF | OEM |
|---|---|
| REC688-11193-A1 | 688-11193-A1 |
|  | 75CETO/TLR/AE E75B 80AEO/AETO/A 85A/AE 90AEO/TLR/A/AETO |

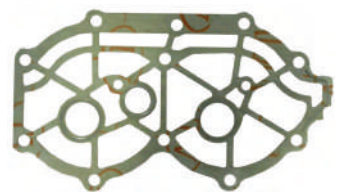

| REF | OEM |
|---|---|
| REC61T-11193-A0 | 61T-11193-A1 |
|  | 25VE/VM/BMH/B E25A/BMH 30G/GE/HMH/HW MSH |



| REF | OEM |
|---|---|
| REC6E5-11193-A0 | 6E5-11193-A0 |
|  | 100A/AETO/TLR 115B/BETO/BE C115TLR/CEO/CETO/TXR E115AEL 130BETO |



| REF | OEM |
|---|--------------------------|
| REC66T-11193-A0 | 66T-11193-A0 |
|  | 40X/E40X E40 MLH/X/XW |

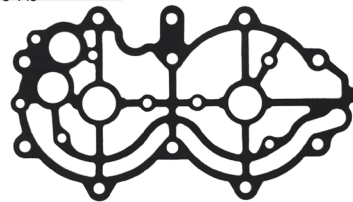



| REF | OEM |
|---|--|
| REC68F-11193-02 | 68F-11193-02 |
|  | Z150P/TXR/PETO/TR/Q/QETO Z175G/GETO/TR/TLR/H Z200N/TXR/PETO/TLR/NETO |

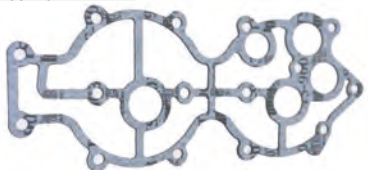

| REF | OEM |
|---|------------------|
| REC6E9-11193-A0 | 6E9-11193-A0 |
|  | 40QE/QE-Z/QM/QWC |





| REF | OEM |
|---|---|
| REC6G5-11193-A0 | 6G5-11193-A1 |
|  | 150A/AET/CETO/F/FETO/TXR D150H 175D/DETO/BETO 200AET/CETO/FETO/G/GETO/BETO/TLR, TXR/F/TLR, 225D/DET/BET |

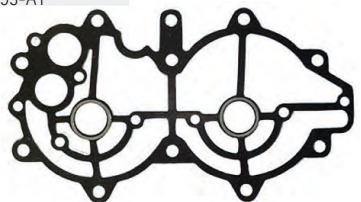

| REF | OEM |
|---|-------------------------|
| REC6F6-11193-A1 | 6F6-11193-A1 |
|  | 40GWH/JWH E40GMH/JMH |



| REF | OEM |
|---|----------------------------------|
| REC61A-11193-A2 | 61A-11193-A2 |
|  | 225C/CETO/G/GETO 250AET/B/TLR |



| REF | OEM |
|---|---------------------------------------|
| REC663-11193-00 | 663-11193-A0 |
|  | E48CMH 55BET/B/BE/BM/BET E55CMH |

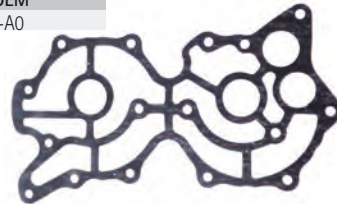

| REF | OEM |
|---|---|
| REC6H4-11193-A1 | 6H4-11193-00 |
|  | 25Q (1990-94) 40N/H (1984-91) 50E/D (1984-94) |

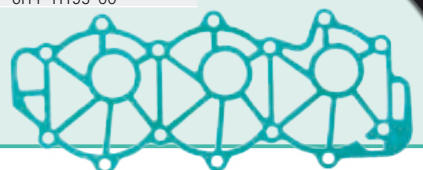

new

CIGÜEÑAL

CRANKSHAFT

ALBERO MOTORE

VILEBREQUIN

2T
STROKES

GUÍA CIGÜEÑAL COMPLETO

GUIDE CRANKSHAFT ASSY

GUIDA ALBERO MOTORE COMPLETO

GUIDE VILEBREQUIN COMPLET

| 2T STROKES | | | 2T STROKES | | | 2T STROKES | | |
|----------------|---------|-----------------|------------------|---------|-----------------|-------------|---------|-----------------|
| | | REF | | | REF | | | REF |
| E48CMHS | 2003 | REC663-11411-00 | 140A | 1984-87 | REC6E5-11411-00 | 175D ETO | 2000 | REC6G5-11411-02 |
| E55CMH/L/S | 2003-05 | REC663-11411-00 | 140B | 1988-89 | REC6E5-11411-00 | 175D ETOX | 2001-02 | REC6G5-11411-02 |
| 55B | 1993-02 | REC663-11411-00 | L140B | 1989 | REC6E5-11411-00 | 200A | 1984-89 | REC6G5-11411-02 |
| 55B E | 1990-92 | REC663-11411-00 | 150A | 1984-89 | REC6G5-11411-02 | 200AET-L-X | 2003 | REC6G5-11411-02 |
| 55B EHD | 2000 | REC663-11411-00 | 150A ET | 1998-00 | REC6G5-11411-02 | 200BETO/ETD | 1990-95 | REC6R3-11411-00 |
| 55B ET | 1990-98 | REC663-11411-00 | 150A ETL/ETX | 2001 | REC6G5-11411-02 | 200CETO | 1992-93 | REC6R3-11411-00 |
| 55B ETL | 2001-02 | REC663-11411-00 | 150D ETOL | 2001-03 | REC6G5-11411-02 | 200F | 1997-98 | REC6G5-11411-02 |
| 80A/90AETO | 1988 | REC688-11411-00 | 150F | 1997-98 | REC6G5-11411-02 | 200F ETO | 2000 | REC6G5-11411-02 |
| 100A | 1996-01 | REC6N7-11411-00 | 150F ETO | 2000 | REC6G5-11411-02 | 200F ETOL | 2001 | REC6G5-11411-02 |
| 100A A ETO | 2000 | REC6N7-11411-00 | 150FETOL-X | 2002-07 | REC6G5-11411-02 | 200FETOL-X | 2002-10 | REC6G5-11411-02 |
| 100A ETOL | 2001 | REC6N7-11411-00 | 150F ETOL | 2001-06 | REC6G5-11411-02 | 200F ETOX | 2001 | REC6G5-11411-02 |
| 115A | 1984-87 | REC6E5-11411-00 | 150F ETOX | 2001-06 | REC6G5-11411-02 | 200G | 1999 | REC6G5-11411-02 |
| 115B | 1985-01 | REC6E5-11411-00 | D150H | 1999 | REC6G5-11411-02 | 200G ETO | 2000 | REC6G5-11411-02 |
| 115B ETO | 1997-00 | REC6N7-11411-00 | DX150TLRA | 2002 | REC67H-11411-00 | 200G ETOL | 2001 | REC6G5-11411-02 |
| 115B ETOL | 2001-02 | REC6N7-11411-00 | L150A | 1988-89 | REC6G5-11411-02 | L200A | 1988-91 | REC6G5-11411-02 |
| 115CEO | 1990-98 | REC6N7-11411-00 | L150CETO | 1990-95 | REC6R3-11411-00 | L200BETO/ET | 1990-95 | REC6R3-11411-00 |
| 115C ETO | 1995-01 | REC6N7-11411-00 | L150F | 1997-98 | REC6G5-11411-02 | L200F | 1997-98 | REC6G5-11411-02 |
| 115CETOL/CETOX | 2001 | REC6N7-11411-00 | L150F ETO | 2000 | REC6G5-11411-02 | L200F ETO | 2000 | REC6G5-11411-02 |
| 130BETO | 1990-01 | REC6N7-11411-00 | L150 FETOL/FETOX | 2001 | REC6G5-11411-02 | PROV200 | 1991-95 | REC6R3-11411-00 |
| 130BETOL/BETOX | 2001 | REC6N7-11411-00 | SX150TXRA | 2002 | REC67H-11411-00 | 220AET | 1984-96 | REC6G5-11411-02 |
| L130B | 1991-98 | REC6N7-11411-00 | 175A | 1984-89 | REC6G5-11411-02 | 225AETO | 1987-89 | REC6G5-11411-02 |
| L130B ETO | 2000 | REC6N7-11411-00 | 175BETO/ET | 1990-95 | REC6R3-11411-00 | 225D-DET | 1997-01 | REC6G5-11411-02 |
| L130B ETOX | 2001 | REC6N7-11411-00 | 175D | 1997-98 | REC6G5-11411-02 | | | |

2T
STROKES

GUÍA PARTES DE CIGÜEÑAL

GUIDE CRANKSHAFT PARTS

GUIDA PARTE ALBERO MOTORE

GUIDE PARTS DE VILEBREQUIN

| | | 1 | 2 | 3 | 4 |
|-------------|---------|-----------------|-----------------|-----------------|-----------------|
| 6B/8B | 1980-81 | REC677-11412-02 | REC677-11422-02 | REC677-11432-02 | REC677-11442-02 |
| E8D | 1996-99 | REC677-11412-02 | REC677-11422-02 | REC677-11432-02 | REC677-11442-02 |
| E8D MH | 1998-99 | REC677-11412-02 | REC677-11422-02 | REC677-11432-02 | REC677-11442-02 |
| 9.9D | 1985-97 | REC682-11412-00 | REC682-11422-00 | REC682-11432-00 | REC682-11442-00 |
| 9.9D | 1988-95 | REC63V-11412-00 | REC6K4-11422-00 | REC6K4-11432-00 | REC682-11442-00 |
| 9.9F/MH | 1995-14 | REC63V-11412-00 | REC63V-11422-00 | REC63V-11432-00 | REC63V-11442-00 |
| 9.9F WH | 2000 | REC63V-11412-00 | REC63V-11422-00 | REC63V-11432-00 | REC63V-11442-00 |
| 9.9F WHL/S | 2001 | REC63V-11412-00 | REC63V-11422-00 | REC63V-11432-00 | REC63V-11442-00 |
| 13.5A | 1999-06 | REC63V-11412-00 | REC63V-11422-00 | REC63V-11432-00 | REC63V-11442-00 |
| 15D | 1985-87 | REC682-11412-00 | REC682-11422-00 | REC63V-11432-00 | REC682-11442-00 |
| 15D | 1988-95 | REC682-11412-00 | REC6K4-11422-00 | REC6K4-11432-00 | REC682-11442-00 |
| 15F/MH | 1995-14 | REC63V-11412-00 | REC63V-11412-00 | REC63V-11432-00 | REC63V-11442-00 |
| E15D | 2003 | REC63V-11412-00 | REC63V-11422-00 | REC63V-11432-00 | REC63V-11442-00 |
| 15F WCL | 2001-03 | REC63V-11412-00 | REC63V-11422-00 | REC63V-11432-00 | REC63V-11442-00 |
| 15 WCS | 2001-02 | REC63V-11412-00 | REC63V-11422-00 | REC63V-11432-00 | REC63V-11442-00 |
| 20C | 1981-86 | REC6G0-11412-00 | REC6G0-11422-00 | REC6G0-11432-00 | |
| 20C | 1996-02 | | REC6G0-11422-00 | REC6G0-11432-00 | |
| 20C M | 1990-02 | REC6G0-11412-00 | REC6G0-11422-00 | REC6G0-11432-00 | |
| 25D | 1985-87 | REC6G0-11412-00 | REC6G0-11422-00 | REC6G0-11432-00 | |
| 25D M | 1990-97 | REC6G0-11412-00 | REC6G0-11422-00 | REC6G0-11432-00 | REC6G0-11442-00 |
| 25D MH | 1998 | REC6G0-11412-00 | REC6G0-11422-00 | REC6G0-11432-00 | REC6G0-11442-00 |
| 25D MHL/MHS | 2001 | REC6G0-11412-00 | REC6G0-11422-00 | REC6G0-11432-00 | REC6G0-11442-00 |
| 40X/E40X/MH | 1998-02 | REC66T-11412-00 | REC66T-11422-00 | REC66T-11432-00 | REC66T-11442-00 |
| 40X MHL | 2001-13 | REC66T-11412-00 | REC66T-11422-00 | REC66T-11432-00 | REC66T-11442-00 |
| 40X MHS | 2001-13 | REC66T-11412-00 | REC66T-11422-00 | REC66T-11432-00 | REC66T-11442-00 |
| 40X W | 2000 | REC66T-11412-00 | REC66T-11422-00 | REC66T-11432-00 | REC66T-11442-00 |
| 40X WL/WS | 2001-03 | REC66T-11412-00 | REC66T-11422-00 | REC66T-11432-00 | REC66T-11442-00 |
| 40X WT | 2000 | REC66T-11412-00 | REC66T-11422-00 | REC66T-11432-00 | REC66T-11442-00 |
| 40X WTL | 2001-03 | REC66T-11412-00 | REC66T-11422-00 | REC66T-11432-00 | REC66T-11442-00 |



1



2



3



4

GUÍA
RODAMIENTOS DE MOTOR

GUIDE
ENGINE BEARING

GUIDA
CUSCINETTI MOTORE

GUIDE
ROULEMENTS DE MOTEUR

| | | 1 | 2 | 3 | 4 | 5 |
|---------------|-----------|----------------|----------------|----------------|----------------|----------------|
| 4A | 1985-87 | REC93306-304U0 | | REC93306-304U0 | REC93310-112V0 | REC93310-418V1 |
| 4AC | 1987-99 | REC93306-304U0 | | REC93306-304U0 | REC93310-112V0 | REC93310-418V1 |
| 4AC | 1999 | REC93306-304U0 | | REC93306-304U0 | REC93310-112V0 | REC93310-418V1 |
| 4AC MHL/MHS | 2001-03 | REC93306-304U0 | | REC93306-304U0 | REC93310-112V0 | REC93310-418V1 |
| 4AS | 1987-96 | REC93306-304U0 | | REC93306-304U0 | REC93310-112V0 | REC93310-418V1 |
| 4BC | 1998-99 | REC93306-304U0 | | REC93306-304U0 | REC93310-112V0 | REC93310-418V1 |
| 4BC | 1999 | REC93306-304U0 | | REC93306-304U0 | REC93310-112V0 | REC93310-418V1 |
| 4BC MHL/MHS | 2001-03 | REC93306-304U0 | | REC93306-304U0 | REC93310-112V0 | REC93310-418V1 |
| 5C | 1985-99 | REC93306-304U0 | | REC93306-304U0 | REC93310-112V0 | REC93310-418V1 |
| 5C MHL/MHS | 2001-13 | REC93306-304U0 | | REC93306-304U0 | REC93310-112V0 | REC93310-418V1 |
| 5CS | 1987-96 | REC93306-304U0 | | REC93306-304U0 | REC93310-112V0 | REC93310-418V1 |
| 6C | 1990 | REC93306-204U0 | REC93306-204U0 | REC93306-204U0 | REC93310-112V0 | REC93310-418V1 |
| 6C | 1990-02 | REC93306-204U0 | REC93306-204U0 | REC93306-204U0 | REC93310-112V0 | REC93310-418V1 |
| 6C MHL/MHS | 2001-06 | REC93306-204U0 | REC93306-204U0 | REC93306-204U0 | REC93310-112V0 | REC93310-418V1 |
| 6C WHL/WHS | 2001 | REC93306-204U0 | REC93306-204U0 | REC93306-204U0 | REC93310-112V0 | REC93310-418V1 |
| 6C | 1990 | REC93306-204U0 | REC93306-204U0 | REC93306-204U0 | REC93310-112V0 | REC93310-418V1 |
| 6D | 1990-98 | REC93306-204U0 | REC93306-204U0 | REC93306-204U0 | REC93310-112V0 | REC93310-418V1 |
| 6D MHL/MHS | 2001-06 | REC93306-204U0 | REC93306-204U0 | REC93306-204U0 | REC93310-112V0 | REC93310-418V1 |
| 6D WHS | 2001 | REC93306-204U0 | REC93306-204U0 | REC93306-204U0 | REC93310-112V0 | REC93310-418V1 |
| 8C | 1987-02 | REC93306-204U0 | REC93306-204U0 | REC93306-204U0 | REC93310-112V0 | REC93310-418V1 |
| 8C MHL/MHS | 2001-12 | REC93306-204U0 | REC93306-204U0 | REC93306-204U0 | REC93310-112V0 | REC93310-418V1 |
| 8C MHX/WHL | 2001-03 | REC93306-204U0 | REC93306-204U0 | REC93306-204U0 | REC93310-112V0 | REC93310-418V1 |
| E8D/MH | 1996-99 | REC93306-204U0 | REC93306-204U0 | REC93306-204U0 | REC93302-14118 | REC93310-418U0 |
| 9.9D | 1985-89 | REC93306-205U2 | REC93304-205U0 | REC93306-304U0 | REC93602-14104 | REC93310-620V5 |
| 9.9D | 1985-95 | REC93306-205U2 | REC93304-205U0 | REC93306-304U0 | REC93602-14104 | REC93310-620V5 |
| 9.9D | 1990-95 | REC93306-205U2 | REC93304-205U0 | REC93306-304U0 | REC93602-14104 | REC93310-620V5 |
| 9.9F | 1995-99 | REC93306-205U7 | REC93306-205U7 | REC93306-205U7 | REC93602-14104 | REC93310-620V5 |
| 9.9F MH | 2000 | REC93306-205U7 | REC93306-205U7 | REC93306-205U7 | REC93602-14104 | REC93310-620V5 |
| 9.9F MHL/MHS | 2001-06 | REC93306-205U7 | REC93306-205U7 | REC93306-205U7 | REC93602-14104 | REC93310-620V5 |
| 9.9F WC/WH | 2000 | REC93306-205U7 | REC93306-205U7 | REC93306-205U7 | REC93602-14104 | REC93310-620V5 |
| 9.9F WHL/WHS | 2001 | REC93306-205U7 | REC93306-205U7 | REC93306-205U7 | REC93602-14104 | REC93310-620V5 |
| 13.5A | 1999 | REC93306-205U7 | REC93306-205U7 | REC93306-205U7 | REC93602-14104 | REC93310-620V5 |
| 13.5A MH | 2000 | REC93306-205U7 | REC93306-205U7 | REC93306-205U7 | REC93602-14104 | REC93310-620V5 |
| 13.5A MHL/MHS | 2001-04 | REC93306-205U7 | REC93306-205U7 | REC93306-205U7 | REC93602-14104 | REC93310-620V5 |
| 13.5A WH | 2000 | REC93306-205U7 | REC93306-205U7 | REC93306-205U7 | REC93602-14104 | REC93310-620V5 |
| 15D | 1985-89 | REC93306-205U2 | REC93304-205U0 | REC93306-304U0 | REC93602-14104 | REC93310-620V5 |
| 15D | 1985 | REC93306-205U2 | REC93304-205U0 | REC93306-304U0 | REC93602-14104 | REC93310-620V5 |
| 15D | 1990-95 | REC93306-205U2 | REC93304-205U0 | REC93306-304U0 | REC93602-14104 | REC93310-620V5 |
| 15F | 1995-99 | REC93306-205U7 | REC93306-205U7 | REC93306-205U7 | REC93602-14104 | REC93310-620V5 |
| 15F MH | 2000 | REC93306-205U7 | REC93306-205U7 | REC93306-205U7 | REC93602-14104 | REC93310-620V5 |
| 15F MHL/MHS | 2001-06 | REC93306-205U7 | REC93306-205U7 | REC93306-205U7 | REC93602-14104 | REC93310-620V5 |
| 15F WC | 2000 | REC93306-205U7 | REC93306-205U7 | REC93306-205U7 | REC93602-14104 | REC93310-620V5 |
| 15F WCL/WCS | 2001-03 | REC93306-205U7 | REC93306-205U7 | REC93306-205U7 | REC93602-14104 | REC93310-620V5 |
| 20C | 1985 | REC93306-305I0 | | REC93306-305I0 | REC93602-20M02 | REC93310-522W0 |
| 20C | 1986-93 | REC93306-305I0 | | REC93306-305I0 | REC93602-20M02 | REC93310-522W0 |
| 20C | 1993 | REC93306-305U3 | | REC93306-305U3 | REC93602-20M02 | REC93310-522W0 |
| 20C M | 1990-97 | REC93306-305U3 | | REC93306-305U3 | REC93602-20M02 | REC93310-522W0 |
| 20C MH | 1998 | REC93306-305U3 | | REC93306-305U3 | REC93602-20M02 | REC93310-522W0 |
| 20C MHL/MHS | 2001-02 | REC93306-305U3 | | REC93306-305U3 | REC93602-20M02 | REC93310-522W0 |
| 20DEM | 1994-98 | REC93311-632U7 | REC93306-305U3 | REC93306-305U3 | | |
| 20D MHOL/MHOS | 2001-06 | REC93311-632U7 | REC93306-305U3 | REC93306-305U3 | | |
| 20D WOL/WOS | 2006 | REC93311-632U7 | REC93306-305U3 | REC93306-305U3 | | |
| 25B | 1994-95 | REC93311-636U6 | | REC93306-306V1 | REC93603-18M09 | REC93603-18M09 |
| 25B MHL/MHS | 2001-06 | REC93399-99951 | | REC93306-305U3 | REC93602-20M02 | |
| 25B WCS | 2001-02 | REC93399-99951 | | REC93306-305U3 | REC93602-20M02 | |
| 25D | 1985 | REC93306-305I0 | | REC93306-305I0 | REC93602-20M02 | REC93310-522W0 |
| 25D | 1986-87 | REC93306-305I0 | | REC93306-305I0 | REC93602-20M02 | REC93310-522W0 |
| 25D M | 1990-97 | REC93311-632U7 | REC93306-305U3 | REC93306-305U3 | REC93602-20M02 | REC93310-522W0 |
| 25D MH | 1998 | REC93311-632U7 | REC93306-305U3 | REC93306-305U3 | REC93602-20M02 | REC93310-522W0 |
| 25D MHL/MHS | 2001 | REC93311-632U7 | REC93306-305U3 | REC93306-305U3 | REC93602-20M02 | REC93310-522W0 |
| 25J | 1987-2000 | | | REC93306-305U3 | | |
| 25J | 1992-2000 | REC93311-632U7 | | REC93306-305U3 | | |
| 25N | 1994-98 | REC93311-632U7 | REC93306-305U3 | REC93306-305U3 | | |
| 25N MHOL/MHOS | 2001-06 | REC93311-632U7 | REC93306-305U3 | REC93306-305U3 | | |
| 25N WOL/WOS | 2001-03 | REC93311-632U7 | REC93306-305U3 | REC93306-305U3 | | |
| 25V | 1996 | REC93311-632U7 | REC93306-305U3 | REC93306-305U3 | REC93602-20M02 | |
| 25V | 1997-98 | REC93311-632V4 | REC93306-305U3 | REC93306-305U3 | REC93602-20M02 | REC93310-624U5 |
| 25V MHL/MHS | 2001 | REC93311-632V4 | REC93306-305U3 | REC93306-305U3 | REC93602-20M02 | REC93310-624U5 |
| 25V WCS | 2001 | REC93311-632V4 | REC93306-305U3 | REC93306-305U3 | REC93602-20M02 | REC93310-624U5 |
| 30A | 1985 | | | REC93306-305I0 | REC93602-20M02 | REC93310-624U5 |
| 30A M | 1990-92 | | | REC93306-305U3 | REC93602-20M02 | REC93310-624U5 |
| 30D | 1986-99 | | | REC93306-305U3 | | |
| 30D | 1992-00 | REC93311-632U7 | | REC93306-305U3 | | |
| 30D EOL/ETOL | 2001-06 | REC93311-632U7 | | REC93306-305U3 | | |
| 30D MHOL/MHOS | 2001-06 | REC93311-632U7 | | REC93306-305U3 | | |
| 30D OL | 2001-03 | REC93311-632U7 | | REC93306-305U3 | | |
| 30D EOS | 2001-06 | REC93311-632U7 | | REC93306-305U3 | | |
| 30G | 1996 | REC93311-632U7 | | REC93306-305U3 | REC93602-20M02 | REC93310-624U5 |

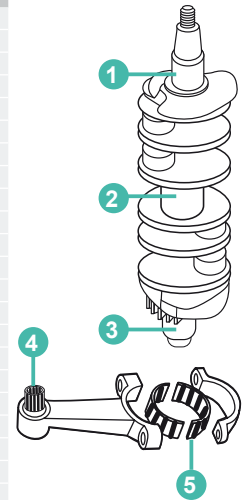



1 2 3 4 5

| | | | | | | |
|---------------|-----------|----------------|----------------|----------------|----------------|----------------|
| 30G | 1996-98 | REC93311-632V4 | | REC93306-305U3 | REC93602-20M02 | REC93310-624U5 |
| 30G MHS/WCS | 2001 | REC93311-632V4 | | REC93306-305U3 | REC93602-20M02 | REC93310-624U5 |
| 30H MHS | 2001-03 | REC93311-632V4 | | REC93306-305U3 | REC93602-20M02 | REC93310-624U5 |
| 30H WCS | 2001-02 | REC93311-632V4 | | REC93306-305U3 | REC93602-20M02 | |
| 40H | 1984-87 | REC93306-305U8 | | REC93306-30510 | REC93602-20M02 | |
| 40Q | 1993-98 | | REC93311-832U4 | | REC93603-21111 | REC93310-730V6 |
| 40Q E/M | 1992 | | REC93311-832U4 | | REC93603-21111 | REC93310-730V6 |
| 40R MHO | 2000 | | | | REC93602-20M02 | |
| 40R ROS | 2001 | | | | REC93602-20M02 | |
| 40V | 1994-99 | REC93306-305U8 | | REC93306-305U8 | REC93602-20M02 | |
| 40V EO | 2000 | REC93306-305U8 | | REC93306-305U8 | REC93602-20M02 | |
| 40V EOL/EOS | 2001-06 | REC93306-305U8 | | REC93306-305U8 | REC93602-20M02 | |
| 40V ETO | 2000 | REC93306-305U8 | | REC93306-305U8 | REC93602-20M02 | |
| 40V ETOL/ETOS | 2001-03 | REC93306-305U8 | | REC93306-305U8 | REC93602-20M02 | |
| 40V MHOL/MHOS | 2001-06 | REC93306-305U8 | | REC93306-305U8 | REC93602-20M02 | |
| 40V MO | 2000 | REC93306-305U8 | | REC93306-305U8 | REC93602-20M02 | |
| 40V MOS | 2002-05 | REC93306-305U8 | | REC93306-305U8 | REC93602-20M02 | |
| 40X | 1998 | REC93306-307U0 | REC93332-000UE | REC93306-306V5 | REC93603-21111 | REC93310-727U0 |
| 40X MH | 2000 | REC93306-307U0 | REC93332-000UE | REC93306-306V5 | REC93603-21111 | REC93310-727U0 |
| 40X MHL | 2001-06 | REC93306-307U0 | REC93332-000UE | REC93306-306V5 | REC93603-21111 | REC93310-727U0 |
| 40X WL/WS | 2001 | REC93306-307U0 | REC93332-000UE | REC93306-306V5 | REC93603-21111 | REC93310-727U0 |
| 40X WT | 2000 | REC93306-307U0 | REC93332-000UE | REC93306-306V5 | REC93603-21111 | REC93310-727U0 |
| 40X WTL | 2001-03 | REC93306-307U0 | REC93332-000UE | REC93306-306V5 | REC93603-21111 | REC93310-727U0 |
| 40Y ETOL | 2001-06 | REC93306-305U8 | | REC93306-305U8 | REC93602-20M02 | |
| 40Y MHOS | 2001-06 | REC93306-305U8 | | REC93306-305U8 | REC93602-20M02 | |
| E40G | 2003 | REC93306-307U0 | REC93332-000UE | REC93306-306V1 | REC93603-21111 | REC93310-727V7 |
| E40J | 2003 | REC93306-307U0 | REC93332-000UE | REC93306-306V1 | REC93603-21111 | REC93310-727V7 |
| 50D | 1984-90 | REC93306-305U8 | | REC93306-30510 | REC93602-20M02 | |
| 50G | 1993-98 | REC93311-636U6 | | REC93306-306V1 | REC93603-18M09 | REC93310-522W0 |
| 50G ETO | 2000 | REC93311-636U6 | | REC93306-306V1 | REC93603-18M09 | REC93310-522W0 |
| 50G ETOL | 2001-06 | REC93311-636U6 | | REC93306-306V1 | REC93603-18M09 | REC93310-522W0 |
| 50H | 1994-99 | REC93306-305U8 | | REC93306-305U8 | REC93602-20M02 | REC93310-522W0 |
| 50H EDO | 2000 | REC93306-305U8 | | REC93306-305U8 | REC93602-20M02 | REC93310-522W0 |
| 50H EDOL/EDOS | 2001-02 | REC93306-305U8 | | REC93306-305U8 | REC93602-20M02 | REC93310-522W0 |
| 50H MDO/MO | 2000 | REC93306-305U8 | | REC93306-305U8 | REC93602-20M02 | REC93310-522W0 |
| 55B | 1993-98 | REC93311-632U1 | | | REC93603-21111 | REC93311-832U4 |
| 55B E | 1990-00 | REC93311-632U1 | REC93311-832U4 | | REC93603-21111 | REC93311-832U4 |
| 55B EHD/ET | 2000 | REC93311-632U1 | REC93311-832U4 | | REC93603-21111 | REC93311-832U4 |
| 55B ETL | 2001-02 | REC93311-632U1 | REC93311-832U4 | | REC93603-21111 | REC93311-832U4 |
| 60F | 1984-98 | REC93311-636U6 | | REC93306-306V1 | REC93603-18M09 | |
| 60F EO/ETO | 2000 | REC93311-636U6 | | REC93306-306V1 | REC93603-18M09 | |
| 60F ETOL | 2001-06 | REC93311-636U6 | | REC93306-306V1 | REC93603-18M09 | |
| E60HMHD | 2003 | REC93311-636U6 | | REC93306-306V1 | | REC93310-527W1 |
| E60 ELHB | 2003 | REC93311-636U6 | | REC93306-306V1 | | REC93310-527W1 |
| E60H MHDL | 2001-06 | REC93311-636U6 | | REC93306-306V1 | REC93603-18M09 | |
| 70B | 1984-98 | REC93311-636U6 | | REC93306-306V1 | REC93603-18M09 | |
| 70B EDOL | 2001 | REC93311-636U6 | | REC93306-306V1 | REC93603-18M09 | |
| 70B EO/ETO | 2000 | REC93311-636U6 | | REC93306-306V1 | REC93603-18M09 | |
| 70B ETOL | 2001-06 | REC93311-636U6 | | REC93306-306V1 | REC93603-18M09 | |
| 75A | 1993-98 | REC93310-636U4 | REC93310-835U8 | REC93306-206U5 | REC93603-21111 | REC93310-730V8 |
| 75A E | 1990-00 | REC93310-636U4 | REC93310-835U8 | REC93306-206U5 | REC93603-21111 | REC93310-730V8 |
| 75A EDL | 2001-06 | REC93310-636U4 | REC93310-835U8 | REC93306-206U5 | REC93603-21111 | REC93310-730V8 |
| 75A EM | 1992 | REC93310-636U4 | REC93310-835U8 | REC93306-206U5 | REC93603-21111 | REC93310-730V8 |
| 75A ET/ETL | 2000 | REC93310-636U4 | REC93310-835U8 | REC93306-206U5 | REC93603-21111 | REC93310-730V8 |
| 75A MHD | 2000 | REC93310-636U4 | REC93310-835U8 | REC93306-206U5 | REC93603-21111 | REC93310-730V8 |
| 75C | 1998 | REC93310-636U4 | REC93310-835U8 | REC93306-206U5 | REC93603-21111 | REC93310-730V8 |
| 75C ETO | 2000 | REC93310-636U4 | REC93310-835U8 | REC93306-206U5 | REC93603-21111 | REC93310-730V8 |
| 75C ETOL | 2001-06 | REC93310-636U4 | REC93310-835U8 | REC93306-206U5 | REC93603-21111 | REC93310-730V8 |
| 80A | 1985-95 | REC93310-636U4 | REC93310-835U8 | REC93306-206U5 | REC93603-21111 | REC93310-730V8 |
| 85A | 1996-98 | REC93310-636U4 | REC93310-835U8 | REC93306-206U5 | REC93603-21111 | REC93310-730V8 |
| 85A E | 1990-2000 | REC93310-636U4 | REC93310-835U8 | REC93306-206U5 | REC93603-21111 | REC93310-730V8 |
| 85A ET/ETL | 2000 | REC93310-636U4 | REC93310-835U8 | REC93306-206U5 | REC93603-21111 | REC93310-730V8 |
| 90A | 1984-98 | REC93310-636U4 | REC93310-835U8 | REC93306-206U5 | REC93603-21111 | REC93310-730V8 |
| 90A ETO/ETOL | 2000 | REC93310-636U4 | REC93310-835U8 | REC93306-206U5 | REC93603-21111 | REC93310-730V8 |
| 100A | 1998 | REC93311-940U3 | REC93310-954U1 | REC93306-208U0 | REC93310-32337 | REC93310-836V2 |
| 100A ETO | 2000 | REC93311-940U3 | REC93310-954U1 | REC93306-208U0 | REC93310-32337 | REC93310-836V2 |
| 100A ETOL | 2001 | REC93311-940U3 | REC93310-954U1 | REC93306-208U0 | REC93310-32337 | REC93310-836V2 |
| 115A | 1984-87 | REC93311-940U3 | REC93310-954V3 | REC93306-208U0 | REC93603-21111 | REC93310-836V2 |
| 115B | 1988-92 | REC93311-940U3 | REC93310-954V3 | REC93306-208U0 | REC93603-21111 | REC93310-836V2 |
| 115B | 1993-96 | REC93311-940U3 | REC93310-954V3 | REC93306-208U0 | REC93310-32337 | REC93310-836V2 |
| 115B ETOL | 2001-02 | REC93311-940U3 | REC93310-954U1 | REC93306-208U0 | REC93310-32337 | REC93310-836U0 |
| 115C | 1988-91 | REC93311-940U3 | REC93310-954V3 | REC93306-208U0 | REC93603-21111 | REC93310-836V2 |
| 115C | 1992-98 | REC93311-940U3 | REC93310-954V3 | REC93306-208U0 | REC93310-32337 | REC93310-836V2 |
| 115C ETO | 2000 | REC93311-940U3 | REC93310-954U1 | REC93306-208U0 | REC93310-32337 | REC93310-836V2 |
| 115C ETOL | 2001 | REC93311-940U3 | REC93310-954U1 | REC93306-208U0 | REC93310-32337 | REC93310-836U0 |
| 115C ETOX | 1988-91 | REC93311-940U3 | REC93310-954U1 | REC93306-208U0 | REC93310-32337 | REC93310-836V2 |
| 130B | 1992-98 | REC93311-940U3 | REC93310-954V3 | REC93306-208U0 | REC93603-21111 | REC93310-836V2 |
| 130B | 2001-06 | REC93311-940U3 | REC93310-954U1 | REC93306-208U0 | REC93310-32337 | REC93310-836V2 |
| 130B ETO | 2000-2005 | REC93306-307U0 | REC93332-000UE | REC93306-208U0 | REC93603-21111 | REC93310-836V2 |
| 130B ETOL | 2001-06 | REC93311-940U3 | REC93310-954U1 | REC93306-208U0 | REC93310-32337 | REC93310-836V2 |
| 130B ETOX | 2001 | REC93311-940U3 | REC93310-954U1 | REC93306-208U0 | REC93310-32337 | REC93310-836U0 |
| L130B | 1988-91 | REC93311-940U3 | REC93310-954U1 | REC93306-208U0 | REC93310-32337 | REC93310-836V2 |
| L130B | 1992-98 | REC93311-940U3 | REC93310-954U1 | REC93306-208U0 | REC93603-21111 | REC93310-836V2 |

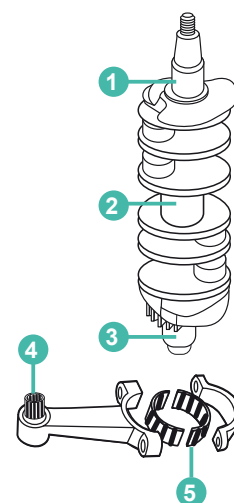



1 2 3 4 5

| | | | | | | |
|-------------------|---------|----------------|----------------|----------------|----------------|----------------|
| L130B ETO | 2000 | REC93311-940U3 | REC93310-954U1 | REC93306-208U0 | REC93310-32337 | REC93310-836V2 |
| L130B ETO | 2001 | REC93311-940U3 | REC93310-954U1 | REC93306-208U0 | REC93310-32337 | REC93310-836V2 |
| 140A | 1984-89 | REC93311-940U3 | REC93310-954U1 | REC93306-208U0 | REC93310-32337 | REC93310-836V2 |
| 140B | 1988-89 | REC93311-940U3 | REC93310-954V3 | REC93306-208U0 | REC93603-21111 | REC93310-836V2 |
| L140B | 1989 | REC93311-940U3 | REC93310-954V3 | REC93306-208U0 | REC93603-21111 | REC93310-836V2 |
| 150A | 1984-89 | REC93311-940U3 | REC93310-954V3 | REC93306-208U0 | REC93603-21111 | REC93310-836V2 |
| 150A ET | 1998-00 | REC93311-940U3 | REC93310-954V3 | REC93306-208U0 | REC93603-21111 | REC93310-836V2 |
| 150A ETL | 2001-02 | REC93311-940U3 | REC93310-954U1 | REC93306-208U0 | REC93310-32337 | REC93310-836V2 |
| 150A ETX | 2001-02 | REC93311-940U3 | REC93310-954U1 | REC93306-208U0 | REC93310-32337 | REC93310-836V2 |
| L150C | 1988-91 | REC93311-940U3 | REC93310-954U1 | REC93306-208U0 | REC93310-32337 | REC93310-836V2 |
| 150C | 1988-91 | REC93311-940U3 | REC93310-954V3 | REC93306-208U0 | REC93603-21111 | REC93310-836V2 |
| 150C | 1992-95 | REC93311-940U3 | REC93310-954V3 | REC93306-208U0 | REC93603-21111 | REC93310-836V2 |
| 150F | 1996-98 | REC93311-940U3 | REC93310-954V3 | REC93306-208U0 | REC93310-32337 | REC93310-836V2 |
| 150F ETO | 2000 | REC93311-940U3 | REC93310-954U1 | REC93306-208U0 | REC93310-32337 | REC93310-836V2 |
| 150F ETOL | 2001-06 | REC93311-940U3 | REC93310-954U1 | REC93306-208U0 | REC93310-32337 | REC93310-836V2 |
| 150F ETOX | 2001-06 | REC93311-940U3 | REC93310-954U1 | REC93306-208U0 | REC93310-32337 | REC93310-836V2 |
| D150H | 1999 | REC93311-940U3 | REC93310-954U1 | REC93306-208U0 | REC93310-32337 | REC93310-836V2 |
| D150HETO | 2001-02 | REC93311-940U3 | REC93310-954U1 | REC93306-208U0 | REC93310-32337 | REC93310-836V2 |
| L150A | 1988-89 | REC93311-940U3 | REC93310-954U1 | REC93306-208U0 | REC93310-32337 | REC93310-836V2 |
| L150C | 1990-95 | REC93311-940U3 | REC93310-954V3 | REC93306-208U0 | REC93603-21111 | REC93310-836V2 |
| L150F | 1996-98 | REC93311-940U3 | REC93310-954V3 | REC93306-208U0 | REC93310-32337 | REC93310-836V2 |
| L150F ETO | 2000 | REC93311-940U3 | REC93310-954U1 | REC93306-208U0 | REC93310-32337 | REC93310-836V2 |
| L150F ETOL | 2001 | REC93311-940U3 | REC93310-954U1 | REC93306-208U0 | REC93310-32337 | REC93310-836V2 |
| L150 EOTX | 2001 | REC93311-940U3 | REC93310-954U1 | REC93306-208U0 | REC93310-32337 | REC93310-836V2 |
| LZ150PETO | 2000-06 | REC93311-940U3 | REC93310-954U1 | REC93306-208U0 | REC93310-32337 | REC93310-836V2 |
| Z150P ETO | 2000 | REC93311-940U3 | REC93310-954U1 | REC93306-208U0 | REC93310-32337 | REC93310-836U0 |
| Z150P ETO | 2001-06 | REC93311-940U3 | REC93310-954U1 | REC93306-208U0 | REC93310-32337 | REC93310-836U0 |
| Z150Q ETO | 2000 | REC93311-940U3 | REC93310-954U1 | REC93306-208U0 | REC93310-32337 | REC93310-836U0 |
| Z150Q ETOL | 2001-06 | REC93311-940U3 | REC93310-954U1 | REC93306-208U0 | REC93310-32337 | REC93310-836U0 |
| 175A | 1984-89 | REC93311-940U3 | REC93310-954U1 | REC93306-208U0 | REC93310-32337 | REC93310-836U0 |
| 175B | 1978-95 | REC93311-940U3 | REC93310-954V3 | REC93306-208U0 | REC93603-21111 | REC93310-836V2 |
| 175D | 1996-98 | REC93311-940U3 | REC93310-954V3 | REC93306-208U0 | REC93310-32337 | REC93310-836V2 |
| 175D ETO/ETOL | 2000 | REC93311-940U3 | REC93310-954U1 | REC93306-208U0 | REC93310-32337 | REC93310-836V2 |
| 175D ETOX/ETOL | 2001-02 | REC93311-940U3 | REC93310-954U1 | REC93306-208U0 | REC93310-32337 | REC93310-836V2 |
| 175D ETOL | 2001 | REC93311-940U3 | REC93310-954U1 | REC93306-208U0 | REC93310-32337 | REC93310-836V2 |
| Z175G ETOX | 2001-06 | REC93311-940U3 | REC93310-954U1 | REC93306-208U0 | REC93310-32337 | REC93310-836U0 |
| 200A | 1984-89 | REC93311-940U3 | REC93310-954U1 | REC93306-208U0 | REC93310-32337 | REC93310-836U0 |
| 200B | 1990-95 | REC93311-940U3 | REC93310-954V3 | REC93306-208U0 | REC93603-21111 | REC93310-836V2 |
| 200F | 1996-98 | REC93311-940U3 | REC93310-954V3 | REC93306-208U0 | REC93310-32337 | REC93310-836V2 |
| 200F ETO/ETOL | 2000 | REC93311-940U3 | REC93310-954U1 | REC93306-208U0 | REC93310-32337 | REC93310-836V2 |
| 200F ETOX | 2001-06 | REC93311-940U3 | REC93310-954U1 | REC93306-208U0 | REC93310-32337 | REC93310-836V2 |
| 200G | 1999-02 | REC93311-940U3 | REC93310-954U1 | REC93306-208U0 | REC93310-32337 | REC93310-836V2 |
| 200G ETO/ETOL | 2000 | REC93311-940U3 | REC93310-954U1 | REC93306-208U0 | REC93310-32337 | REC93310-836V2 |
| L200A | 1988-91 | REC93311-940U3 | REC93310-954U1 | REC93306-208U0 | REC93310-32337 | REC93310-836V2 |
| L200B | 1992-95 | REC93311-940U3 | REC93310-954V3 | REC93306-208U0 | REC93603-21111 | REC93310-836V2 |
| L200F | 1996-98 | REC93311-940U3 | REC93310-954V3 | REC93306-208U0 | REC93310-32337 | REC93310-836V2 |
| L200F ETO/ETOL | 2000 | REC93311-940U3 | REC93310-954U1 | REC93306-208U0 | REC93310-32337 | REC93310-836V2 |
| LZ200N ETO | 2000 | REC93311-940U3 | REC93310-954U1 | REC93306-208U0 | REC93310-32337 | REC93310-836V2 |
| LZ200NETO | | REC93311-940U3 | REC93310-954U1 | REC93306-208U0 | REC93310-32337 | REC93310-836U0 |
| Z200N ETO | 2001-06 | REC93311-940U3 | REC93310-954U1 | REC93306-208U0 | REC93310-32337 | REC93310-836U0 |
| Z200 N ETOL | 2000 | REC93311-940U3 | REC93310-954U1 | REC93306-208U0 | REC93310-32337 | REC93310-836U0 |
| Z200N ETOX/ETOL | 2001-06 | REC93311-940U3 | REC93310-954U1 | REC93306-208U0 | REC93310-32337 | REC93310-836U0 |
| 220A | 2003-06 | REC93311-940U3 | REC93310-954U1 | REC93306-208U0 | REC93310-32337 | REC93310-836U0 |
| 225A | 1984-86 | REC93311-940U3 | REC93310-954V3 | REC93306-208U0 | REC93603-21111 | REC93310-836V2 |
| 225A | 1987-89 | REC93311-940U3 | REC93310-954V3 | REC93306-208U0 | REC93603-21111 | REC93310-836V2 |
| 225D ETO | 2000 | REC93311-940U3 | REC93310-954U1 | REC93306-208U0 | REC93310-32337 | REC93310-836V2 |
| 225D ETOX/ETOL | 2001-03 | REC93311-940U3 | REC93310-954U1 | REC93306-208U0 | REC93310-32337 | REC93310-836V2 |
| 250AET | 1996-06 | | | | REC93310-326V4 | |
| 250B | 95-02 | | | | REC93310-326V4 | |
| 225G | 99-03 | | | | REC93310-326V4 | |
| 225A | 1984-86 | REC93311-940U3 | REC93310-954V3 | REC93306-208U0 | REC93603-21111 | REC93310-836V2 |
| 225A | 1987-89 | REC93311-940U3 | REC93310-954V3 | REC93306-208U0 | REC93603-21111 | REC93310-836V2 |
| 225D ETO | 2000 | REC93311-940U3 | REC93310-954U1 | REC93306-208U0 | REC93310-32337 | REC93310-836V2 |
| 225D ETOX/ETOL | 2001-03 | REC93311-940U3 | REC93310-954U1 | REC93306-208U0 | REC93310-32337 | REC93310-836V2 |
| 250AET | 1996-06 | | | | REC93310-326V4 | |
| 250B | 95-02 | | | | REC93310-326V4 | |
| 225G | 99-03 | | | | REC93310-326V4 | |
| Z, LZ | | | | | | |
| 225/250/300 HP V6 | 1990-10 | REC93306-209U1 | | | | |

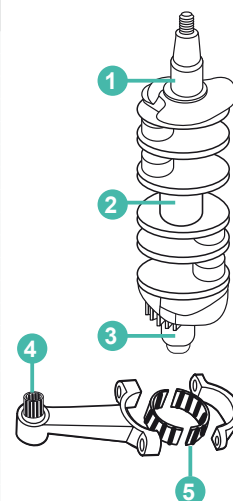

YAMAHA

RECAMBIOS MARINOS

GUÍA DE BIELAS

GUIDE CONNECTING ROAD

GUIDA BIELLE

GUIDE DE BIELLES

| | | 1 | 2 | 3 | 4 | 5 |
|-------------|---------|-----------------|-----------------|----------------|-----------------|----------------|
| 2B | 1986-02 | REC646-11651-02 | | | REC646-11681-00 | REC90209-18112 |
| 2MSHA/S/B | 2002-03 | REC646-11651-02 | | | REC646-11681-00 | |
| 2CMHS | 2010 | REC646-11651-02 | | | REC646-11681-00 | |
| 4A | 1985-87 | REC6E0-11651-01 | REC6G1-11633-00 | | REC6G1-11681-00 | |
| 4AC | 1987-99 | REC6E0-11651-01 | REC6G1-11633-00 | | REC6G1-11681-00 | REC90209-18112 |
| 4AC MHL/HS | 2001-03 | REC6E0-11651-01 | REC6G1-11633-00 | | REC6G1-11681-00 | REC90209-18112 |
| 4AS | 1987-96 | REC6E0-11651-01 | REC6G1-11633-00 | | REC6G1-11681-00 | REC90209-18112 |
| 4BC | 1998-99 | REC6E0-11651-01 | REC6G1-11633-00 | | REC6G1-11681-00 | REC90209-18112 |
| 4BC | 1999 | REC6E0-11651-01 | REC6G1-11633-00 | | REC6G1-11681-00 | REC90209-18112 |
| 4BC MHL/HS | 2001-03 | REC6E0-11651-01 | REC6G1-11633-00 | | REC6G1-11681-00 | REC90209-18112 |
| 5C | 1985-99 | REC6E0-11651-01 | REC6G1-11633-00 | | REC6G1-11681-00 | REC90209-18112 |
| 5C MHL/MHS | 2001-06 | REC6E0-11651-01 | REC6G1-11633-00 | REC90201-12565 | REC6G1-11681-00 | REC90209-18112 |
| 5CS | 1987-96 | REC650-11651-04 | REC634-11633-00 | REC90201-14377 | REC682-11681-00 | REC90209-20159 |
| 6C | 1990 | | REC634-11633-00 | REC90201-14377 | REC682-11681-00 | REC90209-20159 |
| 6C | 1990-98 | | REC634-11633-00 | REC90201-14377 | REC682-11681-00 | REC90209-20159 |
| 6C MHL/HS | 2001-06 | | REC634-11633-00 | REC90201-14377 | REC682-11681-00 | REC90209-18112 |
| 6C WHL/HS | 2001 | | REC634-11633-00 | REC90201-14377 | REC682-11681-00 | REC90209-18112 |
| 6C | 1990 | | REC634-11633-00 | REC90201-14377 | REC682-11681-00 | REC90209-18112 |
| 6D | 1990-98 | | REC634-11633-00 | REC90201-14377 | REC682-11681-00 | REC90209-18112 |
| 6D MHL/HS | 2001-06 | | REC634-11633-00 | REC90201-14377 | REC682-11681-00 | REC90209-18112 |
| 6D WHS | 2001 | | REC634-11633-00 | REC90201-14377 | REC682-11681-00 | REC90209-18112 |
| 8C | 1990-98 | REC677-11651-00 | REC634-11633-00 | REC90201-14377 | REC682-11681-00 | REC90209-18112 |
| 8C | 1990 | REC677-11651-00 | REC634-11633-00 | REC90201-14377 | REC682-11681-00 | REC90209-18112 |
| 8C MHL/HS | 2001-06 | REC677-11651-00 | REC634-11633-00 | REC90201-14377 | REC682-11681-00 | REC90209-20159 |
| 8C MHX | 2001-03 | REC677-11651-00 | REC634-11633-00 | REC90201-14377 | REC682-11681-00 | REC90209-20159 |
| 8C WHL/HS | 2001-02 | REC677-11651-00 | REC634-11633-00 | REC90201-14377 | REC682-11681-00 | REC90209-20159 |
| E8D | 1997-98 | REC6E0-11651-01 | REC634-11633-00 | REC90201-14377 | REC682-11681-00 | REC90209-18112 |
| E8D MH | 1999 | REC6E0-11651-01 | REC634-11633-00 | REC90201-14377 | REC682-11681-00 | REC90209-18112 |
| 9.9D | 1985-89 | REC650-11651-04 | REC634-11633-00 | REC90201-14377 | REC682-11681-00 | |
| 9.9D | 1985-95 | REC6K4-11651-00 | REC634-11633-00 | REC90201-14377 | REC682-11681-00 | |
| 9.9D | 1990-95 | REC6K4-11651-00 | REC634-11633-00 | REC90201-14377 | REC648-11681-00 | REC90209-20159 |
| 9.9F | 1995-99 | REC648-11651-00 | REC648-11633-00 | REC90201-14377 | REC682-11681-00 | REC90209-20159 |
| 9.9F MH | 2000 | REC648-11651-00 | REC648-11633-00 | REC90201-14377 | REC682-11681-00 | REC90209-20159 |
| 9.9F MHL | 2001-06 | REC648-11651-00 | REC648-11633-00 | REC90201-14377 | REC682-11681-00 | REC90209-20159 |
| 9.9F MHS | 2001-06 | REC648-11651-00 | REC648-11633-00 | REC90201-14377 | REC682-11681-00 | REC90209-20159 |
| 9.9F WC | 2000 | REC648-11651-00 | REC648-11633-00 | REC90201-20M27 | REC682-11681-00 | |
| 9.9F WH | 2000 | REC689-11651-00 | REC689-11633-00 | REC90201-20M27 | REC689-11681-00 | REC90209-24M03 |
| 9.9F WHL/HS | 2001 | REC689-11651-00 | REC689-11633-00 | REC90201-20M27 | REC689-11681-00 | REC90209-24M03 |
| 13.5A | 1999 | REC689-11651-00 | REC689-11633-00 | REC90201-20M27 | REC689-11681-00 | REC90209-24M03 |
| 13.5A MH | 2000 | REC689-11651-00 | REC689-11633-00 | REC90201-20M27 | REC689-11681-00 | REC90209-24M03 |
| 13.5A MHL | 2001-04 | REC689-11651-00 | REC689-11633-00 | REC90201-20M27 | REC689-11681-00 | REC90209-24M03 |
| 13.5A MHS | 2001-04 | REC689-11651-00 | REC648-11633-00 | REC90201-14377 | REC648-11681-00 | |
| 13.5A WH | 2000 | REC648-11651-00 | REC648-11633-00 | REC90201-14377 | REC648-11681-00 | |
| 15D | 1985-89 | REC648-11651-00 | REC648-11633-00 | REC90201-14377 | REC648-11681-00 | |
| 15D | 1985-95 | REC648-11651-00 | REC648-11633-00 | REC90201-14377 | REC648-11681-00 | |
| 15D | 1990-95 | REC648-11651-00 | REC648-11633-00 | REC90201-14377 | REC648-11681-00 | |
| 15F | 1995-99 | REC648-11651-00 | REC689-11633-00 | REC90201-20M27 | REC689-11681-00 | REC90209-24M03 |
| 15F MH | 2000 | REC689-11651-00 | REC689-11633-00 | REC90201-20M27 | REC689-11681-00 | REC90209-24M03 |
| 15F MHL/HS | 2001-06 | REC689-11651-00 | REC689-11633-00 | REC90201-20M27 | REC689-11681-00 | REC90209-24M03 |
| 13.5A MH | 2000 | REC689-11651-00 | REC689-11633-00 | REC90201-20M27 | REC689-11681-00 | REC90209-24M03 |
| 13.5A MHL | 2001-04 | REC689-11651-00 | REC689-11633-00 | REC90201-20M27 | REC689-11681-00 | REC90209-24M03 |
| 13.5A MHS | 2001-04 | REC689-11651-00 | REC648-11633-00 | REC90201-14377 | REC648-11681-00 | |
| 13.5A WH | 2000 | REC648-11651-00 | REC648-11633-00 | REC90201-14377 | REC648-11681-00 | |
| 15D | 1985-89 | REC648-11651-00 | REC648-11633-00 | REC90201-14377 | REC648-11681-00 | |
| 15D | 1985-95 | REC648-11651-00 | REC648-11633-00 | REC90201-14377 | REC648-11681-00 | |
| 15D | 1990-95 | REC648-11651-00 | REC648-11633-00 | REC90201-14377 | REC648-11681-00 | |
| 15F | 1995-99 | REC648-11651-00 | REC689-11633-00 | REC90201-20M27 | REC689-11681-00 | REC90209-24M03 |
| 15F MH | 2000 | REC689-11651-00 | REC689-11633-00 | REC90201-20M27 | REC689-11681-00 | REC90209-24M03 |
| 15F MHL/HS | 2001-06 | REC689-11651-00 | REC689-11633-00 | REC90201-20M27 | REC689-11681-00 | REC90209-24M03 |
| 15F WC | 2000 | REC689-11651-00 | REC689-11633-00 | REC90201-20M27 | REC689-11681-00 | REC90209-24M03 |
| 15F WCL | 2001-03 | REC689-11651-00 | REC689-11633-00 | REC90201-20M27 | REC689-11681-00 | REC90209-24M03 |
| 15F WCS | 2001-02 | REC689-11651-00 | REC689-11633-00 | REC90201-20M27 | REC689-11681-00 | REC90209-24M03 |
| 20C | 1985-93 | REC689-11651-00 | REC689-11633-00 | REC90201-20M27 | REC689-11681-00 | REC90209-24M03 |
| 20C | 1986-02 | REC648-11651-00 | REC648-11633-00 | REC90201-20417 | REC648-11681-00 | |
| 20C | 1993 | REC6F5-11651-00 | REC6F5-11633-00 | REC90201-20417 | REC66T-11681-00 | REC90209-27M07 |
| 20C M | 1990-97 | REC6F5-11651-00 | REC6F5-11633-00 | REC90201-20417 | REC66T-11681-00 | REC90209-27M07 |
| 20C MH | 1998 | REC6F5-11651-00 | REC6F5-11633-00 | REC90201-20417 | REC66T-11681-00 | REC90209-27M07 |
| 20C MHL | 2001-02 | REC6F5-11651-00 | REC6F5-11633-00 | REC90201-20417 | REC66T-11681-00 | REC90209-27M07 |
| 20C MHS | 2001-02 | REC6F5-11651-00 | REC6F5-11633-00 | REC90201-20417 | REC66T-11681-00 | REC90209-27M07 |
| 20D | 1994-98 | REC6F5-11651-00 | REC6F5-11633-00 | REC90201-20417 | REC66T-11681-00 | REC90209-27M07 |
| 20D MHOL | 2001-06 | REC6F5-11651-00 | REC6F5-11633-00 | REC90201-20417 | REC66T-11681-00 | REC90209-27M07 |
| 20D MHOS | 2001-06 | REC6F5-11651-00 | REC6F5-11633-00 | REC90201-20417 | REC66T-11681-00 | REC90209-27M07 |
| 20D WOL/OS | 2006 | REC6F5-11651-00 | REC6F5-11633-00 | REC90201-20417 | REC66T-11681-00 | REC90209-27M07 |
| 25B | 1994-02 | REC689-11651-00 | REC663-11633-00 | REC90201-20417 | REC689-11681-00 | REC90209-24M03 |
| 25B MHL/HS | 2001-06 | REC689-11651-00 | REC663-11633-00 | REC90201-20417 | REC689-11681-00 | REC90209-24M03 |
| 25B WCS | 2001-02 | REC689-11651-00 | REC663-11633-00 | REC90201-20417 | REC689-11681-00 | REC90209-24M03 |
| 25D | 1985-01 | REC648-11651-00 | REC663-11633-00 | REC90201-20417 | REC648-11681-00 | |
| 25D | 1986-87 | REC648-11651-00 | REC663-11633-00 | REC90201-20417 | REC648-11681-00 | |
| 25D M | 1990-97 | REC648-11651-00 | REC663-11633-00 | REC90201-20417 | | |
| 25D MH | 1998 | REC648-11651-00 | | | | |
| 25D MHL | 2001 | REC648-11651-00 | | | | |

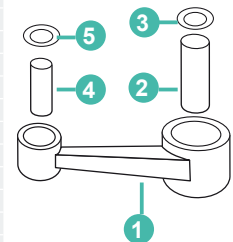

YAMAHA

RECAMBIOS MARINOS



1

2

3

4

5

| | | | | | | | |
|--------------|---------|-----------------|-----------------|----------------|-----------------|----------------|--|
| 25D MHS | 2001 | REC648-11651-00 | | | | | |
| 25N | 1994-98 | | REC6H3-11633-00 | REC90201-20417 | | | |
| 25N MHOL/S | 2001-06 | REC689-11651-00 | REC663-11633-00 | REC90201-20417 | | | |
| 25N WOL/WOS | 2001-03 | REC689-11651-00 | REC663-11633-00 | REC90201-20417 | | | |
| 25V | 1996-98 | REC689-11651-00 | REC663-11633-00 | REC90201-20417 | REC689-11681-00 | REC90209-24M03 | |
| 25V MHL/HS | 2001 | REC689-11651-00 | REC663-11633-00 | REC90201-20417 | REC689-11681-00 | REC90209-24M03 | |
| 25V WCS | 2001 | REC689-11651-00 | REC663-11633-00 | REC90201-20417 | REC689-11681-00 | REC90209-24M03 | |
| 30A | 1985 | REC689-11651-00 | REC663-11633-00 | REC90201-20417 | REC689-11681-00 | REC90209-24M03 | |
| 30A M | 1990-92 | REC689-11651-00 | REC663-11633-00 | REC90201-20417 | REC689-11681-00 | REC90209-24M03 | |
| 30D | 1986-00 | REC689-11651-00 | REC663-11633-00 | REC90201-20417 | | | |
| 30D EOL/EOS | 2001-06 | REC689-11651-00 | REC663-11633-00 | REC90201-20417 | | | |
| 30D ETOL | 2001-06 | REC689-11651-00 | REC663-11633-00 | REC90201-20417 | | | |
| 30D MHOL | 2001-06 | REC689-11651-00 | REC663-11633-00 | REC90201-20417 | | | |
| 30D MHOS | 2001-05 | REC689-11651-00 | REC663-11633-00 | REC90201-20417 | | | |
| 30D OL | 2001-03 | REC689-11651-00 | REC663-11633-00 | REC90201-20417 | | | |
| 30D EOS | 2001-06 | | REC6R5-11633-00 | REC90201-23M01 | | | |
| 40G/J | 1986-89 | REC6F5-11651-00 | REC6F5-11633-00 | | REC6F5-11681-00 | REC90209-27M11 | |
| 40R ROS | 2001 | | REC6R5-11633-00 | REC90201-23M01 | | | |
| 40V | 1994-99 | REC6H4-11651-00 | REC6R5-11633-00 | REC90201-23M01 | | | |
| 40V EO | 2000 | REC6E5-11651-00 | REC6R5-11633-00 | REC90201-23M01 | | | |
| 40V EOL/EOS | 2001-06 | | REC6R5-11633-00 | REC90201-23M01 | | | |
| 40V ETO | 2000 | REC6E5-11651-00 | REC6E5-11633-00 | | | | |
| 40V ETOL | 2001-03 | REC6E5-11651-00 | | | | | |
| 40V ETOS | 2001-03 | REC6E5-11651-00 | | | | | |
| 40V MHOL | 2001-06 | REC6E5-11651-00 | | | | | |
| 40V MHOS | 2001-06 | | REC6E5-11633-00 | | | | |
| 40V MO | 2000 | | REC6R5-11633-00 | REC90201-23M01 | | | |
| 40V MOS | 2002-05 | | REC6R5-11633-00 | REC90201-23M01 | | | |
| 40X | 1998 | REC6F5-11651-00 | REC6F5-11633-00 | REC90201-23M01 | REC66T-11681-00 | REC90209-27M07 | |
| 40X MH | 2000 | REC6F5-11651-00 | REC6F5-11633-00 | REC90201-23M01 | REC66T-11681-00 | REC90209-27M07 | |
| 40X MHL | 2001-06 | REC6F5-11651-00 | REC6F5-11633-00 | REC90201-23M01 | REC66T-11681-00 | REC90209-27M07 | |
| 40 MHS | 2001-02 | REC6F5-11651-00 | REC6F5-11633-00 | REC90201-23M01 | REC66T-11681-00 | REC90209-27M07 | |
| 40X W | 2000 | REC6F5-11651-00 | REC6F5-11633-00 | REC90201-23M01 | REC66T-11681-00 | REC90209-27M07 | |
| 40X WL | 2001 | REC6F5-11651-00 | REC6F5-11633-00 | REC90201-23M01 | REC66T-11681-00 | REC90209-27M07 | |
| 40X WS | 2001 | REC6E5-11651-00 | REC6F5-11633-00 | | REC66T-11681-00 | REC90209-27M07 | |
| 40X WT | 2000 | REC6E5-11651-00 | REC6F5-11633-00 | REC90201-23M01 | REC66T-11681-00 | REC90209-27M07 | |
| 40X WTL | 2001-03 | | REC6F5-11633-00 | REC90201-23M01 | REC66T-11681-00 | REC90209-27M07 | |
| 40Y ETOL | 2001-06 | | REC6R5-11633-00 | REC90201-23M01 | | | |
| 40Y MHOS | 2001-06 | | REC6R5-11633-00 | REC90201-23M01 | | | |
| 40GM,W,J | 2003-04 | REC6F5-11651-00 | REC6F5-11633-00 | REC90209-27M07 | REC6F5-11681-00 | REC90209-27M07 | |
| 50D | 1984-87 | | REC6R5-11633-00 | REC90201-23M01 | | | |
| 50G | 1993-98 | REC6H4-11651-00 | REC648-11633-00 | | REC6G0-11681-00 | REC90209-24M03 | |
| 50G ETO | 2000 | REC6E5-11651-00 | REC648-11633-00 | REC90201-23M01 | REC6G0-11681-00 | REC90209-24M03 | |
| 50G ETOL | 2001-06 | | REC648-11633-00 | REC90201-23M01 | REC6G0-11681-00 | REC90209-24M03 | |
| 50H | 1994-99 | REC6H4-11651-00 | REC648-11633-00 | REC90201-23M01 | REC6G0-11681-00 | REC90209-24M03 | |
| 50H EDO | 2000 | REC6H4-11651-00 | REC648-11633-00 | REC90201-23M01 | REC6G0-11681-00 | REC90209-24M03 | |
| 50H EDOL | 2001-02 | REC6H4-11651-00 | REC648-11633-00 | REC90201-23M01 | REC6G0-11681-00 | REC90209-24M03 | |
| 50H EDOS | 2001-02 | REC6E5-11651-00 | REC648-11633-00 | | REC6G0-11681-00 | REC90209-24M03 | |
| 50H MDO | 2000 | REC6E5-11651-00 | REC648-11633-00 | REC90201-23M01 | REC6G0-11681-00 | REC90209-24M03 | |
| 50H MO | 2000 | | REC648-11633-00 | REC90201-23M01 | REC6G0-11681-00 | REC90209-24M03 | |
| 55B | 1993-98 | REC688-11651-00 | REC6R5-11633-00 | REC90201-23M01 | | | |
| 70B ETOL | 2001-06 | REC6E5-11651-00 | REC6R5-11633-00 | REC90201-23M01 | | | |
| 75A | 1993-98 | REC688-11651-00 | REC6R5-11633-00 | REC90201-23M01 | | | |
| 75A E | 1990-00 | REC688-11651-00 | REC6R5-11633-00 | REC90201-23M01 | | | |
| 75A EDL | 2001-06 | REC688-11651-00 | REC6R5-11633-00 | REC90201-23M01 | | | |
| 75A EM | 1992 | REC688-11651-00 | REC6R5-11633-00 | REC90201-23M01 | | | |
| 75A ET | 2000 | REC688-11651-00 | | | | | |
| 75A ETL | 2001-02 | REC688-11651-00 | | | | | |
| 75A MHD | 2000 | REC688-11651-00 | | | | | |
| 75C | 1998 | REC688-11651-00 | | | | | |
| 75C ETO | 2000 | REC688-11651-00 | | | | | |
| 75C ETOL | 2001-06 | REC688-11651-00 | | | | | |
| 80A | 1985-96 | REC688-11651-00 | | | | | |
| 85A | 1996-98 | REC688-11651-00 | | | | | |
| 85A E | 1990-00 | REC688-11651-00 | | | | | |
| 85A ET | 2000 | REC688-11651-00 | | | | | |
| 85A ETL | 2001-02 | REC688-11651-00 | | | | | |
| 90A | 1984-98 | REC688-11651-00 | | | | | |
| 90A ETO | 2000-00 | REC688-11651-00 | | | | | |
| 90A ETOL | 2001-06 | REC688-11651-00 | | | | | |
| V4-V6 | 21.5 | REC6E5-11651-00 | | | | | |
| E60 ELHB | 2003 | | | | REC6K5-11681-00 | | |
| E60HMHD | 2003 | | | | REC6K5-11681-00 | | |
| 225 AET | 1986 | | REC6E5-11633-00 | | | | |
| 115 B | 1988-90 | REC6E5-11650-01 | REC6K7-11633-00 | REC90201-21M75 | | | |
| 115BE-T | 1991-92 | REC6E5-11650-01 | REC6K7-11633-00 | REC90201-21M75 | | | |
| 140 BETO | 1988-89 | REC6E5-11650-01 | REC6K7-11633-00 | REC90201-21M75 | | | |
| 150 AETO | 1988-89 | REC6E5-11650-01 | REC6K7-11633-00 | REC90201-21M75 | | | |
| 200-225 BETO | 1990-92 | REC6E5-11650-01 | REC6K7-11633-00 | REC90201-21M75 | | | |
| 175 BETO | 1990-92 | REC6E5-11650-01 | REC6K7-11633-00 | REC90201-21M75 | | | |
| 250A,E 225C | 1990-06 | REC61A-11650-00 | | | | | |
| 250B | | | | | | | |

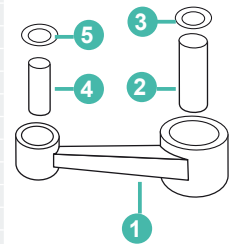

YAMAHA

RECAMBIOS
MARINOS

PISTONES

PISTON

PISTONE

PISTONS

2T
STROKES

KITS DE PISTONES

La gama de pistones RECMAR®, se suministrará siempre como kit, compuesto por pistón, aros, bulón y clips. Eventualmente las referencias antiguas sufren cambios de numeración. En caso de duda contacten con nuestros técnicos comerciales.

PISTON KITS







The RECMAR® piston assortment is always supplied as a set (piston, rings, pins and bearings). Old references may change. In case of any doubt contact our technicians.

KIT PISTONE







La gamma dei pistoni RECMAR®, si vende sempre come kit, composto da pistoni, fasce, bulloni e clips. Le referenze vecchie avranno un cambio di numerazione. In caso di dubbi contattare i nostri tecnici commerciali.

KIT PISTON







La gamme de pistons RECMAR® sera toujours fournie en kit, comprenant piston, segments, axe et clips. Les anciennes références subissent des modifications de numérotation. En cas de doute, contactez nos technico commerciaux

| | STD Ø 50mm | |
|---|---|-----------------|
| | REF | OEM |
|  | REC6E0-11631-00-98K | 6E0-11631-00-98 |
|  | REC6G1-11610-00 | 6G1-11610-00 |
|  | REC6G1-11633-00 | 6G1-11633-00 |
|  | REC93310-112V0 | 93310-112V0 |
|  | REC93450-13022 | 93450-13022 |
|  | 4AC (1985-02) 4AS (1987-96) 5C (1994-98) 5CS (1994-96) | |







| | STD Ø 50mm | | 0.25 | | 0.50 | |
|---|----------------------------------|-----------------|------------------|--------------|------------------|--------------|
| | REF | OEM | REF | OEM | REF | OEM |
|  | REC677-11631-00K | 677-11631-00-97 | REC677-11635-00K | 677-11635-00 | REC677-11636-00K | 677-11636-00 |
|  | REC647-11610-00 | 647-11610-00 | | | | |
|  | REC6G1-11633-00 | 6G1-11633-00 | REC6G1-11633-00 | 6G1-11633-00 | REC6G1-11633-00 | 6G1-11633-00 |
|  | REC93602-14118 | 93602-14118 | REC93602-14118 | 93602-14118 | REC93602-14118 | 93602-14118 |
|  | REC93450-13022 | 93450-13022 | REC93450-13022 | 93450-13022 | REC93450-13022 | 93450-13022 |
|  | E8D (1997-99) E8DMH (1998-03) | | | | | |









| | STD Ø 56mm | | 0.25 | | 0.50 | |
|---|--|--------------|------------------|--------------|------------------|--------------|
| | REF | OEM | REF | OEM | REF | OEM |
|  | REC6E7-11631-00K | 6E7-11631-00 | REC6E7-11635-00K | 6E7-11635-00 | REC6E7-11636-00K | 6E7-11636-00 |
|  | REC682-11610-01 | 682-11610-00 | REC682-11610-11 | 682-11610-11 | REC682-11610-21 | 682-11610-21 |
|  | REC634-11633-00 | 634-11633-00 | REC634-11633-00 | 634-11633-00 | REC634-11633-00 | 634-11633-00 |
|  | REC93602-14104 | 93602-14104 | REC93602-14104 | 93602-14104 | REC93602-14104 | 93602-14104 |
|  | REC93450-15023 | 93450-15023 | REC93450-15023 | 93450-15023 | REC93450-15023 | 93450-15023 |
|  | 9.9D/15D (1985-95) 9.9F/FMH/MSH (1995-14) 15F/FEM/MSH/FMH/MH (1995-14) | | | | | |









| | STD Ø 72mm | | 0.25 | | 0.50 | |
|---|--|-----------------|------------------|--------------|------------------|--------------|
| | REF | OEM | REF | OEM | REF | OEM |
|  | REC6H3-11631-01K | 6H3-11631-01-96 | REC6H3-11635-01K | 6H3-11635-01 | REC6H3-11636-01K | 6H3-11636-01 |
|  | REC6K5-11601-02 | 6K5-11601-02 | REC6K5-11601-12 | 6K5-11601-12 | REC6K5-11601-22 | 6K5-11601-22 |
|  | REC6H3-11633-00 | 6H3-11633-00 | REC6H3-11633-00 | 6H3-11633-00 | REC6H3-11633-00 | 6H3-11633-00 |
|  | REC93603-18M09 | 93603-18M09 | REC93603-18M09 | 93603-18M09 | REC93603-18M09 | 93603-18M09 |
|  | 25B/BETO (1994-95) 50G/GEO/GETO (1993-07) 60F/FE0/FEDO/FETO/FEH/TR/TLR (1990-07) 70BEH/BEO/B/BEM/BETO/BEDO/TR (1990-13) | | | | | |



| | STD Ø 72mm | | 0.25 | | 0.50 | |
|---|---|-----------------|------------------|--------------|------------------|--------------|
| | REF | OEM | REF | OEM | REF | OEM |
|  | REC61N-11631-00K | 61N-11631-00-95 | REC61N-11635-00K | 61N-11635-00 | REC61N-11636-00K | 61N-11636-00 |
|  | REC61N-11603-00 | 61N-11603-00 | REC61N-11604-00 | 61N-11604-00 | REC61N-11605-00 | 61N-11605-00 |
|  | REC689-11633-00 | 689-11633-00 | REC689-11633-00 | 689-11633-00 | REC689-11633-00 | 689-11633-00 |
|  | REC93602-20M02 | 93602-20M02 | REC93602-20M02 | 93602-20M02 | REC93602-20M02 | 93602-20M02 |
|  | REC688-11634-00 | 688-11634-00 | REC688-11634-00 | 688-11634-00 | REC688-11634-00 | 688-11634-00 |
|  | 25VE/VM (1996-01) 25B/BMH (2001-10) 30G/GE (1996-00) E30HMH(2003) E30HMH/HW (2003-12) | | | | | |





| | STD Ø 67mm | | 0.25 | | 0.50 | |
|---|---|-----------------|------------------|--------------|------------------|--------------|
| | REF | OEM | REF | OEM | REF | OEM |
|  | REC6H4-11631-01K | 6H4-11631-01-95 | REC6H4-11635-01K | 6H4-11635-01 | REC6H4-11636-01K | 6H4-11636-01 |
|  | REC63D-11603-00 | 63D-11603-00 | | | REC63D-11605-00 | 63D-11605-00 |
|  | REC648-11633-00 | 648-11633-00 | REC648-11633-00 | 648-11633-00 | REC648-11633-00 | 648-11633-00 |
|  | REC93602-20M02 | 93602-20M02 | REC93602-20M02 | 93602-20M02 | REC93602-20M02 | 93602-20M02 |
|  | REC6H4-11634-01 | 6H4-11634-01 | REC6H4-11634-01 | 6H4-11634-01 | REC6H4-11634-01 | 6H4-11634-01 |
|  | 25Q/QEO (1990-94) 40V/VMH/VETO/VMH/MLH/VMHO/VE/VEO/TLR/VETO/YETO/H/HE (1995-13) C40T/TLR (1995-02) 50H/HRD/HMHD/HETO/HEDO/HWM/D/DE/DEMTO (1989-03) | | | | | |









| | STD Ø 72mm | |
|---|------------------|-----------------|
| | REF | OEM |
|  | REC689-11631-00K | 689-11631-00-95 |
|  | REC689-11610-00 | 689-11610-01 |
|  | REC689-11633-00 | 689-11633-00 |
|  | REC93602-20M02 | 93602-20M02 |
|  | REC663-11634-00 | 633-11634-00 |
|  | 30A (1985-1992) | |









| | STD Ø 59mm | |
|---|---|-----------------|
| | REF | OEM |
|  | REC6J8-11631-02 | 6J8-11631-02-97 |
|  | 25J/JEO/JETO/ESH (1990-99) 30DETO/DEO/DE/DMH/D/ELH/ DWH (1990-12) | |









| | STD Ø 76mm | | 0.25 | | 0.50 | |
|---|---|-----------------|------------------|--------------|------------------|--------------|
| | REF | OEM | REF | OEM | REF | OEM |
|  | REC6F6-11631-00K | 6F6-11631-00-95 | REC6F6-11635-00K | 6F6-11635-00 | REC6F6-11636-00K | 6F6-11636-00 |
|  | REC6F5-11610-00 | 6F5-11610-00 | REC6F5-11610-10 | 6F5-11610-10 | REC6F5-11610-20 | 6F5-11610-20 |
|  | REC6F5-11633-00 | 6F5-11633-00 | REC6F5-11633-00 | 6F5-11633-00 | REC6F5-11633-00 | 6F5-11633-00 |
|  | REC93603-21111 | 93603-21111 | REC93603-21111 | 93603-21111 | REC93603-21111 | 93603-21111 |
|  | REC663-11634-00 | 663-11634-00 | REC663-11634-00 | 663-11634-00 | REC663-11634-00 | 663-11634-00 |
|  | E40GMH/JMH/JWH (2003) 40GWH/JWH (2003) | | | | | |







| | STD Ø 80mm | | 0.25 | | 0.50 | |
|---|---|-----------------|------------------|--------------|------------------|--------------|
| | REF | OEM | REF | OEM | REF | OEM |
|  | REC66T-11631-01K | 66T-11631-01-93 | REC66T-11635-01K | 66T-11635-01 | REC66T-11636-01K | 66T-11636-01 |
|  | REC66T-11603-00 | 66T-11603-00 | REC66T-11604-00 | 66T-11604-00 | REC66T-11605-00 | 66T-11605-00 |
|  | REC6F5-11633-00 | 6F5-11633-00 | REC6F5-11633-00 | 6F5-11633-00 | REC6F5-11633-00 | 6F5-11633-00 |
|  | REC93603-21111 | 93603-21111 | REC93603-21111 | 93603-21111 | REC93603-21111 | 93603-21111 |
|  | REC663-11634-00 | 663-11634-00 | REC663-11634-00 | 663-11634-00 | REC663-11634-00 | 663-11634-00 |
|  | E40X/XMH/XW (2002-13) 40XMH/XW (2003-13) | | | | | |









| | STD Ø 67mm | | 0.25 | | 0.50 | |
|---|--|-----------------|------------------|--------------|------------------|--------------|
| | REF | OEM | REF | OEM | REF | OEM |
|  | REC6H4-11631-00K | 6H4-11631-00-96 | REC6H4-11635-00K | 6H4-11635-00 | REC6H4-11636-00K | 6H4-11636-00 |
|  | REC6H4-11610-00-00 | 6H4-11610-00 | | | | |
|  | REC648-11633-00 | 648-11633-00 | REC648-11633-00 | 648-11633-00 | REC648-11633-00 | 648-11633-00 |
|  | REC93602-20M02 | 93602-20M02 | REC93602-20M02 | 93602-20M02 | REC93602-20M02 | 93602-20M02 |
|  | REC6H4-11634-01 | 6H4-11634-01 | REC6H4-11634-01 | 6H4-11634-01 | REC6H4-11634-01 | 6H4-11634-01 |
|  | 40N/E/H (1984-1988) 50D/ETN (1984-1988) | | | | | |







| | STD Ø 81mm | | 0.25 | | 0.50 | |
|---|---|-----------------|----------------|-------------|-----------------|--------------|
| | REF | OEM | REF | OEM | REF | OEM |
|  | REC6H1-11631-03K | 6H1-11631-03-95 | | | | |
|  | REC688-11603-A0 | 688-11603-A0 | | | REC688-11605-A0 | 688-11605-A0 |
|  | REC663-11633-00 | 663-11633-00 | | | | |
|  | REC93603-21111 | 93603-21111 | REC93603-21111 | 93603-21111 | REC93603-21111 | 93603-21111 |
|  | 55B (1996) 75 TLRB (2003) 75CETO (2004-13) 75AE/T/M/HD (1995-98) E75B (2000-02) 75AED (2003-07) 75TLR (2000-02) 80A/AETO/AEMTO (1994-02) 85A/AE (1995-02) 90A/AEO/AEMO/AETO/AET/TLR/AETO (1994-13) | | | | | |









| | STD Ø 82mm | |
|---|-----------------------------|-----------------|
| | REF | OEM |
|  | REC688-11631-02K | 688-11631-02-95 |
|  | REC688-11610-02 | 688-11610-02 |
|  | REC663-11633-00 | 663-11633-00 |
|  | REC93603-21111 | 93603-21111 |
|  | REC688-11634-00 | 688-11634-00 |
|  | 55BET (1990) 55BE (1992) | |







| | STD | |
|---|--------------------------------------|-----------------|
| | REF | OEM |
|  | REC688-11631-81K | 688-11631-81-96 |
|  | REC688-11610-02 | 688-11610-02 |
|  | REC93603-21111 | 93603-21111 |
|  | 75A/AE (1990-93) 85A/AE (1990-93) | |









| | STD Ø 82mm | | 0.25 | | 0.50 | |
|---|--|-----------------|------------------|--------------|------------------|--------------|
| | REF | OEM | REF | OEM | REF | OEM |
|  | REC688-11631-03K | 688-11631-03-94 | REC688-11635-03K | 688-11635-03 | REC688-11636-03K | 688-11635-03 |
|  | REC688-11603-A0 | 688-11603-A0 | | | REC688-11605-A0 | 688-11605-A0 |
|  | REC663-11633-00 | 663-11633-00 | REC663-11633-00 | 663-11633-00 | REC663-11633-00 | 663-11633-00 |
|  | REC93603-21111 | 93603-21111 | REC93603-21111 | 93603-21111 | REC93603-21111 | 93603-21111 |
|  | REC688-11634-00 | 688-11634-00 | REC688-11634-00 | 688-11634-00 | REC688-11634-00 | 688-11634-00 |
|  | E48CMHS (2003) 55B/BM/BET (1993-02) E55CMH (2003-05) E75B (2000) 85A/AET/AED (2000-03) | | | | | |









| | STD Ø 72mm | | 0.25 | | 0.50 | |
|---|--|-----------------|------------------|--------------|------------------|--------------|
| | REF | OEM | REF | OEM | REF | OEM |
|  | REC6K5-11631-03K | 6K5-11631-03-95 | REC6K5-11635-03K | 6K5-11635-03 | REC6K5-11636-03K | 6K5-11636-03 |
|  | REC6K5-11601-02 | 6K5-11601-02 | REC6K5-11601-12 | 6K5-11601-12 | REC6K5-11601-22 | 6K5-11601-22 |
|  | REC6H3-11633-00 | 6H3-11633-00 | REC6H3-11633-00 | 6H3-11633-00 | REC6H3-11633-00 | 6H3-11633-00 |
|  | REC93603-18M09 | 93603-18M09 | REC93603-18M09 | 93603-18M09 | REC93603-18M09 | 93603-18M09 |
|  | E60HE/HM/H/MHZ/MLHA/ELHB/HMHD -S-L (1997-13) | | | | | |









| | STD Ø 89mm | | STD Ø 89mm | |
|---|---|-------------------------------|---|--------------------------------|
| | ESTRIBOR REF | STD TRIBORDO DROIT OEM | BABOR REF | PORT BABORDO GAUCHE OEM |
|  | REC6R5-11631-11K | 6R5-11631-11-93 | REC6R5-11642-11K | 6R5-11642-11-93 |
|  | REC6R5-11603-00 | 6R5-11603-00 | REC6R5-11603-00 | 6R5-11603-00 |
|  | REC6R5-11633-00 | 6R5-11633-00 | | |
|  | REC93310-32337 | 93310-32337 | REC93310-32337 | 93310-32337 |
|  | REC6R5-11634-00 | 6R5-11634-10 | REC6R5-11634-00 | 6R5-11634-10 |
|  | 100A/AETO (1996-01) 115B (2000-02) 115CEO/CETO/TLR/TXRZ (1993-13) 130BETO/TLR (1993-07) 150 CETO/L150CETO (1993-95) | | 175BETO (1993-95) 200CETO (1993) 200BETO (1993-95) 225BET/BETO (1993-95) | |









| | STD Ø 89mm | | STD Ø 89mm | | 0.2590 | | 0.50 | |
|---|--|-------------------------------|------------------|--------------------------------|-----------------|--------------|-----------------|--------------|
| | ESTRIBOR REF | STD TRIBORDO DROIT OEM | BABOR REF | PORT BABORDO GAUCHE OEM | REF | OEM | REF | OEM |
|  | REC6R5-11631-01K | 6R5-11631-11-93 | REC6R5-11642-01K | 6R5-11642-11-93 | | | | |
|  | REC64D-11603-01 | 64D-11603-02 | REC64D-11603-01 | 64D-11603-02 | REC64D-11604-01 | 64D-11603-04 | REC64D-11605-01 | 64D-11603-05 |
|  | REC6K7-11633-00 | 6K7-11633-00 | REC6K7-11633-00 | 6K7-11633-00 | | | | |
|  | REC93310-32337 | 93603-21111 | REC93310-32337 | 93603-21111 | | | | |
|  | REC6R5-11634-00 | 6R5-11634-00 | REC6R5-11634-00 | 6R5-11634-00 | | | | |
|  | 115BE/CEO (1992) E115AEL (2003) 130BETO (1992) 150CETO (1992) 175BETO (1992) 200BETO (1992) | | | | | | | |







| | STD Ø 89mm | | STD Ø 89mm | |
|---|---|-------------------------------|------------------|--------------------------------|
| | ESTRIBOR REF | STD TRIBORDO DROIT OEM | BABOR REF | PORT BABORDO GAUCHE OEM |
|  | REC6G5-11631-00K | 6G5-11631-00-93 | REC6G5-11642-00K | 6G5-11642-00-93 |
|  | REC6E5-11610-02 | 6E5-11610-02 | REC6E5-11610-02 | 6E5-11610-02 |
|  | REC6E5-11633-00 | 6E5-11633-01 | REC6E5-11633-00 | 6E5-11633-01 |
|  | REC93603-21111 | 93603-21111 | REC93603-21111 | 93603-21111 |
|  | REC6E5-11634-00 | 6E5-11634-00 | REC6E5-11634-00 | 6E5-11634-00 |
|  | 115ETN (1984) 115A (1985-87) 140AETO (1984-87) 150ETN (1984) 150AETO (1985-87) 175AETO (1984-87) 200ETN (1984) 200AETO (1985-87) | | | |



| | STD Ø 89mm | | STD Ø 89mm | |
|---|--|-------------------------------|---|--------------------------------|
| | ESTRIBOR REF | STD TRIBORDO DROIT OEM | BABOR REF | PORT BABORDO GAUCHE OEM |
|  | REC64D-11631-00K | 64D-11631-02-90 | REC64D-11642-00K | 64D-11642-02-90 |
|  | REC64D-11603-01 | 64D-11603-02 | REC64D-11603-01 | 64D-11603-02 |
|  | REC6R5-11633-00 | 6R5-11633-10 | REC6R5-11633-00 | 6R5-11633-10 |
|  | REC93310-32337 | 93310-32337 | REC93310-32337 | 93310-32337 |
|  | REC6R5-11634-00 | 6R5-11634-10 | REC6R5-11634-00 | 6R5-11634-10 |
|  | 150F/FETO (1996-2007) 150TXR/TR (2002-05) 150AET (2001-02) 175D/DETO (1996-03) 200AET (2003) | | 200F/TLR/FETO (1996-10) 200G/GETOL (1996-02) L200F/FETO (1996-00) 225D/DET (1996-09) | |



| | |  | |  | |
|---------------------|---------|---|------------------|---|--|
| | | ESTRIBOR STD TRIBORDO DROIT | | BABOR PORT BABORDO GAUCHE | |
| L130B | 1997-98 | REC64D-11603-01 | REC6R5-11631-11K | REC6R5-11642-11K | |
| L130BETOX | 2000-01 | REC64D-11603-01 | REC6R5-11631-11K | REC6R5-11642-11K | |
| 140A | 1985-87 | REC6E5-11610-02 | REC6G5-11631-00K | REC6G5-11642-00K | |
| 150A | 1984-87 | REC6E5-11610-02 | REC6G5-11631-00K | REC6G5-11642-00K | |
| 150AET | 1998-00 | REC64D-11603-01 | REC64D-11631-00K | | |
| 150AETL/ AETX | 2001-02 | REC64D-11603-01 | REC64D-11642-00K | | |
| 150C | 1992 | REC61U-11601-00 | REC6R5-11631-01K | REC6R5-11642-01K | |
| 150C | 1993-05 | REC6R5-11603-00 | REC6R5-11631-11K | REC6R5-11642-11K | |
| 150F | 1996-01 | REC64D-11603-01 | REC6G5-11631-00K | REC6G5-11642-00K | |
| 150FETO | 1998-00 | REC64D-11603-01 | REC64D-11631-00K | REC64D-11642-00K | |
| 150FETOL | 2001-04 | REC64D-11603-01 | REC64D-11631-00K | REC64D-11642-00K | |
| 150FETOX | 2001-05 | REC64D-11603-01 | REC64D-11631-00K | REC64D-11642-00K | |
| D150H | 1999-02 | REC64D-11603-01 | REC64D-11631-00K | REC64D-11642-00K | |
| L150C | 1992 | REC61U-11601-00 | REC6R5-11631-01K | REC6R5-11642-01K | |
| L 150C | 1993-95 | REC6R5-11603-00 | REC6R5-11631-11K | REC6R5-11642-11K | |
| L150F | 1996-98 | REC64D-11603-01 | REC6G5-11631-00K | REC6G5-11642-00K | |
| L150FETO | 2000 | REC64D-11603-01 | REC64D-11631-00K | REC64D-11642-00K | |
| L150FETOL/ FETOX | 2001 | REC64D-11603-01 | REC64D-11642-00K | REC64D-11642-00K | |
| 175A | 1984-87 | REC6E5-11610-02 | REC6G5-11631-00K | REC6G5-11642-00K | |
| 175B | 1992 | REC61U-11601-00 | REC6R5-11631-01K | REC6R5-11642-01K | |
| 175BETO/ CETO | 1993-95 | REC6R5-11603-00 | REC6R5-11631-11K | REC6R5-11642-11K | |
| 175D | 1996-98 | REC64D-11603-01 | REC6G5-11631-00K | REC6G5-11642-00K | |
| 175DETO | 1996-00 | REC64D-11603-01 | REC64D-11631-00K | | |
| 175DETOX | 2001-03 | REC64D-11603-01 | REC64D-11642-00K | | |
| 175DETOX | 2001-02 | REC64D-11603-01 | REC64D-11642-00K | | |
| 200A | 1984-87 | REC6E5-11610-02 | REC6G5-11631-00K | REC6G5-11642-00K | |
| 200B | 1992 | REC64D-11603-01 | REC6R5-11631-01K | REC6R5-11642-01K | |
| 200B | 1993-95 | REC6R5-11603-00 | REC6R5-11631-11K | REC6R5-11642-11K | |
| 200F | 1996-98 | REC64D-11603-01 | REC6G5-11631-00K | REC6G5-11642-00K | |
| 200FETO | 2000 | REC64D-11603-01 | REC64D-11631-00K | REC64D-11642-00K | |
| 200FETOL/F | 2001-04 | REC64D-11603-01 | REC64D-11631-00K | REC64D-11642-00K | |

| | |  | |  | |
|-------------|---------|---|------------------|---|--|
| | | ESTRIBOR STD TRIBORDO DROIT | | BABOR PORT BABORDO GAUCHE | |
| 200G | 1999 | REC64D-11603-01 | REC64D-11631-00K | REC64D-11642-00K | |
| 200GETO | 2000 | REC64D-11603-01 | REC64D-11631-00K | REC64D-11642-00K | |
| 200GETOL | 2001-03 | REC64D-11603-01 | REC64D-11631-00K | REC64D-11642-00K | |
| L200B | 1992 | REC6R5-11603-00 | REC6R5-11631-01K | REC6R5-11642-01K | |
| L 200B | 1993-95 | REC6R5-11603-00 | REC6R5-11631-11K | REC6R5-11642-11K | |
| L200F | 1996-01 | REC64D-11603-01 | REC6G5-11631-00K | REC6G5-11642-00K | |
| L200FETO | 1996-00 | REC64D-11603-01 | REC64D-11631-00K | REC64D-11642-00K | |
| 200FETOL | 2001-04 | REC64D-11603-01 | REC64D-11631-00K | REC64D-11642-00K | |
| 220A, ET, O | 1985-87 | REC6E5-11610-02 | | | |
| 225B | 1993-95 | REC6R5-11603-00 | REC6R5-11631-11K | REC6R5-11642-11K | |
| 225D | 1996-01 | REC64D-11603-01 | REC6G5-11631-00K | REC6G5-11642-00K | |
| 225DETO | 1996-00 | REC64D-11603-01 | REC64D-11631-00K | REC64D-11642-00K | |
| 225G | 1999 | REC64D-11603-01 | REC64D-11631-00K | REC64D-11642-00K | |
| 225GETO | 1999-00 | REC64D-11603-01 | REC64D-11631-00K | REC64D-11642-00K | |
| 225GETOL | 2001-03 | REC64D-11603-01 | REC64D-11631-00K | REC64D-11642-00K | |
| L225C | 1994-95 | REC6R5-11603-00 | REC6R5-11631-00K | REC6R5-11642-00K | |
| 250A | 1993-95 | REC6R5-11603-00 | REC6R5-11631-00K | REC6R5-11642-00K | |
| 250AETO | 2000 | REC64D-11603-01 | REC69L-11631-00K | REC69L-11642-00K | |
| 250AETOX | 2001-04 | REC64D-11603-01 | REC69L-11631-00K | REC69L-11642-00K | |
| 250B | 1997-98 | REC64D-11603-01 | REC69L-11631-00K | REC69L-11642-00K | |
| 250BETO | 2000 | REC64D-11603-01 | REC69L-11631-00K | REC69L-11642-00K | |
| 250BETOX | 2001 | REC64D-11603-01 | REC69L-11631-00K | REC69L-11642-00K | |
| L250AETO | 2000-05 | REC64D-11603-01 | REC69L-11631-00K | REC69L-11642-00K | |
| L250AETOX | 2001-06 | REC64D-11603-01 | REC69L-11631-00K | REC69L-11642-00K | |
| L250B | 1997-02 | REC64D-11603-01 | REC69L-11631-00K | REC69L-11642-00K | |
| L250BETO | 2000-03 | REC64D-11603-01 | REC69L-11631-00K | REC69L-11642-00K | |
| L250BETOX | 2001-03 | REC64D-11603-01 | REC69L-11631-00K | REC69L-11642-00K | |
| L250GETOX | 2006-10 | REC64D-11603-01 | REC69L-11631-00K | REC69L-11642-00K | |
| L250 A | 1997-98 | REC64D-11603-01 | REC69L-11631-00K | REC69L-11642-00K | |





GUÍA CORREAS DE DISTRIBUCIÓN

GUIDE TIMING BELT

GUIDA CINGHIE DISTRIBUZIONE

GUIDE DES COURROIES DE DISTRIBUTION

|  | |  | REF | OEM |
|---|---------|--|-----------------|--------------|
| F6A-04/ F6A-05/ F8C-04/ F8C-05/ FT8D-04/ FT8D-05/ F9.9F/ F9.9J/ FT9.9G/ FT9.9L | 2000+ | 60 | REC68T-46241-00 | 68T-46241-00 |
| F8B/ FT9.9A/ F9.9B | 1985-06 | 64 | REC6G8-46241-00 | 6G8-46241-00 |
| F9.9C/ FT9.9D/ F15A | 1998-08 | 68 | REC66M-46241-00 | 66M-46241-00 |
| F15C/ F20B | 2007+ | 80 | PAF20-05000003 | 6AH-46241-00 |
| F20A/ F25A/ FT25B/ F30A/ F40B/ F45A | 1998-09 | 80 | REC65W-46241-00 | 65W-46241-00 |
| F40A/ F50A/ FT50B/ FT50C/ F60A/ FT60B | 1995+ | 106 | REC62Y-46241-00 | 62Y-46241-00 |
| F25D/ FT25F/ F30B/ F40F/ F50F/ FT50G/ FT50J/ F50H/ F60C/ F60F/ FT60D/ FT60G/ F70A | 2005+ | 94 | REC6C5-46241-00 | 6C5-46241-00 |
| F80A/ F80B/ F100A/ F100B/ F100D/ F100F(L)/ F115A | 1999+ | 135 | REC67F-46241-00 | 67F-46241-00 |
| F(L) 150A | 2004+ | 147 | REC63P-46241-00 | 63P-46241-00 |
| F(L) 200A/ F(L) 225A | 2002-11 | 159 | REC69J-46241-00 | 69J-46241-00 |
| F(L) 200C/ F(L) 225B/ F225C/ F(L) 250A/ F(L) 250B | 2005+ | 225 | REC6P2-46241-02 | 6P2-46241-02 |

SISTEMA DE ESCAPE Y ADMISIÓN EXHAUST & INTAKE SYSTEM

SISTEMA DI SCARICO E ASPIRAZIONE SYSTEME D'ÉCHAPPEMENT ET D'ADMISSION

SISTEMA DE ESCAPE

EXHAUST SYSTEM

SISTEMA SCARICO

SYSTÈME D'ÉCHAPPEMENT

JUNTAS DEL SISTEMA DE ESCAPE

EXHAUST GASKETS

GUARNIZIONE SCARICO

JOINTS D'ÉCHAPPEMENT

| REF | OEM |
|---|---|
| REC6G1-41133-A0 | 6G1-41133-A0 |
|  | 6C/CEM/D/DEM/TRV/MSH/MHS/CWH/DMH/J 8CEM/C/TRV/MSH/MH/CMH/J/N |



| REF | OEM |
|---|---------------|
| PAF25-05080004 | 65W-14457-10 |
|  | F20/25 T25 |



| REF | OEM |
|---|----------------------|
| PAF15-04010004 | 66M-41138-00 |
|  | F9.9/15/13.5 T9.9 |



| REF | OEM |
|---|------------------------|
| REC62Y-45127-00 | 62Y-45127-00 |
|  | F20/25/40/45/50 T50 |



| REF | OEM |
|---|----------------------|
| PAF15-03000003 | 66M-45115-00 |
|  | F9.9/13.5/15 T9.9 |



| REF | OEM |
|---|------------------------|
| REC62Y-41133-00 | 62Y-41133-00 |
|  | F20/25/40/45/50 T50 |



| REF | OEM |
|---|----------------------------------|
| REC682-41133-A0 | 682-41133-A0 |
|  | 9.9D E9.9DMH 15D E15DMH |



| REF | OEM |
|---|------------------------|
| REC67C-41133-00 | 67C-41133-00 |
|  | F20/25/40/50/30 T25 |



| REF | OEM |
|---|-----------------------------------|
| REC63V-41133-A1 | 63V-41133-A1 |
|  | 9.9F/FEM/FMH/MH/AW/MSH 13.5AWH |

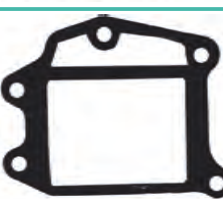

| REF | OEM |
|---|------------------------|
| REC67C-45123-00 | 67C-45123-00 |
|  | F20/25/40/50/30 T25 |



| REF | OEM |
|---|---|
| REC6L2-41133-A3 | 6L2-41133-A3 |
|  | 20D/DEM/DEO/MLH/DMH 25NE/NW/MLH/N/MSH/MH/MLH |



| REF | OEM | |
|---|--------------------------------------|---------------------|
| REC663-45123-00 | 663-45123-00 | |
|  | 25QE0 40H/N F40/45/50 50ETN | T50 55B E55CM |



| REF | OEM |
|---|---|
| REC6L2-41134-00 | 6L2-41134-00 |
|  | 20D/DEM/DEO/MLH/DMH 25NE/NW/MLH/N/MSH/MH/MLH |



| REF | OEM |
|---|------------------------------------|
| REC664-41134-A0 | 664-41134-A0 |
|  | 20C/CM/A/G/GE E25A/25VE/VM/DE/D |

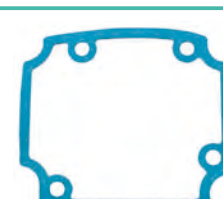

YAMAHA

RECAMBIOS MARINOS

| REF | OEM |
|-----------------|--------------|
| REC63D-45123-00 | 63D-45123-00 |

 25AE0/50H/40V/YE
C40M/40TLR/50DE





| REF | OEM |
|-----------------|--------------|
| REC688-41134-00 | 688-41134-A0 |

 75A/AE/AED/CETO/TLR
80A/AEO
85A/AED-T
90A/AET/AEO





| REF | OEM |
|-----------------|--------------|
| REC6H3-45127-00 | 6H3-45127-00 |

 25B/BETO
50G/GEO/GETO
60FE/FET/FE0/FETO/FEDO
E60H/MHZ/MLH/HMH/HW





| REF | OEM |
|-----------------|--------------|
| REC688-45123-00 | 688-45123-00 |

 75CETO/TLR
E75B/AED
80A/AE/TLR
85A/AE
90A/AE/TLR/TR





| REF | OEM |
|-----------------|--------------|
| REC6H3-45123-00 | 6H3-45123-00 |

 25B/BETO
50G/GEO/GETO
60FE/FET/FE0/FETO/FEDO
E60H/MHZ/MLH/HMH/HW
70B/ETN/
BEH/BE0/BEMO/BETO/CE





| REF | OEM |
|-----------------|--------------|
| REC67F-41138-00 | 67F-41138-00 |

 F80/100/115



| REF | OEM |
|-----------------|--------------|
| REC6H4-41134-A0 | 6H4-41134-A0 |

 25QEO/50H/40V/YE
C40M/40TLR/50DE





| REF | OEM |
|-----------------|--------------|
| REC67F-45127-00 | 67F-45127-00 |

 F80/100/115



| REF | OEM |
|-----------------|--------------|
| REC66T-41133-A1 | 66T-41133-A0 |

 40X/XW/XMH
E40X/MLN



| REF | OEM |
|-----------------|--------------|
| REC67F-45123-00 | 67F-45123-00 |

 F75/80/100



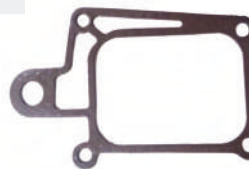

| REF | OEM |
|-----------------|--------------|
| REC676-41133-A0 | 676-41133-A0 |

 40QE/QE-Z/QM/QWC





| REF | OEM |
|-----------------|--------------|
| REC67F-41134-A0 | 67F-41134-A0 |

 F80/100/115





| REF | OEM |
|-----------------|--------------|
| REC676-45128-00 | 676-45128-00 |

 40QE/QE-Z/QM/QWC





| REF | OEM |
|-----------------|--------------|
| REC68V-45123-00 | 68V-45123-00 |

 F80/100/115





| REF | OEM |
|-----------------|--------------|
| REC676-45127-00 | 676-45127-00 |

 40QE/QE-Z/QM/QWC



| REF | OEM |
|-----------------|--------------|
| REC6E5-41135-A0 | 6E5-41135-A0 |

 100A/AET/TLR
115B/BETO/CEO/CETO/TXR
130BETO



| REF | OEM |
|-----------------|--------------|
| REC6E5-41134-A0 | 6E5-41134-A0 |

 100A/AET/TLR
 115B/BETO/CEO/CETO/TXR, 130BETO



| REF | OEM |
|-----------------|--------------|
| REC6S1-41136-00 | 6S1-41136-00 |

 F200/225/250

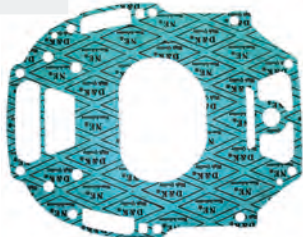

| REF | OEM |
|-----------------|--------------|
| REC6G5-41134-A1 | 6G5-41134-A1 |

 130BETO
 150FETO/PETO/TR
 175DETO/GETO/TR
 Z200
 200AET/ FETO/NETO/TXR
 225DET





| REF | OEM |
|-----------------|--------------|
| REC6AW-41134-01 | 6AW-41134-00 |

 FL/F300-350 (2008+)



| REF | OEM |
|-----------------|--------------|
| REC69J-41138-00 | 69J-41138-00 |

 F200/225/250



| REF | OEM |
|-----------------|----------------------|
| REC6A1-14613-A0 | 6A1-14613-A0, 00, 01 |

 2B/C/M (1985-10)
 2T/strokes

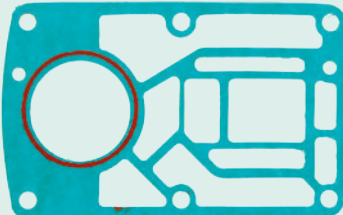

new

| REF | OEM |
|-----------------|--------------|
| REC69J-45123-00 | 69J-45123-00 |

 F200/225/250



| REF | OEM |
|-----------------|--------------|
| REC69J-41135-A0 | 69J-41135-A0 |

 F200/225/250

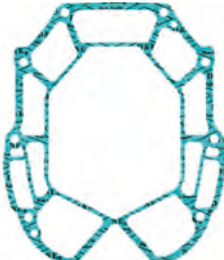

| REF | OEM |
|----------------|-------------|
| REC93101-13M27 | 93101-13M27 |

 E9.9/E15
 F9.9/F15 (modelos antiguos | old models | modello vecchio | anciens)



new

| REF | OEM |
|-----------------|--------------|
| REC69J-41134-A0 | 69J-41134-A0 |

 F200/225

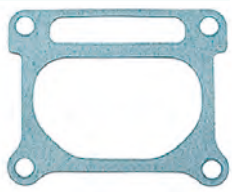

JUNTAS DE COLECTOR Y CARTER

GASKET, UPPERCASING, OIL PAN, MANIFOLD

GUARNIZIONI COLLETTORE E CARTER

JOINTS DE COLLECTEUR ET CARTER D'HUILE

| REF | OEM |
|-----------------|--------------|
| REC646-14623-A1 | 646-14623-A1 |

 2B

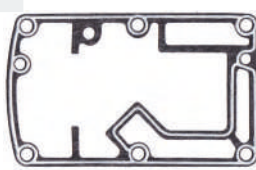

| REF | OEM |
|---------------|--------------|
| PAF4-04000002 | 68D-11351-A0 |

 F4





| REF | OEM |
|-----------------|--------------|
| PAF2.6-04000004 | 69M-11351-A0 |

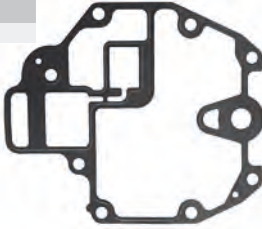

 F2.5

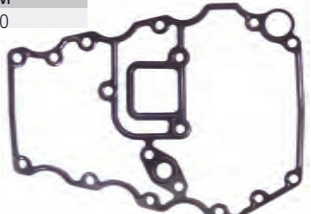



| REF | OEM |
|--|---|
| REC68T-13475-00 | 68T-13475-00 |
|  F6/8/9.9 T8/9.9 |  |



| REF | OEM |
|--|---|
| REC67C-15312-00 | 67C-15312-00 |
|  F25/30/40 T25 |  |

| REF | OEM |
|--|---|
| REC6G8-45113-A1 | 6G8-45113-A1 |
|  F8/9.9 T9.9 |  |



| REF | OEM |
|--|---|
| REC67C-45113-00 | 67C-45113-00 |
|  F25/30/40 T25 |  |



| REF | OEM |
|---|---|
| REC6AH-13329-00 | 6AH-13329-00 |
|  F9.9/13.5/15/20 |  |

| REF | OEM |
|---|--|
| REC6H3-45114-A1 | 6H3-45114-A1 |
|  25B/BETO 50G/GEO/GETO 60FEDO/TLR/BEO E60H/MLHMHM 70B/BEO 70BETO/TR |  |

| REF | OEM |
|---|---|
| REC682-45113-A0 | 682-45113-02 |
|  9.9D 15D |  |



| REF | OEM |
|--|---|
| PAF25-02010007 | 67C-15312-00 |
|  F25/30/40 T25 |  |

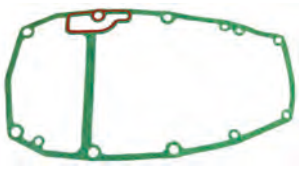

| REF | OEM |
|---|---|
| REC6AH-15312-00 | 6AH-15312-00 |
|  F9.9/13.5/15/20 |  |

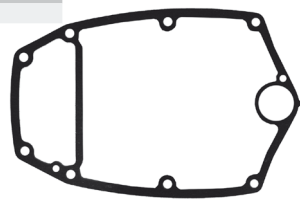
| REF | OEM |
|--|---|
| REC676-45114-A1 | 676-45114-A1 |
|  40QE/QE-Z/QM/QWC/GWH/JWH E40GMH/JMH |  |

| REF | OEM |
|---|---|
| PAF15-00000005 | 66M-45113-00 |
|  F15/9.9/13.5 FT9.9 |  |

| REF | OEM |
|--|---|
| REC66T-45114-A0 | 66T-45114-A0 |
|  40X/XMH/XW E40X/MLH/XMH |  |

| REF | OEM |
|--|---|
| REC62Y-15312-00 | 62Y-15312-00 |
|  F20/25/40/45/50 T50 |  |

| REF | OEM |
|---|---|
| REC697-45114-00 | 697-45114-A0 |
|  E48CMH 55BET/B/BE/BM E55CMH |  |

| REF | OEM |
|-----------------|--------------|
| REC63D-45114-A0 | 63D-45114-A0 |

 50H/HR/HM
 40V/VM/VETO/C40MLH
 C40T/TLR
 40YETO



| REF | OEM |
|-----------------|--------------|
| REC63P-15312-00 | 63P-15312-00 |

 F150/175/200



| REF | OEM |
|-----------------|--------------|
| REC688-45114-A1 | 688-45114-A1 |

 75A/AE/CETO/TLR/AED
 E75B
 85A/AED-M-T
 80A/AE/AEO
 90A/ETN/AEO/AETO

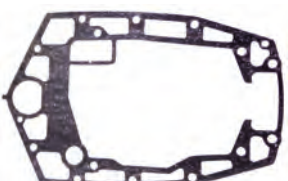

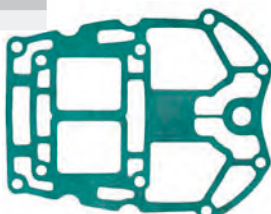

| REF | OEM |
|-----------------|--------------|
| REC61A-41134-A0 | 6D0-41134-00 |

 225C/FETO/G/GETO
 Z250
 250B/AET/BETO/TXR
 Z300/AETO/TR



| REF | OEM |
|-----------------|--------------|
| REC67F-45113-00 | 67F-45113-00 |

 F75/80/100/115



| REF | OEM |
|-----------------|--------------|
| REC6AW-45113-00 | 6AW-45113-00 |

 F300/350

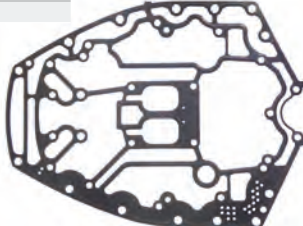

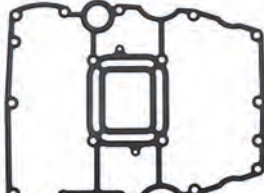

| REF | OEM |
|-----------------|--------------|
| REC68V-15312-00 | 68V-15312-00 |

 F80/100/115





| REF | OEM |
|-----------------|--------------|
| REC6AW-15312-00 | 6AW-15312-00 |

 FL/F300-350 (2008+)





| REF | OEM |
|-----------------|--------------|
| REC6G5-45114-A0 | 6G5-45114-A1 |

 115A/B/ETN/BETO
 130BETO
 140AETO/BETO
 150ETN/AETO/CETO/FETO
 Z150
 Z175
 175AETO
 200ETN/AET-0
 Z200
 225AETO/DET





| REF | OEM |
|-----------------|--------------|
| REC6AW-15451-00 | 6AW-15451-00 |

 FL/F300-350 (2008+)





| REF | OEM |
|-----------------|--------------|
| REC6E5-45114-00 | 6E5-45114-A0 |

 115A/ETN
 E115AEL
 140AETO



| REF | OEM |
|-----------------|--------------|
| REC6AW-14613-00 | 6AW-14613-00 |

 FL/F300-350 (2008-11)



| REF | OEM |
|-----------------|--------------|
| REC6AW-14623-00 | 6AW-14623-00 |

 FL/F300-350 (2008-11)



SISTEMA DE ADMISION

INTAKE SYSTEM

SISTEMA ASPIRAZIONE

SYSTEME D'ADMISSION

JUNTAS DEL SISTEMA DE ADMISION

GASKETS INTAKE

GUARNIZIONE SISTEMA ASPIRAZIONE

JOINTS D'ADMISSION

| REF | OEM |
|-----------------|--------------|
| REC69J-13645-00 | 69J-13645-A1 |

 F200/FL-LF200 (2002-11)
 F225/LF-FL225 (2002-11)



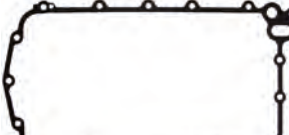

| REF | OEM |
|-----------------|--------------|
| REC69J-15451-00 | 69J-15451-A1 |

 F200/FL-LF200 (2002-11)
 F225/LF-FL225 (2002-11)





| REF | OEM |
|-----------------|--------------|
| REC6G1-13645-A1 | 6G1-13645-A1 |

 6D/DMH/CMH//MH/C/TRV
 8C/CMH/MH/MSH



| REF | OEM |
|-----------------|--------------|
| REC6G1-14198-A1 | 6G1-14198-A1 |

 6D/DMH/CMH//MH/C/TRV
 8C/CMH/MH/MSH



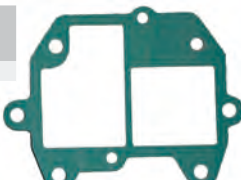

| REF | OEM |
|-----------------|--------------|
| REC6G1-13621-A1 | 6G1-13621-A1 |

 6D/DMH/CMH//MH/C/TRV
 8C/CMH/MH/MSH



| REF | OEM |
|-----------------|--------------|
| REC6G8-14198-A0 | 6G8-14198-00 |

 F8BE/BM/B
 F9.9B/BE/BM/A/AM





| REF | OEM |
|-----------------|--------------|
| REC6G8-13645-00 | 6G8-13645-00 |

 F8BE/BM/B
 F9.9B/BE/BM/A/AM





| REF | OEM |
|-----------------|--------------|
| REC6G8-13646-A0 | 6G8-13646-00 |

 F8BE/BM/B
 F9.9B/BE/BM/A/AM





| REF | OEM |
|-----------------|--------------|
| REC6G8-15374-00 | 6G8-15374-00 |

 F8BE/BM/B
 F9.9B/BE/BM/A/AM





| REF | OEM |
|-----------------|--------------|
| REC677-24434-02 | 677-24434-02 |

 E8D/DMH
 9.9D/15D
 25D/NH/NMH/MH/NE/NEMO
 20DMH/MLH/DW





| REF | OEM |
|-----------------|--------------|
| REC677-13621-00 | 677-13621-A1 |

 20CM/C
 25DE/BMH/B/D/V
 30A/HM/HW/G/GE
 E30HMH





| REF | OEM |
|-----------------|--------------|
| REC677-14198-A1 | 677-14198-A1 |

 20CM/C
 25DE/BMH/B/D/V
 30A/HM/HW/G/GE
 E30HMH



| REF | OEM |
|-----------------|--------------|
| REC682-13621-00 | 682-13621-A0 |

 9.9D
 15D





| REF | OEM |
|-----------------|--------------|
| REC648-13645-A0 | 648-13645-A0 |

 20CM/C
 25DE/BMH/B/D/V
 30A/HM/HW/G/GE, E30HMH



| REF | OEM |
|-----------------|--------------|
| REC648-13621-A0 | 648-13621-A1 |

 20CM/C
 25DE/BMH/B/D/V
 30A/HM/HW/G/GE
 E30HMH



| REF | OEM |
|-----------------|--------------|
| REC648-14198-A0 | 648-14198-A0 |

 20C/CM
 25D/DE
 30A





| REF | OEM |
|-----------------|--------------|
| REC6H4-14198-09 | 6H4-14198-00 |

 40N/H/E
 50D/ETN



| REF | OEM |
|-----------------|--------------|
| REC6H4-14198-01 | 6H4-14198-01 |

 25Q/QEO/B
 50D/G/GEO/GET/H
 40V/VM/TLR/H
 C40T/40YET
 60FEO/FET/D
 70B/BE



| REF | OEM |
|-----------------|--------------|
| REC676-13646-A0 | 676-13646-A0 |

 40QE/QM/QWC



| REF | OEM |
|-----------------|--------------|
| REC6L2-13621-00 | 6L2-13621-00 |

 25N/M 6L2-6L29, 6L2A - 6L2D
 (1988-13)

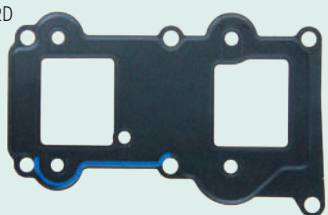



| REF | OEM |
|-----------------|--------------|
| REC688-14483-A0 | 688-14483-A0 |

 E40CMH
 55B/BE/BET
 E55CMH





| REF | OEM |
|-----------------|--------------|
| REC61N-14198-00 | 61N-14198-00 |

 25VE/VM/B/BMH/BWH
 E25A/BMH
 30G/GE/HMH/HW
 E30HMH





| REF | OEM |
|-----------------|--------------|
| REC688-14416-01 | 688-14416-01 |

 75AET/AEM/AED
 E75B
 85A/AE/AET/AED





| REF | OEM |
|-----------------|--------------|
| REC6H3-13621-A1 | 6H3-13621-A1 |

 25B
 50G/GEO/GETO,
 60FEO/FETO/TLR/TRZ/F
 E60H/E60M
 70BEO/B/BE/
 BEDO/BETO/TR





| REF | OEM |
|-----------------|--------------|
| REC688-13621-A1 | 688-13621-A1 |

 75AET/AEM/AED
 E75B
 85A/AE/AET/AED





| REF | OEM |
|-----------------|--------------|
| REC6H3-14198-A1 | 6H3-14198-A1 |

 25B
 50G/GEO/GETO
 60FEO/FETO/TLR/TRZ/F
 E60H/E60M
 70BEO/B/BE/
 BEDO/BETO/TR





| REF | OEM |
|-----------------|--------------|
| REC688-14198-A1 | 688-14198-A2 |

 Z150P/Q/TLR
 175G/GET
 200NETO/N/TR/PET
 250G/GET/B





| REF | OEM |
|-----------------|--------------|
| REC6H3-13622-A1 | 6H3-13622-A1 |

 25B
 50G/GEO/GETO
 60FEO/FETO/TLR/TRZ/F
 E60H/E60M
 70BEO/B/BE/BEDO/BETO/TR



| REF | OEM |
|-----------------|--------------|
| REC6F5-13645-A0 | 6F5-13645-A1 |

 40GWH/JWH
 E40GMH/JMH





| REF | OEM |
|-----------------|--------------|
| REC6F5-13646-A2 | 6F5-13646-A1 |

 40GWH/JWH
 E40GMH/JMH





| REF | OEM |
|-----------------|--------------|
| REC6F5-13621-A1 | 6F5-13621-A1 |

 40GWH/JWH
 E40GMH/JMH



| REF | OEM |
|-----------------|--------------|
| REC6E5-14198-A2 | 6E5-14198-A2 |

 100A/TLR
 115BE/B/CETO/TXR
 130BETO/TLR
 150F/FETO/TXR/TR/GETO/A/AETO
 175DETO/D/FETO
 225DET/D



| REF | OEM |
|-----------------|--------------|
| REC6F5-14198-A1 | 6F5-14198-A1 |

 40GWH/JWH
 E40GMH/JMH



| REF | OEM |
|-----------------|--------------|
| REC6E5-14416-A1 | 6E5-14416-A1 |

 115B/BE/BET
 C115TLR

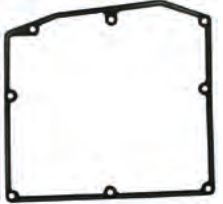



| REF | OEM |
|-----------------|--------------|
| REC6E9-14198-A0 | 6E9-14198-A0 |

 40QE/QM/QWC



| REF | OEM |
|-----------------|--------------|
| REC6E5-11381-A1 | 6E5-11381-A1 |

 115BET/CEO
 130BET
 150CET
 175BET
 200CETO
 225BET



| REF | OEM |
|-----------------|--------------|
| REC663-14483-A0 | 663-14483-A0 |

 E40CMH
 55B/BE/BET
 E55CMH



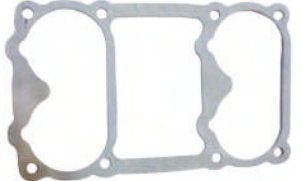

| REF | OEM |
|-----------------|--------------|
| REC6E5-14483-A1 | 6E5-14483-A1 |

 115B/BE/BET
 C115TLR





| REF | OEM |
|-----------------|--------------|
| REC663-14198-00 | 663-14198-A0 |

 E48CMHS
 55BET/B/BE/BM



| REF | OEM |
|-----------------|--------------|
| REC65L-13646-00 | 65L-13646-00 |

 150PETO/QETO/TXR
 175GETO
 200N/NETO/PET/TLR
 225G/GET





| REF | OEM |
|-----------------|--------------|
| REC663-13621-00 | 663-13621-A0 |

 E48CMHS
 55BET/B/BE/BM



| REF | OEM |
|-----------------|--------------|
| REC65L-13645-00 | 65L-13645-00 |

 150PETO/QETO/TXR
 175GETO
 200N/NETO/PET/TLR
 225G/GET



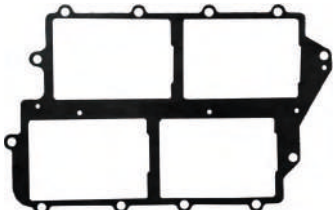

| REF | OEM |
|--------------------|--------------|
| REC6E5-13645-A1-00 | 6E5-13645-A1 |

 100A/TLR
 115BE/B/CETO/TXR
 130BETO/TLR
 150F/FETO/TXR/TR/GETO/A/AETO
 175DETO/D/FETO
 225DET/D



| REF | OEM |
|-----------------|--------------|
| REC6E5-13621-A1 | 6E5-13621-A1 |

 100A/TLR
 115BE/B/CETO/TXR
 130BETO/TLR
 150F/FETO/TXR/TR/GETO/A/AETO
 175DETO/D/FETO
 225DET/D



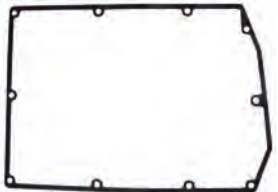

| REF | OEM |
|-----------------|--------------|
| REC6G5-14416-A1 | 6G5-14416-A1 |

 150A-AET





| REF | OEM |
|-----------------|--------------|
| REC6G5-14483-01 | 6G5-14483-A1 |

 150A/AETO
 175AE/AETO
 200AET/AETO



| REF | OEM |
|-----------------|--------------|
| REC61A-13646-00 | 61A-13646-00 |

 225C/CET
 250AET/B/A/ETD



| REF | OEM |
|-----------------|--------------|
| REC6G5-13645-A1 | 6G5-13645-A2 |

 150A/AETO
 175AE/AETO
 200AET/AETO

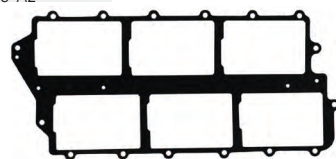

| REF | OEM |
|-----------------|--------------|
| REC68F-11381-00 | 68F-11381-00 |

 Z150
 VZ150
 LZ150
 Z175
 VZ175

Z200
VZ200
LZ200



| REF | OEM |
|-----------------|--------------|
| REC64E-13645-A0 | 64E-13645-A0 |

 150GETO
 D150H 175DET
 200GETO/G
 225D/DET



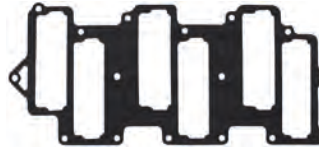

| REF | OEM |
|-----------------|--------------|
| REC6K7-13645-A2 | 6K7-13645-A2 |

 200CETO
 225BET



| REF | OEM |
|-----------------|--------------|
| REC61A-13621-A0 | 61A-13621-A0 |

 Z150P/Q/TLR
 175G/GET
 200NETO/N/TR/PET
 250G/GET/B



| REF | OEM |
|-----------------|--------------|
| REC6K7-13646-A2 | 6K7-13646-A2 |

 200CETO
 225BET

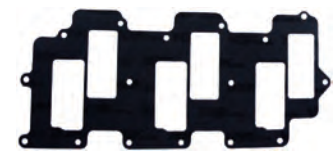

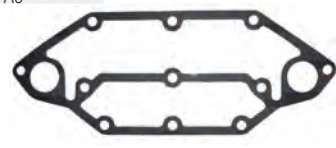

| REF | OEM |
|-----------------|--------------|
| REC61A-11381-A0 | 61A-11381-A0 |

 225C/CET/FET/G/GET
 250AET/B





| REF | OEM |
|-----------------|--------------|
| REC60V-13621-A0 | 60V-13621-A0 |

 Z300AETO/TR
 Z250DETO/TR/FETO
 LZ250 (2003-07)
 LZ300 (2004-07)
 VZ200 (2005-09)
 VZ225 (2003-09)
 VZ300 (2004-09)
 VZ250 (2003-07)
 Z300 (2004-07)



| REF | OEM |
|-----------------|--------------|
| REC61A-13645-00 | 61A-13645-00 |

 225C/CET
 250AET/B/A/ETD



| REF | OEM |
|-----------------|--------------|
| REC60V-13645-00 | 60V-13645-00 |

 Z300AETO/TR
 Z250DETO/TR/FETO
 LZ250 (2003-07)
 LZ300 (2004-07)
 VZ200 (2005-09)
 VZ225 (2003-09)
 VZ300 (2004-09)
 VZ250 (2003-07)
 Z300 (2004-07)

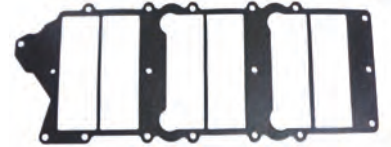

UNIDADES DE TRANSMISIÓN UNIT DRIVES & COMPONENTS

UNITÀ DI TRASMISSIONE EMBASES ET PIECES

COLA COMPLETA

COMPLETE GEARCASE ASSY

PIEDI COMPLETI

EMBASE COMPLETE

4T
STROKES

COLAS DE 4 TIEMPOS

4 STROKES GEARCASE

PIEDI 4 TEMPI

EMBASES DE MOTEUR 4T

| REF | OEM | | REDUCCIÓN GEAR RATIO RIDUZIONE REDUCTION |
|------------------|-----------------|-----|---|
| PAF2.6-03020000S | 69M-65300-01-4D | 17" | 2.08 |
| PAF2.6-03020000L | 69M-65300-11-4D | 22" | 2.08 |

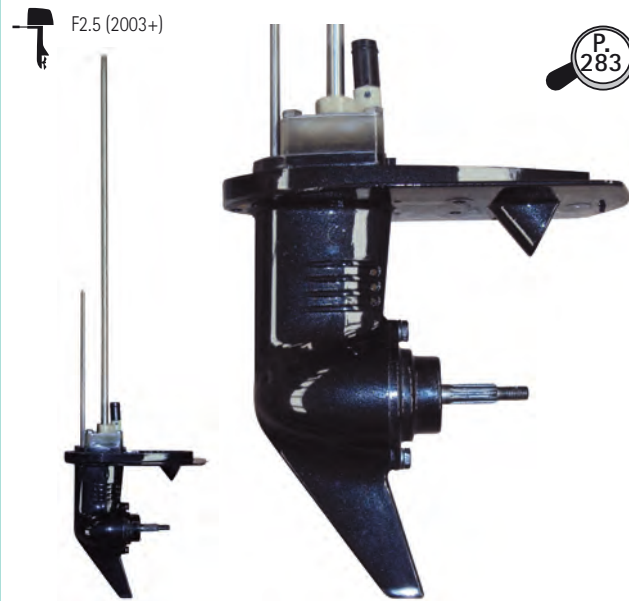

| REF | OEM | | REDUCCIÓN GEAR RATIO RIDUZIONE REDUCTION |
|-----------------|-----------------|-------|---|
| PAF15-06100000S | 66M-45300-02-4D | 17.3" | 2.08 |
| PAF15-06100000L | 66M-45300-11-4D | 22.3" | 2.08 |

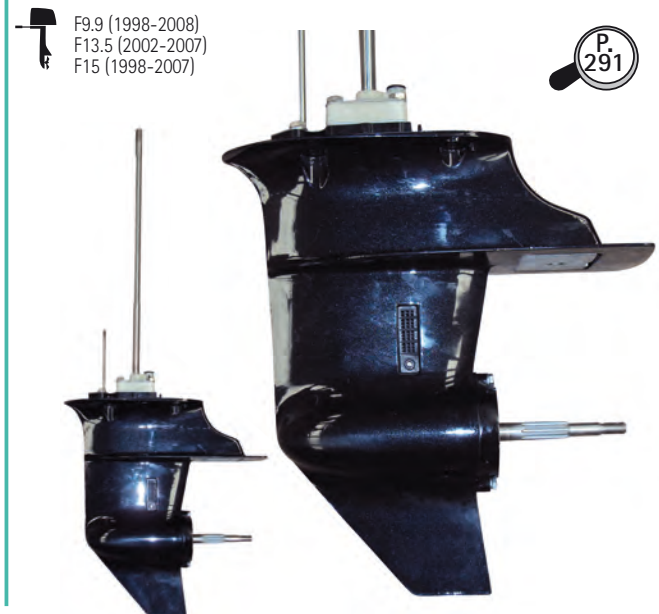

| REF | OEM | | REDUCCIÓN GEAR RATIO RIDUZIONE REDUCTION |
|---------------|-----------------|-------|---|
| PAF4-0310000S | 68D-65300-03-4D | 17.1" | 2.08 |
| PAF4-0310000L | 68D-65300-11-4D | 22.1" | 2.08 |

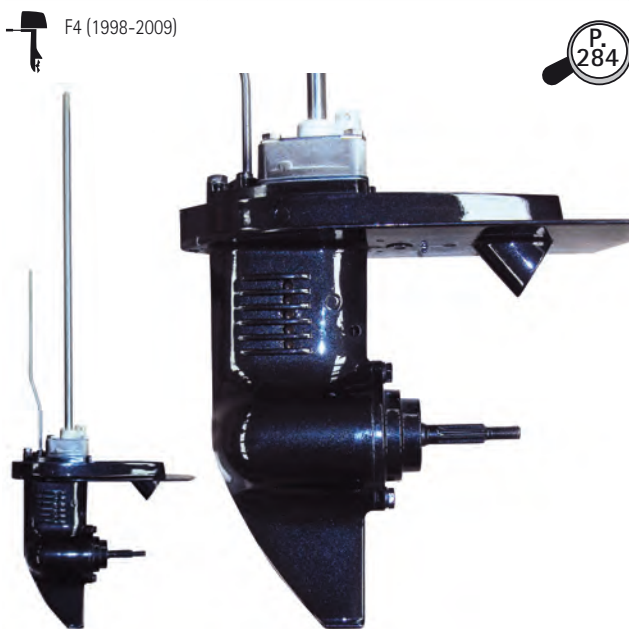

| REF | OEM | | REDUCCIÓN GEAR RATIO RIDUZIONE REDUCTION |
|-----------------|------------------------------------|-------|---|
| PAF20-04000000S | 6AH-45300-00-4D 6AH-45300-00-8D | 17.1" | 2.08 |
| PAF20-04000000L | 6AH-45300-10-4D 6AH-45300-10-8D | 22.1" | 2.08 |

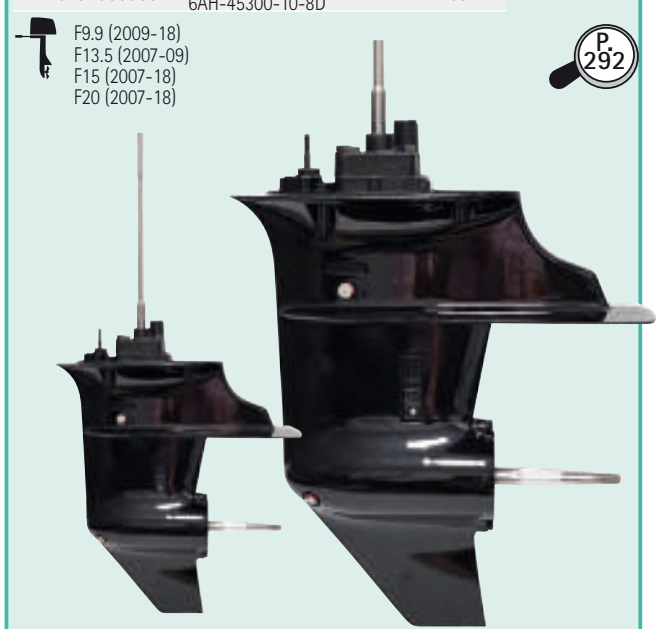

YAMAHA

RECAMBIOS
MARINOS

| REF | OEM | | REDUCCIÓN GEAR RATIO RIDUZIONE REDUCTION |
|-----------------|-----------------|-------|---|
| PAF25-04090000S | 65W-45300-01-4D | 16.6" | 2.08 |
| PAF25-04090000L | 65W-45300-01-4D | 21.6" | 2.08 |

F20 (1998-2003)
F25 (1998+)

P. 294

new

| REF | OEM | | REDUCCIÓN GEAR RATIO RIDUZIONE REDUCTION |
|----------------|---|-----|---|
| PAF60-04000000 | 69W-45300-00-4D 69W-45300-00-8D 69W-45300-01-8D | 20" | 1.85 |

F40D/H (2006+)
F50F/H/T (2005+)
F60A/B/C/T (2002+)

P. 310

| STD | CONTRAROTACIÓN COUNTERROTATION CONTROROTANTE CONTRE ROTATION | OEM | | REDUCCIÓN GEAR RATIO RIDUZIONE REDUCTION |
|-------------|---|-----------------|------------|---|
| REC416-B20F | | 63P-45300-00-8D | 20" V6 90° | 2.0:1 |
| REC416-B25F | | 63P-45300-10-8D | 25" V6 90° | 2.0:1 |
| | REC418-B25F | 64P-45300-10-8D | 25" V6 90° | 2.0:1 |

20" --> F150HP
25" --> LF150 HP
V6

P. 326

P. 326

DUAL WATER PICKUP

| STD | CONTRAROTACIÓN COUNTERROTATION CONTROROTANTE CONTRE ROTATION | OEM | | REDUCCIÓN GEAR RATIO RIDUZIONE REDUCTION |
|-------------|---|---|-----|---|
| REC422-B25F | | 6P2-45300-20-8D 6P2-45300-21-8D 6P2-45300-40-8D 6P2-45300-41-8D 6P3-45300-40-8D | 25" | 2.00:1 |
| | REC429-B25F | 6P3-45300-41-8D 6P3-45300-42-8D | 25" | 2.00:1 |

F200
F250

P. 336

new

P. 336

| STD | CONTRAROTACIÓN COUNTERROTATION CONTROROTANTE CONTRE ROTATION | OEM | | REDUCCIÓN GEAR RATIO RIDUZIONE REDUCTION |
|-------------|---|-----------------|------------|---|
| REC421-B25F | | 69J-45300-21-8D | 25" V6 76° | 2.0:1 |
| REC421-B30F | | 69J-45300-32-8D | 30" V6 76° | 2.0:1 |
| | REC428-B25F | 69K-45300-21-8D | 25" V6 90° | 2.0:1 |
| | REC428-B30F | 69K-45300-34-8D | 30" V6 | 2.0:1 |

P. 330

F200 HP
F225 HP

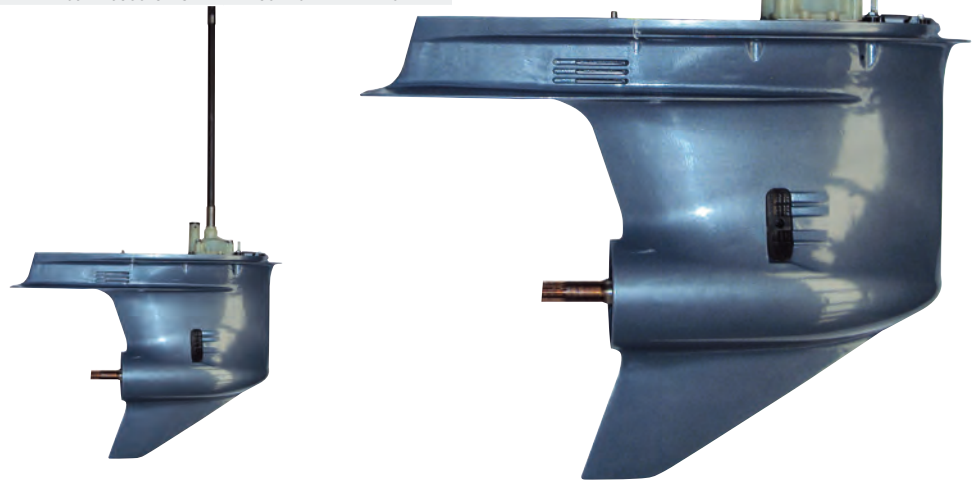

2T
STROKES

COLAS DE 2 TIEMPOS 2 STROKES GEARCASE PIEDI 2 TEMPI EMBASES DE MOTEUR 2 TEMPS

| REF | OEM | | REDUCCIÓN GEAR RATIO RIDUZIONE REDUCTION |
|--------------------|-----------------|---------|---|
| REC63V-45300-13-8D | 63V-45300-13-8D | | |
| | 63V-45300-13-4D | L 22.3" | 2.08 |
| | 63V-45300-10-4D | | |
| REC63V-45300-03-8D | 63V-45300-03-8D | | |
| | 63V-45300-03-4D | S 17.3" | 2.08 |
| | 63V-45300-00-4D | | |

9.9 /15 HP (63V Et 63W) (1995+)
13.5 HP (66S)

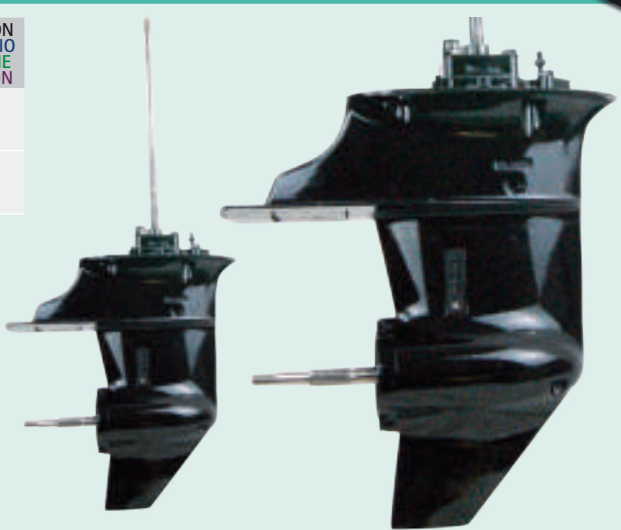

new

P. 350

| REF | OEM | | REDUCCIÓN GEAR RATIO RIDUZIONE REDUCTION |
|-----------------|------------------------------------|-----|---|
| PAF40-04000000L | 66T-45300-10-4D 66T-45311-13-8D | 20" | 2.08 |

(E)40X/M (1998-09)

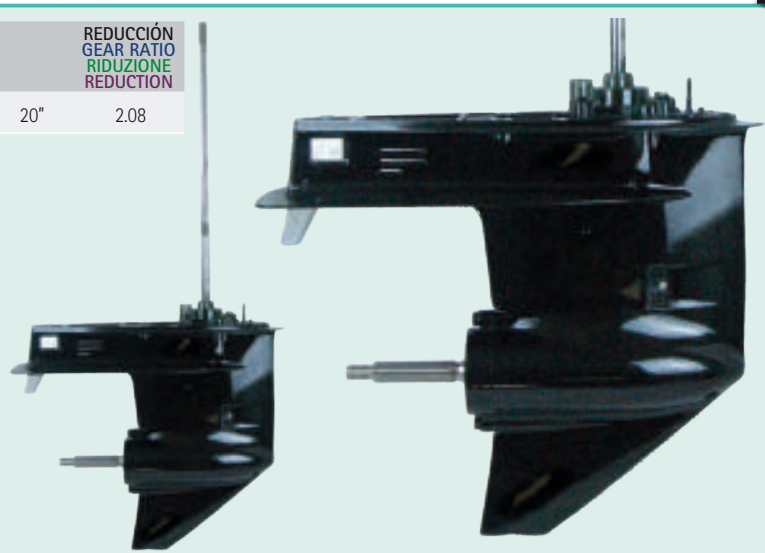

new

P. 360

YAMAHA

RECAMBIOS
MARINOS

| REF | OEM | |
|--------------------|-----------------|---|
| REC692-45300-16-8D | 692-45300-16-8D | L |
| | 692-45300-14-4D | |
| | 692-45300-13-4D | |
| | 692-45300-12-4D | |

 75A (692) (1995-09)
 85A (688) (1995-09)

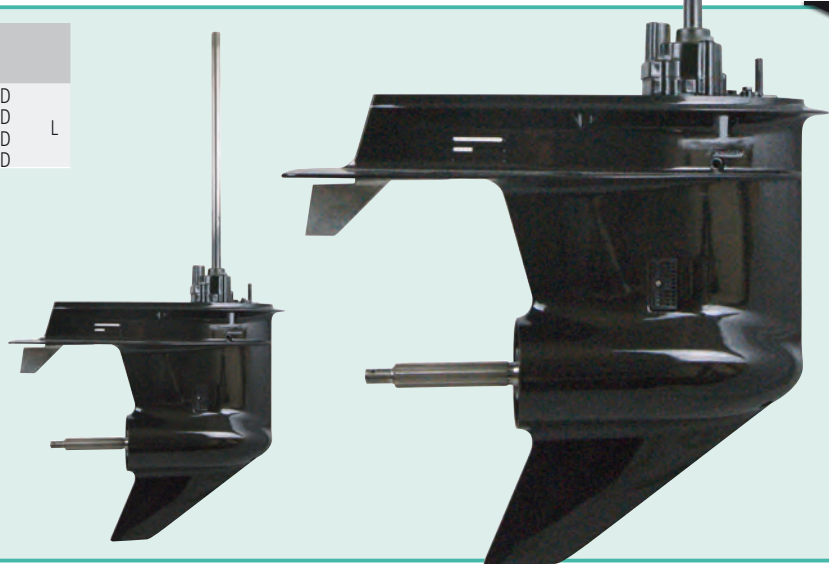

P.370

| STD | OEM | | REDUCCIÓN GEAR RATIO RIDUZIONE REDUCTION |
|------------|-----------------|--------|---|
| REC405-A20 | 6E5-45300-17-8D | 20° V4 | 2.0:1 |
| REC405-A25 | 6E5-45300-27-8D | 25° V4 | 2.0:1 |

 115HP (1984+)
 130HP (1987+)

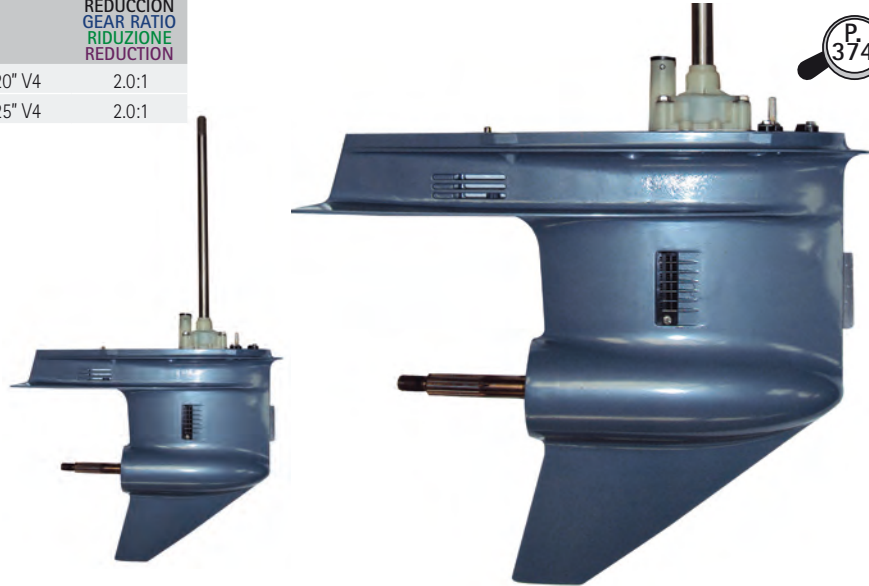

P.374

| STD | CONTRAROTACIÓN COUNTERROTATION CONTROROTANTE CONTRE ROTATION | OEM | | REDUCCIÓN GEAR RATIO RIDUZIONE REDUCTION |
|------------|---|-----------------|-----------------|---|
| REC416-A20 | | 64D-45300-01-8D | 20° V6 90° 2.6L | 1.86:1 |
| REC416-A25 | | 64D-45300-21-8D | 25° V6 90° 2.6L | 1.86:1 |
| | REC418-A25 | 64P-45300-10-8D | 25° V6 90° 2.6L | 1.86:1 |

 150HP (1984+)
 175HP (1984+)
 200HP (1984+)
 225HP (1990+)

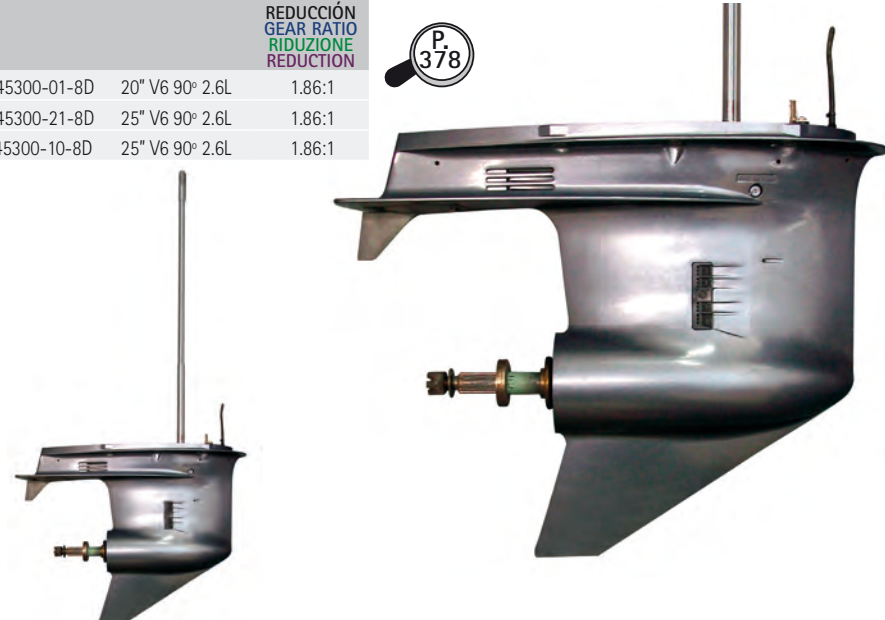

P.378

| STD | OEM | | REDUCCIÓN GEAR RATIO RIDUZIONE REDUCTION |
|------------|-----------------|-----------------|---|
| REC416-B20 | 64K-45300-02-NA | 20" V6 90° 2.6L | 2.0:1 |

 150HP (1987+)
 175HP (1989+)
 200HP (1989+)
 225HP (1992+)

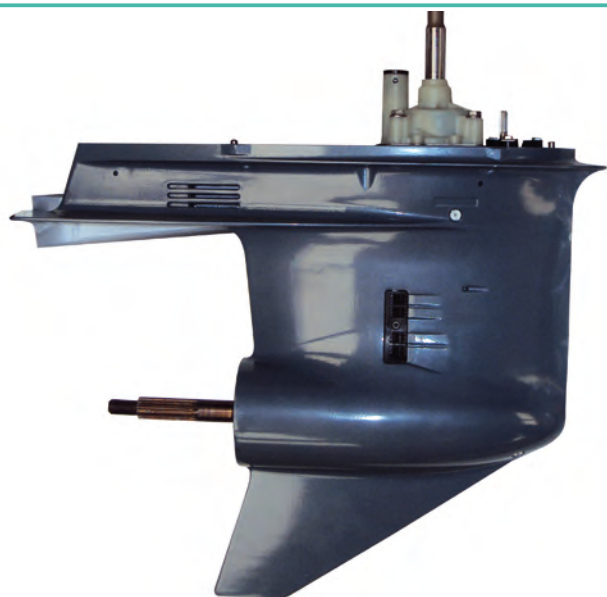

| STD | CONTRAROTACIÓN COUNTERROTATION CONTROROTANTE CONTRE ROTATION | OEM | | REDUCCIÓN GEAR RATIO RIDUZIONE REDUCTION | |
|------------|---|-----------------|-------------------------|---|------|
| REC421-A20 | | 66K-45300-12-NA | 20" V6 76° 3.1L / 3.2 L | 1.81 | |
| REC421-A25 | | 60V-45300-20-8D | 25" V6 76° | 1.81 | |
| | | REC428-A25 | 60W-45300-20-8D | 25" V6 90° 3.1L / 3.2 L | 1.81 |

 V6
 250D / DETO / DETOX / TR / TXR

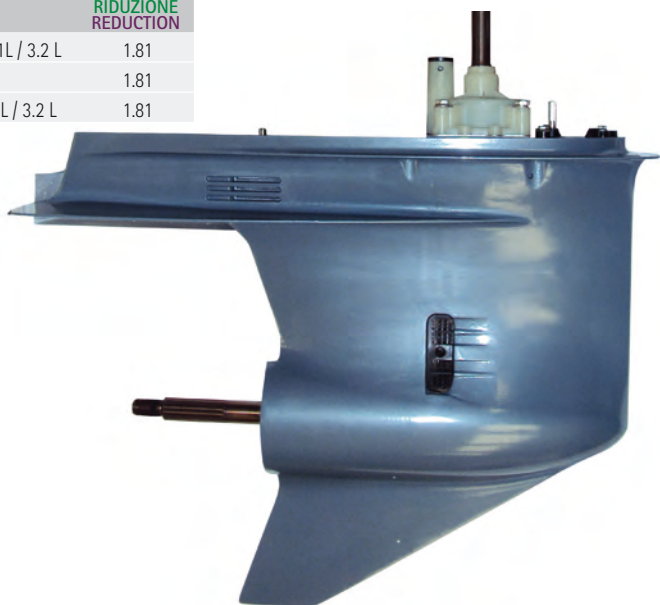

DESPIECE COLAS
4 TIEMPOS

GEAR CASE PARTS
4 STROKES

PARTI PIEDI
DE 4 TEMPI

PIECES D'EMBASES
DE 4 TEMPS

4T F2.5 (2003+)
STROKES

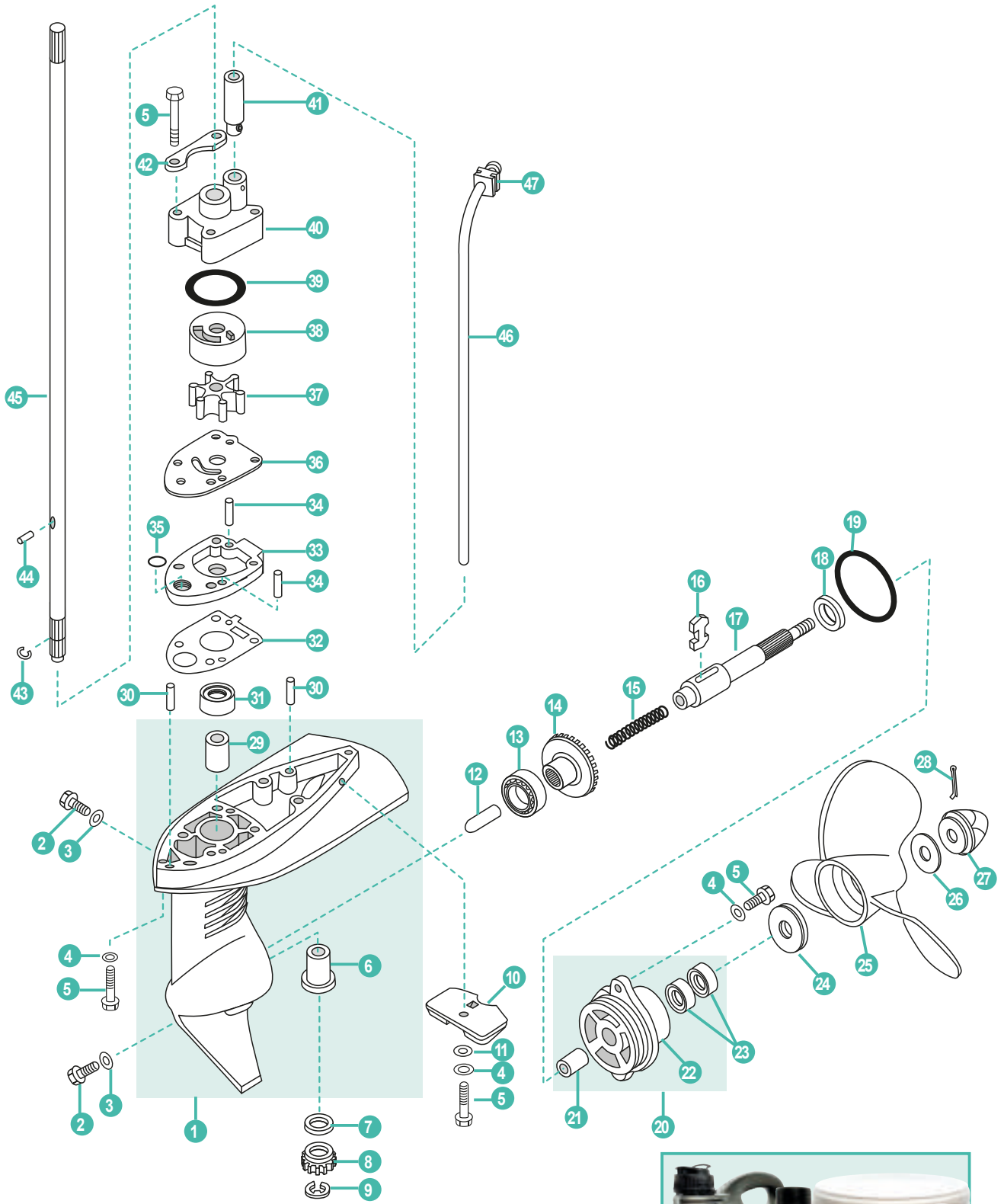

YAMAHA

RECAMBIOS
MARINOS

| | REF | OEM | | | | |
|----|-------------------|-----------------|-----------------------|--------------------------|------------------------------|-------------------------------|
| | PAF2.6-03020000L | 69M-G5300-01-4D | COLA COMPLETA L | COMPLETE GEAR HOUSING L | PIEDE COMPLETO L | EMBASE COMPLETE L |
| | PAF2.6-03020000S | 69M-G5300-00-4D | COLA COMPLETA S | COMPLETE GEAR HOUSING S | PIEDE COMPLETO S | EMBASE COMPLETE S |
| 1 | PAF2.6-03000001 | 69M-G5311-00-4D | CARCASA | LOWER CASING | CARASSA | CARTER D'EMBASE |
| 2 | REC90340-08002 | 90340-08002 | TAPÓN ACEITE | PLUG, OIL | TAPPO OLIO | BOUCHON REMPLISSAGE D'HUILE |
| 3 | REC90430-08020 | 90430-08020 | JUNTA | GASKET | GUARNIZIONE | JOINT |
| 4 | PAGB/T97.1-8 | 97595-06520 | ARANDELA | WASHER | RONDELLA | RONDELLE |
| 5 | PAGB/T5783-M5X12 | 95895-06020 | TORNILLO | BOLT | VITE | VIS |
| 6 | PAF2.6-03000002 | 6L5-45317-09 | COJINETE | BEARING | CUSCINETTO | PALIER |
| 7 | PAF2.6-03000017 | 6L5-45533-00-20 | GRUESO (2.0mm) | SHIM (2.0mm) | SPESSORE (2.0mm) | CALE (2.0mm) |
| 8 | PAF2.6-03000018 | 6L5-45551-00 | PIÑÓN ATAQUE | INITIATIVE GEAR | PIGNONE | PIGNON D'ATTAQUE |
| 9 | PAGB/T896-86 | 99001-06600 | CIRCLIP | CIRCLIP | CIRCLIP | CIRCLIP |
| 10 | PAF4-03000022 | 68D-G5251-00 | ÁNODO | ANODE | ANODO | ANODE |
| 11 | PAGB/T861.1-87 | 92990-06300 | ARANDELA | WASHER | RONDELLA | RONDELLE |
| 12 | PAF2.6-03000020 | 69M-G5635-00 | TAPÓN CAMBIO | PLUG, SHIFT | TAPPO | BOUCHON |
| 13 | PANTN16003EY | 93316-003Y0 | COJINETE | BEARING | CUSCINETTO | PALIER |
| 14 | PAF2.6-03000019 | 6L5-45560-00 | PIÑÓN MARCHA AVANTE | POSITIVE GEAR ASSY | PIGNONE MARCIA AVANTI | PIGNON DE MARCHÉ AVANT |
| 15 | PAF4-03030003 | 90501-10064 | MUELLE | SPRING, CLUTCH BLOCK | MOLLA | RESSORT |
| 16 | PAF2.6-03000202 | 6L5-45631-00 | SELECTOR | CLUTCH BLOCK | SELETTORE | SELECTEUR |
| 17 | PAF2.6-03000201 | 6L5-45631-00 | EJE HÉLICE | SHAFT, PROPELLER | ASSE ELICA | ARBRE D'HELICE |
| 18 | PAF2.6-03000021 | 90201-13198 | ARANDELA | WASHER | RONDELLA | RONDELLE |
| 19 | PAJISB2401P48 | 93210-48214 | TÓRICA | O-RING | O-RING | JOINT TORIQUE |
| 20 | PAF2.6-03000300 | 69M-G5361-00-4D | TAPA CARTER COMPLETA | COVER ASSY, LOWER CASING | COPERCHIO DE CARTER COMPLETO | DIABOLO COMPLET |
| 21 | PAF2.6-03000302 | | COJINETE CAMISA | BEARING, SLEEVE | CUSCINETTO ASSE | BAGUE |
| 22 | PAF2.6-03000301 | 69M-G5361-00-4D | TAPA CARTER | COVER, LOWER CASING | COPERCHIO CARTER | DIABOLO |
| 23 | PAF4-03050002 | 93101-13M12 | RETÉN DE ACEITE | OIL SEAL | PARAOLIO | JOINT SPI |
| 24 | PAF4-03000025 | 68D-G5978-00 | ESPACIADOR | SPACER | SPESSORE | ENTRETOISE |
| 25 | PAF2.6-03010000 | 6L5-45943-00-EL | HÉLICE | PROPELLER ASSY | ELICHE | HELICE |
| 26 | PAF4-03000026 | 90201-08M54 | ARANDELA | WASHER | RONDELLA | RONDELLE |
| 27 | PAF4-03080000 | 6L5-45616-00 | TUERCA | LOCK NUT | DADO | ÉCROU |
| 28 | PAGB/T91-1.6X12 | 91490-25030 | PASADOR ALETAS | PIN, COTTER | SPINOTTO | LEVIER |
| 29 | PAF2.6-03000003 | 6L5-45316-09 | COJINETE | BEARING | CUSCINETTO | PALIER |
| 30 | PAF15-00000013 | 93604-12M07 | PASADOR | PIN | SPINOTTO | LEVIER |
| 31 | PAF2.6-03000004 | 93103-09M41 | RETÉN DE ACEITE | OIL SEAL | PARAOLIO | JOINT D'HUILE |
| 32 | PAF2.6-03000007 | 69M-G5315-A0 | JUNTA | GASKET, WATER PUMP | GUARNIZIONE | JOINT |
| 33 | PAF2.6-03000008 | 69M-G5321-00-94 | CUERPO BOMBA | HOUSING, WATER PUMP | CORPO POMPA ACQUA | CORPS DE POMPE À EAU |
| 34 | PAF4-03000013 | 93604-18080 | PASADOR | PIN | SPINOTTO | LEVIER |
| 35 | PAF2.6-03000009 | 93210-05001 | TÓRICA | O-RING | O-RING | JOINT TORIQUE |
| 36 | PAF2.6-03000010 | 69M-G4323-00 | PLACA | OUT PLATE | PIASTRA | PLAQUE |
| 37 | PAF2.6-03000100 | 6L5-44352-00 | TURBINA | IMPELLER | GIRANTE | TURBINE |
| 38 | PAF2.6-03000015 | 6L5-44322-00 | TAPA BOMBA AGUA | COVER, INNER WATER PUMP | TAPPO | COUVERCLE DE POMPE D'EAU |
| 39 | PAJASOF404-19-033 | 93210-33M85 | TÓRICA | O-RING | O-RING | JOINT TORIQUE |
| 40 | PAF2.6-03000014 | 69M-G4311-00 | CUERPO BOMBA | WATER PUMP HOUSING | CORPO POMPA ACQUA | CORPS DE POMPE À EAU |
| 41 | PAF4-03000021 | 6R0-44366-00 | TUBO BOMBA AGUA | RUBBER TUBE, WATER PUMP | TUBO POMPA ACQUA | TUBE DE POMPE À EAU |
| 42 | PAF2.6-03000016 | 69M-G4328-00 | PLATO BOMBA DE AGUA | PLATE, WATER PUMP FIXED | PIASTRA | PLAQUE, POMPE D'EAU |
| 43 | PAF2.6-03000012 | 93440-08819 | CIRCLIP | CIRCLIP | CIRCLIP | CIRCLIP |
| 44 | PAF2.6-03000013 | 93604-07M13 | PASADOR | PIN | SPINOTTO | LEVIER |
| 45 | PAF2.6-03000011S | 69M-G5511-00 | EJE VERTICAL S | DRIVE SHAFT S | ASSE VERTICALE S | ARBRE DE COMMANDE S |
| | PAF2.6-03000011L | 69M-G5511-10 | EJE VERTICAL L | DRIVE SHAFT L | ASSE VERTICALE L | ARBRE DE COMMANDE L |
| 46 | PAF2.6-02000003S | 69M-44361-00 | TUBO DE AGUA S | WATER TUBE S | TUBO DELL'ACQUA S | DURITE D'EAU S |
| | PAF2.6-02000003L | 69M-44361-10 | TUBO DE AGUA L | WATER TUBE L | TUBO DELL'ACQUA L | DURITE D'EAU L |
| 47 | PAF4-02040002 | 68D-G4365-00 | GOMA DEL TUBO DE AGUA | I-SHAPED RUBBER BAND | GOMMA TUBO ACQUA | PLOT CAOUTCHOUC DE TUBE D'EAU |

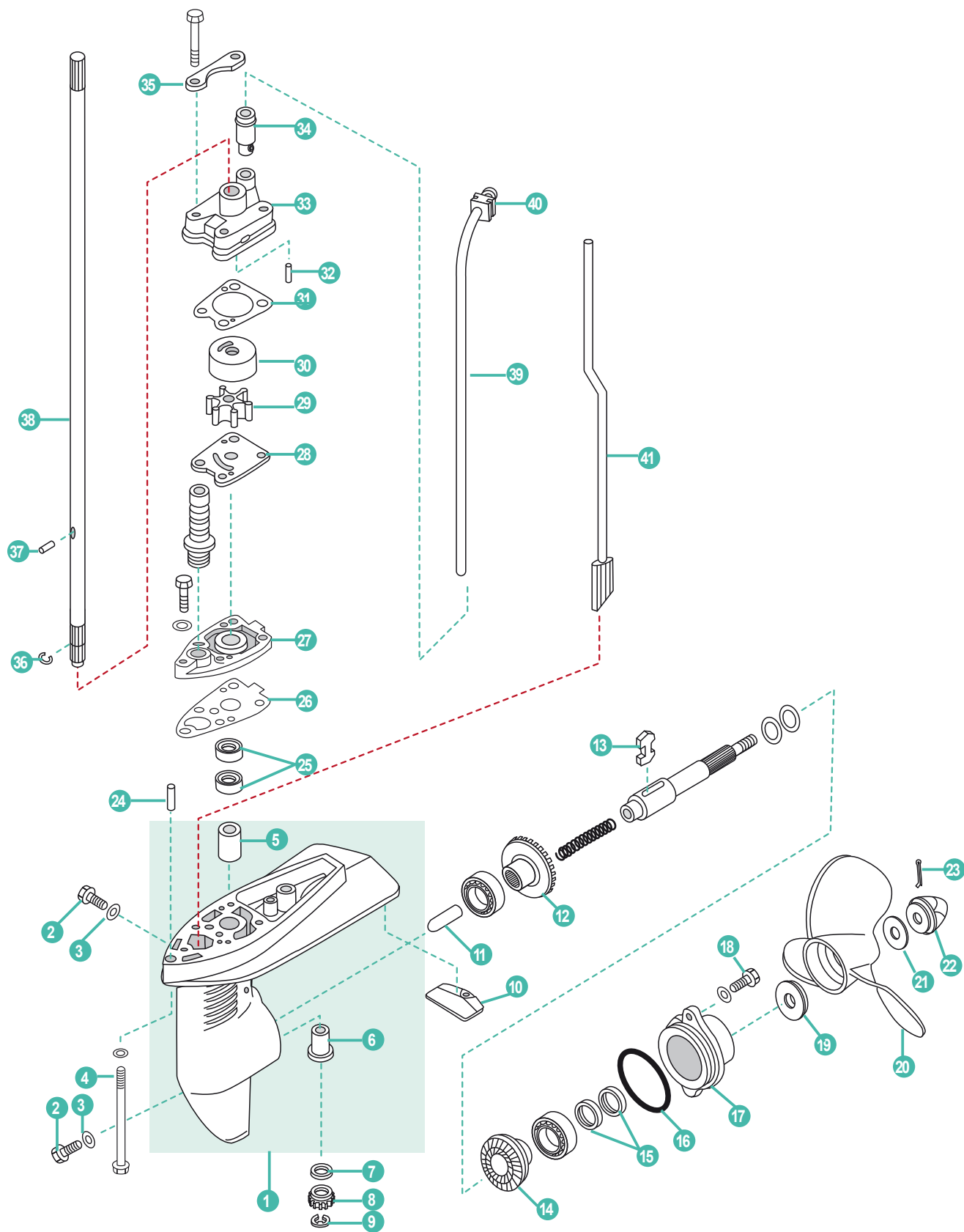

| | REF | OEM | | | | |
|----|-------------------|------------------|-----------------------|----------------------------------|------------------------------|------------------------------|
| | PAF4-0310000L | 68D-G5300-10-4D | COLA COMPLETA L | COMPLETE GEAR HOUSING L | PIEDE COMPLETO L | EMBASE COMPLETE L |
| | PAF4-0310000S | 68D-G5300-00-4D | COLA COMPLETA S | COMPLETE GEAR HOUSING S | PIEDE COMPLETO S | EMBASE COMPLETE S |
| 1 | PAF4-03000001 | 68D-G5300-11-4D | CARCASA MOTOR | CRANK CASE | CARCASSA | CARTER D'EMBASE |
| 2 | REC90340-08002 | 90340-08002 | TAPÓN ACEITE | PLUG, OIL | TAPPO OLIO | BOUCHON REMPLISSAGE D'HUILE |
| 3 | REC90430-08020 | 90430-08020 | JUNTA | GASKET | GUARNIZIONE | JOINT |
| 4 | PAGB/T5782-M6X125 | 97013-06035 | TORNILLO HEXAGONAL L | HEXAGON BOLT L | VITE L | VIS L |
| | PAGB/T5782-2000S | PAGB/T5782-2000S | TORNILLO HEXAGONAL S | HEXAGON BOLT S | VITE S | VIS S |
| 5 | PAF4-03000003 | 6E0-45316-09 | RODAMIENTO | BALL BEARING | CUSCINETTO | ROULEMENT À BILLE |
| 6 | PAF4-03000002 | 6E0-45317-09 | COJINETE | BEARING | CUSCINETTO | PALIER |
| 7 | PAF4-03000006 | 90204-11M49 | ARANDELA | WASHER | RONDELLA | RONDELLE |
| 8 | PAF4-03000007 | 6E0-45551-00 | PIÑÓN ATAQUE | INITIATIVE GEAR | MARCIA INIZIATIVA | PIGNON D'ATTAQUE |
| 9 | PAGB/T896-86 | 99001-06600 | CIRCLIP | CIRCLIP | CIRCLIP | CIRCLIP |
| 10 | PAF4-03000022 | 68D-G5251-00 | ÁNODO | ANODE | ANODO | ANODE |
| 11 | PAF4-03000008 | 67D-45635-00 | ÉMBOLO | PLUGER, SHIFT | BULLONE | BOUCHON |
| 12 | PAF4-03010000 | 67D-45560-00 | PIÑÓN MARCHA AVANTE | POSITIVE GEAR ASSY | PIGNONE MARCIA AVANTI | PIGNON DE MARCHE AVANT |
| 13 | PAF4-03030002 | 67D-45631-01 | SELECTOR | CLUTCH BLOCK | SELETTORE | SELECTEUR |
| 14 | PAF4-03040000 | 67D-45570-00 | PIÑÓN MARCHA ATRÁS | REVERSE GEAR | PIGNONE MARCIA INDIETRO | PIGNON MARCHE ARRIÈRE |
| 15 | PAF4-03050002 | 93101-13M12 | RETÉN DE ACEITE | OIL SEAL | PARAOLIO | JOINT SPI |
| 16 | PAJISB2401P48 | 93210-48214 | TÓRICA | O-RING | O-RING | JOINT TORIQUE |
| 17 | PAF4-03050001 | 68D-G5361-00-4D | TAPA CÁRTER | COVER, LOWER CASING | TAPPO CARTER | DIABOLO |
| 18 | PAGB/T5783-M5X12 | 95895-06016-00 | TORNILLO HEXAGONAL | HEXAGON BOLT | VITE ESSAGONALE | VIS HEXAGONAL |
| 19 | PAF4-03000025 | 68D-G5987-00 | ESPACIADOR | SPACER | DISTANZIALE | ENTRETOISE |
| 20 | PAF4-03070000 | 6E0-45943-01-EL | HÉLICE | PROPELLER | ELICHE | HELICE |
| 21 | PAF4-03000026 | 90201-08M54 | ARANDELA INOX. | WASHER, STAINLESS STEEL | RONDELLA INOX. | RONDELLE INOX |
| 22 | PAF4-03080000 | 6L5-45616-00 | TUERCA | LOCK NUT | DADO | ÉCROU |
| 23 | PAGB/T91-1.6X12 | 91490-25030 | PASADOR ALETAS | PIN, COTTER 2.5x30 | PIN | PIN |
| 24 | PAF4-00000001 | 90387-06806 | PASADOR VACÍO | HOLLOW PIN | SPINOTTO | GUIDE |
| 25 | PAF4-03000027 | 93101-10M14 | RETÉN DE ACEITE | OIL SEAL | PARAOLIO | JOINT SPI |
| 26 | PAF4-03000011 | 68D-G5315-A0 | JUNTA HERMÉTICA BASE | HERMETIC GASKET, WATER PUMP BASE | GUARNIZIONE BASE POMPA ACQUA | JOINT DE BASE DE POMPE À EAU |
| 27 | PAF4-03000012 | 68D-G5321-00 | BASE BOMBA AGUA | BASE, WATER PUMP | BASE POMPA | BASE DE POMPE À EAU |
| 28 | PAF4-03000015 | 6E0-44323-00 | PLACA | OUT PLATE | PIASTRA | PLAQUE |
| 29 | PAF4-03060000 | 6E0-44352-00 | TURBINA BOMBA AGUA | IMPELLER, WATER PUMP | GIRANTE POMPA | TURBINE, POMPE D'EAU |
| 30 | PAF4-03000017 | 6E0-44322-02 | TAPA, BOMBA AGUA | COVER, INNER WATER PUMP | COPERCHIO, POMPE D'EAU | COUVERCLE, POMPE D'EAU |
| 31 | PAF4-03000018 | 68D-G4315-A0 | JUNTA TAPA BOMBA AGUA | GASKET, WATER PUMP COVER | GUARNIZIONE COPERCHIO | JOINT COUVERCLE |
| 32 | PAF4-03000013 | 93604-18080 | PASADOR BOMBA AGUA | PIN, WATER PUMP | SPINOTTO POMPA ACQUA | LEVIER POMPE D'EAU |
| 33 | PAF4-03000019 | 68D-G4311-01 | CUERPO BOMBA AGUA | HOUSING, WATER PUMP | CORPO POMPA | LOGEMENT POMPE D'EAU |
| 34 | PAF4-03000021 | 67D-44366-00 | TUBO GOMA BOMBA AGUA | RUBBER TUBE, WATER PUMP | TUBO IN GOMMA, POMPA | DURITE DE COUTCHOU |
| 35 | PAF4-03000020 | 68D-G4328-00 | PLCA BOMBA AGUA | PLATE, WATER PUMP FIXED | PIASTRA POMPA | PLAQUE, POMPE D'EAU |
| 36 | PAF4-03000005 | 90467-08M01 | CLIP | CLIP | CLIP | CLIP |
| 37 | PAF4-03000016 | 93604-09066 | PASADOR | PIN | SPINOTTO | LEVIER |
| 38 | PAF4-03000004L | 6E0-45511-11 | EJE VERTICAL S | DRIVE SHAFT S | ASSE VERTICALE S | ARBRE DE COMMANDE S |
| | PAF4-03000004S | 6E0-45511-01 | EJE VERTICAL L | DRIVE SHAFT L | ASSE VERTICALE L | ARBRE DE COMMANDE L |
| 39 | PAF4-02040001 | 68D-G4360-10 | TUBO DE AGUA S | WATER TUBE S | TUBO DELL'ACQUA S | DURITE D'EAU S |
| | PAF4-02040001S | 68D-G4360-00 | TUBO DE AGUA L | WATER TUBE L | TUBO DELL'ACQUA L | DURITE D'EAU L |
| 40 | PAF4-02040002 | 68D-G4365-00 | GOMA DEL TUBO DE AGUA | I-SHAPED RUBBER BAND | GOMMA TUBO ACQUA | PLOT CAOUTCHOU DE TUBE D'EAU |
| 41 | PAF4-03020000L | 68D-G4150-10 | VARILLA SELECTOR L | CAM ASSY, SHIFT ROD L | ASTICELLA CAMBIO L | LEVIER DE VITESSE L |
| | PAF4-03020000S | 68D-G4150-00 | VARILLA SELECTOR S | CAM ASSY, SHIFT ROD S | ASTICELLA CAMBIO S | LEVIER DE VITESSE S |



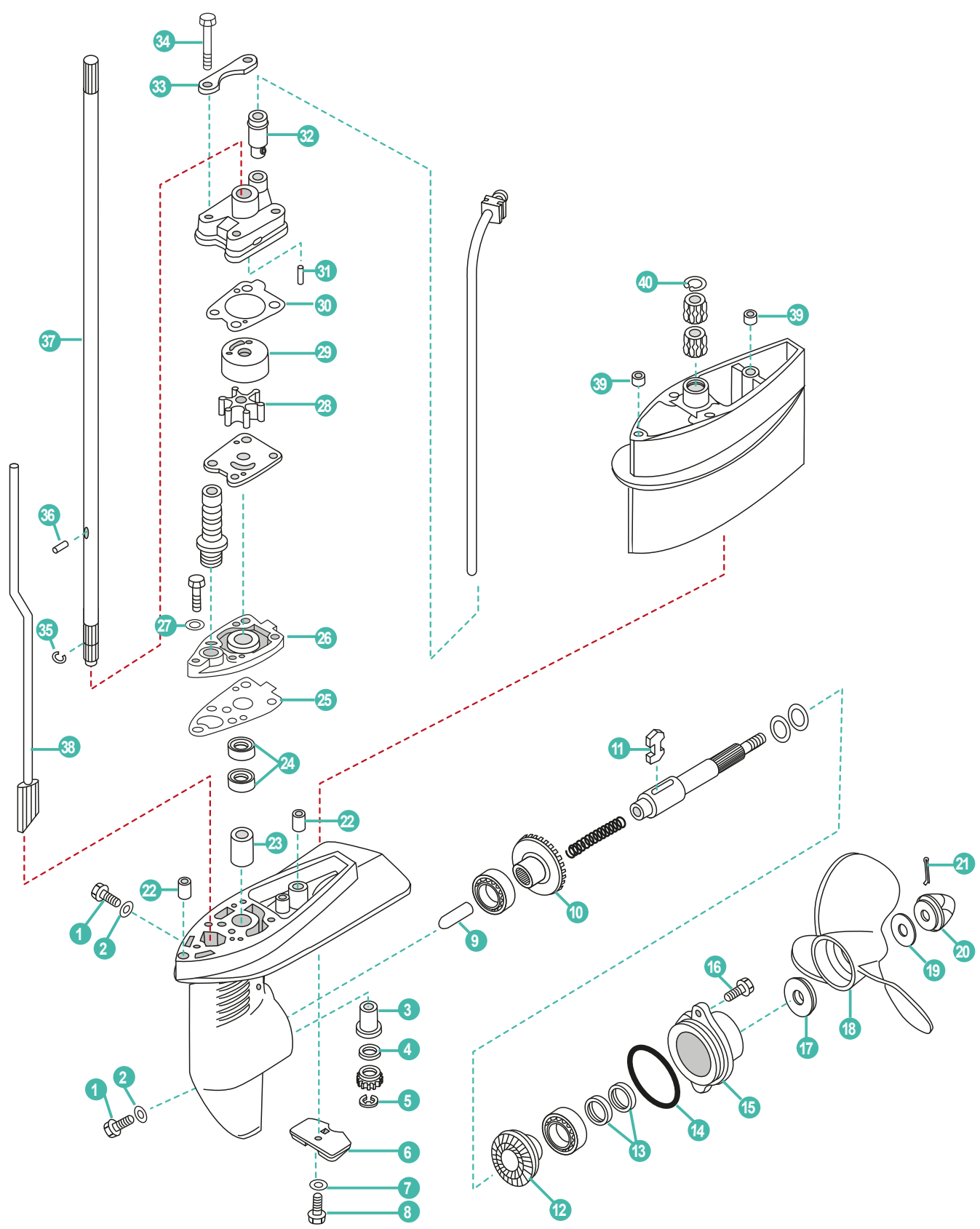

| | REF | OEM | | | | |
|----|------------------|-----------------|-----------------------|--------------------------|------------------------------|-------------------------------|
| 1 | REC90340-08002 | 90340-08002 | TORNILLO DRENAJE | BOLT, DISCHARGING OIL | VITE DRENAGGIO | BOUCHON DE VIDANGE |
| 2 | REC90430-08020 | 90430-08020 | JUNTA | GASKET | GUANIZIONE | JOINT |
| 3 | PAF4-03000002 | 6E0-45317-09 | COJINETE | BEARING | CUSCINETTO | PALIER |
| 4 | PAF4-03000006 | 90201-11M49 | ARANDELA | WASHER | RONDELLA | RONDELLE |
| 5 | REC99001-06600 | 99001-06600 | CIRCLIP | CIRCLIP | CIRCLIP | CIRCLIP |
| 6 | CM6L5-45251-02A | 68D-G5251-00 | ÁNODO | ANODE | ANODO | ANODE |
| 7 | PAGB/T861.1-87 | 92990-06300 | ARANDELA | WASHER | RONDELLA | RONDELLE |
| 8 | PAGB/T5783-M6X14 | 95895-06012 | TORNILLO | SCREW | VITE | VIS |
| 9 | PAF4-03000008 | 67D-45635-00 | ÉMBOLO | PLUGER, SHIFT | BULLONE | AXE DE VERROUILLAGE DU CRABOT |
| 10 | PAF4-03010000 | 67D-45560-00 | PIÑÓN MARCHA AVANTE | POSITIVE GEAR ASSY | PIGNONE MARCIA AVANTI | PIGNON DE MARCHÉ AVANT |
| 11 | PAF4-03030002 | 67D-45631-01 | SELECTOR | CLUTCH BLOCK | SELETORE | BLOQUEUR |
| 12 | PAF4-03040000 | 67D-45570-00 | PIÑÓN MARCHA ATRÁS | REVERSE GEAR | PIGNONE MARCIA INDIETRO | PIGNON MARCHÉ ARRIÈRE |
| 13 | REC93101-13M12 | 93101-13M12 | RETÉN DE ACEITE | OIL SEAL | PARAOLIO | JOINT SPI |
| 14 | REC93210-48214 | 93210-48214 | TÓRICA | O-RING | O-RING | JOINT TORIQUE |
| 15 | PAF4-03050001 | 68D-G5361-00-4D | TAPA CÁRTER | COVER, LOWER CASING | COPERCHIO CARTER | DIABOLO |
| 16 | PAGB/T5783-M5X12 | 95895-06016 | TORNILLO HEXAGONAL | HEXAGON BOLT M6x18 | VITE | VIS |
| 17 | PAF4-03000025 | 68D-G5987-00 | ESPACIADOR | SPACER | DISTANZIALE | ENTRETOISE |
| 18 | PAF4-03070000 | 6E0-45943-01 | HÉLICE | PROPELLER | ELICHE | HELICE |
| 18 | PAF2.6-03010000 | 6E0-45949-00 | HÉLICE | PROPELLER | ELICHE | HELICE |
| 19 | PAF4-03000026 | 90201-08M54 | ARANDELA INOX. | WASHER, STAINLESS STEEL | RONDELLA INOX. | RONDELLE INOX |
| 20 | PAF4-03080000 | 6L5-45646-00 | TUERCA | LOCK NUT | DADO | ÉCROU |
| 21 | PAGB/T91-1.6X12 | 91490-25030 | PASADOR ALETAS | PIN, COTTER 2.5x30 | PIN | PIN |
| 22 | PAF4-00000001 | 90387-06806 | ESPACIADOR | SPACER | DISTANZIALE | ENTRETOISE |
| 23 | PAF4-03000003 | 6E0-45316-09 | RODAMIENTO | BALL BEARING | CUSCINETTO | ROULEMENT À BILLE |
| 24 | PAF4-03000027 | 93101-10M14 | RETÉN DE ACEITE | OIL SEAL | PARAOLIO | JOINT SPI |
| 25 | PAF4-03000011 | 68D-G5315-A0 | JUNTA BASE | GASKET, WATER PUMP BASE | GUARNIZIONE BASE POMPA ACQUA | JOINT DE POMPE À EAU |
| 26 | PAF4-03000012 | 68D-G5321-00 | PLACA | OUT PLATE | PIASTRA | PLAQUE |
| 27 | PAGB/T97.1-6 | 92995-06600 | ARANDELA | WASHER | RONDELLA | RONDELLE |
| 28 | REC6E0-44352-00 | 6E0-44352-00 | TURBINA BOMBA AGUA | IMPELLER, WATER PUMP | GIRANTE POMPA | TURBINE DEPOMPE À EAU |
| 29 | PAF6-03000002 | 6BX-44322-00 | TAPA, BOMBA AGUA | COVER, INNER WATER PUMP | COPERCHIO, POMPE ACQUA | INSERT DE POMPE À EAU |
| 30 | PAF4-03000018 | 6BX-G4315-01 | JUNTA TAPA BOMBA AGUA | GASKET, WATER PUMP COVER | GUARNIZIONE COPERCHIO | JOINT COUVERCLE |
| 31 | PAF4-03000013 | 93604-18080 | PASADOR BOMBA AGUA | PIN, WATER PUMP | SPINOTTO POMPA ACQUA | PIN DE POMPE À EAU |
| 32 | PAF4-03000021 | 67D-44366-00 | TUBO GOMA BOMBA AGUA | RUBBER TUBE, WATER PUMP | TUBO IN GOMMA, POMPA | DURITE COUTCHOUÇ |
| 33 | PAF4-03000020 | 68D-G4328-00 | PLCA BOMBA AGUA | PLATE, WATER PUMP FIXED | PIASTRA POMPA | PLAQUE, POMPE À EAU |
| 34 | REC97095-06045 | 97095-06045 | TORNILLO | SCREW | VITE | VIS |
| 35 | PAF4-03000005 | 90467-08M01 | CLIP | CLIP | CLIP | CLIP |
| 36 | PAF4-03000016 | 93604-09066 | PASADOR | PIN | SPINOTTO | CLAVETTE |
| 37 | PAF4-03000004S | 68D-G5511-00 | EJE VERTICAL S | DRIVE SHAFT S | ASSE VERTICALE S | ARBRE DE COMMANDE S |
| 37 | PAF4-03000004L | 68D-G5511-10 | EJE VERTICAL L | DRIVE SHAFT L | ASSE VERTICALE L | ARBRE DE COMMANDE L |
| 38 | PAF4-03020000S | 6BX-G4150-00 | EJE LEVA COMPLETO S | CAM ASSY, SHIFT ROD S | ASSE LEVA COMPLETO S | LEVIER DE VITESSE S |
| 38 | PAF4-03020000L | 6BX-G4150-10 | EJE LEVA COMPLETO L | CAM ASSY, SHIFT ROD L | ASSE LEVA COMPLETO L | LEVIER DE VITESSE L |
| 39 | PAF4-00000001 | 90387-06806 | ESPACIADOR | SPACER | DISTANZIALE | ENTRETOISE |
| 40 | PAGB/T893.1-22 | 93420-22M03 | SEGURO | CLAMP | BLOCCAGGIO | CLAVETTE |



REC80W90U3
REC80W90U6
RECGREU1
RECGREU12

P. 43

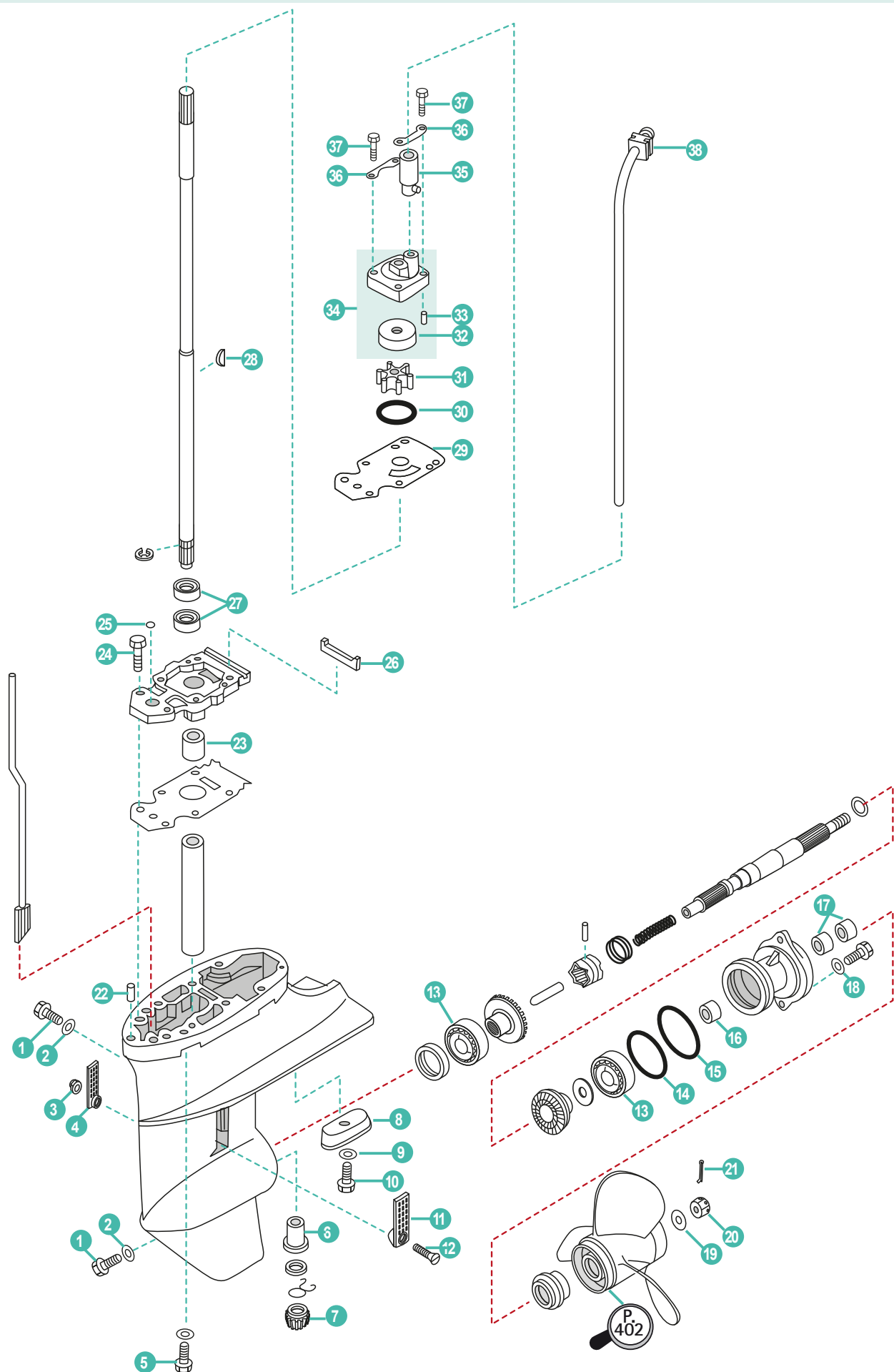

| | REF | OEM | | | | |
|----|------------------|--------------|----------------------------|--------------------------|---------------------------|------------------------------|
| 1 | REC90340-08002 | 90340-08002 | TORNILLO DRENAJE | BOLT, DISCHARGING OIL | VITE DRENAGGIO | BOUCHON DE VIDANGE |
| 2 | REC90430-08020 | 90430-08020 | JUNTA | GASKET | GUANIZIONE | JOINT |
| 3 | PAGB/T6182-M5 | 90185-05002 | TUERCA AUTOBLOCANTE | NUT LOCKING M5 | DADO CHIUSURA M5 | ECROU FREIN M5 |
| 4 | PAF15-06000002 | 6G1-45215-00 | CUBIERTA ENTRADA DE AGUA 2 | WATER INLET 2 | COPERCHIO ENTRATA ACQUA 2 | GRILLE D'ENTREE D'EAU 2 |
| 5 | PAGB/T5783-M8X35 | 97075-08035 | PERNO | STUD | BULLONE | BOULON |
| 6 | REC6G1-45317-09 | 6G1-45317-09 | RODAMIENTO | BALL BEARING | CUSCINETTO | ROULEMENT À BILLE |
| 7 | REC68T-45551-00 | 6N0-G5551-A0 | PIÑÓN ATAQUE | INITIATIVE GEAR | MARCIA INIZIATIVA | PIGNON D'ATTAQUE |
| 8 | CM68T-45251-00A | 68T-45251-00 | ÁNODO | ANODE | ANODO | ANODE |
| 9 | PAGB/T861.1-87 | 92990-06300 | ARANDELA | WASHER | RONDELLA | RONDELLE |
| 10 | PAGB/T5783-M5X12 | 95895-06016 | TORNILLO | SCREW | VITE | VIS |
| 11 | PAF15-06000003 | 6G1-45214-00 | CUBIERTA ENTRADA DE AGUA 1 | WATER INLET 1 | COPERCHIO ENTRATA ACQUA 1 | GRILLE D'ENTREE D'EAU 1 |
| 12 | PAGB/T820-M5X25 | 90152-05M03 | TORNILLO | SCREW | VITE | VIS |
| 13 | PAGB/T276-6004C2 | 93306-004YH | COJINETE | BEARING | CUSCINETTO | PALIER |
| 14 | REC93210-49046 | 93210-49046 | TÓRICA | O-RING | O-RING | JOINT TORIQUE |
| 15 | REC93210-53M08 | 93210-53M08 | TÓRICA | O-RING | O-RING | JOINT TORIQUE |
| 16 | REC6G1-45362-09 | 6G1-45362-09 | RODAMIENTO | BALL BEARING | CUSCINETTO | ROULEMENT À BILLE |
| 17 | REC93101-15074 | 93101-15074 | RETÉN DE ACEITE | OIL SEAL | PARAOLIO | JOINT SPI |
| 18 | PAGB/T97.1-6 | 92995-06600 | ARANDELA | WASHER | RONDELLA | RONDELLE |
| 19 | REC90201-10M01 | 90201-10M01 | ARANDELA | WASHER | RONDELLA | RONDELLE |
| 20 | REC90171-10M01 | 90171-10M01 | TUERCA | LOCK NUT | DADO | ÉCROU |
| 21 | REC91490-30025 | 91490-30020 | PASADOR ALETAS | PIN, COTTER | PIN | GOUPILLE |
| 22 | PAF15-00000013 | 93604-12M07 | PIN CENTRADOR | HOLLOW PIN | SPINOTTO DI CENTRAGGIO | PIN DE CENTRAGE |
| 23 | REC6G1-45316-09 | 6G1-45316-09 | RODAMIENTO | BALL BEARING | CUSCINETTO | ROULEMENT À BILLE |
| 24 | PAGB/T5783-M8X25 | 97080-08025 | PERNO | STUD | BULLONE | BOULON |
| 25 | REC93210-06ME6 | 93210-06ME6 | TÓRICA | O-RING | O-RING | JOINT TORIQUE |
| 26 | PAF15-06020005 | 63V-45375-00 | RETÉN DE GOMA | SEAL, RUBBER | TENUTA IN GOMMA | JOINT DE COUTCHOU |
| 27 | REC93101-11M23 | 93101-11M23 | RETÉN DE ACEITE | OIL SEAL | PARAOLIO | JOINT SPI |
| 28 | REC664-44338-00 | 664-44338-00 | CUÑA | KEY WOODRUFF | CHIAVETTA | CLAVETTE |
| 29 | REC68T-44323-00 | 68T-44323-00 | JUNTA TAPA BOMBA AGUA | GASKET, WATER PUMP COVER | GUARNIZIONE COPERCHIO | JOINT COUVERCLE |
| 30 | REC93210-44398 | 93210-44398 | TÓRICA | O-RING | O-RING | JOINT TORIQUE |
| 31 | REC68T-44352-00 | 68T-44352-00 | TURBINA BOMBA AGUA | IMPELLER, WATER PUMP | GIRANTE POMPA | TURBINE DE POMPE À EAU |
| 32 | REC63V-44322-00 | 63V-44322-00 | TAPA, BOMBA AGUA | COVER, INNER WATER PUMP | COPERCHIO, POMPE ACQUA | COUVERCLE, POMPE À EAU |
| 33 | PAF15-00000013 | 93604-12M07 | PIN CENTRADOR | HOLLOW PIN | SPINOTTO DI CENTRAGGIO | PIN DE CENTRAGE |
| 34 | REC63V-44301-00 | 63V-44301-00 | CUERPO BOMBA AGUA | HOUSING, WATER PUMP | CORPO POMPA | CORPS DE POMPE À EAU |
| 35 | REC68T-44366-00 | 68T-44366-00 | TUBO GOMA BOMBA AGUA | RUBBER TUBE, WATER PUMP | TUBO IN GOMMA, POMPA | DURITE COUTCHOU |
| 36 | PAF15-06000014 | 63V-44328-00 | PLACA | OUT PLATE | PIASTRA | PLAQUE |
| 37 | REC97080-08045 | 97080-08045 | PERNO | STUD | BULLONE | BOULON |
| 38 | PAF15-02000006 | 63V-44365-10 | GOMA DEL TUBO DE AGUA | I-SHAPED RUBBER BAND | GOMMA TUBO ACQUA | PLOT CAOUTCHOU DE TUBE D'EAU |

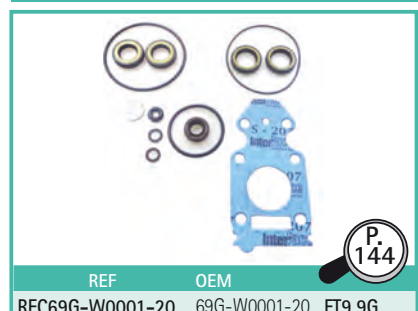

4T STROKES F9.9 (1998-08) • F9.9C • F13.5 (2002-07) • F15 (1998-07) • F15A

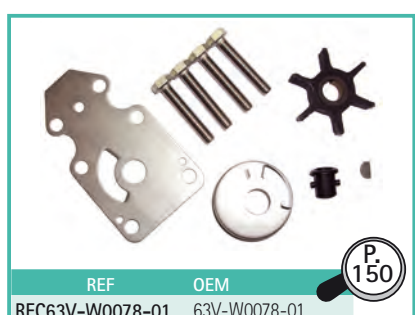
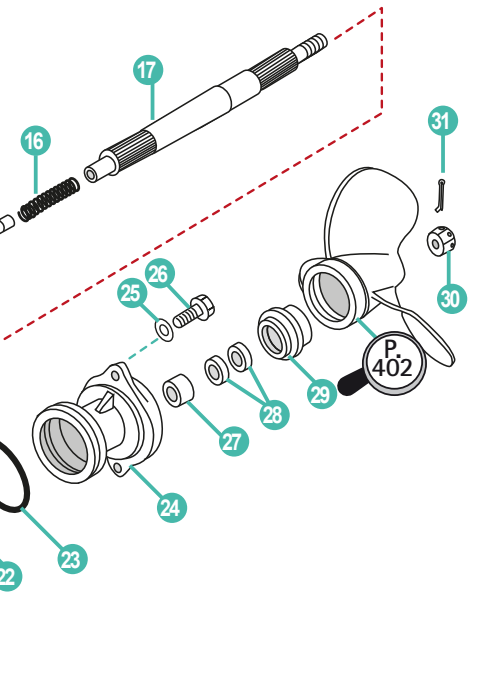
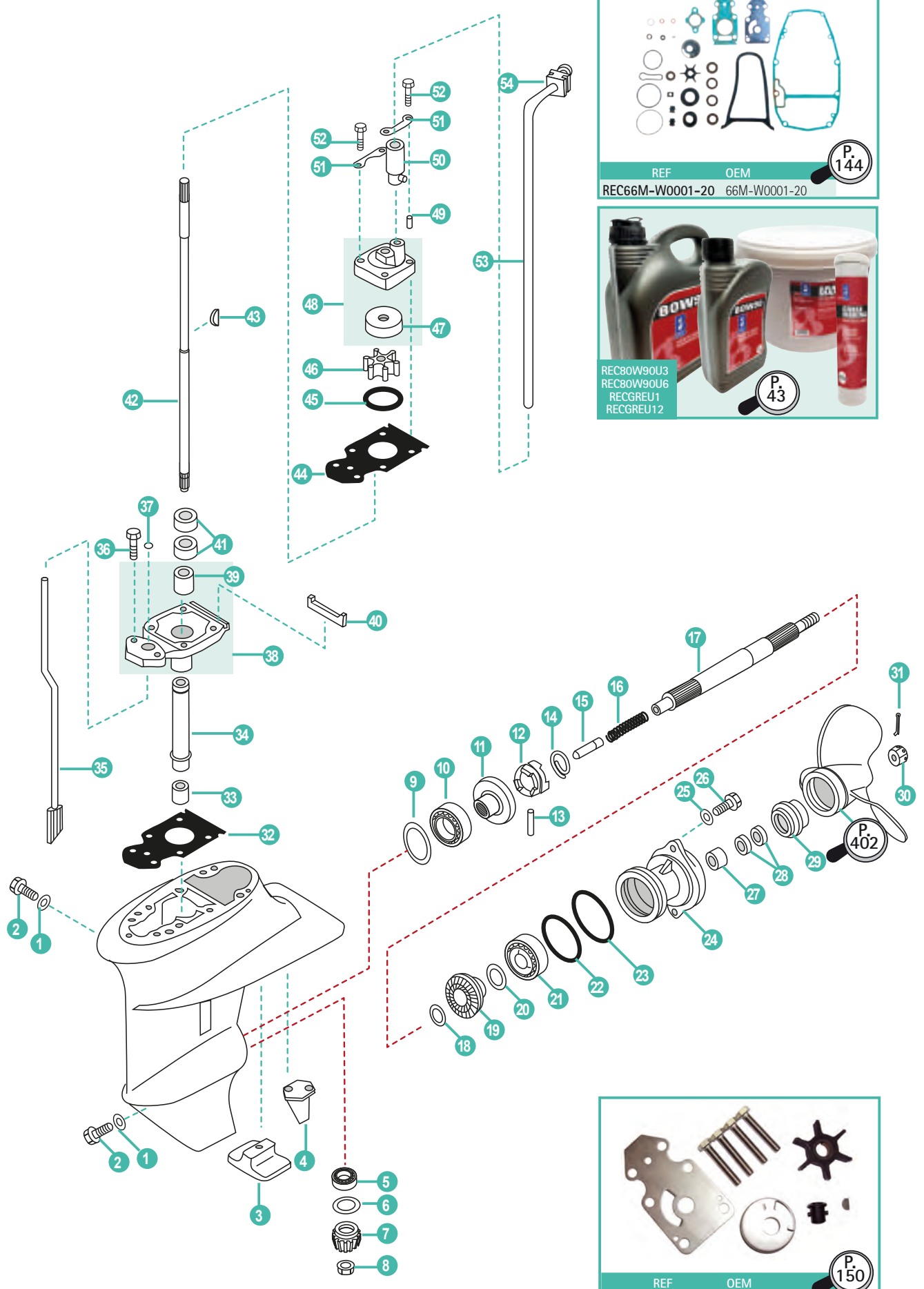

| | REF | OEM | | | | |
|----|--------------------|-----------------|-----------------------|--------------------------|----------------------------|------------------------------|
| | PAF15-06100000L | 66M-45300-11-4D | COLA COMPLETA L | COMPLETE GEAR HOUSING L | PIEDE COMPLETO L | EMBASE COMPLETE L |
| | PAF15-06100000S | 66M-45300-02-4D | COLA COMPLETA S | COMPLETE GEAR HOUSING S | PIEDE COMPLETO S | EMBASE COMPLETE S |
| 1 | REC90430-08020 | 90430-08020 | ARANDELA | WASHER | RONDELLA | RONDELLE |
| 2 | REC90340-08002 | 90340-08002 | TAPÓN ACEITE | PLUG, OIL | TAPPO OLIO | BOUCHON REMPLISSAGE D'HUILE |
| 3 | CM61N-45251-01 | 61N-45251-01 | ÁNODO | ANODE | ANODO | ANODE |
| 4 | CM66M-45371-00 | 66M-45371-00 | ÁNODO TIMÓN | TAB-TRIM | ANODO TIMONE | ANODE |
| 5 | REC93341-214U1 | 93314-314V8 | COJINETE | BEARING | CUSCINETTO | PALIER |
| 6 | PAF15-06000008 | 6E8-45587-10-13 | GRUESO | SHIM | SPESSORE | CALE |
| 7 | REC63V-45551-00 | 63V-45551-00 | PIÑÓN ATAQUE | INITIATIVE GEAR | MARCIA INIZIATIVA | PIGNON D'ATTAQUE |
| 8 | REC90179-08M06 | 90179-08M06 | TUERCA | LOCK NUT | DADO | ÉCROU |
| 9 | PAF15-06000010-1 | 664-45567-01-10 | GRUESO | SHIM | SPESSORE | CALE |
| 10 | REC93332-00005 | 93332-00005 | COJINETE | BEARING | CUSCINETTO | PALIER |
| 11 | REC6E7-45560-01 | 6E7-45560-01 | PIÑÓN MARCHA AVANTE | POSITIVE GEAR ASSY | PIGNONE MARCIA AVANTI | PIGNON DE MARCHÉ AVANT |
| 12 | REC682-45631-00 | 682-45631-00 | SELECTOR | CLUTCH BLOCK | SELETTORE | SELECTEUR |
| 13 | REC90250-05010 | 90250-05010 | PASADOR | PIN | SPINOTTO | LEVIER |
| 14 | REC648-45633-00 | 648-45633-00 | MUELLE | SPRING | MOLLA | RESSORT |
| 15 | REC650-45635-00 | 650-45635-00 | ÉMBOLO | PLUNGER | BULLONE | BOUCHON |
| 16 | PAF15-06070002 | 90501-14M06 | MUELLE | SPRING | MOLLA | RESSORT |
| 17 | REC683-45611-00 | 683-45611-00 | EJE HÉLICE | PROPELLER SHAFT | ASSE ELICA | ARBRE D'HELICE |
| 18 | REC90201-17682 | 90201-17682 | ARANDELA | WASHER | RONDELLA | RONDELLE |
| 19 | REC6E7-45570-00 | 6E7-45571-00 | PIÑÓN MARCHA ATRÁS | REVERSE GEAR | PIGNONE MARCIA INDIETRO | PIGNON MARCHÉ ARRIÈRE |
| 20 | PAF15-06080006-1 | 626-45577-00-01 | GRUESO | SHIM | SPESSORE | CALE |
| 21 | REC93306-00501 | 93306-00501 | COJINETE | BEARING | CUSCINETTO | PALIER |
| 22 | REC93210-57M09 | 93210-57M09 | TÓRICA | O-RING | O-RING | JOINT TORIQUE |
| 23 | PAF15-06080003 | 93210-56M80 | TÓRICA | O-RING | O-RING | JOINT TORIQUE |
| 24 | REC683-45361-01-4D | 683-45361-02-4D | DIÁBOLO | CAP, LOWER CASING | COPERCHIO CARTER INFERIORE | DIABOLO |
| 25 | PAGB/T97.1-1-6 | 92995-06600 | ARANDELA | WASHER | RONDELLA | RONDELLE |
| 26 | PAGB/T5783-M6X20 | 97095-06020 | TORNILLO | SCREW | VITE | VIS |
| 27 | REC93315-317U2 | 93315-317U2 | COJINETE | BEARING | CUSCINETTO | PALIER |
| 28 | REC93101-17054 | 93101-17054 | RETÉN DE ACEITE | OIL SEAL | PARAOLIO | JOINT SPI |
| 29 | REC6E7-45987-00 | 6E7-45987-00 | ESPACIADOR | SPACER | DISTANZIALE | ENTRETOISE |
| 30 | REC90171-10M01 | 90171-10M01 | TUERCA | LOCK NUT | DADO | ÉCROU |
| 31 | REC91490-30025 | 91490-30020 | PASADOR ALETAS | PIN, COTTER | PIN | GOUPILLE |
| 32 | REC63V-45315-A0 | 63V-45315-A0 | JUNTA | GASKET | GUANIZIONE | JOINT |
| 33 | REC93315-314V8 | 93315-314V8 | COJINETE | BEARING | CUSCINETTO | PALIER |
| 34 | PAF15-06000006 | 63V-45536-00 | CAMISA EJE | SLEEVE, DRIVE | TUBO GUIDA | TUBE GUIDE |
| 35 | PAF15-06030000S | 63V-44150-00 | VARILLA SELECTOR S | CAM ASSY, SHIFT ROD S | ASTICELLA CAMBIO S | LEVIER DE VITESSE S |
| | PAF15-06030000L | 63V-44150-10 | VARILLA SELECTOR L | CAM ASSY, SHIFT ROD L | ASTICELLA CAMBIO L | LEVIER DE VITESSE L |
| 36 | PAGB/T5783-M8X25 | 97080-08025 | TORNILLO | SCREW | VITE | VIS |
| 37 | REC93210-06ME6 | 93210-06ME6 | TÓRICA | O-RING | O-RING | JOINT TORIQUE |
| 38 | REC63V-45331-00-5B | 63V-45331-00-5B | CUERPO DEL COJINETE | SHELL, BEARING | CORPO DE CUSCINETTO | LOGEMENT DE PALIER |
| 39 | REC626-45316-09 | 626-45316-09 | CASQUILLO EJE | BUSHER, SHAFT | GOMMINO ASSE | DOUILLE |
| 40 | PAF15-06020005 | 63V-45375-00 | RETÉN DE GOMA | SEAL, RUBBER | TENUTA IN COMMA | JOINT DE COUTCHOU |
| 41 | REC93101-20048 | 93101-20048 | RETÉN DE ACEITE | OIL SEAL | PARAOLIO | JOINT SPI |
| 42 | PAF15-06040000S | 63V-45510-00 | EJE VERTICAL S | DRIVE SHAFT S | ASSE VERTICALE S | ARBRE DE COMMANDE S |
| | REC63V-45501-10 | 63V-45510-11 | EJE VERTICAL L | DRIVE SHAFT L | ASSE VERTICALE L | ARBRE DE COMMANDE L |
| 43 | REC664-44338-00 | 664-44338-00 | CUÑA | KEY WOODRUFF | CHIAVETTA | CLAVETTE |
| 44 | REC63V-44323-00 | 63V-44323-00 | JUNTA TAPA BOMBA AGUA | GASKET, WATER PUMP COVER | GUARNIZIONE COPERCHIO | JOINT COUVERCLE |
| 45 | REC93210-44398 | 93210-44398 | TÓRICA | O-RING | O-RING | JOINT TORIQUE |
| 46 | REC63V-44352-01 | 63V-44352-01 | TURBINA | IMPELLER | GIRANTE | TURBINE |
| 47 | REC63V-44322-00 | 63V-44322-00 | TAPA, BOMBA AGUA | COVER, INNER WATER PUMP | COPERCHIO, POMPE DACQUA | INSERT DE POMPE À EAU |
| 48 | REC63V-44301-00 | 63V-44301-00 | CUERPO DE BOMBA | PUMP HOUSING | CORPO POMPA | CORPS DE POMPE À EAU |
| 49 | PAF15-00000013 | 93604-12M07 | PASADOR | PIN | SPINOTTO | PIN |
| 50 | REC647-44366-00 | 647-44366-00 | TUBO GOMA BOMBA AGUA | RUBBER TUBE, WATER PUMP | TUBO IN GOMMA, POMPA | DURITE COUTCHOU |
| 51 | PAF15-06000014 | 63V-44328-00 | PLACA | OUT PLATE | PIASTRA | PLAQUE |
| 52 | REC97080-08045 | 97080-08045 | PERNO | STUD | BULLONE | BOULON |
| 53 | PAF15-02000005S | 66M-44361-00 | TUBO DE AGUA S | WATER TUBE S | TUBO DELL'ACQUA S | DURITE D'EAU S |
| | PAF15-02000005L | 66M-44361-10 | TUBO DE AGUA L | WATER TUBE L | TUBO DELL'ACQUA L | DURITE D'EAU L |
| 54 | PAF15-02000006 | 63V-44365-10 | GOMA DEL TUBO DE AGUA | I-SHAPED RUBBER BAND | GOMMA TUBO ACQUA | PLOT CAOUTCHOU DE TUBE D'EAU |

4T F9.9H • F13.5B • F15C/M/E • F20B/E/M
STROKES

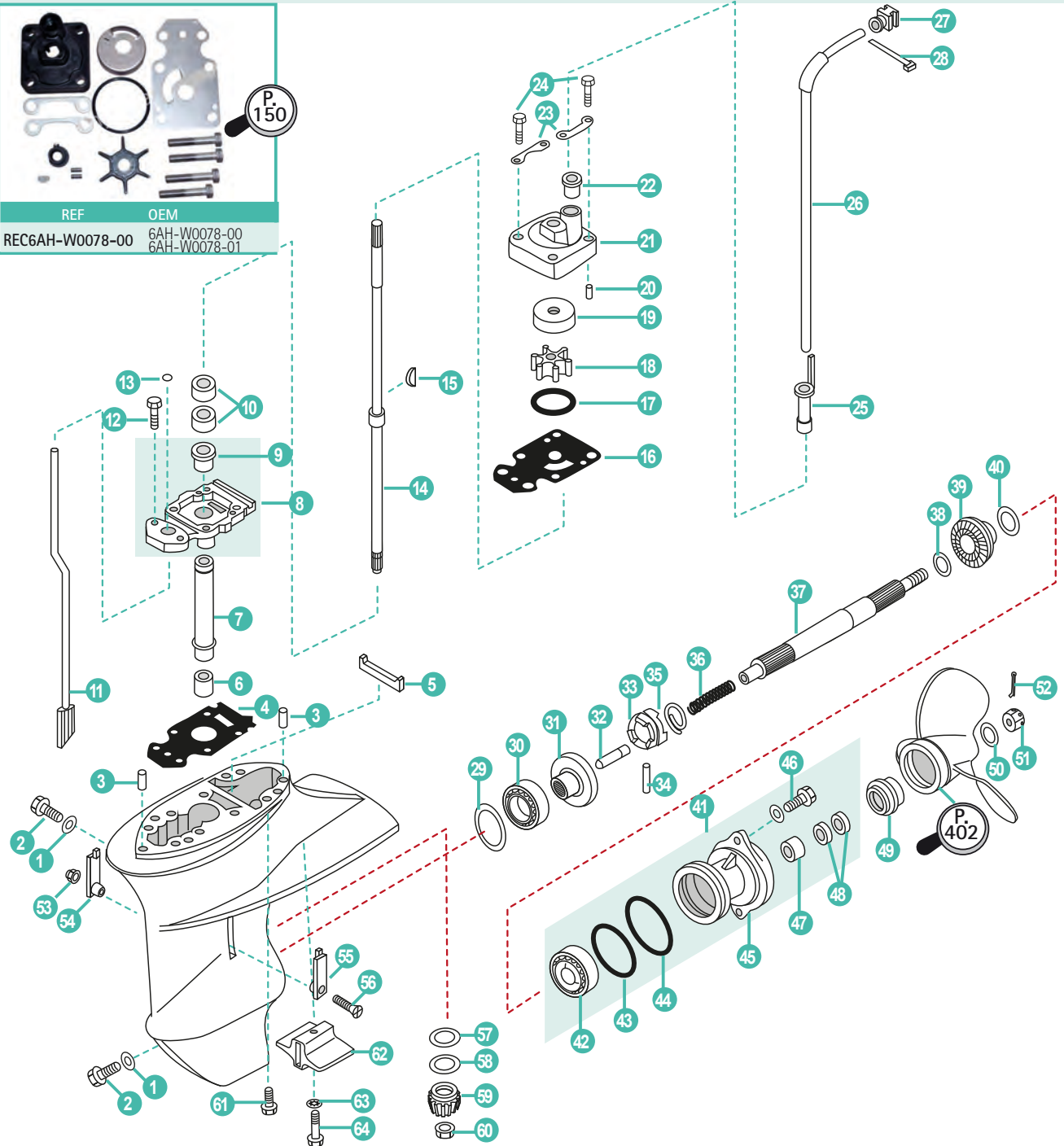

| | REF | OEM | | | | |
|----|------------------|-----------------|---------------------|-------------------------|------------------------|-----------------------------|
| | PAF20-04000000L | 6AH-45300-10-8D | COLA COMPLETA L | COMPLETE GEAR HOUSING L | PIEDE COMPLETO L | EMBASE COMPLETE L |
| | PAF20-04000000S | 6AH-45300-00-8D | COLA COMPLETA S | COMPLETE GEAR HOUSING S | PIEDE COMPLETO S | EMBASE COMPLETE S |
| 1 | REC90430-08020 | 90430-08003 | ARANDELA | WASHER | RONDELLA | RONDELLE |
| 2 | REC90340-08002 | 90340-08002 | TAPÓN ACEITE | PLUG, OIL | TAPPO OLIO | BOUCHON REMPLISSAGE D'HUILE |
| 3 | PAF15-00000013 | 93604-12M07 | PIN CENTRADOR | HOLLOW PIN | SPINOTTO DI CENTRAGGIO | PIN DE CENTRAGE |
| 4 | PAF20-04000001 | 69G-45315-A0 | JUNTA | GASKET | GUANIZIONE | JOINT |
| 5 | PAF15-06020005 | 63V-45375-00 | RETÉN DE GOMA | SEAL, RUBBER | TENUTA IN COMMA | JOINT CAOUTCHOUC |
| 6 | REC93315-314V8 | 93315-314V8 | RODAMIENTO | BALL BEARING | CUSCINETTO | ROULEMENT À BILLE |
| 7 | PAF15-06000006 | 63V-45536-00 | CAMISA EJE | SLEEVE, DRIVE | TUBO GUIDA | TUBE GUIDE |
| 8 | PAF20-04010001 | 69G-45331-01-CA | CUERPO DEL COJINETE | SHELL, BEARING | CORPO DE CUSCINETTO | LOGEMENT DE PALIER |
| 9 | REC626-45316-09 | 626-45316-09 | CASQUILLO EJE | BUSHER, SHAFT | GOMMINO ASSE | DOUILLE |
| 10 | REC93101-20048 | 93101-20001 | RETÉN DE ACEITE | OIL SEAL | PARAOILIO | JOINT D'HUILE |
| 11 | PAF20-04020000S | 6AH-44150-00 | VARILLA SELECTOR S | CAM ASSY, SHIFT ROD S | ASTICELLA CAMBIO S | LEVIER DE VITESSE S |
| | PAF20-04020000L | 6AH-44150-10 | VARILLA SELECTOR L | CAM ASSY, SHIFT ROD L | ASTICELLA CAMBIO L | LEVIER DE VITESSE L |
| 12 | REC93210-06ME6 | 93210-06ME6 | TÓRICA | O-RING | O-RING | JOINT TORIQUE |
| 13 | PAGB/T5783-M8X25 | 97080-08025 | TORNILLO | SCREW | VITE | VIS |

| | REF | OEM | | | | |
|----|------------------------------------|------------------------------|----------------------------------|--------------------------------|--|--|
| 14 | PAF20-04030000L PAF20-04030000S | 6AH-45510-10 6AH-45510-00 | EJE VERTICAL L EJE VERTICAL S | DRIVE SHAFT L DRIVE SHAFT S | ASSE VERTICALE L ASSE VERTICALE S | ARBRE DE COMMANDE L ARBRE DE COMMANDE S |
| 15 | REC664-44338-00 | 664-44338-00 | CUÑA | KEY WOODRUFF | CHIAVETTA | CLAVETTE |
| 16 | REC68T-44323-00 | 68T-44323-00 | JUNTA TAPA BOMBA AGUA | GASKET, WATER PUMP COVER | GUARNIZIONE COPERCHIO | JOINT COUVERCLE |
| 17 | REC93210-49046 | 93210-49046 | TÓRICA | O-RING | O-RING | JOINT TORIQUE |
| 18 | REC63V-44352-01 | 63V-44352-01 | TURBINA BOMBA AGUA | IMPELLER, WATER PUMP | GIRANTE POMPA | TURBINE DE POMPE À EAU |
| 19 | REC63V-44322-00 | 63V-44322-00 | TAPA, BOMBA AGUA | COVER, INNER WATER PUMP | COPERCHIO, POMPE ACQUA | COUVERCLE DE POMPE À EAU |
| 20 | PAF15-00000013 | 93604-12M07 | PASADOR BOMBA AGUA | PIN, WATER PUMP | SPINOTTO POMPA ACQUA | LEVIER POMPE D'EAU |
| 21 | PAF20-04040001 | 6AH-44311-00 | CUERPO BOMBA AGUA | HOUSING, WATER PUMP | CORPO POMPA | CORPS DE POMPE À EAU |
| 22 | PAF25-04050004 | 6L2-44367-00 | TUBO GOMA BOMBA AGUA | RUBBER TUBE, WATER PUMP | TUBO IN GOMMA, POMPA | DURITE DE COUTCHOU |
| 23 | PAF15-06000014 | 63V-44328-01 | PLACA | OUT PLATE | PIASTRA | PLAQUE |
| 24 | REC97095-08045 | 97095-08045 | PERNO | STUD | BULLONE | BOULON |
| 25 | PAF20-02000005 | 6AH-44368-00 | TUBO DE AGUA | WATER TUBE | TUBO DELL'ACQUA | DURITE D'EAU |
| 26 | PAF20-02000101L PAF20-02000101S | 6AH-44361-11 6AH-44361-01 | TUBO DE AGUA L TUBO DE AGUA S | WATER TUBE L WATER TUBE S | TUBO DELL'ACQUA L TUBO DELL'ACQUA S | DURITE D'EAU L DURITE D'EAU S |
| 27 | PAF20-02000007 | 6AH-44365-00 | GOMA DEL TUBO DE AGUA | I-SHAPED RUBBER BAND | GOMMA TUBO ACQUA | PLOT CAOUTCHOU DE TUBE D'EAU |
| 28 | PAHT-2.5X50 | 90465-11M10 | BRIDA 2,5X50 | CLAMP | FASCETTA | COLLIER RILSAN 2,5X50 |
| 29 | PAF15-06000010-1 | 664-45567-01 | GRUESO 0.10 mm | SHIM 0.10 mm | SPESSORE 0.10 mm | CALE 0.10 mm |
| | PAF15-06000010-2 | 664-45567-10 | GRUESO 0.12 mm | SHIM 0.12 mm | SPESSORE 0.12 mm | CALE 0.12 mm |
| | PAF15-06000010-3 | 664-45567-20 | GRUESO 0.15 mm | SHIM 0.15 mm | SPESSORE 0.15 mm | CALE 0.15 mm |
| | PAF15-06000010-4 | 664-45567-30 | GRUESO 0.18 mm | SHIM 0.18 mm | SPESSORE 0.18 mm | CALE 0.18 mm |
| | PAF15-06000010-5 | 664-45567-40 | GRUESO 0.30 mm | SHIM 0.30 mm | SPESSORE 0.30 mm | CALE 0.30 mm |
| | PAF15-06000010-6 | 664-45567-50 | GRUESO 0.40 mm | SHIM 0.40 mm | SPESSORE 0.40 mm | CALE 0.40 mm |
| | PAF15-06000010-7 | 664-45567-60 | GRUESO 0.50 mm | SHIM 0.50 mm | SPESSORE 0.50 mm | CALE 0.50 mm |
| 30 | REC93332-00005 | 93332-00005 | RODAMIENTO | BALL BEARING | CUSCINETTO | ROULEMENT À BILLE |
| 31 | REC6E7-45560-01 | 6E7-45560-01 | PIÑÓN MARCHA AVANTE | POSITIVE GEAR ASSY | PIGNONE MARCIA AVANTI | PIGNON DE MARCHÉ AVANT |
| 32 | REC650-45635-00 | 650-45635-00 | ÉMBOLO | PLUNGER | BULLONE | BOUCHON |
| 33 | REC682-45631-00 | 682-45631-00 | SELECTOR | CLUTCH BLOCK | SELETTORE | SELECTEUR |
| 34 | REC90250-05010 | 90250-05010 | PASADOR | PIN | SPINOTTO | LEVIER |
| 35 | REC648-45633-00 | 648-45633-11 | MUELLE | SPRING | MOLLA | RESSORT |
| 36 | PAF15-06070002 | 90501-150A0 | MUELLE | SPRING | MOLLA | RESSORT |
| 37 | REC683-45611-00 | 683-45611-00 | EJE HÉLICE | PROPELLER SHAFT | ASSE ELICA | ARBRE D'HELICE |
| 38 | REC90201-17682 | 90201-17682 | ARANDELA | WASHER | RONDELLA | RONDELLE |
| 39 | REC6E7-45570-00 | 6E7-45570-00 | PIÑÓN MARCHA ATRÁS | REVERSE GEAR | PIGNONE MARCIA INDIETRO | PIGNON MARCHE ARRIÈRE |
| 40 | PAF15-06080006-1 | 626-45577-00 | GRUESO 0.10 mm | SHIM 0.10 mm | SPESSORE 0.10 mm | CALE 0.10 mm |
| | PAF15-06080006-2 | 626-45577-10 | GRUESO 0.20 mm | SHIM 0.20 mm | SPESSORE 0.20 mm | CALE 0.20 mm |
| | PAF15-06080006-3 | 626-45577-20 | GRUESO 0.30 mm | SHIM 0.30 mm | SPESSORE 0.30 mm | CALE 0.30 mm |
| | PAF15-06080006-4 | 626-45577-30 | GRUESO 0.40 mm | SHIM 0.40 mm | SPESSORE 0.40 mm | CALE 0.40 mm |
| | PAF15-06080006-5 | 626-45577-40 | GRUESO 0.50 mm | SHIM 0.50 mm | SPESSORE 0.50 mm | CALE 0.50 mm |
| 41 | PAF15-06080000 | 683-45361-02-8D | FUNDA INFERIOR COMPLETA | COVER ASSY, LOWER CASING | COVER INFERIORE COMPLETA | DIABOLO COMPLET |
| 42 | REC93306-00501 | 93306-00501 | COJINETE | BEARING | CUSCINETTO | ROULEMENT |
| 43 | REC93210-57M09 | 93210-57M09 | TÓRICA | O-RING | O-RING | JOINT TORIQUE |
| 44 | PAF15-06080003 | 93210-56M80 | TÓRICA | O-RING | O-RING | JOINT TORIQUE |
| 45 | REC683-45361-01-4D | 683-45361-02-8D | DIÁBOLO | CAP, LOWER CASING | COPERCHIO CARTER INFERIORE | DIABOLO |
| 46 | PAGB/T5783-M6X20 | 97575-06520 | TORNILLO | SCREW | VITE | VIS |
| 47 | REC93315-317U2 | 93315-317U2 | COJINETE | BEARING | CUSCINETTO | PALIER |
| 48 | REC93101-17054 | 93101-17054 | RETÉN DE ACEITE | OIL SEAL | PARAOLIO | JOINT SPI |
| 49 | REC6E7-45987-00 | 6E7-45987-01 | ESPACIADOR | SPACER | DISTANZIALE | ENTRETOISE |
| 50 | PAGB/T96-10 | 90201-10M01 | ARANDELA | WASHER | RONDELLA | RONDELLE |
| 51 | REC90171-10M01 | 90171-10M01 | TUERCA | LOCK NUT | DADO | ÉCROU |
| 52 | REC91490-30025 | 94190-30020 | PASADOR ALETAS | PIN, COTTER | PIN | GOUPILLE |
| 53 | PAGB/T6182-M5 | 90185-05002 | TUERCA | LOCK NUT | DADO | ÉCROU |
| 54 | PAF15-06000002 | 63V-45215-00 | CUBIERTA, ENTRADA AGUA 2 | WATER INLET A | COPERCHIO ENTRATA ACQUA A | GRILLE D'ENTREE D'EAU A |
| 55 | PAF15-06000003 | 6G1-45214-00 | CUBIERTA, ENTRADA AGUA 1 | WATER INLET B | COPERCHIO ENTRATA ACQUA B | GRILLE D'ENTREE D'EAU B |
| 56 | PAGB/T820-M5X20 | 90152-05011 | TORNILLO | SCREW | VITE | VIS |
| 57 | PAF15-06000020-1 | 90201-15017 | ARANDELA | WASHER | RONDELLA | RONDELLE |
| 58 | PAF15-06000008 PAF15-06000009 | 6E8-45587-10 6E8-45587-30 | GRUESO 1.13 mm GRUESO 1.20 mm | SHIM 1.13 mm SHIM 1.20 mm | SPESSORE 1.13 mm SPESSORE 1.20 mm | CALE 1.13 mm CALE 1.20 mm |
| 59 | REC63V-45551-00 | 63V-45551-00 | PIÑÓN ATAQUE | INITIATIVE GEAR | MARCIA INIZIATIVA | PIGNON D'ATTAQUE |
| 60 | REC90179-08M06 | 90179-08M06 | TUERCA | LOCK NUT | DADO | ÉCROU |
| 61 | PAGB/T5783-M8X30 | 97575-08530 | PERNO | STUD | BULLONE | BOULON |
| 62 | TEN01154AL | 6AH-45251-00 | ÁNODO | ANODE | ANODO | ANODE |
| 63 | PAGB/T861.1-6 | 92990-06300 | ARANDELA | WASHER | RONDELLA | RONDELLE |
| 64 | PAGB/T5783-M6X30 | 95895-06035 | TORNILLO | SCREW | VITE | VIS |

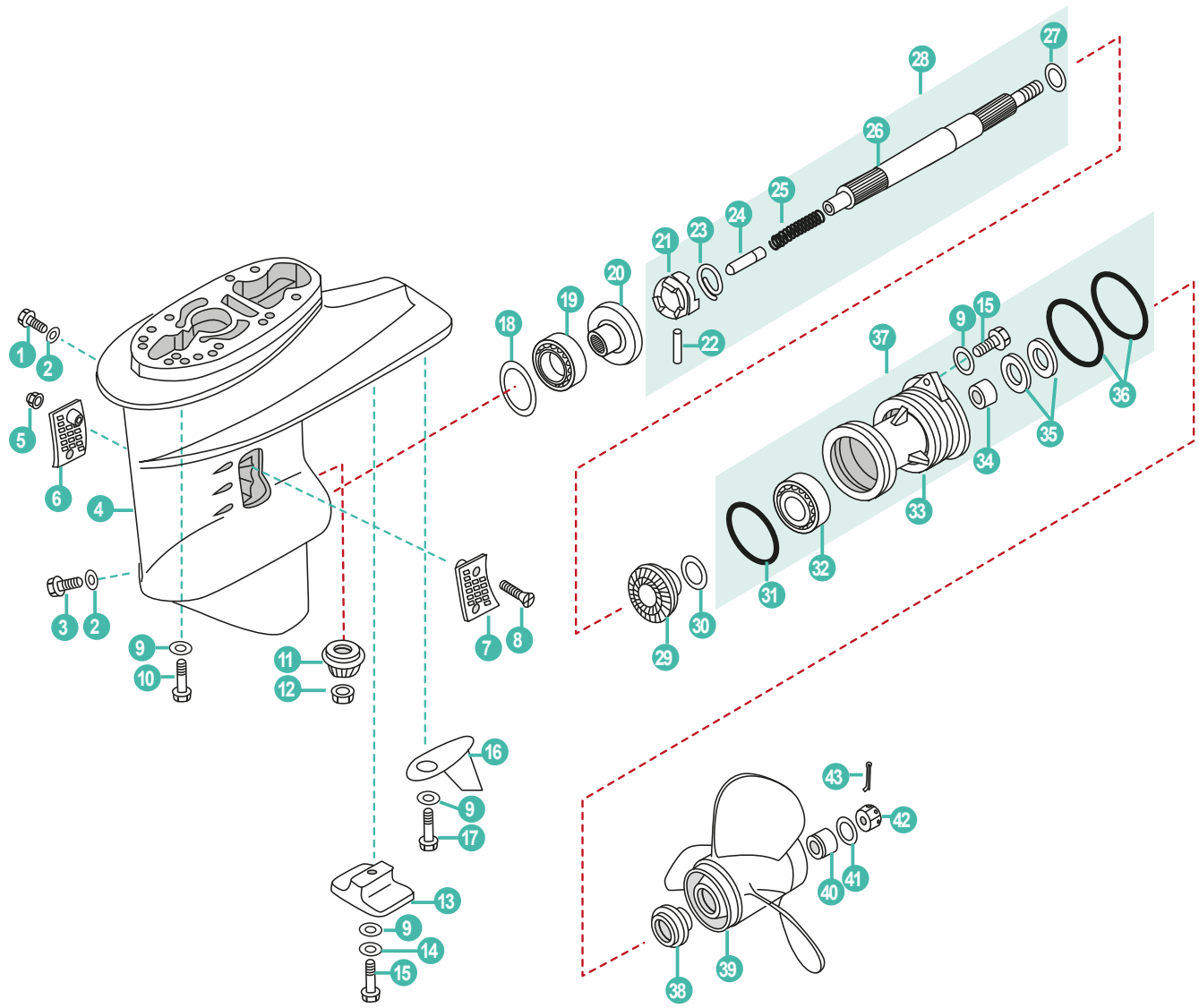

| | REF | OEM | | | | |
|----|-------------------|-----------------|-------------------------|--------------------------|----------------------------|-----------------------------|
| | PAF25-04090000L | 65W-45300-10-4D | COLA COMPLETA L | COMPLETE GEAR HOUSING L | PIEDE COMPLETO L | EMBASE COMPLETE L |
| | PAF25-04090000S | 65W-45300-00-4D | COLA COMPLETA S | COMPLETE GEAR HOUSING S | PIEDE COMPLETO S | EMBASE COMPLETE S |
| 1 | REC90340-08002 | 90340-08M04 | TAPÓN ACEITE | PLUG, OIL | TAPPO OLIO | BOUCHON REMPLISSAGE D'HUILE |
| 2 | REC90430-08020 | 93210-06ME6 | JUNTA | GASKET | GUANIZIONE | JOINT |
| 3 | REC688-45341-00 | 688-45341-00 | TAPÓN DE DESAGÜE | PLUG, DRAIN | TAPPO DRENAGGIO | BOUCHON DE VIDANGE |
| 4 | PAF25-04000001 | 61N-45311-02-4D | CARTER | LOWER CASING | CARTER | CARTER D'EMBASE |
| 5 | PAGB/T889.1-2000 | 90185-05002 | TUERCA | NUT, LOCKING | DADO | ÉCROU |
| 6 | PAF25-04000023 | 6L2-45215-00 | CUBIERTA ENTRADA AGUA B | WATER INLET B | COPERCHIO ACQUA B | GRILLE D'ENTREE D'EAU B |
| 7 | PAF25-04000022 | 6L2-45214-00 | CUBIERTA ENTRADA AGUA A | WATER INLET A | COPERCHIO ACQUA A | GRILLE D'ENTREE D'EAU A |
| 8 | PAGB/T820-M5X30 | 90151-05M05 | TORNILLO | SCREW, PAN HEAD | VITE | VIS |
| 9 | PAGB/T97.1-8 | 92995-10600 | ARANDELA | WASHER | RONDELLA | RONDELLE |
| 10 | PAF25-00000011 | 90105-10M12 | TORNILLO | BOLT | VITE | VIS |
| 11 | PAF25-04000005 | 61N-45551-00 | PIÑÓN ATAQUE | INITIATIVE GEAR | MARCIA INIZIATIVA | PIGNON D'ATTAQUE |
| 12 | REC90179-10M14 | 90179-10M14 | TUERCA | NUT, PINION | DADO | ÉCROU |
| 13 | PAF15-06000004 | 61N-45251-00 | ÁNODO | ANODE, LOWER | ANODO | ANODE |
| 14 | PAGB/T861.1-87 | 92990-06300 | ARANDELA | WASHER, LOCKING | RONDELLA | RONDELLE |
| 15 | PAGB/T5782-M6X125 | 95895-06035 | TORNILLO | BOLT | VITE | VIS |
| 16 | PAF25-04000021 | 61N-45214-00 | PLACA TIMÓN | TAB, COURSE | PIASTRA TIMONE | DERIVE |
| 17 | PAGB/T5783-M5X12 | 90119-06M48 | TORNILLO | BOLT | VITE | VIS |
| 18 | PAF25-04000004-3 | 6L2-45567-12 | GRUESO 1.2 mm | SHIM 1.2 mm | SPESSORE 1.2 mm | CALE 1.2 mm |
| | PAF25-04000004-5 | 6L2-45567-14 | GRUESO 1.4mm | SHIM 1.4 mm | SPESSORE 1.4 mm | CALE 1.4 mm |
| 19 | REC93332-00005 | 93332-00005 | RODAMIENTO | BALL BEARING | CUSCINETTO | ROULEMENT À BILLE |
| 20 | REC61N-45560-10 | 61N-45560-00 | PIÑÓN MARCHA AVANTE | POSITIVE GEAR ASSY | PIGNONE MARCIA AVANTI | PIGNON DE MARCHÉ AVANT |
| 21 | PAF25-04060003 | 664-45631-02 | SELECTOR | CLUTCH BLOCK | SELETTORE | CRABOT |
| 22 | REC90250-05010 | 90250-05010 | PASADOR | PIN | SPINOTTO | LEVIER |
| 23 | REC648-45633-00 | 648-45633-00 | MUELLE | SPRING | MOLLA | RESSORT |
| 24 | REC648-45635-00 | 648-45635-00 | ÉMBOLO | PLUNGER | BULLONE | BOUCHON |
| 25 | PAF25-04060002 | 90501-10065 | MUELLE | SPRING | MOLLA | RESSORT |
| 26 | REC6L2-45611-00 | 612-45611-00 | EJE HÉLICE | PROPELLER SHAFT | ASSE ELICA | ARBRE D'HELICE |
| 27 | PAF25-04060007 | 90201-20417 | GRUESO | SHIM | SPESSORE | CALE |
| 28 | PAF25-04060000 | 648-45633-11 | EJE HÉLICE COMPELTO | PROPELLER, SHAFT ASSY | ASSE ELICHE COMPLETO | ARBRE D'HELICE COMPLÈTE |
| 29 | PAF25-04070004 | 61N-45571-00 | PIÑÓN MARCHA INVERSA | GEAR, REVERSE | MARCIA INDIETRO | PIGNON MARCHÉ ARRIÈRE |
| 30 | PAF25-04070005-1 | 6L2-45577-00-10 | GRUESO 1.0 mm | SHIM 1.0 mm | SPESSORE 1.0 mm | CALE 1.0 mm |
| | PAF25-04070005-3 | 6L2-45577-00-12 | GRUESO 1.2 mm | SHIM 1.2 mm | SPESSORE 1.2 mm | CALE 1.2 mm |
| 31 | REC93210-64ME7 | 93210-64ME7 | TÓRICA | O-RING | O-RING | JOINT TORIQUE |
| 32 | PAGB/T276-6006/P6 | 93306-00612 | RODAMIENTO | BALL BEARING | CUSCINETTO | ROULEMENT À BILLE |
| 33 | PAF25-04070001 | 61N-45361-01-4D | DIÁBOLO | CAP, LOWER CASING | COPERCHIO CARTER INFERIORE | DIABOLO |
| 34 | REC93315-22004 | 93315-22004 | RODAMIENTO | BALL BEARING | CUSCINETTO | ROULEMENT À BILLE |
| 35 | REC93101-20M07 | 93101-20M07 | RETÉN DE ACEITE | OIL SEAL | PARAOLIO | JOINT SPI |
| 36 | REC93210-65M50 | 93210-65M50 | TÓRICA | O-RING | O-RING | JOINT TORIQUE |
| 37 | PAF25-04070000 | 61N-45361-01-8D | TAPA CÁRTER COMPLETA | COVER ASSY, LOWER CASING | COPERCHIO CARTER COMPLETA | DIABOLO COMPLET |
| 38 | REC6L2-45987-00 | 6L2-45987-01 | ESPACIADOR | SPACER, PROPELLER | SPESSORE | ENTRETOISE |
| 39 | PAF25-04080000 | 664-45947-01-EL | HÉLICE | PROPELLER ASSY | ELICHE | HELICE |
| 40 | REC689-45997-00 | 689-45997-00 | ESPACIADOR | SPACER | SPESSORE | ENTRETOISE |
| 41 | PAGB/T97.1-8 | 92990-14200 | ARANDELA | WASHER | RONDELLA | RONDELLE |
| 42 | REC90171-14013-00 | 90171-14013 | TUERCA | NUT | DADO | ÉCROU |
| 43 | PAGB/T91-1.6X12 | 91490-30022 | PIN | PIN, COTTER | SPINOTTO | GOUPILLE |

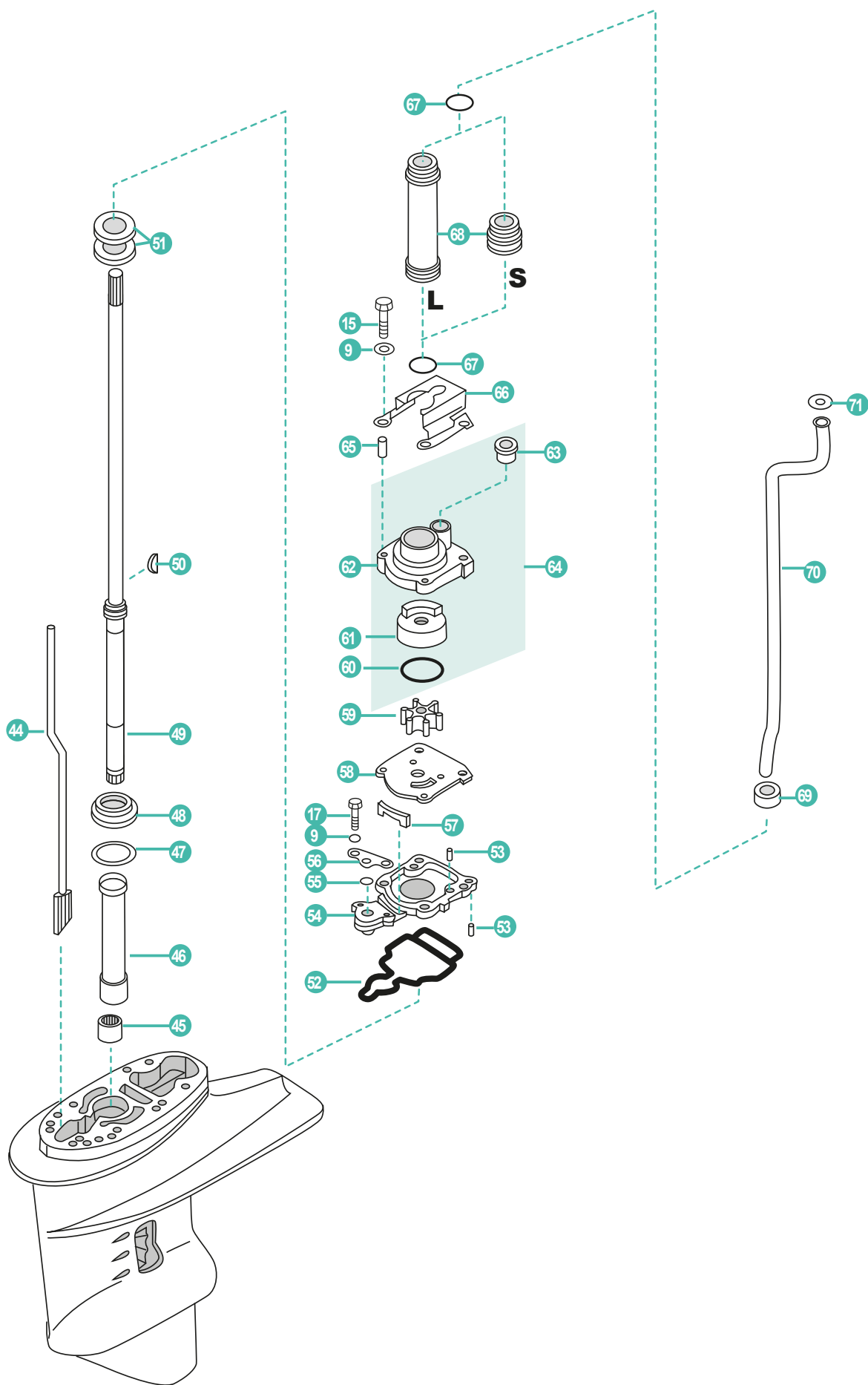

| | REF | OEM | | | | |
|----|------------------------------------|------------------------------|--|--|--|--|
| 44 | PAF25-04030000L PAF25-04030000S | 65W-44150-10 65W-44150-00 | VARILLA SELECTOR L VARILLA SELECTOR S | CAM ASSY, SHIFT ROD L CAM ASSY, SHIFT ROD S | ASTICELLA CAMBIO L ASTICELLA CAMBIO S | LEVIER DE VITESSE L LEVIER DE VITESSE S |
| 45 | PAGB/T290F-2020 | 93315-220V7 | RODAMIENTO | BALL BEARING | CUSCINETTO | ROULEMENT À BILLE |
| 46 | PAF25-04000002 | 61N-45536-00 | CASQUILLO | BUSHING, NYLON | GHIERA | BAGUE NYLON |
| | PAF25-04000003-2 | 61N-45587-00-10 | GRUESO 1.0 mm | SHIM 1.0 mm | SPESSORE 1.0 mm | CALE 1.0 mm |
| | PAF25-04000003-3 | 61N-45587-00-11 | GRUESO 1.1 mm | SHIM 1.1 mm | SPESSORE 1.1 mm | CALE 1.1 mm |
| 47 | PAF25-04000003-4 | 61N-45587-00-12 | GRUESO 1.2 mm | SHIM 1.2 mm | SPESSORE 1.2 mm | CALE 1.2 mm |
| | PAF25-04000003-5 | 61N-45587-00-13 | GRUESO 1.3 mm | SHIM 1.3 mm | SPESSORE 1.3 mm | CALE 1.3 mm |
| | PAF25-04000003-6 | 61N-45587-00-14 | GRUESO 1.4mm | SHIM 1.4 mm | SPESSORE 1.4 mm | CALE 1.4 mm |
| | PAF25-04000003-7 | 61N-45587-00-15 | GRUESO 1.5mm | SHIM 1.5 mm | SPESSORE 1.5 mm | CALE 1.5 mm |
| 48 | PAHI-CAP32004JRK0YO | 93332-000W5 | CUERPO RODAMIENTO | HOUSING, BEARING | CORPO CUSCINETTO | LOGEMENT DE ROULEMENT |
| 49 | PAF25-04010000L PAF25-04010000S | 61N-45510-10 61N-45510-00 | EJE VERTICAL L EJE VERTICAL S | DRIVE SHAFT L DRIVE SHAFT S | ASSE VERTICALE L ASSE VERTICALE S | ARBRE DE COMMANDE L ARBRE DE COMMANDE S |
| 50 | PAF25-04000015 | 90280-03024 | CHAVETA | KEY WOODRUFF | CHIAVETTA | CLAVETTE |
| 51 | REC93101-22M00 | 93101-22067 | RETÉN DE ACEITE | OIL SEAL | PARAOILIO | JOINT D'HUILE |
| 52 | PAF25-04000009 | 61N-45315-00 | RETÉN | SEAL | TENUTA | JOINT |
| 53 | PAF25-04000007 | 93604-10M03 | PIN | PIN, COTTER | SPINOTTO | PLOT DE CENTRAGE F4X12 |
| 54 | PAF25-04000008 | 65W-45331-00-5B | BASE EJE VERTICAL | BASE, DRIVE SHAFT | BASE, ASSE VERTICALE | BASE POUR ARBRE D'ENTRAÎNEMENT |
| 55 | REC93210-06ME6 | 93210-06ME6 | TÓRICA | O-RING | O-RING | JOINT TORIQUE |
| 56 | PAF25-04000012 | 65W-44176-00 | PLACA | OUT PLATE | PIASTRA | PLAQUE |
| 57 | PAF25-04000013 | 61N-45127-00 | RETÉN AGUA | WATER SEAL | PARAOILIO ACQUA | RONDELLE JOINT |
| 58 | REC61N-44323-00 | 61N-44323-00 | JUNTA TAPA BOMBA AGUA | GASKET, WATER PUMP COVER | GUARNIZIONE COPERCHIO | JOINT COUVERCLE |
| 59 | REC6H4-44352-02 | 6H4-44352-02 | TURBINA BOMBA AGUA | IMPELLER, WATER PUMP | GIRANTE POMPA | TURBINE DE POMPE À EAU |
| 60 | PAF25-04050003 | 93210-45161 | TÓRICA | O-RING | O-RING | JOINT TORIQUE |
| 61 | REC61N-44322-00 | 61N-44322-01 | ACOPLE INOX | INSERT CARTRIDGE | ACCOPPIAMENTO INOX | INSERT DE POMPE À EAU |
| 62 | PAF25-04050001 | 61N-44311-01 | CUERPO BOMBA | SHELL, WATER PUMP | CORPO POMPA | CORPS DE POMPE À EAU |
| 63 | PAF25-04050004 | 6L2-44367-00 | RETÉN TUBO AGUA | DAMPER, WATER PIPE | AMMORTIZZATORE, TUBO DELL'ACQUA | MANCHON TUYAU D'EAU |
| 64 | PAF25-04050000 | 61N-44311-01 | KIT CUERPO BOMBA | SHELL ASSY, WATER PUMP | KIT CORPO POMPA | KIT COPRS DE POMPE À EAU |
| 65 | REC93606-12019 | 93606-11M24 | PIN | PIN, DOWEL | SPINOTTO | PLOT DE CENTRAGE |
| 66 | PAF25-04000016 | 65W-44328-00 | PLATO FIJO BOMBA AGUA | FIXED PLATE, WATER PUMP | PIASTRA POMPA | PLAQUE FIXATION CORPS DE POMPE À EAU |
| 67 | PAGB/T3452.1-25.8X2 | 93210-26130 | TÓRICA | O-RING | O-RING | JOINT TORIQUE |
| 68 | PAF25-04000017 PAF25-04000017S | 61N-44362-10 61N-44362-00 | TUBO DE AGUA L TUBO DE AGUA S | WATER TUBE L WATER TUBE S | TUBO DELL'ACQUA L TUBO DELL'ACQUA S | DURITE D'EAU L DURITE D'EAU S |
| 69 | PAF25-02000005 | 90430-12072 | JUNTA AGUA | GASKET, WATER PIPE | GUARNIZIONE | JOINT |
| 70 | PAF25-02000004L PAF25-02000004S | 65W-44361-10 65W-44361-00 | TUBO DE AGUA L TUBO DE AGUA S | WATER TUBE L WATER TUBE S | TUBO DELL'ACQUA L TUBO DELL'ACQUA S | DURITE D'EAU L DURITE D'EAU S |
| 71 | PAF25-02000019 | 90202-12060 | ARANDELA | WASHER, NYLON | RONDELLA | RONDELLE |

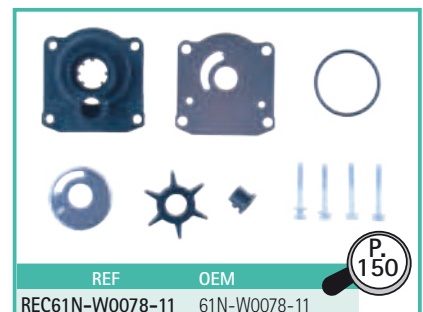

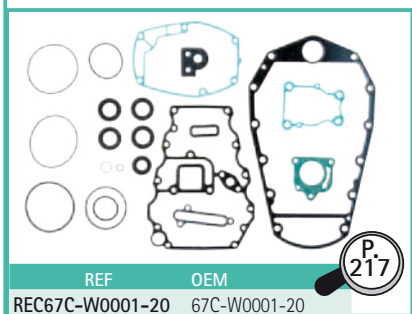
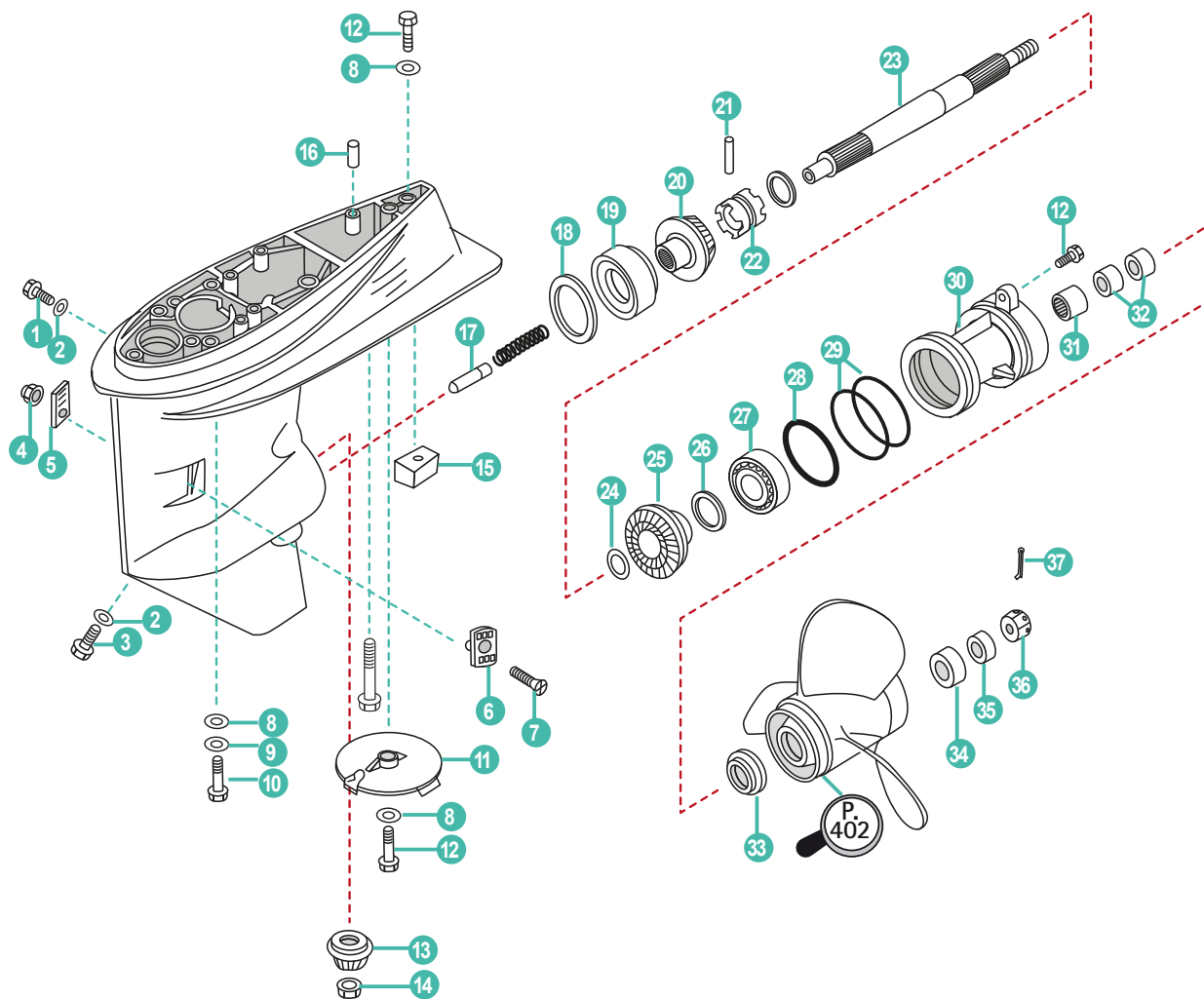

| | REF | OEM | | | | |
|----|--------------------|-----------------|-------------------------|--------------------|----------------------------|-----------------------------|
| 1 | REC90340-08002 | 90340-08002 | TAPÓN ACEITE | PLUG, OIL | TAPPO OLIO | BOUCHON DE NIVEAU D'HUILE |
| 2 | REC90430-08020 | 90430-08020 | JUNTA | GASKET | GUARNIZIONE | JOINT |
| 3 | REC688-45341-00 | 688-45341-10 | TAPÓN ACEITE | PLUG, OIL | TAPPO OLIO | BOUCHON REMPLISSAGE D'HUILE |
| 4 | PAGB/T889.1-M5 | 95380-05600 | TUERCA | LOCK NUT | DADO | ÉCROU |
| 5 | PAT40-04000023 | 63D-45215-00 | CUBIERTA ENTRADA AGUA B | WATER INLET B | COPERCHIO ACQUA B | GRILLE D'ENTREE D'EAU B |
| 6 | PAT40-04000022 | 63D-45214-00 | CUBIERTA ENTRADA AGUA A | WATER INLET A | COPERCHIO ACQUA A | GRILLE D'ENTREE D'EAU A |
| 7 | PAGB/T820-M5X30 | 90142-05M06 | TORNILLO | SCREW | VITE | VIS |
| 8 | PAGB/T97.1-8 | 92995-10600 | ARANDELA | WASHER | RONDELLA | RONDELLE |
| 9 | PAGB/T97.1-10 | 92995-10100 | ARANDELA | WASHER | RONDELLA | RONDELLE |
| 10 | REC97075-10040 | 97075-10040 | PERNO | STUD | BULLONE | BOULON |
| 11 | CM67C-45371-00A | 67C-45371-00 | ÁNODO | ANODE | ANODO | ANODE |
| 12 | PAGB/T5783-M8X25 | 97095-08025 | PERNO | STUD | BULLONE | BOULON |
| 13 | REC66T-45551-00 | 66T-45551-00 | PIÑÓN ATAQUE | INITIATIVE GEAR | MARCIA INIZIATIVA | PIGNON D'ATTAQUE |
| 14 | REC90170-12138 | 90170-12138 | TUERCA | LOCK NUT | DADO | ÉCROU |
| 15 | CM67C-45251-00A | 67C-45251-00 | ÁNODO | ANODE | ANODO | ANODE |
| 16 | REC93606-12019 | 93606-12019 | PASADOR | PIN | SPINOTTO | LEVIER |
| 17 | REC66T-45635-00 | 66T-45635-00 | ÉMBOLO | PLUNGER | BULLONE | BOUCHON |
| | PAT40-04000004-1 | 663-45567-01 | GRUESO 0.10 mm | SHIM 0.10 mm | SPESSORE 0.10 mm | CALE 0.10 mm |
| 18 | PAT40-04000004-2 | 663-45567-10 | GRUESO 0.12 mm | SHIM 0.12 mm | SPESSORE 0.12 mm | CALE 0.12 mm |
| | PAT40-04000004-3 | 663-45567-20 | GRUESO 0.15 mm | SHIM 0.15 mm | SPESSORE 0.15 mm | CALE 0.15 mm |
| | PAT40-04000004-5 | 663-45567-40 | GRUESO 0.30 mm | SHIM 0.30 mm | SPESSORE 0.30 mm | CALE 0.30 mm |
| 19 | REC93332-00003 | 93332-00003 | COJINETE | BEARING | CUSCINETTO | PALIER |
| 20 | REC66T-45560-00 | 66T-45560-01 | PIÑÓN MARCHA AVANTE | POSITIVE GEAR ASSY | PIGNONE MARCIA AVANTI | PIGNON DE MARCHÉ AVANT |
| 21 | REC90250-06023 | 90250-06023 | PASADOR | PIN | SPINOTTO | PIN |
| 22 | REC66T-45631-00 | 66T-45631-00 | SELECTOR | CLUTCH BLOCK | SELETTORE | CRABOT |
| 23 | REC66T-45611-00 | 66T-45611-00 | EJE HÉLICE | PROPELLER SHAFT | ASSE ELICA | ARBRE D'HELICE |
| 24 | REC90201-22429 | 90201-22429 | ARANDELA | WASHER | RONDELLA | RONDELLE |
| 25 | REC66T-45571-00 | 66T-45571-00 | PIÑÓN MARCHA ATRÁS | REVERSE GEAR | PIGNONE MARCIA INDIETRO | PIGNON MARCHÉ ARRIÈRE |
| | PAT40-04060005-2 | 63D-45577-10 | GRUESO 0.12 mm | SHIM 0.12 mm | SPESSORE 0.12 mm | CALE 0.12 mm |
| | PAT40-04060005-3 | 63D-45577-20 | GRUESO 0.15 mm | SHIM 0.15 mm | SPESSORE 0.15 mm | CALE 0.15 mm |
| 26 | PAT40-04060005-4 | 63D-45577-30 | GRUESO 0.18 mm | SHIM 0.18 mm | SPESSORE 0.18 mm | CALE 0.18 mm |
| | PAT40-04060005-5 | 63D-45577-40 | GRUESO 0.30 mm | SHIM 0.30 mm | SPESSORE 0.30 mm | CALE 0.30 mm |
| | PAT40-04060005-6 | 63D-45577-50 | GRUESO 0.40 mm | SHIM 0.40 mm | SPESSORE 0.40 mm | CALE 0.40 mm |
| | PAT40-04060005-7 | 63D-45577-60 | GRUESO 0.50 mm | SHIM 0.50 mm | SPESSORE 0.50 mm | CALE 0.50 mm |
| 27 | REC93306-001U1 | 93306-001U1 | COJINETE | BEARING | CUSCINETTO | PALIER |
| 28 | REC93210-69MG6 | 93210-69MG6 | TÓRICA | O-RING | O-RING | JOINT TORIQUE |
| 29 | REC93210-74MG5 | 93210-74MG5 | TÓRICA | O-RING | O-RING | JOINT TORIQUE |
| 30 | REC63D-45361-02-4D | 63D-45361-02-4D | DIÁBOLO | CAP, LOWER CASING | COPERCHIO CARTER INFERIORE | DIABOLO |
| 31 | REC93317-22204 | 93317-22204 | COJINETE | BEARING | CUSCINETTO | PALIER |
| 32 | REC93101-22M00 | 93101-22M00 | RETÉN DE ACEITE | OIL SEAL | PARAOLIO | JOINT SPI |
| 33 | REC663-45987-00 | 663-45987-02 | ESPACIADOR | SPACER | DISTANZIALE | ENTRETOISE |
| 34 | REC66T-45997-00 | 66T-45997-00 | ESPACIADOR | SPACER | DISTANZIALE | ENTRETOISE |
| 35 | REC90389-22M01 | 90389-22M01 | CASQUILLO HÉLICE | WASHER | GHIERA ELICA | RONDELLE D'HELICE |
| 36 | REC90171-16011 | 90171-16011 | TUERCA | LOCK NUT | DADO | ÉCROU |
| 37 | REC91490-30025 | 91490-30025 | PASADOR | PIN | SPINOTTO | LEVIER |

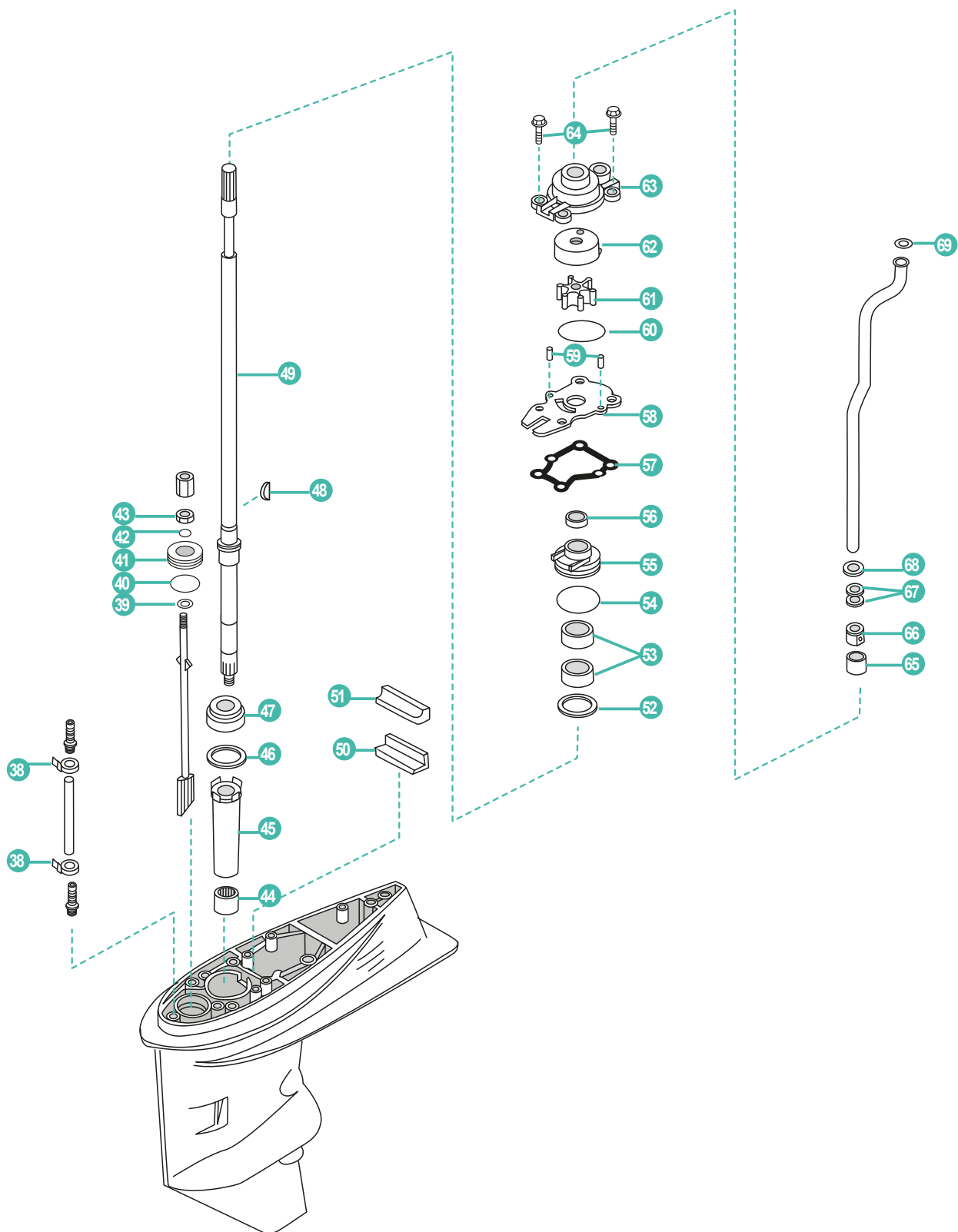

| | REF | OEM | | | | |
|----|------------------|-----------------|--------------------------------|---------------------------|------------------------|----------------------------------|
| 38 | PAHT-2.5X60 | 90465-11M10 | BRIDA | CLAMP | FLANGIA | COLLIER |
| 39 | PAGB/T97.1-6 | 92990-06600 | ARANDELA | WASHER | RONDELLA | RONDELLE |
| 40 | REC93210-33MG4 | 93210-33MG4 | TÓRICA | O-RING | O-RING | JOINT TORIQUE |
| 41 | PAT40-04000007 | 66T-45321-00 | PLACA | COVER PLATE, CAMSHAFT | PLACCA | COUVERCLE |
| 42 | REC93210-06ME6 | 93210-06ME6 | TÓRICA | O-RING | O-RING | JOINT TORIQUE |
| 43 | REC95380-06700 | 95380-06700 | TUERCA | LOCK NUT | DADO | ÉCROU |
| 44 | REC93315-32224 | 93315-32224 | COJINETE | BEARING | CUSCINETTO | PALIER |
| 45 | PAT40-04000002 | 6H4-45536-00 | CAMISA EJE | SLEEVE, DRIVE | TUBO GUIDA | BAGUE NYLON |
| | PAT40-04000003-1 | 663-45587-01 | GRUESO 0.10 mm | SHIM 0.10 mm | SPESSORE 0.10 mm | CALE 0.10 mm |
| | PAT40-04000003-2 | 663-45587-10 | GRUESO 0.12 mm | SHIM 0.12 mm | SPESSORE 0.12 mm | CALE 0.12 mm |
| | PAT40-04000003-3 | 663-45587-20 | GRUESO 0.15 mm | SHIM 0.15 mm | SPESSORE 0.15 mm | CALE 0.15 mm |
| 46 | PAT40-04000003-4 | 663-45587-30 | GRUESO 0.18 mm | SHIM 0.18 mm | SPESSORE 0.18 mm | CALE 0.18 mm |
| | PAT40-04000003-5 | 663-45587-40 | GRUESO 0.30 mm | SHIM 0.30 mm | SPESSORE 0.30 mm | CALE 0.30 mm |
| | PAT40-04000003-6 | 663-45587-50 | GRUESO 0.40 mm | SHIM 0.40 mm | SPESSORE 0.40 mm | CALE 0.40 mm |
| | PAT40-04000003-7 | 663-45587-60 | GRUESO 0.50 mm | SHIM 0.50 mm | SPESSORE 0.50 mm | CALE 0.50 mm |
| 47 | REC93332-00001 | 93332-00001 | COJINETE | BEARING | CUSCINETTO | ROULEMENT |
| 48 | REC90280-03M03 | 90280-03M03 | CHAVETA | KEY WOODRUFF | CHIAVETTA | CLAVETTE |
| 49 | REC67C-45501-10 | 67C-45501-10 | EJE VERTICAL L | DRIVE SHAFT L | ASSE VERTICALE L | ARBRE DE COMMANDE L |
| | REC67C-45501-00 | 67C-45501-00 | EJE VERTICAL S | DRIVE SHAFT S | ASSE VERTICALE S | ARBRE DE COMMANDE S |
| 50 | REC663-45376-00 | 663-45376-00-94 | GUÍA SELLO DE GOMA | GUIDE RUB. SEAL | GUIDA PARAOLIO | GUIDE |
| 51 | PAT40-04000014 | 63D-45375-00 | SELLO DE GOMA | WATER ENVELOP | PARAOLIO | PROTECTION TUYAU D'EAU |
| 52 | PAT40-04000008 | 90201-27M00 | ARANDELA | WASHER | RONDELLA | RONDELLE |
| 53 | REC93101-22M60 | 93101-22M60 | RETÉN DE ACEITE | OIL SEAL | PARAOLIO | JOINT SPI |
| 54 | REC93210-48MG8 | 93210-48MG8 | TÓRICA | O-RING | O-RING | JOINT TORIQUE |
| 55 | REC63D-44341-00 | 63D-44341-00 | CUERPO BOMBA DE AGUA | SHELL, WATER PUMP | CORPO POMPA | INSERT POMPE À EAU |
| 56 | PAT40-04000009 | 66T-45344-01 | CUBIERTA SELLO DE ACEITE | COVER, OIL SEAL | COPERCHIO, PARAOLIO | JOINT SPI |
| 57 | REC63D-44316-00 | 63D-44316-00 | JUNTA | GASKET | GUARNIZIONE | JOINT |
| 58 | REC66T-44323-00 | 66T-44323-00 | PLACA EXTERIOR | OUTER PLATE | PIASTRA POMPA ACQUA | PLAQUE DE POMPE À EAU |
| 59 | PAF25-04000007 | 93604-08062 | PASADOR | PIN | SPINOTTO | PIN |
| 60 | REC93210-59MG7 | 93210-59MG7 | TÓRICA | O-RING | O-RING | JOINT TORIQUE |
| 61 | REC6H4-44352-02 | 6H4-44352-02 | TURBINA | IMPELLER | GIRANTE | TURBINE |
| 62 | REC63D-44322-00 | 63D-44322-00 | TAPA, BOMBA AGUA | COVER, INNER WATER PUMP | COPERCHIO, POMPE ACQUA | COUVERCLE, POMPE D'EAU |
| 63 | PAT40-04000201 | 66T-44311-00 | CUERPO BOMBA AGUA | HOUSING, WATER PUMP | CORPO POMPA | LOGEMENT POMPE D'EAU |
| 64 | REC90119-08M15 | 90119-08M15 | TORNILLO CON ARANDELA | SCREW WITH WASHER | VITE CON RONDELLA | VIS AVEC RONDELLE |
| 65 | REC663-44366-00 | 663-44366-00 | GOMA DEL SELLO DE AGUA | DAMPER, WATER SEAL | GHIERA | JOINT DE TUBE D'EAU |
| 66 | REC63D-44312-00 | 63D-44312-00 | CUBIERTA CAJA DE BOMBA DE AGUA | PUMP COVER | COPERCHIO POMPA ACQUA | PLAQUE POMPE À EAU |
| 67 | PAT40-02000002 | 663-44367-00 | GOMA DEL SELLO DE AGUA | GUIDE BUSHING, WATER PIPE | PARAOLIO | MAUCHON CAOUTCHOUC DE PIPE D'EAU |
| 68 | REC90430-12072 | 90430-12072 | JUNTA | GASKET | GUARNIZIONE | JOINT |
| 69 | PAF25-02000019 | 90202-12060 | ARANDELA PLANA | WASHER | RONDELLA PIANA | RONDELLE |

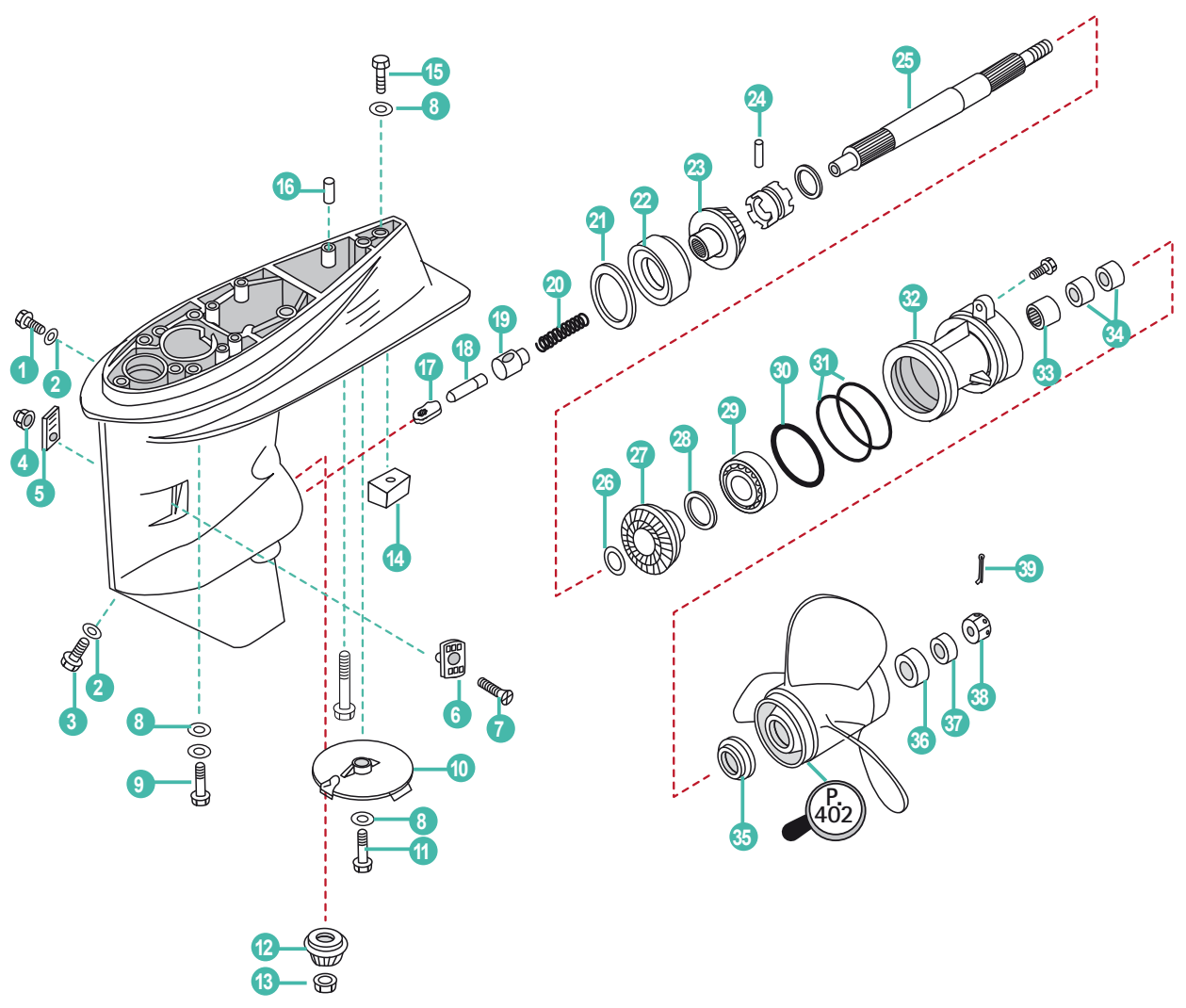

| REF | OEM |
|-----------------|--------------|
| REC6BG-W0078-00 | 6BG-W0078-00 |

P. 151

| REF |
|------------|
| REC80W90U3 |
| REC80W90U6 |
| RECGREU1 |
| RECGREU12 |

P. 43

| | REF | OEM | | | | |
|----|--------------------|-----------------|-------------------------|-----------------------|----------------------------|-------------------------|
| 1 | REC90340-08002 | 90340-08002 | TORNILLO DRENAJE | BOLT, DISCHARGING OIL | VITE DRENAGGIO | BOUCHON DE VIDANGE |
| 2 | REC90430-08020 | 90430-08003 | JUNTA | GASKET | GUARNIZIONE | JOINT |
| 3 | REC688-45341-00 | 688-45341-10 | TORNILLO DRENAJE | BOLT, DISCHARGING OIL | VITE DRENAGGIO | BOUCHON DE VIDANGE |
| 4 | PAGB/T889.1-M5 | 95380-05600 | TUERCA | LOCK NUT | DADO | ÉCROU |
| 5 | PAT40-04000023 | 63D-45215-00 | CUBIERTA ENTRADA AGUA B | WATER INLET B | COPERCHIO ACQUA B | GRILLE D'ENTREE D'EAU B |
| 6 | PAT40-04000022 | 63D-45214-00 | CUBIERTA ENTRADA AGUA A | WATER INLET A | COPERCHIO ACQUA A | GRILLE D'ENTREE D'EAU A |
| 7 | PAGB/T820-M5X30 | 90152-05010 | TORNILLO | SCREW | VITE | VIS |
| 8 | PAGB/T97.1-8 | 92995-10600 | ARANDELA | WASHER | RONDELLA | RONDELLE |
| 9 | REC97075-10040 | 97075-10040 | PERNO | STUD | BULLONE | BOULON |
| 10 | CM67C-45371-00A | 67C-45371-00 | ÁNODO | ANODE | ANODO | ANODE |
| 11 | PAGB/T5783-M8X25 | 97095-08025 | PERNO | STUD | BULLONE | BOULON |
| 12 | REC66T-45551-00 | 66T-45551-00 | PIÑÓN ATAQUE | INITIATIVE GEAR | MARCIA INIZIATIVA | PIGNON D'ATTAQUE |
| 13 | REC90170-12138 | 90170-12138 | TUERCA | LOCK NUT | DADO | ÉCROU |
| 14 | CM67C-45251-00A | 67C-45251-00 | ÁNODO | ANODE | ANODO | ANODE |
| 15 | PAGB/T5783-M8X35 | 97095-08035 | PERNO | STUD | BULLONE | BOULON |
| 16 | REC93606-12019 | 93606-12019 | PASADOR | PIN | SPINOTTO | LEVIER |
| 17 | PAF60-04000003 | 62Y-44151-00 | LEVA DE CAMBIO | SHIFTING CAM | LEVA CAMBIO | CAME DE CHANGEMENT |
| 18 | PAF60-04020005 | 63D-45635-00 | ÉMBOLO | PLUNGER | BULLONE | BOUCHON |
| 19 | REC663-45634-00 | 663-45634-00 | DESILIZADOR DEL CAMBIO | CLUTCH DOG | TRAINABILE CAMBIO | PIVOT |
| 20 | PAF60-04020002 | 90501-18001 | MUELLE | SPRING | MOLLA | RESSORT |
| | PAT40-04000004-1 | 663-45567-01 | GRUESO 0.10 mm | SHIM 0.10 mm | SPESSORE 0.10 mm | CALE 0.10 mm |
| 21 | PAT40-04000004-2 | 663-45567-10 | GRUESO 0.12 mm | SHIM 0.12 mm | SPESSORE 0.12 mm | CALE 0.12 mm |
| | PAT40-04000004-3 | 663-45567-20 | GRUESO 0.15 mm | SHIM 0.15 mm | SPESSORE 0.15 mm | CALE 0.15 mm |
| | PAT40-04000004-5 | 663-45567-40 | GRUESO 0.30 mm | SHIM 0.30 mm | SPESSORE 0.30 mm | CALE 0.30 mm |
| 22 | REC93332-00003 | 93332-00003 | COJINETE | BEARING | CUSCINETTO | ROULEMENT |
| 23 | REC66T-45560-00 | 66T-45560-01 | PIÑÓN MARCHA AVANTE | POSITIVE GEAR ASSY | PIGNONE MARCIA AVANTI | PIGNON DE MARCHE AVANT |
| 24 | REC90250-06023 | 90250-06023 | PASADOR | PIN | SPINOTTO | PIN |
| 25 | PAF60-04020001 | 63D-45611-00 | EJE HÉLICE | PROPELLER SHAFT | ASSE ELICA | ARBRE D'HELICE |
| 26 | REC90201-22429 | 90201-22429 | ARANDELA | WASHER | RONDELLA | RONDELLE |
| 27 | REC66T-45571-00 | 66T-45571-00 | PIÑÓN MARCHA ATRÁS | REVERSE GEAR | PIGNONE MARCIA INDIETRO | PIGNON MARCHE ARRIÈRE |
| | PAT40-04060005-2 | 63D-45577-10 | GRUESO 0.12 mm | SHIM 0.12 mm | SPESSORE 0.12 mm | CALE 0.12 mm |
| | PAT40-04060005-3 | 63D-45577-20 | GRUESO 0.15 mm | SHIM 0.15 mm | SPESSORE 0.15 mm | CALE 0.15 mm |
| 28 | PAT40-04060005-4 | 63D-45577-30 | GRUESO 0.18 mm | SHIM 0.18 mm | SPESSORE 0.18 mm | CALE 0.18 mm |
| | PAT40-04060005-5 | 63D-45577-40 | GRUESO 0.30 mm | SHIM 0.30 mm | SPESSORE 0.30 mm | CALE 0.30 mm |
| | PAT40-04060005-6 | 63D-45577-50 | GRUESO 0.40 mm | SHIM 0.40 mm | SPESSORE 0.40 mm | CALE 0.40 mm |
| | PAT40-04060005-7 | 63D-45577-60 | GRUESO 0.50 mm | SHIM 0.50 mm | SPESSORE 0.50 mm | CALE 0.50 mm |
| 29 | REC93306-001U1 | 93306-001U1 | COJINETE | BEARING | CUSCINETTO | ROULEMENT |
| 30 | REC93210-69MG6 | 93210-69MG6 | TÓRICA | O-RING | O-RING | JOINT TORIQUE |
| 31 | REC93210-74MG5 | 93210-74MG5 | TÓRICA | O-RING | O-RING | JOINT TORIQUE |
| 32 | REC63D-45361-02-4D | 63D-45361-02-8D | DIÁBOLO | CAP, LOWER CASING | COPERCHIO CARTER INFERIORE | COUVERCLE, POMPE D'EAU |
| 33 | REC93317-22204 | 93317-22204 | COJINETE | BEARING | CUSCINETTO | ROULEMENT |
| 34 | REC93101-22M00 | 93101-22M00 | RETÉN DE ACEITE | OIL SEAL | PARAOLIO | JOINT SPI |
| 35 | REC663-45987-00 | 663-45987-02 | ESPACIADOR | SPACER | DISTANZIALE | ENTRETOISE |
| 36 | REC66T-45997-00 | 66T-45997-00 | ESPACIADOR | SPACER | DISTANZIALE | ENTRETOISE |
| 37 | REC90389-22M01 | 90389-22M01 | CASQUILLO HELICE | WASHER | GHIERA ELICA | RONDELLE D'HELICE |
| 38 | REC90171-16011 | 90171-16011 | TUERCA | LOCK NUT | DADO | ÉCROU |
| 39 | REC91490-30025 | 91490-30025 | PASADOR | PIN | SPINOTTO | PIN |

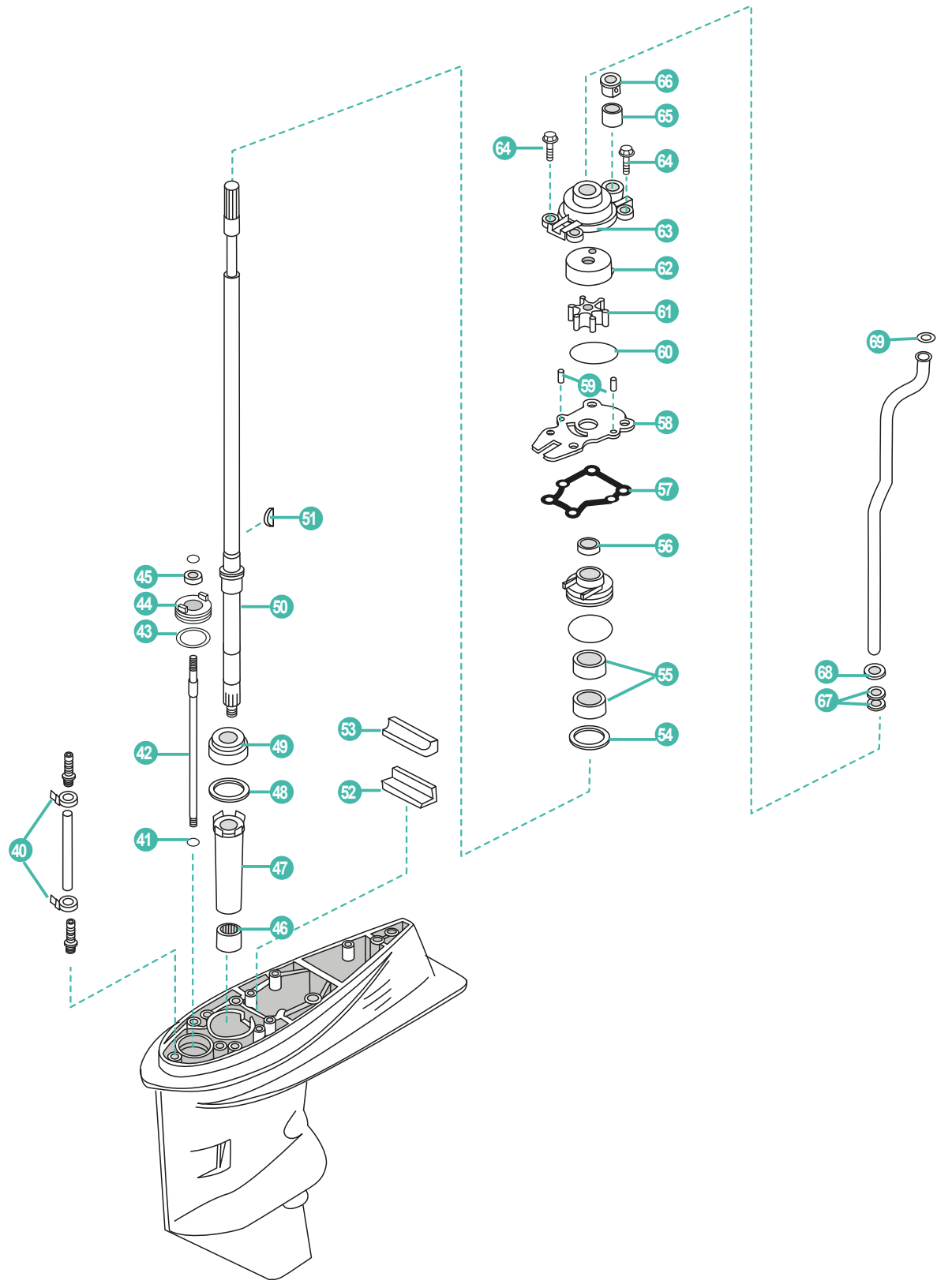

| | REF | OEM | | | | |
|----|-------------------|--------------|--------------------------------|-------------------------|-----------------------------|-----------------------|
| 40 | PAHT-2.5X60 | 90465-11M10 | BRIDA | CLAMP | FLANGIA | COLLIER |
| 41 | REC99001-08600-00 | 99001-08600 | ARANDELA | WASHER | RONDELLA | RONDELLE |
| 42 | PA60-04000004 | 63D-44144-00 | VARILLA DE CAMBIO | SHIFTING CAM | ASTA CAMBIO | LEVIER DE VITESSE |
| 43 | REC93210-33MG4 | 93210-33MG4 | TÓRICA | O-RING | O-RING | JOINT TORIQUE |
| 44 | PAF60-04000101 | 63D-45321-00 | PLACA | COVER, SHIFTING CAM | PACCA | SUPPORT |
| 45 | REC93106-09014 | 93106-09014 | RETÉN DE ACEITE | OIL SEAL | PARAOLIO | JOINT SPI |
| 46 | REC93315-32224 | 93315-32224 | COJINETE | BEARING | CUSCINETTO | ROULEMENT |
| 47 | PAT40-04000002 | 6H4-45536-00 | CAMISA EJE | SLEEVE, DRIVE | TUBO GUIDA | RONDELLE |
| | PAT40-04000003-1 | 663-45587-01 | GRUESO 0.10 mm | SHIM 0.10 mm | SPESSORE 0.10 mm | CALE 0.10 mm |
| | PAT40-04000003-2 | 663-45587-10 | GRUESO 0.12 mm | SHIM 0.12 mm | SPESSORE 0.12 mm | CALE 0.12 mm |
| | PAT40-04000003-3 | 663-45587-20 | GRUESO 0.15 mm | SHIM 0.15 mm | SPESSORE 0.15 mm | CALE 0.15 mm |
| 48 | PAT40-04000003-4 | 663-45587-30 | GRUESO 0.18 mm | SHIM 0.18 mm | SPESSORE 0.18 mm | CALE 0.18 mm |
| | PAT40-04000003-5 | 663-45587-40 | GRUESO 0.30 mm | SHIM 0.30 mm | SPESSORE 0.30 mm | CALE 0.30 mm |
| | PAT40-04000003-6 | 663-45587-50 | GRUESO 0.40 mm | SHIM 0.40 mm | SPESSORE 0.40 mm | CALE 0.40 mm |
| | PAT40-04000003-7 | 663-45587-60 | GRUESO 0.50 mm | SHIM 0.50 mm | SPESSORE 0.50 mm | CALE 0.50 mm |
| 49 | REC93332-00001 | 93332-00001 | COJINETE | BEARING | CUSCINETTO | ROULEMENT |
| 50 | REC67C-45501-10 | 67C-45501-10 | EJE VERTICAL L | DRIVE SHAFT L | ASSE VERTICALE L | ARBRE DE COMMANDE L |
| | REC67C-45501-00 | 67C-45501-00 | EJE VERTICAL S | DRIVE SHAFT S | ASSE VERTICALE S | ARBRE DE COMMANDE S |
| 51 | REC90280-03M03 | 90280-03M03 | CUÑA | KEY WOODRUFF | CHIAVETTA | CLAVETTE |
| 52 | REC663-45376-00 | 663-45376-00 | GUÍA SELLO DE GOMA | GUIDE RUB. SEAL | GUIDA PARAOLIO | GUIDE EN CAOUTCHOUC |
| 53 | PAT40-04000014 | 63D-45375-00 | SELLO DE GOMA | WATER ENVELOP | PARAOLIO | SUPPORT EN CAOUTCHOUC |
| 54 | PAT40-04000008 | 90201-27M00 | ARANDELA | WASHER | RONDELLA | RONDELLE |
| 55 | REC93101-22M60 | 93101-22M60 | RETÉN DE ACEITE | OIL SEAL | PARAOLIO | JOINT SPI |
| 56 | PAT40-04000009 | 66T-45344-01 | CUBIERTA SELLO DE ACEITE | COVER, OIL SEAL | PARAOLIO | BAGUE EN CAOUTCHOUC |
| 57 | REC63D-44316-00 | 63D-44316-00 | JUNTA | GASKET | GUARNIZIONE | JOINT |
| 58 | REC63D-44323-00 | 63D-44323-00 | PLACA EXTERIOR | OUTER PLATE | PLACCA ESTERIORE | PLAQUE DE POMPE À EAU |
| 59 | PAF25-04000007 | 93604-08062 | PASADOR | PIN | SPINOTTO | PIN |
| 60 | REC93210-59MG7 | 93210-59MG7 | TÓRICA | O-RING | O-RING | JOINT TORIQUE |
| 61 | REC6H4-44352-02 | 6H4-44352-02 | TURBINA | IMPELLER | GIRANTE | TURBINE |
| 62 | REC63D-44322-00 | 63D-44322-00 | TAPA, BOMBA AGUA | COVER, INNER WATER PUMP | COPERCHIO, POMPE D'EAU | INSERT DE POMPE À EAU |
| 63 | PAT40-04000201 | 66T-44311-00 | CUERPO BOMBA AGUA | HOUSING, WATER PUMP | CORPO POMPA | CORPS DE POMPE À EAU |
| 64 | REC90119-08M15 | 90119-08M15 | TORNILLO CON ARANDELA | SCREW WITH WASHER | VITE CON RONDELLA | VIS PLUS RONDELLE |
| 65 | REC663-44366-00 | 663-44366-00 | GOMA DEL SELLO DE AGUA | DAMPER, WATER SEAL | PARAOLIO | TUBE DE POMPE À EAU |
| 66 | REC63D-44312-00 | 63D-44312-00 | CUBIERTA CAJA DE BOMBA DE AGUA | PUMP COVER | COPERCHIO CASSA POMPA ACQUA | BAGUE DE POMPE À EAU |
| 67 | PAT40-02000002 | 663-44367-00 | GOMA DEL SELLO DE AGUA | DAMPER, WATER SEAL | PARAOLIO | JOINT |
| 68 | REC90430-12072 | 90430-12072 | JUNTA | GASKET | GUARNIZIONE | JOINT |
| 69 | PAF25-02000019 | 90202-12060 | ARANDELA PLANA | WASHER | RONDELLA PIANA | RONDELLE |

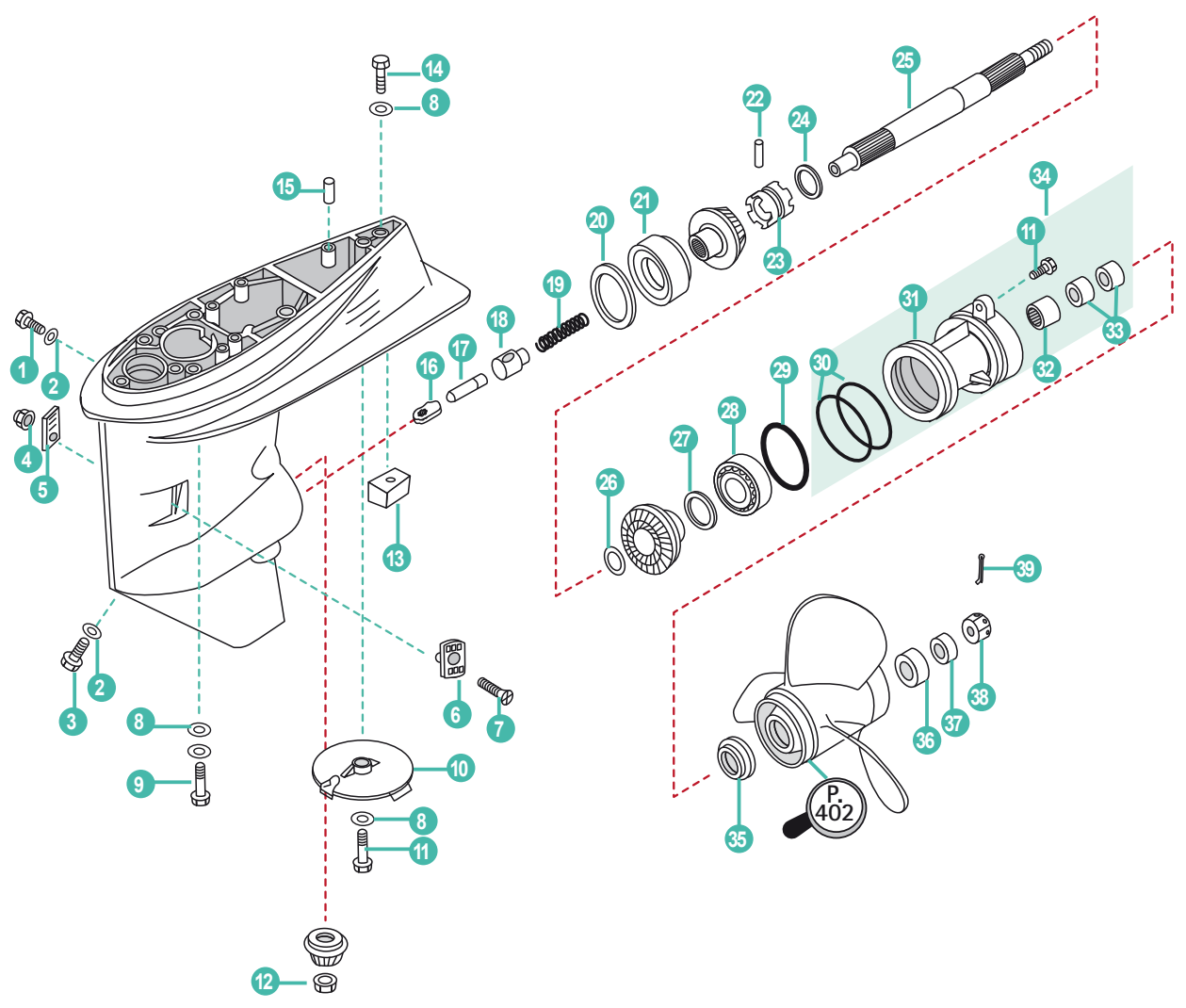

| REF | OEM |
|-----------------|--------------|
| REC62Y-W0001-22 | 62Y-W0001-22 |

P. 146

| REF | OEM |
|-----------------|--------------|
| REC63D-W0078-01 | 63D-W0078-01 |

P. 151

| REF |
|------------|
| REC80W90U3 |
| REC80W90U6 |
| RECGREU1 |
| RECGREU12 |

P. 43

| | REF | OEM | | | | |
|----|--------------------|-----------------|----------------------------|--------------------------|----------------------------|-------------------------|
| 1 | REC90340-08002 | 90340-08002 | TORNILLO DRENAJE | BOLT, DISCHARGING OIL | VITE DRENAGGIO | BOUCHON DE VIDANGE |
| 2 | REC90430-08020 | 90430-08003 | JUNTA | GASKET | GUARNIZIONE | JOINT |
| 3 | REC688-45341-00 | 688-45341-10 | TORNILLO DRENAJE | BOLT, DISCHARGING OIL | VITE DRENAGGIO | BOUCHON DE VIDANGE |
| 4 | PAGB/T889.1-M5 | 95380-05600 | TUERCA | LOCK NUT | DADO | ÉCROU |
| 5 | PAT40-04000023 | 63D-45215-00 | CUBIERTA ENTRADA AGUA B | WATER INLET B | COPERCHIO ACQUA B | GRILLE D'ENTREE D'EAU B |
| 6 | PAT40-04000022 | 63D-45214-00 | CUBIERTA ENTRADA AGUA A | WATER INLET A | COPERCHIO ACQUA A | GRILLE D'ENTREE D'EAU A |
| 7 | PAGB/T820-M5X30 | 90152-05M06 | TORNILLO | SCREW | VITE | VIS |
| 8 | PAGB/T97.1-8 | 92995-10600 | ARANDELA | WASHER | RONDELLA | RONDELLE |
| 9 | REC97075-10040 | 97075-10040 | PERNO | STUD | BULLONE | BOULON |
| 10 | CM67C-45371-00A | 67C-45371-00 | ÁNODO | ANODE | ANODO | ANODE |
| 11 | PAGB/T5783-M8X25 | 97095-08025 | PERNO | STUD | BULLONE | BOULON |
| 12 | REC90170-12138 | 90170-12138 | TUERCA | LOCK NUT | DADO | ÉCROU |
| 13 | CM67C-45251-00A | 67C-45251-00 | ÁNODO | ANODE | ANODO | ANODE |
| 14 | PAGB/T5783-M8X35 | 97095-08035 | PERNO | STUD | BULLONE | BOULON |
| 15 | REC93606-12019 | 93606-12019 | PASADOR | PIN | SPINOTTO | PIN |
| 16 | PAF60-04000003 | 62Y-44151-00 | LEVA DE CAMBIO | SHIFTING CAM | LEVA DE CAMBIO | CAME DE CHANGEMENT |
| 17 | PAF60-04020005 | 63D-45635-00 | ÉMBOLO | PLUNGER | BULLONE | BOUCHON |
| 18 | REC663-45634-00 | 663-45634-00 | DESILIZADOR DEL CAMBIO | CLUTCH DOG | TRAINABILE CAMBIO | PIVOT |
| 19 | PAF60-04020002 | 90501-18001 | MUELLE | SPRING | MOLLA | RESSORT |
| | PAT40-04000004-1 | 663-45567-01 | GRUESO 0.10 mm | SHIM 0.10 mm | SPESSORE 0.10 mm | CALE 0.10 mm |
| 20 | PAT40-04000004-2 | 663-45567-10 | GRUESO 0.12 mm | SHIM 0.12 mm | SPESSORE 0.12 mm | CALE 0.12 mm |
| | PAT40-04000004-3 | 663-45567-20 | GRUESO 0.15 mm | SHIM 0.15 mm | SPESSORE 0.15 mm | CALE 0.15 mm |
| | PAT40-04000004-5 | 663-45567-40 | GRUESO 0.30 mm | SHIM 0.30 mm | SPESSORE 0.30 mm | CALE 0.30 mm |
| 21 | REC93332-00003 | 93332-00003 | COJINETE | BEARING | CUSCINETTO | ROULEMENT |
| 22 | REC90250-06023 | 90250-06023 | PASADOR | PIN | SPINOTTO | LEVIER |
| 23 | PAF60-04020003 | 62Y-45631-00 | EMBRAGUE DE GARRA | CLUTCH DOG | SELETTORE | CRABOT |
| 24 | PAT40-04050005 | 67C-45633-00 | ANILLO DEL PASADOR | ANNULAR SPRING, CLUTCH | PARAOLIO | RESSORT |
| 25 | PAF60-04020001 | 63D-45611-00 | EJE HÉLICE | PROPELLER SHAFT | ASSE ELICA | ARBRE D'HELICE |
| 26 | REC90201-22429 | 90201-22429 | ARANDELA | WASHER | RONDELLA | RONDELLE |
| | PAT40-04060005-2 | 63D-45577-10 | GRUESO 0.12 mm | SHIM 0.12 mm | SPESSORE 0.12 mm | CALE 0.12 mm |
| | PAT40-04060005-3 | 63D-45577-20 | GRUESO 0.15 mm | SHIM 0.15 mm | SPESSORE 0.15 mm | CALE 0.15 mm |
| 27 | PAT40-04060005-4 | 63D-45577-30 | GRUESO 0.18 mm | SHIM 0.18 mm | SPESSORE 0.18 mm | CALE 0.18 mm |
| | PAT40-04060005-5 | 63D-45577-40 | GRUESO 0.30 mm | SHIM 0.30 mm | SPESSORE 0.30 mm | CALE 0.30 mm |
| | PAT40-04060005-6 | 63D-45577-50 | GRUESO 0.40 mm | SHIM 0.40 mm | SPESSORE 0.40 mm | CALE 0.40 mm |
| | PAT40-04060005-7 | 63D-45577-60 | GRUESO 0.50 mm | SHIM 0.50 mm | SPESSORE 0.50 mm | CALE 0.50 mm |
| 28 | REC93306-001U1 | 93306-001U1 | COJINETE | BEARING | CUSCINETTO | ROULEMENT |
| 29 | REC93210-69MG6 | 93210-69MG6 | TÓRICA | O-RING | O-RING | JOINT TORIQUE |
| 30 | REC93210-74MG5 | 93210-74MG5 | TÓRICA | O-RING | O-RING | JOINT TORIQUE |
| 31 | REC63D-45361-02-4D | 63D-45361-02-4D | DIÁBOLO | CAP, LOWER CASING | COPERCHIO CARTER INFERIORE | DIABOLO |
| 32 | REC93317-22204 | 93317-22204 | COJINETE | BEARING | CUSCINETTO | ROULEMENT |
| 33 | REC93101-22M00 | 93101-22M00 | RETÉN DE ACEITE | OIL SEAL | PARAOLIO | JOINT SPI |
| 34 | PAF60-04030000 | 63D-45361-02-8D | FUNDA INFERIOR COMPLETA | COVER ASSY, LOWER CASING | COPERCHIO CARTER COMPLETA | DIABOLO COMPLET |
| 35 | REC663-45987-00 | 663-45987-02 | ESPACIADOR | SPACER | DISTANZIALE | ENTRETOISE |
| 36 | REC66T-45997-00 | 667-45997-00 | ESPACIADOR | SPACER | DISTANZIALE | ENTRETOISE |
| 37 | REC90389-22M01 | 90389-22M01 | CASQUILLO HELICE | WASHER | GHIERA ELICA | RONDELLE D'HELICE |
| 38 | REC90171-16011 | 90171-16011 | TUERCA | LOCK NUT | DADO | ÉCROU |
| 39 | REC91490-30025 | 91490-30025 | PASADOR | PIN | SPINOTTO | CLAVETTE |

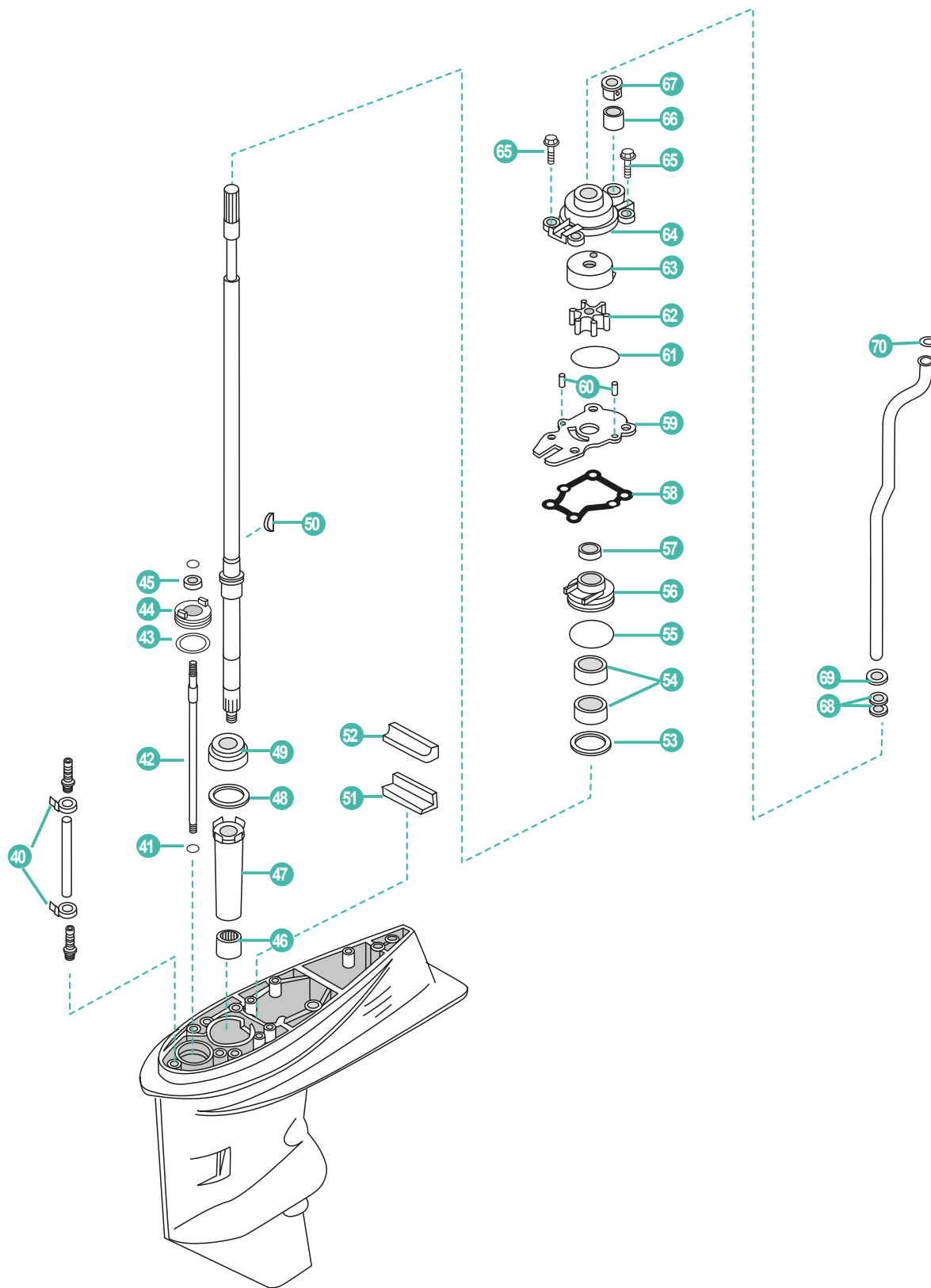

| | REF | OEM | | | | |
|----|-------------------|-----------------|--------------------------------|---------------------------|------------------------|----------------------------------|
| 40 | PAHT-2.5X60 | 90465-11M10 | BRIDA | CLAMP | FLANGIA | COLLIER |
| 41 | REC99001-08600-00 | 99001-08600 | ARANDELA | WASHER | RONDELLA | RONDELLE |
| 42 | PA60-04000004 | 63D-44144-00 | VARILLA DE CAMBIO | SHIFTING CAM | ASTA CAMBIO | LEVIER DE VITESSE |
| 43 | REC93210-33MG4 | 93210-33MG4 | TÓRICA | O-RING | O-RING | JOINT TORIQUE |
| 44 | PAF60-04000101 | 63D-45321-00 | PLACA | COVER, SHIFTING CAM | PLACCA | SUPPORT |
| 45 | REC93106-09014 | 93106-09014 | RETÉN DE ACEITE | OIL SEAL | PARAOLIO | JOINT SPI |
| 46 | REC93315-32224 | 93315-32224 | COJINETE | BEARING | CUSCINETTO | ROULEMENT |
| 47 | PAT40-04000002 | 6H4-45536-00 | CAMISA EJE | SLEEVE, DRIVE | TUBO GUIDA | BAGUE NYLON |
| | PAT40-04000003-1 | 663-45587-01 | GRUESO 0.10 mm | SHIM 0.10 mm | SPESSORE 0.10 mm | CALE 0.10 mm |
| | PAT40-04000003-2 | 663-45587-10 | GRUESO 0.12 mm | SHIM 0.12 mm | SPESSORE 0.12 mm | CALE 0.12 mm |
| | PAT40-04000003-3 | 663-45587-20 | GRUESO 0.15 mm | SHIM 0.15 mm | SPESSORE 0.15 mm | CALE 0.15 mm |
| 48 | PAT40-04000003-4 | 663-45587-30 | GRUESO 0.18 mm | SHIM 0.18 mm | SPESSORE 0.18 mm | CALE 0.18 mm |
| | PAT40-04000003-5 | 663-45587-40 | GRUESO 0.30 mm | SHIM 0.30 mm | SPESSORE 0.30 mm | CALE 0.30 mm |
| | PAT40-04000003-6 | 663-45587-50 | GRUESO 0.40 mm | SHIM 0.40 mm | SPESSORE 0.40 mm | CALE 0.40 mm |
| | PAT40-04000003-7 | 663-45587-60 | GRUESO 0.50 mm | SHIM 0.50 mm | SPESSORE 0.50 mm | CALE 0.50 mm |
| 49 | REC93332-00001 | 93332-00001 | COJINETE | BEARING | CUSCINETTO | ROULEMENT |
| 50 | REC90280-03024 | 90280-03024 | CUÑA | KEY WOODRUFF | CHIAVETTA | CLAVETTE |
| 51 | REC663-45376-00 | 663-45376-00-94 | GUIÁ SELLO DE GOMA | GUIDE RUB SEAL | GUIDA PARAOLIO | GUIDE |
| 52 | PAT40-04000014 | 63D-45375-00 | SELLO DE GOMA | WATER ENVELOP | PARAOLIO | PROTECTION TUYAU D'EAU |
| 53 | PAT40-04000008 | 90201-27M00 | ARANDELA | WASHER | RONDELLA | RONDELLE |
| 54 | REC93101-25M57 | 93101-25M57 | RETÉN DE ACEITE | OIL SEAL | PARAOLIO | JOINT SPI |
| 55 | REC93210-48MG8 | 93210-48MG8 | TÓRICA | O-RING | O-RING | JOINT TORIQUE |
| 56 | REC63D-44341-00 | 63D-44341-00 | CAJA DE BOMBA | HOUSING PUMP | CASSA POMPA | BOITIER DE POMPE À EAU |
| 57 | PAT40-04000009 | 66T-45344-01 | CUBIERTA SELLO DE ACEITE | COVER SEAL OIL | COPERCHIO PARAOLIO | JOINT SPI |
| 58 | REC63D-44316-00 | 63D-44316-00 | JUNTA | GASKET | GUARNIZIONE | JOINT |
| 59 | REC63D-44323-00 | 63D-44323-00 | PLACA EXTERIOR | OUTER PLATE | PIASTRA POMPA ACQUA | PLAQUE DE POMPE À EAU |
| 60 | PAF25-04000007 | 93604-08062 | PASADOR | PIN | SPINOTTO | PIN |
| 61 | REC93210-59MG7 | 93210-59MG7 | TÓRICA | O-RING | O-RING | JOINT TORIQUE |
| 62 | REC6H4-44352-02 | 6H4-44352-00 | TURBINA | IMPELLER | GIRANTE | TURBINE |
| 63 | REC63D-44322-00 | 63D-44322-00 | TAPA, BOMBA AGUA | COVER, INNER WATER PUMP | COPERCHIO, POMPA ACQUA | INSERT DE POMPE À EAU |
| 64 | REC63D-44311-01 | 63D-44311-00 | CUERPO BOMBA AGUA | HOUSING, WATER PUMP | CORPO POMPA | CORPS DE POMPE À EAU |
| 65 | REC90119-08M15 | 90119-08M15 | TORNILLO CON ARANDELA | SCREW WITH WASHER | VITE CON RONDELLA | VIS AVEC RONDELLE |
| 66 | REC663-44366-00 | 663-44366-00 | GOMA DEL SELLO DE AGUA | GUIDE BUSHING, WATER PIPE | PARAOLIO | MAUCHON CAOUTCHOUC DE PIPE D'EAU |
| 67 | REC63D-44312-00 | 63D-44312-00 | CUBIERTA CAJA DE BOMBA DE AGUA | PUMP COVER | COPERCHIO CORPO ACQUA | PLAQUE POMPE À EAU |
| 68 | PAT40-02000002 | 663-44367-00 | GOMA DEL SELLO DE AGUA | GUIDE BUSHING, WATER PIPE | PARAOLIO | JOINT CAHOUTCHOUC |
| 69 | REC90430-12072 | 90430-12072 | JUNTA | GASKET | GUARNIZIONE | JOINT |
| 70 | PAF25-02000019 | 90202-12060 | ARANDELA PLANA | WASHER | RONDELLA PIANA | RONDELLE |

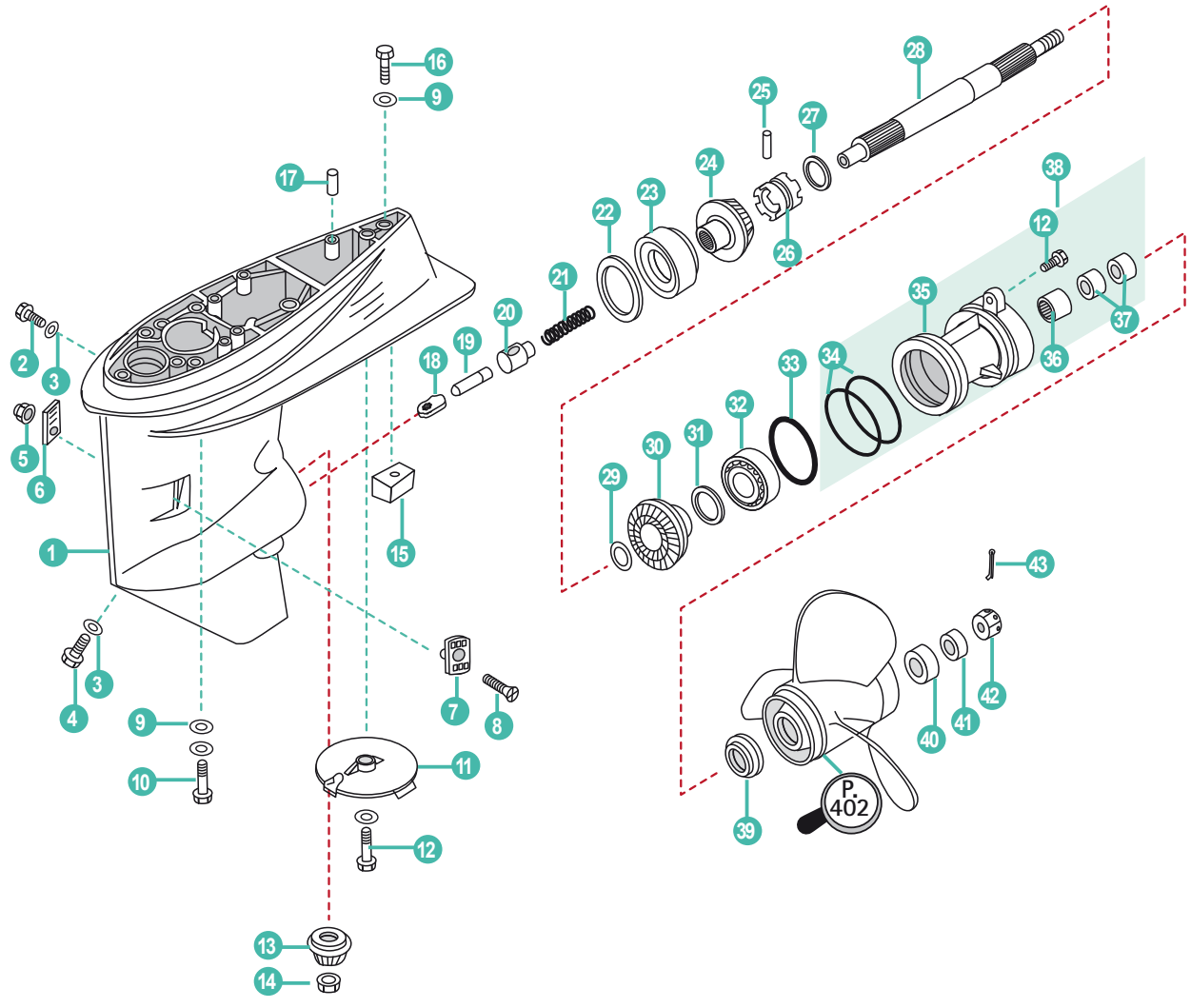

REF
REC63D-W0078-01

OEM
63D-W0078-01

P.151

REF
REC80W90U3
REC80W90U6
RECGREU1
RECGREU12

P.43

| | REF | OEM | | | | |
|----|--------------------|---|--------------------------|----------------------------|----------------------------|--|
| | PAF60-04000000 | 69W-45300-04-8D COLA COMPLETA L | COMPLETE GEAR HOUSING L | PIEDE COMPLETO L | EMBASE COMPLETE L | |
| 1 | PAF60-04000001 | 69W-45301-00-8D CARCASA COMPLETA | LOWER CASING | CARCASSA COMPLETA | CARTER D'EMBASE | |
| 2 | REC90340-08002 | 90340-08002 TORNILLO DRENAJE | BOLT, DISCHARGING OIL | VITE DRENAGGIO | BOUCHON DE VIDANGE | |
| 3 | REC90430-08020 | 90430-08003 JUNTA | GASKET | GUARNIZIONE | JOINT | |
| 4 | REC688-45341-00 | 688-45341-10 TORNILLO DRENAJE | BOLT, DISCHARGING OIL | VITE DRENAGGIO | VIS DE VIDANGE | |
| 5 | PAGB/T889.1-M5 | 95380-05600 TUERCA | LOCK NUT | DADO | ÉCROU | |
| 6 | PAT40-04000023 | 63D-45215-00 CUBIERTA ENTRADA AGUA B | WATER INLET B | COPERCHIO ACQUA B | GRILLE D'ENTREE D'EAU B | |
| 7 | PAT40-04000022 | 63D-45214-00 CUBIERTA ENTRADA AGUA A | WATER INLET A | COPERCHIO ACQUA A | GRILLE D'ENTREE D'EAU A | |
| 8 | PAGB/T820-M5X30 | 90152-05010 TORNILLO | SCREW | VITE | VIS | |
| 9 | PAGB/T97.1-8 | 92995-10600 ARANDELA | WASHER | RONDELLA | RONDELLE | |
| 10 | REC97075-10040 | 97075-10040 PERNO | STUD | BULLONE | BOULON | |
| 11 | CM67C-45371-00A | 67C-45371-00 ÁNODO | ANODE | ANODO | ANODE | |
| 12 | PAGB/T5783-M8X25 | 97095-08025 PERNO | STUD | BULLONE | BOULON | |
| 13 | PAF60-04000002 | 69W-45551-00 PIÑÓN ATAQUE | INITIATIVE GEAR | MARCIA INIZIATIVA | PIGNON D'ATTAQUE | |
| 14 | REC90170-12138 | 90170-12138 TUERCA | LOCK NUT | DADO | ÉCROU | |
| 15 | CM67C-45251-00A | 67C-45251-00 ÁNODO | ANODE | ANODO | ANODE | |
| 16 | PAGB/T5783-M8X35 | 97095-08035 PERNO | STUD | BULLONE | BOULON | |
| 17 | REC93606-12019 | 93606-12019 PASADOR | PIN | SPINOTTO | PIN | |
| 18 | PAF60-04000003 | 62Y-44151-00 LEVA DE CAMBIO | SHINFTING CAM | LEVA DE CAMBIO | CAME DE CHANGEMENT | |
| 19 | PAF60-04020005 | 63D-45635-00 ÉMBOLO | PLUNGER | BULLONE | BOUCHON | |
| 20 | REC663-45634-00 | 663-45634-00 DESLIZADOR DEL CAMBIO | CLUTCH DOG | TRAINABILE CAMBIO | PIVOT | |
| 21 | PAF60-04020002 | 90501-18001 MUELLE | SPRING | MOLLA | RESSORT | |
| | PAT40-04000004-1 | 663-45567-01 GRUESO 0.10 mm | SHIM 0.10 mm | SPESSORE 0.10 mm | CALE 0.10 mm | |
| | PAT40-04000004-2 | 663-45567-10 GRUESO 0.12 mm | SHIM 0.12 mm | SPESSORE 0.12 mm | CALE 0.12 mm | |
| | PAT40-04000004-3 | 663-45567-20 GRUESO 0.15 mm | SHIM 0.15 mm | SPESSORE 0.15 mm | CALE 0.15 mm | |
| | PAT40-04000004-5 | 663-45567-40 GRUESO 0.30 mm | SHIM 0.30 mm | SPESSORE 0.30 mm | CALE 0.30 mm | |
| 23 | PAKOYOH1-CAP322/32 | 93332-00092 COJINETE | BEARING | CUSCINETTO | ROULEMENT | |
| 24 | PAF60-04000600 | 69W-45560-00 PIÑÓN MARCHA AVANTE | POSITIVE GEAR ASSY | PIGNONE MARCIA AVANTI | PIGNON DE MARCHE AVANT | |
| 25 | REC90250-06023 | 90250-06023 PASADOR | PIN | SPINOTTO | LEVIER | |
| 26 | PAF60-04020003 | 62Y-45631-00 EMBRAGUE DE GARRA | CLUTCH DOG | SELETTORE | CRABOT | |
| 27 | PAT40-04050005 | 67C-45633-00 ANILLO DEL PASADOR | ANNULAR SPRING, CLUTCH | PARAOLIO | RESSORT | |
| 28 | PAF60-04020001 | 63D-45611-00 EJE HÉLICE | PROPELLER SHAFT | ASSE ELICA | ARBRE D'HELICE | |
| 29 | PAT40-04050007 | 90201-22008 ARANDELA | WASHER | RONDELLA | RONDELLE | |
| 30 | PAF60-04000500 | 62Y-45571-00 PIÑÓN MARCHA ATRÁS | REVERSE GEAR | PIGNONE MARCIA INDIETRO | PIGNON MARCHE ARRIÈRE | |
| | PAT40-04060005-2 | 63D-45577-10 GRUESO 0.12 mm | SHIM 0.12 mm | SPESSORE 0.12 mm | CALE 0.12 mm | |
| | PAT40-04060005-3 | 63D-45577-20 GRUESO 0.15 mm | SHIM 0.15 mm | SPESSORE 0.15 mm | CALE 0.15 mm | |
| | PAT40-04060005-4 | 63D-45577-30 GRUESO 0.18 mm | SHIM 0.18 mm | SPESSORE 0.18 mm | CALE 0.18 mm | |
| | PAT40-04060005-5 | 63D-45577-40 GRUESO 0.30 mm | SHIM 0.30 mm | SPESSORE 0.30 mm | CALE 0.30 mm | |
| | PAT40-04060005-6 | 63D-45577-50 GRUESO 0.40 mm | SHIM 0.40 mm | SPESSORE 0.40 mm | CALE 0.40 mm | |
| | PAT40-04060005-7 | 63D-45577-60 GRUESO 0.50 mm | SHIM 0.50 mm | SPESSORE 0.50 mm | CALE 0.50 mm | |
| 32 | REC93306-001U1 | 93306-001U1 COJINETE | BEARING | CUSCINETTO | ROULEMENT | |
| 33 | REC93210-69MG6 | 93210-69MG6 TÓRICA | O-RING | O-RING | JOINT TORIQUE | |
| 34 | REC93210-74MG5 | 93210-74MG5 TÓRICA | O-RING | O-RING | JOINT TORIQUE | |
| 35 | REC63D-45361-02-8D | 63D-45361-02-8D DIÁBOLO | CAP, LOWER CASING | COPERCHIO CARTER INFERIORE | COUVERCLE, POMPE D'EAU | |
| 36 | REC93317-22204 | 93317-22204 COJINETE | BEARING | CUSCINETTO | PALIER | |
| 37 | REC93101-22M00 | 93101-22M00 RETÉN DE ACEITE | OIL SEAL | PARAOLIO | JOINT SPI | |
| 38 | PAF60-04030000 | 63D-45361-02-8D FUNDA INFERIOR COMPLETA | COVER ASSY, LOWER CASING | COPERCHIO CARTER COMPLETA | COUVERCLE INFERIEUR EMBASE | |
| 39 | REC663-45987-00 | 663-45987-02 ESPACIADOR | SPACER | DISTANZIALE | ENTRETOISE | |
| 40 | REC66T-45997-00 | 667-45997-00 ESPACIADOR | SPACER | DISTANZIALE | ENTRETOISE | |
| 41 | REC90389-22M01 | 90389-22M01 CASQUILLO HÉLICE | WASHER | GHIERA ELICA | RONDELLE D'HELICE | |
| 42 | REC90171-16011 | 90171-16011 TUERCA | LOCK NUT | DADO | ÉCROU | |
| 43 | REC91490-30025 | 91490-30025 PASADOR | PIN | SPINOTTO | CLAVETTE | |

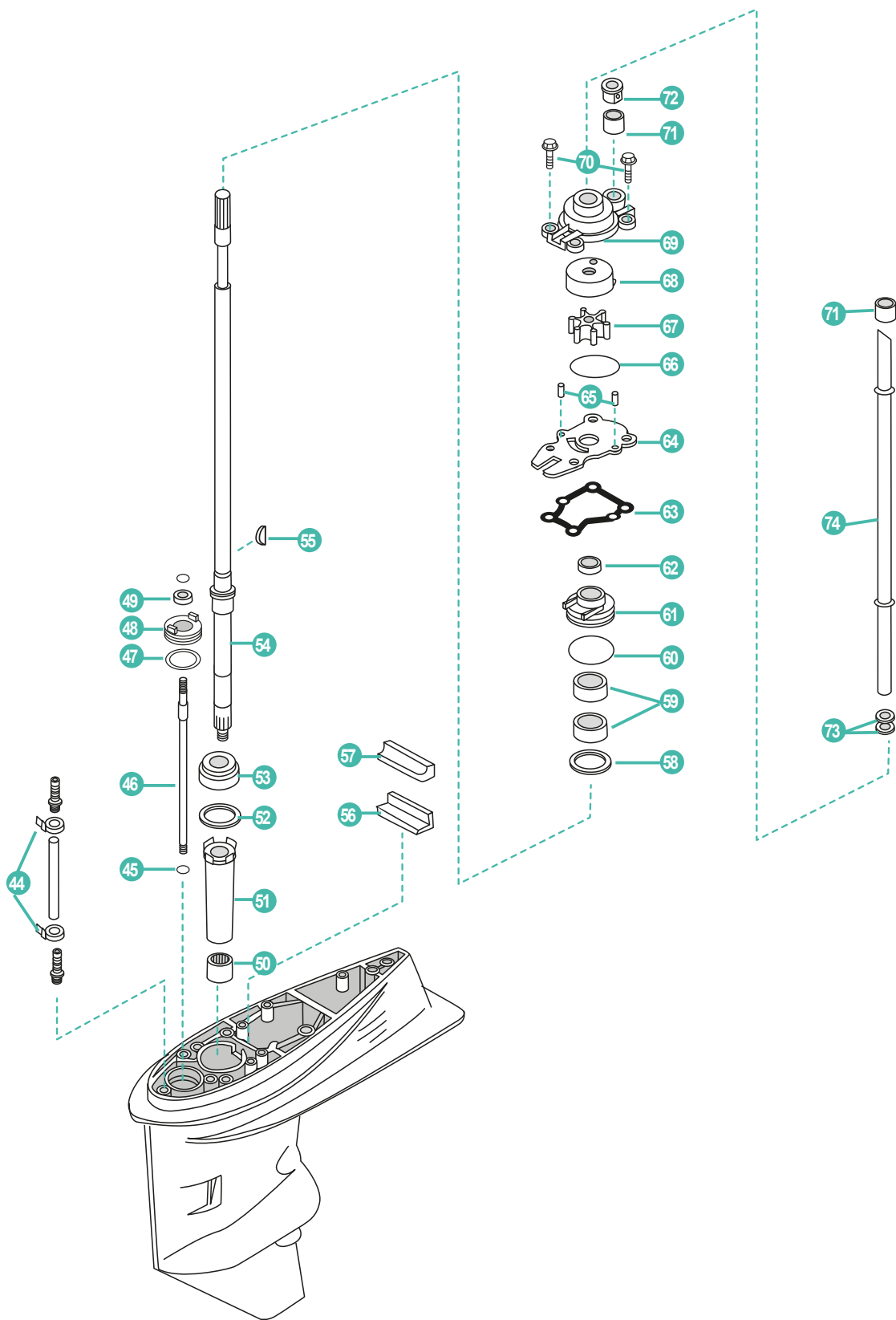

| | REF | OEM | | | | |
|----|-------------------|-----------------|--------------------------------|---------------------------|------------------------|--------------------------|
| 44 | PAHT-2.5X60 | 90465-11M10 | BRIDA | CLAMP | FLANGIA | COLLIER |
| 45 | REC99001-08600-00 | 99001-08600 | ARANDELA | WASHER | RONDELLA | RONDELLE |
| 46 | PA60-04000004 | 63D-44144-00 | VARILLA DE CAMBIO | SHIFTING CAM | ASTICELLA DEL CAMBIO | CAME DE CHANGEMENT |
| 47 | REC93210-33MG4 | 93210-33MG4 | TÓRICA | O-RING | O-RING | JOINT TORIQUE |
| 48 | PAF60-04000101 | 63D-45321-00 | PLACA | COVER, SHIFTING CAM | PLACCA | SUPPORT |
| 49 | REC93106-09014 | 93106-09014 | RETÉN DE ACEITE | OIL SEAL | PARAOLIO | JOINT SPI |
| 50 | REC93315-32224 | 93315-32224 | COJINETE | BEARING | CUSCINETTO | PALIER |
| 51 | PAT40-04000002 | 6H4-45536-00 | CAMISA EJE | SLEEVE, DRIVE | TUBO GUIDA | RONDELLE |
| | PAT40-04000003-1 | 663-45587-01 | GRUESO 0.10 mm | SHIM 0.10 mm | SPESSORE 0.10 mm | CALE 0.10 mm |
| | PAT40-04000003-2 | 663-45587-10 | GRUESO 0.12 mm | SHIM 0.12 mm | SPESSORE 0.12 mm | CALE 0.12 mm |
| | PAT40-04000003-3 | 663-45587-20 | GRUESO 0.15 mm | SHIM 0.15 mm | SPESSORE 0.15 mm | CALE 0.15 mm |
| 52 | PAT40-04000003-4 | 663-45587-30 | GRUESO 0.18 mm | SHIM 0.18 mm | SPESSORE 0.18 mm | CALE 0.18 mm |
| | PAT40-04000003-5 | 663-45587-40 | GRUESO 0.30 mm | SHIM 0.30 mm | SPESSORE 0.30 mm | CALE 0.30 mm |
| | PAT40-04000003-6 | 663-45587-50 | GRUESO 0.40 mm | SHIM 0.40 mm | SPESSORE 0.40 mm | CALE 0.40 mm |
| | PAT40-04000003-7 | 663-45587-60 | GRUESO 0.50 mm | SHIM 0.50 mm | SPESSORE 0.50 mm | CALE 0.50 mm |
| 53 | REC93332-00001 | 93332-00001 | COJINETE | BEARING | CUSCINETTO | ROULEMENT |
| 54 | PAF60-04010000 | 69W-45501-00 | EJE VERTICAL COMPLETO | DRIVE SHAFT | ASSE VERTICALE | ARBRE DE COMMANDE |
| 55 | REC90280-03024 | 90280-03024 | CUÑA | KEY WOODRUFF | CHIAVETTA | CLAVETTE |
| 56 | REC663-45376-00 | 663-45376-00-94 | GUÍA SELLO DE GOMA | GUIDE RUB. SEAL | GUIDA PARAOLIO | GUIDE |
| 57 | PAT40-04000014 | 63D-45375-00 | SELLO DE GOMA | WATER ENVELOP | PARAOLIO | PROTECTION TUYAU D'EAU |
| 58 | PAT40-04000008 | 90201-27M00 | ARANDELA | WASHER | RONDELLA | RONDELLE |
| 59 | REC93101-25M57 | 93101-25M57 | RETÉN DE ACEITE | OIL SEAL | PARAOLIO | JOINT SPI |
| 60 | PAJASOF40424-050 | 93210-48001 | TÓRICA | O-RING | O-RING | JOINT TORIQUE |
| 61 | PAT40-04040001 | 6BG-44341-00 | CAJA DE BOMBA | CASING A, OIL SEAL | CASSA POMPA | LOGEMENT JOINT SPI |
| 62 | PAF60-04000008 | 63D-45344-00 | CUBIERTA SELLO DE ACEITE | COVER, OIL SEAL | PARAOLIO | COUVERTURE JOINT D'HUILE |
| 63 | REC63D-44316-00 | 63D-44316-00 | JUNTA | GASKET | GUARNIZIONE | JOINT |
| 64 | REC63D-44323-00 | 63D-44323-00 | PLACA EXTERIOR | WATER PLATE | PLACCA ESTERNA | PLAQUE DE POMPE À EAU |
| 65 | PAF25-04000007 | 93604-08062 | PASADOR | PIN | SPINOTTO | LEVIER |
| 66 | REC93210-59MG7 | 93210-59MG7 | TÓRICA | O-RING | O-RING | JOINT TORIQUE |
| 67 | REC6H3-44352-00 | 6H3-44352-00 | TURBINA | IMPELLER | GIRANTE | TURBINE |
| 68 | REC63D-44322-00 | 63D-44322-00 | TAPA, BOMBA AGUA | COVER, INNER WATER PUMP | COPERCHIO, POMPE D'EAU | INSERT DE POMPE À EAU |
| 69 | REC63D-44311-01 | 63D-44311-00 | CUERPO BOMBA AGUA | HOUSING, WATER PUMP | CORPO POMPA | CORPS DE POMPE À EAU |
| 70 | REC90119-08M15 | 90119-08M15 | TORNILLO CON ARANDELA | SCREW WITH WASHER | VITE CON RONDELLA | VIS AVEC RONDELLE |
| 71 | REC663-44366-00 | 663-44366-00 | GOMA DEL SELLO DE AGUA | GUIDE BUSHING, WATER PIPE | PARAOLIO | GUIDE CAOUTCHOUC |
| 72 | REC63D-44312-00 | 63D-44312-00 | CUBIERTA CAJA DE BOMBA DE AGUA | PUMP COVER | COPERCHIO CORPO ACQUA | PLAQUE POMPE À EAU |
| 73 | PAT40-02000002 | 663-44367-00 | GOMA DEL SELLO DE AGUA | GUIDE BUSHING, WATER PIPE | PARAOLIO | JOINT CAOUTCHOUC |
| 74 | PAF60-02000007 | 6C5-44361-00 | TUBO DE AGUA | WATER TUBE | TUBO DELL'ACQUA | DURITE D'EAU |

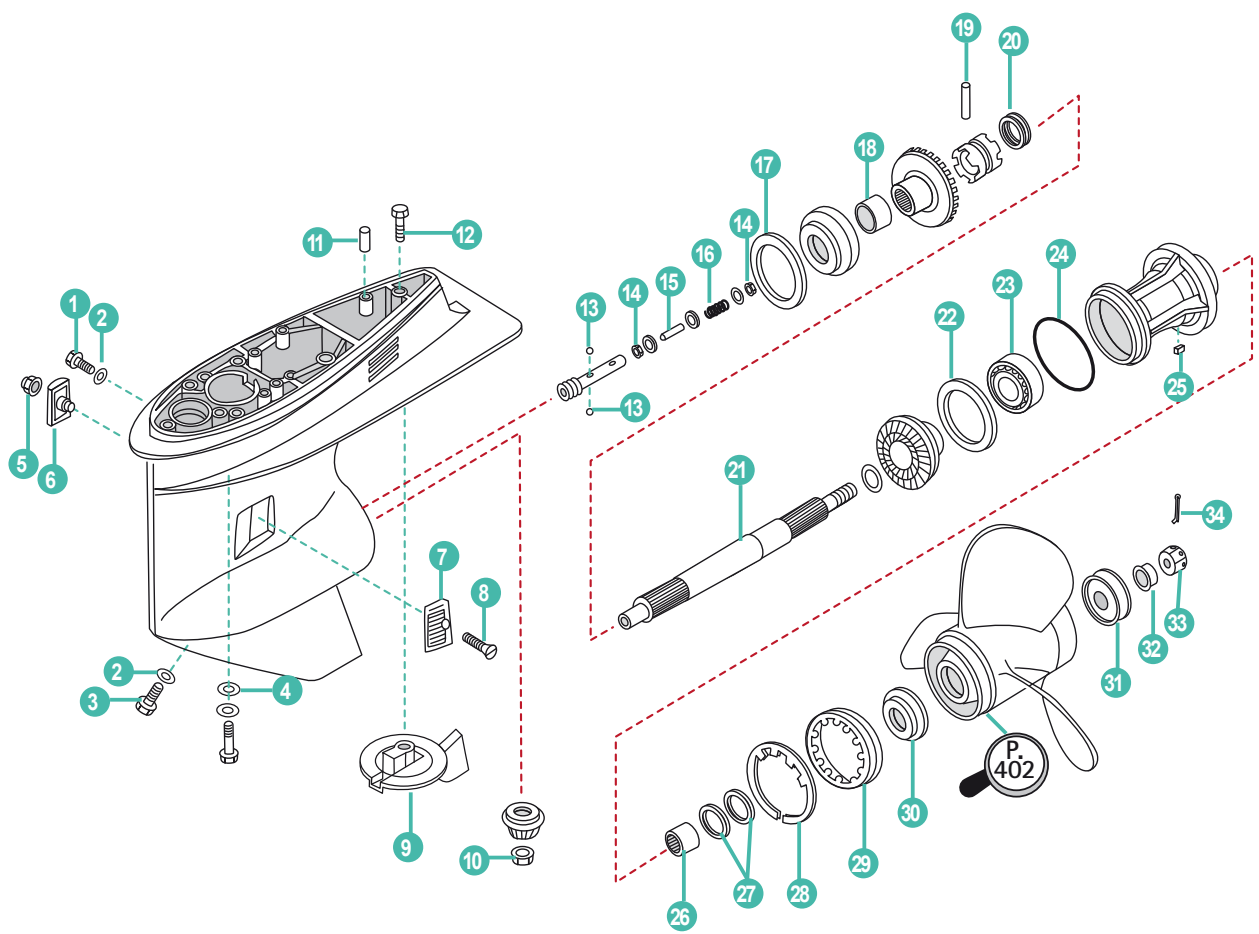

| REF | OEM |
|-----------------|--------------|
| REC6CJ-W0078-00 | 6CJ-W0078-00 |

P. 151

| REF |
|------------|
| REC80W90U3 |
| REC80W90U6 |
| RECGREU1 |
| RECGREU12 |

P. 43

| | REF | OEM | | | | |
|----|------------------|--------------|-------------------------|------------------------|-------------------|-------------------------|
| 1 | REC90340-08002 | 90340-08002 | TORNILLO DRENAJE | BOLT, DISCHARGING OIL | VITE DRENAGGIO | BOUCHON DE VIDANGE |
| 2 | REC90430-08020 | 90430-08003 | JUNTA | GASKET | GUARNIZIONE | JOINT |
| 3 | REC688-45341-00 | 688-45341-10 | TORNILLO DRENAJE | BOLT, DISCHARGING OIL | VITE DRENAGGIO | BOUCHON DE VIDANGE |
| 4 | PAGB/T97.1-8 | 92995-10600 | ARANDELA | WASHER | RONDELLA | RONDELLE |
| 5 | PAGB/T6182-M5 | 90185-05002 | TUERCA | LOCK NUT | DADO | ÉCROU |
| 6 | REC6H1-45215-00 | 6H1-45215-00 | CUBIERTA ENTRADA AGUA B | WATER INLET B | COPERCHIO ACQUA B | GRILLE D'ENTREE D'EAU B |
| 7 | REC6H1-45214-00 | 6H1-45214-00 | CUBIERTA ENTRADA AGUA A | WATER INLET A | COPERCHIO ACQUA A | GRILLE D'ENTREE D'EAU A |
| 8 | REC90151-05M00 | 90152-05000 | TORNILLO | SCREW | VITE | VIS |
| 9 | CM67F-45371-00A | 67F-45371-00 | ÁNODO | ANODE | ANODO | ANODE |
| 10 | REC90170-16M01 | 90170-16M01 | TUERCA | LOCK NUT | DADO | ÉCROU |
| 11 | REC93606-12019 | 93606-12019 | PASADOR | PIN | SPINOTTO | LEVIER |
| 12 | PAT85-00000012 | 90105-16M67 | PERNO | STUD | BULLONE | BOULON |
| 13 | REC93503-16003 | 93503-16003 | ESFERA | BALL | SFERA | BILLE |
| 14 | REC90183-02M03 | 90183-02M03 | TUERCA | LOCK NUT | DADO | ÉCROU |
| 15 | REC6H1-45668-00 | 6H1-45668-00 | EJE DEL ÉMBOLO | FREE SHAFT | BULLONE | ARBRE |
| 16 | REC90501-12M48 | 90501-12M48 | MUELLE | SPRING | MOLLA | RESSORT |
| 17 | PAT85-04000004-B | 688-45567-01 | GRUESO 0.10 mm | SHIM 0.10 mm | SPESSORE 0.10 mm | CALE 0.10 mm |
| 18 | REC93317-322V0 | 93317-322V0 | COJINETE | BEARING | CUSCINETTO | PALIER |
| 19 | REC90250-07M02 | 90250-07M02 | PASADOR | PIN | SPINOTTO | LEVIER |
| 20 | REC688-45633-00 | 688-45633-00 | ANILLO DEL PASADOR | ANNULAR SPRING, CLUTCH | PARAOLIO | RESSORT |
| 21 | REC67F-45611-01 | 67F-45611-01 | EJE HÉLICE | PROPELLER SHAFT | ASSE ELICA | ARBRE D'HELICE |
| 22 | REC67F-45576-00 | 67F-45576-00 | ARANDELA | WASHER | RONDELLA | RONDELLE |
| 23 | REC93306-207U0 | 93306-207U0 | COJINETE | BEARING | CUSCINETTO | PALIER |
| 24 | REC93210-86M39 | 93210-86M39 | TÓRICA | O-RING | O-RING | JOINT TORIQUE |
| 25 | REC90282-04010 | 90282-04010 | CHAVETA RECTA | KEY | CHIAVETTA | CLAVETTE |
| 26 | REC93317-325U0 | 93317-325U0 | COJINETE | BEARING | CUSCINETTO | PALIER |
| 27 | REC93101-25M03 | 93101-25M03 | RETÉN DE ACEITE | OIL SEAL | PARAOLIO | JOINT SPI |
| 28 | REC688-45383-01 | 688-45383-02 | ARANDELA | WASHER | RONDELLA | RONDELLE |
| 29 | REC688-45384-00 | 688-45384-02 | TUERCA | NUT | DADO | ÉCROU |
| 30 | REC688-45987-00 | 688-45987-01 | ESPACIADOR | SPACER | DISTANZIALE | ENTRETOISE |
| 31 | REC67F-45997-00 | 67F-45997-00 | ESPACIADOR | SPACER | DISTANZIALE | ENTRETOISE |
| 32 | REC90389-25M00 | 90389-25M00 | CASQUILLO HÉLICE | WASHER | GHIERA ELICA | RONDELLE D'HELICE |
| 33 | REC90171-16011 | 90171-16011 | TUERCA | LOCK NUT | DADO | ÉCROU |
| 34 | REC91490-30025 | 91490-30025 | PASADOR | PIN | SPINOTTO | CLAVETTE |

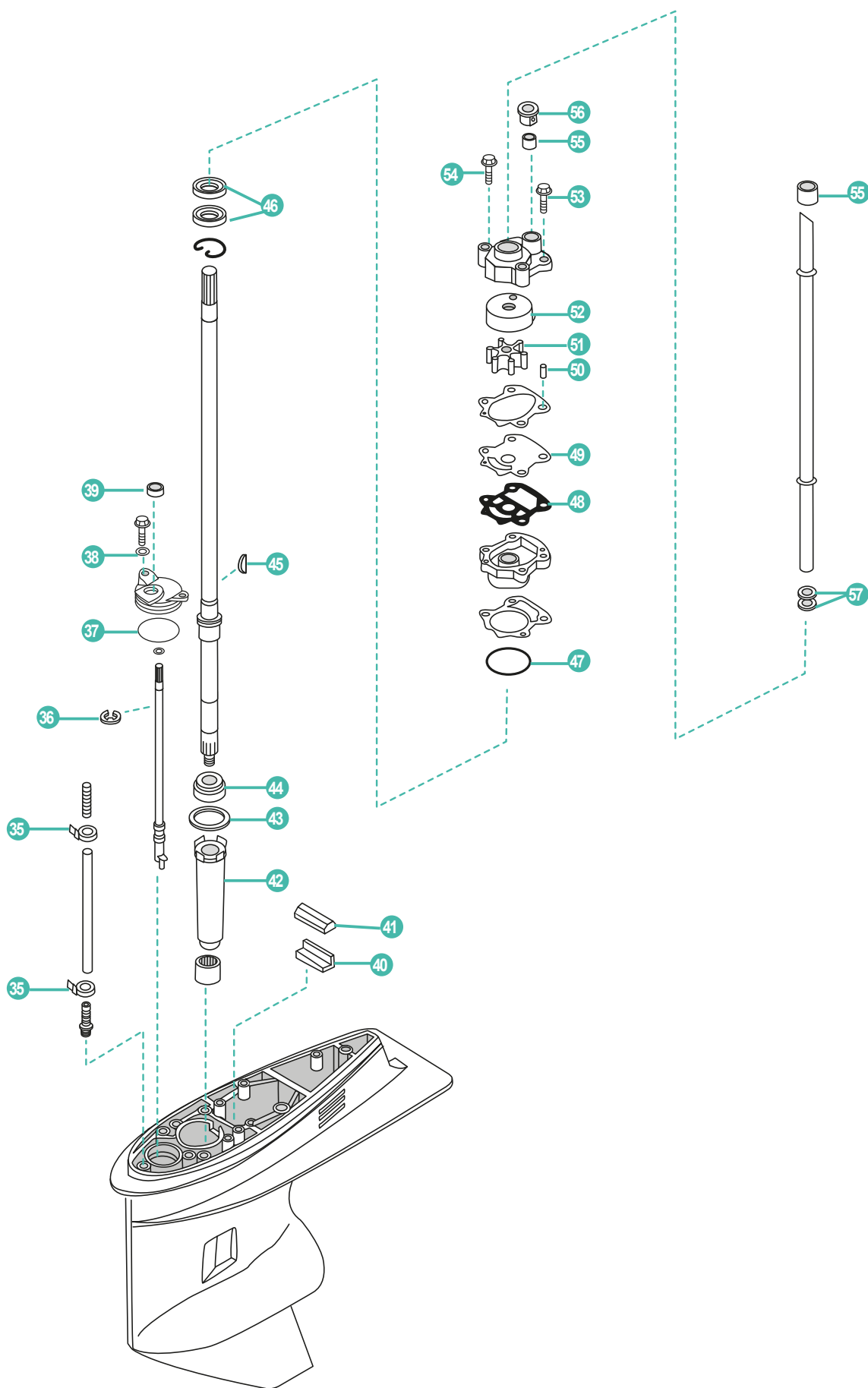

| | REF | OEM | | | | |
|----|-------------------|-----------------|--------------------------------|---------------------------|-------------------------|-----------------------|
| 35 | PAHT-2.5X60 | 90465-11M10 | BRIDA | CLAMP | FLANGIA | COLLIER |
| 36 | REC99001-08600-00 | 99001-08600 | ARANDELA | WASHER | RONDELLA | RONDELLE |
| 37 | REC93210-49046 | 93210-49046 | TÓRICA | O-RING | O-RING | JOINT TORIQUE |
| 38 | PAGB/T97.1-6 | 92995-06600 | ARANDELA | WASHER | RONDELLA | RONDELLE |
| 39 | REC93106-09014 | 93106-09014 | RETÉN DE ACEITE | OIL SEAL | PARAOLIO | JOINT SPI |
| 40 | REC663-45376-00 | 663-45376-00-94 | GUÍA SELLO DE GOMA | GUIDE RUB. SEAL | GUIDA PARAOLIO | GUIDE |
| 41 | REC688-45375-00 | 63D-45375-00 | RETEN DAMPER | DAMPER WASHER | PARAOLIO DAMPER | JOINT SILENT BLOC |
| 42 | REC688-45536-01 | 688-45536-01 | CAMISA EJE | SLEEVE, DRIVE | TUBO GUIDA | RONDELLE |
| 43 | PAT85-040000003-B | 688-45587-01 | GRUESO 0.10 mm | SHIM 0.10 mm | SPESSORE 0.10 mm | CALE 0.10 mm |
| 44 | REC93332-000U3 | 93332-000U3 | COJINETE | BEARING | CUSCINETTO | ROULEMENT |
| 45 | REC90280-03M03 | 90280-03M03 | CUÑA | KEY WOODRUFF | CHIAVETTA | CLAVETTE |
| 46 | REC93101-23070 | 93101-23070 | RETÉN DE ACEITE | OIL SEAL | PARAOLIO | JOINT SPI |
| 47 | REC93210-46044 | 93210-46044 | TÓRICA | O-RING | O-RING | JOINT TORIQUE |
| 48 | REC6CJ-44324-00 | 6CJ-44324-00 | JUNTA | GASKET | GUARNIZIONE | JOINT |
| 49 | REC6CJ-44323-00 | 6CJ-44323-00 | PLACA EXTERIOR | OUTER PLATE, CARTRIDGE | COPERCHIO POMPA D'ACQUA | PLAQUE DE POMPE À EAU |
| 50 | PAF15-00000013 | 93604-10M03 | PASADOR | PIN | SPINOTTO | PIN |
| 51 | REC6H3-44352-00 | 6H3-44352-00 | TURBINA | IMPELLER | GIRANTE | TURBINE |
| 52 | REC63D-44322-00 | 63D-44322-00 | TAPA, BOMBA AGUA | COVER, INNER WATER PUMP | COPERCHIO, POMPA ACQUA | INSERT DE POMPE À EAU |
| 53 | REC90119-08M14 | 90119-08M14 | TORNILLO CON ARANDELA | SCREW WITH WASHER | VITE CON RONDELLA | VIS AVEC RONDELLE |
| 54 | REC90119-08M33 | 90119-08M33 | TORNILLO CON ARANDELA | SCREW WITH WASHER | VITE CON RONDELLA | VIS AVEC RONDELLE |
| 55 | REC663-44366-00 | 663-44366-00 | GOMA DEL SELLO DE AGUA | DAMPER, WATER SEAL | GHIERA | JOINT DE TUBE D'EAU |
| 56 | REC63D-44312-00 | 63D-44312-00 | CUBIERTA CAJA DE BOMBA DE AGUA | PUMP COVER | COPERCHIO CORPO ACQUA | PLAQUE POMPE À EAU |
| 57 | PAT40-02000002 | 663-44367-00 | GOMA DEL SELLO DE AGUA | GUIDE BUSHING, WATER PIPE | PARAOLIO | JOINT CAOUTCHOU |

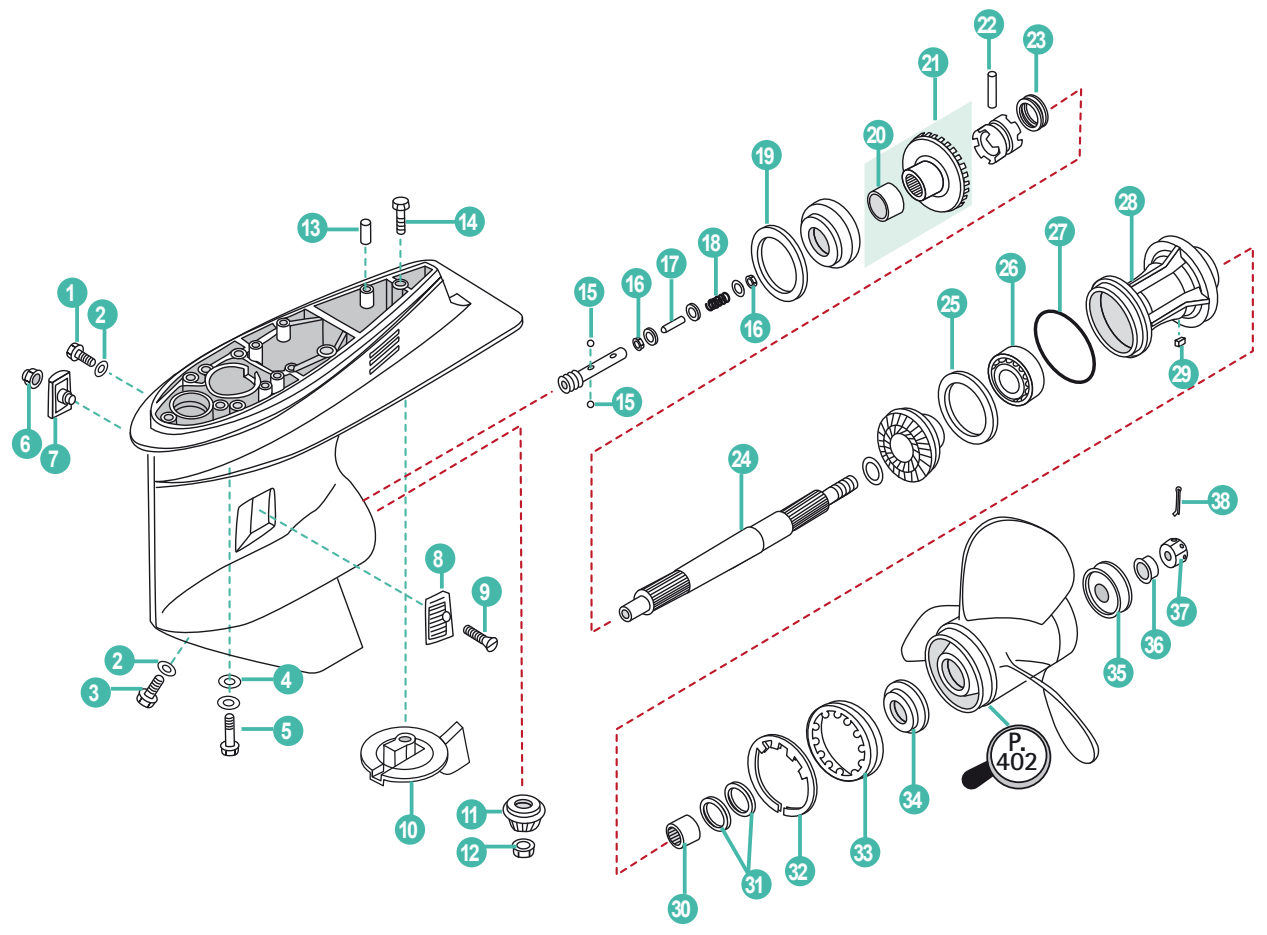

| REF | OEM |
|-----------------|--------------|
| REC67F-W0001-20 | 67F-W0001-20 |

P. 145

| REF | OEM |
|-----------------|--------------|
| REC67F-W0078-00 | 67F-W0078-00 |

P. 152

| REF |
|------------|
| REC80W90U3 |
| REC80W90U6 |
| RECGREU1 |
| RECGREU12 |

P. 43

| | REF | OEM | | | | |
|----|--------------------|-----------------|-------------------------|------------------------|-----------------------|-------------------------|
| 1 | REC90340-08002 | 90340-08002 | TORNILLO DRENAJE | BOLT, DISCHARGING OIL | VITE DRENAGGIO | BOUCHON DE VIDANGE |
| 2 | REC90430-08020 | 90430-08003 | JUNTA | GASKET | GUARNIZIONE | JOINT |
| 3 | REC688-45341-00 | 688-45341-10 | TORNILLO DRENAJE | BOLT, DISCHARGING OIL | VITE DRENAGGIO | BOUCHON DE VIDANGE |
| 4 | PAGB/T97.1-8 | 92995-10600 | ARANDELA | WASHER | RONDELLA | RONDELLE |
| 5 | REC97075-10040 | 97075-10040 | PERNO | STUD | BULLONE | BOULON |
| 6 | PAGB/T6182-M5 | 90185-05002 | TUERCA | LOCK NUT | DADO | ÉCROU |
| 7 | REC6H1-45215-00 | 6H1-45215-00 | CUBIERTA ENTRADA AGUA B | WATER INLET B | COPERCHIO ACQUA B | GRILLE D'ENTREE D'EAU B |
| 8 | REC6H1-45214-00 | 6H1-45214-00 | CUBIERTA ENTRADA AGUA A | WATER INLET A | COPERCHIO ACQUA A | GRILLE D'ENTREE D'EAU A |
| 9 | REC90151-05M00 | 90152-05000 | TORNILLO | SCREW | VITE | VIS |
| 10 | CM67F-45371-00A | 67F-45371-00 | ÁNODO | ANODE | ANODO | ANODE |
| 11 | REC6D9-45551-00 | 6D9-45551-00 | PIÑÓN ATAQUE | INITIATIVE GEAR | MARCIA INIZIATIVA | PIGNON D'ATTAQUE |
| 12 | REC90170-16M01 | 90170-16M01 | TUERCA | LOCK NUT | DADO | ÉCROU |
| 13 | REC93606-12019 | 93606-12019 | PASADOR | PIN | SPINOTTO | PIN |
| 14 | PAT85-00000012 | 90105-16M67 | PERNO | STUD | BULLONE | BOULON |
| 15 | REC93503-16003 | 93503-16003 | ESFERA | BALL | SFERA | BILLE |
| 16 | REC90183-02M03 | 90183-02M03 | TUERCA | LOCK NUT | DADO | ÉCROU |
| 17 | REC6H1-45668-00 | 6H1-45668-00 | EJE DEL ÉMBOLO | FREE SHAFT | BULLONE | ARBRE |
| 18 | REC90501-12M48 | 90501-12M48 | MUELLE | SPRING | MOLLA | RESSORT |
| 19 | PAT85-040000004-B | 688-45567-01 | GRUESO 0.10 mm | SHIM 0.10 mm | SPESSORE 0.10 mm | CALE 0.10 mm |
| 20 | REC93317-322V0 | 93317-322V0 | COJINETE | BEARING | CUSCINETTO | ROULEMENT |
| 21 | REC67F-45560-00 | 67F-45560-00 | PIÑÓN MARCHA AVANTE | POSITIVE GEAR ASSY | PIGNONE MARCIA AVANTI | PIGNON DE MARCHE AVANT |
| 22 | REC90250-07M02 | 90250-07M02 | PASADOR | PIN | SPINOTTO | PIN |
| 23 | REC688-45633-00 | 688-45633-00 | ANILLO DEL PASADOR | ANNULAR SPRING, CLUTCH | PARAOLIO | RESSORT |
| 24 | REC67F-45611-01 | 67F-45611-01 | EJE HÉLICE | PROPELLER SHAFT | ASSE ELICA | ARBRE D'HELICE |
| 25 | REC67F-45576-00 | 67F-45576-00 | ARANDELA | WASHER | RONDELLA | RONDELLE |
| 26 | REC93306-207U0 | 93306-207U0 | COJINETE | BEARING | CUSCINETTO | ROULEMENT |
| 27 | REC93210-86M39 | 93210-86M39 | TÓRICA | O-RING | O-RING | JOINT TORIQUE |
| 28 | REC67F-45331-00-CA | 67F-45331-00-94 | DIÁBOLO | BEARING | DIABOLO | DIABOLO |
| 29 | REC90282-04010 | 90282-04010 | CHAVETA RECTA | KEY | CHIAVETTA | CHAVETTE |
| 30 | REC93317-325U0 | 93317-325U0 | COJINETE | BEARING | CUSCINETTO | PALIER |
| 31 | REC93101-25M03 | 93101-25M03 | RETÉN DE ACEITE | OIL SEAL | PARAOLIO | JOINT SPI |
| 32 | REC688-45383-01 | 688-45383-02 | ARANDELA | WASHER | RONDELLA | RONDELLE |
| 33 | REC688-45384-00 | 688-45384-02 | TUERCA | NUT | DADO | ÉCROU |
| 34 | REC688-45987-00 | 688-45987-01 | ESPACIADOR | SPACER | DISTANZIALE | ENTRETOISE |
| 35 | REC67F-45997-00 | 67F-45997-00 | ESPACIADOR | SPACER | DISTANZIALE | ENTRETOISE |
| 36 | REC90389-25M00 | 90389-25M00 | CASQUILLO HÉLICE | WASHER | GHIERA ELICA | RONDELLE D'HELICE |
| 37 | REC90171-16011 | 90171-16011 | TUERCA | LOCK NUT | DADO | ÉCROU |
| 38 | REC91490-40030 | 91490-40025 | PASADOR | PIN | SPINOTTO | CLAVETTE |

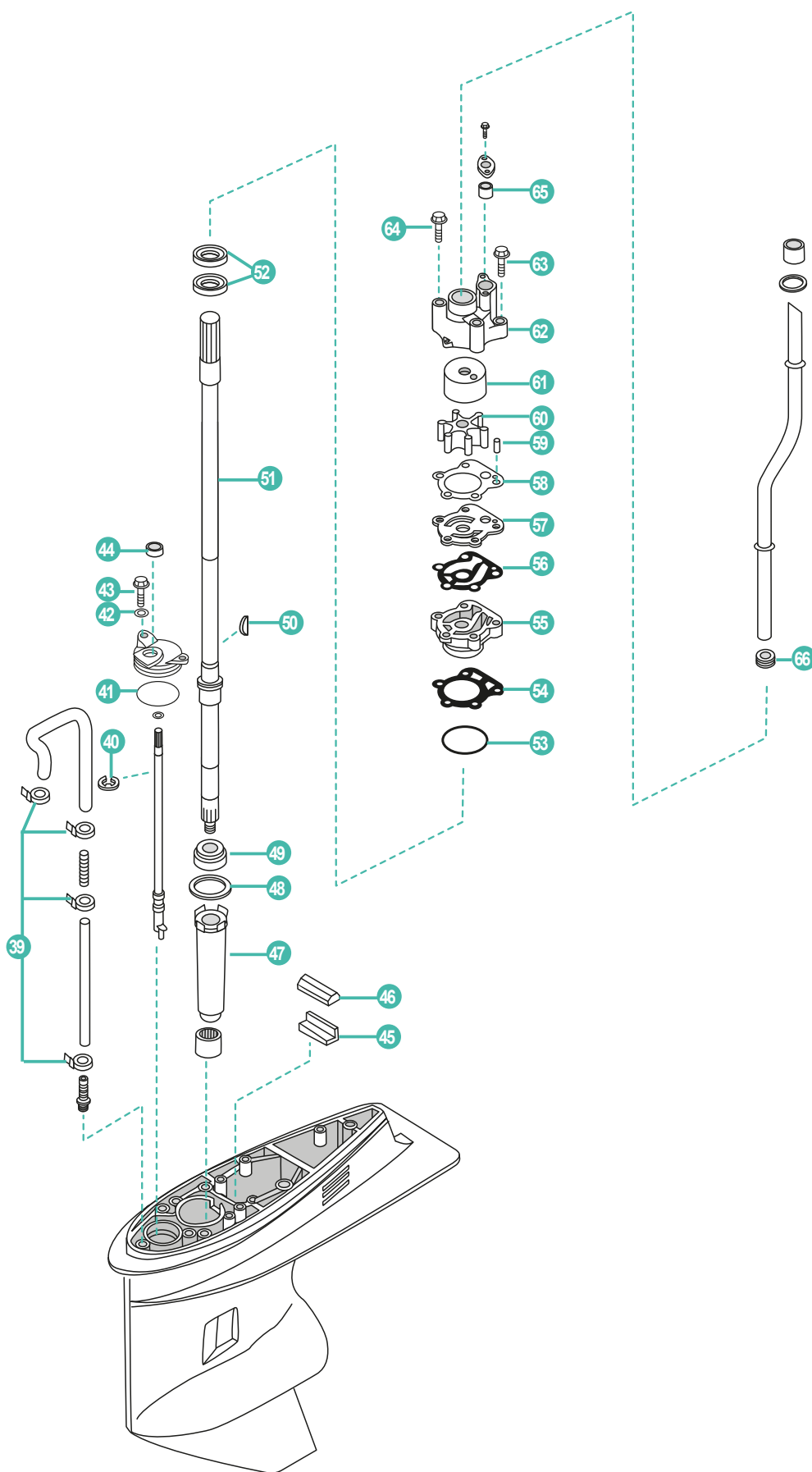

| | REF | OEM | | | | |
|----|-------------------|-----------------|------------------------------|---------------------------|--------------------------|----------------------------------|
| 39 | PAHT-2.5X60 | 90465-11M10 | BRIDA | CLAMP | FLANGIA | COLLIER |
| 40 | REC99001-08600-00 | 99001-08600 | ARANDELA | WASHER | RONDELLA | RONDELLE |
| 41 | REC93210-49046 | 93210-49046 | TÓRICA | O-RING | O-RING | JOINT TORIQUE |
| 42 | PAGB/T97.1-6 | 92995-06600 | ARANDELA | WASHER | RONDELLA | RONDELLE |
| 43 | PAGB/T5783-M6X16 | 97095-06016 | PERNO HEXAGONAL | HEXAGON BOLT | BULLONE ESSAGONALE | BOULON HEXAGONAL |
| 44 | REC93106-09014 | 93106-09014 | RETÉN DE ACEITE | OIL SEAL | PARAOLIO | JOINT SPI |
| 45 | REC663-45376-00 | 663-45376-00-94 | GUÍA SELLO DE GOMA | GUIDE RUB. SEAL | GUIDA PARAOLIO | GUIDE |
| 46 | REC688-45375-00 | 63D-45375-00 | RETEN DAMPER | DAMPER WASHER | PARAOLIO DAMPER | JOINT SILENT BLOC |
| 47 | REC688-45536-01 | 688-45536-01 | CAMISA EJE | SLEEVE, DRIVE | TUBO GUIDA | RONDELLE |
| 48 | PAT85-040000003-B | 688-45587-01 | GRUESO 0.10 mm | SHIM 0.10 mm | SPESSORE 0.10 mm | CALE 0.10 mm |
| 49 | REC93332-000U3 | 93332-000U3 | COJINETE | BEARING | CUSCINETTO | ROULEMENT |
| 50 | REC90280-04M04 | 90280-04M04 | CUÑA | KEY WOODRUFF | CHIAVETTA | CLAVETTE |
| 51 | REC67F-45501-10 | 67F-45501-10 | EJE VERTICAL L (21,1") | DRIVE SHAFT L (21,1") | ALBERO TRANSON L (21,1") | ARBRE VERTICAL L (21,1") |
| 52 | REC93101-25M03 | 93101-25M03 | RETÉN DE ACEITE | OIL SEAL | PARAOLIO | JOINT SPI |
| 53 | REC93210-46044 | 93210-46044 | TÓRICA | O-RING | O-RING | JOINT TORIQUE |
| 54 | REC688-44316-00 | 688-44316-00 | JUNTA | GASKET | GUARNIZIONE | JOINT |
| 55 | REC688-44341-01 | 6D8-44341-01 | CUERPO RETENES BOMBA DE AGUA | HOUSING WATER PUMP | CORPO POMPA | BASE DE POMPE À EAU |
| 56 | REC688-44324-00 | 688-44324-A0 | JUNTA | GASKET | GUARNIZIONE | JOINT |
| 57 | REC67F-44323-00 | 67F-44323-00 | PLACA EXTERIOR | WEAR PLATE | COPERCHIO | PLAQUE DE POMPE À EAU |
| 58 | REC688-44315-00 | 688-44315-A0 | JUNTA | GASKET | GUARNIZIONE | JOINT |
| 59 | PAF25-04000007 | 93604-10M03 | PASADOR | PIN | SPINOTTO | LEVIER |
| 60 | REC67F-44352-00 | 67F-44352-00 | TURBINA | IMPELLER | GIRANTE | TURBINE |
| 61 | REC67F-44322-00 | 67F-44322-00 | TAPA, BOMBA AGUA | COVER, INNER WATER PUMP | COPERCHIO, POMPE ACQUA | INSERT DE POMPE À EAU |
| 62 | REC67F-44311-01 | 67F-44311-00 | CUERPO BOMBA AGUA | HOUSING, WATER PUMP | CORPO POMPA | CORPS DE POMPE À EAU |
| 63 | REC90119-08M13 | 90119-08M13 | TORNILLO CON ARANDELA | SCREW WITH WASHER | VITE CON RONDELLA | VIS AVEC RONDELLE |
| 64 | REC90119-08M87 | 90119-08M87 | TORNILLO CON ARANDELA | SCREW WITH WASHER | VITE CON RONDELLA | VIS AVEC RONDELLE |
| 65 | REC663-44366-00 | 663-44366-00 | RETEN TUBO AGUA | DAMPER, WATER SEAL | GHIERA | JOINT DE TUBE D'EAU |
| 66 | PAT40-02000002 | 663-44367-00 | GOMA DEL SELLO DE AGUA | GUIDE BUSHING, WATER PIPE | PARAOLIO | MAUCHON CAOUTCHOUC DE PIPE D'EAU |

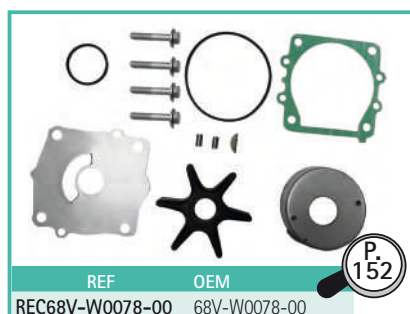
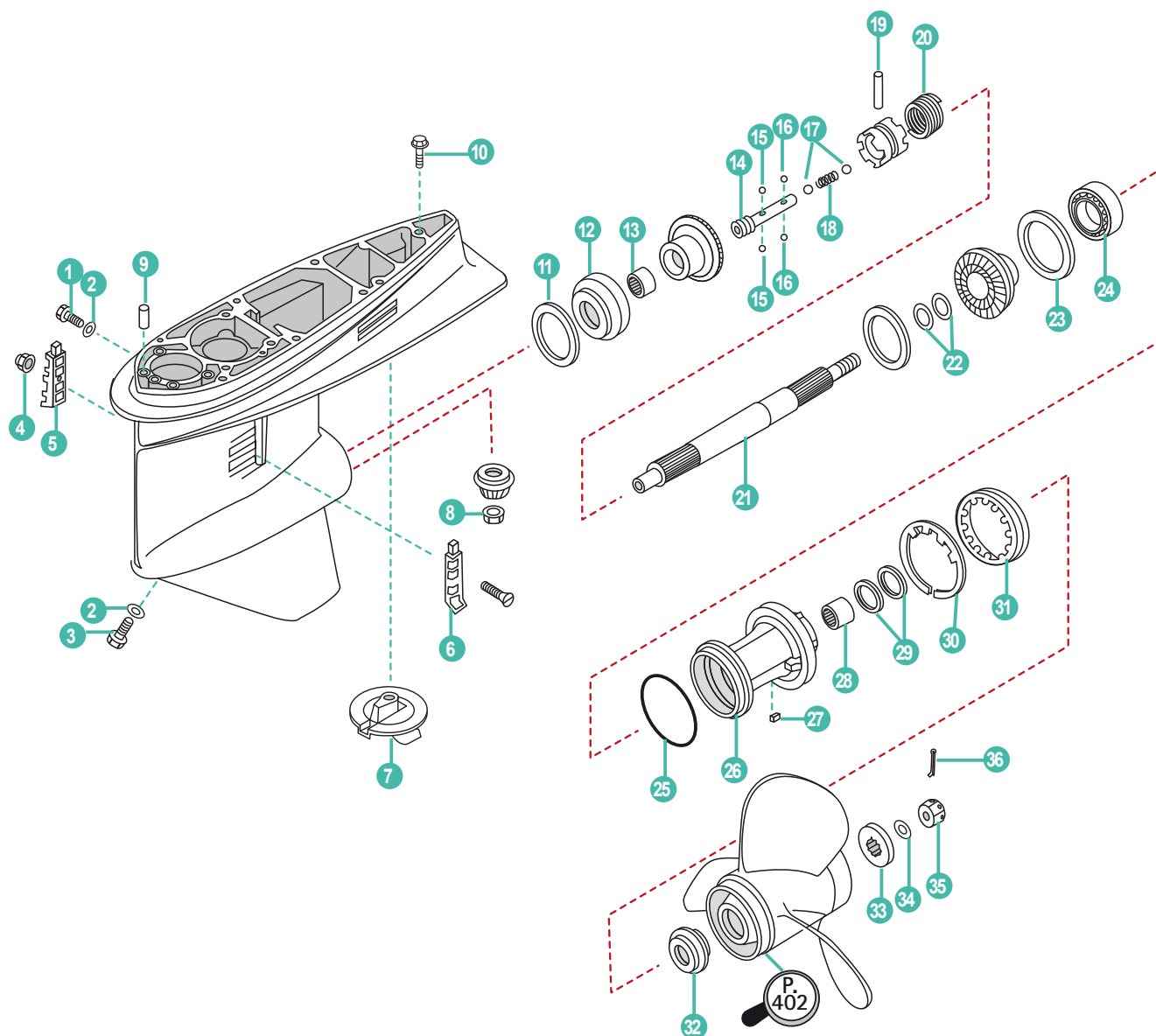

| | REF | OEM | | | | |
|----|--------------------|-----------------|----------------------------|-------------------------|-----------------------------|--------------------------|
| 1 | REC90340-08002 | 90340-08002 | TORNILLO DRENAJE | BOLT, DISCHARGING OIL | VITE DRENAGGIO | BOUCHON DE VIDANGE |
| 2 | REC90430-08020 | 90430-08003 | JUNTA | GASKET | GUARNIZIONE | JOINT |
| 3 | REC688-45341-00 | 688-45341-10 | TORNILLO DRENAJE | BOLT, DISCHARGING OIL | VITE DRENAGGIO | BOUCHON DE VIDANGE |
| 4 | PAGB/T6182-M5 | 90185-05002 | TUERCA | LOCK NUT | DADO | ÉCROU |
| 5 | REC688-45215-02 | 688-45215-02 | CUBIERTA ENTRADA AGUA B | WATER INLET B | COPERCHIO ACQUA B | GRILLE D'ENTREE D'EAU B |
| 6 | REC688-45214-02 | 688-45214-02 | CUBIERTA ENTRADA AGUA A | WATER INLET A | COPERCHIO ACQUA A | GRILLE D'ENTREE D'EAU A |
| 7 | CM6E5-45371-01A | 6E5-45371-00 | ÁNODO | ANODE | ANODO | ANODE |
| 8 | REC90170-16M01 | 90170-16M01 | TUERCA | LOCK NUT | DADO | ÉCROU |
| 9 | REC93608-12M05 | 93608-12M05 | PASADOR | PIN | SPINOTTO | PIN |
| 10 | PAT85-00000012 | 90105-10M00 | TORNILLO | SCREW | VITE | VIS |
| 11 | REC6E5-45567-01 | 6E5-45567-01 | KIT GRUESOS 0.12 - 0.50 mm | SHIM SET 0.12 - 0.50 mm | KIT SPESSORI 0.12 - 0.50 mm | KIT CALES 0.12 - 0.50 mm |
| 12 | REC93332-000U7 | 93332-000U7 | COJINETE | BEARING | CUSCINETTO | ROULEMENT |
| 13 | REC93315-425U7 | 93315-425U7 | COJINETE | BEARING | CUSCINETTO | ROULEMENT |
| 14 | REC6E5-45634-01 | 6E5-45634-01 | PASADOR DESPLAZABLE | SLIDE SHIFT | SPINOTTO SCORREVOLE | PIN REGLABLE |
| 15 | REC93507-32031 | 93507-32009 | ESFERA | BALL | SFERA | BILLE |
| 16 | REC93503-16003 | 93503-16003 | ESFERA | BALL | SFERA | BILLE |
| 17 | REC93511-32027 | 93511-32027 | ESFERA | BALL | SFERA | BILLE |
| 18 | REC90501-16M37 | 90501-16M37 | MUELLE | SPRING | MOLLA | RESSORT |
| 19 | REC90250-08M07 | 90250-08M07 | PASADOR | PIN | SPINOTTO | LEVIER |
| 20 | REC6E5-45633-01 | 6E5-45633-01 | ANILLO DEL PASADOR | ANNULAR SPRING, CLUTCH | ANELLO SELETTORE | RESSORT |
| 21 | REC6E5-45611-00 | 6E5-45611-00 | EJE HÉLICE | PROPELLER SHAFT | ASSE ELICA | ARBRE D'HELICE |
| 22 | REC90201-30M92 | 90201-30M92 | ARANDELA | WASHER | RONDELLA | RONDELLE |
| 23 | REC6E5-45576-00 | 6E5-45576-00 | ARANDELA | WASHER | RONDELLA | RONDELLE |
| 24 | REC93306-208U0 | 93306-208U0 | COJINETE | BEARING | CUSCINETTO | ROULEMENT |
| 25 | REC93210-86M39 | 93210-86M39 | TÓRICA | O-RING | O-RING | JOINT TORIQUE |
| 26 | REC6E5-45332-00-94 | 6E5-45332-00-CA | DIÁBOLO | GEAR HOUSING | DIABOLO | DIABOLO |
| 27 | REC90282-04010 | 90282-04010 | CHAVETA RECTA | KEY | CHIAVETTA | CHAVETTE |
| 28 | REC93315-430U8 | 93315-430U8 | COJINETE | BEARING | CUSCINETTO | ROULEMENT |
| 29 | REC93101-30M17 | 93101-30M17 | RETÉN DE ACEITE | OIL SEAL | PARAOLIO | JOINT SPI |
| 30 | REC688-45383-01 | 688-45383-02 | ARANDELA | WASHER | RONDELLA | RONDELLE |
| 31 | REC688-45384-00 | 688-45384-02 | TUERCA | NUT | DADO | ÉCROU |
| 32 | REC6E5-45987-00 | 63P-45987-00 | ESPACIADOR | SPACER | DISTANZIALE | ENTRETOISE |
| 33 | REC688-45997-00 | 688-45997-01 | ESPACIADOR | SPACER | DISTANZIALE | ENTRETOISE |
| 34 | REC92990-18200 | 92990-18200 | ARANDELA | WASHER | RONDELLA | RONDELLE |
| 35 | REC90171-18M04 | 90171-18M04 | TUERCA | LOCK NUT | DADO | ÉCROU |
| 36 | REC91490-40030 | 91490-40030 | PASADOR | PIN | SPINOTTO | CLAVETTE |

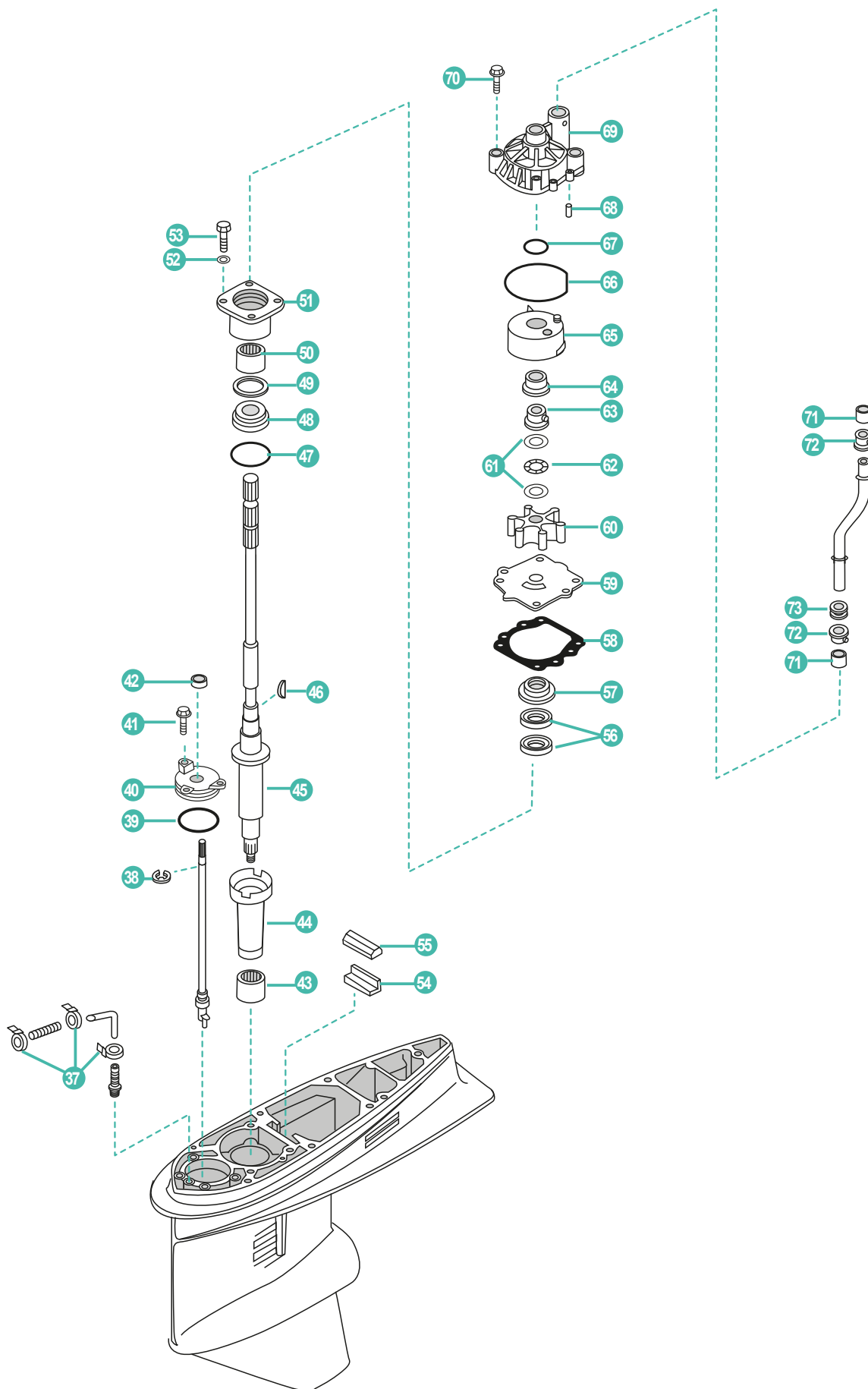

| | REF | OEM | | | | |
|----|--------------------|-----------------|--------------------------------|----------------------------|--------------------------------|-------------------------------|
| 37 | PAHT-2.5X60 | 90465-11M10 | BRIDA | CLAMP | FLANGIA | COLLIER |
| 38 | REC99001-08600-00 | 99001-08600 | ARANDELA | WASHER | RONDELLA | RONDELLE |
| 39 | REC93210-58677 | 93210-58144 | TÓRICA | O-RING | O-RING | JOINT TORIQUE |
| 40 | REC6E5-45321-00 | 6E5-45321-00 | TAPA CAMBIO | PLATE | COPERCHIO CAMBIO | COUVERCLE |
| 41 | REC90119-06M10 | 90119-06M10 | TORNILLO CON ARANDELA | SCREW WITH WASHER | VITE CON RONDELLA | VIS AVEC RONDELLE |
| 42 | REC93106-09014 | 93106-09014 | RETÉN DE ACEITE | OIL SEAL | PARAOLIO | JOINT SPI |
| 43 | REC93315-628U9 | 93315-628U9 | COJINETE | BEARING | CUSCINETTO | ROULEMENT |
| 44 | REC6E5-45536-00 | 6E5-45536-00 | CAMISA EJE DE MANDO | SLEEVE | CAMICIA | BAGUE |
| 45 | REC68V-45501-10 | 68V-45501-10 | EJE TRANSMISION L 20.3" | DRIVE SHAFT L 20.3" | ASSE TRASMISSIONE L 20,3" | ARBRE DE TRANSMISSION L 20,3" |
| 46 | REC90280-04M05 | 90280-04M05 | CUÑA | KEY WOODRUFF | CHIAVETTA | CLAVETTE |
| 47 | REC93210-54534 | 93210-55M14 | TÓRICA | O-RING | O-RING | JOINT TORIQUE |
| 48 | REC93341-930V2 | 93341-930V2 | COJINETE | BEARING | CUSCINETTO | ROULEMENT |
| 49 | REC6E5-45587-01 | 6E5-45587-01 | KIT GRUESOS 0.12 - 0.50 mm | SHIM SET 0.12 - 0.50 mm | KIT SPESSORI 0.12 - 0.50 mm | KIT CALES 0.12 - 50 mm |
| 50 | REC93317-330U2 | 93317-330U2 | COJINETE | BEARING | CUSCINETTO | ROULEMENT |
| 51 | REC6E5-45331-00-94 | 6E5-45331-00-9S | DIÁBOLO | GEAR HOUSING | DIABOLO | DIABOLO |
| 52 | PAGB/T97.1-8 | 92995-08600 | ARANDELA | WASHER | RONDELLA | RONDELLE |
| 53 | PAGB/T5783-M8X25 | 97095-08025 | PERNO | BOLT | VOTE | BOULON |
| 54 | REC663-45376-00 | 663-45376-00 | GUÍA SELLO DE GOMA | GUIDE RUB. SEAL | GUIDA PARAOLIO | GUIDE |
| 55 | REC688-45375-00 | 63D-45375-00 | RETEN DAMPER | DAMPER WASHER | PARAOLIO DAMPER | JOINT SILENT BLOC |
| 56 | REC93101-28M16 | 93101-28M16 | RETÉN DE ACEITE | OIL SEAL | PARAOLIO | JOINT SPI |
| 57 | REC6E5-45344-00 | 6E5-45344-00 | TAPA RETEN | RETAINER | COPERCHIO PARAOLIO | RETENUE |
| 58 | REC6E5-44315-A0 | 6E5-44315-A0 | JUNTA | GASKET | GUARNIZIONE | JOINT |
| 59 | REC68V-44323-00 | 6EK-44323-00 | TAPA BOMBA | OUTER PLATE | COPERCHIO POMPA | PLAQUE DE POMPE À EAU |
| 60 | REC6E5-44352-01 | 6E5-44352-01 | TURBINA | IMPELLER | GIRANTE | TURBINE |
| 61 | REC90201-22M01 | 90201-22M01 | ARANDELA | WASHER | RONDELLA | RONDELLE |
| 62 | REC90206-22M19 | 90206-22M19 | ARANDELA ONDULADA | WAVE WASHER | RONDELLA ONDULATA | RONDELLE |
| 63 | REC61A-45538-00 | 61A-45538-00 | ESPACIADOR | SPACER | SPESSORE | ENTRETOISE |
| 64 | REC61A-45527-00 | 61A-45527-00 | CASQUILLO CUERPO BOMBA | COLLAR | BOCCOLA CORPO POMPA | BAGUE POMPE À EAU |
| 65 | REC61A-44322-02 | 61A-44322-02 | TAPA, BOMBA AGUA | COVER, INNER WATER PUMP | COPERCHIO, POMPE D'EAU | INSERT DE POMPE À EAU |
| 66 | REC93210-86M38 | 93210-86M38 | TÓRICA | O-RING | O-RING | JOINT TORIQUE |
| 67 | REC93210-37160 | 93210-37160 | TÓRICA | O-RING | O-RING | JOINT TORIQUE |
| 68 | REC93606-12019 | 93606-12019 | PASADOR | PIN | SPINOTTO | LEVIER |
| 69 | REC61A-44311-00 | 61A-44311-01 | CUERPO BOMBA AGUA | HOUSING, WATER PUMP | CORPO POMPA | CORPS DE POMPE À EAU |
| 70 | REC90119-08M14 | 90119-08M14 | TORNILLO CON ARANDELA | SCREW WITH WASHER | VITE CON RONDELLA | VIS AVEC RONDELLE |
| 71 | REC6E5-44365-00 | 6E5-44365-00 | GOMA DEL SELLO DE AGUA | DAMPER WATER TUBE | GUARNIZIONE | BAGUE DE TUBE D'EAU |
| 72 | REC6E5-44312-00 | 6E5-44312-00 | CUBIERTA CAJA DE BOMBA DE AGUA | PUMP COVER | COPERCHIO CORPO ACQUA | PLAQUE POMPE À EAU |
| 73 | REC6E5-44366-00 | 6E5-44366-00 | FLECTOR | DAMPER WATER SEAL | GUARNIZIONE | JOINT |

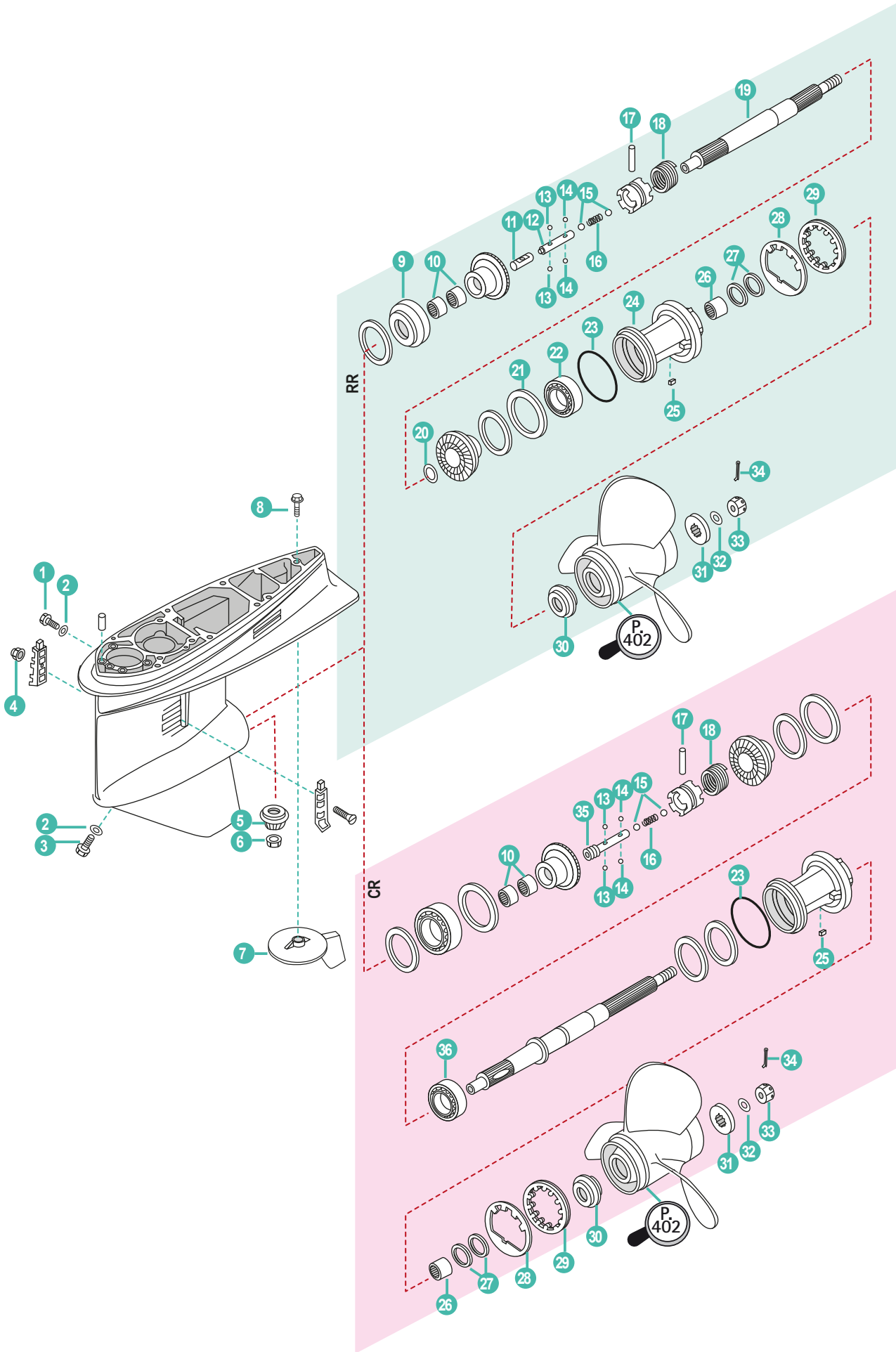

| REF | OEM | | | | |
|-----------------------|-----------------|--|--|------------------------------------|--|
| REC416-B20F | 63P-45300-02-8D | CONJUNTO INFERIOR RR (L) SÓLO PARA F150 | COMPLETE GEARCASE V6 (L) ONLY F150 | PIEDE COMPLETO (L) SOLO F150 | EMBASE COMPLETE (L) POUR F150 |
| REC416-B25F | 63P-45300-12-8D | CONJUNTO INFERIOR RR (X) SÓLO PARA F150 | COMPLETE GEARCASE V6 (X) ONLY F150 | PIEDE COMPLETO V6 (X) SOLO F150 | EMBASE COMPLETE V6 (X) POUR F150 |
| REC418-B25F | 64P-45300-12-8D | CONJUNTO INFERIOR CR (X) SÓLO PARA F150 | COMPLETE GEARCASE V6 CR (X) ONLY F150 | PIEDE COMPLETE CR (X) FOLO F150 | EMBASE COMPLETE CONTRE ROTATION (X) POUR F150 |
| 1 REC90340-08002 | 90304-08002 | TORNILLO DRENAJE | BOLT, DISCHARGING OIL | VITE DRENAGGIO | BOUCHON DE VIDANGE |
| 2 REC90430-08020 | 90430-08020 | JUNTA | GASKET | GUARNIZIONE | JOINT |
| 3 REC688-45341-00 | 688-45341-10 | TORNILLO DRENAJE | BOLT, DISCHARGING OIL | VITE DRENAGGIO | BOUCHON DE VIDANGE |
| 4 PAGB/T6182-M5 | 90185-05002 | TUERCA | LOCK NUT | DADO | ÉCROU |
| 5 REC63P-45551-00 | 63P-45551-00 | PIÑÓN ATAQUE | INITIATIVE GEAR | MARCIA INIZIATIVA | PIGNON D'ATTAQUE |
| 6 REC90170-16M01 | 90170-16M01 | TUERCA | LOCK NUT | DADO | ÉCROU |
| 7 CM6J9-45371-01A | 6J9-45371-01 | ÁNODO | ANODE | ANODO | ANODE |
| 8 PAT85-00000012 | 90105-10M00 | TORNILLO | SCREW | VITE | VIS |
| 9 REC93332-000V3 | 93332-000V3 | COJINETE | BEARING | CUSCINETTO | ROULEMENT |
| 10 REC93315-425V3 | 93315-425V3 | COJINETE | BEARING | CUSCINETTO | ROULEMENT |
| 11 REC6E5-45641-03 | 6E5-45641-03 | EJE | SHAFT | ASSE | ARBRE |
| 12 REC6E5-45634-01 | 6E5-45634-01 | PASADOR DESPLAZABLE | SLIDE SHIFT | SPINOTTO SCORREVOLE | PIN REGLABLE |
| 13 REC93507-32031 | 93507-32009 | ESFERA | BALL | SFERA | BILLE |
| 14 REC93503-16003 | 93503-16003 | ESFERA | BALL | SFERA | BILLE |
| 15 REC93511-32027 | 93511-32017 | ESFERA | BALL | SFERA | BILLE |
| 16 REC90501-16M37 | 90501-16M37 | MUELLE | SPRING | MOLLA | RESSORT |
| 17 REC90250-08M07 | 90250-08M07 | PASADOR | PIN | SPINOTTO | PIN |
| 18 REC6E5-45633-01 | 6E5-45633-01 | ANILLO DEL PASADOR | ANNULAR SPRING, CLUTCH | ANELLO | RESSORT |
| 19 REC6J9-45611-00 | 6J9-45611-01 | EJE HÉLICE | PROPELLER SHAFT | ASSE ELICA | ARBRE D'HELICE |
| 20 REC90201-30M92 | 90201-30M92 | ARANDELA | WASHER | RONDELLA | RONDELLE |
| 21 REC6G5-45576-10 | 6G5-45576-10 | ARANDELA EMPUJE | WASHER, THRUST | RONDELLA DI SPINTA | RONDELLE D'APPUI |
| 22 REC93306-209U0 | 93306-209U0 | COJINETE | BEARING | CUSCINETTO | ROULEMENT |
| 23 REC93210-97M55 | 93210-97M55 | TÓRICA | O-RING | O-RING | JOINT TORIQUE |
| 24 REC6J9-45332-00-CA | 6J9-45332-00-CA | DIÁBOLO | GEAR HOUSING | DIABOLO | DIABOLO |
| 25 REC90282-04M00 | 90282-04M00 | CHAVETA RECTA | KEY | CHIAVETTA | CLAVETTE |
| 26 REC93315-43061 | 93315-43061 | COJINETE | BEARING | CUSCINETTO | ROULEMENT |
| 27 REC93101-30M17 | 93101-30M17 | RETÉN DE ACEITE | OIL SEAL | PARAOLIO | JOINT SPI |
| 28 REC6G5-45383-01 | 6G5-45383-01 | ARANDELA | WASHER | RONDELLA | RONDELLE |
| 29 REC6G5-45384-00 | 6G5-45384-00 | TUERCA | NUT | DADO | ÉCROU |
| 30 REC6E5-45987-00 | 63P-45987-00 | ESPACIADOR | SPACER | DISTANZIALE | ENTRETOISE |
| 31 REC688-45997-00 | 688-45997-01 | ESPACIADOR | SPACER | DISTANZIALE | ENTRETOISE |
| 32 REC92990-18200 | 92990-18200 | ARANDELA | WASHER | RONDELLA | RONDELLE |
| 33 REC90171-18M04 | 90171-18M04 | TUERCA | LOCK NUT | DADO | ÉCROU |
| 34 REC91490-40030 | 91490-40030 | PASADOR | PIN | SPINOTTO | CLAVETTE |
| | | CONTRA ROTACIÓN | COUNTER ROTATION | CONTRO ROTANTE | CONTRE |
| 35 REC6E5-45634-01 | 6E5-45634-02 | DESGLIZADOR CAMBIO | SLIDE SHIFT | SPINOTTO SCORREVOLE | PIN REGLABLE |
| 36 REC93332-00048 | 93332-00048 | COJINETE | BEARING | CUSCINETTO | ROULEMENT |

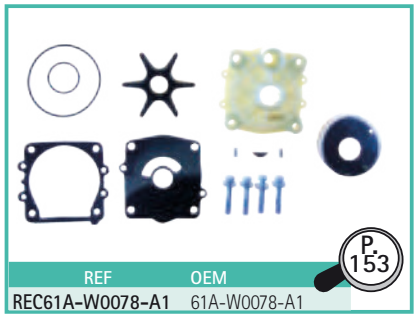
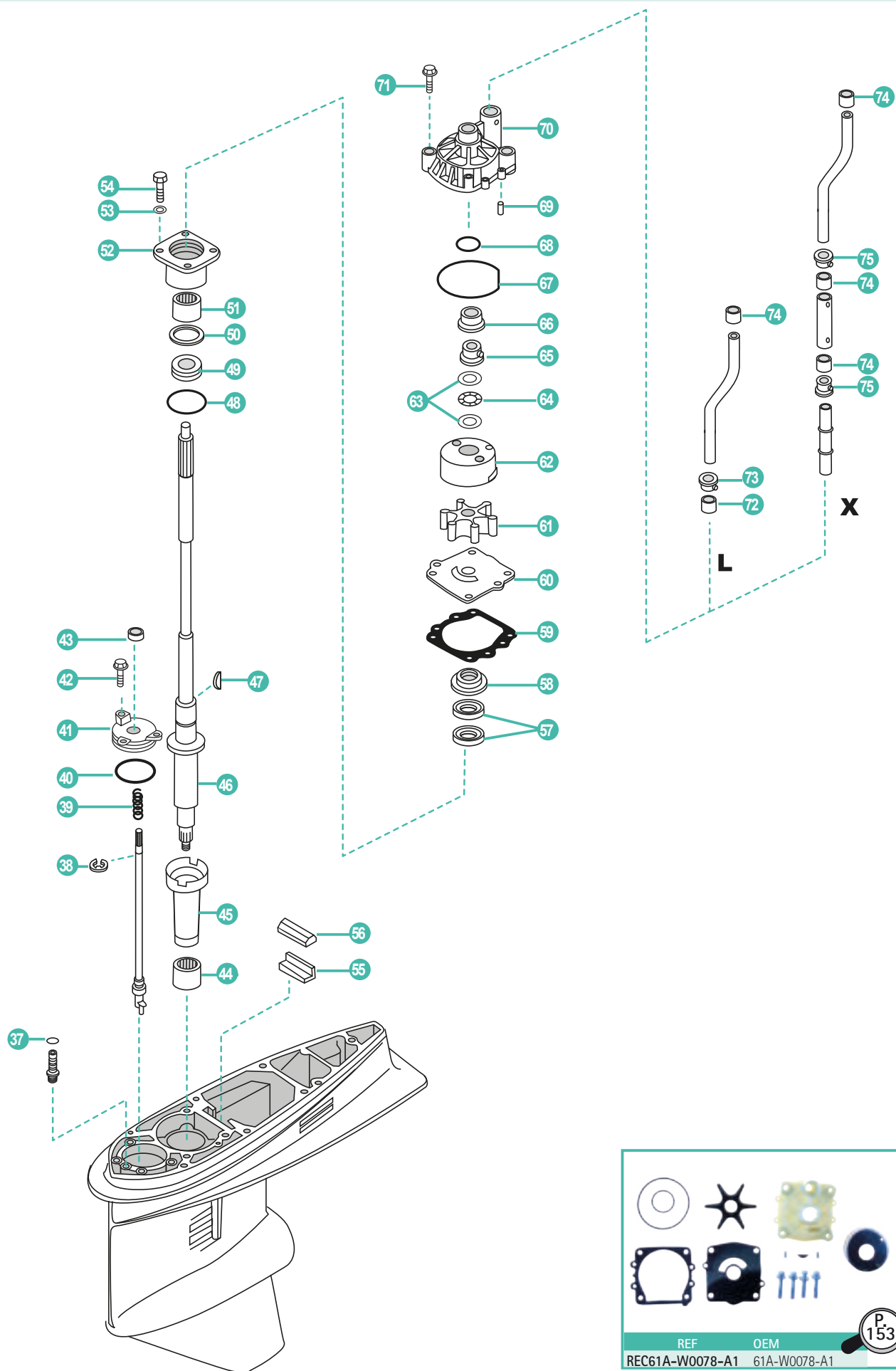

| | REF | OEM | | | | |
|----|--------------------|-----------------|---------------------------------------|----------------------------|--------------------------------|----------------------------|
| 37 | REC93210-07540 | 93210-07003 | TÓRICA | O-RING | O-RING | JOINT TORIQUE |
| 38 | REC99001-08600-00 | 99001-08600 | CLIP | CLIP | CLIP | CLIP |
| 39 | REC90501-11M10-00 | 90501-11M10 | RESORTE DE COMPRESIÓN | SPRING | MOLLA | RESSORT |
| 40 | REC93210-58677 | 93210-58144 | TÓRICA | O-RING | O-RING | JOINT TORQUE |
| 41 | REC6E5-45321-00 | 6E5-45321-00 | TAPA CAMBIO | PLATE | COPERCHIO CAMBIO | COUVERCLE |
| 42 | REC90119-06M10 | 90119-06M10 | TORNILLO CON ARANDELA | SCREW WITH WASHER | VITE CON RONDELLA | VIS AVEC RONDELLE |
| 43 | REC93106-09014 | 93106-09014 | RETÉN DE ACEITE | OIL SEAL | PARAOLIO | JOINT SPI |
| 44 | REC93311-928U5 | 93311-928U5 | COJINETE | BEARING | CUSCINETTO | ROULEMENT |
| 45 | REC6E5-45536-00 | 6E5-45536-01 | CAMISA EJE DE MANDO | SLEEVE | CAMICIA | BAGUE |
| 46 | REC63P-45501-00 | 63P-45501-00 | EJE TRASMISION 20" (L) | DRIVE SHAFT 20" (L) | ALBERO DI TRASMISSIONE 20" (L) | ARBRE TRASMISION 20" (L) |
| | REC63P-45501-10 | 63P-45501-10 | EJE TRASMISION 25" (X) | DRIVE SHAFT 25" (X) | ALBERO DI TRASMISSIONE 25" (X) | ARBRE TRASMISION 25" (X) |
| 47 | REC90280-04M05 | 90280-04M05 | CUÑA | KEY WOODRUFF | CHIAVETTA | CLAVETTE |
| 48 | REC93210-54534 | 93210-55M14 | TÓRICA | O-RING | O-RING | JOINT TORIQUE |
| 49 | REC93341-930V2 | 93341-930V2 | COJINETE | BEARING | CUSCINETTO | ROULEMENT |
| 50 | REC6E5-45587-01 | 6E5-45587-01 | KIT GRUESOS 0.10 - 0.50 mm | SHIM SET 0.10 - 0.50 mm | KIT SPESSORI 0.10 - 0.50 mm | KIT CALES 0.10- 0.50 mm |
| 51 | REC93317-330U2 | 93317-330U2 | COJINETE | BEARING | CUSCINETTO | ROULEMENT |
| 52 | REC6E5-45331-00-94 | 6E5-45331-00-95 | DIÁBOLO | GEAR HOUSING | DIABOLO | DIABOLO |
| 53 | PAGB/T97.1-8 | 92995-08600 | ARANDELA | WASHER | RONDELLA | RONDELLE |
| 54 | PAGB/T5783-M8X25 | 97095-08025 | PERNO | BOLT | BULLONE | BOULON |
| 55 | REC663-45376-00 | 663-45376-00-94 | GUÍA SELLO DE GOMA | GUIDE RUB. SEAL | GUIDA PARAOLIO | GUIDE |
| 56 | REC688-45375-00 | 688-45375-00 | RETEN DAMPER | DAMPER WASHER | PARAOLIO DAMPER | JOINT SILENT BLOC |
| 57 | REC93101-28M16 | 93101-28M16 | RETÉN DE ACEITE | OIL SEAL | PARAOLIO | JOINT SPI |
| 58 | REC6E5-45344-00 | 6E5-45344-00 | CUBIERTA SELLO DE ACEITE | RETAINER | COPERCHIO PARAOLIO | RETENUE |
| 59 | REC6E5-44315-A0 | 6E5-44315-A0 | JUNTA | GASKET | GUARNIZIONE | JOINT |
| 60 | REC6G5-44323-00 | 6G5-44323-00 | PLACA EXTERIOR DEL CARTUCHO | OUTER PLATE | COPERCHIO POMPA | PLAQUE DE POMPE À EAU |
| 61 | REC6E5-44352-01 | 6E5-44352-01 | TURBINA | IMPELLER | GIRANTE | TURBINE |
| 62 | REC61A-44322-02 | 61A-44322-02 | ACOPLE INOX | INSERT CARTRIDGE | ACCOPIAMENTO INOX | INSERT DE POMPE À EAU |
| 63 | REC90201-22M01 | 90201-22M01 | ARANDELA | WASHER | RONDELLA | RONDELLE |
| 64 | REC90206-22M19 | 90206-22M19 | ARANDELA ONDULADA | WAVE WASHER | RONDELLA ONDULATA | RONDELLE |
| 65 | REC61A-45538-00 | 61A-45538-00 | ESPACIADOR | SPACER | SPESSORE | ENTRETOISE |
| 66 | REC61A-45527-00 | 61A-45527-00 | CASQUILLO CUERPO BOMBA | COLLAR | BOCCOLA CORPO POMPA | BAGUE POMPE À EAU |
| 67 | REC93210-86M38 | 93210-86M38 | TÓRICA | O-RING | O-RING | JOINT TORIQUE |
| 68 | REC93210-37160 | 93210-37160 | TÓRICA | O-RING | O-RING | JOINT TORIQUE |
| 69 | REC93606-12019 | 93606-12019 | PASADOR | PIN | SPINOTTO | PIN |
| 70 | REC61A-44311-00 | 61A-44311-01 | CUERPO BOMBA AGUA | HOUSING, WATER PUMP | CORPO POMPA | CORPS DE POMPE À EAU |
| 71 | REC90119-08M14 | 90119-08M14 | TORNILLO CON ARANDELA | SCREW WITH WASHER | VITE CON RONDELLA | VIS AVEC RONDELLE |
| 72 | REC6E5-44365-00 | 6E5-44365-00 | GOMA DEL SELLO DE AGUA | DAMPER WATER TUBE | GUARNIZIONE | BAGUE DE TUBE D'EAU |
| 73 | REC6E5-44312-00 | 6E5-44312-00 | CUBIERTA CAJA DE BOMBA DE AGUA (L) | WATER PUMP COVER (L) | COPERCHIO POMPA ACQUA (L) | GUIDE DE TBE D'EAU (L) |
| 74 | REC6E5-44365-00 | 6E5-44365-00 | GOMA TUBO AGUA | DAMPER WATER TUBE | GUARNIZIONE | BAGUE DE TUBE D'EAU |
| 75 | REC6E5-44312-00 | 6E5-44312-00 | CUBIERTA CAJA DE BOMBA DE AGUA (X) | WATER PUMP COVER (X) | COPERCHIO POMPA ACQUA (X) | GUIDE DE TUBE D'EAU (X) |



REF
REC80W90U3
REC80W90U6
RECGREU1
RECGREU12

P
43

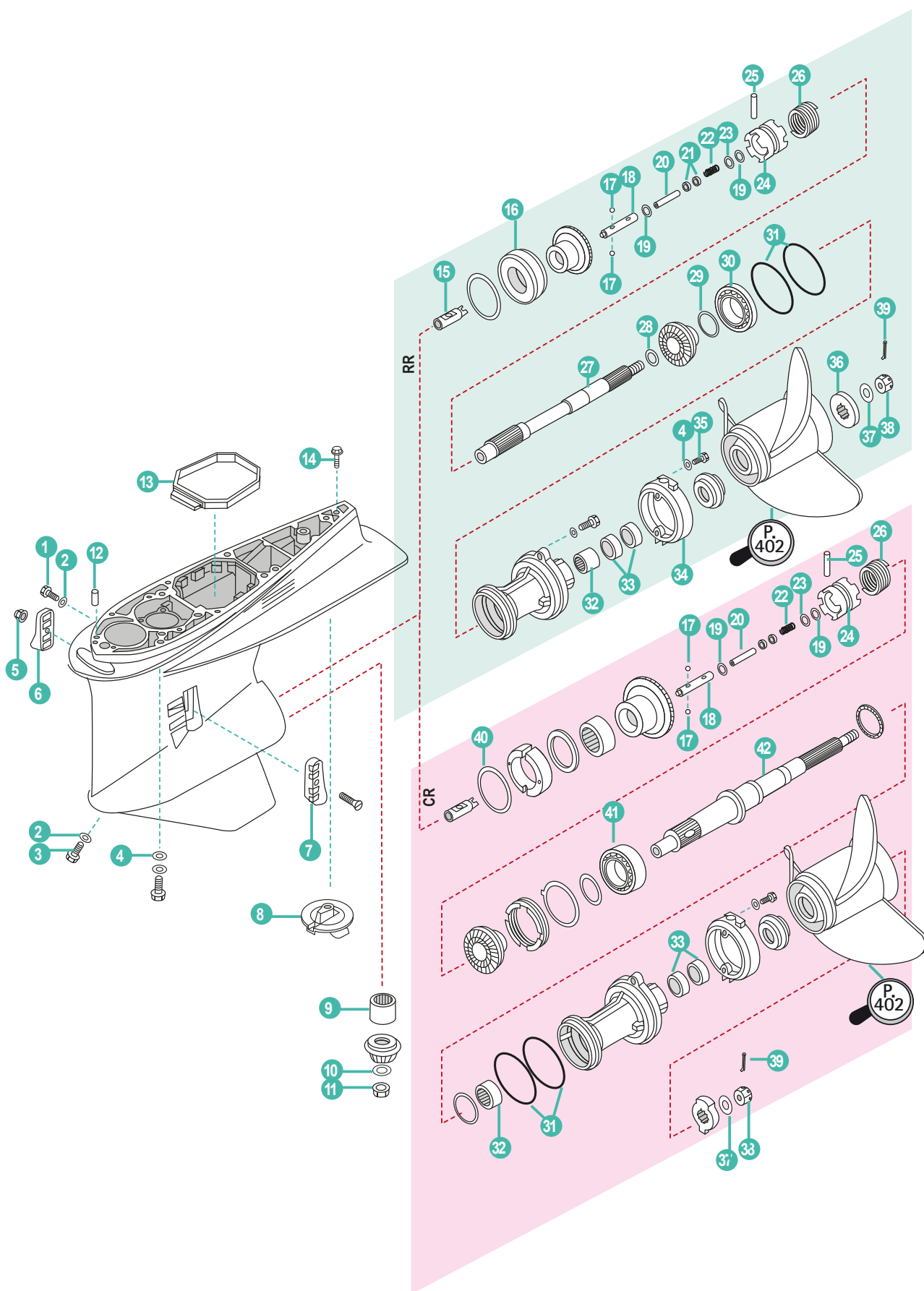

| | REF | OEM | | | | |
|----|----------------------|-----------------|----------------------------|--------------------------|------------------------------|-------------------------------|
| | REC421-B25F | 69J-45300-22-8D | CONJUNTO INFERIOR RR (X) | COMPLETE GEARCASE V6 (X) | PIEDE COMPLETO V6 (X) | EMBASE COMPLETE (X) |
| 1 | REC90340-08002 | 90304-08002 | TORNILLO DRENAJE | BOLT, DISCHARGING OIL | VITE DRENAGGIO | BOUCHON DE VIDANGE |
| 2 | REC90430-08020 | 90430-08020 | JUNTA | GASKET | GUARNIZIONE | JOINT |
| 3 | REC688-45341-00 | 688-45341-10 | TORNILLO DRENAJE | BOLT, DISCHARGING OIL | VITE DRENAGGIO | BOUCHON DE VIDANGE |
| 4 | PAGB/T97.1-8 | 92995-10600 | ARANDELA | WASHER | RONDELLA | RONDELLE |
| 5 | PAGB/T6182-M5 | 90185-05002 | TUERCA | LOCK NUT | DADO | ÉCROU |
| 6 | REC61A-45215-10 | 61A-45215-11 | REJILLA TOMA AGUA ESTIBOR | WATER SCREEN STARBOARD | GRIGLIA PRESA ACQUA TRIBORDO | GRILLE D'ENTREE D'EAU TRIBORD |
| 7 | REC61A-45214-10 | 61A-45214-11 | REJILLA TOMA AGUA BABOR | WATER SCREEN PORT | GRIGLIA PRESA ACQUA BABORDO | GRILLE D'ENTREE D'EAU BABORD |
| 8 | CM61A-45371-00A | 61A-45371-00 | ÁNODO | ANODE | ANODO | ANODE |
| 9 | REC93311-83280 | 93311-83280 | COJINETE | BEARING | CUSCINETTO | ROULEMENT |
| 10 | REC90201-16M00 | 90201-16M00 | ARANDELA | WASHER | RONDELLA | RONDELLE |
| 11 | REC90170-16M19 | 90170-16M19 | TUERCA | LOCK NUT | DADO | ÉCROU |
| 12 | REC93608-12M05 | 93608-12M05 | PASADOR | PIN | SPINOTTO | PIN |
| 13 | REC69J-45375-00 | 69J-45375-00 | GOMA ESCAPE COLA | EXHAUST DAMPER | GOMMA SCARICO | JOINT D'ÉCHAPPEMENT |
| 14 | PAT85-00000012 | 90105-10M00 | TORNILLO | SCREW | VITE | VIS |
| 15 | REC61A-45641-02 | 61A-45641-02 | CAMBIO | SHIFTER | CAMBIO | SHIFTER |
| 16 | REC93332-000W1 | 93332-000W1 | COJINETE | BEARING | CUSCINETTO | ROULEMENT |
| 17 | REC93501-04011 | 93501-04011 | ESFERA | BALL | SFERA | BILLE |
| 18 | REC61A-45634-01 | 61A-45634-01 | PASADOR DESPLAZABLE | SLIDE SHIFT | SPINOTTO SCORREVOLE | PIN REGLABLE |
| 19 | REC90183-02M03 | 90183-02M03 | TUERCA DE RESORTE | SPRING NUT | DADO MOLLA | RONDELLE FREIN |
| 20 | REC6H1-45668-00 | 6H1-45668-00 | EJE | FREE SHAFT | ASSE | ARBRE |
| 21 | REC61A-45635-00 | 61A-45635-00 | ÉMBOLO DE CAMBIO | SHIFT PLUNGER | GOMMINI | SHIFT |
| 22 | REC90501-10M77 | 90501-10M77 | RESORTE DE COMPRESIÓN | SPRING | MOLLA | RESSORT |
| 23 | REC90201-02M00 | 90201-02M00 | ARANDELA PLANA | WASHER | RONDELLA | RONDELLE |
| 24 | REC69J-45631-00 | 69J-45631-00 | EMBRAGUE DE GARRA | CLUTH | SELETTORE | CRABOT |
| 25 | REC61A-45632-00 | 61A-45632-00 | PASADOR | PIN | SPINOTTO | LEVIER |
| 26 | REC61A-45633-00 | 61A-45633-00 | ANILLO DEL PASADOR | ANNULAR SPRING, CLUTCH | ANELLO | RESSORT |
| 27 | REC69J-45611-00 | 69J-45611-00 | EJE | SHAFT | ASSE | ARBRE D'HELICE |
| 28 | REC90201-31M00 | 90201-31M00 | ARANDELA PLANA | WASHER | RONDELLA | RONDELLE |
| 29 | REC61A-45577-00/60-0 | 61A-45577-00 | KIT GRUESOS (0.10-0.50 mm) | KIT SHIM (0.10-0.50 mm) | KIT SPESSORE (0.10-0.50 mm) | KIT CALES (0.10 - 0.50 mm) |
| 30 | REC93306-210U0 | 93306-210U0 | COJINETE | BEARING | CUSCINETTO | ROULEMENT |
| 31 | REC93211-04384 | 93211-04384 | TÓRICA | O-RING | O-RING | JOINT TORIQUE |
| 32 | REC93315-43061 | 93315-43061 | COJINETE | BEARING | CUSCINETTO | ROULEMENT |
| 33 | REC93101-30M17 | 93101-30M17 | RETÉN DE ACEITE | OIL SEAL | PARAOLIO | ROULEMENT |
| 34 | REC69J-45361-00-8D | 69J-45361-00-8D | FUNDA INFERIOR | CAO LOWER CASING | COVER INFERIORE | COUVERCLE INFERIEUR |
| 35 | PAF4-04000001 | 97095-08020 | PERNO | STUD | BULLONE | BOULON |
| 36 | REC688-45997-00 | 688-45997-01 | ESPACIADOR AP | DISTANCE WASHER | DISTANZIALE | BRIDE |
| 37 | REC92990-18200 | 92990-18200 | ARANDELA PLANA | WASHER | RONDELLA | RONDELLE |
| 38 | REC90171-18M04 | 90171-18M04 | TUERCA | LOCK NUT | DADO | ÉCROU |
| 39 | REC91490-40030 | 91490-40030 | PASADOR | PIN | SPINOTTO | CLAVETTE |

| | | | CONTRA ROTACIÓN | COUNTER ROTATION | CONTRO ROTANTE | CONTRE ROTATION |
|----|----------------------|--------------|----------------------------|-------------------------|-----------------------------|----------------------------|
| 40 | REC61A-45567-00/60-0 | 61A-45567-00 | KIT GRUESOS (0.10-0.50 mm) | KIT SHIM (0.10-0.50 mm) | KIT SPESSORE (0.10-0.50 mm) | KIT CALES (0.10 - 0.50 mm) |
| 41 | REC93332-00048 | 93332-00048 | COJINETE | BEARING | CUSCINETTO | ROULEMENT |
| 42 | REC69K-45611-00 | 69K-45611-00 | EJE | SHAFT | ASSE | ARBRE D'HELICE |

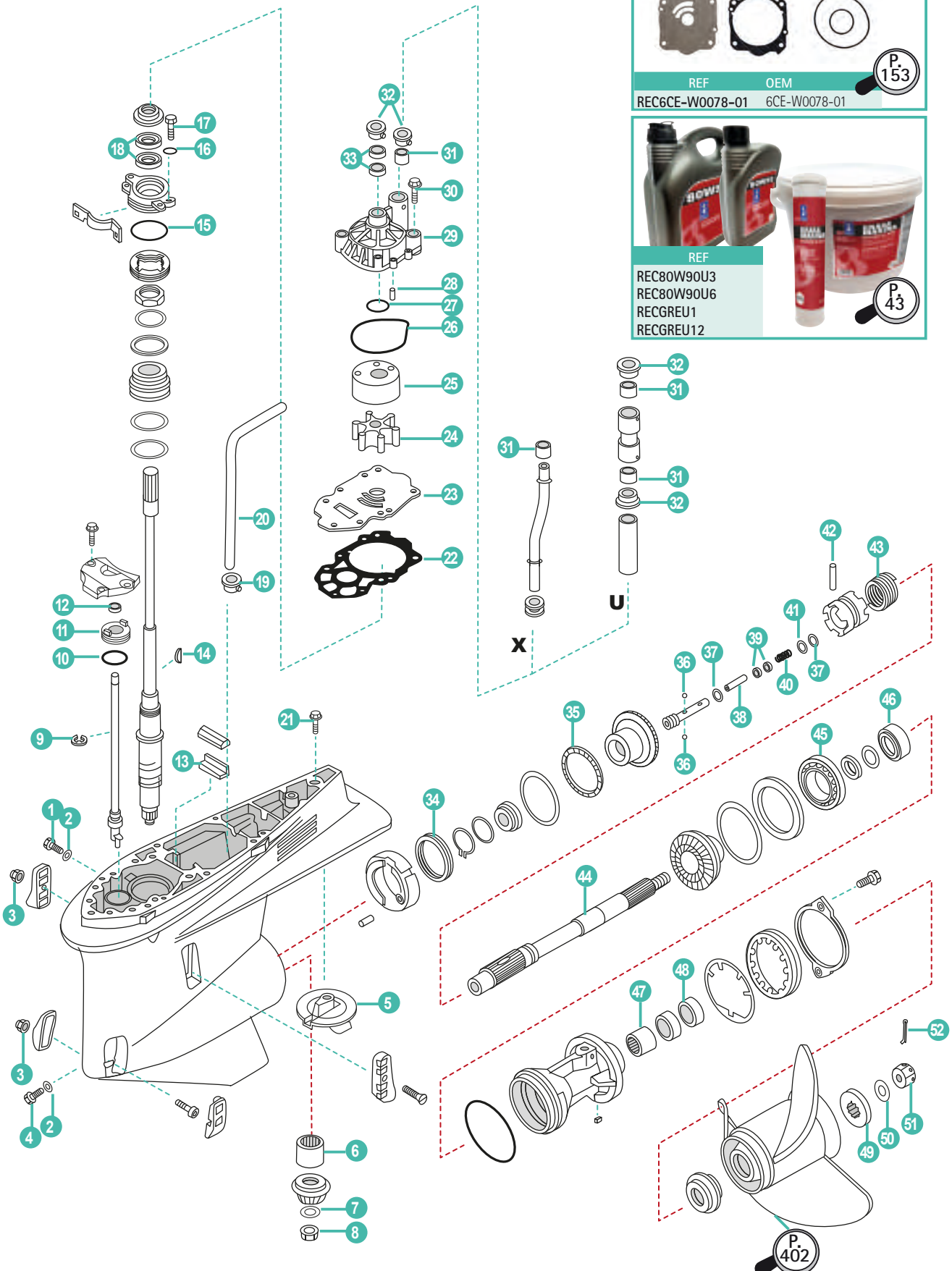

| REF | OEM |
|-----------------|--------------|
| REC6CE-W0078-01 | 6CE-W0078-01 |

P. 153

| REF |
|------------|
| REC80W90U3 |
| REC80W90U6 |
| RECGREU1 |
| RECGREU12 |

P. 43

| | REF | OEM | | | | |
|----|-------------------|--------------|--------------------------------|-------------------------|------------------------|------------------------|
| 1 | REC90340-08002 | 90304-08002 | TORNILLO DRENAJE | BOLT, DISCHARGING OIL | VITE DRENAGGIO | BOUCHON DE VIDANGE |
| 2 | REC90430-08020 | 90430-08020 | JUNTA | GASKET | GUARNIZIONE | JOINT |
| 3 | PAGB/T6182-M5 | 90185-05002 | TUERCA | LOCK NUT | DADO | ÉCROU |
| 4 | REC688-45341-00 | 688-45341-10 | TORNILLO DRENAJE | BOLT, DISCHARGING OIL | VITE DRENAGGIO | BOUCHON DE VIDANGE |
| 5 | CM61A-45371-00A | 61A-45371-00 | ÁNODO | ANODE | ANODO | ANODE |
| 6 | REC93311-83280 | 93311-83280 | COJINETE | BEARING | CUSCINETTO | ROULEMENT |
| 7 | REC90201-16M00 | 90201-16M00 | ARANDELA | WASHER | RONDELLA | RONDELLE |
| 8 | REC90170-16M19 | 90170-16M19 | TUERCA | LOCK NUT | DADO | ÉCROU |
| 9 | REC99001-08600-00 | 99001-08600 | ARANDELA | WASHER | RONDELLA | RONDELLE |
| 10 | PAJASOF404-19-033 | 93210-33M49 | TÓRICA | O-RING | O-RING | JOINT TORIQUE |
| 11 | REC65N-45321-00 | 65N-45321-00 | TAPA SELECTOR | PLATE | COPERCHIO SELETTORE | COUVERCLE DU SELECTEUR |
| 12 | REC93106-09014 | 93106-09014 | RETÉN DE ACEITE | OIL SEAL | PARAOLIO | JOINT SPI |
| 13 | REC663-45376-00 | 663-45376-00 | GUÍA DE SELLO DE GOMA | GUIDE RUB. SEAL | GUIDA PARAOLIO | GUIDE |
| 14 | REC90280-04002 | 90280-04002 | CUÑA | KEY WOODRUFF | CHIAVETTA | CLAVETTE |
| 15 | REC93210-65752-00 | 93210-64488 | TÓRICA | O-RING | O-RING | JOINT TORIQUE |
| 16 | PAGB/T97.1-8 | 92995-08600 | ARANDELA | WASHER | RONDELLA | RONDELLE |
| 17 | PAF4-04000001 | 97095-08020 | PERNO | STUD | BULOONE | BOULON |
| 18 | REC93101-28M16 | 93101-28M16 | RETÉN DE ACEITE | OIL SEAL | PARAOLIO | JOINT SPI |
| 19 | REC6D0-44367-00 | 6D0-44367-00 | GOMA DEL SELLO DE AGUA | DAMPER, WATER SEAL | GOMMA TUBO ACQUA | MANCHON TUBE D'EAU |
| 20 | REC6D0-44362-01 | 6D0-44362-01 | TUBO DE AGUA | WATER TUBE | TUBO ACQUA | DURITE D'EAU |
| 21 | PAT85-00000012 | 90105-10M00 | TORNILLO | BOLT | VITE | VIS |
| 22 | REC6CE-44315-00 | 6CE-44315-00 | JUNTA | GASKET | GUARNIZIONE | JOINT |
| 23 | REC6CE-44323-01 | 6CE-44323-01 | TAPA BOMBA | OUTER PLATE, CARTRIDGE | COPERCHIO POMPA ACQUA | PLAQUE DE POMPE À EAU |
| 24 | REC6CE-44352-00 | 6CE-44352-01 | TURBINA | IMPELLER | GIRANTE | TURBINE |
| 25 | REC6AW-44322-00 | 6AW-44322-00 | TAPA, BOMBA AGUA | COVER, INNER WATER PUMP | COPERCHIO, POMPE ACQUA | INSERT DE POMPE À EAU |
| 26 | REC93210-94003 | 93210-94003 | TÓRICA | O-RING | O-RING | JOINT TORIQUE |
| 27 | REC93210-37160 | 93210-37160 | TÓRICA | O-RING | O-RING | JOINT TORIQUE |
| 28 | REC93606-12019 | 93606-12019 | PASADOR | PIN | SPINOTTO | PIN |
| 29 | REC6CE-44311-01 | 6CE-44311-01 | CUERPO BOMBA AGUA | HOUSING, WATER PUMP | CORPO POMPA | CORPS DE POMPE À EAU |
| 30 | REC90119-08M14 | 90119-08M14 | TORNILLO CON ARANDELA | SCREW WITH WASHER | VITE CON RONDELLA | VIS AVEC RONDELLE |
| 31 | REC6AW-44365-00 | 6AW-44365-00 | GOMA DEL SELLO DE AGUA | DAMPER, WATER SEAL | ANELLO TUBO ACQUA | RETENUE TUBE D'EAU |
| 32 | REC6AW-44312-00 | 6AW-44312-00 | CUBIERTA CAJA DE BOMBA DE AGUA | WATER PUMP COVER | COPERCHIO POMPA ACQUA | BAGUE DE POMPE À EAU |
| 33 | REC93104-22M07 | 93104-22M07 | RETÉN DE ACEITE | OIL SEAL | PARAOLIO | ROULEMENT |
| 34 | REC93311-85894 | 93311-85894 | COJINETE | BEARING | CUSCINETTO | ROULEMENT |
| 35 | REC93340-67011 | 93340-67011 | COJINETE | BEARING | CUSCINETTO | ROULEMENT |
| 36 | REC93501-04011 | 93501-04011 | ESFERA | BALLE | SFERA | BILLE |
| 37 | REC90183-02M03 | 90183-02M03 | TUERCA DE RESORTE | SPRING NUT | DADO MOLLA | RONDELLE FREIN |
| 38 | REC6H1-45668-00 | 6H1-45668-00 | EJE | SHAFT | ASSE | ARBRE |
| 39 | REC61A-45635-00 | 61A-45635-00 | ÉMBOLO DE CAMBIO | SHIFT PLUNGER | GUARNIZIONE | SHIFT |
| 40 | REC90501-10M77 | 90501-10M77 | RESORTE DE COMPRESIÓN | SPRING | MOLLA | RESSORT |
| 41 | REC90201-02M00 | 90201-02M00 | ARANDELA PLANA | WASHER | RONDELLA | RONDELLE |
| 42 | REC90250-08M07 | 90250-08M07 | PASADOR | PIN | SPINOTTO | PIN |
| 43 | REC6E5-45633-01 | 6E5-45633-01 | ANILLO DEL PASADOR | ANULAR SPRING, CLUTCH | ANELLO | RESSORT |
| 44 | REC6CB-45611-00 | 6CB-45611-00 | EJE | SHAFT | ASSE | ARBRE D'HELICE |
| 45 | REC93306-209U0 | 93306-209U0 | COJINETE | BEARING | CUSCINETTO | ROULEMENT |
| 46 | REC93332-000A5 | 93332-000A5 | COJINETE | BEARING | CUSCINETTO | ROULEMENT |
| 47 | REC93315-43061 | 93315-43061 | COJINETE | BEARING | CUSCINETTO | ROULEMENT |
| 48 | REC93101-30002 | 93101-30002 | RETÉN DE ACEITE | OIL SEAL | PARAOLIO | JOINT SPI |
| 49 | REC688-45997-00 | 688-45997-01 | ESPACIADOR | SPACER | SPESSORE | ENTRETOISE |
| 50 | REC92990-18200 | 92990-18200 | ARANDELA PLANA | WASHER | RONDELLA | RONDELLE |
| 51 | REC90171-18M04 | 90171-18M04 | TUERCA | LOCK NUT | DADO | ÉCROU |
| 52 | REC91490-40030 | 91490-40030 | PASADOR | PIN | SPINOTTO | CLAVETTE |

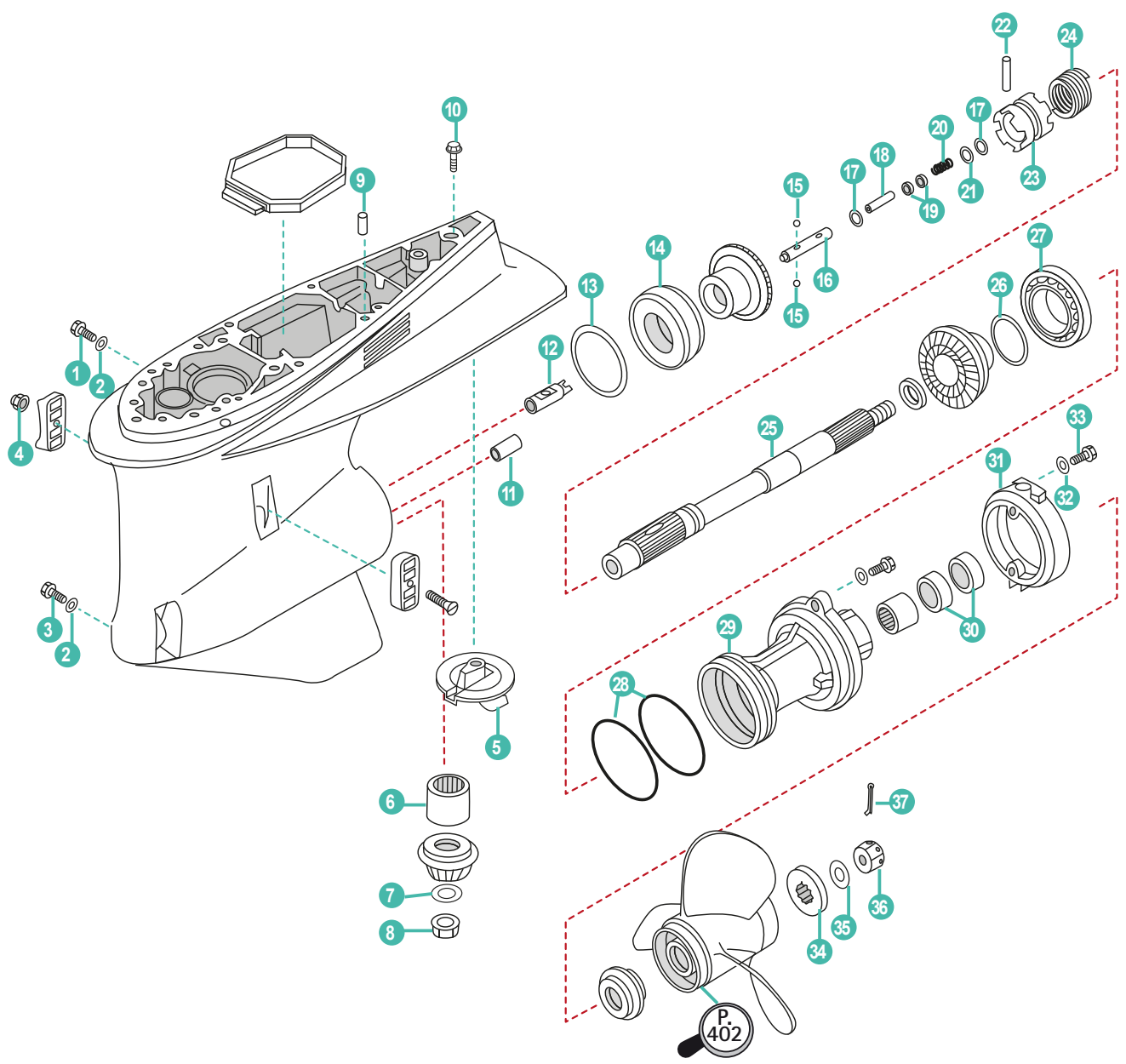

| REF | OEM |
|-----------------|---------------|
| REC6P2-W0078-00 | 61P2-W0078-00 |

P. 153

| REF |
|------------|
| REC80W90U3 |
| REC80W90U6 |
| RECGREU1 |
| RECGREU12 |

P. 43

| | REF | OEM | | | | |
|----|----------------------|-----------------|----------------------------|-------------------------|-----------------------------|----------------------------|
| 1 | REC90340-08002 | 90304-08002 | TORNILLO DRENAJE | BOLT, DISCHARGING OIL | VITE DRENAGGIO | VIS DE VIDANGE |
| 2 | REC90430-08020 | 90430-08020 | JUNTA | GASKET | GUARNIZIONE | JOINT |
| 3 | REC688-45341-00 | 688-45341-10 | TORNILLO DRENAJE | BOLT, DISCHARGING OIL | VITE DRENAGGIO | VIS DE VIDANGE |
| 4 | PAGB/T6182-M5 | 90185-05002 | TUERCA | LOCK NUT | DADO | ÉCROU |
| 5 | CM61A-45371-00A | 61A-45371-00 | ÁNODO | ANODE | ANODO | ANODE |
| 6 | REC93311-83280 | 93311-83280 | COJINETE | BEARING | CUSCINETTO | PALIER |
| 7 | REC90201-16M00 | 90201-16M00 | ARANDELA | WASHER | RONDELLA | RONDELLE |
| 8 | REC90170-16M19 | 90170-16M19 | TUERCA | LOCK NUT | DADO | ÉCROU |
| 9 | REC93608-12M05 | 93608-12M05 | PASADOR | PIN | SPINOTTO | LEVIER |
| 10 | PAT85-00000012 | 90105-10M00 | TORNILLO | SCREW | VITE | VIS |
| 11 | REC99590-10114 | 99590-10114 | PASADOR | PIN | SPINOTTO | LEVIER |
| 12 | REC61A-45641-02 | 61A-45641-02 | CAMBIO | SHIFTER | CAMBIO | SHIFTER |
| 13 | REC61A-45567-00/60-0 | 61A-45567-00 | KIT GRUESOS (0.10-0.50 mm) | KIT SHIM (0.10-0.50 mm) | KIT SPESSORE (0.10-0.50 mm) | KIT CALES (0.10 - 0.50 mm) |
| 14 | REC93332-000W1 | 93332-000W1 | COJINETE | BEARING | CUSCINETTO | ROULEMENT |
| 15 | REC93501-04011 | 93501-04011 | ESFERA | BALL | SFERA | BILLE |
| 16 | REC61A-45634-01 | 61A-45634-01 | DESLIZADOR CAMBIO | SHIFT SLIDE | SPINOTTO SCORREVOLE | SHIFT |
| 17 | REC90183-02M03 | 90183-02M03 | TUERCA DE RESORTE | SPRING NUT | DADO MOLLA | RONDELLE FREIN |
| 18 | REC6H1-45668-00 | 6H1-45668-00 | EJE | SHAFT | ASSE | ARBRE |
| 19 | REC61A-45635-00 | 61A-45635-00 | DESLIZADOR CAMBIO | SHIFT SLIDE | SPINOTTO | SHIFT |
| 20 | REC90501-10M77 | 90501-10M77 | RESORTE DE COMPRESIÓN | SPRING | MOLLA | RESSORT |
| 21 | REC90201-02M00 | 90201-02M00 | ARANDELA PLANA | WASHER | RONDELLA | RONDELLE |
| 22 | REC61A-45632-00 | 61A-45632-00 | PASADOR | PIN | SPINOTTO | PIN |
| 23 | REC69J-45631-00 | 69J-45631-00 | EMBRAGUE DE GARRA | CLUTH | SELETTORE | CRABOT |
| 24 | REC61A-45633-00 | 61A-45633-00 | ANILLO DEL PASADOR | ANNULAR SPRING, CLUTCH | ANELLO | RESSORT |
| 25 | REC69J-45611-00 | 69J-45611-00 | EJE | SHAFT | ASSE | ARBRE |
| | REC69K-45611-00 | 69K-45611-00 | EJE CONTRARROTACIÓN | CR SHAFT | ASSE CR | ARBRE D'HELICE CR |
| 26 | REC61A-45577-00/60-0 | 61A-45577-00 | KIT GRUESOS (0.10-0.50 mm) | KIT SHIM (0.10-0.50 mm) | KIT SPESSORE (0.10-0.50 mm) | KIT CALES (0.10 -0.50 mm) |
| 27 | REC93306-210U0 | 93306-210U0 | COJINETE | BEARING | CUSCINETTO | ROULEMENT |
| 28 | REC93211-04384 | 93211-04384 | TÓRICA | O-RING | O-RING | JOINT TORIQUE |
| 29 | REC6D0-45332-00-CA | 6D0-45332-00-CA | DIÁBOLO | GEAR HOUSING | DIABOLO | DIABOLO |
| 30 | REC93101-30002 | 93101-300002 | RETÉN DE ACEITE | OIL SEAL | PARAOLIO | JOINT SPI |
| 31 | REC6D0-45361-00-8D | 6D0-45361-00-8D | FUNDA INFERIOR | CAO LOWER CASING | COVER INFERIORE | COUVERCLE INFERIEUR |
| 32 | PAF4-04000001 | 97095-08020 | PERNO | BOLT | BULONE | BOULON |
| 33 | PAGB/T97.1-8 | 92995-08600 | ARANDELA | WASHER | RONDELLA | RONDELLE |
| 34 | REC688-45997-00 | 688-45997-01 | ESPACIADOR | SPACER | SPESSORE | CALES |
| 35 | REC92990-18200 | 92990-18200 | ARANDELA PLANA | WASHER | RONDELLA | RONDELLE |
| 36 | REC90171-18M04 | 90171-18M04 | TUERCA | LOCK NUT | DADO | ÉCROU |
| 37 | REC91490-40030 | 91490-40030 | PASADOR | PIN | SPINOTTO | CLAVETTE |

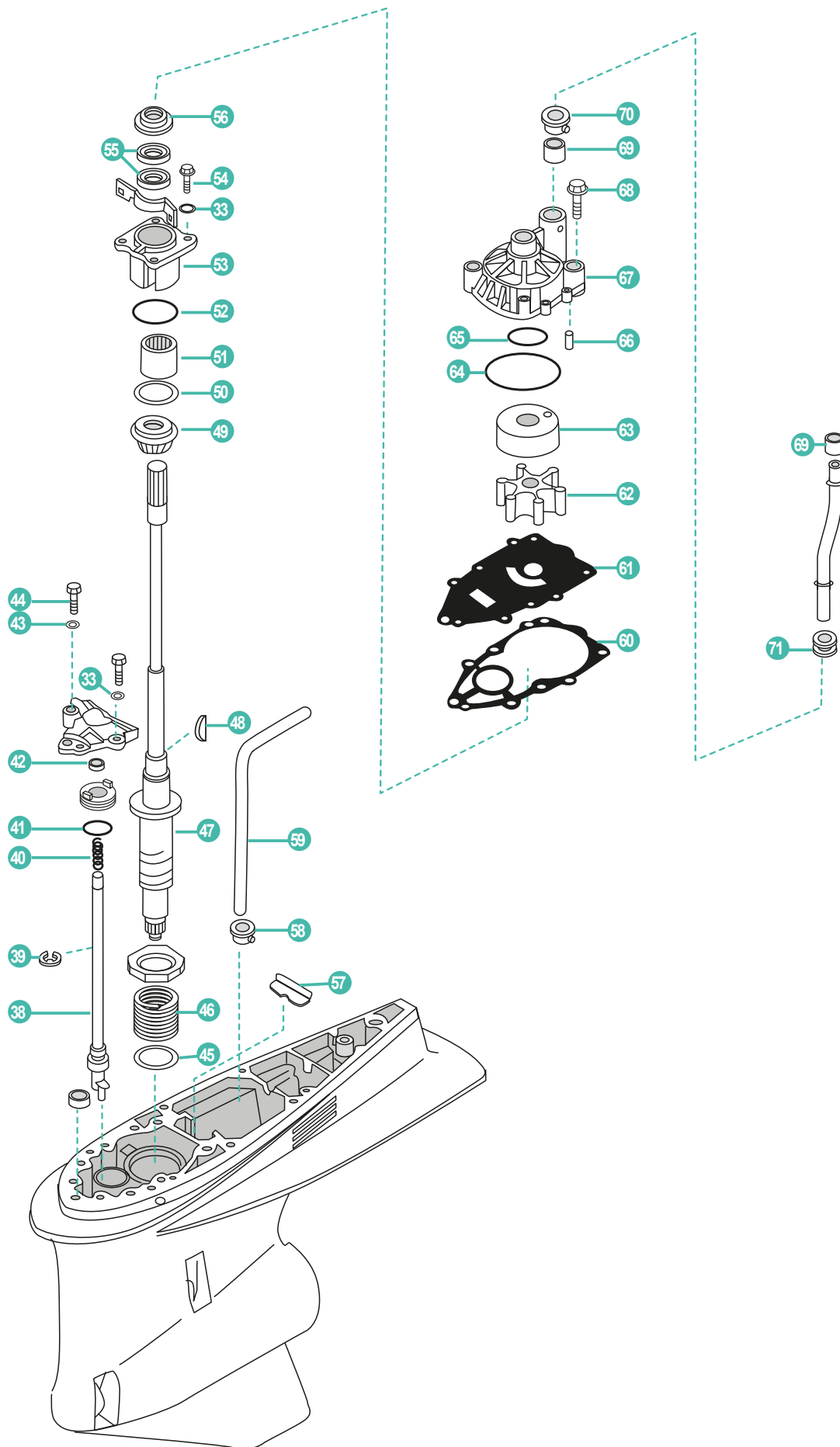

| | REF | OEM | | | | |
|----|----------------------|------------------------------------|--------------------------------------|---------------------------------------|----------------------------------|------------------------------------|
| 38 | REC6P2-44150-00 | 6P2-44150-00 | VARILLA SELECTOR | SHIFT CAM ASSY | ASTA SELETTORE | TIGE DE SELECTEUR |
| 39 | REC99001-08600-00 | 99001-08600 | CLIP | CLIP | RONDELLA | CLIP |
| 40 | REC90501-11M10-00 | 90501-11M10 | RESORTE DE COMPRESIÓN | SPRING | MOLLA | RESSORT |
| 41 | PAJASOF404-19-033 | 93210-33M49 | TÓRICA | O-RING | O-RING | JOINT TORIQUE |
| 42 | REC93106-09014 | 93106-09014 | RETÉN DE ACEITE | OIL SEAL | PARAOLIO | ROULEMENT |
| 43 | PAGB/T97.1-6 | 92995-06600 | ARANDELA | WASHER | RONDELLA | RONDELLE |
| 44 | PAGB/T5783-M6X16 | 97095-06016 | PERNO | BOLT | BULLONE | BOULON |
| 45 | REC90201-42014 | 90201-42014 | ARANDELA PLANA | WASHER | RONDELLA | RONDELLE |
| 46 | REC90501-450A2 | 90501-450A2 | RESORTE | SPRING | MOLLA | RESSORT |
| 47 | REC6P2-45501-11 | 6P2-45501-10 | EJE TRANSMISION U (30.3") | DRIVE SHSFT U (30.3") | ASSE TRASMISSIONE U (30.3") | ARBRE DE TRANSMISSION U (30.3") |
| | REC6P2-45501-01 | 6P2-45501-00 | EJE TRANSMISION X (25.3") | DRIVE SHSFT X (25.3") | ASSE TRASMISSIONE X (25.3") | ARBRE DE TRANSMISSION X (25.3") |
| 48 | REC90280-04M05 | 90280-04M05 | CUÑA | KEY WOODRUFF | CHIAVETTA | CLAVETTE |
| 49 | REC93341-93020 | 93341-930U9 | COJINETE | BEARING | CUSCINETTO | ROULEMENT |
| 50 | REC61A-45587-00/60-0 | 61A-45587-00 | KIT GRUESOS (0.10-0.50 mm) | KIT SHIM (0.10-0.50 mm) | KIT SPESSORE (0.10-0.50 mm) | KIT CALES (0.10 - 0.50 mm) |
| 51 | REC93317-330U2 | 93317-330U2 | COJINETE | BEARING | CUSCINETTO | ROULEMENT |
| 52 | REC93210-54534 | 93210-54534 | TÓRICA | O-RING | O-RING | JOINT TORIQUE |
| 53 | REC6P2-45331-00-9S | 6P2-45331-00-9S | CAJA DE COJINETE | HOUSING, BEARING | SCATOLA CUSCINETTO | PALIER DE ROULEMENT |
| 54 | PAGB/T5783-M8X25 | 97095-08025 | PERNO | BOLT | BULLONE | BOULON |
| 55 | REC93101-28M16 | 93101-28M16 | RETÉN DE ACEITE | OIL SEAL | PARAOLIO | JOINT SPI |
| 56 | REC6E5-45344-00 | 6E5-45344-00 | TAPA RETEN | RETAINER | COPERCHIO PARAOLIO | RETENUE |
| 57 | REC61A-45376-00-94 | 61A-45376-00 | GUÍA SELLO DE GOMA | GUIDE | GUIDA | GUIDE |
| 58 | REC6D0-44367-00 | 6D0-44367-00 | GOMA TUBO AGUA | DAMPER, WATER SEAL | GOMMA TUBO ACQUA | MANCHON TUBE D'EAU |
| 59 | REC6D0-44362-01 | 6D0-44362-01 | TUBO DE AGUA | WATER TUBE | TUBO ACQUA | TUBE D'EAU |
| 60 | REC60X-44315-A0 | 60X-44315-A0 | JUNTA | GASKET | GUARNIZIONE | JOINT |
| 61 | REC6P2-44323-00 | 6P2-44323-00 | PLACA EXTERIOR DEL CARTÚCHO | OUTER PLATE | PLACCA ESTERNA | PLAQUE DE POMPE À EAU |
| 62 | REC6E5-44352-01 | 6E5-44352-01 | TURBINA | IMPELLER | GIRANTE | TURBINE |
| 63 | REC61A-44322-02 | 61A-44322-02 | TAPA, BOMBA AGUA | COVER, INNER WATER PUMP | COPERCHIO, POMPE ACQUA | INSERT DE POMPE À EAU |
| 64 | REC93210-86M38 | 93210-86M38 | TÓRICA | O-RING | O-RING | JOINT TORIQUE |
| 65 | REC93210-37160 | 93210-37160 | TÓRICA | O-RING | O-RING | JOINT TORIQUE |
| 66 | REC93606-12019 | 93606-12019 | PASADOR | PIN | SPINOTTO | PIN |
| 67 | REC61A-44311-00 | 61A-44311-01 | CUERPO BOMBA AGUA | HOUSING, WATER PUMP | CORPO POMPA | CORPS DE POMPE À EAU |
| 68 | REC90119-08M14 | 90119-08M14 | TORNILLO CON ARANDELA | SCREW WITH WASHER | VITE CON RONDELLA | VIS AVEC RONDELLE |
| 69 | REC6E5-44365-00 | 6E5-44365-00 | GOMA DEL SELLO DE AGUA | DAMPER, WATER SEAL | ANELLO TUBO ACQUA | RETENUE TUBE D'EAU |
| 70 | REC6E5-44312-00 | 6E5-44312-00 | CUBIERTA CAJA DE BOMBA DE AGUA | WATER PUMP COVER | COPERCHIO POMPA ACQUA | GUIDE DE POMPE À EAU |
| 71 | REC6E5-44366-00 | 6E5-44366-00 | GOMA DEL SELLO DE AGUA | DAMPER, WATER SEAL | ANELLO TUBO ACQUA | RETENUE TUBE D'EAU |
| | REC422-B25F | 6P2-45300-20-8D 6P2-45300-21-8D | CONJUNTO INFERIOR | COMPLETE GEARCASE | PIEDE COMPLETO | EMBASE COMPLETE |
| | REC429-B25F | 6P3-45300-40-8D 6P3-45300-41-8D | CONJUNTO INFERIOR CONTRA ROTACIÓN | COMPLETE GEARCASE COUNTER ROTATION | PIEDE COMPLETO CONTRO ROTANTE | EMBASE COMPLETE CONTRE ROTATION |

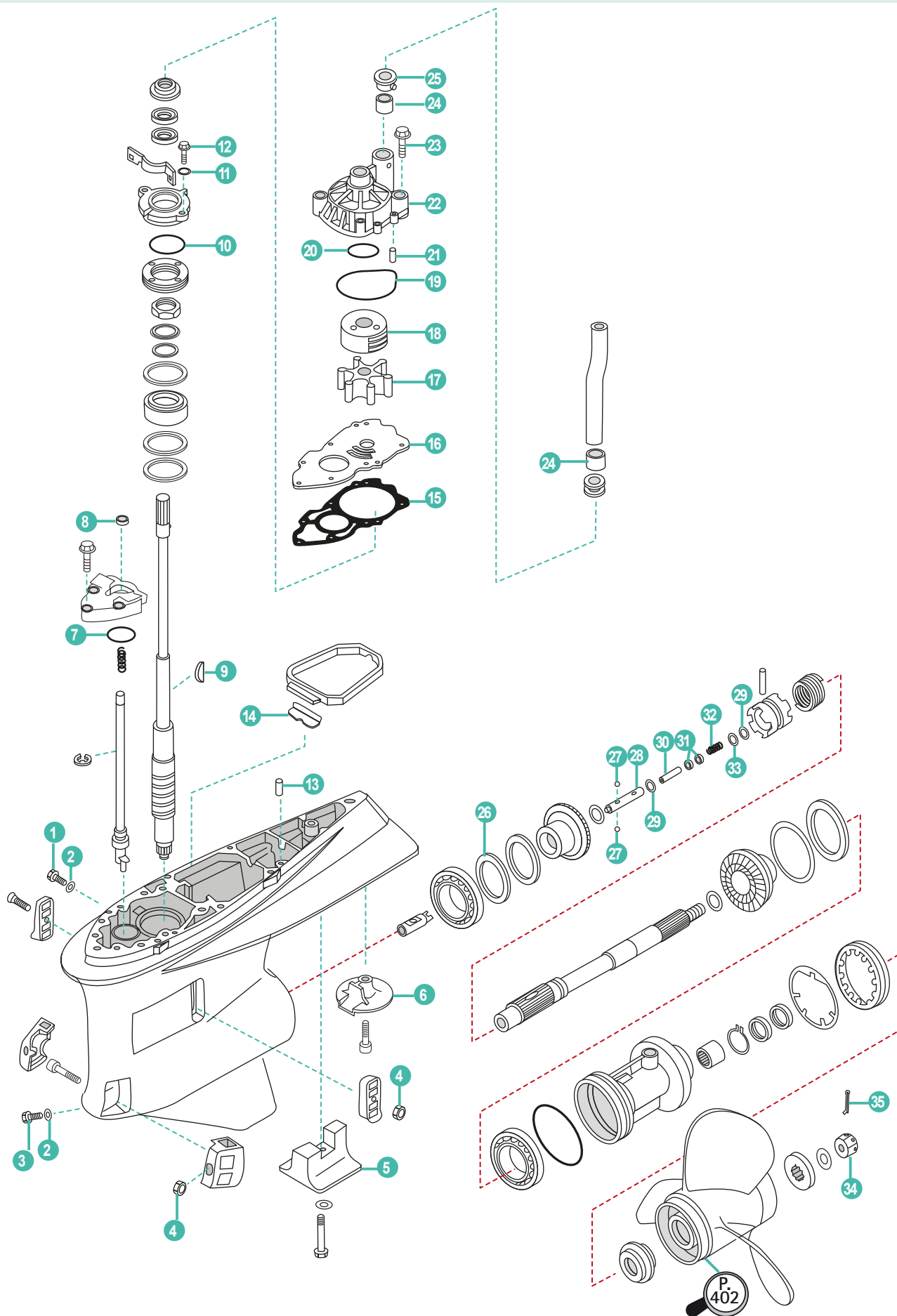

| | REF | OEM | | | | |
|----|--------------------|-----------------|--------------------------------|-------------------------|-------------------------|-----------------------|
| 1 | REC90340-08002 | 90304-08002 | TORNILLO DRENAJE | BOLT, DISCHARGING OIL | VITE DRENAGGIO | BOUCHON DE VIDANGE |
| 2 | REC90430-08020 | 90430-08020 | JUNTA | GASKET | GUARNIZIONE | JOINT |
| 3 | REC688-45341-00 | 688-45341-10 | TORNILLO DRENAJE | BOLT, DISCHARGING OIL | VITE DRENAGGIO | BOUCHON DE VIDANGE |
| 4 | PAGB/T6182-M5 | 90185-05002 | TUERCA | LOCK NUT | DADO | ÉCROU |
| 5 | CM6AW-45373-00A | 6AW-45373-00 | ÁNODO | ANODE | ANODO | ANODE |
| 6 | CM6AW-45619-00A | 6AW-45619-00 | ÁNODO | ANODE | ANODO | ANODE |
| 7 | REC93210-48214 | 93210-48214 | TÓRICA | O-RING | O-RING | JOINT TORIQUE |
| 8 | REC93101-12M70 | 93101-12M70 | RETÉN DE ACEITE | OIL SEAL | PARAOILIO | JOINT SPI |
| 9 | REC6AW-44336-00 | 6AW-44336-00 | CUÑA | KEY WOODRUFF | CHIAVETTA | CLAVETTE |
| 10 | REC93210-69MG6 | 93210-69MG6 | TÓRICA | O-RING | O-RING | JOINT TORIQUE |
| 11 | PAGB/T97.1-8 | 92995-08600 | ARANDELA | WASHER | RONDELLA | RONDELLE |
| 12 | PAF4-04000001 | 97095-08020 | PERNO | BOLT | BULLONE | BOULON |
| 13 | REC93608-12M05 | 93608-12M05 | PASADOR | PIN | SPINOTTO | PIN |
| 14 | REC61A-45376-00-94 | 61A-45376-00-94 | GUÍA DE SELLO DE GOMA | GUIDE | GUIDE | GUIDE |
| 15 | REC6AW-44315-00 | 6AW-44315-00 | JUNTA | GASKET | GUARNIZIONE | JOINT |
| 16 | REC6AW-44323-00 | 6AW-44323-00 | TAPA BOMBA | OUTER PLATE, CARTRIDGE | COPERCHIO POMPA D'ACQUA | PLAQUE DE POMPE À EAU |
| 17 | REC6AW-44352-00 | 6AW-44352-00 | TURBINA | IMPELLER | GIRANTE | TURBINE |
| 18 | REC6AW-44322-00 | 6AW-44322-00 | TAPA, BOMBA AGUA | COVER, INNER WATER PUMP | COPERCHIO, POMPE D'EAU | INSERT DE POMPE À EAU |
| 19 | REC93210-94003 | 93210-94003 | TÓRICA | O-RING | O-RING | JOINT TORIQUE |
| 20 | REC93210-37160 | 93210-37160 | TÓRICA | O-RING | O-RING | JOINT TORIQUE |
| 21 | REC93606-12019 | 93606-12019 | PASADOR | PIN | SPINOTTO | PIN |
| 22 | REC6AW-44311-01 | 6AW-44311-00 | CUERPO BOMBA AGUA | HOUSING, WATER PUMP | CORPO POMPA | CORPS DE POMPE À EAU |
| 23 | REC90119-08M14 | 90119-08M14 | TORNILLO CON ARANDELA | SCREW WITH WASHER | VITE CON RONDELLA | VIS AVEC RONDELLE |
| 24 | REC6AW-44365-00 | 6AW-44365-00 | GOMA DEL SELLO DE AGUA | DAMPER, WATER SEAL | ANELLO TUBO ACQUA | RETENUE TUBE D'EAU |
| 25 | REC6AW-44312-00 | 6AW-44312-00 | CUBIERTA CAJA DE BOMBA DE AGUA | WATER PUMP COVER | COPERCHIO POMPA ACQUA | BAGUE DE POMPE À EAU |
| 26 | REC93340-67011 | 93340-67011 | COJINETE | BEARING | CUSCINETTO | ROULEMENT |
| 27 | REC93501-04011 | 93501-04011 | ESFERA | BALL | SFERA | BILLE |
| 28 | REC61A-45634-01 | 61A-45634-01 | DESGLIZADOR DE CAMBIO | SHIFT SLIDE | SCORREVOLE DEL CAMBIO | SHIFT |
| 29 | REC90183-02M03 | 90183-02M03 | TUERCA DE RESORTE | SPRING NUT | DADO MOLLA | RONDELLE FREIN |
| 30 | REC6H1-45668-00 | 6H1-45668-00 | EJE | SHAFT | ASSE | ARBRE |
| 31 | REC61A-45635-00 | 61A-45635-00 | ÉMBOLO DE CAMBIO | SHIFT PLUNGER | GOMMINO | SHIFT |
| 32 | REC90501-10M77 | 90501-10M77 | RESORTE DE COMPRESIÓN | SPRING | MOLLA | RESSORT |
| 33 | REC90201-02M00 | 90201-02M00 | ARANDELA PLANA | WASHER | RONDELLA | RONDELLE |
| 34 | REC90171-18M04 | 90171-18M04 | TUERCA | LOCK NUT | DADO | ÉCROU |
| 35 | REC91490-40030 | 91490-40030 | PASADOR | PIN | SPINOTTO | CLAVETTE |

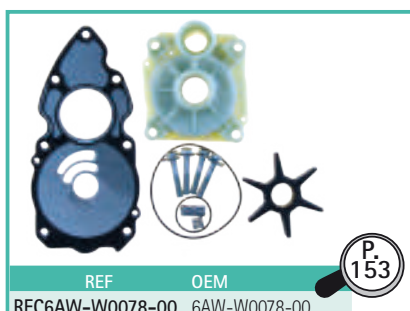

DESPIECE COLAS
2 TIEMPOS

GEAR CASE PARTS
2 STROKES

PARTI PIEDI
2 TEMPI

PIECES D'EMBASES
DE 2 TEMPS

2T 2HP • 2B • 2MSH • 2CMH
STROKES

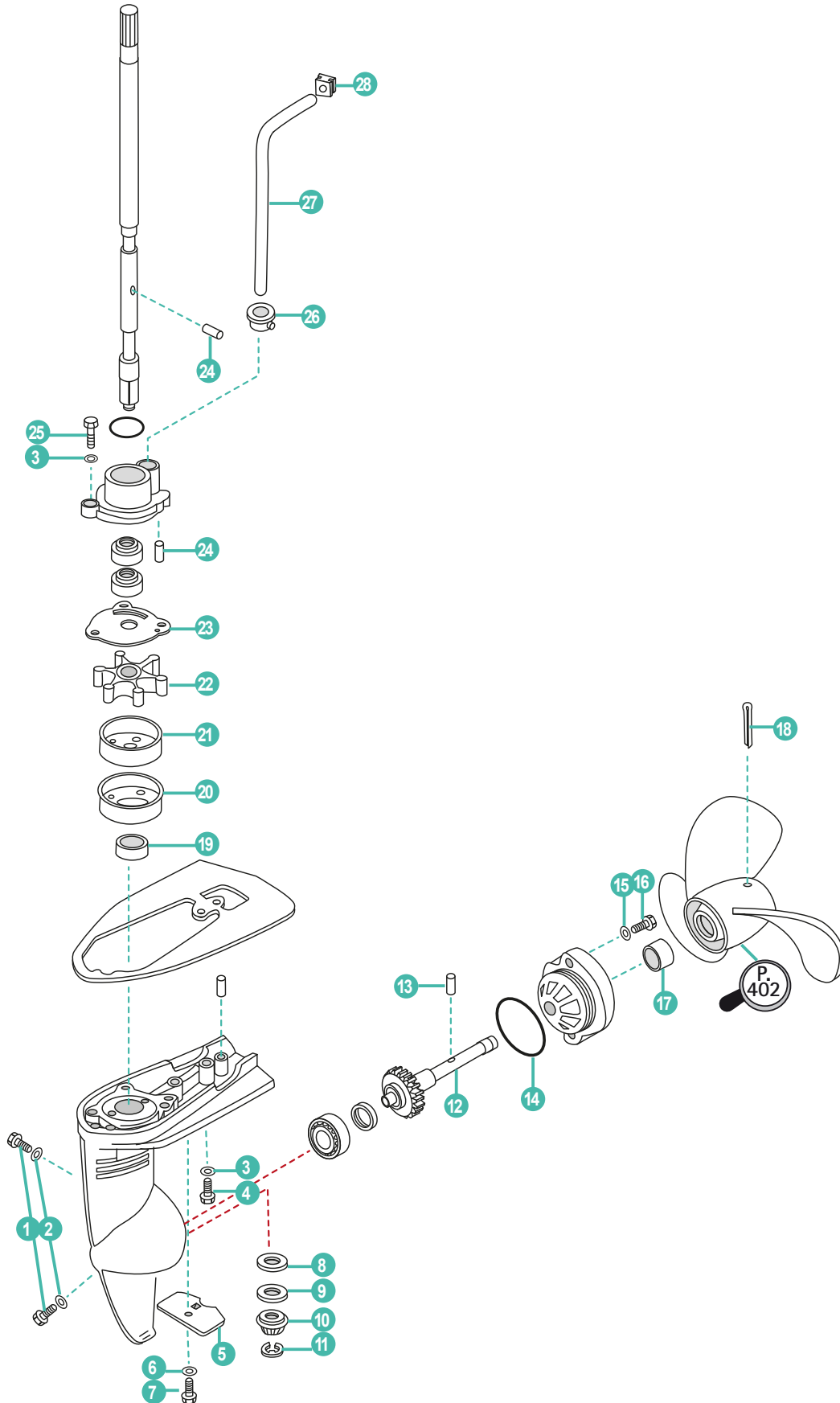

| | REF | OEM | | | | |
|----|------------------|-----------------|-----------------------|-----------------------|---------------------|-----------------------|
| 1 | REC90340-08002 | 90340-08M04 | TORNILLO DRENAJE | BOLT, DISCHARGING OIL | VITE DRENAGGIO | BOUCHON DE VIDANGE |
| 2 | REC90430-08020 | 90430-08020 | JUNTA | GASKET | GUARNIZIONE | JOINT |
| 3 | PAGB/T97.1-8 | 92995-08600 | ARANDELA | WASHER | RONDELLA | RONDELLE |
| 4 | PAGB/T5783-M6X30 | 97095-06030 | TORNILLO | BOLT | VITE | VIS |
| 5 | CM6L5-45251-02 | 6L5-45251-02 | ÁNODO ZINC | ANODE | ANODO ZINCO | ANODE |
| 6 | PAGB/T861.1-87 | 92990-06300 | ARANDELA | WASHER | RONDELLA | RONDELLE |
| 7 | PAGB/T5783-M6X35 | 95895-06012 | TORNILLO | BOLT, FLANGE | VITE | VIS |
| 8 | PAF2.6-03000017 | 646-45534-00-03 | GRUESO | SHIM | SPESSORE | CALE |
| 9 | PAF4-03000006 | 90201-11M49 | ARANDELA | WASHER | RONDELLA | RONDELLE |
| 10 | REC646-45551-00 | 646-45551-00 | PIÑÓN ATAQUE | INITIATIVE GEAR | MARCIA INIZIATIVA | PIGNON D'ATTAQUE |
| 11 | PAGB/T896-86 | 93430-06005 | CLIP | CIRCLIP | CLIP | CLIP |
| 12 | REC646-45560-00 | 646-45560-00 | ENGRANAJE CON EJE | GEAR WITH SHAFT | IGRANAGGIO CON ASSE | PIGNON |
| 13 | REC90250-03M10 | 90250-03M10 | PASADOR SEGURIDAD | PIN | SPINOTTO | LEVIER |
| 14 | REC93210-42101 | 93210-42101 | ARO TÓRICA | O-RING | O-RING | JOINT TORIQUE |
| 15 | PAGB/T97.1-6 | 92990-06600 | ARANDELA | WASHER | RONDELLA | RONDELLE |
| 16 | PAGB/T5783-M6X16 | 97090-06014 | TORNILLO | BOLT | VITE | VIS |
| 17 | REC93103-10052 | 93103-10052 | RETÉN | OIL SEAL | PARAOLIO | JOINT SPI |
| 18 | REC91490-30040 | 91490-30040 | PASADOR ALETAS | PIN | SPINOTTO | PIN |
| 19 | REC93103-11051 | 93103-11051 | RETÉN | OIL SEAL | PARAOLIO | JOINT D'HUILE |
| 20 | REC6A1-44325-00 | 6A1-44325-00P | CUERPO INF. BOMBA | PROTECTOR | CORPO INF. POMPA | BASE DE POMPE À EAU |
| 21 | REC646-44322-00 | 646-44322-00 | CASQUILLO INOX. BOMBA | INSERT | GHIERA INOX. POMPA | INSERT DE POMPE À EAU |
| 22 | REC646-44352-01 | 646-44352-01 | TURBINA | IMPELLER | GIRANTE | TURBINE |
| 23 | REC646-44322-00 | 646-44323-00 | PLATO BOMBA AGUA | OUTER PLATE | PIASTRA POMPA ACQUA | PLAQUE DE POMPE À EAU |
| 24 | PAF2.6-03000013 | 93604-09068 | PIN | PIN | SPINOTTO | PIN |
| 25 | PAGB/T5783-M5X16 | 97095-05016 | TORNILLO | BOLT | VITE | VIS |
| 26 | REC646-44366-01 | 646-44366-01 | RETÉN TUBO AGUA | SEAL WATER PIPE | ANELLO TUBO ACQUA | RETENUE TUBE D'EAU |
| 27 | REC6A1-44361-00 | 6A1-44361-00 | TUBO AGUA | TUBE, WATER | TUBO ACQUA | TUBE D'EAU |
| 28 | REC646-44365-00 | 646-44365-00 | RETÉN TUBO DE AGUA | I-SHAPED RUBBER BAND | ANELLO TUBO ACQUA | RETENUE TUBE D'EAU |



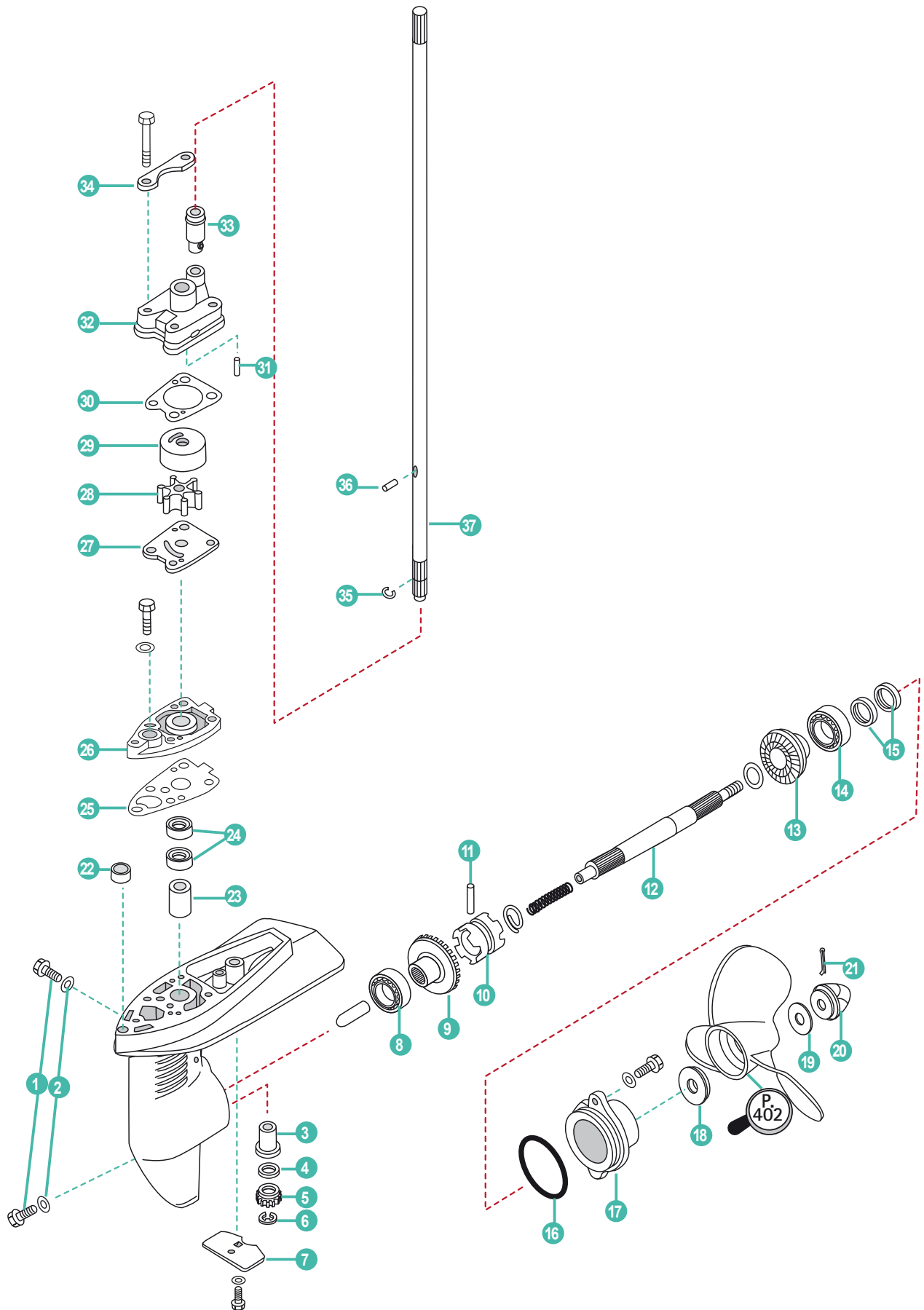

| | REF | OEM | | | | |
|----|------------------|-----------------|------------------------------|-------------------------|---------------------------------|-----------------------------------|
| 1 | REC90340-08002 | 90340-08002 | TAPÓN ACEITE | PLUG, OIL | TAPPO OLIO | BOUCHON REMPLISSAGE D'HUILE |
| 2 | REC90430-08020 | 90430-08020 | JUNTA | GASKET | GUARNIZIONE | JOINT |
| 3 | REC6E0-45317-00 | 6E0-45317-09 | CASQUILLO EJE | BUSHING | CAPPUCCIO ASSE | BAGUE D'ARBRE |
| 4 | PAF4-03000006 | 90204-11M49 | ARANDELA | WASHER | RONDELLA | RONDELLE |
| 5 | REC6E0-45551-00 | 6E0-45551-00 | PIÑÓN ATAQUE | INITIATIVE GEAR | MARCIA INIZIATIVA | PIGNON D'ATTAQUE |
| 6 | PAGB/T896-86 | 99001-06600 | CIRCLIP | CIRCLIP | CIRCLIP | CIRCLIP |
| 7 | CM6L5-45251-02 | 6L5-45251-03 | ÁNODO | ZINC ANODE | ANODO ZINCO | ANODE |
| 8 | PAGB/T276-6004C2 | 93306-004U0 | RODAMIENTO | BEARING | CUSCINETTO | ROULEMENT |
| 9 | REC6E0-45560-00 | 6E0-45560-00 | PIÑÓN MARCHA AVANTE | POSITIVE GEAR ASSY | PIGNONE MARCIA AVANTI | PIGNON DE MARCHÉ AVANT |
| 10 | REC6E0-45631-00 | 6E0-45631-00 | DESPLAZABLE | CLUTCH, DOG | SCORREVOLE | CRABOT |
| 11 | REC90250-05046 | 90250-05046 | PASADOR | PIN STRAIGHT | SPINOTTO | PIN |
| 12 | REC6E0-45611-01 | 6E0-45611-01 | EJE HÉLICE | SHAFT, PROPELLER | ASSE ELICA | ARBRE D'HELICE |
| 13 | REC6E0-45570-00 | 6E0-45570-00 | PIÑÓN MARCHA ATRÁS | REVERSE GEAR | PIGNONE MARCIA INDIETRO | PIGNON MARCHÉ ARRIÈRE |
| 14 | PAGB/T276-6004C2 | 93306-004U0 | RODAMIENTO | BEARING | CUSCINETTO | ROULEMENT |
| 15 | REC93101-13M12 | 93101-13M12 | RETÉN | OIL SEAL | PARAOLIO | JOINT SPI |
| 16 | REC93210-48214 | 93210-48214 | ARO TÓRICO | O-RING | O-RING | JOINT TORIQUE |
| 17 | PAF4-03050001 | 6E0-45361-01-4D | TAPA CÁRTER | COVER, LOWER CASING | COPERCHIO CARTER | COUVERCLE INFERIEUR EMBASE |
| 18 | PAF4-03000025 | 6L5-45987-01 | ESPACIADOR | SPACER | DISTANZIALE | ENTRETOISE |
| 19 | PAF4-03000026 | 90201-08M54 | ARANDELA INOX. | WASHER, STAINLESS STEEL | RONDELLA INOX. | RONDELLE INOX |
| 20 | REC647-45616-02 | 6L5-45616-02 | TUERCA | NUT, PROPELLER | DADO | ÉCROU |
| 21 | PAGB/T91-1.6X12 | 91490-25030 | PASADOR ALETAS | PIN, COTTER | SPINOTTO | PIN |
| 22 | PAF4-00000001 | 90387-06M14 | COLLAR | COLLAR | COLLARE | GUIDE CREUX |
| 23 | REC6E0-45316-00 | 6E0-45316-09 | CASQUILLO EJE | BUSHING | GHIERA ASSE | BAGUE BRONZE |
| 24 | REC93101-10M14 | 93101-10M14 | RETÉN | OIL SEAL | PARAOLIO | JOINT SPI |
| 25 | PAF4-03000011 | 6E0-45315-A0 | JUNTA | PACKING | GUARNIZIONE | JOINT |
| 26 | PAF4-03000012 | 6E0-45321-01-5B | BASE BOMBA DE AGUA | BASE, WATER PUMP | BASE POMPA ACQUA | BASE DE POMPE À EAU |
| 27 | PAF4-03000015 | 6E0-44323-00 | PLACA | OUTER PLATE | PIASTRA | PLAQUE |
| 28 | REC6E0-44352-00 | 6E0-44352-00 | IMPULSOR | IMPELLER | GIRANTE | TURBINE |
| 29 | REC6E0-44322-02 | 6E0-44322-02 | CASQUILLO INOX | CARTRIDGE INSERT | CAPPUCCIO | INSERT DE POMPE À EAU |
| 30 | PAF4-03000018 | 6E0-44315-A0 | JUNTA BOMBA | GASKET | GUARNIZIONE POMPA | JOINT DE POMPE |
| 31 | PAF4-03000013 | 93604-18080 | PIN | PIN, DOWEL | SPINOTTO | PIN |
| 32 | PAF4-03000019 | 6E0-44311-00 | CUERPO BOMBA | HOUSING, WATER PUMP | CORPO POMPA | CORPS DE POMPE À EAU |
| 33 | PAF4-03000021 | 6E0-44366-00 | RETÉN GOMA, BOMBA DE AGUA | RUBBER TUBE, WATER PUMP | TENUTA IN GOMMA, POMPA ACQUA | MANCHON CAOUTCHOUC DE POMPE À EAU |
| 34 | PAF4-03000020 | 6E0-44328-00 | PLACA FIJACIÓN BOMBA DE AGUA | PLATE, WATER PUMP FIXED | PLACCA DI FISSAGGIO POMPA ACQUA | PLAQUE FIXATION DE POMPE À EAU |
| 35 | PAF4-03000005 | 90467-08M01 | CLIP | CLIP | CLIP | CLIP |
| 36 | PAF4-03000016 | 93604-09066 | PIN | PIN, DOWEL | SPINOTTO | PIN |
| 37 | REC6E0-45511-01 | 6E0-45511-01 | EJE VERTICAL S | SHAFT, DRIVE S | ASSE VERTICALE S | ARBRE VERTICAL S |
| | REC6E0-45511-11 | 6E0-45511-11 | EJE VERTICAL L | SHAFT, DRIVE L | ASSE VERTICALE L | ARBRE VERTICAL L |



2T 6HP/C/MSH/CMH/CWH/MBK'07/D/DMH/DWH
STROKES 8HP/C/MSH/MH/CMH/CWH

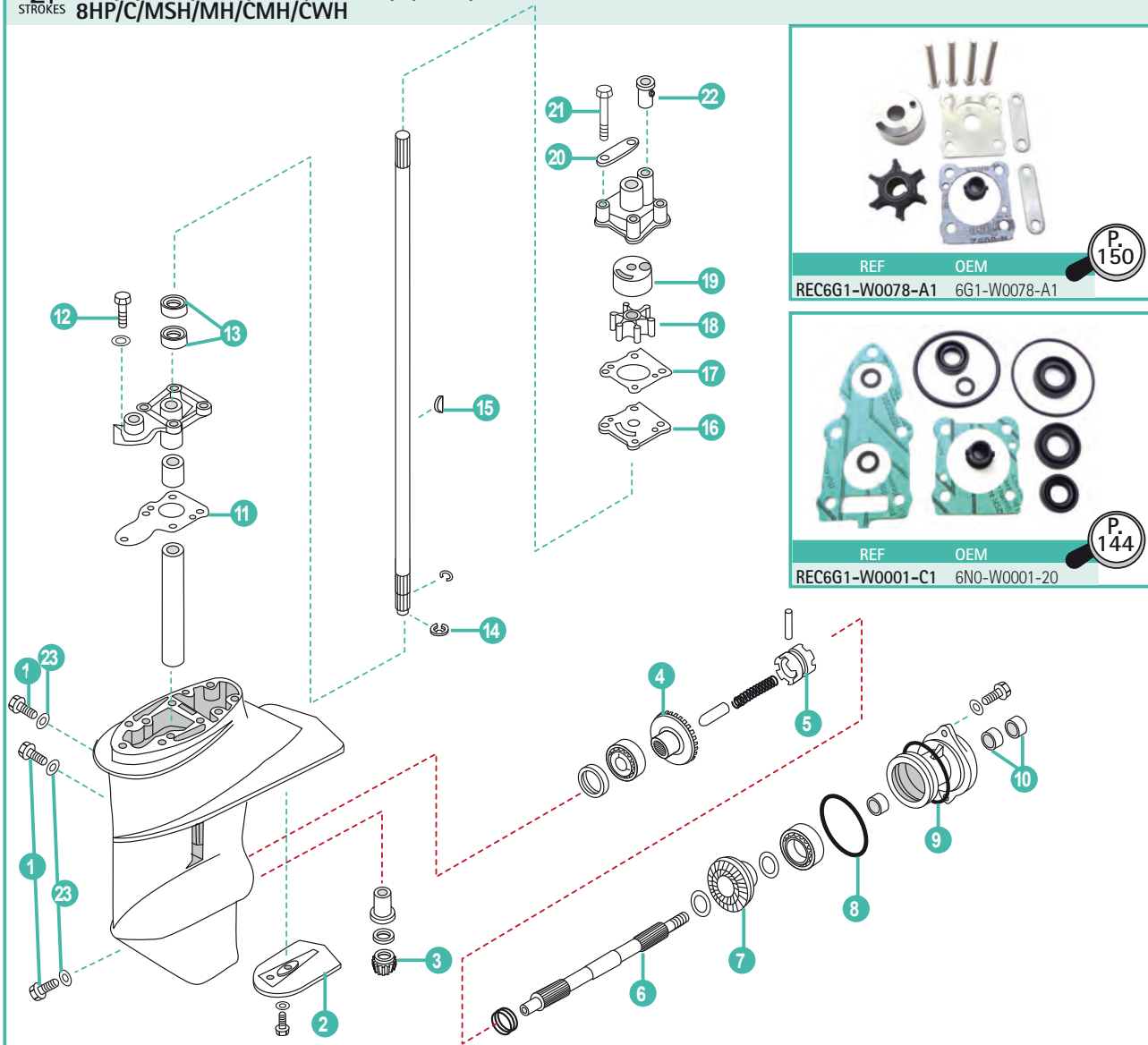

| | REF | OEM | | | | |
|----|------------------|--------------|------------------------------|-------------------------|---------------------------------|--------------------------------|
| 1 | REC90340-08002 | 6E0-45316-09 | TAPÓN | PLUG | TAPPO | BOUCHON REMPLISSAGE D'HUILE |
| 2 | TEN01118 | 6N0-G5251-00 | ÁNODO | ANODE | ANODO | ANODE |
| 3 | REC6N0-G5551-00 | 6N0-G5551-00 | PIÑÓN ATAQUE | INITIATIVE GEAR | MARCIA INIZIATIVA | PIGNON D'ATTAQUE |
| 4 | REC6N0-G5560-00 | 6N0-G5560-00 | PIÑÓN MARCHA AVANTE | POSITIVE GEAR ASSY | PIGNONE MARCIA AVANTI | PIGNON DE MARCHÉ AVANT |
| 5 | REC6G1-45631-00 | 6G1-45631-00 | EMBRAGUE DE GARRA | CLUTCH, DOG | SELETTORE | CRABOT |
| 6 | REC6G1-45611-01 | 6G1-45611-01 | EJE HÉLICE | SHAFT, PROPELLER | ASSE ELICA | ARBRE D'HELICE |
| 7 | REC6N0-G5571-00 | 6N0-G5571-00 | PIÑÓN MARCHA ATRÁS | REVERSE GEAR | PIGNONE MARCIA INDIETRO | PIGNON MARCHÉ ARRIÈRE |
| 8 | REC93210-49046 | 93210-49046 | ARO TÓRICO | O-RING | O-RING | JOINT TORIQUE |
| 9 | REC93210-53M08 | 93210-53M08 | ARO TÓRICO | O-RING | O-RING | JOINT TORIQUE |
| 10 | REC93101-15074 | 93101-15074 | RETÉN | OIL SEAL | PARAOLIO | JOINT SPI |
| 11 | REC6G1-45315-A0 | 6G1-45315-A0 | JUNTA | PACKING, LOWER CASING | GUARNIZIONE | JOINT |
| 12 | PAGB/T5783-M6X30 | 97095-06030 | TORNILLO | BOLT | VITE | VIS |
| 13 | REC93101-11M23 | 93101-11M23 | RETÉN | OIL SEAL | PARAOLIO | JOINT SPI |
| 14 | REC99001-06600 | 99001-06600 | CERCLIP | CIRCLIP | CIRCLIP | CIRCLIP |
| 15 | REC90280-03024 | 90280-03024 | CHAVETA | KEY | CHIAVETTA | CLAVETTE |
| 16 | REC6G1-44323-00 | 6G1-44323-00 | PLATO | OUTTER PLATE, CARTRIDGE | PIASTRA | PLAQUE DE POMPE À EAU |
| 17 | REC6G1-44315-A0 | 6G1-44315-A0 | JUNTA | GASKET, WATER PUMP | GUARNIZIONE | JOINT |
| 18 | REC6G1-44352-00 | 6G1-44352-00 | TURBINA | IMPELLER | GIRANTE | TURBINE |
| 19 | REC6G1-44322-00 | 6G1-44322-00 | CASQUILLO | INSERT, CARTRIDGE | GHIERA | INSERT DE POMPE À EAU |
| 20 | REC6G1-44328-00 | 6G1-44328-00 | PLACA FIJACIÓN BOMBA DE AGUA | PLATE, WATER PUMP FIXED | PLACCA DI FISSAGGIO POMPA ACQUA | PLAQUE FIXATION DE POMPE À EAU |
| 21 | REC97095-06045 | 97095-06045 | TORNILLO | BOLT | VITE | VIS |
| 22 | REC647-44366-00 | 647-44366-00 | CASQUILLO GOMA | DAMPER | GHIERA GOMA | BAGUE CAOUTCHOUC |
| 23 | REC90430-08020 | 90430-08020 | JUNTA | GASKET | GUARNIZIONE | JOINT |

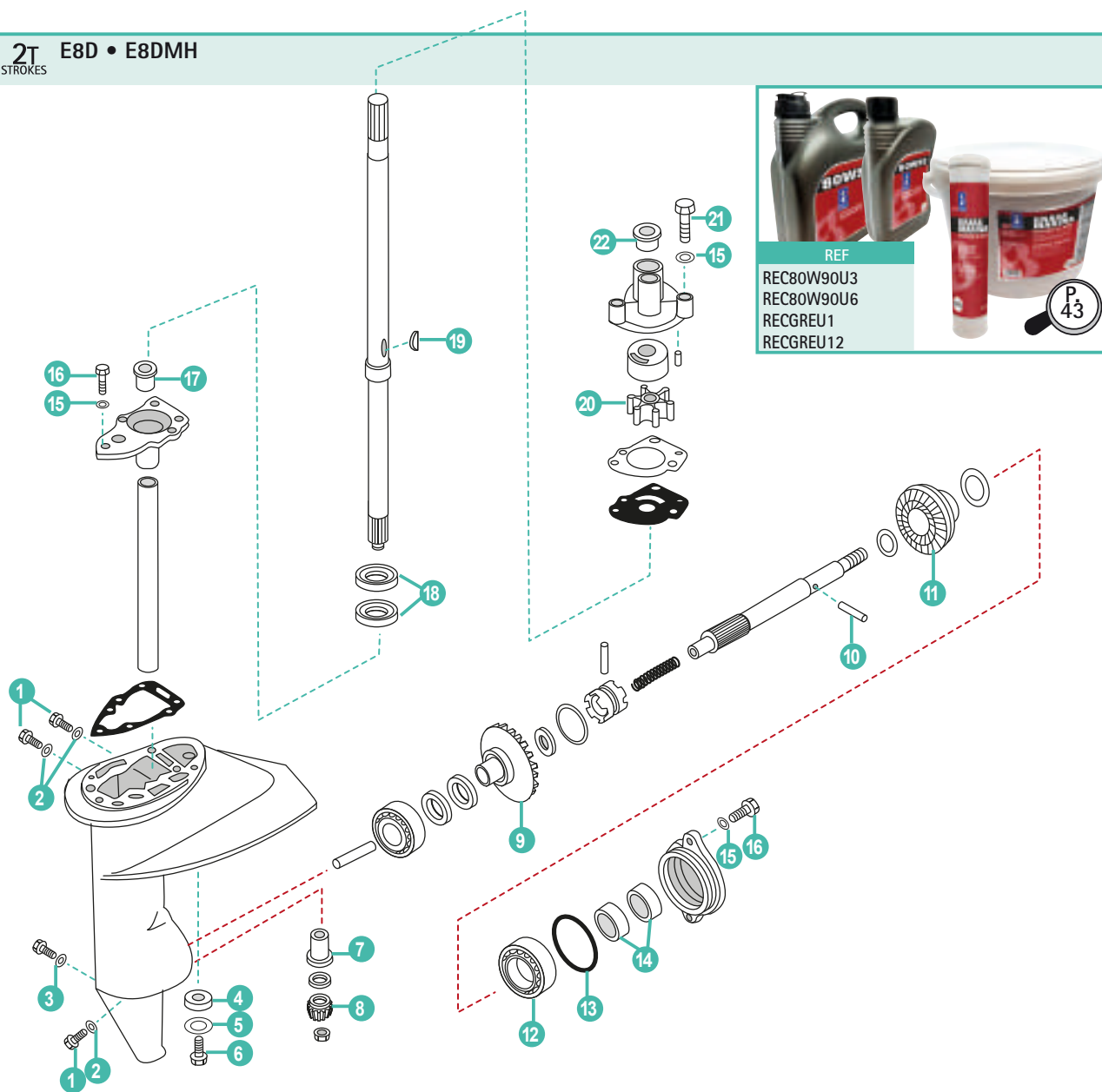

| | REF | OEM | | | | |
|----|------------------|--------------|---------------------|--------------------|-------------------------|------------------------|
| 1 | REC90340-08002 | 90340-08M04 | TORNILLO | BOLT | VITE | VIS |
| 2 | REC90430-08020 | 90430-08020 | JUNTA | GASKET | GUARNIZIONE | JOINT |
| 3 | REC90430-06M03 | 90430-06M03 | JUNTA | GASKET | GUARNIZIONE | JOINT |
| 4 | CM6E0-45251-11 | 677-45251-00 | ÁNODO | ANODE | ANODO | ANODE |
| 5 | PAGB/T861.1-87 | 92990-06300 | ARANDELA | WASHER | RONDELLA | RONDELLE |
| 6 | PAGB/T5783-M6X35 | 95895-06012 | TORNILLO | BOLT | VITE | VIS |
| 7 | REC647-45316-09 | 647-45316-09 | CASQUILLO | DAMPER | GHIERA GOMA | PIN |
| 8 | REC647-45551-00 | 647-45551-00 | PIÑÓN ATAQUE | INITIATIVE GEAR | MARCIA INIZIATIVA | PIGNON D'ATTAQUE |
| 9 | REC647-45560-00 | 647-45560-00 | PIÑÓN MARCHA AVANTE | POSITIVE GEAR ASSY | PIGNONE MARCIA AVANTI | PIGNON DE MARCHÉ AVANT |
| 10 | REC90250-05036 | 90250-05036 | PASADOR | PIN | SPINOTTO | PIN |
| 11 | REC647-45570-00 | 647-45570-01 | PIÑÓN MARCHA ATRÁS | REVERSE GEAR | PIGNONE MARCIA INDIETRO | PIGNON MARCHÉ ARRIÈRE |
| 12 | REC93306-00519 | 93306-00519 | COJINETE | BEARING | CUSCINETTO | ROULEMENT |
| 13 | REC93210-58677 | 93210-58677 | ARO | O-RING | O-RING | JOINT TORIQUE |
| 14 | REC93101-15074 | 93101-15074 | RETÉN ACEITE | OIL SEAL | PARAOLIO | JOINT SPI |
| 15 | PAGB/T97.1-6 | 92990-06600 | ARANDELA | WASHER | RONDELLA | RONDELLE |
| 16 | PAGB/T5783-M6X20 | 97095-06020 | PERNO | BOLT | VITE | VIS |
| 17 | REC647-45316-09 | 647-45316-09 | CASQUILLO | BUSH | GHIERA | BAGUE |
| 18 | REC93101-18050 | 93101-18050 | RETÉN ACEITE | OIL SEAL | PARAOLIO | JOINT SPI |
| 19 | REC90280-03024 | 90280-03024 | CHAVETA | KEY | CHIAVETTA | CLAVETTE |
| 20 | REC662-44352-01 | 662-44352-01 | IMPULSOR | IMPELLER | GIRANTE | TURBINE |
| 21 | REC97095-06040 | 97095-06040 | PERNO | BOLT | VITE | VIS |
| 22 | REC647-44366-00 | 647-44366-00 | GOMA | RUBER BAND | GOMMA | BAGUE |

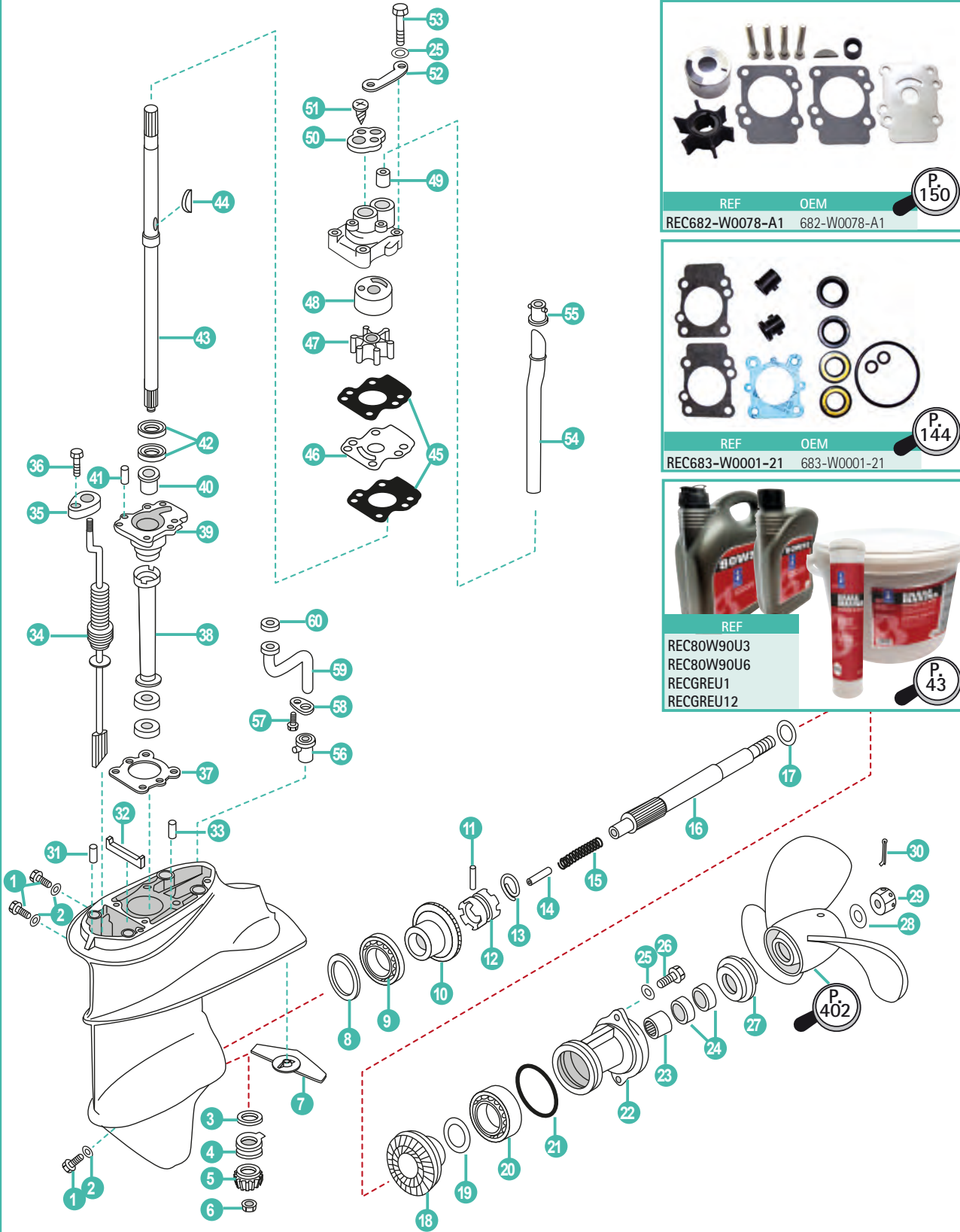

| REF | OEM |
|-----------------|--------------|
| REC682-W0078-A1 | 682-W0078-A1 |

P. 150

| REF | OEM |
|-----------------|--------------|
| REC683-W0001-21 | 683-W0001-21 |

P. 144

| REF |
|------------|
| REC80W90U3 |
| REC80W90U6 |
| RECGREU1 |
| RECGREU12 |

P. 43

| | REF | OEM | | | | |
|---|-----------------|-----------------|-----------------|----------------------|-------------------|--------------------|
| 1 | REC90340-08002 | 90340-08014 | TAPÓN | PLUG, STRAIGHT SCREW | TAPPO | BOUCHON DE VIDANGE |
| 2 | REC90430-08020 | 90430-08020 | JUNTA | GASKET | GUARNIZIONE | JOINT |
| 3 | PAF15-06000009 | 6E7-45587-01-30 | GRUESO (1.20mm) | SHIM (1.20mm) | SPESSORE (1.20mm) | CALE (1.20 mm) |
| 4 | REC93341-214U1 | 93341-214U1 | RODAMIENTO | BEARING | CUSCINETTO | ROULEMENT |
| 5 | REC6E7-45551-00 | 6E7-45551-00 | PIÑÓN ATAQUE | INITIATIVE GEAR | MARCIA INIZIATIVA | PIGNON D'ATTAQUE |
| 6 | REC90179-08M06 | 90179-08M06 | TUERCA | NUT | DADO | ÉCROU |
| 7 | TEN01116 | 6B4-45251-00 | ÁNODO | ANODE | ANODO | ANODE |

| | REF | OEM | | | | |
|----|--------------------|-----------------|------------------------|---------------------------|-------------------------|----------------------------|
| 8 | PAF15-06000010-1 | 664-45567-05 | GRUESO (0.05mm) | SHIM (0.05mm) | SPESSORE (0.05mm) | CALE (0.05 mm) |
| | PAF15-06000010-2 | 664-45567-12 | GRUESO (0.12mm) | SHIM (0.12mm) | SPESSORE (0.12mm) | CALE (0.12 mm) |
| | PAF15-06000010-5 | 664-45567-30 | GRUESO (0.30mm) | SHIM (0.30mm) | SPESSORE (0.30mm) | CALE (0.30 mm) |
| | PAF15-06000010-7 | 664-4556-50 | GRUESO (0.50mm) | SHIM (0.50mm) | SPESSORE (0.50mm) | CALE (0.50 mm) |
| 9 | REC93332-00005 | 93332-00005 | RODAMIENTO | BEARING | CUSCINETTO | ROULEMENT |
| 10 | REC6E7-45560-01 | 6E7-45560-00 | PIÑÓN MARCHA AVANTE | POSITIVE GEAR ASSY | PIGNONE MARCIA AVANTI | PIGNON DE MARCHE AVANT |
| 11 | REC90250-05010 | 90250-05010 | PASADOR | PIN, STRAIGHT | SPINOTTO | PIN |
| 12 | REC682-45631-00 | 682-45631-00 | EMBRAGUE DE GARRA | CLUTCH, DOG | SELETTORE | CRABOT |
| 13 | REC648-45633-00 | 648-45633-00 | ANILLO | RING, CROSS PIN | O-RING | JOINT TORIQUE |
| 14 | REC650-45635-00 | 650-45635-00 | PISTÓN | PLUNGER, SHIFT | PISTONE | PISTON |
| 15 | PAF15-06070002 | 90501-14M06 | MUELLE | SPRING, COMPRESSION | MOLLA | RESSORT |
| 16 | REC683-45611-00 | 683-45611-00 | EJE HÉLICE | SHAFT, PROPELLER | ASSE ELICA | ARBRE D'HELICE |
| 17 | REC90201-17682 | 90201-17682 | ARANDELA | WASHER, PLATE | RONDELLA | RONDELLE |
| 18 | REC6E7-45570-00 | 6E7-45571-00 | PIÑÓN MARCHA ATRÁS | REVERSE GEAR | PIGNONE MARCIA INDIETRO | PIGNON MARCHE ARRIÈRE |
| 19 | PAF15-06080006-1 | 626-45577-00-01 | GRUESO (0.10mm) | SHIM (0.10mm) | SPESSORE (0.10mm) | CALE (0.10 mm) |
| | PAF15-06080006-3 | 626-45577-00-03 | GRUESO (0.30mm) | SHIM (0.30mm) | SPESSORE (0.30mm) | CALE (0.30 mm) |
| | PAF15-06080006-5 | 626-45577-00-05 | GRUESO (0.50mm) | SHIM (0.50mm) | SPESSORE (0.50mm) | CALE (0.50 mm) |
| 20 | REC93306-00501 | 93306-00501 | RODAMIENTO | BEARING | CUSCINETTO | ROULEMENT |
| 21 | REC93210-57M09 | 93210-57M09 | ARO TÓRICO | O-RING | O-RING | JOINT TORIQUE |
| 22 | REC683-45361-01-4D | 683-45361-00-EJ | DIÁBOLO | CAP, LOWER CASING | COP. CASSA INGRANAGGI | DIABOLO |
| 23 | REC93315-317U2 | 93315-317U2 | RODAMIENTO | BEARING | CUSCINETTO | ROULEMENT |
| 24 | REC93101-17054 | 93101-17054 | RETÉN | OIL SEAL | PARAOLIO | JOINT SPI |
| 25 | PAGB/T97.1-16 | 92990-06600 | ARANDELA | WASHER, PLATE | RONDELLA | RONDELLE |
| 26 | PAGB/T5783-M6X20 | 97395-06020 | TORNILLO | BOLT | VITE | VIS |
| 27 | REC6E7-45987-00 | 6E7-45987-00 | ESPACIADOR | SPACER | DISTANZIALE | ENTRETOISE |
| 28 | PAGB/T96-10 | 90201-10M01 | SEPARADOR | SPACER | DISTANZIALE | CALE |
| 29 | PAF15-06000016 | 90171-10M01 | TUERCA HÉLICE | NUT, CASTLE | DADO ELICA | ÉCROU |
| 30 | PAGB/T91-2.5X20 | 91490-30020 | PASADOR ALETAS | PIN, COTTER | PIN ELICA | CLAVETTE |
| 31 | REC93606-12019 | 93606-12019 | PIN | PIN | SPINOTTO | PIN |
| 32 | REC682-45376-01 | 682-45376-01 | GUÍA RETÉN | GUIDE, SEAL DAMPER | GUIDA BOCCOLA | GUIDE |
| 33 | PAF25-04000007 | 93604-08062 | PIN | PIN, DOWEL | SPINOTTO | PIN |
| 34 | REC682-44147-00 | 682-44147-00 | TAPÓN GUÍA | BOOT, SHIFT ROD | TAPPO GUIDA | GUIDE |
| 35 | REC682-44176-00 | 682-44176-00 | SOPORTE | BRACKET | SUPPORTO | SUPPORT |
| 36 | PAGB/T845-ST4.8X9 | 97780-50510 | TORNILLO | SCREW | VITE | VIS |
| 37 | REC683-45315-A0 | 683-45315-00 | JUNTA | PACKING, LOWER CASING | GUARNIZIONE | JOINT |
| 38 | REC6E7-45536-00 | 6E7-45536-00 | CAMISA EJE | SLEEVE, DRIVE SHAFT | TUBO GUIDA | TUBE GUIDE |
| 39 | REC6E7-45331-00-CA | 6E7-45331-00-9M | CUERPO DE RODAMIENTO | HOUSING, BEARING | CUSCINETTO | LOGEMENT |
| 40 | REC626-45316-09 | 626-45316-09 | CASQUILLO | BUSHING, DRIVE SHAFT | GHIERA | BAGUE |
| 41 | REC93606-12019 | 93606-12019 | PIN | PIN, DOWEL | SPINOTTO | PIN |
| 42 | REC93101-20048 | 93101-20048 | RETÉN | OIL SEAL | PARAOLIO | JOINT SPI |
| 43 | REC6E7-45501-00 | 6E7-45501-00 | EJE S | DRIVE SHAFT COMP. S | ASSE VERTICALE S | ARBRE VERTICAL S |
| | REC6E7-45501-11 | 6E7-45501-10 | EJE L | DRIVE SHAFT COMP. L | ASSE VERTICALE L | ARBRE VERTICAL L |
| 44 | REC90280-03024 | 90280-03024 | CHAVETA | KEY, WOODRUFF | CHIAVETTA | CLAVETTE |
| 45 | REC682-44315-00 | 682-44315-00 | JUNTA | GASKET, WATER PUMP | GUARNIZIONE | JOINT |
| 46 | REC682-44323-40 | 682-44323-00 | PLATO | OUTER PLATE, CARTRIDGE | PIASTRA | PLAQUE DE POMPE À EAU |
| 47 | REC682-44352-01 | 682-44352-00 | TURBINA | IMPELLER | GIRANTE | TURBINE |
| 48 | REC682-44322-00 | 682-44322-00 | CASQUILLO INOX. | INSERT, CARTRIDGE | GHIERA INOX. | INSERT DE POMPE À EAU |
| 49 | REC682-44365-00 | 682-44365-00 | CASQUILLO GOMA | DAMPER, WATER SEAL | GHIERA GOMA | BAGUE |
| 50 | REC682-44312-00 | 682-44312-00 | TAPA CUERPO BOMBA AGUA | COVER, WATER PUMP HOUSING | COPERCHIO CORPO ACQUA | CORPS DE POMPE À EAU |
| 51 | PAGB/T845-ST4.2X16 | 97780-40112 | TORNILLO | SCREW, TAPPING | VITE | VIS |
| 52 | REC682-44328-00 | 682-44328-00 | PLATO | PLATE | PIASTRA | PLAQUE |
| 53 | PAGB/T5782-M6X45 | 947395-06040 | TORNILLO | BOLT | VITE | VIS |
| 54 | REC682-44361-01 | 682-44361-01 | TUBO DE AGUA S | WATER TUBE S | TUBO ACQUA S | TUBE D'EAU S |
| | REC682-44361-10 | 682-44361-10 | TUBO DE AGUA L | WATER TUBE L | TUBO ACQUA L | TUBE D'EAU L |
| 55 | REC626-44365-01 | 626-44365-01 | RETÉN | SEAL | PARAOLIO | JOINT SPI |
| 56 | REC6E7-44366-00 | 6E7-44366-00 | CASQUILLO GOMA | WATER SEAL | BOCCOLA GOMMA | GUIDE CAOUTCHOUC |
| 57 | PAGB/T5783-M6X10 | 97095-06010 | TORNILLO | BOLT | VITE | VIS |
| 58 | REC683-44373-00 | 683-44373-00 | PLACA FIJACION TUBO | PLATE WATER TUBE | PLACCA SUPPORTO TUBO | PLAQUE DE FIXATION DE TUBE |
| 59 | REC683-44362-01 | 683-44361-01 | TUBO DE AGUA | WATER TUBE "B" | TUBO ACQUA | TUBE D'EAU |
| 60 | REC683-44365-01 | 683-44365-01 | CASQUILLO GOMA | SEAL WATER TUBE | BOCCOLA GOMMA | GUIDE CAOUTCHOUC |

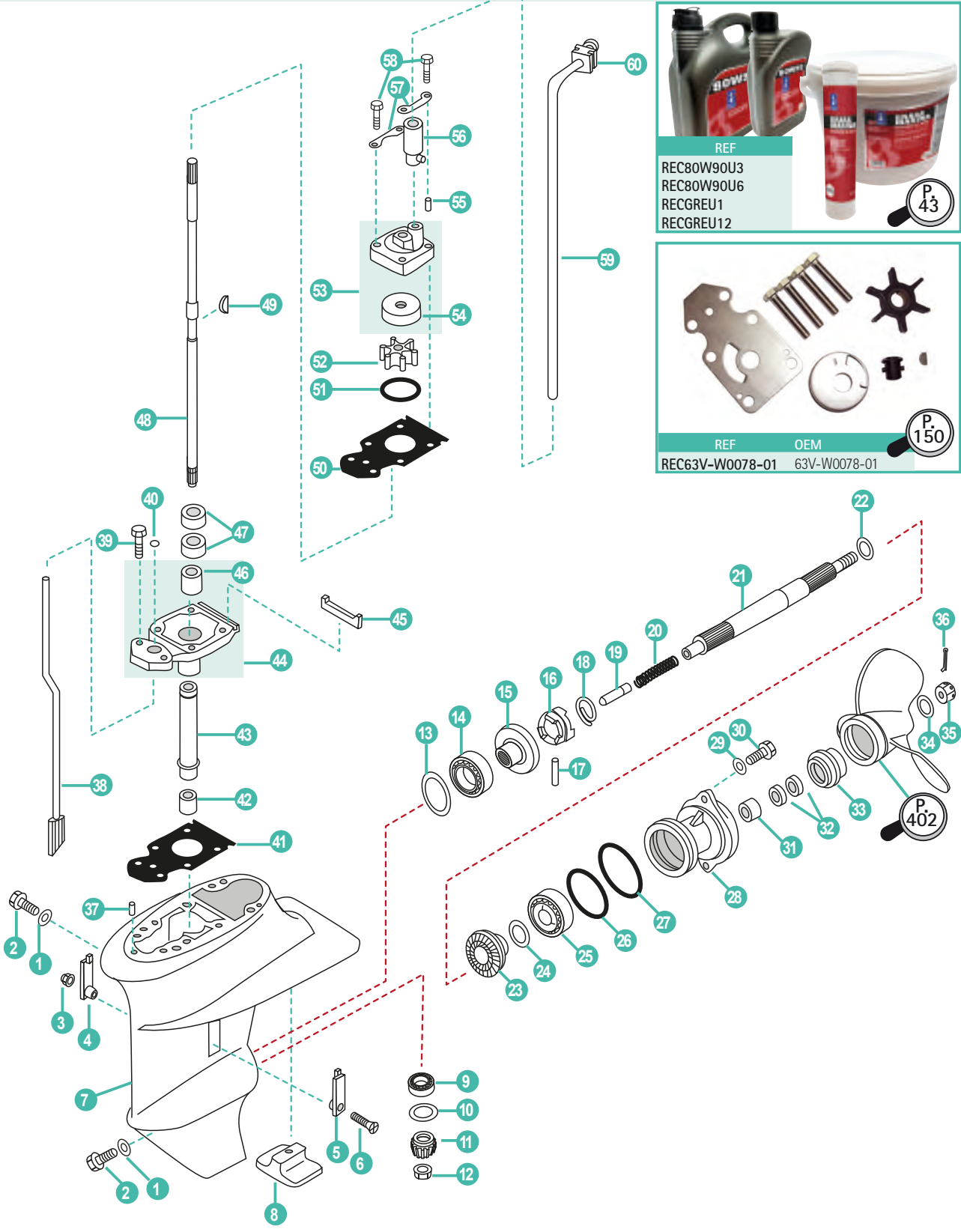

| | REF | OEM | | | | |
|---|-----------------|--------------|-------------------------|---------------|-------------------|-----------------------------|
| 1 | REC90430-08020 | 90430-08020 | ARANDELA | WASHER | RONDELLA | RONDELLE |
| 2 | REC90340-08002 | 90340-08002 | TAPÓN ACEITE | PLUG, OIL | TAPPO OLIO | BOUCHON REMPLISSAGE D'HUILE |
| 3 | PAGB/T6182-M5 | 90185-05002 | TUERCA | LOCK NUT | DADO | ÉCROU |
| 4 | PAF15-06000002 | 63V-45215-00 | CUBIERTA ENTRADA AGUA A | WATER INLET A | COPERCHIO ACQUA A | GRILLE D'ENTREE D'EAU A |
| 5 | PAF15-06000003 | 6G1-45214-00 | CUBIERTA ENTRADA AGUA B | WATER INLET B | COPERCHIO ACQUA B | GRILLE D'ENTREE D'EAU B |
| 6 | PAGB/T820-M5X25 | 90152-05M04 | TORNILLO | SCREW | VITE | VIS |

| | REF | OEM | | | | |
|----|--------------------|-----------------|-----------------------|--------------------------|----------------------------|------------------------------|
| 7 | PAF15-06000001 | 63V-45311-01-4D | CARTER | CASTING, LOWER | CARTER | CARTER D'EMBASE |
| 8 | CM61N-45251-01 | 61N-45251-01 | ÁNODO | ANODE | ANODO | ANODE |
| 9 | REC93341-41414 | 93341-41414 | RODAMIENTO | BEARING | CUSCINETTO | ROULEMENT |
| 10 | PAF15-06000008 | 6E8-45587-10-13 | GRUESO (1.13 mm) | SHIM (1.13mm) | SPESSORE (1.13 mm) | CALE (1.13 mm) |
| 11 | REC63V-45551-00 | 63V-45551-00 | PIÑÓN ATAQUE | INITIATIVE GEAR | MARCIA INIZIATIVA | PIGNON D'ATTAQUE |
| 12 | REC90179-08M06 | 90179-08M06 | TUERCA | LOCK NUT | DADO | ÉCROU |
| 13 | PAF15-06000010-1 | 664-45567-01-10 | GRUESO | SHIM | SPESSORE | CALE |
| 14 | REC93332-00005 | 93332-00005 | COJINETE | BEARING | CUSCINETTO | ROULEMENT |
| 15 | REC6E7-45560-01 | 6E7-45560-01 | PIÑÓN MARCHA AVANTE | POSITIVE GEAR ASSY | PIGNONE MARCIA AVANTI | PIGNON DE MARCHÉ AVANT |
| 16 | REC682-45631-00 | 682-45631-00 | SELECTOR | CLUTCH BLOCK | SELETTORE | CRABOT |
| 17 | REC90250-05010 | 90250-05010 | PASADOR | PIN | SPINOTTO | PIN |
| 18 | REC648-45633-00 | 648-45633-00 | MUELLE SELECTOR | RING, CROSS PIN | MOLLA SELETTORE | RESSORT |
| 19 | REC650-45635-00 | 650-45635-00 | ÉMBOLO | PLUNGER | BULLONE | PISTON |
| 20 | PAF15-06070002 | 90501-14M06 | MUELLE | SPRING | MOLLA | RESSORT |
| 21 | REC683-45611-00 | 683-45611-00 | EJE HÉLICE | PROPELLER SHAFT | ASSE ELICA | ARBRE D'HELICE |
| 22 | REC90201-17682 | 90201-17682 | ARANDELA | WASHER | RONDELLA | RONDELLE |
| 23 | REC6E7-45570-00 | 6E7-45571-00 | PIÑÓN MARCHA ATRÁS | REVERSE GEAR | PIGNONE MARCIA INDIETRO | PIGNON MARCHÉ ARRIÈRE |
| 24 | PAF15-06080006-1 | 626-45577-00 | GRUESO | SHIM | SPESSORE | CALE |
| 25 | REC93306-00501 | 93306-00501 | RODAMIENTO | BEARING (B6005) | CUSCINETTO | ROULEMENT |
| 26 | REC93210-57M09 | 93210-57M09 | TÓRICA | O-RING | O-RING | JOINT TORIQUE |
| 27 | PAF15-06080003 | 93210-56M80 | TÓRICA | O-RING | O-RING | JOINT TORIQUE |
| 28 | REC683-45361-01-4D | 683-45361-02-4D | DIÁBOLO | CAP, LOWER CASING | COPERCHIO CARTER INFERIORE | DIABOLO |
| 29 | PAGB/T97.1-6 | 92995-06600 | ARANDELA | WASHER | RONDELLA | RONDELLE |
| 30 | PAGB/T5783-M6X20 | 97095-06020 | TORNILLO | SCREW | VITE | VIS |
| 31 | REC93315-317U2 | 93315-317U2 | COJINETE | BEARING | CUSCINETTO | ROULEMENT |
| 32 | REC93101-17054 | 93101-17054 | RETÉN DE ACEITE | OIL SEAL | PARAOLIO | JOINT SPI |
| 33 | PAF15-06000015 | 6E7-45987-01 | ESPACIADOR | SPACER | DISTANZIALE | ENTRETOISE |
| 34 | REC6E7-45987-00 | 6E7-45987-01 | SEPARADOR | SPACER | DISTANZIALE | ENTRETOISE |
| 35 | REC90171-10M01 | 90171-10M01 | TUERCA HÉLICE | NUT, CASTLE | DADO ELICA | ÉCROU |
| 36 | REC91490-30025 | 91490-30020 | PASADOR ALETAS | PIN, COTTER | PIN ELICA | CLAVETTE |
| 37 | PAF15-00000013 | 93604-10M03 | PIN | PIN | SPINOTTO | PIN |
| 38 | PAF15-06030000S | 63V-44150-00 | EJE SELECTOR S | SHIFT CAM ASSY S | ASSE SELETTORE S | ARBRE SELECTEUR S |
| | PAF15-06030000L | 63V-44150-10 | EJE SELECTOR L | SHIFT CAM ASSY L | ASSE SELETTORE L | ARBRE SELECTEUR L |
| 39 | PAGB/T5783-M8X25 | 97080-08025 | TORNILLO | SCREW | VITE | VIS |
| 40 | REC93210-06ME6 | 93210-06ME6 | TÓRICA | O-RING | O-RING | JOINT TORIQUE |
| 41 | REC63V-45315-AO | 63V-45315-AO | JUNTA | GASKET | GUANIZIONE | JOINT |
| 42 | REC93315-314V8 | 93315-314V8 | COJINETE | BEARING | CUSCINETTO | PALIER |
| 43 | PAF15-06000006 | 63V-45536-00 | TUBO GUÍA | SLEEVE, DRIVE SHAFT | TUBO GUIDA | TUBE |
| 44 | REC63V-45331-00-5B | 63V-45331-00-5B | CUERPO DEL COJINETE | SHELL, BEARING | CORPO DE CUSCINETTO | LOGEMENT DE PALIER |
| 45 | PAF15-06020005 | 63V-45375-00 | GOMA | SEAL | GOMMA | TAMPON |
| 46 | REC626-45316-09 | 90381-14020 | CASQUILLO | BUSH, SOLID | BOCCOLA | BAGUE |
| 47 | REC93101-20048 | 93101-20048 | RETÉN DE ACEITE | OIL SEAL | PARAOLIO | JOINT SPI |
| 48 | REC63V-45510-01 | 63V-45510-01 | EJE VERTICAL S | DRIVE SHAFT ASSY S | ASSE VERTICALE S | ARBRE VERTICAL S |
| | REC63V-45510-11 | 63V-45510-11 | EJE VERTICAL L | DRIVE SHAFT ASSY L | ASSE VERTICALE L | ARBRE VERTICAL L |
| 49 | REC664-44338-00 | 63V-44338-00 | CHAVETA | KEY, WOODRUFF | CHIAVETTA | CLAVETTE |
| 50 | REC63V-44323-00 | 63V-44323-00 | JUNTA TAPA BOMBA AGUA | GASKET, WATER PUMP COVER | GUARNIZIONE COPERCHIO | JOINT COUVERCLE |
| 51 | PAJASOF404-31-045 | 93210-44398 | ARO TÓRICO | O-RING | O-RING | JOINT TORIQUE |
| 52 | REC63V-44352-01 | 63V-44352-01 | TURBINA | IMPELLER | GIRANTE | TURBINE |
| 53 | REC63V-44301-00 | 63V-44301-00 | CUERPO DE BOMBA | PUMP HOUSING | CORPO POMPA | CORPS DE POMPE À EAU |
| 54 | REC63V-44322-00 | 63V-44322-00 | TAPA, BOMBA AGUA | COVER, INNER WATER PUMP | COPERCHIO, POMPE ACQUA | INSERT DE POMPE À EAU |
| 55 | PAF15-00000013 | 93604-12M07 | PASADOR | PIN | SPINOTTO | PIN |
| 56 | REC647-44366-00 | 647-44366-00 | TUBO GOMA BOMBA AGUA | RUBBER TUBE, WATER PUMP | TUBO IN GOMMA, POMPA | DURITE DE COUTCHOU |
| 57 | PAF15-06000014 | 63V-44328-00 | PLACA | OUT PLATE | PIASTRA | PLAQUE |
| 58 | REC97080-08045 | 97080-08045 | PERNO | STUD | BULLONE | BOULON |
| 59 | REC63V-44361-01 | 63V-44361-01 | TUBO DE AGUA S | WATER TUBE S | TUBO DELL'ACQUA S | DURITE D'EAU S |
| | REC63V-44361-11 | 63V-44361-11 | TUBO DE AGUA L | WATER TUBE L | TUBO DELL'ACQUA L | DURITE D'EAU L |
| 60 | PAF15-02000006 | 63V-44365-10 | GOMA DEL TUBO DE AGUA | I-SHAPED RUBBER BAND | GOMMA TUBO ACQUA | PLOT CAOUTCHOU DE TUBE D'EAU |

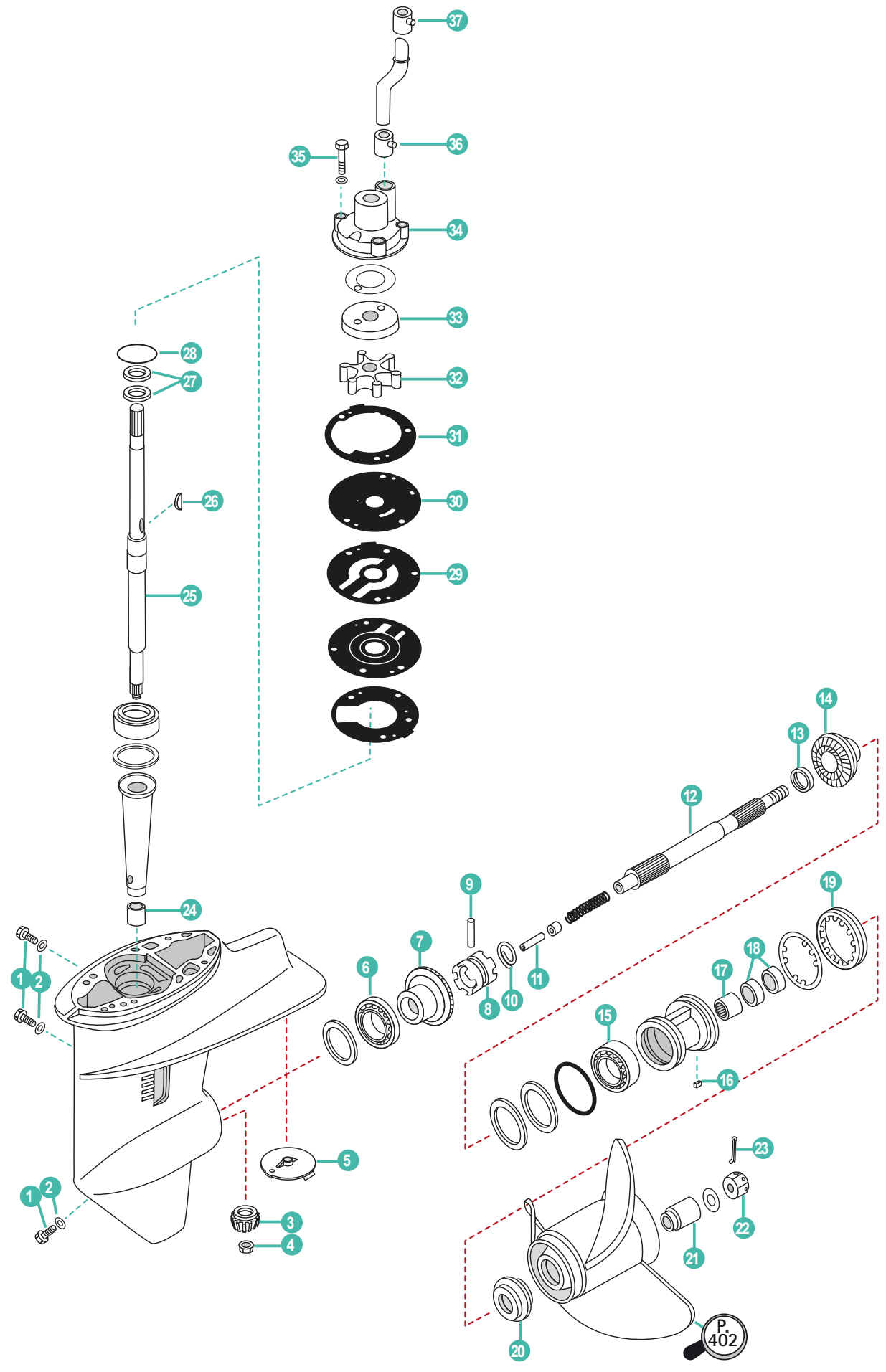

| | REF | OEM | | | | |
|----|--------------------|-----------------|-----------------------------|--------------------|-------------------------------|-----------------------------|
| 1 | REC90340-08002 | 90340-08002 | TAPÓN ACEITE | PLUG, OIL | TAPPO OLIO | BOUCHON REMPLISSAGE D'HUILE |
| 2 | REC90430-08020 | 90430-08020 | ARANDELA | WASHER | RONDELLA | RONDELLE |
| 3 | REC689-45551-00 | 689-45551-00 | PIÑÓN ATAQUE | INITIATIVE GEAR | MARCIA INIZIATIVA | PIGNON D'ATTAQUE |
| 4 | REC90179-09M02 | 90179-09M02 | TUERCA, PIÑÓN | NUT | DADO | ÉCROU |
| 5 | CM664-45371-01 | 664-45371-01-00 | ÁNODO | ANODE | ANODO | ANODE |
| 6 | REC93332-00005 | 93332-00005 | COJINETE | BEARING | CUSCINETTO | ROULEMENT |
| 7 | REC689-45560-00 | 689-45560-00 | PIÑÓN MARCHA AVANTE | POSITIVE GEAR ASSY | PIGNONE MARCIA AVANTI | PIGNON DE MARCHÉ AVANT |
| 8 | REC664-45631-01 | 664-45631-01 | SELECTOR | CLUTCH | SELETTORE | CRABOT |
| 9 | REC90250-05010 | 90250-05010 | PASADOR | PIN | SPINOTTO | LEVIER |
| 10 | REC648-45633-00 | 648-45633-00 | ARO, PASADOR | CROSS PIN | O-RING | JOINT TORIQUE |
| 11 | REC648-45635-00 | 648-45635-00 | PIVOTE | PIN | PERNO | ARBRE |
| 12 | REC689-45611-00 | 689-45611-00 | EJE HÉLICE | SHAFT PROPELLER | ASSE ELICA | ARBRE D'HELICE |
| 13 | REC90201-20417 | 90201-20417 | ARANDELA | WASHER | RONDELLA | RONDELLE |
| 14 | REC689-45571-00-00 | 689-45570-00 | PIÑÓN MARCHA ATRÁS | REVERSE GEAR | PIGNONE MARCIA INDIETRO | PIGNON MARCHÉ ARRIÈRE |
| 15 | REC93306-00612 | 93306-00612 | COJINETE | BEARING | CUSCINETTO | ROULEMENT |
| 16 | REC90282-04010 | 90282-04010 | CHAVETA | KEY | CHIAVETTA | CLAVETTE |
| 17 | REC93315-22004 | 93315-22004 | COJINETE | BEARING | CUSCINETTO | ROULEMENT |
| 18 | REC93101-20M07 | 93101-20M07 | RETÉN | OIL SEAL | PARAOLIO | JOINT D'HUILE |
| 19 | REC664-45384-00 | 664-45384-00 | TUERCA | NUT | DADO | ÉCROU |
| 20 | REC664-45987-00 | 664-45987-00 | ESPACIADOR | SPACER | DISTANZIALE | CALE |
| 21 | REC689-45997-00 | 689-45997-00 | ESPACIADOR | SAPCER | DISTANZIALE | CALE |
| 22 | REC90171-14013-00 | 90171-14013 | TUERCA HÉLICE | NUT | DADO | ÉCROU |
| 23 | REC91490-30030 | 91490-30030 | PASADOR | COTTER PIN | PIN | PIN |
| 24 | REC93315-017U4 | 93315-017U4 | COJINETE, PIÑÓN | BEARING | CUSCINETTO | ROULEMENT |
| 25 | REC689-45501-10 | 689-45501-10 | EJE L | DRIVE SHAFT L | ASSE VERTICALE L | ARBRE VERTICAL L |
| 26 | REC664-44338-00 | 664-44338-00 | CUÑA | CHAVETA | KEY | CHIAVETTA |
| 27 | REC93101-22067 | 93101-22067 | RETÉN ACEITE | OIL SEAL | PARAOLIO | JOINT SPI |
| 28 | REC689-44315-A0 | 689-44315-A0 | JUNTA BASE | GASKET | GUARNIZIONE | JOINT |
| 29 | REC689-44316-A0 | 689-44316-A0 | JUNTA BASE | GASKET | GUARNIZIONE | JOINT |
| 30 | REC689-44323-00 | 689-44323-03 | CHAPA | PLATE | PIASTRA | PLAQUE |
| 31 | REC689-44324-A0 | 689-44324-A0 | JUNTA, CHAPA | GASKET | GUARNIZIONE | JOINT |
| 32 | REC689-44352-02 | 689-44352-02 | IMPULSOR | IMPELLER | GIRANTE | TURBINE |
| 33 | REC689-W4432-01 | 689-W4432-02 | ACOPLE | INSERT CUP | ACCOPIAMENTO | INSERT DE POMPE À EAU |
| 34 | REC689-44311-00 | 689-44311-03 | CUERPO BOMBA AGUA | HOUSING W.P. | CORPO POMPA ACQUA | CORPS DE POMPE |
| 35 | REC90101-06M56 | 90101-06M56 | TORNILLO CUERPO BOMBA | BOLT | VITE | VIS |
| 36 | REC626-44365-01 | 626-44365-01 | RETÉN SUPERIOR TUBO DE AGUA | DUMPER WATER TUBE | PARAOLIO SUPERIORE TUBO ACQUA | BAGUE TUBE D'EAU |
| 37 | REC689-44366-00 | 689-44366-00 | RETÉN SUPERIOR TUBO DE AGUA | DUMPER WATER TUBE | PARAOLIO SUPERIORE TUBO ACQUA | BAGUE TUBE D'EAU |

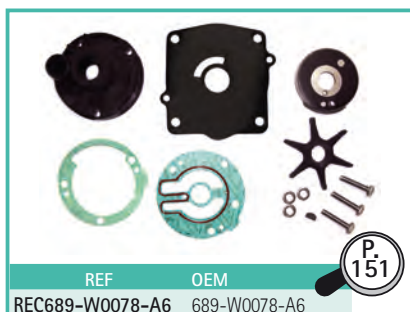

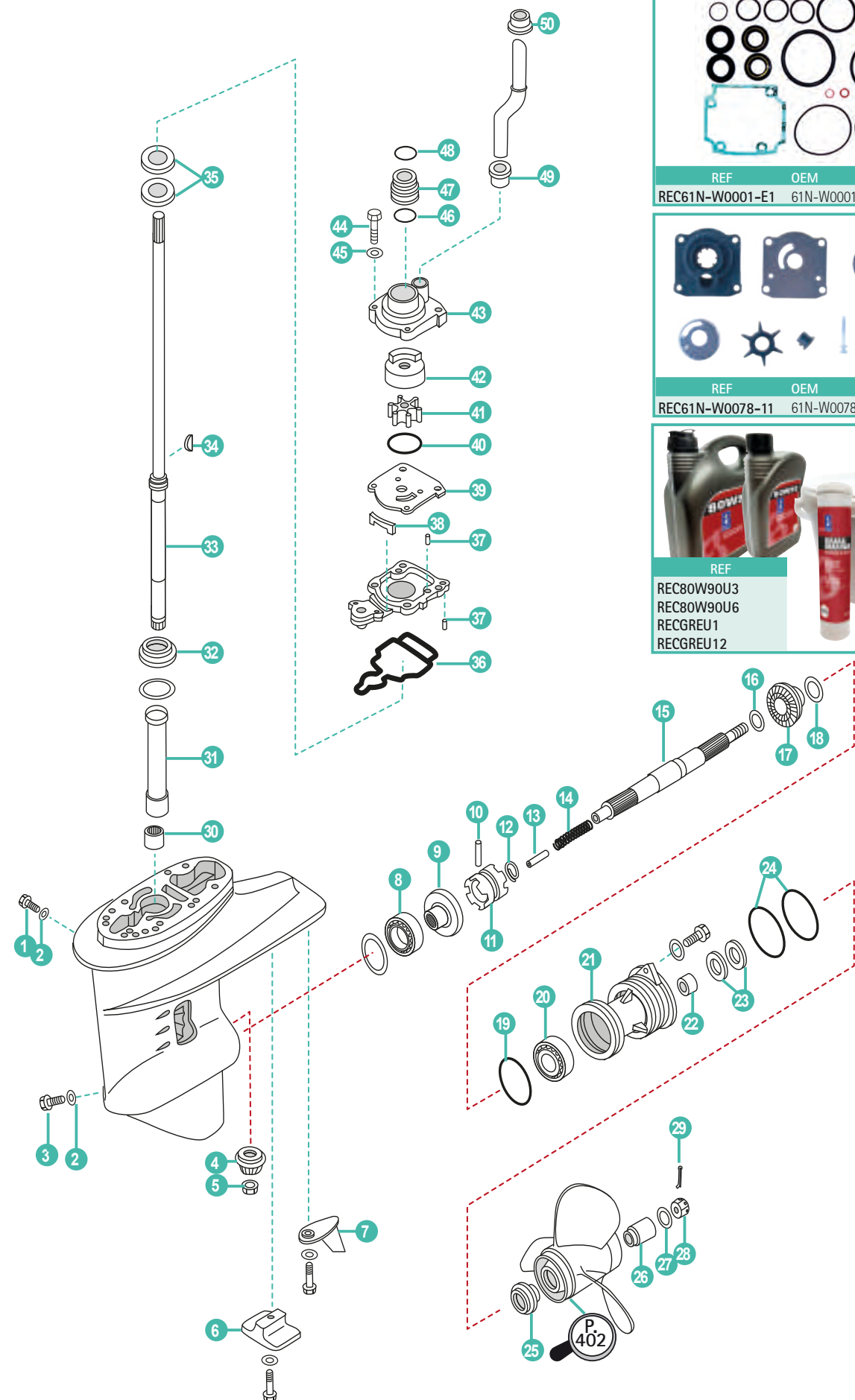

| REF | OEM |
|-----------------|--------------|
| REC61N-W0001-E1 | 61N-W0001-E1 |

P.145

| REF | OEM |
|-----------------|--------------|
| REC61N-W0078-11 | 61N-W0078-11 |

P.150

| REF |
|------------|
| REC80W90U3 |
| REC80W90U6 |
| RECGREU1 |
| RECGREU12 |

P.43

| REF | OEM |
|-----------------|--------------|
| REC61N-W0001-E1 | 61N-W0001-E1 |

P.402

| | REF | OEM | | | | |
|----|---------------------|-----------------|---------------------|-------------------------|-------------------------|------------------------|
| 1 | REC90340-08002 | 90340-08002 | TAPÓN | PLUG, STRAIGHT SCREW | TAPPO | BOUCHON |
| 2 | REC90430-08020 | 90430-08020 | JUNTA | GASKET | GUARNIZIONE | JOINT |
| 3 | REC688-45341-00 | 688-45341-10 | TAPÓN VACIADO | PLUG, DRAIN | TAPPO | BOUCHON |
| 4 | REC61N-45551-00 | 61N-45551-00 | PIÑÓN ATAQUE | INITIATIVE GEAR | MARCIA INIZIATIVA | PIGNON D'ATTAQUE |
| 5 | REC90179-10M14 | 90179-10M14 | TUERCA | NUT | DADO | ÉCROU |
| 6 | CM61N-45251-01 | 61N-45251-01 | ÁNODO | ANODE | ANODO | ANODE |
| 7 | TEN01130 | 61N-45371-00 | ÁNODO ZINC | TAB-TRIM | ANODO ZINCO | ANODE |
| 8 | REC93332-00005 | 93332-00005 | RODAMIENTO | BEARING | CUSCINETTO | ROULEMENT |
| 9 | REC61N-45560-10 | 61N-45560-10 | PIÑÓN MARCHA AVANTE | POSITIVE GEAR ASSY | PIGNONE MARCIA AVANTI | PIGNON DE MARCHÉ AVANT |
| 10 | REC90250-05010 | 90250-05010 | PASADOR | PIN, STRAIGHT | SPINOTTO | PIN |
| 11 | REC664-45631-00 | 664-45631-02 | DEAPLAZABLE | CLUTCH, DOG | SCORREVOLE | CRABOT |
| 12 | REC648-45633-00 | 648-45633-00 | MUELLE | RING, CROSS PIN | MOLLA | RESSORT |
| 13 | REC648-45635-00 | 648-45635-00 | BULÓN | PLUNGER, SHIFT | BULLONE | BOULON |
| 14 | PAF25-04060002 | 90501-10065 | MUELLE COMPRESIÓN | SPRING, COMPRESSION | MOLLA | RESSORT |
| 15 | REC6L2-45611-00 | 6L2-45611-00 | EJE HÉLICE | SHAFT, PROPELLER | ASSE ELICA | ARBRE D'HELICE |
| 16 | REC90201-20417 | 90201-20417 | ARANDELA | WASHER, PLATE | RONDELLA | RONDELLE |
| 17 | REC61N-45571-00 | 61N-45571-00 | PIÑÓN MARCHA ATRÁS | REVERSE GEAR | PIGNONE MARCIA INDIETRO | PIGNON MARCHE ARRIÈRE |
| 18 | PAF25-04070005-1 | 6L2-45577-00-10 | GRUESO (1.0 mm) | SHIM (t:1.0mm) | SPESSORE (1.0 mm) | CALE (1.0 mm) |
| 19 | REC93210-64ME7 | 93210-64ME7 | ARO TÓRICO | O-RING | O-RING | JOIN TORIQUE |
| 20 | REC93306-00612 | 93306-00612 | RODAMIENTO | BEARING | CUSCINETTO | ROULEMENT |
| 21 | PAF25-04070001 | 61N-45361-01-4D | DIÁBOLO | CAP, LOWER CASING | COP. CASSA INGRANAGGI | DIABOLO |
| 22 | REC93315-22004 | 93315-22004 | RODAMIENTO | BEARING | CUSCINETTO | ROULEMENT |
| 23 | REC93101-20M07 | 93101-20M07 | RETÉN | OIL SEAL | PARAOLIO | JOINT SPI |
| 24 | REC93210-65M50 | 93210-65M50 | ARO TÓRICO | O-RING | O-RING | JOINT TORIQUE |
| 25 | REC6L2-45987-00 | 6L2-45987-01 | SEPARADOR | SPACER | DISTANZIALE | CALE |
| 26 | REC689-45997-00 | 689-45997-00 | SEPARADOR | SPACER | DISTANZIALE | CALE |
| 27 | PAGB/T97.1-14 | 92990-14200 | ARANDELA | WASHER, PLAIN | RONDELLA | RONDELLE |
| 28 | REC90171-14013-00 | 90171-14013 | TUERCA | NUT, CASTLE | DADO | ÉCROU |
| 29 | PAGB/T91-1.6x12 | 91490-30022 | PASADOR | PIN | SPINOTTO | PIN |
| 30 | REC93315-220V7 | 93315-220V7 | RODAMIENTO | BEARING | CUSCINETTO | ROULEMENT |
| 31 | PAF25-04000002 | 61N-45536-00 | TUBO GUÍA | SLEEVE, DRIVE SHAFT | TUBO GUIDA | TUBE GUIDE |
| 32 | REC93332-000W5 | 93332-000WS | RODAMIENTO | BEARING | CUSCINETTO | ROULEMENT |
| 33 | REC61N-45510-00 | 61N-45510-00 | EJE VERTICAL S | DRIVE SHAFT ASSY S | ASSE VERTICALE S | ARBRE VERTICAL S |
| | REC61N-45510-10 | 61N-45510-10 | EJE VERTICAL L | DRIVE SHAFT ASSY L | ASSE VERTICALE L | ARBRE VERTICAL L |
| 34 | REC90280-03M03 | 90280-03M03 | CHAVETA | KEY, WOODRUFF | CHIAVETTA | CLAVETTE |
| 35 | REC93101-22067 | 93101-22067 | RETÉN | OIL SEAL | PARAOLIO | JOINT SPI |
| 36 | PAF25-04000009 | 61N-45315-00 | JUNTA | PACKING, LOWER CASING | GUARNIZIONE | JOINT |
| 37 | PAF25-04000007 | 93604-10M03 | PIN CENTRADO | PIN, DOWEL | SPINOTTO | PIN |
| 38 | PAF25-04000013 | 61N-45127-00 | RETÉN | SEAL | PARAOLIO | JOINT SPI |
| 39 | REC61N-44323-00 | 61N-44323-00 | PLATO BOMBA AGUA | OUTTER PLATE, CARTRIDGE | PIASTRA POMPA ACQUA | PLAQUE |
| 40 | PAF25-04050003 | 93210-45161 | ARO TÓRICO | O-RING | O-RING | JOINT TORIQUE |
| 41 | REC6H4-44352-02 | 6H4-44352-02 | TURBINA | IMPELLER | GIRANTE | TURBINE |
| 42 | REC61N-44322-00 | 61N-44322-01 | CASQUILLO INOX. | INSERT, CARTRIDGE | BOCCOLA INOX. | INSERT DE POMPE À EAU |
| 43 | PAF25-04050001 | 61N-44311-01 | CUERPO BOMBA | HOUSING, WATER PUMP | CORPO POMPA | CORPS DE POMPE À EAU |
| 44 | REC97095-06040 | 97095-06040 | TORNILLO | BOLT | VITE | VIS |
| 45 | PAGB/T97.1-6 | 92995-06600 | ARANDELA | WASHER | RONDELLA | RONDELLE |
| 46 | PAGB/T3452.1-25.8X2 | 93210-26130 | ARO TÓRICO | O-RING | O-RING | JOINT TORIQUE |
| 47 | PAF25-04000017S | 61N-44362-00 | TUBO AGUA S | WATER TUBE S | TUBO ACQUA S | TUBE D'EAU S |
| | PAF25-04000017 | 61N-44362-10 | TUBO AGUA L | WATER TUBE L | TUBO ACQUA L | TUBE D'EAU L |
| 48 | PAGB/T3452.1-25.8X2 | 93210-22164 | ARO TÓRICO | O-RING | O-RING | JOINT TORIQUE |
| 49 | PAF25-04050004 | 6L2-44367-00 | CASQUILLO | DAMPER WATER PIPE | BOCCOLA | BAGUE TUBE D'EAU |
| 50 | REC689-44366-00 | 689-44366-00 | CASQUILLO | DAMPER, WATER SEAL | BOCCOLA | BAGUE TUBE D'EAU |

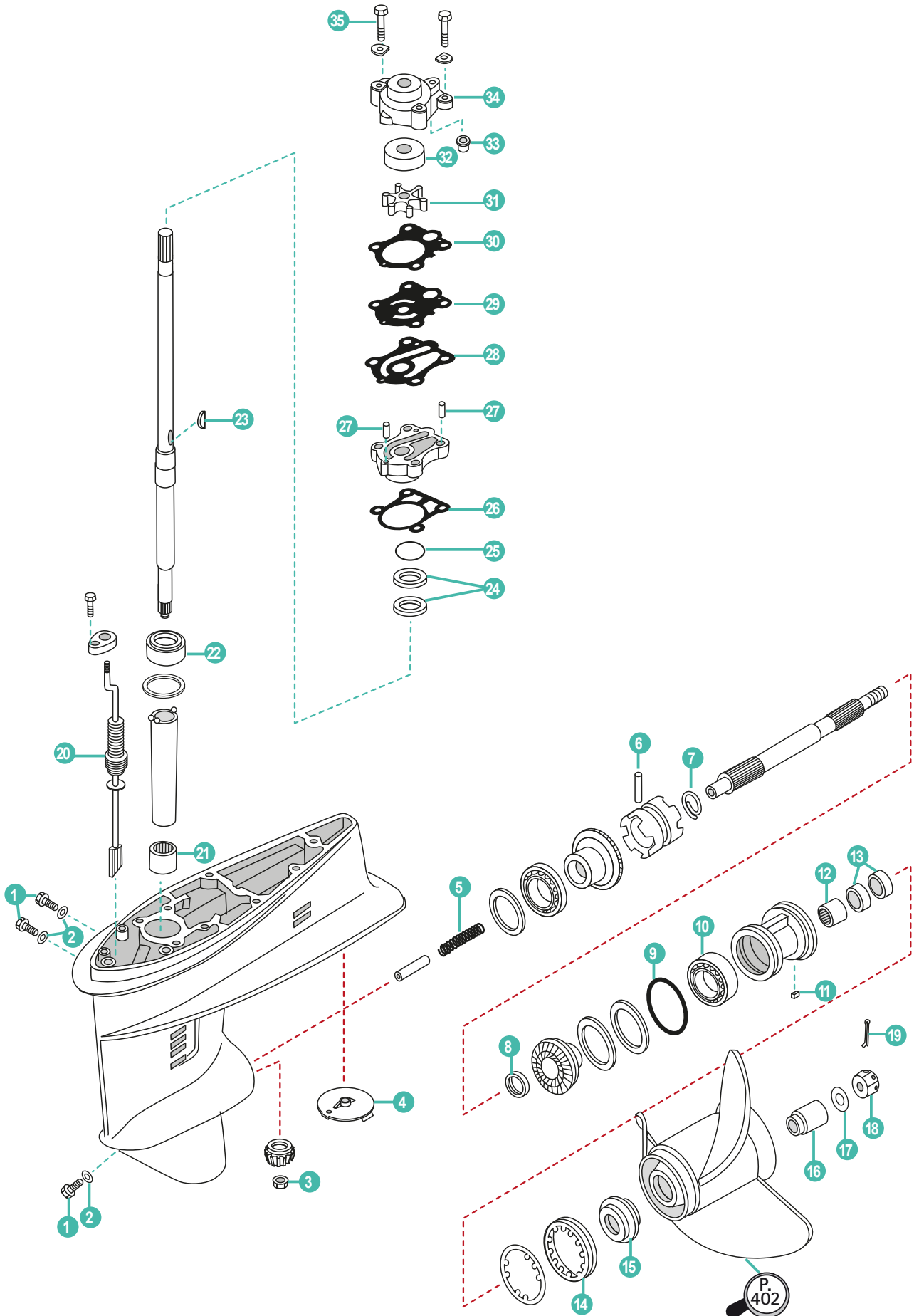

| | REF | OEM | | | | |
|----|-------------------|--------------|-------------------|----------------------|---------------------|-----------------------|
| 1 | REC90340-08002 | 90340-08002 | TAPÓN | PLUG, STRAIGHT SCREW | TAPPO | BOUCHON DE VIDANGE |
| 2 | REC90430-08020 | 90430-08020 | JUNTA | GASKET | GUARNIZIONE | JOINT |
| 3 | REC90179-10M14 | 90179-10M14 | TUERCA | NUT | DADO | ECROU |
| 4 | CM664-45371-01 | 664-45371-01 | ÁNODO DERIVA | TAB-TRIM | ANODO | ANODE |
| 5 | PAF25-04060002 | 90501-10065 | MUELLE | SPRING, COMPRESSION | MOLLA | RESSORT |
| 6 | REC90250-05010 | 90250-05010 | PASADOR | PIN, STRAIGHT | SPINOTTO | PIN |
| 7 | REC648-45633-00 | 648-45633-00 | ARO | RING CROSS PIN | O-RING | JOINT TORIQUE |
| 8 | REC90201-20417 | 90201-20417 | ARANDELA | WASHER, PLATE | RONDELLA | RONDELLE |
| 9 | REC93210-60MA3 | 93210-60MA3 | ARO TÓRICO | O-RING | O-RING | JOINT TORIQUE |
| 10 | REC93306-00612 | 93306-00612 | RODAMIENTO | BEARING | CUSCINETTO | ROULEMENT |
| 11 | REC90282-04010 | 90282-04010 | CHAVETA | KEY, STRAIGHT | CHIAVETTA | CLAVETTE |
| 12 | REC93315-22004 | 93315-22004 | RODAMIENTO | BEARING | CUSCINETTO | ROULEMENT |
| 13 | REC93101-20M07 | 93101-20M07 | RETÉN | OIL SEAL | PARAOLIO | JOINT SPI |
| 14 | REC664-45384-00 | 664-45384-00 | TUERCA | NUT | DADO | EROU |
| 15 | REC6L2-45987-00 | 6L2-45987-01 | DISTANCIADOR | SPACER | DISTANZIALE | ENTRETOISE |
| 16 | REC689-45997-00 | 689-45997-00 | DISTANCIADOR | SPACER | DISTANZIALE | ENTRETOISE |
| 17 | PAGB/T97.1-14 | 92990-14200 | ARANDELA | WASHER, PLAIN | RONDELLA | RONDELLE |
| 18 | REC90171-14013-00 | 90171-14013 | TUERCA HÉLICE | NUT, CASTLE | DADO | ECROU D'HELICE |
| 19 | REC91490-30025 | 91490-30025 | PIN | PIN | SPINOTTO | CLAVETTE |
| 20 | REC682-44147-00 | 682-44147-00 | TAPÓN GUÍA | BOOT, SHIFT ROD | TAPPO | GUIDE |
| 21 | REC93315-220V7 | 93315-220V7 | RODAMIENTO | BEARING | CUSCINETTO | ROULEMENT |
| 22 | REC93332-00001 | 93332-00001 | RODAMIENTO | BEARING | CUSCINETTO | ROULEMENT |
| 23 | REC90280-03024 | 90280-03024 | CHAVETA | KEY, WOODRUFF | CHIAVETTA | CLAVETTE |
| 24 | REC93101-23070 | 93101-23070 | RETÉN | OIL SEAL | PARAOLIO | JOINT SPI |
| 25 | REC93210-41042 | 93210-41042 | ARO TÓRICO | O-RING | O-RING | JOINT TORIQUE |
| 26 | REC663-44316-A0 | 663-44316-A0 | JUNTA | GASKET, WATER PUMP | GUARNIZIONE | JOINT |
| 27 | PAF25-04000007 | 93604-08062 | PIN | PIN | SPINOTTO | PIN |
| 28 | REC663-44324-00 | 663-44324-A0 | JUNTA | GASKET, CARTRIDGE | GUARNIZIONE | JOINT |
| 29 | REC663-44323-00 | 663-44323-00 | PLATO BOMBA AGUA | OUTTER PLATE | PIASTRA POMPA ACQUA | PLAQUE DE POMPE À EAU |
| 30 | REC663-44315-A0 | 663-44315-A0 | JUNTA | GASKET, WATER PUMP | GUARNIZIONE | JOINT |
| 31 | REC6H4-44352-02 | 6H4-44352-02 | TURBINA | IMPELLER | GIRANTE | TURBINE |
| 32 | REC663-44322-00 | 663-44322-00 | CASQUILLO INOX | INSERT, CARTRIDGE | BOCCOLA INOX. | INSERT DE POMPE À EAU |
| 33 | REC663-44366-00 | 663-44366-00 | CASQUILLO GOMA | DAMPER, WATER SEAL | BOCCOLA GOMMA | BAGUE |
| 34 | REC663-44311-02 | 6J8-44311-00 | CUERPO BOMBA AGUA | HOUSING, WATER | CORPO POMPA ACQUA | CORPS DE POMPE À EAU |
| 35 | REC90119-08M13 | 90119-08M13 | TORNILLO | BOLT, WITH WASHER | VITE | VIS |

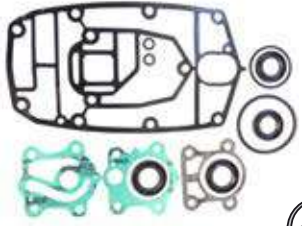

| REF | OEM |
|-----------------|--------------|
| REC6J8-W0001-21 | 6J8-W0001-21 |

P. 145



| REF | OEM |
|-----------------|--------------|
| REC6J8-W0078-A2 | 6J8-W0078-C2 |

P. 151



| REF |
|------------|
| REC80W90U3 |
| REC80W90U6 |
| RECGREU1 |
| RECGREU12 |

P. 43

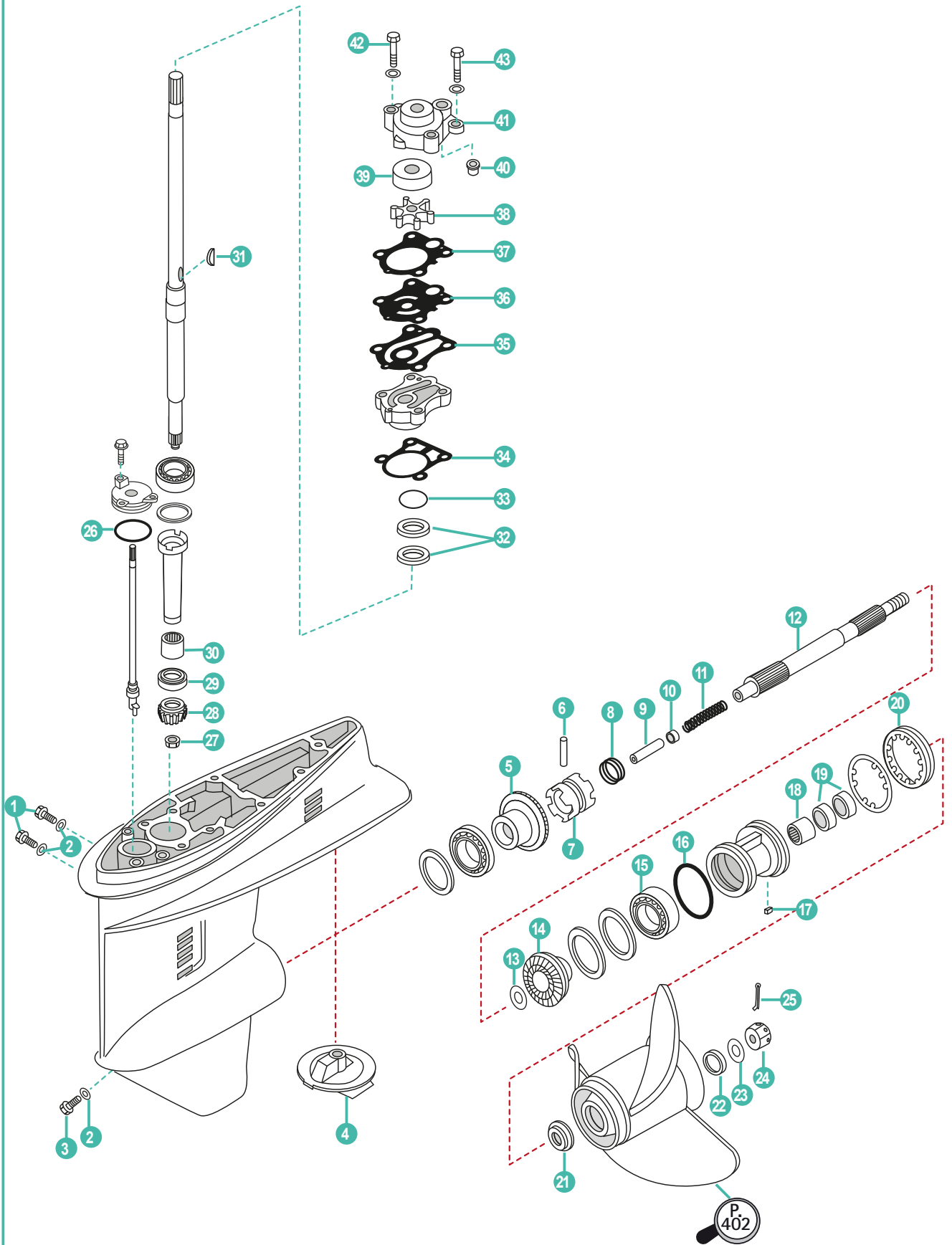

| | REF | OEM | | | | |
|----|-----------------|--------------|---------------------|--------------------|-------------------------|------------------------|
| 1 | REC90340-08002 | 90340-08014 | TORNILLO | BOLT | VITE | VIS |
| 2 | REC90430-08020 | 90430-08020 | JUNTA | GASKET | GUARNIZIONE | JOINT |
| 3 | REC688-45341-00 | 688-45341-00 | TAPÓN DRENAJE | PLUG | TAPPO | BOUCHON DE VIDANGE |
| 4 | CM664-45371-01 | 664-45371-01 | ÁNODO | ANODE | ANODO | ANODE |
| 5 | REC6H4-45560-00 | 6H4-45560-00 | PIÑÓN MARCHA AVANTE | POSITIVE GEAR ASSY | PIGNONE MARCIA AVANTI | PIGNON DE MARCHÉ AVANT |
| 6 | REC90250-06023 | 90250-06023 | PASADOR | PIN | SPINOTTO | PIN |
| 7 | REC663-45631-00 | 663-45631-01 | DESPLAZABLE | CLUTCH | SCORREVOLE | CRABOT |
| 8 | REC663-45633-00 | 663-45633-00 | ARO | SPING | O-RING | JOINT TORIQUE |
| 9 | REC676-45635-00 | 676-45635-00 | PIVOTE | PIN | SPINOTTO | PIVOT |
| 10 | REC663-45634-00 | 663-45634-00 | CASQUILLO | SLIDE | BOCCOLA | DOUILLE |
| 11 | REC90501-16M01 | 90501-16M01 | MUELLE | SPRING | MOLLA | RESSORT |
| 12 | REC679-45611-00 | 679-45611-01 | EJE HÉLICE | SHAFT PROPELLER | ASSE ELICA | ARBRE D'HELICE |
| 13 | REC90201-22429 | 90201-22429 | ARANDELA | WASHER | RONDELLA | RONDELLE |
| 14 | REC6H4-45570-00 | 6H4-45571-00 | PIÑÓN MARCHA ATRÁS | REVERSE GEAR | PIGNONE MARCIA INDIETRO | PIGNON MARCHE ARRIÈRE |
| 15 | REC93306-00702 | 93306-00702 | RODAMIENTO BOLAS | BEARING | CUSCINETTO | ROULEMENT |
| 16 | REC93210-66M98 | 93210-66M98 | ARO | O-RING | O-RING | JOINT TORIQUE |
| 17 | REC90282-04010 | 90282-04010 | CHAVETA | KEY | CHIAVETTA | CLAVETTE |
| 18 | REC93317-22204 | 93317-22204 | COJINETE AGUJAS | CILINDRIC BEARING | CUSCINETTO | ROULEMENT |
| 19 | REC93101-22067 | 93101-22067 | RETÉN ACEITE | OIL SEAL | PARAOLIO | JOINT SPI |
| 20 | REC697-45384-00 | 697-45384-00 | TUERCA | NUT | DADO | ÉCROU |
| 21 | REC663-45987-00 | 663-45987-02 | ESPACIADOR | SPACER | DISTANZIALE | ENTRETOISE |
| 22 | REC670-45997-00 | 670-45997-02 | ESPACIADOR | SPACER | DISTANZIALE | ENTRETOISE |
| 23 | REC92990-16200 | 92990-16200 | ARANDELA | WASHER | RONDELLA | RONDELLE |
| 24 | REC90171-16011 | 90171-16011 | TUERCA | NUT | DADO | ÉCROU D'HELICE |
| 25 | REC91490-30030 | 91490-30030 | PASADOR | PIN COTTER | SPINOTTO | CLAVETTE |
| 26 | REC93210-49046 | 93210-49046 | ARO PLATO | O-RING | O-RING | JOINT TORIQUE |
| 27 | REC90170-12138 | 90170-12138 | TUERCA | NUT | DADO | ÉCROU |
| 28 | REC6H4-45551-00 | 6H4-45551-00 | PIÑÓN ATAQUE | INITIATIVE GEAR | MARCIA INIZIATIVA | PIGNON D'ATTAQUE |
| 29 | REC663-45552-00 | 663-45552-00 | COJINETE (-1998) | BEARING (-1998) | CUSCINETTO (-1998) | ROULEMENT (-1998) |
| 30 | REC93315-32224 | 93315-32224 | RODAMIENTO AGUJAS | BEARING | CUSCINETTO | ROULEMENT |
| 31 | REC90280-03024 | 90280-03024 | CHAVETA | KEY | CHIAVETTA | CLAVETTE |
| 32 | REC93101-23070 | 93101-23070 | RETÉN ACEITE | OIL SEAL | PARAOLIO | JOINT SPI |
| 33 | REC93210-41042 | 93210-41042 | ARO, BASE BOMBA | O-RING | O-RING | JOINT TORIQUE |
| 34 | REC663-44316-A0 | 663-44316-A0 | JUNTA BASE | GASKET | GUARNIZIONE | JOINT |
| 35 | REC663-44324-A0 | 663-44324-A0 | JUNTA | GASKET | GUARNIZIONE | JOINT |
| 36 | REC663-44323-00 | 663-44323-00 | TAPA | OUTTER PLATE | TAPPO | PLAQUE DE POMPE À EAU |
| 37 | REC663-44315-A0 | 663-44315-A0 | JUNTA | GASKET | GUARNIZIONE | JOINT |
| 38 | REC6H4-44352-02 | 6H4-44352-02 | IMPULSOR | IMPELLER | GIRANTE | TURBINE |
| 39 | REC663-44322-00 | 663-44322-00 | CASQUILLO | INSERT CARTRIDGE | BOCCOLA | INSERT DE POMPE À EAU |
| 40 | REC663-44366-00 | 663-44366-00 | RETÉN | SEAL | TENUTA | JOINT SPI |
| 41 | REC663-44311-02 | 663-44311-02 | CUERPO BOMBA AGUA | HOUSING WATER P. | CORPO POMPA ACQUA | CORPS DE POMPE À EAU |
| 42 | REC97095-08045 | 97395-08045 | TORNILLO | BOLT | VITE | VIS |
| 43 | REC97095-08055 | 97395-08055 | TORNILLO | BOLT | VITE | VIS |

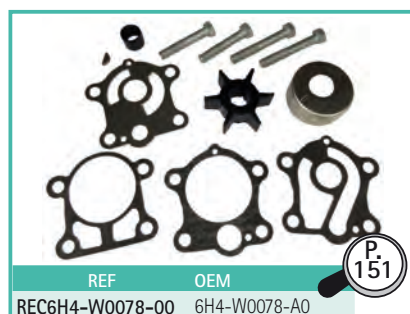
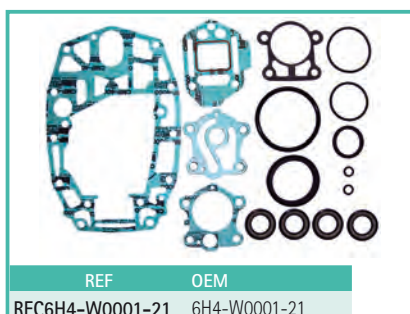

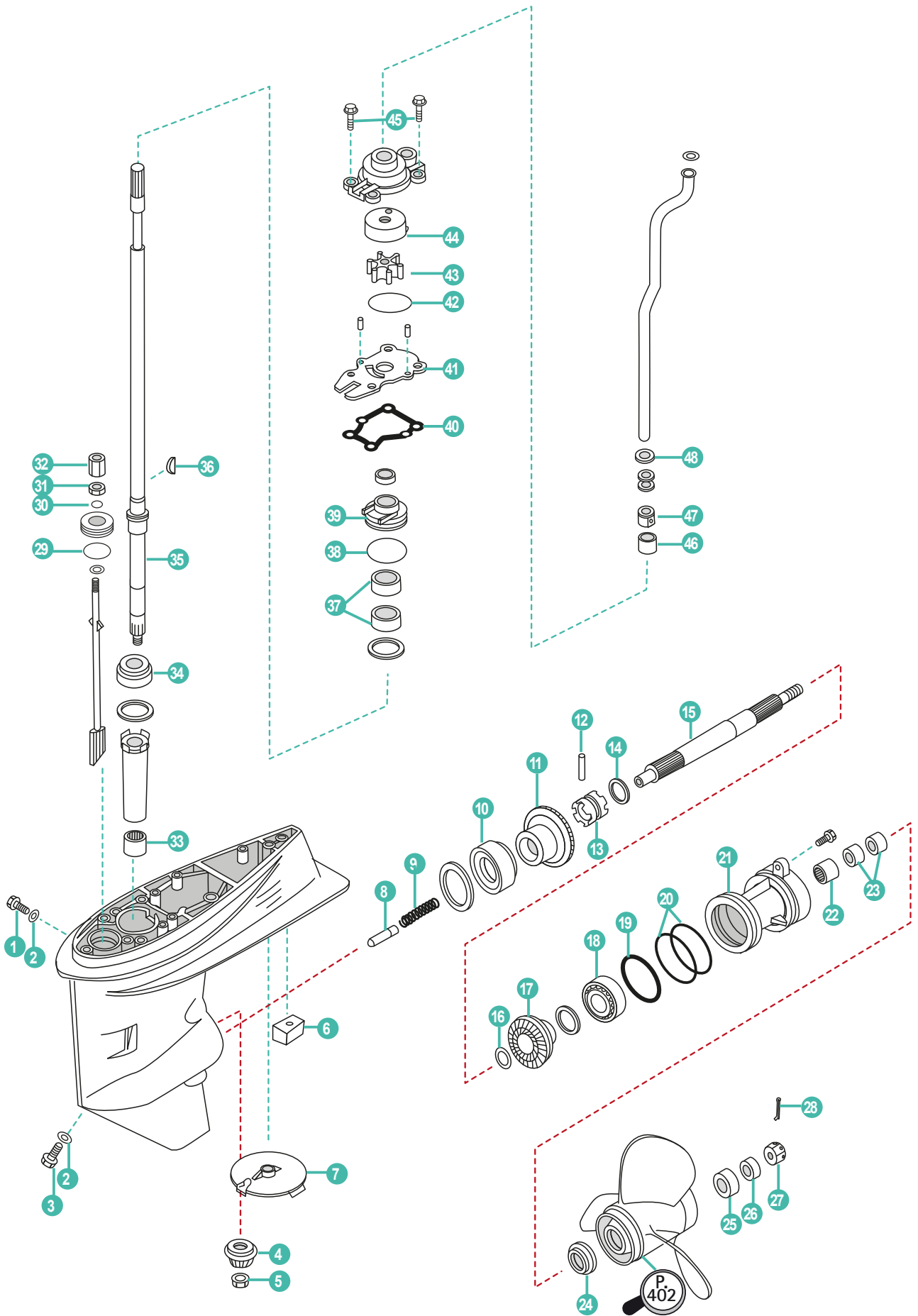

| | REF | OEM | | | | |
|----|--------------------|-----------------|---------------------|--------------------|-------------------------|------------------------|
| 1 | REC90340-08002 | 90340-08002 | TAPÓN | PLUG | TAPPO | BOUCHON DE VIDANGE |
| 2 | REC90430-08020 | 90430-08020 | JUNTA | GASKET | GUARNIZIONE | JOINT |
| 3 | REC688-45341-00 | 688-45341-10 | TAPÓN | PLUG | TAPPO | BOUCHON DE VIDANGE |
| 4 | REC66T-45551-00 | 66T-45551-00 | PIÑÓN ATAQUE | INITIATIVE GEAR | MARCIA INIZIATIVA | PIGNON D'ATTAQUE |
| 5 | REC90170-12138 | 90170-12138 | TUERCA | NUT | DADO | ECROU |
| 6 | CM67C-45251-00 | 67C-45251-00 | ÁNODO | ANODE | ANODO | ANODE |
| 7 | CM664-45371-01 | 664-45371-01 | ÁNODO DERIVA | TAB-TRIM | ANODO | ANODE |
| 8 | REC66T-45635-00 | 66T-45635-00 | BULÓN | PLUNGER | BULLONE | BOULON |
| 9 | PAT40-04050002 | 90501-15M01 | RESORTE | SPRING | MOLLA | RESSORT |
| 10 | REC93332-00003 | 93332-00003 | RODAMIENTO | BEARING | CUSCINETTO | ROULEMENT |
| 11 | REC66T-45560-00 | 66T-45560-01 | PIÑÓN MARCHA AVANTE | POSITIVE GEAR ASSY | PIGNONE MARCIA AVANTI | PIGNON DE MARCHÉ AVANT |
| 12 | REC90250-06023 | 90250-06023 | PASADOR | PIN | SPINOTTO | PIN |
| 13 | REC66T-45631-00 | 66T-45631-00 | SELECTOR | CLUTCH, DOG | SELETTORE | CRABOT |
| 14 | REC663-45633-00 | 663-45633-00 | ANILLO | RING | O-RING | JOINT TORIQUE |
| 15 | REC66T-45611-00 | 66T-45611-00 | EJE HÉLICE | SHAFT | ASSE ELICA | ARBRE D'HELICE |
| 16 | REC90201-22429 | 90201-22429 | ARANDELA | WASHER | RONDELLA | RONDELLE |
| 17 | REC66T-45571-00 | 66T-45571-00 | PIÑÓN MARCHA ATRÁS | REVERSE GEAR | PIGNONE MARCIA INDIETRO | PIGNON MARCHÉ ARRIÈRE |
| 18 | REC93306-001U1 | 93306-001U1 | RODAMIENTO | BEARING | CUSCINETTO | ROULEMENT |
| 19 | REC93210-69MG6 | 93210-69MG6 | ANILLO TÓRICO | O-RING | O-RING | JOINT TORIQUE |
| 20 | REC93210-74MG5 | 93210-74MG5 | ANILLO TÓRICO | O-RING | O-RING | JOINT TORIQUE |
| 21 | REC63D-45361-02-4D | 63D-45361-02-4D | DIÁVOLO | CAP | COP. CASSA INGRANAGGI | DIABOLO |
| 22 | REC93317-22204 | 93317-22204 | RODAMIENTO | BEARING | CUSCINETTO | ROULEMENT |
| 23 | REC93101-22M00 | 93101-22M00 | RETÉN | OIL SEAL | PARAOLIO | JOINT SPI |
| 24 | REC663-45987-00 | 663-45987-02 | ESPACIADOR | SPACER | DISTANZIALE | ENTRETOISE |
| 25 | REC66T-45997-00 | 66T-45997-00 | ESPACIADOR | SPACER | DISTANZIALE | ENTRETOISE |
| 26 | REC90389-22M01 | 90389-22M01 | CASQUILLO GRUESO | BUSH | BOCCOLA | RONDELLE D'HELICE |
| 27 | REC90171-16011 | 90171-16011 | TUERCA HÉLICE | NUT, CASTLE | DADO | ECROU D'HELICE |
| 28 | REC91490-30025 | 91490-30025 | PASADOR ALETAS | PIN | SPINOTTO | CLAVETTE |
| 29 | REC93210-33MG4 | 93210-33MG4 | ARILLO TÓRICO | O-RING | O-RING | JOINT TORIQUE |
| 30 | REC93210-06ME6 | 93210-06ME6 | ARILLO TÓRICO | O-RING | O-RING | JOINT TORIQUE |
| 31 | REC95380-06700 | 95380-06700 | TUERCA | NUT | DADO | ECROU |
| 32 | REC61N-44146-00 | 61N-44146-00 | CONECTOR | CONNECTOR | RACCORDO | CONNECTEUR |
| 33 | REC93315-32224 | 93315-32224 | RODAMIENTO | BEARING | CUSCINETTO | ROULEMENT |
| 34 | REC93332-00001 | 93332-00001 | RODAMIENTO | BEARING | CUSCINETTO | ROULEMENT |
| 35 | REC66T-45501-01 | 66T-45501-01 | EJE VERTICAL S | DRIVE SHAFT ASSY S | ASSE VERTICALE S | ARBRE VERTICAL S |
| | REC66T-45501-10 | 66T-45501-11 | EJE VERTICAL L | DRIVE SHAFT ASSY L | ASSE VERTICALE L | ARBRE VERTICAL L |
| 36 | REC90280-03M03 | 90280-03M03 | CHAVETA | KEY | CHIAVETTA | CLAVETTE |
| 37 | REC93101-22M60 | 93101-22M60 | RETÉN | OIL SEAL | PARAOLIO | JOINT SPI |
| 38 | REC93210-48MG8 | 93210-48MG8 | ARILLO TÓRICO | O-RING | O-RING | JOINT TORIQUE |
| 39 | REC63D-44341-00 | 63D-44341-00 | CUERPO | HOUSING | CORPO | LOGEMENT |
| 40 | REC63D-44316-00 | 63D-44316-00 | JUNTA | GASKET, WATER PUMP | GUARNIZIONE | JOINT |
| 41 | REC66T-44323-00 | 66T-44323-00 | PLATO | OUTTER PLATE | PIASTRA | PLAQUE DE POMPE À EAU |
| 42 | REC93210-59MG7 | 93210-59MG7 | ARILLO TÓRICO | O-RING | O-RING | JOINT TORIQUE |
| 43 | REC6H4-44352-02 | 6H4-44352-02 | TURBINA | IMPELLER | GIRANTE | TURBINE |
| 44 | REC63D-44322-00 | 63D-44322-00 | CASQUILLO | INSERT | BOCCOLA | INSERT DE POMPE À EAU |
| 45 | REC90119-08M15 | 90119-08M15 | TORNILLO | BOLT | VITE | BOULON |
| 46 | REC663-44366-00 | 663-44366-00 | CASQUILLO | DAMPER | BOCCOLA | DOUILLE |
| 47 | REC63D-44312-00 | 63D-44312-00 | TAPA | COVER | COPERCHIO | BAGUE |
| 48 | REC90430-12072 | 90430-12072 | JUNTA | GASKET | GUARNIZIONE | JOINT |

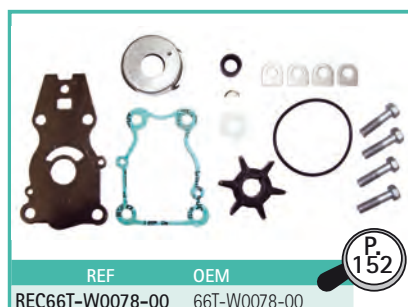
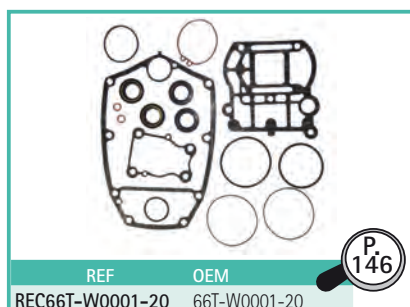

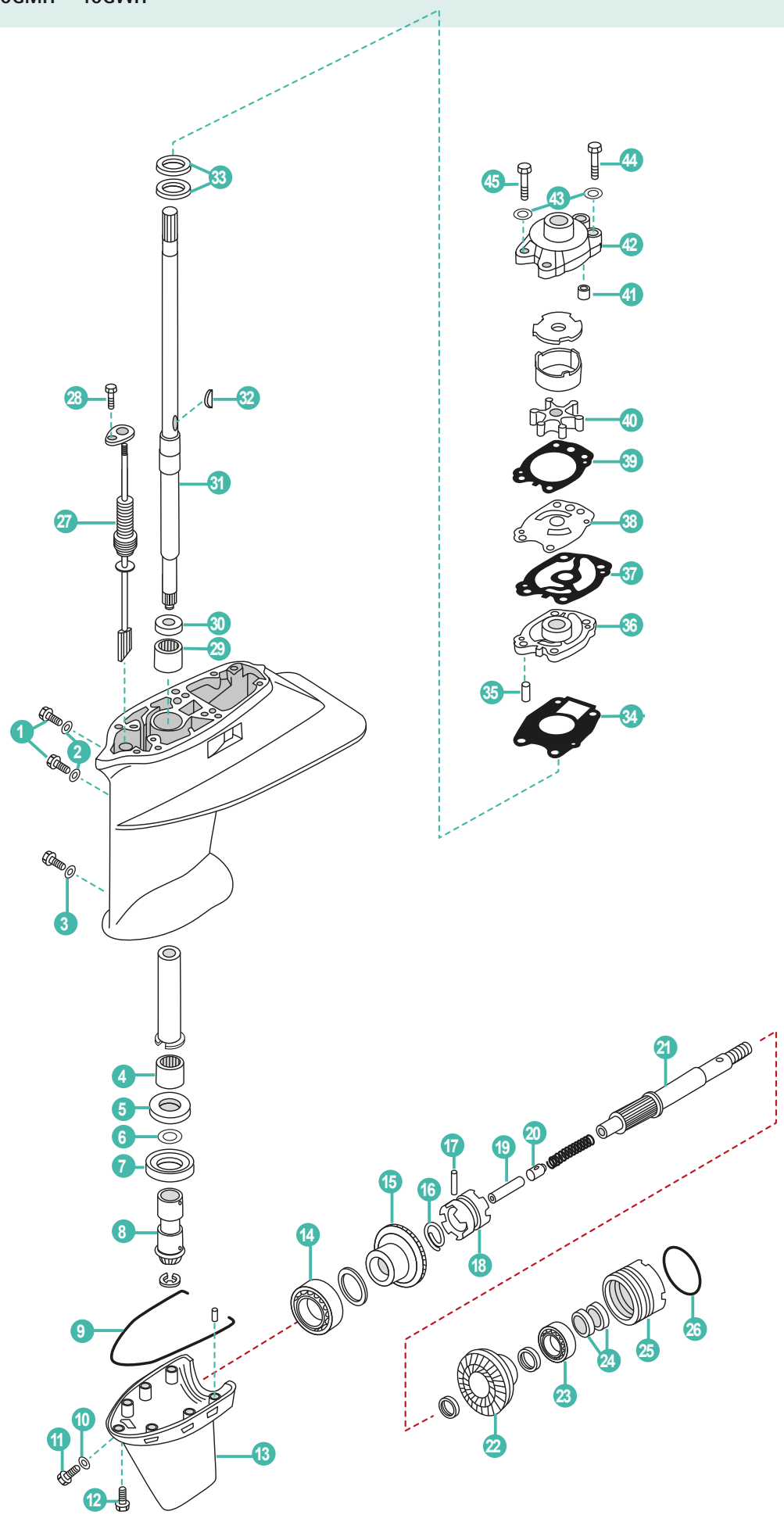

| | REF | OEM | | | | |
|----|--------------------|-----------------|-----------------------------|--------------------|-----------------------------|---------------------------|
| 1 | REC90340-08002 | 90340-08002 | TORNILLO, DRENAJE | BOLT DRAIN | VITE | BOUCHON DE VIDANGE |
| 2 | REC90430-08020 | 90430-08020 | JUNTA | GASKET | GUARNIZIONE | JOINT |
| 3 | REC90430-06M03 | 90430-06M03 | JUNTA | GASKET | GUARNIZIONE | JOINT |
| 4 | REC93315-324U1 | 93315-324U1 | COJINETE DE RODILLOS | BEARING | CUSCINETTO | ROULEMENT |
| 5 | REC93342-624U0 | 93342-624U0 | COJINETE CON RODAMIENTOS | BEARING | CUSCINETTO | ROULEMENT |
| 6 | REC676-45587-00 | 676-45587-00-70 | GRUESO | SHIM (t:0.070mm) | SPESSORE | CALE (0.070mm) |
| | REC676-45587-00-75 | 676-45587-00-75 | GRUESO | SHIM (t:0.075mm) | SPESSORE | CALE (0.075mm) |
| | REC676-45587-00-80 | 676-45587-00-80 | GRUESO | SHIM (t:0.080mm) | SPESSORE | CALE (0.080mm) |
| 7 | REC93390-000U0 | 93390-000U0 | COJINETE DE RODILLOS | BEARING | CUSCINETTO | ROULEMENT |
| 8 | REC6F5-45551-00 | 6F5-45551-00 | PIÑÓN | PINION (13T) | PIGNONE | PIGON (13D) |
| 9 | REC676-45314-00 | 676-45314-00 | SELLO DE FUNDA INFERIOR | SEAL | BOCCOLA COPERCHIO INFERIORE | JOINT DE CARTER INFERIEUR |
| 10 | REC90430-08020 | 90430-08020 | JUNTA | GASKET | GUARNIZIONE | JOINT |
| 11 | REC688-45341-00 | 688-45341-10 | TAPÓN, DREN | BOLT DRAIN | TAPPO | BOUCHON DE VIDANGE |
| 12 | REC90105-06M01 | 90105-06M01 | TORNILLO | BOLT | VITE | VIS |
| 13 | REC6F5-45312-00-4D | 6F5-45312-01-4D | FUNDA INFERIOR | CASING | COPERCHIO INFERIORE | CARTER INFERIEUR |
| 14 | REC93332-000U0 | 93332-000U0 | COJINETE | BEARING | CUSCINETTO | ROULEMENT |
| 15 | REC6F5-45560-00 | 6F5-45560-00 | PIÑÓN MARCHA AVANTE | POSITIVE GEAR ASSY | PIGNONE MARCIA AVANTI | PIGNON DE MARCHÉ AVANT |
| 16 | REC663-45633-00 | 663-45633-00 | ANILLO DE PASADOR | RING, CROSS PIN | O-RING | JOINT TORIQUE |
| 17 | REC90250-06023 | 90250-06023 | PASADOR CILÍNDRICO | PIN, STRAIGHT | SPINOTTO | PIN |
| 18 | REC663-45631-00 | 663-45631-01 | EMBRAGUE DE GARRA | CLUTCH DOG | GIUNTO A DENTI FRONTALI | CRABOT |
| 19 | REC676-45635-00 | 676-45635-00 | ÉMBOLO DE CAMBIO | PLUNGER SHIFT | CAMBIO PISTONE | PISTON |
| 20 | REC663-45634-00 | 663-45634-00 | DESILIZADOR, CAMBIO | SLIDE SHIFT | SCORREVOLE | DOUILLE |
| 21 | REC6F6-45611-00 | 6F6-45611-00 | EJE PROPULSOR | SHAFT PROPELLER | ASSE GIRANTE | ARBRE D'HELICE |
| 22 | REC6F5-45570-00 | 6F5-45570-00 | ENGRANAJE COMPL. 2. | GEAR | INGRANAGGIO | PIGNON |
| 23 | REC93306-204Y7 | 93306-20401 | COJINETE (B6204) | BEARING | CUSCINETTO | ROULEMENT |
| 24 | REC93101-20048 | 93101-20048 | SELLO ACEITE | OIL SEAL | PARAOLIO | JOINT SPI |
| 25 | REC676-45361-00 | 676-45361-01-94 | FUNDA INFERIOR | CAP LOWER CASING | COPERCHIO INFERIORE | DIABOLO |
| 26 | REC93210-57M00 | 93210-57M00 | ARO TÓRICO | O-RING | O-RING | JOINT TORIQUE |
| 27 | REC650-44147-00 | 650-44147-00 | HULE DE VARILLA | BOOT, SHIFT ROD | AVVIO, BARRA DI SPOSTAMENTO | GUIDE |
| 28 | PAGB/T5783-M6X10 | 97095-06010 | PERNO | BOLT | VITE | VIS |
| 29 | REC93315-217U0 | 93315-217U0 | COJINETE DE RODILLOS | BEARING | CUSCINETTO | ROULEMENT |
| 30 | REC676-45533-00 | 676-45533-00 | ARANDELA DE EMPUJE AXIAL | WASHER | RONDELLA | RONDELLE |
| 31 | REC676-45501-10 | 676-45501-10 | EJE DE MANDO COMPL. | DRIVE SHAFT | ASSE VERTICALE | ARBRE VERTICAL |
| 32 | REC90280-04M00 | 90280-04M00 | CUNA WOODRUFF | KEY WOODRUFF | CHIAVE WOODRUFF | CLAVETTE |
| 33 | REC93101-22M00 | 93101-22M00 | SELLO ACEITE | OIL SEAL | PARAOLIO | JOINT SPI |
| 34 | REC676-44316-A1 | 676-44316-A1 | EMPAQUE | GASKET | GUARNIZIONE | JOINT |
| 35 | PAF25-04000007 | 93604-08062 | PASADOR DE CLAVIJA | PIN, DOWEL | SPINOTTO | CLAVETTE |
| 36 | REC676-44341-00 | 676-44341-94 | CAJA BOMBA DE AGUA | HOUSING WATER PUMP | ALLOGGIAMENTO POMPA ACQUA | BASE DE POMPE À EAU |
| 37 | REC676-44324-A0 | 676-44324-A1 | EMPAQUE | GASKET | GUARNIZIONE | JOINT |
| 38 | REC676-44323-00-40 | 676-44323-40 | PLACA EXTERIOR DEL CARTUCHO | PLATE | PIASTRA | PLAQUE DE POMPE À EAU |
| 39 | REC676-44315-00 | 676-44315-A1 | EMPAQUE | GASKET | GUARNIZIONE | JOINT |
| 40 | REC6F5-44352-00 | 6F5-44352-00 | IMPULSOR | IMPELLER | GIRANTE | TURBINE |
| 41 | REC663-44366-00 | 663-44366-00 | GOMA DEL SELLO DE AGUA | DAMPER WATER SEAL | BOCCOLA GOMMA ACQUA | BAGUE |
| 42 | REC676-44311-00 | 676-44311-00 | CAJA BOMBA AGUA | HOUSING WATER PUMP | ALLOGGIAMENTO POMPA ACQUA | CORPS DE POMPE À EAU |
| 43 | PAGB/T97.1-8 | 92995-08600 | ARANDELA | WASHER | RONDELLA | RONDELLE |
| 44 | REC97095-08055 | 97095-08055 | PERNO | BOLT | VITE | VIS |
| 45 | REC97095-08045 | 97095-08045 | PERNO | BOLT | VITE | VIS |



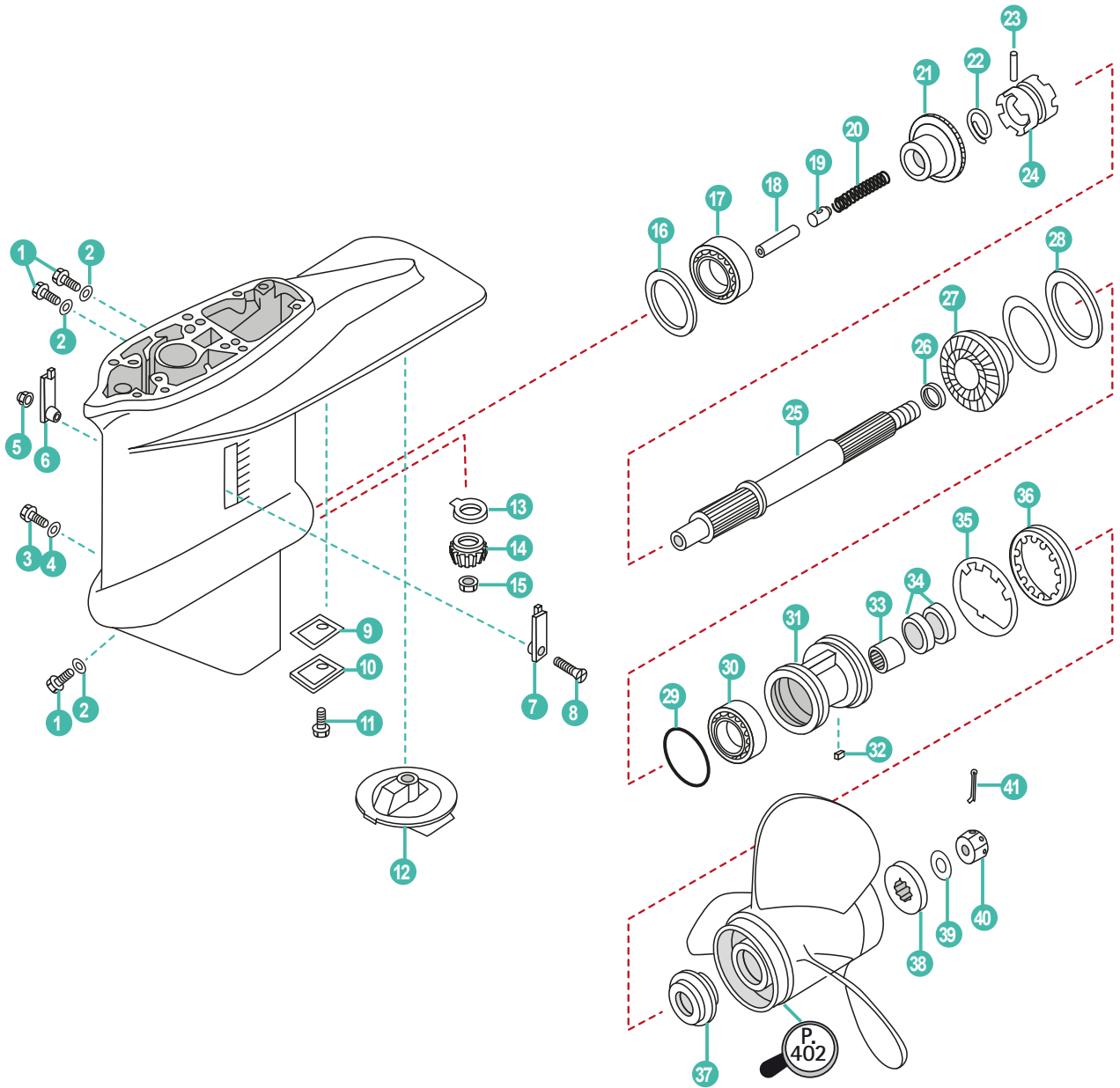

| | REF | OEM | | | | |
|----|------------------|-----------------|-----------------------|------------------------|--------------------------|------------------------|
| 1 | REC90340-08002 | 90340-08M14 | TORNILLO NIVEL ACEITE | VENT PLUG | VITE LIVELLO OLIO | BOUCHON DE VIDANGE |
| 2 | REC90430-08020 | 90430-08020 | ARANDELA | WASHER | RONDELLA | RONDELLE |
| 3 | REC90149-06M00 | 90149-06M00 | TORNILLO DRENAJE | DRAIN SCREW | VITE DRENAGGIO | BOUCHON DE VIDANGE |
| 4 | REC90430-06M03 | 90430-06M03 | JUNTA | GASKET | GUARNIZIONE | JOINT |
| 5 | PAGB/T889.1-M5 | | TUERCA | NUT | DADO | ÉCROU |
| 6 | REC688-45215-02 | 688-45215-02 | TAPA ENTRADA DE AGUA | WATER SCREEN | COPERCHIO RAFFREDDAMENTO | GRILLE D'ENTREE D'EAU |
| 7 | REC688-45214-02 | 688-45214-02 | TAPA ENTRADA DE AGUA | WATER SCREEN | COPERCHIO RAFFREDDAMENTO | GRILLE D'ENTREE D'EAU |
| 8 | PAGB/T820-M5X30 | | TORNILLO | SCREW | VITE | VIS |
| 9 | REC679-45315-A1 | 679-45315-A1 | JUNTA | GASKET | GUARNIZIONE | JOINT |
| 10 | REC679-45321-02 | 679-45321-02 | PLACA | PLATE | PIASTRA | PLAQUE |
| 11 | PAGB/T818-M6X16 | 98580-06016 | TORNILLO | SCREW | VITE | VIS |
| 12 | TEN01101 | 679-45371-00 | ÁNODO | ANODE | ANODO | ANODE |
| 13 | REC663-45552-00 | 663-45552-00 | COJINETE PLANO | BEARING | CUSCINETTO | ROULEMENT |
| 14 | REC6H9-45551-00 | 6H9-45551-00 | PIÑÓN ATAQUE | INITIATIVE GEAR | MARCIA INIZIATIVA | PIGNON D'ATTAQUE |
| 15 | REC90170-12138 | 90170-012138 | TUERCA | NUT | DADO | ÉCROU |
| | PAT40-04000004-1 | 663-45567-01-10 | GRUESO (0.10mm) | SHIM (0.10mm) | SPESSORE (0.10mm) | CALE (0.10mm) |
| 16 | PAT40-04000004-2 | 663-45567-01-12 | GRUESO (0.12mm) | SHIM (0.12mm) | SPESSORE (0.12mm) | CALE (0.12mm) |
| | PAT40-04000004-3 | 663-45567-01-15 | GRUESO (0.15mm) | SHIM (0.15mm) | SPESSORE (0.15mm) | CALE (0.15mm) |
| | PAT40-04000004-5 | 663-45567-01-30 | GRUESO (0.30mm) | SHIM (0.30mm) | SPESSORE (0.30mm) | CALE (0.30mm) |
| 17 | REC93332-00003 | 93332-00003 | COJINETE | BEARING | CUSCINETTO | ROULEMENT |
| 18 | REC676-45635-00 | 676-45635-00 | ÉMBOLO DE CAMBIO | PIVOT | PERNO | PIVOT |
| 19 | REC663-45634-00 | 663-45634-00 | DESILIZADOR DE CAMBIO | CLUTCH DOG | TRAINABILE CAMBIO | PISTON |
| 20 | REC90501-16M01 | 90501-16M01 | RESORTE DE COMPRESIÓN | SPRING | MOLLA | RESSORT |
| 21 | REC679-45560-00 | 679-45560-00 | PIÑÓN MARCHA AVANTE | POSITIVE GEAR ASSY | PIGNONE MARCIA AVANTI | PIGNON DE MARCHE AVANT |
| 22 | REC663-45633-00 | 663-45633-00 | ANILLO DEL PASADOR | ANNULAR SPRING, CLUTCH | ANELLO | RESSORT |
| 23 | REC90250-06023 | 90250-06023 | PASADOR | PIN | FERMO | GOUPILLE |
| 24 | REC663-45631-00 | 663-45631-01 | EMBRAGUE DE GARRA | CLUCH DOG | SELETTORE | CRABOT |
| 25 | REC679-45611-00 | 679-45611-01 | EJE PROPULSOR | PROPELLER SHAFT | ASSE ELICA | ARBRE D'HELICE |
| 26 | REC90201-22429 | 90201-22429 | ARANDELA PLANA | WASHER | RONDELLA | RONDELLE |
| 27 | REC679-45571-00 | 679-45571-00 | PIÑÓN MARCHA ATRÁS | REVERSE GEAR | PIGNONE MARCIA INDIETRO | PIGNON MARCHE ARRIÈRE |
| 28 | REC663-45576-00 | 663-45576-00 | ARANDELA DE EMPUJE | PUSH WASHER | RONDELLA DI SPINTA | RONDELLE D'APPUI |
| 29 | REC93210-66M98 | 93210-66M98 | O-RING | O-RING | O-RING | JOINT TORIQUE |
| 30 | REC93306-00702 | 93306-00702 | COJINETE | BEARING | CUSCINETTO | ROULEMENT |
| 31 | REC679-45331-00 | 679-45331-00-94 | DIABOLO | DIABOLO | DIABOLO | DIABOLO |
| 32 | REC90282-04010 | 90282-04010 | CHAVETA | KEY | CHIAVETTE | CLAVETTE |
| 33 | REC93317-22204 | 93317-22204 | COJINETE | BEARING | CUSCINETTO | ROULEMENT |
| 34 | REC93101-22067 | 93101-22067 | RETÉN DE ACEITE | SEAL OIL | PAROLIO | JOINT SPI |
| 35 | REC90214-48M03 | 90214-48M03 | ARANDELA | WASHER | RONDELLA | RONDELLE |
| 36 | REC697-45384-00 | 697-45384-00 | TUERCA | NUT | DADO | ÉCROU |
| 37 | REC663-45987-00 | 663-45987-00 | ESPACIADOR | DISTANCE WASHER | DISTANZIALE | ENTRETOISE |
| 38 | REC66T-45997-00 | 66T-45997-00 | ESPACIADOR | DISTANCE WASHER | DISTANZIALE | ENTRETOISE |
| 39 | REC90389-22M01 | 90389-22M01 | ARANDELA | WASHER | RONDELLA | RONDELLE |
| 40 | REC90171-16011 | 90171-16011 | TUERCA | NUT | DADO | ÉCROU D'HELICE |
| 41 | REC91490-30025 | 91490-30025 | CLIP | CLIP | CLIP | GOUPILLE |

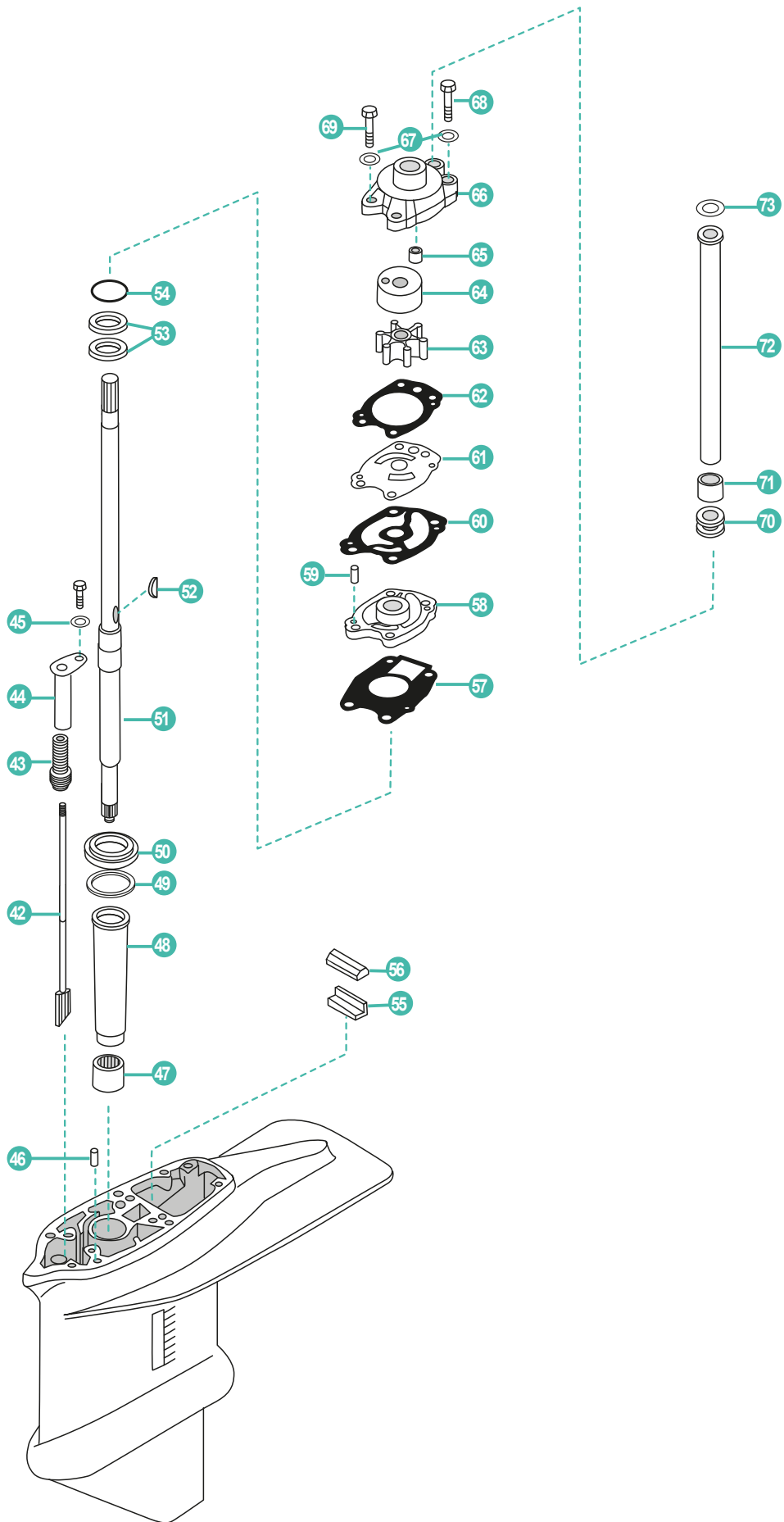

| | REF | OEM | | | | |
|----|--------------------|-----------------|-----------------------------|---------------------------|---------------------------|-----------------------|
| 42 | REC679-44150-10 | 679-44150-10 | EJE SELECTOR L | SHAFT SELECTOR L | ASSE SELETTORE L | ARBRE SELECTEUR L |
| | REC679-44150-00 | 679-44150-00 | EJE SELECTOR S | SHAFT SELECTOR S | ASSE SELETTORE S | ARBRE SELECTEUR S |
| 43 | REC650-44147-00 | 650-44147-00 | FUELLE EJE | BOOT, SHIFT ROD | BOOT, SHIFT ROD | SOUFFLET |
| 44 | REC679-44152-00 | 679-44152-00 | BUJE LEVE DE CAMBIO | HUBE GEAR LEVE | MOZZO LEVA CAMBIO | LEVIER DE VITESSE |
| 45 | PAGB/T97.1-6 | 92990-06600 | ARANDELA PLANA | WASHER | RONDELLA | RONDELLE |
| 46 | REC93606-12019 | 93606-12019 | PIN CENTRADOR | PIN DOWEL | SPINOTTO DI CENTRAGGIO | CLAVETTE DE CENTRAGE |
| 47 | REC93315-32224 | 93315-32224 | COJINETE | BEARING | CUSCINETTO | ROULEMENT |
| 48 | REC679-45536-00 | 679-45536-00 | CAMISA EJE TRASMISION | BUSHING NYLON | CAMICIA ASSE TRASMISSIONE | AXE TRANSMISSION |
| | PAT40-04000003-1 | 663-45587-01-10 | GRUESO (0.10mm) | SHIM (0.10mm) | SPESSORE (0.10mm) | CALE (0.10mm) |
| | PAT40-04000003-2 | 663-45587-01-12 | GRUESO (0.12mm) | SHIM (0.12mm) | SPESSORE (0.12mm) | CALE (0.12mm) |
| | PAT40-04000003-3 | 663-45587-01-15 | GRUESO (0.15mm) | SHIM (0.15mm) | SPESSORE (0.15mm) | CALE (0.15mm) |
| 49 | PAT40-04000003-4 | 663-45587-01-18 | GRUESO (0.18mm) | SHIM (0.18mm) | SPESSORE (0.18mm) | CALE (0.18mm) |
| | PAT40-04000003-5 | 663-45587-01-30 | GRUESO (0.30mm) | SHIM (0.30mm) | SPESSORE (0.30mm) | CALE (0.30mm) |
| | PAT40-04000003-6 | 663-45587-01-40 | GRUESO (0.40mm) | SHIM (0.40mm) | SPESSORE (0.40mm) | CALE (0.40mm) |
| | PAT40-04000003-7 | 663-45587-01-50 | GRUESO (0.50mm) | SHIM (0.50mm) | SPESSORE (0.50mm) | CALE (0.50mm) |
| 50 | PAT40-04000027 | 93332-00079 | COJINETE | BEARING | CUSCINETTO | ROULEMENT |
| 51 | REC679-45501-10 | 679-45501-10 | EJE L | SHAFT L | ASSE L | ARBRE L |
| 52 | REC90280-04M00 | 90280-04M00 | CHAVETA | KEY | CHIAVETTA | CLAVETTE |
| 53 | REC93101-22067 | 93101-22067 | RETÉN DE ACEITE | SEAL OIL | PARAOILIO | JOINT SPI |
| 54 | REC93210-41042 | 93210-41042 | TÓRICA | O-RING | O-RING | JOINT TORIQUE |
| 55 | REC663-45376-00 | 663-45376-00 | GUIA RETEN | GUIDE RUB. SEAL | GUIDA PARAOILIO | GUIDE |
| 56 | REC663-45375-00 | 663-45375-00 | GOMA SELLADORA | SEALING RUBBER | ANELLO SIGILLANTE | JOINT CAOUTCHOUC |
| 57 | REC679-44316-A0 | 679-44316-A0 | JUNTA | GASKET | GUARNIZIONE | JOINT |
| 58 | REC679-44341-00 | 679-44341-00-94 | CAJA BOMBA DE AGUA | WATER PUMP HOUSING | SCATOLA POMPA ACQUA | BASE DE POMPE À EAU |
| 59 | PAF25-04000007 | 93604-08062 | PASADOR | PIN | FERMO | GOUPILLE |
| 60 | REC676-44324-A0 | 676-44324-A0 | JUNTA | GASKET | GUARNIZIONE | JOINT |
| 61 | REC676-44323-00-40 | 676-44323-00 | PLACA EXTERIOR DEL CARTUCHO | OUTER PLATE | PLACCA ESTERNA | PLAQUE DE POMPE À EAU |
| 62 | REC676-44315-00 | 676-44315-A0 | JUNTA | GASKET | GUARNIZIONE | JOINT |
| 63 | REC6F5-44352-00 | 6F5-44352-002 | IMPULSOR | IMPELLER | GIRANTE | TURBINE |
| 64 | REC676-44322-00 | 676-44322-00 | CASQUILLO INOX | CARTRIDGE INSERT | BOCCOLA | INSERT DE POMPE À EAU |
| 65 | REC663-44366-00 | 663-44366-00 | RETEN TUBO AGUA | DAMPER, WATER SEAL | GHIERA | JOINT DE TUBE D'EAU |
| 66 | REC676-44311-00 | 676-44311-00 | CAJA BOMBA DE AGUA | WATER PUMP HOUSING | SCATOLA POMPA ACQUA | CORPS DE POMPE À EAU |
| 67 | PAGB/T97.1-8 | 92990-08600 | ARANDELA PLANA | WASHER | RONDELLA | RONDELLE |
| 68 | REC97095-08055 | 97095-08055 | PERNO | BOLT | BOULONE | BOULON |
| 69 | REC97095-08045 | 97095-08045 | PERNO | BOLT | BOULONE | BOULON |
| 70 | PAT40-02000002 | 663-44367-00 | GOMA DEL SELLO DE AGUA | GUIDE BUSHING, WATER PIPE | GUARNIZIONE | GUIDE DE PIPE D'EAU |
| 71 | REC90430-12072 | 90430-12072 | JUNTA | GASKET | GUARNIZIONE | JOINT |
| 72 | REC676-44361-00 | 676-44361-00 | TUBO S | TUBE S | TUBO S | TUBE S |
| | REC676-44361-10 | 676-44361-10 | TUBO L | TUBE L | TUBO L | TUBE L |
| 73 | PAF25-02000019 | 90202-12060 | GOMA DEL SELLO DE AGUA | GUIDE BUSHING, WATER PIPE | GUARNIZIONE | GUIDE DE PIPE D'EAU |



REF
 REC80W90U3
 REC80W90U6
 RECGREU1
 RECGREU12

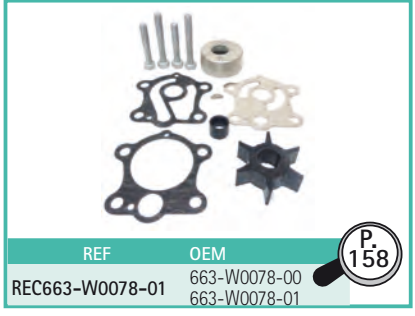
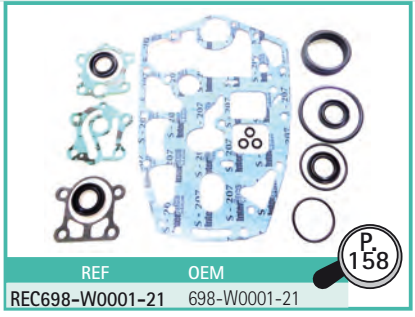
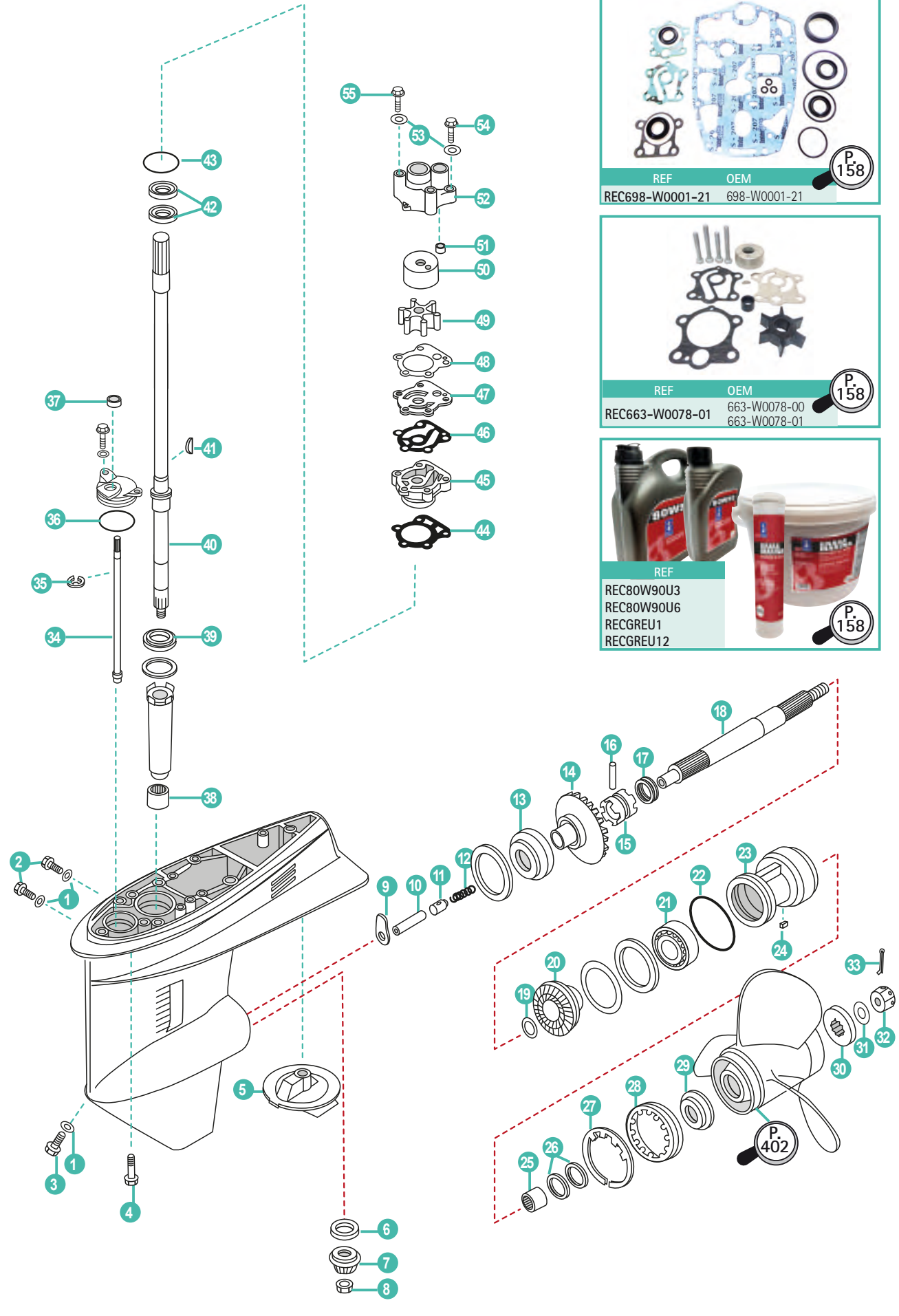

| | REF | OEM | | | | |
|----|--------------------|-----------------|-----------------------|---------------------|-------------------------|------------------------|
| 1 | REC90430-08020 | 90430-08020 | JUNTA | GASKET | GUARNIZIONE | JOINT |
| 2 | REC90340-08002 | 90340-08002 | TORNILLO | STRAIGHT SCREW | VITE | VIS |
| 3 | REC688-45341-00 | 688-45341-10 | TAPÓN, DREN | PLUG, DRAIN | TAPPO | BOUCHON DE VIDANGE |
| 4 | REC97075-10040 | 97075-10040 | PERNO | BOLT | PERNO | BOULON |
| 5 | TEN01101 | 679-45371-00 | ÁNODO | ANODE | ANODO | ANODE |
| 6 | REC663-45552-00 | 663-45552-00 | COJINETE PLANO | BEARING, PLAIN | CUSCINETTO PIATO | ROULEMENT |
| 7 | REC697-45551-00 | 697-45551-00 | PIÑÓN ATAQUE | INITIATIVE GEAR | MARCIA INIZIATIVA | PIGNON D'ATTAQUE |
| 8 | REC90170-12138 | 90170-12138 | TUERCA | NUT | DADO | ÉCROU |
| 9 | REC663-44151-00 | 663-44151-00 | LEVA DE CAMBIO | CAM SHIFT | ALBERO | CAME |
| 10 | REC688-45635-00 | 688-45635-00 | PLUNGER, SHIFT | ÉMBOLO DE CAMBIO | CAMBIO PISTONE | PISTON |
| 11 | REC663-45634-00 | 663-45634-00 | DESILIZADOR CAMBIO | SLIDE, SHIFT | SCORREVOLE | DOUILLE |
| 12 | REC90501-16233 | 90501-16233 | RESORTE DE COMPRESIÓN | SPRING | MOLLA | RESSORT |
| 13 | REC93332-00003 | 93332-00003 | COJINETE | BEARING | CUSCINETTO | ROULEMENT |
| 14 | REC697-45560-00 | 697-45560-00 | PIÑÓN MARCHA AVANTE | POSITIVE GEAR ASSY | PIGNONE MARCIA AVANTI | PIGNON DE MARCHE AVANT |
| 15 | REC663-45631-00 | 663-45631-01 | EMBRAGUE DE GARRA | CLUTCH, DOG | GIUNTO A DENTI FRONTALE | CRABOT |
| 16 | REC90250-06023 | 90250-06023 | PASADOR CILÍNDRICO | PIN, STRAIGHT | SPINOTTO | PIN |
| 17 | REC663-45633-00 | 663-45633-00 | ANILLO DE PASADOR | RING, CROSS PIN | O-RING | JOINT TORIQUE |
| 18 | REC697-45611-00 | 697-45611-00 | EJE PROPULSOR | SHAFT PROPELLER | ASSE | ARBRE D'HELICE |
| 19 | REC90201-22429 | 90201-22429 | ARANDELA PLANA | WASHER, PLATE | RONDELLA | RONDELLE |
| 20 | REC697-45570-00 | 697-45571-00 | PIÑÓN MARCHA ATRÁS | REVERSE GEAR | PIGNONE MARCIA INDIETRO | PIGNON MARCHE ARRIÈRE |
| 21 | REC93306-00702 | 93306-00702 | COJINETE | BEARING | CUSCINETTO | ROULEMENT |
| 22 | REC93210-66M98 | 93210-66M98 | ANILLO O | O- RING | O-RING | JOINT TORIQUE |
| 23 | REC663-45331-00-94 | 663-45331-00-94 | CAJA DE COJINETE | HOUSING, BEARING | SEDE CUSCINETTO | DIABOLO |
| 24 | REC90282-04010 | 90282-04010 | CHAVETA | KEY, STRAIGHT | CHIAVETTA | CLAVETTE |
| 25 | REC93317-22204 | 93317-22204 | COJINETE | BEARING | CUSCINETTO | ROULEMENT |
| 26 | REC93101-22067 | 93101-22067 | SELLO ACEITE | OIL SEAL | PARAOLIO | JOINT SPI |
| 27 | REC90214-48M03 | 90214-48M03 | ARANDELA | WASHER | RONDELLA | RONDELLE |
| 28 | REC697-45384-00 | 697-45384-00 | TUERCA | NUT | DADO | ÉCROU |
| 29 | REC663-45987-00 | 663-45987-02 | ESPACIADOR | SPACER | DISTANZIALE | ENTRETOISE |
| 30 | REC670-45997-00 | 670-45997-02 | ESPACIADOR | SPACER | DISTANZIALE | ENTRETOISE |
| 31 | REC92990-16200 | 92990-16200 | ARANDELA PLANA | WASHER, PLAIN | RONDELLA | RONDELLE |
| 32 | REC90171-16011 | 90171-16011 | TUERCA ENTALLADA | NUT, CASTLE | DADO | ÉCROU D'HELICE |
| 33 | REC91490-40030 | 91490-40025 | CHAVETA | PIN, COTTER | CHIAVETTA | GOUPILLE |
| 34 | REC663-44144-01 | 663-44144-01 | VARILLA DE CAMBIO | ROD, SHIFT | ASTICELLA | LEVIER DE VITESSE |
| 35 | REC99001-08600-00 | 99001-08600 | CLIP | CLIP | CLIP | CLAVETTE |
| 36 | REC93210-49046 | 93210-49046 | ANILLO | O-RING | O-RING | JOINT TORIQUE |
| 37 | REC93106-09014 | 93106-09014 | RETÉN DE ACEITE | OIL SEAL | PARAOLIO | JOINT SPI |
| 38 | REC93315-32224 | 93315-32224 | COJINETE DE RODILLOS | BEARING | CUSCINETTO | ROULEMENT |
| 39 | REC93332-00001 | 93332-00001 | COJINETE | BEARING | CUSCINETTO | ROULEMENT |
| 40 | REC663-45510-01 | 663-45510-01 | EJE DE MANDO | DRIVE SHAFT ASSY | ASSE VERTICALE | ARBRE VERTICAL |
| 41 | REC90280-03M03 | 90280-03M03 | CHAVETA | KEY, WOODRUFF | CHIAVE | CLAVETTE |
| 42 | REC93101-23070 | 93101-23070 | SELLO ACEITE | OIL SEAL | PARAOLIO | JOINT SPI |
| 43 | REC93210-41042 | 93210-41042 | ANILLO O | O-RING | O-RING | JOINT TORIQUE |
| 44 | REC663-44316-A0 | 663-44316-A0 | EMPAQUE | GASKET, WATER PUMP | GUARNIZIONE | JOINT DE POMPE À EAU |
| 45 | REC663-44311-02 | 663-44341-00 | CAJA BOMBA | HOUSING, WATER PUMP | CORPO POMPA | BASE DE POMPE À EAU |
| 46 | REC663-44324-00 | 663-44324-A0 | EMPAQUE | GASKET, CARTRIDGE | GUARNIZIONE | JOINT |
| 47 | REC663-44323-00 | 663-44323-00 | PLACA EXTERIOR | OUTTER PLATE | PIASTRA EXT. | PLAQUE DE POMPE À EAU |
| 48 | REC663-44315-A0 | 663-44315-A0 | EMAPAQUE | GASKET, WATER PUMP | GUARNIZIONE | JOINT |
| 49 | REC6H3-44352-00 | 697-44352-00 | IMPULSOR | IMPELLER | GIRANTE | TURBINE |
| 50 | REC663-44322-00 | 663-44322-00 | CARTUCHO | INSERT CARTRIDGE | CARTUCCIA | INSERT DE POMPE À EAU |
| 51 | REC663-44366-00 | 663-44366-00 | GOMA SELLO | DAMPER, WATER SEAL | BOCCOLA GOMMA | BAGUE |
| 52 | REC663-44311-02 | 663-44311-02 | CAJA BOMBA | HOUSING, WATER PUMP | CORPO POMPA | CORPS DE POMPE À EAU |
| 53 | PAGB/T97.1-8 | 92995-08600 | ARANDELA | WASHER | RONDELLA | RONDELLE |
| 54 | REC97095-08045 | 97095-08045 | PERNO | BOLT | VITE | VIS |
| 55 | REC97095-08055 | 97095-08055 | PERNO | BOLT | VITE | VIS |

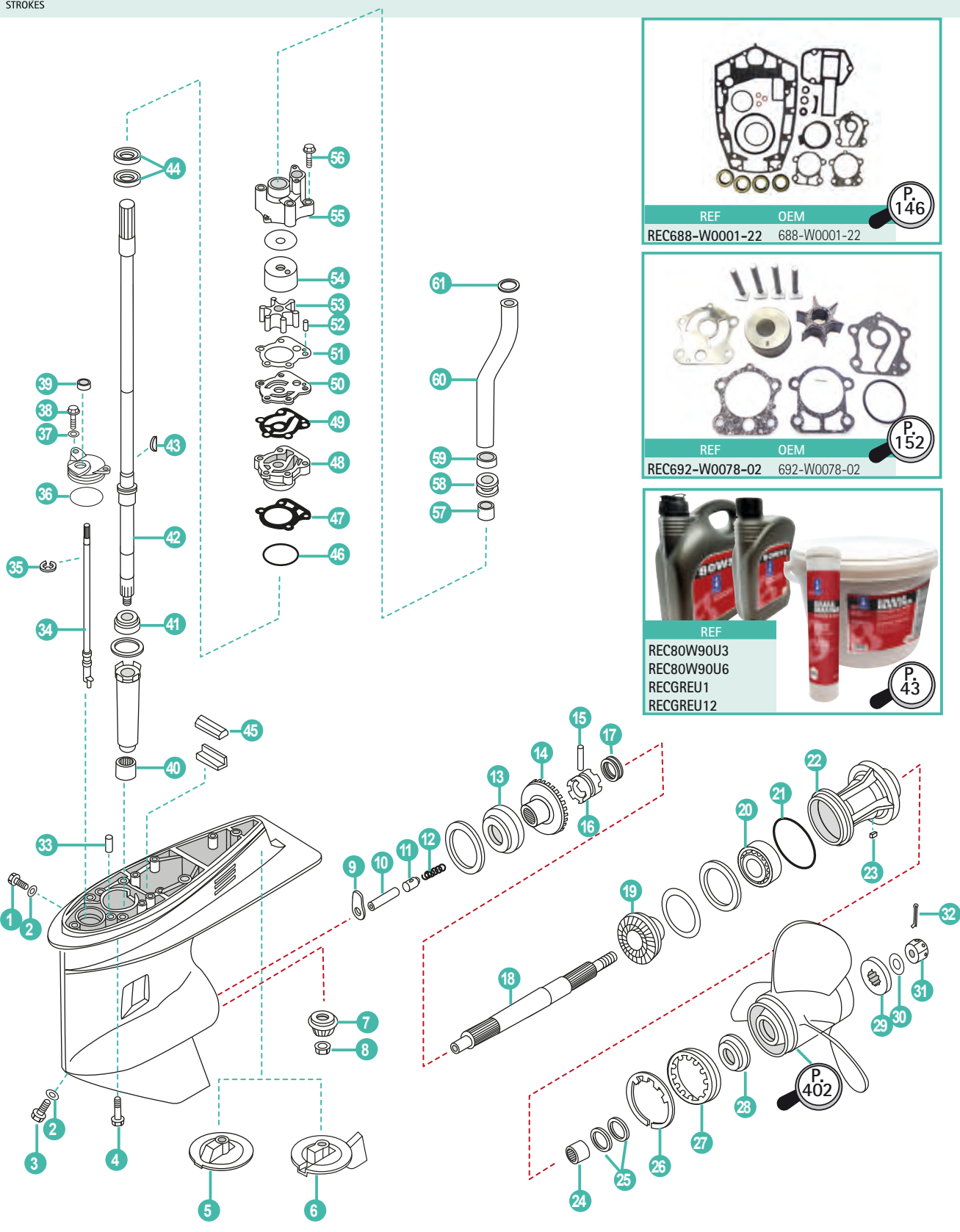

| | REF | OEM | | | | |
|---|--------------------|-----------------|-----------------|---------------------|------------------|--------------------|
| | REC692-45300-16-8D | 692-45300-14-4D | COLA COMPLETA L | LOWER UNIT ASSY L | PIEDE COMPLETO L | EMBASE COMPLETE L |
| 1 | REC90340-08002 | 90340-08002 | TAPÓN | PLUG STRAIGHT SCREW | TAPPO | BOUCHON DE VIDANGE |
| 2 | REC90430-08020 | 90430-08020 | JUNTA | GASKET | GUARNIZIONE | JOINT |
| 3 | REC688-45341-00 | 688-45341-10 | TAPÓN | PLUG DRAIN | TAPPO | BOUCHON DE VIDANGE |
| 4 | REC97075-10040 | 97075-10040 | TORNILLO | BOLT WITH WASHER | VITE | VIS |
| 5 | TEN01153 | 6E5-45371-10 | ÁNODO TIMÓN | TAB-TRIM | ANODO | ANODE |

| | REF | OEM | | | | |
|----|--------------------|-----------------|------------------------|---------------------------|-------------------------|------------------------|
| 6 | CM688-45371-02 | 688-45371-02 | ÁNODO TIMÓN STD. | TAB-TRIM STD | ANODO STD | ANODE |
| 7 | REC688-45551-00 | 688-45551-01 | PIÑÓN ATAQUE | INITIATIVE GEAR | MARCIA INIZIATIVA | PIGNON D'ATTAQUE |
| 8 | REC90170-16M01 | 90170-16M01 | TUERCA | NUT | DADO | ECROU |
| 9 | REC663-44151-00 | 663-44151-00 | LEVA | CAM, SHIFT | LEVA | CAME |
| 10 | REC688-45635-00 | 688-45635-00 | BULÓN | PLUNGER, SHIFT | BULLONE | BOULON |
| 11 | REC688-45634-00 | 688-45634-00 | EMPUJADOR | SLIDE, SHIFT | SCORREVOLE | DOUILLE |
| 12 | REC90501-16233 | 90501-16233 | MUELLE | SPRING, COMPRESSION | MOLLA | RESSORT |
| 13 | REC93332-000W7 | 93332-000W7 | RODAMIENTO | BEARING | CUSCINETTO | ROULEMENT |
| 14 | REC688-45560-00 | 688-45560-00 | PIÑÓN MARCHA AVANTE | POSITIVE GEAR ASSY | PIGNONE MARCIA AVANTI | PIGNON DE MARCHÉ AVANT |
| 15 | REC90250-07M02 | 90250-07M02 | PASADOR | PIN, STRAIGHT | SPINOTTO | PIN |
| 16 | REC688-45631-00 | 688-45631-01 | DESPLAZABLE | CLUTCH, DOG | GIUNTO A DENTI FRONTALE | CRABOT |
| 17 | REC688-45633-00 | 688-45633-00 | ARO METÁLICO | RING, CROSS PIN | O-RING | JOINT TORIQUE |
| 18 | REC688-45611-00 | 688-45611-00 | EJE HÉLICE | SHAFT, PROPELLER | ASSE ELICA | ARBRE D'HELICE |
| 19 | REC688-45570-00 | 688-45571-01 | PIÑÓN MARCHA ATRÁS | REVERSE GEAR | PIGNONE MARCIA INDIETRO | PIGNON MARCHÉ ARRIÈRE |
| 20 | REC93306-207U0 | 93306-207U0 | RODAMIENTO | BEARING | CUSCINETTO | ROULEMENT |
| 21 | REC93210-85M97 | 93210-85M97 | ARO TÓRICO | O-RING | O-RING | JOINT TORIQUE |
| 22 | REC688-45331-00-94 | 688-45331-00-94 | DIÁBOLO | HOUSING, BEARING | COP. CASSA INGRANAGGI | DIABOLO |
| 23 | REC90282-04010 | 90282-04010 | CHAVETA | KEY, STRAIGHT | CHIAVETTA | CLAVETTE |
| 24 | REC93317-325U0 | 93317-325U0 | RODAMIENTO | BEARING | CUSCINETTO | ROULEMENT |
| 25 | REC93101-25M03 | 93101-25M03 | RETÉN | OIL SEAL | PARAOLIO | JOINT SPI |
| 26 | REC688-45383-01 | 688-45383-02 | ARANDELA CIERRE | WASHER, CLAW | RONDELLA CHIUSURA | RONDELLE |
| 27 | REC688-45384-00 | 688-45384-00 | TUERCA | NUT | DADO | ECROU |
| 28 | REC688-45987-00 | 688-45987-01 | SEPARADOR | SPACER | DISTANZIALE | ENTRETOISE |
| 29 | REC67F-45997-00 | 67F-45997-00 | SEPARADOR | SPACER | DISTANZIALE | ENTRETOISE |
| 30 | REC90389-25M00 | 90389-25M00 | CASQUILLO | BUSH | BOCCOLA | RONDELLE |
| 31 | REC90171-16011 | 90171-16011 | TUERCA | NUT, CASTLE | DADO | ECROU D'HELICE |
| 32 | REC91490-40030 | 91490-40025 | PASADOR ALETAS | PIN, COTTER | SPINOTTO | GOUPILLE |
| 33 | REC93606-12019 | 93606-12019 | PASADOR | PIN, DOWEL | SPINOTTO | PIN |
| 34 | REC663-44144-01 | 663-44144-01 | EJE SELECTOR | ROD, SHIFT | ASSE SELETTORE | ARBRE DE VITESSE |
| 35 | REC99001-08600-00 | 99001-08600 | CERCLIP | CIRCLIP | CIRCLIP | CIRCLIP |
| 36 | REC93210-49046 | 93210-49046 | ARO TÓRICO | O-RING | O-RING | JOINT TORIQUE |
| 37 | PAGB/T5783-M6X16 | 92995-06600 | ARANDELA | WASHER | RONDELLA | RONDELLE |
| 38 | PAGB/T97.1-6 | 97095-06016 | TORNILLO | BOLT | VITE | VIS |
| 39 | REC93106-09014 | 93106-09014 | RETÉN | OIL SEAL | PARAOLIO | JOINT SPI |
| 40 | REC93315-325V1 | 93315-325V1 | RODAMIENTO | BEARING | CUSCINETTO | ROULEMENT |
| 41 | REC93332-000U3 | 93332-000U3 | RODAMIENTO | BEARING | CUSCINETTO | ROULEMENT |
| 42 | REC688-45501-11 | 688-45501-11 | EJE VERTICAL | DRIVE SHAFT COMP. | ASSE VERTICALE | ARBRE VERTICAL |
| 43 | REC90280-04M04 | 90280-04M04 | CHAVETA | KEY, WOODRUFF | CHIAVETTA | CLAVETTE |
| 44 | REC93101-25M03 | 93101-25M03 | RETÉN | OIL SEAL | PARAOLIO | JOINT SPI |
| 45 | REC688-45375-00 | 688-45375-00 | RETÉN DAMPER | DAMPER WASHER | PARAOLIO DAMPER | JOINT SILENT BLOC |
| 46 | REC93210-46044 | 93210-46044 | ARO TÓRICO | O-RING | O-RING | JOINT TORIQUE |
| 47 | REC688-44316-00 | 688-44316-A0 | JUNTA | GASKET WATER PUMP | GUARNIZIONE | JOINT DE POMPE À EAU |
| 48 | REC688-44341-01 | 688-44341-01-94 | TAPA INF. BOMBA AGUA | HOUSING, WATER PUMP | CORPO INF. POMPA ACQUA | BASE DE POMPE À EAU |
| 49 | REC688-44324-00 | 688-44324-A0 | JUNTA | GASKET, CARTRIDGE | GUARNIZIONE | JOINT |
| 50 | REC688-44323-00 | 688-44323-40 | PLATO | OUTTER PLATE, CARTRIDGE | PIASTRA | PLAQUE DE POMPE À EAU |
| 51 | REC688-44315-00 | 688-44315-A0 | JUNTA | GASKET, WATER PUMP | GUARNIZIONE | JOINT |
| 52 | PAF25-04000007 | 93604-10M03 | CENTRADOR | PIN, DOWEL | SPINOTTO | PIN |
| 53 | REC688-44352-03 | 688-44352-03 | TURBINA | IMPELLER | GIRANTE | TURBINE |
| 54 | REC688-44322-00 | 688-44322-00 | CASQUILLO INOX. | INSERT, CARTRIDGE | BOCCOLA INOX. | INSERT DE POMPE À EAU |
| 55 | REC688-44311-01 | 688-44311-01 | CUERPO BOMBA AGUA | HOUSING, WATER PUMP | CORPO POMPA ACQUA | CORPS DE POMPE À EAU |
| 56 | REC90119-08M13 | 90119-08M13 | TORNILLO | BOLT WITH WASHER | VITE | VIS |
| 57 | REC663-44366-00 | 663-44366-00 | CASQUILLO GOMA | DAMPER, WATER SEAL | BOCCOLA GOMMA | BAGUE |
| 58 | PAT40-02000002 | 663-44367-00 | GOMA DEL SELLO DE AGUA | GUIDE BUSHING, WATER PIPE | GU | GUIDE DE PIPE D'EAU |
| 59 | REC90430-12072 | 90430-12072 | JUNTA | GASKET | GUARNIZIONE | JOINT |
| 60 | REC688-44361-10 | 688-44361-10 | TUBO DE AGUA L | WATER TUBE L | TUBO ACQUA L | TUBE D'EAU L |
| 61 | PAF25-02000019 | 90202-12060 | ARANDELA | WASHER | RONDELLA | RONDELLE |

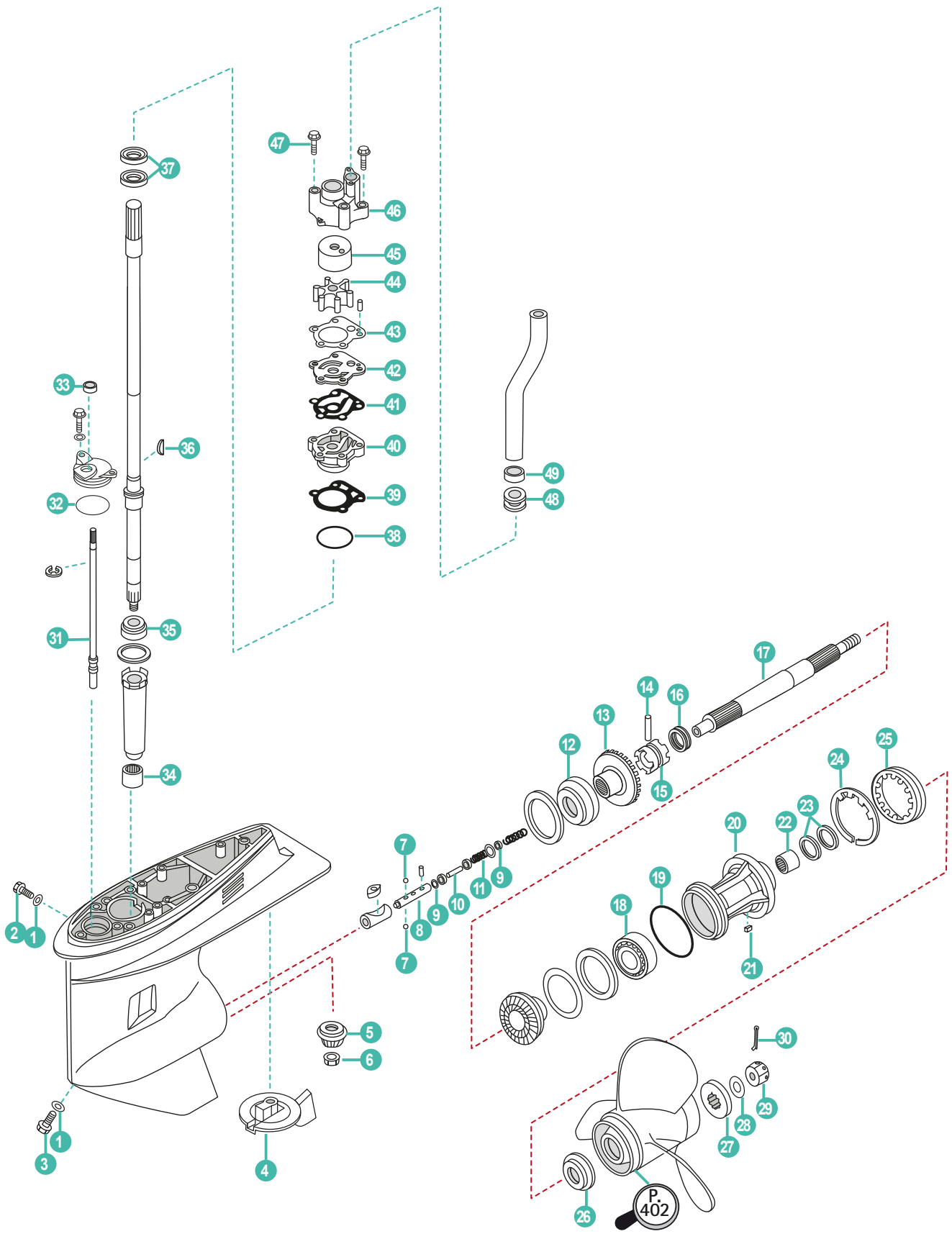

| | REF | OEM | | | | |
|----|--------------------|-----------------|---------------------|--------------------|-----------------------|------------------------|
| 1 | REC90430-08020 | 90430-08020-00 | JUNTA | GASKET | GUARNIZIONE | JOINT |
| 2 | REC90340-08002 | 90340-08002 | TAPÓN | PLUG | TAPPO | BOUCHON DE VIDANGE |
| 3 | REC688-45341-00 | 688-45341-00-00 | TAPÓN | PLUG | TAPPO | BOUCHON DE VIDANGE |
| 4 | CM688-45371-02 | 688-45371-02-00 | ÁNODO | ANODE | ANODO | ANODE |
| 5 | REC688-45551-00 | 688-45551-01-00 | PIÑÓN ATAQUE | INITIATIVE GEAR | MARCIA INIZIATIVA | PIGNON D'ATTAQUE |
| 6 | REC90170-16M01 | 90170-16M01-00 | TUERCA | NUT | DADO | ECROU |
| 7 | REC93503-16003 | 93503-16003 | ESFERA | BALL | SFERA | BILLE |
| 8 | REC6H1-45634-02 | 6H1-45634-02 | DESPLAZABLE | SLIDE, SHIFT | SCORREVOLE | DOUILLE |
| 9 | REC90183-02M03 | 90183-02M03 | TUERCA | NUT | DADO | ECROU |
| 10 | REC6H1-45668-00 | 6H1-45668-00 | EJE | SHAFT | ASSE | ARBRE |
| 11 | REC90501-12M48 | 90501-12M48 | RESORTE | SPRING | MOLLA | RESSORT |
| 12 | REC93332-000W7 | 93332-000W7-00 | RODAMIENTO | BEARING | CUSCINETTO | ROULEMENT |
| 13 | REC688-45560-00 | 688-45560-00-00 | PIÑÓN MARCHA AVANTE | POSITIVE GEAR ASSY | PIGNONE MARCIA AVANTI | PIGNON DE MARCHÉ AVANT |
| 14 | REC90250-07M02 | 90250-07M02-00 | PASADOR | PIN | SPINOTTO | CLAVETTE |
| 15 | REC6H1-45631-01 | 6H1-45631-01-00 | SELECTOR | CLUTCH | SELETORE | CRABOT |
| 16 | REC688-45633-00 | 688-45633-00-00 | MUELLE | SPRING | MOLLA | RESSORT |
| 17 | REC6H1-45611-00 | 6H1-45611-01-00 | EJE HÉLICE | PROPELLER SHAFT | ASSE ELICA | ARBRE D'HELICE |
| 18 | REC93306-207U0 | 93306-207U0-00 | RODAMIENTO | BEARING | CUSCINETTO | ROULEMENT |
| 19 | REC93210-85M97 | 93210-85M97-00 | ARO TÓRICO | O-RING | O-RING | JOINT TORIQUE |
| 20 | REC688-45331-00-94 | 688-45331-00-94 | DIABOLO | DIABOLO | DIABOLO | DIABOLO |
| 21 | REC90282-04010 | 90282-04010 | CHAVETA | KEY | CHIAVETTA | CLAVETTE |
| 22 | REC93317-325U0 | 93317-325U0-00 | RODAMIENTO | BEARING | CUSCINETTO | ROULEMENT |
| 23 | REC93101-25M03 | 93101-25M03-00 | RETÉN | OIL SEAL | PARAOLIO | JOINT SPI |
| 24 | REC688-45383-01 | 688-45383-02-00 | ARANDELA | WASHER | RONDELLA | RONDELLE |
| 25 | REC688-45384-00 | 688-45384-00-00 | TUERCA | NUT | DADO | ECROU |
| 26 | REC688-45987-00 | 688-45987-01-00 | ESPACIADOR | SPACER | DISTANZIALE | ENTRETOISE |
| 27 | REC688-45997-00 | 688-45997-01-00 | ESPACIADOR | SPACER | DISTANZIALE | ENTRETOISE |
| 28 | REC90201-17M00 | 90201-17M00-00 | ARANDELA | WASHER | RONDELLA | RONDELLE |
| 29 | REC90171-16011 | 90171-16011-00 | TUERCA | NUT | DADO | ECROU D'HELICE |
| 30 | REC91490-40030 | 91490-40030-00 | PASADOR | PIN | SPINOTTO | GOUPILLE |
| 31 | REC6H1-44144-00 | 6H1-44144-00 | VARILLA CAMBIO | SHIFT ROD | ASSE SELETORE | LEVIER DE VITESSE |
| 32 | REC93210-49046 | 93210-49046-00 | ANILLO | O-RING | O-RING | JOINT TORIQUE |
| 33 | REC93106-09014 | 93106-09014-00 | RETÉN | OIL SEAL | PARAOLIO | JOINT SPI |
| 34 | REC93315-325V1 | 93315-325V1-00 | RODAMIENTO | BEARING | CUSCINETTO | ROULEMENT |
| 35 | REC93332-000U3 | 93332-000U3-00 | RODAMIENTO | BEARING | CUSCINETTO | ROULEMENT |
| 36 | REC90280-04M04 | 90280-04M04-00 | CHAVETA | KEY | CHIAVETTA | CLAVETTE |
| 37 | REC93101-25M03 | 93101-25M03-00 | RETÉN | OIL SEAL | PARAOLIO | JOINT SPI |
| 38 | REC93210-46044 | 93210-46044-00 | ANILLO, BASE | O-RING | O-RING | JOINT TORIQUE |
| 39 | REC688-44316-00 | 688-44316-A0-00 | JUNTA, BASE | GASKET | GUARNIZIONE | JOINT |
| 40 | REC688-44341-01 | 688-44341-01-94 | BASE, BOMBA AGUA | HOUSING WATER PUMP | BASE POMPA ACQUA | BASE DE POMPE À EAU |
| 41 | REC688-44324-00 | 688-44324-A0-00 | JUNTA | GASKET | GUARNIZIONE | JOINT |
| 42 | REC688-44323-00 | 688-44323-00-00 | PLATO | PLATE | PIASTRA | PLAQUE DE POMPE À EAU |
| 43 | REC688-44315-00 | 688-44315-A0-00 | JUNTA | GASKET | GUARNIZIONE | JOINT |
| 44 | REC688-44352-03 | 688-44352-03-00 | TURBINA | IMPELLER | GIRANTE | TURBINE |
| 45 | REC688-44322-00 | 688-44322-00-00 | ACOPLAMIENTO INOX. | INSERT | BOCCOLA INOX. | INSERT DE POMPE À EAU |
| 46 | REC688-44311-01 | 688-44311-01-00 | CUERPO BOMBA AGUA | HOUSING | CORPO POMA ACQUA | CORPS DE POMPE À EAU |
| 47 | REC97395-08070 | 97395-08070-00 | TORNILLO | BOLT | VITE | VIS |
| 48 | REC663-44366-00 | 663-44366-00 | RETÉN | SEAL | PARAOLIO | BAGUE |
| 49 | REC90430-12072 | 90430-12072-00 | JUNTA | GASKET | GUARNIZIONE | JOINT |

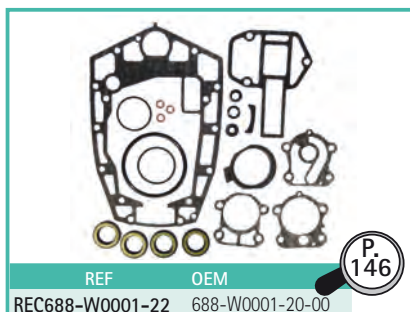

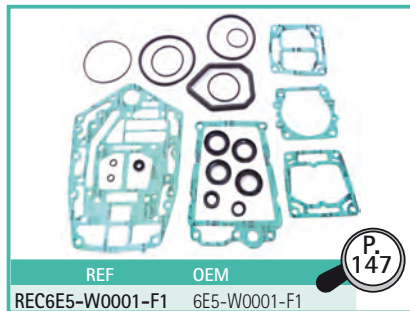
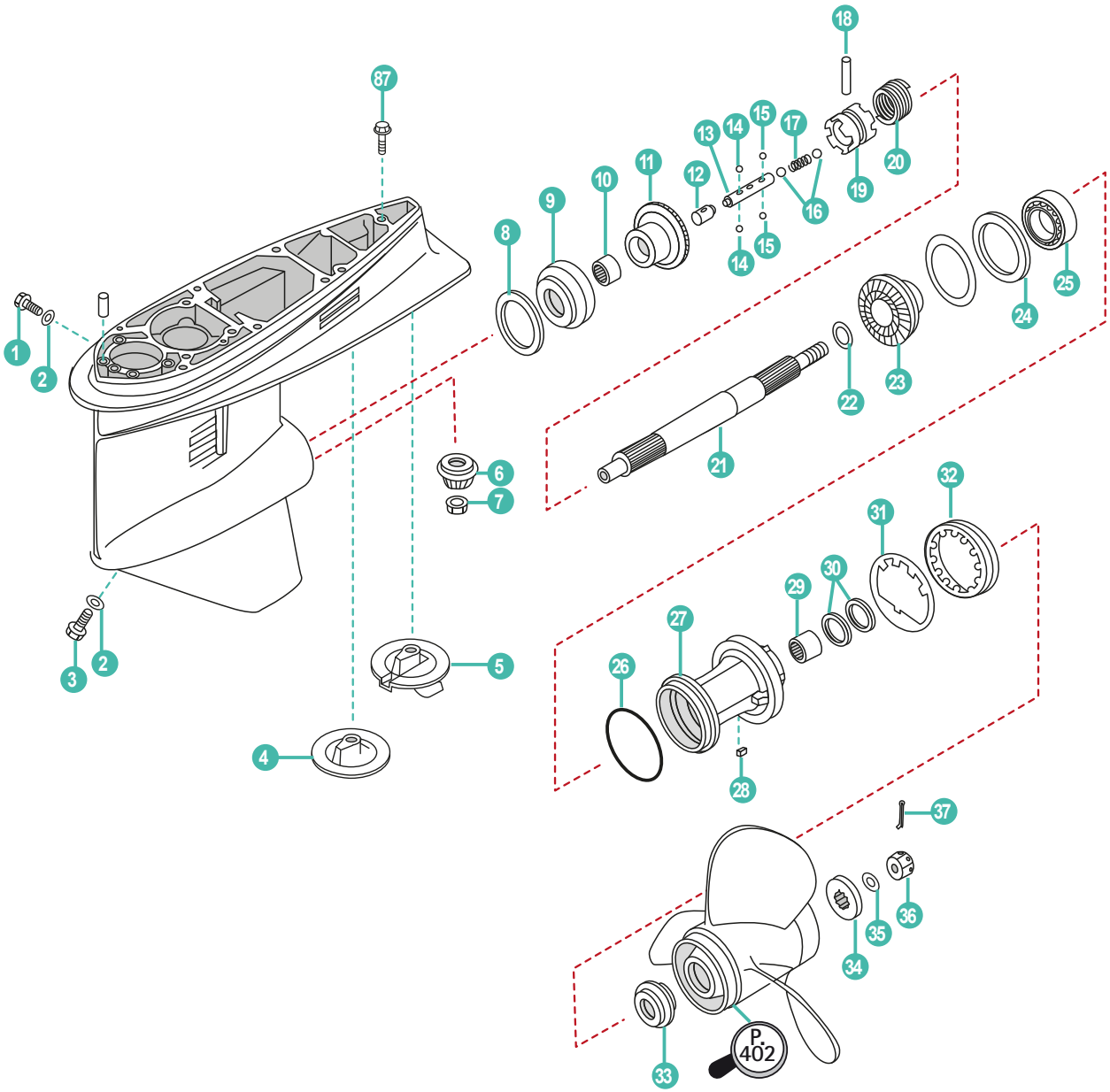

| | REF | OEM | | | | |
|----|--------------------|-----------------|---------------------|----------------------|-------------------------|------------------------|
| | REC405-A20 | 6E5-45300-16-8D | COLA COMPLETA | LOWER UNIT ASSY | PIEDE COMPLETO | EMBASE COMPLETE |
| | REC405-A25 | 6E5-45300-26-8D | COLA COMPLETA | LOWER UNIT ASSY | PIEDE COMPLETO | EMBASE COMPLETE |
| 1 | REC90340-08002 | 90340-08M04 | TAPÓN | PLUG, STRAIGHT SCREW | TAPPO | BOUCHON DE VIDANGE |
| 2 | REC90430-08020 | 90430-08020 | JUNTA | GASKET | GUARNIZIONE | JOINT |
| 3 | REC688-45341-00 | 688-45341-00 | TAPÓN | PLUG DRAIN | TAPPO | BOUCHON DE VIDANGE |
| 4 | REC6E5-45371-01 | 6E5-45371-01 | ZINC HÉLICE ALU | TAB-TRIM | ZINCO ELICA ALLU. | ANODE |
| 5 | TEN01153 | 6E5-45371-10 | ZINC HÉLICE INOX | TAB-TRIM | ZINCO ELICA INOX. | ANODE |
| 6 | REC6E5-45551-00 | 6E5-45551-02 | PIÑÓN ATAQUE | INITIATIVE GEAR | MARCIA INIZIATIVA | PIGNON D'ATTAQUE |
| 7 | REC90170-16M01 | 90170-16M01 | TUERCA | NUT | DADO | ECROU |
| 8 | REC6E5-45567-01 | 6E5-45567-01-60 | KIT GRUESO | SHIM SET | KIT SPESSORE | KIT CALE |
| 9 | REC93332-000U7 | 93332-000U7 | RODAMIENTO | BEARING | CUSCINETTO | ROULEMENT |
| 10 | REC93315-425U7 | 93315-425U7 | RODAMIENTO | BEARING | CUSCINETTO | ROULEMENT |
| 11 | REC6E5-45560-00 | 6E5-45560-01 | PIÑÓN MARCHA AVANTE | POSITIVE GEAR ASSY | PIGNONE MARCIA AVANTI | PIGNON DE MARCHE AVANT |
| 12 | REC6E5-45641-03 | 6E5-45641-02 | BULÓN | SHIFTER | BULLONE | PISTON |
| 13 | REC6E5-45634-01 | 6E5-45634-01 | PASADOR DESPLAZABLE | SLIDE, SHIFT | PASSANTE | DOUILLE |
| 14 | REC93507-32031 | 93507-32031 | BOLA | BALL | BOLLA | BILLE |
| 15 | REC93503-16003 | 93503-16003 | BOLA | BALL | BOLLA | BILLE |
| 16 | REC93511-32027 | 93511-32027 | BOLA | BALL | BOLLA | BILLE |
| 17 | REC90501-16M37 | 90501-16M37 | MUELLE | SPRING, COMPRESSION | MOLLA | RESSORT |
| 18 | REC90250-08M07 | 90250-08M07 | PASADOR | PIN STRAIGHT | SPINOTTO | PIN |
| 19 | REC6E5-45631-00 | 6E5-45631-01 | DESPLAZABLE | CLUTCH, DOG | SCORREVOLE | CRABOT |
| 20 | REC6E5-45633-01 | 6E5-45633-01 | ARILLO METÁLICO | RING, CROSS PIN | O-RING | JOINT TORIQUE |
| 21 | REC6E5-45611-00 | 6E5-45611-01 | EJE HÉLICE | SHAFT, PROPELLER | ASSE ELICA | ARBRE D'HELICE |
| 22 | REC90201-30M92 | 90201-30M92 | ARANDELA | WASHER, PLATE | RONDELLA | RONDELLE |
| 23 | REC6E5-45570-00 | 6E5-45571-01 | PIÑÓN MARCHA ATRÁS | REVERSE GEAR | PIGNONE MARCIA INDIETRO | PIGNON MARCHE ARRIÈRE |
| 24 | REC6E5-45576-00 | 6E5-45576-00 | ARANDELA | WASHER, THURST | RONDELLA | RONDELLE |
| 25 | REC93306-208U0 | 93306-208U0 | RODAMIENTO | BEARING | CUSCINETTO | ROULEMENT |
| 26 | REC93210-86M39 | 93210-86M39 | ARO TÓRICO | O-RING | O-RING | JOINT TORIQUE |
| 27 | REC6E5-45332-00-94 | 6E5-45332-00-94 | CUERPO COJINETE | HOUSING, BEARING | CUSCINETTO | DIABOLO |
| 28 | REC90282-04010 | 90282-04010 | CHAVETA | KEY, STRAIGHT | CHIAVETTA | CLAVETTE |
| 29 | REC93315-430U8 | 93315-430U8 | RODAMIENTO | BEARING | CUSCINETTO | ROULEMENT |
| 30 | REC93101-30M17 | 93101-30M17 | RETÉN | OIL SEAL | PARAOLIO | JOINT SPI |
| 31 | REC688-45383-01 | 688-45383-02 | ARANDELA | WASHER, CLAW | RONDELLA | RONDELLE |
| 32 | REC688-45384-00 | 688-45384-00 | TUERCA | NUT | DADO | ECROU |
| 33 | REC6E5-45987-00 | 6E5-45987-01 | SEPARADOR | SPACER | SPESSORE | ENTRETOISE |
| 34 | REC688-45997-00 | 688-45997-01 | SEPARADOR | SPACER | SPESSORE | ENTRETOISE |
| 35 | REC92990-18200 | 92990-18200 | ARANDELA | WASHER | RONDELLA | RONDELLE |
| 36 | REC90171-18M04 | 90171-18M04 | TUERCA HÉLICE | NUT, CASTLE | DADO | ECROU D'HELICE |
| 37 | REC91490-40030 | 91490-40030 | PASADOR ALETA | PIN, COTTER | SPINOTTO | GOUPILLE |
| 38 | PAT85-00000012 | 90105-10M00 | TORNILLO | SCREW | VITE | VIS |

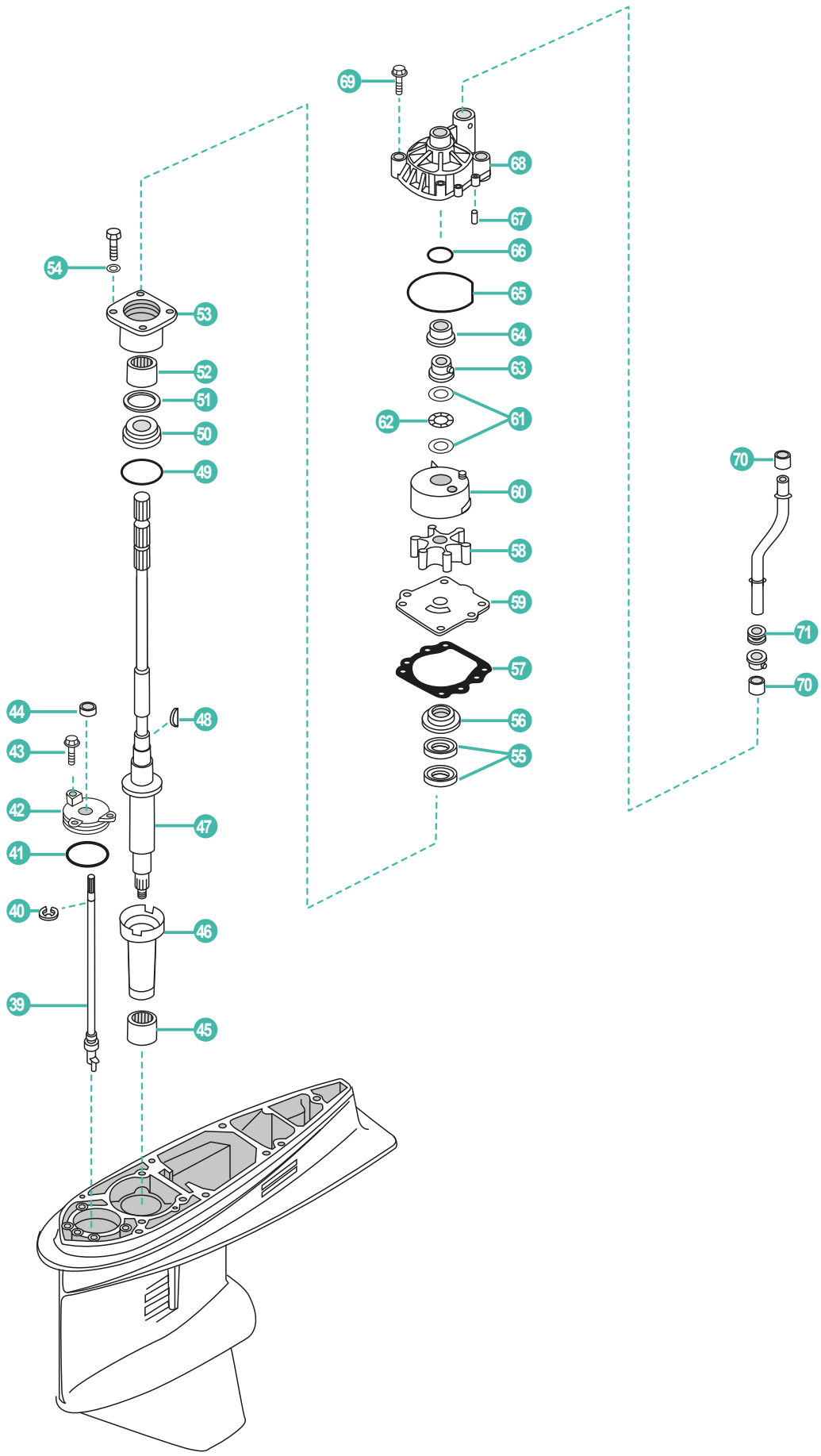

| | REF | OEM | | | | |
|----|--------------------|-----------------|-------------------|-------------------------|------------------|-----------------------|
| 39 | REC6E5-44150-02 | 6E5-44150-01 | EJE SELECTOR | SHIFT CAM ASSY. | ASSE SELETTORE | ARBRE SELECTEUR |
| 40 | REC99001-08600-00 | 99001-08600 | CLIP | CLIP | CLIP | CLIP |
| 41 | REC93210-58677 | 93210-58144 | ARO TÓRICO | O-RING | O-RING | JOINT TORIQUE |
| 42 | REC6E5-45321-00 | 6E5-45321-00 | PLATO | PLATE | PIASTRA | PLAQUE |
| 43 | REC90119-06M10 | 90119-06M10 | TORNILLO | BOLT WITH WASHER | VITE | VIS |
| 44 | REC93106-09014 | 93106-09014 | RETÉN | OIL SEAL | PARAOLIO | JOINT SPI |
| 45 | REC93315-628U9 | 93315-628U9 | RODAMIENTO | BEARING | CUSCINETTO | ROULEMENT |
| 46 | REC6E5-45536-00 | 6E5-45536-00 | CAMISA | SLEEVE | CAMICIA | TUBE GUIDE |
| 47 | REC6E5-45501-01 | 6E5-45501-01 | EJE VERTICAL S | DRIVE SHAFT COMP. S | ASSE VERTICALE S | ARBRE VERTICAL S |
| 48 | REC90280-04M05 | 90280-04M05 | CHAVETA | KEY, WOODRUF | CHIAVETTA | CLAVETTE |
| 49 | REC93210-54534 | 93210-55M14 | ARO TÓRICO | O-RING | O-RING | JOINT TORIQUE |
| 50 | REC93341-930V2 | 93341-930V2 | RODAMIENTO | BEARING | CUSCINETTO | ROULEMENT |
| 51 | REC6E5-45587-01 | 6E5-45587-01 | GRUESO | SHIM | SPESORE | CALE |
| 52 | REC93317-330U2 | 93317-330U2 | RODAMIENTO | BEARING | CUSCINETTO | ROULEMENT |
| 53 | REC6E5-45331-00-94 | 6E5-45331-00-94 | CUERPO RODAMIENTO | HOUSING, BEARING | SEDE CUSCINETTO | PALIER DE ROULEMENT |
| 54 | PAGB/T97.1-8 | 92995-08600 | ARANDELA | WASHER | RONDELLA | RONDELLE |
| 55 | REC93101-28M16 | 93101-28M16 | RETÉN | OIL SEAL | PARAOLIO | JOINT SPI |
| 56 | REC6E5-45344-00 | 6E5-45344-00 | TAPA RETÉN | COVER, OIL SEAL | COPERCHIO | COUVERCLE JOINT SPI |
| 57 | REC6E5-44315-A0 | 6E5-44315-A0 | JUNTA BOMBA | GASKET, WATER PUMP | GUARNIZIONE | JOINT |
| 58 | REC6E5-44323-00-40 | 6E5-44323-00 | PLATO | OUTTER PLATE, CARTRIDGE | PIASTRA | TURBINE |
| 59 | REC6E5-44352-01 | 6E5-44352-01 | TURBINA | IMPELLER | GIRANTE | PLAQUE DE POMPE À EAU |
| 60 | REC61A-44322-02 | 61A-44322-02 | CASQUILLO INOX | INSERT, CARTRIDGE | BOCCOLA INOX. | INSERT DE POMPE À EAU |
| 61 | REC90201-22M01 | 90201-22M01 | ARANDELA | WASHER | RONDELLA | RONDELLE |
| 62 | REC90206-22M19 | 90206-22M19 | ARANDELA | WASHER | RONDELLA | RONDELLE |
| 63 | REC61A-45538-00 | 61A-45538-00 | ESPACIADOR | SPACER | DISTANZIALE | ENTRETOISE |
| 64 | REC61A-45527-00 | 61A-45527-00 | CASQUILLO | COLLAR, DRIVE SHAFT | BOCCOLA | GUIDE |
| 65 | REC93210-86M38 | 93210-86M38 | ARO TÓRICO | O-RING | O-RING | JOINT TORIQUE |
| 66 | REC93210-37160 | 93210-37160 | ARO TÓRICO | O-RING | O-RING | JOINT TORIQUE |
| 67 | REC93606-12019 | 93606-12019 | PIN CENTRADOR | PIN DOWEL | SPINOTTO | PIN |
| 68 | REC61A-44311-00 | 61A-44311-01 | CUERPO BOMBA | HOUSING, WATER PUMP | CORPO POMPA | CORPS DE POMPE À EAU |
| 69 | REC90119-08M14 | 90119-08M14 | TORNILLO | BOLT, WITH WASHER | VITE | VIS |
| 70 | REC6E5-44365-00 | 6E5-44365-00 | CASQUILLO GOMA | DAMPER | BOCCOLA | BAGUE |
| 71 | REC6E5-44366-00 | 6E5-44366-00 | CASQUILLO GOMA | DAMPER | BOCCOLA | BAGUE |

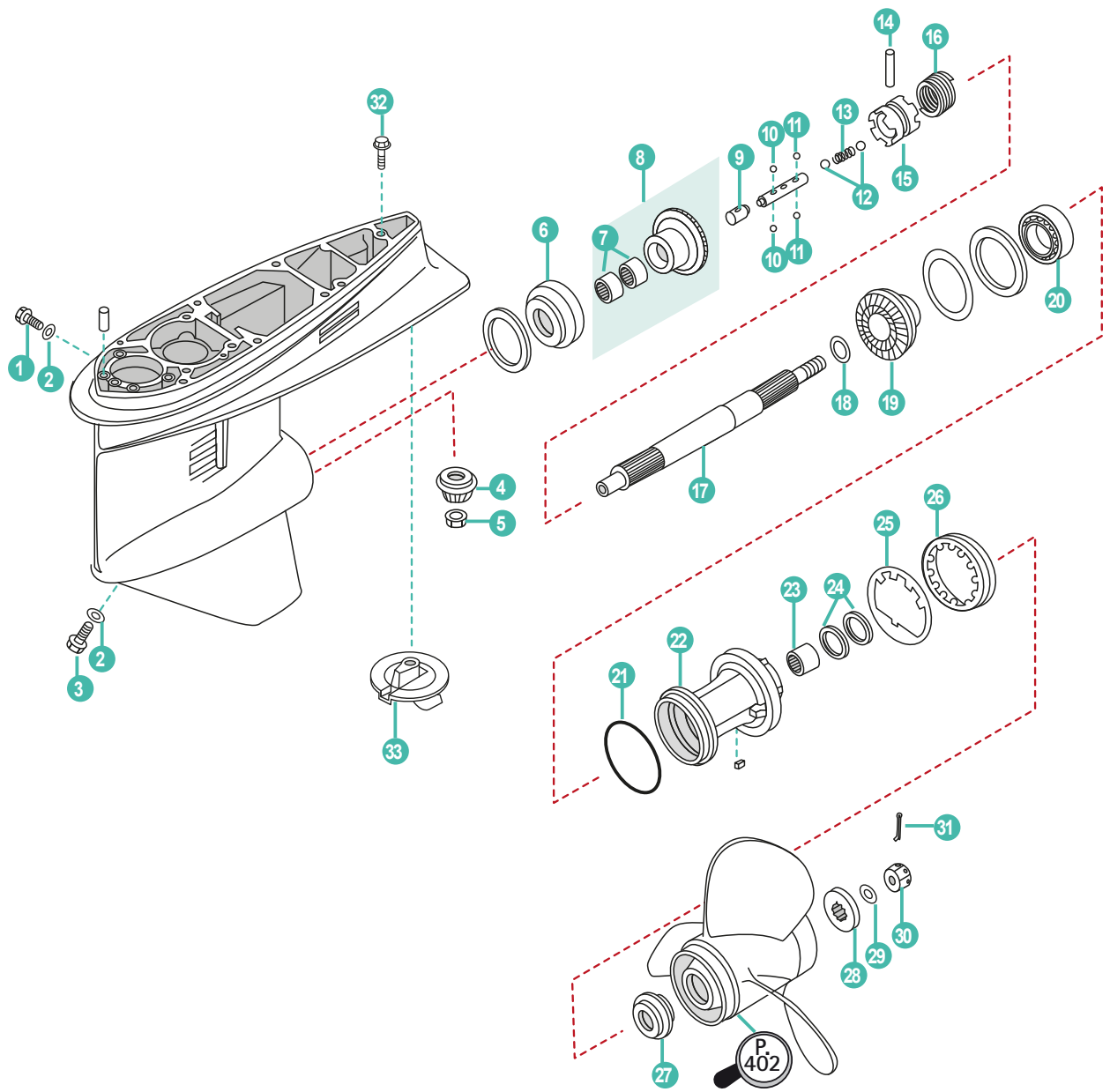

| REF | OEM |
|-----------------|--------------|
| REC6G5-W0078-A1 | 6G5-W0078-A1 |

P. 152

| REF | OEM |
|-----------------|--------------|
| REC6E5-W0001-F1 | 6E5-W0001-F1 |

P. 147

| REF |
|------------|
| REC80W90U3 |
| REC80W90U6 |
| RECGREU1 |
| RECGREU12 |

P. 43

| | REF | OEM | | | | |
|----|--------------------|-----------------|---------------------|----------------------|-------------------------|------------------------|
| | REC416-A20 | 64D-45300-02-8D | COLA COMPLETA 20" | LOWER UNIT ASSY 20" | PIEDE COMPLETO 20" | EMBASE COMPLETE 20" |
| | REC416-A25 | 64D-45300-22-8D | COLA COMPLETA 25" | LOWER UNIT ASSY 25" | PIEDE COMPLETO 25" | EMBASE COMPLETE 25" |
| 1 | REC90340-08002 | 90340-08002 | TAPÓN | PLUG, STRAIGHT SCREW | TAPPO | BOUCHON DE VIDANGE |
| 2 | REC90430-08020 | 90430-08020 | JUNTA | GASKET | GUARNIZIONE | JOINT |
| 3 | REC688-45341-00 | 688-45341-10 | TAPÓN | PLUG, DRAIN | TAPPO | BOUCHON DE VIDANGE |
| 4 | REC6G5-45551-00 | 6G5-45551-01 | PIÑÓN ATAQUE | INITIATIVE GEAR | MARCIA INIZIATIVA | PIGNON D'ATTAQUE |
| 5 | REC90170-16M01 | 93170-16M01 | TUERCA | NUT | DADO | ECROU |
| 6 | REC93332-000V3 | 93332-000V3 | RODAMIENTO | BEARING | CUSCINETTO | ROULEMENT |
| 7 | REC93315-425V3 | 93315-425V3 | RODAMIENTO | BEARING | CUSCINETTO | ROULEMENT |
| 8 | REC6G5-45560-00 | 6G5-45560-01 | PIÑÓN MARCHA AVANTE | POSITIVE GEAR ASSY | PIGNONE MARCIA AVANTI | PIGNON DE MARCHÉ AVANT |
| 9 | REC6E5-45641-03 | 6E5-45641-03 | PITOT | PITOT | PITOT | PITOT |
| 10 | REC93507-32031 | 93507-32031 | BOLA | BALL | BOLLA | BILLE |
| 11 | REC93503-16003 | 93503-16003 | BOLA | BALL | BOLLA | BILLE |
| 12 | REC93511-32027 | 93511-32027 | BOLA | BALL | BOLLA | BILLE |
| 13 | REC90501-16M37 | 90501-16M37 | MUELLE | SPRING | MOLLA | RESSORT |
| 14 | REC90250-08M07 | 90250-08M07 | PASADOR | PIN, STRAIGHT | SPINOTTO | CLAVETTE |
| 15 | REC6G5-45631-00 | 6G5-45631-00 | DESPLAZABLE | CLUTCH, DOG | SCORREVOLE | CRABOT |
| 16 | REC6E5-45633-01 | 6E5-45633-01 | ANILLO | RING, CROSS PIN | O-RING | JOINT TORIQUE |
| 17 | REC6J9-45611-00 | 6J9-45611-01 | EJE HÉLICE | SHAFT, PROPELLER | ASSE ELICA | ARBRE D'HELICE |
| 18 | REC90201-30M92 | 90201-30M92 | ARANDELA | WASHER, PLATE | RONDELLA | RONDELLE |
| 19 | REC6G5-45571-00 | 6G5-45571-02 | PIÑÓN MARCHA ATRÁS | REVERSE GEAR | PIGNONE MARCIA INDIETRO | PIGNON MARCHÉ ARRIÈRE |
| 20 | REC93306-209U0 | 93306-209U0 | RODAMIENTO | BEARING | CUSCINETTO | ROULEMENT |
| 21 | REC93210-97M55 | 93210-97M55 | ARO TÓRICO | O-RING | O-RING | JOINT TORIQUE |
| 22 | REC6J9-45332-00-CA | 6J9-45332-00-CA | DIÁBOLO | BEARING CARRIER | COP. CASSA INGRANAGGI | DIABOLO |
| 23 | REC93315-43061 | 93315-43061 | RODAMIENTO | BEARING | CUSCINETTO | ROULEMENT |
| 24 | REC93101-30M17 | 93101-30M17 | RETÉN | OIL SEAL | PARAOLIO | JOINT SPI |
| 25 | REC6G5-45383-01 | 6G5-45383-01 | ARANDELA | WASHER, CLAW | RONDELLA | RONDELLE |
| 26 | REC6G5-45384-00 | 6G5-45384-00 | TUERCA | NUT | DADO | ECROU |
| 27 | REC6E5-45987-00 | 6E5-45978-01 | ESPACIADOR | SPACER | DISTANZIALE | ENTRETOISE |
| 28 | REC688-45997-00 | 688-45997-01 | ESPACIADOR | SPACER | DISTANZIALE | ENTRETOISE |
| 29 | REC92990-18200 | 92990-18200 | ARANDELA | WASHER | RONDELLA | RONDELLE |
| 30 | REC90171-18M04 | 90171-18M04 | TUERCA | NUT, CASTLE | DADO | ECROU D'HELICE |
| 31 | REC91490-40030 | 91490-40030 | PASADOR | PIN, COTTER | SPINOTTO | GOUPILLE |
| 32 | PAT85-00000012 | 90105-10M00 | TORNILLO | SCREW | VITE | VIS |
| 33 | CM6E5-45371-01A | 6E5-45371-01 | ÁNODO | ANODE | ANODO | ANODE |

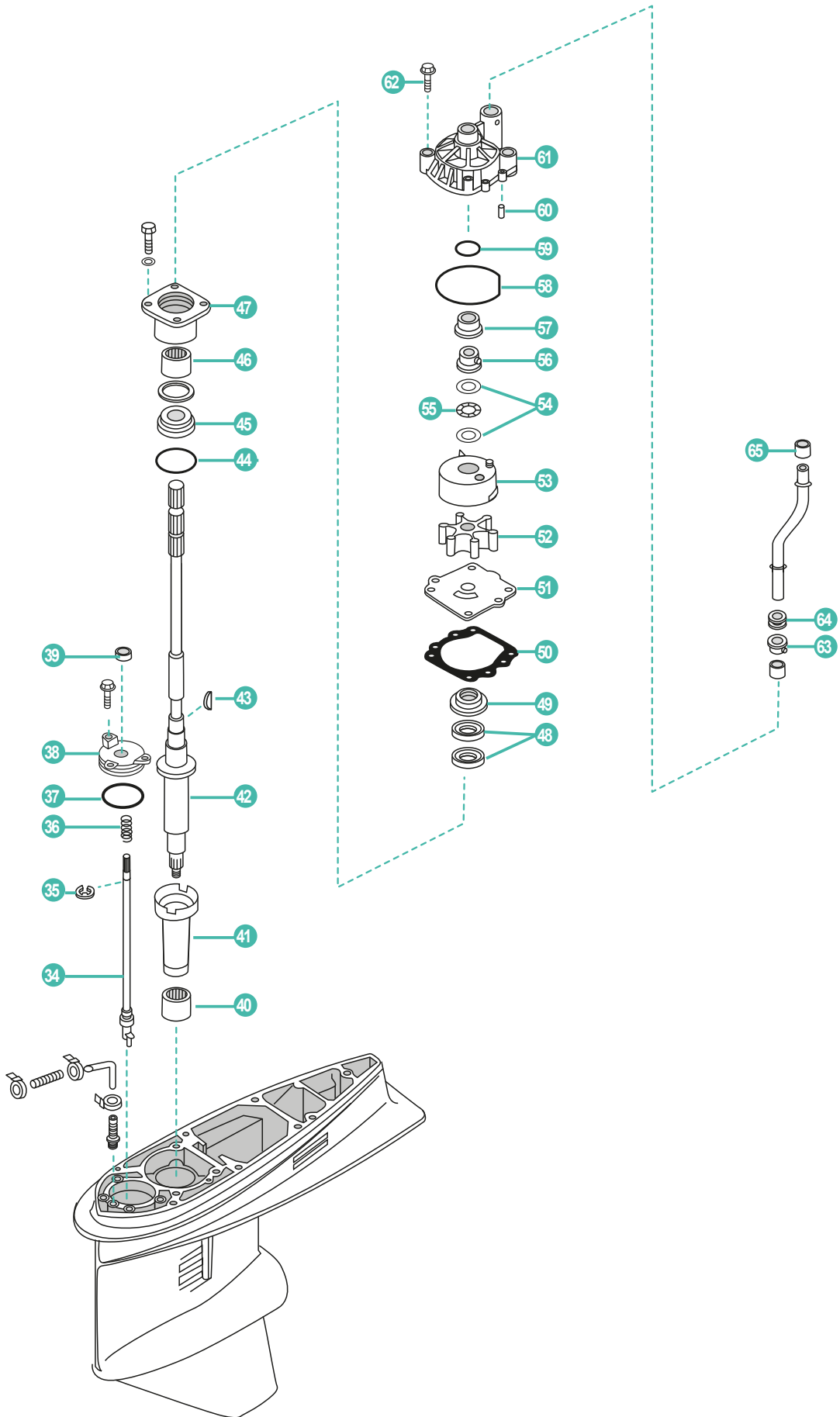

| | REF | OEM | | | | |
|----|--------------------|-----------------|--------------------------------|---------------------------------|-------------------------------|---|
| 34 | REC6G5-44150-02 | 6G5-44150-02 | EJE CAMBIO | SHIFT SHAFT | ASSE CAMBIO | LEVIER DE VITESSE |
| 35 | REC99001-08600-00 | 99001-08600 | CLIP | BEARING | CUSCINETTO | ROULEMENT |
| 36 | REC90501-11M10-00 | 90501-11M10 | MUELLE | SPRING | MOLLA | RESSORT |
| 37 | REC93210-58677 | 93210-58144 | ARO TÓRICO | O-RING | O-RING | JOINT TORIQUE |
| 38 | REC6E5-45321-00 | 6E5-45321-00 | TAPA EJE | SHIFT COVER | COPERCHIO ASSE | COUVERCLE |
| 39 | REC93106-09014 | 93106-09014 | RETÉN | OIL SEAL | PARAOLIO | JOINT SPI |
| 40 | REC93311-928U5 | 93311-928U5 | RODAMIENTO | BEARING | CUSCINETTO | ROULEMENT |
| 41 | REC6G5-45536-01 | 6G5-45536-01 | CAMISA | LUBE SLEEVE | CAMICIA | DOUILLE |
| 42 | REC6G5-45501-21 | 6G5-45501-21 | EJE 25" | DRIVE SHAFT COMP. 25" | ASSE VERTICALE 25" | ARBRE VERTICAL 25" |
| 43 | REC90280-04M05 | 90280-04M05 | CHAVETA | KEY, WOODRUFF | CHIAVETTA | CLAVETTE |
| 44 | REC93210-54534 | 93210-55M14 | ARO TÓRICO | O-RING | O-RING | JOINT TORIQUE |
| 45 | REC93341-930V2 | 93341-930V2 | RODAMIENTO | BEARING | CUSCINETTO | ROULEMENT |
| 46 | REC93317-330U2 | 93317-330U2 | RODAMIENTO | BEARING | CUSCINETTO | ROULEMENT |
| 47 | REC6E5-45331-00-94 | 6E5-45331-00-94 | CUERPO RODAMIENTO | HOUSING, BEARING | SEDE CUSCINETTO | PALIER DE ROULEMENT |
| 48 | REC93101-28M16 | 93101-28M16 | RETÉN | OIL SEAL | PARAOLIO | JOINT SPI |
| 49 | REC6E5-45344-00 | 6E5-45344-00 | TAPA RETÉN | COVER, OIL SEAL | COPERCHIO | COUVERCLE JOINT SPI |
| 50 | REC6E5-44315-A0 | 6E5-44315-A0 | JUNTA | GASKET, WATER PUMP | GUARNIZIONE | JOINT DE POMPE À EAU |
| 51 | REC6G5-44323-00 | 6G5-44323-00 | PLATO | OUTER PLATE, CARTRIDGE | PIASTRA | PLAQUE DE POMPE À EAU |
| 52 | REC6E5-44352-01 | 6E5-44352-01 | TURBINA | IMPELLER | GIRANTE | TURBINE |
| 53 | REC61A-44322-02 | 61A-44322-02 | CASQUILLO INOX. -ANTIGUA- | INSERT, CARTRIDGE -OLDER- | BOCCOLA INOX. -ANTICA- | INSERT DE POMPE À EAU -ANCIEN MODÈLE- |
| | REC6E5-44322-00 | 6E5-44322-00 | CASQUILLO INOX. -MODERNA- | INSERT, CARTRIDGE -NEWER- | BOCCOLA INOX. -NUOVA- | INSERT DE POMPE À EAU -NOUVEAU MODÈLE- |
| 54 | REC90206-22M19 | 90206-22M19 | ARANDELA | WASHER | RONDELLA | RONDELLE |
| 55 | REC90201-22M01 | 90201-22M01 | ARANDELA | WASHER | RONDELLA | RONDELLE |
| 56 | REC61A-45538-00 | 61A-45538-00 | ESPACIADOR | SPACER | DISTANZIALE | ENTRETOISE |
| 57 | REC61A-45527-00 | 61A-45527-00 | GOMA | COLLAR | GOMMA | BAGUE |
| 58 | REC93210-86M38 | 93210-86M38 | ARO TÓRICO | O-RING | O-RING | JOINT TORIQUE |
| 59 | REC93210-37160 | 93210-37160 | ARO TÓRICO | O-RING | O-RING | JOINT TORIQUE |
| 60 | REC93606-12019 | 93606-12019 | CENTRADOR | PIN, DOWEL | SPINOTTO | PIN |
| 61 | REC61A-44311-00 | 61A-44311-01 | CUERPO BOMBA AGUA -ANTIGUA- | HOUSTING, WATER PUMP -OLDER- | CORPO POMPA ACQUA -ANTICA- | CORPS DE POMPE À EAU -ANCIEN MODÈLE- |
| | REC6E5-44311-00 | 6E5-44311-00 | CUERPO BOMBA AGUA -MODERNA- | HOUSTING, WATER PUMP -NEWER- | CORPO POMPA ACQUA -NUOVA- | CORPS DE POMPE À EAU -NOUVEAU MODÈLE- |
| 62 | REC90119-08M14 | 90119-08M14 | TORNILLO | BOLT, WITH WASHER | VITE | VIS |
| 63 | REC6E5-44365-00 | 6E5-44365-00 | CASQUILLO GOMA | DAMPER, WATER SEAL | BOCCOLA GOMMA | BAGUE |
| 64 | REC6E5-44366-00 | 6E5-44366-00 | SELLO GOMA AGUA | DAMPER, WATER SEAL | BOCCOLA | BAGUE |
| 65 | REC6E5-44365-00 | 6E5-44365-00 | SELLO GOMA AGUA | DAMPER, WATER SEAL | BOCCOLA | BAGUE |

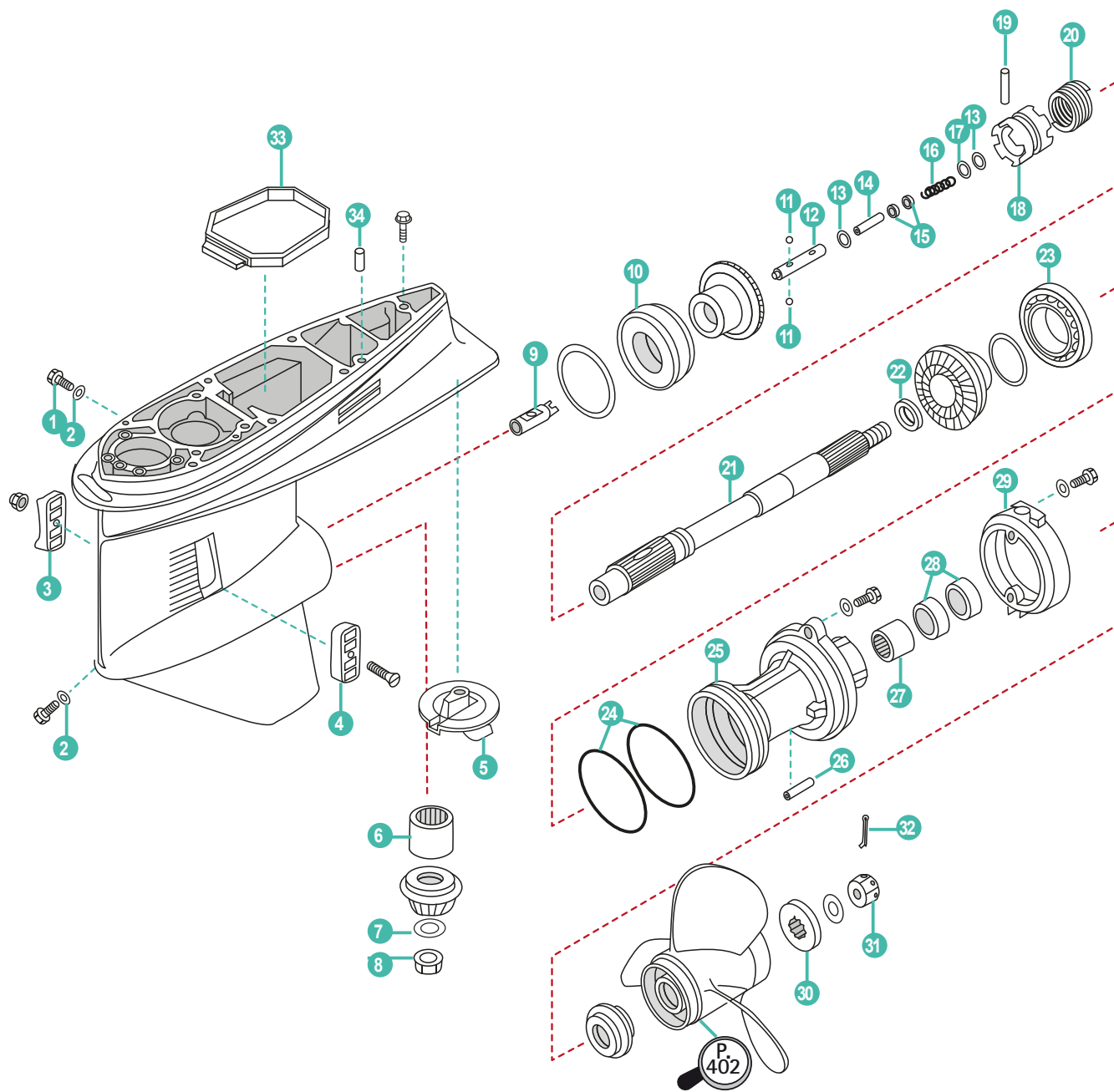

| | REF | OEM | | | | |
|----|--------------------|-----------------|-----------------|-------------------------|-----------------------|-----------------------|
| 1 | REC90340-08002 | 90340-08002 | TORNILLO | VENT PLUG | VITE | BOUCHON DE VIDANGE |
| 2 | REC90430-08020 | 90430-08020 | JUNTA | GASKET, DRAIN PLUG | GUARNIZIONE | JOINT |
| 3 | REC61A-45215-10 | 61A-45215-10 | FILTRO TAPA | WATER SCREEN, STD | COPERCHIO FILTRO | GRILLE D'ENTREE D'EAU |
| 4 | REC61A-45214-10 | 61A-45214-10 | FILTRO TAPA | WATER SCREEN, PORT | COPERCHIO FILTRO | GRILLE D'ENTREE D'EAU |
| 5 | CM61A-45371 | 61A-45371-00 | ÁNODO TIMÓN | TRIM TAB | ANODO | ANODE |
| 6 | REC93311-83280 | 93311-83280 | RODAMIENTO | BEARING | CUSCINETTO | ROULEMENT |
| 7 | REC90201-16M00 | 90201-16M00 | ARANDELA | WASHER | RONDELLA | RONDELLE |
| 8 | REC90170-16M19 | 90170-16M19 | TUERCA DE PIÑÓN | PINION NUT | PIGNONE, DADO | ECROU DE PIGNON |
| 9 | REC61A-45641-02 | 61A-45641-02 | DESPLAZABLE | SHIFTER | SCORREVOLE | DOUILLE |
| 10 | REC93332-000W1 | 93332-000W1 | RODAMIENTO | BEARING | CUSCINETTO | ROULEMENT |
| 11 | REC93501-04011 | 93501-04011 | BOLA | DETENT BALL | BOLLA | BILLE |
| 12 | REC61A-45634-01 | 61A-45634-01 | DESPLAZABLE | SHIFT SLIDE | SCORREVOLE | DOUILLE |
| 13 | REC90183-02M03 | 90183-02M03 | TUERCA | NUT | DADO | ECROU |
| 14 | REC6H1-45668-00 | 6H1-45668-00 | EJE | FREE SHAFT | ASSE | ARBRE |
| 15 | REC61A-45635-00 | 61A-45635-00 | GRUESO | SHIFT PLUNGER | SPESSORE | CALE |
| 16 | REC90501-10M77 | 90501-10M77 | MUELLE | COMPRESSION SPRING | MOLLA | RESSORT |
| 17 | REC90201-02M00 | 90201-02M00 | ARANDELA | PLATE WASHER | RONDELLA | RONDELLE |
| 18 | REC61A-45631-03 | 61A-45631-03 | SELECTOR | CLUTCH, 2 STROKE | SELETTORE | CRABOT |
| 19 | REC61A-45632-00 | 61A-45632-00 | PASADOR | CROSS PIN | SPINOTTO | CLAVETTE |
| 20 | REC61A-45633-00 | 61A-45633-00 | MUELLE | SPRING | MOLLA | RESSORT |
| 21 | REC60V-45611-00 | 60V-45611-00 | EJE HÉLICE | PROP SHAFT | ASSE ELICA | ARBRE D'HELICE |
| 22 | REC90201-31M00 | 90201-31M00 | ARANDELA | WASHER | RONDELLA | RONDELLE |
| 23 | REC93306-210U0 | 93306-210U0 | RODAMIENTO | BEARING | CUSCINETTO | PIGNON |
| 24 | REC93211-04384 | 93211-04384 | ARO TÓRICO | O-RING, BEARING CARRIER | O-RING | JOINT TORIQUE |
| 25 | REC60V-45332-00-94 | 60V-45332-00-94 | DIÁBOLO | BEARING CARRIER | COP. CASSA INGRANAGGI | DIABOLO |
| 26 | REC99590-10114 | 99590-10114 | PIN CENTRADO | ALIGNMENT DOWEL | SPINOTTO | PIN ROULEMENT |
| 27 | REC93315-43061 | 93315-43061 | RODAMIENTO | PROP SHAFT BEARING | CUSCINETTO | ROULEMENT |
| 28 | REC93101-30M17 | 93101-30M17 | RETÉN | PROP SHAFT SEAL | PARAOILIO | JOINT SPI |
| 29 | REC69J-45361-00-8D | 69J-45361-00-8D | FUNDA INFERIOR | CAP, LOWER CASING | COPERCHIO INFERIORE | COUVERCLE INFERIEUR |
| 30 | REC688-45997-00 | 688-45997-00 | ESPACIADOR | SPACER | SPESSORE | ENTRETOISE |
| 31 | REC90171-18M04 | 90171-18M04 | TUERCA | PROP NUT | DADO | ECROU D'HELICE |
| 32 | REC91490-40030 | 91490-40030 | PIN | COTTER PIN | SPINOTTO | GOUPILLE |
| 33 | REC69J-45375-00 | 69J-45375-00 | JUNTA ESCAPE | EXHAUST DAMPER | GUARNIZIONE1 | JOINT D'ECHAPPEMENT |
| 34 | REC93608-12M05 | 93608-12M05 | PIN | ALIGNMENT DOWELS | SPINOTTO | PIN |

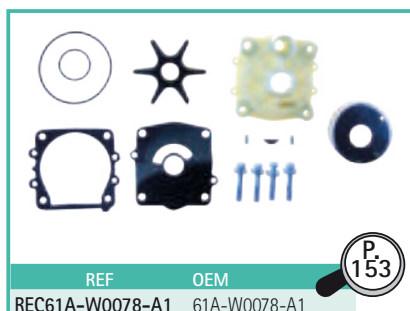

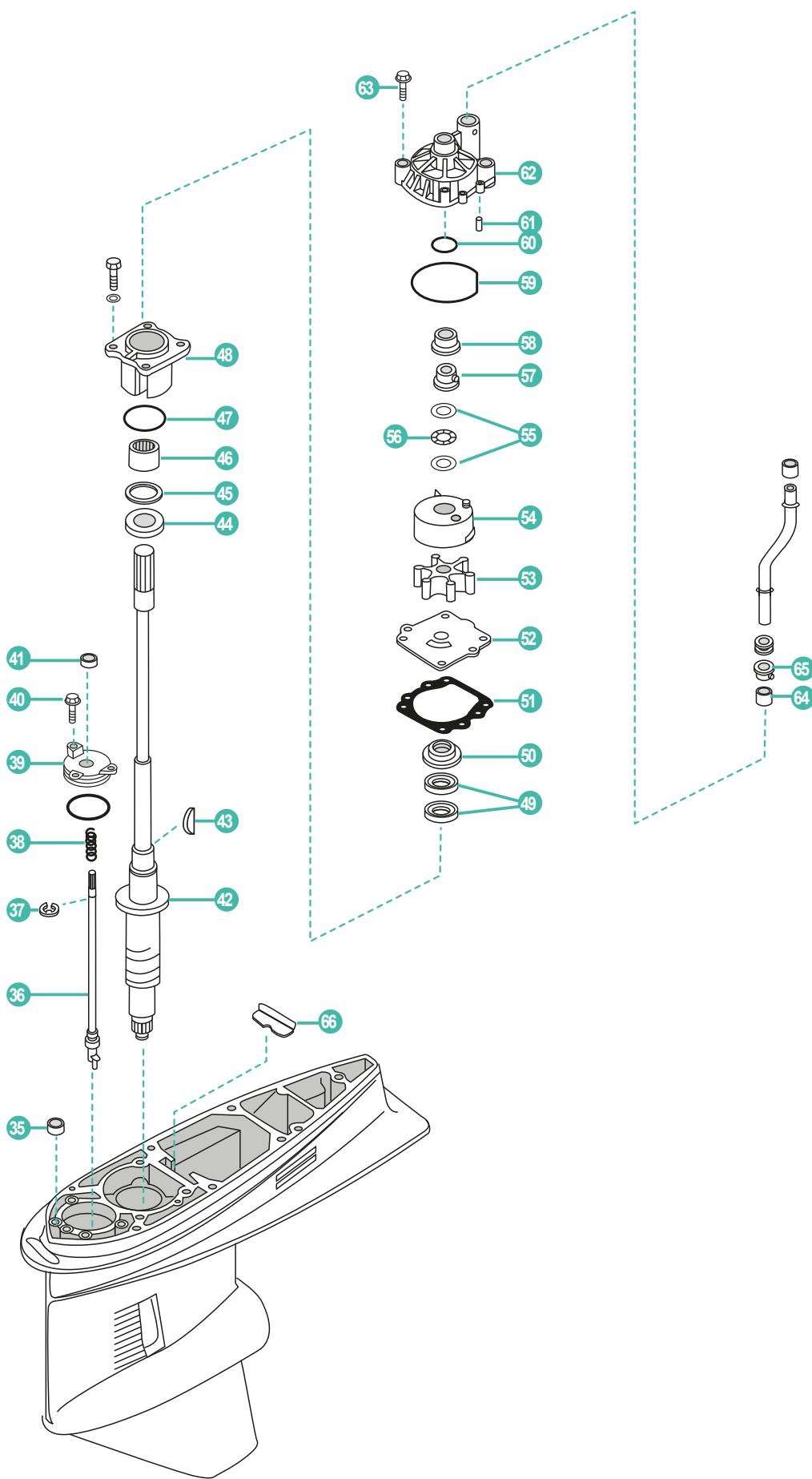

| | REF | OEM | | | | |
|----|----------------------|-----------------|-----------------------|-----------------------------|---------------------|------------------------|
| 35 | REC663-44366-00 | 663-44366-00 | GOMA | SEAL | GOMMA | BAGUE |
| 36 | REC60V-44150-00 | 60V-44150-00 | EJE | SHIFT SHAFT | ASSE | LEVIER DE VITESSE |
| 37 | REC99001-08600-00 | 99001-08600 | CLIP | CLIP | CLIP | CLAVETTE |
| 38 | REC90501-11M10-00 | 90501-11M10 | MUELLE | SPRING | MOLLA | RESSORT |
| 39 | REC61A-45321-01 | 61A-45321-01 | TAPA | SHIFT SHAFT COVER | COPERCHIO ASSE | COUVERCLE |
| 40 | REC90119-06M10 | 90119-06M10 | TORNILLO | BOLT | VITE | VIS |
| 41 | REC93106-09014 | 93106-09014 | RETÉN | SEAL, SHIFT ROD | BOCCOLA | JOINT |
| | REC66K-45501-00 | 66K-45501-00 | EJE 20" | DRIVE SHAFT, 20" | ASSE VERTICALE 20" | ARBRE VERTICAL 20" |
| 42 | REC61A-45501-20 | 61A-45501-20 | EJE 25" | DRIVE SHAFT, 25" | ASSE VERTICALE 25" | ARBRE VERTICAL 25" |
| | REC61A-45501-30 | 61A-45501-30 | EJE 30" | DRIVE SHAFT, 30" | ASSE VERTICALE 30" | ARBRE VERTICAL 30" |
| 43 | REC90280-04M05 | 90280-04M05 | CHAVETA | WOODRUFF KEY | CHIAVETTA | CLAVETTE |
| 44 | REC93341-93020 | 93341-93020 | GRUESO RODAMIENTO | THRUST BEARING | SPESSORE CUSCINETTO | CALE |
| 45 | REC61A-45587-00/60-0 | 61A-45587-00/60 | ESPACIADOR | SHIM KIT | SPESSORE | ENTRETOISE |
| 46 | REC93317-330U2 | 93317-330U2 | RODAMIENTO | BEARING | CUSCINETTO | ROULEMENT |
| 47 | REC93210-54534 | 93210-54534 | ARO TÓRICO | O-RING | O-RING | JOINT TORIQUE |
| 48 | REC61A-45331-00-94 | 61A-45331-00-94 | CUERPO EJE | DRIVE SHAFT BEARING HOUSING | CORPO ASSE | PALIER DE ROULEMENT |
| 49 | REC93101-28M16 | 93101-28M16 | RETÉN | DRIVE SHAFT SEAL | BOCCOLA | JOINT SPI |
| 50 | REC6E5-45344-00 | 6E5-45344-00 | RETÉN | COVER, DRIVE SHAFT SEALS | BOCCOLA | COUVERCLE DE JOINT SPI |
| 51 | REC6E5-44315-A0 | 6E5-44315-A0 | JUNTA BASE | BASE GASKET | GUARNIZIONE | JOINT |
| 52 | REC6G5-44323-00 | 6G5-44323-00 | BASE BOMBA | WEAR PLATE | BASE POMPA | PLAQUE DE POMPE À EAU |
| 53 | REC6E5-44352-01 | 6E5-44352-01 | TURBINA | IMPELLER | GIRANTE | TURBINE |
| 54 | REC61A-44322-02 | 61A-44322-02 | CASQUILLO INOX. | WATER PUMP LINER | BOCCOLA | INSERT DE POMPE À EAU |
| 55 | REC90201-22M01 | 90201-22M01 | ARANDELA | WASHER | RONDELLA | RONDELLE |
| 56 | REC90206-22M19 | 90206-22M19 | TÓRICA | WAVE WASHER | GUARNIZIONE | JOINT TORIQUE |
| 57 | REC61A-45538-00 | 61A-45538-00 | ESPACIADOR | SPACER | DISTANZIALE | ENTRETOISE |
| 58 | REC61A-45527-00 | 61A-45527-00 | COLLAR | COLLAR | COLLAR | BAGUE |
| 59 | REC93210-86M38 | 93210-86M38 | ARO TÓRICO | O-RING | O-RING | JOINT TORIQUE |
| 60 | REC93210-37M67 | 93210-37M67 | ARO TÓRICO | O-RING | O-RING | JOINT TORIQUE |
| 61 | REC93606-12019 | 93606-12019 | PASADOR CENTRAL | ALIGNMENT PIN | SPINOTTO | PIN |
| 62 | REC61A-44311-00 | 61A-44311-00 | CUERPO BOMBA AGUA | WATER PUMP HOUSING | CORPO POMPA ACQUA | CORPS DE POMPE À EAU |
| 63 | REC90119-08M14 | 90119-08M14 | TORNILLO CON ARANDELA | BOLT WITH WASHER | VITE | VIS |
| 64 | REC6E5-44365-00 | 6E5-44365-00 | CASQUILLO JUNTA | DAMPER, WATER TUBE | BOCCOLA TUBO | BAGUE |
| 65 | REC6E5-44312-00 | 6E5-44312-00 | TAPA | OVER | TAPPO | BAGUE |
| 66 | REC61A-45376-00-94 | 61A-45376-00-94 | GUÍA | GUIDE | GUIDE | GUIDE |

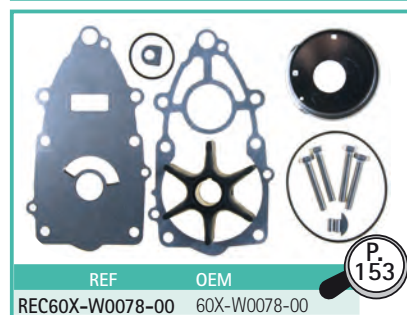
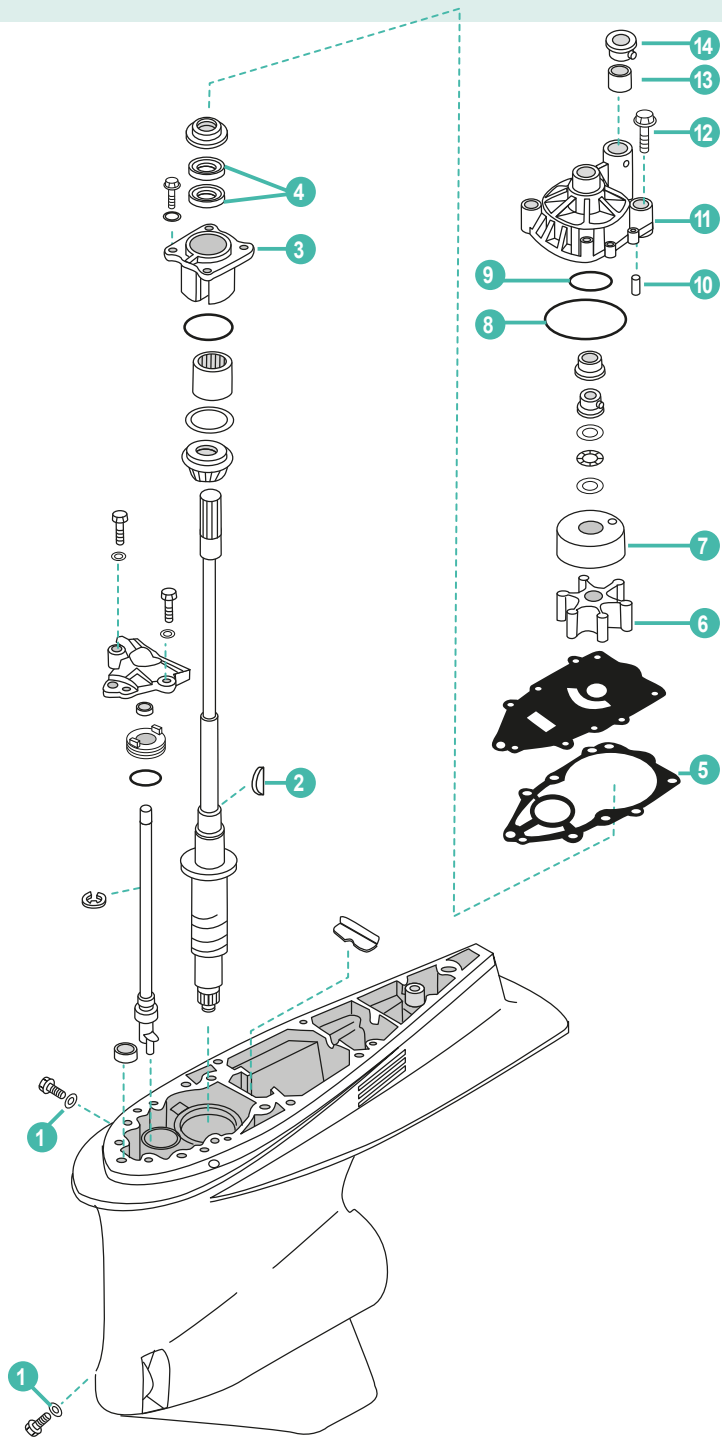

| | REF | OEM | | | | |
|----|--------------------|-----------------|------------------------|-----------------------------|-----------------------|-----------------------|
| 1 | REC90430-08020 | 93430-08020 | JUNTA | GASKET, DRAIN FILL | GUARNIZIONE | JOINT |
| 2 | REC90280-04M05 | 90280-04M05 | CHAVETA | KEY, WOODRUFF | CHIAVETTA | CLAVETTE |
| 3 | REC61A-45331-00-94 | 61A-45331-00-94 | CUERPO COJINETE EJE | DRIVE SHAFT BEARING HOUSING | CORPO CUSCINETTO | PALIER DE ROULEMENT |
| 4 | REC93101-28M16 | 93101-28M16 | RETÉN | OIL SEAL | PARAOILIO | JOINT SPI |
| 5 | REC60X-44315-A0 | 60X-44315-A0 | JUNTA | GASKET | GUARNIZIONE | JOINT |
| 6 | REC6E5-44352-01 | 6E5-44352-01 | IMPULSOR | IMPELLER | GIRANTE | TURBINE |
| 7 | REC61A-44322-02 | 61A-44322-02 | CASQUILLO INOX. | PUMP CUP | BOCCOLA INOX. | INSERT DE POMPE À EAU |
| 8 | REC93210-86M38 | 93210-86M38 | ARO TÓRICO | O-RING | O-RING | JOINT TORIQUE |
| 9 | REC93210-37M67 | 93210-37M67 | ARO TÓRICO | O-RING | O-RING | JOINT TORIQUE |
| 10 | REC93606-12019 | 93606-42019 | PASADOR | PIN, DOWELL | SPINOTTO | PIN |
| 11 | REC61A-44311-00 | 61A-44311-01 | CUERPO BOMBA AGUA | WATER PUMP HOUSING | CORPO POMPA ACQUA | CORPS DE POMPE À EAU |
| 12 | REC90119-08M14 | 90119-08M14 | TORNILLO CON ARANDELA | BOLT W WASHER | VITE | VIS |
| 13 | REC6E5-44365-00 | 6E5-44365-00 | CASQUILLO GOMA | DAMPER | BOCCOLA GOMMA | BAGUE |
| 13 | REC6E5-44312-00 | 6E5-44312-00 | TAPA CUERPO BOMBA AGUA | COVER, WATER PUMP HOUSING | COPERCHIO CORPO POMPA | COUVERCLE |

GUÍA PIEZAS COLA

STERN DRIVE
COMPONENTS GUIDE

GUIDA RICAMBI
PIEDI

GUIDE PIÈCES
D'EMBASE

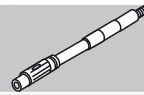

| | | | | | | | | | |
|--|---------|-----------------|-----------------|-----------------|-----------------|-----------------|-----------------|--------------------|---|
| 2B | 1981-03 | REC646-45551-00 | REC646-45560-00 | | | | | | |
| 4A | 1985-87 | REC6E0-45551-00 | REC6E0-45560-00 | REC6E0-45570-00 | REC6E0-45631-00 | | PAF4-03050001 | REC6E0-45511-01 | |
| 4AC | 1987-99 | REC6E0-45551-00 | REC6E0-45560-00 | REC6E0-45570-00 | REC6E0-45631-00 | | PAF4-03050001 | REC6E0-45511-01 | |
| 4AC MHL 4AC MHS | 2001-03 | REC6E0-45551-00 | REC6E0-45560-00 | REC6E0-45570-00 | REC6E0-45631-00 | | PAF4-03050001 | REC6E0-45511-11 | |
| 4AS | 1987-96 | REC6E0-45551-00 | REC6E0-45560-00 | REC6E0-45570-00 | REC6E0-45631-00 | | PAF4-03050001 | REC6E0-45511-01 | |
| 4BC | 1998-99 | REC6E0-45551-00 | REC6E0-45560-00 | REC6E0-45570-00 | REC6E0-45631-00 | | PAF4-03050001 | REC6E0-45511-01 | |
| 4BC | 1999 | REC6E0-45551-00 | REC6E0-45560-00 | REC6E0-45570-00 | REC6E0-45631-00 | | PAF4-03050001 | REC6E0-45511-01 | |
| 4BC MHL 4BC MHS | 2001-03 | REC6E0-45551-00 | REC6E0-45560-00 | REC6E0-45570-00 | REC6E0-45631-00 | | PAF4-03050001 | REC6E0-45511-11 | |
| F4A | 1998-00 | REC6E0-45551-00 | PAF4-03010000 | PAF4-03040000 | | | PAF4-03050001 | REC6E0-45511-11 | |
| F4A MH F4A MHL | 2000 | REC6E0-45551-00 | PAF4-03010000 | PAF4-03040000 | | | PAF4-03050001 | REC6E0-45511-11 | |
| F4A MHS | 2001 | REC6E0-45551-00 | PAF4-03010000 | PAF4-03040000 | | | PAF4-03050001 | REC6E0-45511-11 | |
| 5C | 1985-99 | REC6E0-45551-00 | REC6E0-45560-00 | REC6E0-45570-00 | REC6E0-45631-00 | | PAF4-03050001 | REC6E0-45511-01 | |
| 5C MHL 5C MHS | 2001-06 | REC6E0-45551-00 | REC646-45560-00 | REC6E0-45570-00 | REC6E0-45631-00 | | PAF4-03050001 | REC6E0-45511-11 | |
| 5CS | 1987-96 | REC6E0-45551-00 | REC646-45560-00 | REC6E0-45570-00 | REC6E0-45631-00 | | | REC6E0-45511-01 | |
| 6C | 1990-98 | REC6NO-G5551-00 | REC6NO-G5560-00 | REC6NO-G5571-00 | REC6G1-45631-00 | | REC6G1-45611-01 | | |
| 6C MHL 6C MHS | 2001-06 | REC6NO-G5551-00 | REC6NO-G5560-00 | REC6NO-G5571-00 | REC6G1-45631-00 | | REC6G1-45611-01 | | |
| 6C WHL 6C WHS | 2001 | REC6NO-G5551-00 | REC6NO-G5560-00 | REC6NO-G5571-00 | REC6G1-45631-00 | | REC6G1-45611-01 | | |
| 6D | 1990-98 | REC6NO-G5551-00 | REC6NO-G5560-00 | REC6NO-G5571-00 | REC6G1-45631-00 | | REC6G1-45611-01 | | |
| 6D MHL 6D MHS | 2001-06 | REC6NO-G5551-00 | REC6NO-G5560-00 | REC6NO-G5571-00 | REC6G1-45631-00 | | REC6G1-45611-01 | | |
| 6D WHS | 2001 | REC6NO-G5551-00 | REC6NO-G5560-00 | REC6NO-G5571-00 | REC6G1-45631-00 | | REC6G1-45611-01 | | |
| 8C | 1990-98 | REC6NO-G5551-00 | REC6NO-G5560-00 | REC6NO-G5571-00 | REC6G1-45631-00 | | REC6G1-45611-01 | | |
| 8C MHL 8C MHS | 2001-06 | REC6NO-G5551-00 | REC6NO-G5560-00 | REC6NO-G5571-00 | REC6G1-45631-00 | | REC6G1-45611-01 | | |
| 8C MHX | 2001-03 | REC6NO-G5551-00 | REC6NO-G5560-00 | REC6NO-G5571-00 | REC6G1-45631-00 | | REC6G1-45611-01 | | |
| 8C WHL 8C WHS | 2001-03 | REC6NO-G5551-00 | REC6NO-G5560-00 | REC6NO-G5571-00 | REC6G1-45631-00 | | REC6G1-45611-01 | | |
| E8D | 1997-98 | REC647-45551-00 | REC647-45560-00 | REC647-45570-00 | | | | | |
| E8D MH | 1999 | REC647-45551-00 | REC647-45560-00 | REC647-45570-00 | | | | | |
| F8A | 1986-89 | | | | REC682-45631-00 | REC648-45633-00 | | | |
| F8B | 1985-99 | REC6E7-45551-00 | REC6E7-45560-01 | REC6E7-45570-00 | REC682-45631-00 | REC648-45633-00 | REC683-45611-00 | | |
| F8B E F8B EH F8B MH | 1999 | REC6E7-45551-00 | REC6E7-45560-01 | REC6E7-45570-00 | REC682-45631-00 | REC648-45633-00 | REC683-45611-00 | | |
| FT8D EL | 2001-04 | | | | | REC648-45633-00 | REC683-45611-00 | | REC69G-45510-20 |
| FT8D EPL | 2001-04 | | | | | REC648-45633-00 | REC683-45611-00 | | REC69G-45510-10 |
| FT8D EPX | 2001-02 | | | | | REC648-45633-00 | REC683-45611-00 | | REC69G-45510-10 |
| FT8D EX | 2001-04 | | | | | REC648-45633-00 | REC683-45611-00 | | REC69G-45510-20 |
| FT8D MHL FT8D MHX | 2001-04 | | | | | REC648-45633-00 | REC683-45611-00 | | REC69G-45510-10 |
| 9.9D | 1985-89 | REC6E7-45551-00 | REC6E7-45560-01 | REC6E7-45570-00 | REC682-45631-00 | REC648-45633-00 | REC683-45611-00 | | REC69G-45510-20 |
| 9.9D | 1990-95 | REC6E7-45551-00 | REC6E7-45560-01 | REC6E7-45570-00 | REC682-45631-00 | REC648-45633-00 | REC683-45611-00 | REC683-45361-02-4D | REC6E7-45501-11 REC63V-45510-01 |
| 9.9F | 1995-99 | REC63V-45551-00 | REC6E7-45560-01 | REC6E7-45570-00 | REC682-45631-00 | REC648-45633-00 | REC683-45611-00 | REC683-45361-02-4D | REC63V-45501-10 REC63V-45510-01 REC63V-45510-11 |
| 9.9F MH | 2000 | REC63V-45551-00 | REC6E7-45560-01 | REC6E7-45570-00 | REC682-45631-00 | REC648-45633-00 | REC683-45611-00 | REC683-45361-02-4D | REC63V-45510-11 REC63V-45510-01 REC63V-45510-11 |
| 9.9F MHL 9.9F MHS 9.9F WC 9.9F WH | 2001-06 | REC63V-45551-00 | REC6E7-45560-01 | REC6E7-45570-00 | REC682-45631-00 | REC648-45633-00 | REC683-45611-00 | REC683-45361-02-4D | REC63V-45510-11 REC63V-45510-01 REC63V-45510-11 |
| 9.9F WHL 9.9F WHS | 2001 | REC63V-45551-00 | REC6E7-45560-01 | REC6E7-45570-00 | REC682-45631-00 | REC648-45633-00 | REC683-45611-00 | REC683-45361-02-4D | REC63V-45510-01 REC63V-45510-11 |
| F9.9B | 1985-97 | REC6E7-45551-00 | REC6E7-45560-01 | REC6E7-45570-00 | REC682-45631-00 | REC648-45633-00 | REC683-45611-00 | REC683-45361-02-4D | |
| F9.9B E | 1999 | REC6E7-45551-00 | REC6E7-45560-01 | REC6E7-45570-00 | REC682-45631-00 | REC648-45633-00 | REC683-45611-00 | REC683-45361-02-4D | |
| F9.9B EH | 1999 | REC6E7-45551-00 | REC6E7-45560-01 | REC6E7-45570-00 | REC682-45631-00 | REC648-45633-00 | REC683-45611-00 | REC683-45361-02-4D | |
| F9.9B MH | 1999 | REC6E7-45551-00 | REC6E7-45560-01 | REC6E7-45570-00 | REC682-45631-00 | REC648-45633-00 | REC683-45611-00 | REC683-45361-02-4D | |
| F9.9C | 1998 | REC63V-45551-00 | REC6E7-45560-01 | REC6E7-45570-00 | REC682-45631-00 | REC648-45633-00 | REC683-45611-00 | REC683-45361-02-4D | REC63V-45510-01 REC63V-45510-11 REC63V-45510-01 |
| F9.9C E | 2000 | REC63V-45551-00 | REC6E7-45560-01 | REC6E7-45570-00 | REC682-45631-00 | REC648-45633-00 | REC683-45611-00 | REC683-45361-02-4D | REC63V-45510-11 REC63V-45510-01 REC63V-45510-11 |
| F9.9C EH | 2000 | REC63V-45551-00 | REC6E7-45560-01 | REC6E7-45570-00 | REC682-45631-00 | REC648-45633-00 | REC683-45611-00 | REC683-45361-02-4D | REC63V-45510-11 REC63V-45510-01 REC63V-45510-11 |
| F9.9C EL F9.9C ES | 2001-06 | REC63V-45551-00 | REC6E7-45560-01 | REC6E7-45570-00 | REC682-45631-00 | REC648-45633-00 | REC683-45611-00 | REC683-45361-02-4D | REC63V-45510-11 REC63V-45510-01 REC63V-45510-11 |
| F9.9C MH | 2000 | REC63V-45551-00 | REC6E7-45560-01 | REC6E7-45570-00 | REC682-45631-00 | REC648-45633-00 | REC683-45611-00 | REC683-45361-02-4D | REC63V-45510-11 REC63V-45510-01 REC63V-45510-11 |
| F9.9C MHL F9.9C MHS | 2001-06 | REC63V-45551-00 | REC6E7-45560-01 | REC6E7-45570-00 | REC682-45631-00 | REC648-45633-00 | REC683-45611-00 | REC683-45361-02-4D | REC63V-45510-11 REC63V-45510-01 REC63V-45510-11 |
| FT9.9A | 1999 | | | | REC682-45631-00 | REC648-45633-00 | | | |
| FT9.9D | 1999 | | | | REC682-45631-00 | REC648-45633-00 | REC683-45611-00 | | |
| FT9.9D E FT9.9D EH | 2000 | | | | REC682-45631-00 | REC648-45633-00 | REC683-45611-00 | | |
| FT9.9D EHL FT9.9D EHX | 2001 | | | | REC682-45631-00 | REC648-45633-00 | REC683-45611-00 | | |

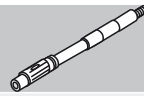

| | | | | | | | | | |
|-----------|---------|-----------------|-----------------|--------------------|-----------------|-----------------|-----------------|--------------------|-----------------|
| 25D MH | 1998 | REC689-45551-00 | REC689-45560-00 | REC689-45571-00-00 | REC664-45631-00 | REC648-45633-00 | | PAF25-04070000 | REC689-45501-10 |
| 25D MHL | | | | | | | | | |
| 25D MHS | 2001 | REC689-45551-00 | REC689-45560-00 | REC689-45571-00-00 | REC664-45631-00 | REC648-45633-00 | | PAF25-04070000 | |
| 25J | 1987-91 | | | | | REC648-45633-00 | | PAF25-04070000 | |
| 25J | 1992-00 | | | | | REC648-45633-00 | | PAF25-04070000 | |
| 25N | 1988 | | | | | REC648-45633-00 | REC6L2-45611-00 | PAF25-04070000 | |
| 25N MHOL | | | | | | | | | |
| 25N MHOS | 2001-06 | | | | | REC648-45633-00 | REC6L2-45611-00 | PAF25-04070000 | |
| 25N WOL | | | | | | | | | |
| 25N WOS | 2001-03 | | | | | REC648-45633-00 | REC6L2-45611-00 | PAF25-04070000 | |
| 25Q | 1988-94 | REC6H4-45551-00 | REC6H4-45560-00 | REC6H4-45570-00 | REC663-45631-00 | REC648-45633-00 | REC679-45611-00 | PAF25-04070000 | |
| 25V | 1996 | REC61N-45551-00 | REC61N-45560-10 | REC61N-45570-00 | REC664-45631-00 | REC648-45633-00 | REC6L2-45611-00 | PAF25-04070000 | REC61N-45510-10 |
| 25V | 1996-98 | REC61N-45551-00 | REC61N-45560-10 | REC61N-45570-00 | REC664-45631-00 | REC648-45633-00 | REC6L2-45611-00 | PAF25-04070000 | REC61N-45510-10 |
| 25V MHL | | | | | | | | | |
| 25V MHS | 2001 | REC61N-45551-00 | REC61N-45560-10 | REC61N-45570-00 | REC664-45631-00 | REC648-45633-00 | REC6L2-45611-00 | PAF25-04070000 | REC61N-45510-10 |
| 25V WCS | 2001 | REC61N-45551-00 | REC61N-45560-10 | REC61N-45570-00 | REC664-45631-00 | REC648-45633-00 | REC6L2-45611-00 | PAF25-04070000 | REC61N-45510-10 |
| F25A E | | | | | | | | | |
| F25A EH | 2000 | REC61N-45551-00 | REC61N-45560-10 | REC61N-45570-00 | REC664-45631-00 | REC648-45633-00 | REC6L2-45611-00 | PAF25-04070000 | REC61N-45510-10 |
| F25A EHL | 2001-02 | REC61N-45551-00 | REC61N-45560-10 | REC61N-45570-00 | REC664-45631-00 | REC648-45633-00 | REC6L2-45611-00 | PAF25-04070000 | REC61N-45510-10 |
| F25A EHS | 2001 | REC61N-45551-00 | REC61N-45560-10 | REC61N-45570-00 | REC664-45631-00 | REC648-45633-00 | REC6L2-45611-00 | PAF25-04070000 | REC61N-45510-10 |
| F25A EL | | | | | | | | | |
| F25A ES | 2001-06 | REC61N-45551-00 | REC61N-45560-10 | REC61N-45570-00 | REC664-45631-00 | REC648-45633-00 | REC6L2-45611-00 | PAF25-04070000 | REC61N-45510-10 |
| F25A ET | 2000 | REC61N-45551-00 | REC61N-45560-10 | REC61N-45570-00 | REC664-45631-00 | REC648-45633-00 | REC6L2-45611-00 | PAF25-04070000 | REC61N-45510-10 |
| F25A ETL | 2001-06 | REC61N-45551-00 | REC61N-45560-10 | REC61N-45570-00 | REC664-45631-00 | REC648-45633-00 | REC6L2-45611-00 | PAF25-04070000 | REC61N-45510-10 |
| F25A MH | 2000 | REC61N-45551-00 | REC61N-45560-10 | REC61N-45570-00 | REC664-45631-00 | REC648-45633-00 | REC6L2-45611-00 | PAF25-04070000 | REC61N-45510-10 |
| F25A MHL | | | | | | | | | |
| F25A MHS | 2001-06 | REC61N-45551-00 | REC61N-45560-10 | REC61N-45570-00 | REC664-45631-00 | REC648-45633-00 | REC6L2-45611-00 | PAF25-04070000 | REC61N-45510-10 |
| FT25B ED | 2000 | | | | | | REC66T-45611-00 | REC63D-45361-02-4D | |
| FT25B EDL | | | | | | | | | |
| FT25B EDX | 2001-02 | | | | | | REC66T-45611-00 | REC63D-45361-02-4D | |
| FT25B ET | 2000 | | | | | | REC66T-45611-00 | REC63D-45361-02-4D | |
| FT25B ETL | 2001-06 | | | | | | REC66T-45611-00 | REC63D-45361-02-4D | |
| FT25B ETX | 2001-02 | | | | | | REC66T-45611-00 | REC63D-45361-02-4D | |
| 30A | 1985 | REC689-45551-00 | REC689-45560-00 | REC689-45571-00-00 | REC664-45631-00 | REC648-45633-00 | REC689-45611-00 | | |
| 30A M | 1990-92 | REC689-45551-00 | REC689-45560-00 | REC689-45571-00-00 | REC664-45631-00 | REC648-45633-00 | REC689-45611-00 | | REC689-45501-10 |
| 30D | 1986-00 | | | | | REC648-45633-00 | | | |
| 30D EOL | | | | | | | | | |
| 30D EOS | | | | | | | | | |
| 30D ETOL | 2001-06 | | | | | REC648-45633-00 | | | |
| 30D MHOL | | | | | | | | | |
| 30D MHOS | | | | | | | | | |
| 30D OL | 2001-03 | | | | | REC648-45633-00 | | | |
| 30D EOS | 2001-06 | | | | | REC648-45633-00 | | | |
| 30G | 1996 | REC61N-45551-00 | REC61N-45560-10 | REC61N-45570-00 | REC664-45631-00 | REC648-45633-00 | REC6L2-45611-00 | PAF25-04070000 | REC61N-45510-10 |
| 30G | 1996-98 | REC61N-45551-00 | REC61N-45560-10 | REC61N-45570-00 | REC664-45631-00 | REC648-45633-00 | REC6L2-45611-00 | PAF25-04070000 | REC61N-45510-10 |
| 30G MHS | | | | | | | | | |
| 30G WCS | 2001 | REC61N-45551-00 | REC61N-45560-10 | REC61N-45570-00 | | REC648-45633-00 | REC6L2-45611-00 | PAF25-04070000 | REC61N-45510-10 |
| 30H MHS | 2001-02 | REC61N-45551-00 | REC61N-45560-10 | REC61N-45570-00 | REC664-45631-00 | REC648-45633-00 | REC6L2-45611-00 | PAF25-04070000 | REC61N-45510-10 |
| 30H WCS | 2001-02 | REC61N-45551-00 | REC61N-45560-10 | REC61N-45570-00 | REC664-45631-00 | REC648-45633-00 | REC6L2-45611-00 | PAF25-04070000 | REC61N-45510-10 |
| F30A ETL | 2001-06 | REC66T-45551-00 | REC66T-45560-00 | REC66T-45571-00 | REC66T-45631-00 | | REC66T-45611-00 | REC63D-45361-02-4D | REC67C-45501-10 |
| F30A ETS | 2001-06 | REC66T-45551-00 | REC66T-45560-00 | REC66T-45571-00 | REC66T-45631-00 | | REC66T-45611-00 | REC63D-45361-02-4D | REC67C-45501-10 |
| F30A MHDL | 2001-06 | REC66T-45551-00 | REC66T-45560-00 | REC66T-45571-00 | REC66T-45631-00 | | REC66T-45611-00 | REC63D-45361-02-4D | REC67C-45501-10 |
| F30A MHDS | 2001-06 | REC66T-45551-00 | REC66T-45560-00 | REC66T-45571-00 | REC66T-45631-00 | | REC66T-45611-00 | REC63D-45361-02-4D | REC67C-45501-10 |
| E40G WH | 2003 | REC6F5-45551-00 | REC6F5-45560-00 | REC6F5-45570-00 | REC663-45631-00 | REC663-45633-00 | REC6F6-45611-00 | REC63D-45361-02-4D | REC676-45501-10 |
| 40H | 1985-90 | REC6H4-45551-00 | REC6H4-45560-00 | REC6H4-45570-00 | REC6H4-45631-00 | REC663-45633-00 | REC679-45611-00 | | |
| 40H | 1991-93 | REC6H4-45551-00 | REC6H4-45560-00 | REC6H4-45570-00 | REC6H4-45631-00 | REC663-45633-00 | REC679-45611-00 | | |
| 40Q | 1993-98 | REC6H9-45551-00 | REC679-45560-00 | REC677-41112-A0 | REC663-45631-00 | REC663-45633-00 | REC679-45611-00 | | REC679-45501-10 |
| 40Q E | 1992 | REC6H9-45551-00 | REC679-45560-00 | REC677-41112-A0 | REC663-45631-00 | REC663-45633-00 | REC679-45611-00 | | REC679-45501-10 |
| 40Q M | 1990-92 | REC6H9-45551-00 | REC679-45560-00 | REC677-41112-A0 | REC663-45631-00 | REC663-45633-00 | REC679-45611-00 | | REC679-45501-10 |
| 40R MHO | 2000 | REC6H4-45551-00 | REC6H4-45560-00 | REC6H4-45570-00 | | REC663-45633-00 | | REC63D-45361-02-4D | |
| 40R ROS | 2001 | REC6H4-45551-00 | REC6H4-45560-00 | REC6H4-45570-00 | | REC663-45633-00 | | REC63D-45361-02-4D | |
| 40V | 1995-98 | REC6H4-45551-00 | REC6H4-45560-00 | REC6H4-45570-00 | | REC663-45633-00 | | REC63D-45361-02-4D | |
| 40V EO | 2000 | REC6H4-45551-00 | REC6H4-45560-00 | REC6H4-45570-00 | | REC663-45633-00 | | REC63D-45361-02-4D | |
| 40V EOL | | | | | | | | | |
| 40V EOS | 2001-06 | REC6H4-45551-00 | REC6H4-45560-00 | REC6H4-45570-00 | | REC663-45633-00 | | REC63D-45361-02-4D | |
| 40V ETO | 2000 | REC6H4-45551-00 | REC6H4-45560-00 | REC6H4-45570-00 | | REC663-45633-00 | | REC63D-45361-02-4D | |
| 40V ETOL | | | | | | | | | |
| 40V ETOS | 2001-03 | REC6H4-45551-00 | REC6H4-45560-00 | REC6H4-45570-00 | | REC663-45633-00 | | REC63D-45361-02-4D | |
| 40V MHOL | | | | | | | | | |
| 40V MHOS | 2001-06 | REC6H4-45551-00 | REC6H4-45560-00 | REC6H4-45570-00 | | REC663-45633-00 | | REC63D-45361-02-4D | |
| 40V MO | 2000 | REC6H4-45551-00 | REC6H4-45560-00 | REC6H4-45570-00 | | REC663-45633-00 | | REC63D-45361-02-4D | |
| 40X | 1998 | REC66T-45551-00 | REC66T-45560-00 | REC66T-45571-00 | REC66T-45631-00 | REC663-45633-00 | REC66T-45611-00 | REC63D-45361-02-4D | REC66T-45501-10 |
| 40X MH | 2000 | REC66T-45551-00 | REC66T-45560-00 | REC66T-45571-00 | REC66T-45631-00 | REC663-45633-00 | REC66T-45611-00 | REC63D-45361-02-4D | REC66T-45501-10 |
| 40X MHL | 2001-06 | REC66T-45551-00 | REC66T-45560-00 | REC66T-45571-00 | REC66T-45631-00 | REC663-45633-00 | REC66T-45611-00 | REC63D-45361-02-4D | REC66T-45501-10 |
| 40X MHS | 2001-02 | REC66T-45551-00 | REC66T-45560-00 | REC66T-45571-00 | REC66T-45631-00 | REC663-45633-00 | REC66T-45611-00 | REC63D-45361-02-4D | REC66T-45501-01 |
| 40X W | 2000 | REC66T-45551-00 | REC66T-45560-00 | REC66T-45571-00 | REC66T-45631-00 | REC663-45633-00 | REC66T-45611-00 | REC63D-45361-02-4D | REC66T-45501-10 |
| 40X WL | | | | | | | | | |
| 40X WS | 2001 | REC66T-45551-00 | REC66T-45560-00 | REC66T-45571-00 | REC66T-45631-00 | REC663-45633-00 | REC66T-45611-00 | REC63D-45361-02-4D | REC66T-45501-10 |

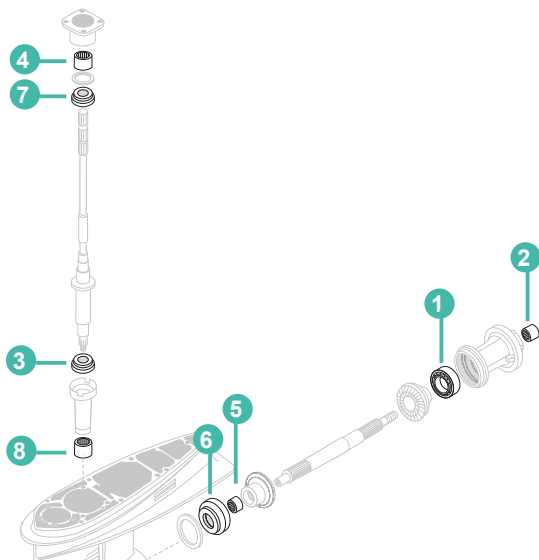

GUÍA RODAMIENTOS STERN DRIVE BEARING GUIDA CUSCINETTI GUIDE ROULEMENTS
APPLICATION TRANSMISSIONE D'EMBASE

| | | 1 | 2 | 3 | 4 | 5 | 6 | 7 | 8 |
|---------------------------------|---------|----------------|---|----------------|----------------|---|----------------|---|----------------|
| F8A | 1986-89 | | | | REC93315-317U2 | | REC93332-00005 | | REC93306-00501 |
| F8B | 1985-99 | REC93315-314V8 | | REC93341-214U1 | REC93315-317U2 | | REC93332-00005 | | REC93306-00501 |
| F8B E F8B EH F8B MH | 1999 | REC93315-314V8 | | REC93341-41414 | REC93315-317U2 | | REC93332-00005 | | REC93306-00501 |
| FT8D EL FT8D EPL | 2001-04 | REC93315-314V8 | | REC93341-41414 | REC93315-317U2 | | REC93332-00005 | | REC93306-00501 |
| FT8D EPX | 2001-02 | REC93315-314V8 | | REC93341-41414 | REC93315-317U2 | | REC93332-00005 | | REC93306-00501 |
| FT8D EX FT8D MHL FT8D MHX | 2001-04 | REC93315-314V8 | | REC93341-41414 | REC93315-317U2 | | REC93332-00005 | | REC93306-00501 |
| 9.9D | 1985-89 | REC93315-314V8 | | REC93341-41414 | REC93315-317U2 | | REC93332-00005 | | REC93306-00501 |
| 9.9D | 1985-95 | REC93315-314V8 | | REC93341-214U1 | REC93315-317U2 | | REC93332-00005 | | REC93306-00501 |
| 9.9D | 1990-95 | REC93315-314V8 | | REC93341-41414 | REC93315-317U2 | | REC93332-00005 | | REC93306-00519 |
| 9.9F | 1995-99 | REC93315-314V8 | | REC93341-41414 | REC93315-317U2 | | REC93332-00005 | | REC93306-00501 |
| 9.9F MH | 2000 | REC93315-314V8 | | REC93341-41414 | REC93315-317U2 | | REC93332-00005 | | REC93306-00501 |
| 9.9F MHL 9.9F MHS | 2001-06 | REC93315-314V8 | | REC93341-41414 | REC93315-317U2 | | REC93332-00005 | | REC93306-00501 |
| 9.9F WC 9.9F WH | 2000 | REC93315-314V8 | | REC93341-41414 | REC93315-317U2 | | REC93332-00005 | | REC93306-00501 |
| 9.9F WHL 9.9F WHS | 2001 | REC93315-314V8 | | REC93341-41414 | REC93315-317U2 | | REC93332-00005 | | REC93306-00501 |
| F9.9B | 1985-97 | REC93315-314V8 | | REC93341-214U1 | REC93315-317U2 | | REC93332-00005 | | REC93306-00501 |
| F9.9B E F9.9B EH F9.9B MH | 1999 | REC93315-314V8 | | REC93341-41414 | REC93315-317U2 | | REC93332-00005 | | REC93306-00501 |
| F9.9C | 1998 | REC93315-314V8 | | REC93341-41414 | REC93315-317U2 | | REC93332-00005 | | REC93306-00501 |
| F9.9C E F9.9C EH | 2000 | REC93315-314V8 | | REC93341-41414 | REC93315-317U2 | | REC93332-00005 | | REC93306-00501 |
| F9.9C EL F9.9C ES | 2001-06 | REC93315-314V8 | | REC93341-41414 | REC93315-317U2 | | REC93332-00005 | | REC93306-00501 |
| F9.9C MH | 2000 | REC93315-314V8 | | REC93341-41414 | REC93315-317U2 | | REC93332-00005 | | REC93306-00501 |
| F9.9C MHL F9.9C MHS | 2001-06 | REC93315-314V8 | | REC93341-41414 | REC93315-317U2 | | REC93332-00005 | | REC93306-00501 |
| FT9.9A | 1999 | | | | REC93315-317U2 | | REC93332-00005 | | REC93306-00501 |
| FT9.9D | 1999 | REC93315-314V8 | | REC93341-41414 | REC93315-317U2 | | REC93332-00005 | | REC93306-00501 |
| FT9.9D E FT9.9D EH | 2000 | REC93315-314V8 | | REC93341-41414 | REC93315-317U2 | | REC93332-00005 | | REC93306-00501 |
| FT9.9D EHL FT9.9D EHX | 2001 | REC93315-314V8 | | REC93341-41414 | REC93315-317U2 | | REC93332-00005 | | REC93306-00501 |
| FT9.9D EL | 2001-06 | REC93315-314V8 | | REC93341-41414 | REC93315-317U2 | | REC93332-00005 | | REC93306-00501 |
| FT9.9D EP | 2000 | REC93315-314V8 | | REC93341-41414 | REC93315-317U2 | | REC93332-00005 | | REC93306-00501 |
| FT9.9D EPL FT9.9D EPX | 2001-02 | REC93315-314V8 | | REC93341-41414 | REC93315-317U2 | | REC93332-00005 | | REC93306-00501 |
| FT9.9D ES | 2001 | REC93315-314V8 | | REC93341-41414 | REC93315-317U2 | | REC93332-00005 | | REC93306-00501 |
| FT9.9D EX | 2001-06 | REC93315-314V8 | | REC93341-41414 | REC93315-317U2 | | REC93332-00005 | | REC93306-00501 |
| FT9.9D MH | 2000 | REC93315-314V8 | | REC93341-41414 | REC93315-317U2 | | REC93332-00005 | | REC93306-00501 |
| FT9.9D MHL | 2001-06 | REC93315-314V8 | | REC93341-41414 | REC93315-317U2 | | REC93332-00005 | | REC93306-00501 |
| FT9.9D MHX | 2001 | REC93315-314V8 | | REC93341-41414 | REC93315-317U2 | | REC93332-00005 | | REC93306-00501 |
| 13.5A | 1999 | REC93315-314V8 | | REC93341-41414 | REC93315-317U2 | | REC93332-00005 | | REC93306-00501 |
| 13.5A MH | 2000 | REC93315-314V8 | | REC93341-41414 | REC93315-317U2 | | REC93332-00005 | | REC93306-00501 |
| 13.5A MHL 13.5A MHS | 2001-04 | REC93315-314V8 | | REC93341-41414 | REC93315-317U2 | | REC93332-00005 | | REC93306-00501 |
| 13.5A WH | 2000 | REC93315-314V8 | | REC93341-41414 | REC93315-317U2 | | REC93332-00005 | | REC93306-00501 |
| F13.5A EHL | 2005-06 | REC93315-314V8 | | | REC93315-317U2 | | REC93332-00005 | | REC93306-00501 |
| F13.5A EPL | 2005 | REC93315-314V8 | | REC93341-41414 | REC93315-317U2 | | REC93332-00005 | | REC93306-00501 |
| F13.5A EPS | 2005 | REC93315-314V8 | | | REC93315-317U2 | | REC93332-00005 | | REC93306-00501 |
| F13.5A MH | 2001 | REC93315-314V8 | | | REC93315-317U2 | | REC93332-00005 | | REC93306-00501 |
| F13.5A MHL F13.5A MHS | 2002-06 | REC93315-314V8 | | REC93341-41414 | REC93315-317U2 | | REC93332-00005 | | REC93306-00501 |

| | | 1 | 2 | 3 | 4 | 5 | 6 | 7 | 8 |
|--|---------|----------------|----------------|----------------|----------------|---|----------------|---|----------------|
| 15D | 1985-95 | REC93315-314V8 | | REC93341-214U1 | REC93315-317U2 | | REC93332-00005 | | REC93306-00501 |
| 15D | 1990-95 | REC93315-314V8 | | REC93341-41414 | REC93315-317U2 | | REC93332-00005 | | REC93306-00501 |
| 15F | 1995-99 | REC93315-314V8 | | REC93341-41414 | REC93315-317U2 | | REC93332-00005 | | REC93306-00501 |
| 15F MH | 2000 | REC93315-314V8 | | REC93341-41414 | REC93315-317U2 | | REC93332-00005 | | REC93306-00501 |
| 15F MHL 15F MHS | 2001-06 | REC93315-314V8 | | REC93341-41414 | REC93315-317U2 | | REC93332-00005 | | REC93306-00501 |
| 15F WC | 2000 | REC93315-314V8 | | REC93341-41414 | REC93315-317U2 | | REC93332-00005 | | REC93306-00501 |
| 15F WCL | 2001-03 | REC93315-314V8 | | REC93341-41414 | REC93315-317U2 | | REC93332-00005 | | REC93306-00501 |
| 15F WCS | 2001-02 | REC93315-314V8 | | REC93341-41414 | REC93315-317U2 | | REC93332-00005 | | REC93306-00501 |
| F15A | 1998 | REC93315-314V8 | | REC93341-41414 | REC93315-317U2 | | REC93332-00005 | | REC93306-00501 |
| F15A E F15A EH F15A EHS F15A EHL F15A EL | 1998-00 | REC93315-314V8 | | REC93341-41414 | REC93315-317U2 | | REC93332-00005 | | REC93306-00501 |
| F15A EP | 2001-06 | REC93315-314V8 | | REC93341-41414 | REC93315-317U2 | | REC93332-00005 | | REC93306-00501 |
| F15A EPL | 2001-06 | REC93315-314V8 | | REC93341-41414 | REC93315-317U2 | | REC93332-00005 | | REC93306-00501 |
| F15A EPS | 2001-06 | REC93315-314V8 | | REC93341-41414 | REC93315-317U2 | | REC93332-00005 | | REC93306-00501 |
| F15A ES | 2001-06 | REC93315-314V8 | | REC93341-41414 | REC93315-317U2 | | REC93332-00005 | | REC93306-00501 |
| F15A MH | 1998-00 | REC93315-314V8 | | REC93341-41414 | REC93315-317U2 | | REC93332-00005 | | REC93306-00501 |
| F15A MHL | 2001-06 | REC93315-314V8 | | REC93341-41414 | REC93315-317U2 | | REC93332-00005 | | REC93306-00501 |
| F15A MHS | 2001-06 | REC93315-314V8 | | REC93341-41414 | REC93315-317U2 | | REC93332-00005 | | REC93306-00501 |
| 20C | 1985-93 | REC93315-017U4 | | | REC93315-22004 | | REC93332-00005 | | REC93306-00612 |
| 20C M | 1990-97 | REC93315-017U4 | | | REC93315-22004 | | REC93332-00005 | | REC93306-00612 |
| 20C MH | 1998 | REC93315-017U4 | | | REC93315-22004 | | REC93332-00005 | | REC93306-00612 |
| 20C MHL 20C MHS | 2001-02 | REC93315-017U4 | | | REC93315-22004 | | REC93332-00005 | | REC93306-00612 |
| 20D | 1988 | | REC93315-22004 | | REC93315-22004 | | REC93332-00005 | | REC93306-00612 |
| 20D MHOL 20D MHOS | 2001-06 | | REC93315-22004 | | REC93315-22004 | | REC93332-00005 | | REC93306-00612 |
| 20D WOL 20D WOS | 2001 | | REC93315-22004 | | REC93315-22004 | | REC93332-00005 | | REC93306-00612 |
| F20A | 1998-99 | REC93315-220V7 | REC93332-000W5 | | REC93315-22004 | | REC93332-00005 | | REC93306-00612 |
| F20A E | 2000 | | REC93332-000W5 | | REC93315-22004 | | REC93332-00005 | | REC93306-00612 |
| F20A EH | 2000 | REC93315-220V7 | REC93332-000W5 | | REC93315-22004 | | REC93332-00005 | | REC93306-00612 |
| F20A EHS | 2001 | REC93315-220V7 | | | REC93315-22004 | | REC93332-00005 | | REC93306-00612 |
| F20A EL | 2001 | REC93315-220V7 | REC93332-000W5 | | REC93315-22004 | | REC93332-00005 | | REC93306-00612 |
| F20A ES | 2001-06 | REC93315-220V7 | REC93332-000W5 | | REC93315-22004 | | REC93332-00005 | | REC93306-00612 |
| F20A ET | 2000 | REC93315-220V7 | REC93332-000W5 | | REC93315-22004 | | REC93332-00005 | | REC93306-00612 |
| F20A ETL | 2003-06 | REC93315-220V7 | REC93332-000W5 | | REC93315-22004 | | REC93332-00005 | | REC93306-00612 |
| F20A MH F20A MHL | 2000 | REC93315-220V7 | REC93332-000W5 | | REC93315-22004 | | REC93332-00005 | | REC93306-00612 |
| F20A MHS | 2001 | REC93315-220V7 | REC93332-000W5 | | REC93315-22004 | | REC93332-00005 | | REC93306-00612 |
| 25B | 1994-95 | REC93315-325V1 | REC93332-00001 | | REC93317-22204 | | REC93332-000W7 | | REC93306-00702 |
| 25B MHL 25B MHS | 2001-06 | REC93315-220V7 | REC93332-000W5 | | REC93315-22004 | | REC93332-00005 | | REC93306-00612 |
| 25B WCS | 2001-02 | REC93315-220V7 | REC93332-000W5 | | REC93315-22004 | | REC93332-00005 | | REC93306-00612 |
| 25D | 1985-87 | REC93315-017U4 | | | REC93315-22004 | | REC93332-00005 | | REC93306-00612 |
| 25D M | 1990-97 | REC93315-017U4 | | | REC93315-22004 | | REC93332-00005 | | REC93306-00612 |
| 25D MH | 1998 | REC93315-017U4 | | | REC93315-22004 | | REC93332-00005 | | REC93306-00612 |
| 25D MHL 25D MHS | 2001 | REC93315-017U4 | | | REC93315-22004 | | REC93332-00005 | | REC93306-00612 |
| 25J | 1987-91 | REC93315-220V7 | REC93332-00023 | | REC93315-22004 | | | | REC93306-00612 |
| 25J | 1992-00 | | REC93332-00001 | | | | | | REC93306-00612 |
| 25N | 1988 | | REC93315-22004 | | REC93315-22004 | | REC93332-00005 | | REC93306-00612 |
| 25N MHOL 25N MHOS | 2001-06 | | REC93315-22004 | | REC93315-22004 | | REC93332-00005 | | REC93306-00612 |
| 25N WOL | 2001-03 | | REC93315-22004 | | REC93315-22004 | | REC93332-00005 | | REC93306-00612 |
| 25N WOS | 2001-03 | | | | REC93315-22004 | | REC93332-00005 | | REC93306-00612 |
| 25Q | 1988-91 | REC93315-32224 | REC93332-00023 | | | | | | REC93306-00612 |
| 25Q | 1990-94 | REC93315-32224 | REC93332-00001 | | REC93317-22204 | | | | REC93306-00702 |
| 25V | 1996-98 | REC93315-220V7 | REC93332-000W5 | | REC93315-22004 | | REC93332-00005 | | REC93306-00612 |
| 25V MHL 25V MHS 25V WVS | 2001 | REC93315-220V7 | REC93332-000W5 | | REC93315-22004 | | REC93332-00005 | | REC93306-00612 |
| F25A E F25A EH | 2000 | REC93315-220V7 | REC93332-000W5 | | REC93315-22004 | | REC93332-00005 | | REC93306-00612 |
| F25A EHL | 2001-02 | REC93315-220V7 | REC93332-000W5 | | REC93315-22004 | | REC93332-00005 | | REC93306-00612 |
| F25A EHS | 2001 | REC93315-220V7 | REC93332-000W5 | | REC93315-22004 | | REC93332-00005 | | REC93306-00612 |
| F25A EL F25A ES | 2001-06 | REC93315-220V7 | REC93332-000W5 | | REC93315-22004 | | REC93332-00005 | | REC93306-00612 |
| F25A ET | 2000 | REC93315-220V7 | REC93332-000W5 | | REC93315-22004 | | REC93332-00005 | | REC93306-00612 |
| F25A ETL | 2001-06 | REC93315-220V7 | REC93332-000W5 | | REC93317-22204 | | REC93332-00005 | | REC93306-00612 |
| F25A MH | 2000 | REC93315-220V7 | REC93332-000W5 | | REC93315-22004 | | REC93332-00005 | | REC93306-00612 |
| F25A MHL F25A MHS | 2001-06 | REC93315-220V7 | REC93332-000W5 | | REC93315-22004 | | REC93332-00005 | | REC93306-00612 |
| FT25B ED | 2000 | REC93315-32224 | REC93332-00001 | | REC93317-22204 | | REC93332-00003 | | REC93306-001U1 |
| FT25B EDL FT25B EDX | 2001-02 | REC93315-32224 | REC93332-00001 | | REC93317-22204 | | REC93332-00003 | | REC93306-001U1 |

| | | 1 | 2 | 3 | 4 | 5 | 6 | 7 | 8 |
|-----------|---------|----------------|----------------|----------------|----------------|---|----------------|---|----------------|
| FT25B ET | 2000 | REC93315-32224 | REC93332-00001 | | REC93317-22204 | | REC93332-00003 | | REC93306-001U1 |
| FT25B ETL | 2001-06 | REC93315-32224 | REC93332-00001 | | REC93317-22204 | | REC93332-00003 | | REC93306-001U1 |
| FT25B ETX | 2001-02 | REC93315-32224 | REC93332-00001 | | REC93317-22204 | | REC93332-00003 | | REC93306-001U1 |
| 30A | 1985 | REC93315-017U4 | | | REC93315-22004 | | REC93332-00005 | | REC93306-00612 |
| 30A M | 1990-92 | REC93315-017U4 | | REC93315-22004 | REC93315-22004 | | REC93332-00005 | | REC93306-00612 |
| 30D | 1986-00 | REC93315-220V7 | REC93332-00023 | | REC93315-22004 | | | | REC93306-00612 |
| 30D EOL | | | | | | | | | |
| 30D EOL | 2001-06 | REC93315-220V7 | REC93332-00001 | | REC93315-22004 | | | | REC93306-00612 |
| 30D ETOL | | | | | | | | | |
| 30D MHOL | | | | | | | | | |
| 30D MHOS | 2001-06 | REC93315-220V7 | REC93332-00001 | | REC93315-22004 | | | | REC93306-00612 |
| 30D OL | 2001-03 | | REC93332-00001 | | REC93315-22004 | | | | REC93306-00612 |
| 30D EOS | 2001-06 | | REC93332-00001 | | REC93315-22004 | | | | REC93306-00612 |
| 30G | 1996-98 | REC93315-220V7 | REC93332-000W5 | | REC93315-22004 | | REC93332-00005 | | REC93306-00612 |
| 30G MHS | | | | | | | | | |
| 30G WCS | 2001 | REC93315-220V7 | REC93332-000W5 | | REC93315-22004 | | REC93332-00005 | | REC93306-00612 |
| 30H MHS | | | | | | | | | |
| 30H WCS | 2001-02 | REC93315-220V7 | REC93332-000W5 | | REC93315-22004 | | REC93332-00005 | | REC93306-00612 |
| F30A ETL | | | | | | | | | |
| F30A ETS | 2001-06 | REC93315-32224 | REC93332-00001 | | REC93317-22204 | | REC93332-00003 | | REC93306-001U1 |
| F30A MHDL | | | | | | | | | |
| F30A MHDS | 2001-06 | REC93315-32224 | REC93332-00001 | | REC93317-22204 | | REC93332-00003 | | REC93306-001U1 |
| 40G WH | 2003 | REC93315-324U1 | REC93315-217U0 | REC93390-000U0 | | | REC93332-000U0 | | |
| 40H | 1985-90 | REC93315-32224 | REC93332-00023 | | REC93317-22204 | | | | REC93306-00702 |
| 40H | 1991-93 | REC93315-32224 | REC93332-00001 | | REC93317-22204 | | | | REC93306-00702 |
| 40Q | 1993 | REC93315-32224 | REC93332-00001 | | REC93317-22204 | | REC93332-00003 | | REC93306-00702 |
| 40Q E | 1992 | REC93315-32224 | REC93332-00023 | | REC93317-22204 | | REC93332-00003 | | REC93306-00702 |
| 40Q M | 1990 | REC93315-32224 | REC93332-00023 | | REC93317-22204 | | REC93332-00003 | | REC93306-00702 |
| 40R MHO | 2000 | REC93315-32224 | REC93332-00001 | | REC93317-22204 | | REC93332-00003 | | REC93306-001U1 |
| 40R ROS | 2001 | REC93315-32224 | REC93332-00001 | | REC93317-22204 | | REC93332-00003 | | REC93306-001U1 |
| 40V | 1995-98 | REC93315-32224 | REC93332-00001 | | REC93317-22204 | | REC93332-00003 | | REC93306-001U1 |
| 40V EO | 2000 | REC93315-32224 | REC93332-00001 | | REC93317-22204 | | REC93332-00003 | | REC93306-001U1 |
| 40V EOL | | | | | | | | | |
| 40V EOS | 2001-06 | REC93315-32224 | REC93332-00001 | | REC93317-22204 | | REC93332-00003 | | REC93306-001U1 |
| 40V ETO | 2000 | REC93315-32224 | REC93332-00001 | | REC93317-22204 | | REC93332-00003 | | REC93306-001U1 |
| 40V ETOL | | | | | | | | | |
| 40V ETOS | 2001-03 | REC93315-32224 | REC93332-00001 | | REC93317-22204 | | REC93332-00003 | | REC93306-001U1 |
| 40V MHOL | | | | | | | | | |
| 40V MHOS | 2001-06 | REC93315-32224 | REC93332-00001 | | REC93317-22204 | | REC93332-00003 | | REC93306-001U1 |
| 40V MO | 2000 | REC93315-32224 | REC93332-00001 | | REC93317-22204 | | REC93332-00003 | | REC93306-001U1 |
| 40X | 1998 | REC93315-32224 | REC93332-00001 | | REC93317-22204 | | REC93332-00003 | | REC93306-001U1 |
| 40X MH | 2000 | REC93315-32224 | REC93332-00001 | | REC93317-22204 | | REC93332-00003 | | REC93306-001U1 |
| 40X MHL | 2001-06 | REC93315-32224 | REC93332-00001 | | REC93317-22204 | | REC93332-00003 | | REC93306-001U1 |
| 40X MHS | 2001-02 | REC93315-32224 | REC93332-00001 | | REC93317-22204 | | REC93332-00003 | | REC93306-001U1 |
| 40X W | 2000 | REC93315-32224 | REC93332-00001 | | REC93317-22204 | | REC93332-00003 | | REC93306-001U1 |
| 40X WL | | | | | | | | | |
| 40X WS | 2001 | REC93315-32224 | REC93332-00001 | | REC93317-22204 | | REC93332-00003 | | REC93306-001U1 |
| 40X WT | 2000 | | REC93332-00001 | | REC93317-22204 | | REC93332-00003 | | REC93306-001U1 |
| 40X WTL | 2001-03 | REC93315-32224 | REC93332-00001 | | REC93317-22204 | | REC93332-00003 | | REC93306-001U1 |
| 40Y ETOL | 2001-06 | REC93315-32224 | REC93332-00001 | | REC93317-22204 | | REC93332-00003 | | REC93306-001U1 |
| 40Y MHOS | 2001-06 | REC93315-32224 | REC93332-00001 | | REC93317-22204 | | REC93332-00003 | | REC93306-001U1 |
| E40G MH | 2003 | REC93315-324U1 | REC93315-217U0 | REC93390-000U0 | | | REC93332-000U0 | | REC93332-000U0 |
| E40G MHL | 2003 | REC93315-324U1 | REC93315-217U0 | REC93390-000U0 | | | REC93332-000U0 | | REC93332-000U0 |
| E40G MHS | 2003 | REC93315-324U1 | REC93315-217U0 | REC93390-000U0 | | | REC93332-000U0 | | REC93332-000U0 |
| F40A | | | | | | | | | |
| F40A ED | 1999 | REC93315-32224 | REC93332-00001 | | REC93317-22204 | | REC93332-00003 | | REC93306-001U1 |
| F40A EDL | 2001 | REC93315-32224 | REC93332-00001 | | REC93317-22204 | | REC93332-00003 | | REC93306-001U1 |
| F40A ET | 1999 | REC93315-32224 | REC93332-00001 | | REC93317-22204 | | REC93332-00003 | | REC93306-001U1 |
| F40A ETL | 2001-02 | REC93315-32224 | REC93332-00001 | | REC93317-22204 | | REC93332-00003 | | REC93306-001U1 |
| F40A ED | 1999 | REC93315-325V1 | REC93332-00001 | | REC93317-22204 | | REC93332-00003 | | REC93306-207U0 |
| F40B ED | 2000-01 | REC93315-32224 | REC93332-00001 | | REC93317-22204 | | REC93332-00003 | | REC93306-001U1 |
| F40B EDL | 2001-06 | REC93315-32224 | REC93332-00001 | | REC93317-22204 | | REC93332-00003 | | REC93306-001U1 |
| F40B EDS | 2001-02 | REC93315-32224 | REC93332-00001 | | REC93317-22204 | | REC93332-00003 | | REC93306-001U1 |
| F40B ET | 2000-01 | REC93315-32224 | REC93332-00001 | | REC93317-22204 | | REC93332-00003 | | REC93306-001U1 |
| F40B ETL | | | | | | | | | |
| F40B ETS | 2001-06 | REC93315-32224 | REC93332-00001 | | REC93317-22204 | | REC93332-00003 | | REC93306-001U1 |
| F40B MHD | 2000 | REC93315-32224 | REC93332-00001 | | REC93317-22204 | | REC93332-00003 | | REC93306-001U1 |
| F40B MHDL | | | | | | | | | |
| F40B MHDS | 2001-06 | REC93315-32224 | REC93332-00001 | | REC93317-22204 | | REC93332-00003 | | REC93306-001U1 |
| F40C ETL | 2002-06 | REC93315-32224 | REC93332-00001 | | REC93317-22204 | | | | |
| F45A | 1996-99 | REC93315-32224 | REC93332-00001 | | REC93317-22204 | | REC93332-000W7 | | REC93306-001U1 |
| F45A ED | | | | | | | | | |
| F45A ET | 2000 | REC93315-32224 | REC93332-00001 | | REC93317-22204 | | REC93332-000W7 | | REC93306-001U1 |
| 50D | 1984-90 | REC93315-32224 | REC93332-00023 | | REC93317-22204 | | | | REC93306-00702 |
| 50D | 1991-93 | REC93315-32224 | REC93332-00001 | | | | | | REC93306-00702 |
| 50G | 1993-98 | REC93315-325V1 | REC93332-00001 | | REC93317-22204 | | REC93332-000W7 | | REC93306-00702 |
| 50G ETO | 2000 | REC93315-325V1 | REC93332-00001 | | REC93317-22204 | | REC93332-00003 | | REC93306-00702 |
| 50G ETOL | 2001-06 | REC93315-325V1 | REC93332-00001 | | REC93317-22204 | | REC93332-00003 | | REC93306-00702 |



1

2

3

4

5

6

7

8

| | | | | | | | | | |
|-----------|---------|----------------|----------------------------------|----|----------------|----------------|----------------|--|----------------|
| 50H | 1995-98 | REC93315-32224 | REC93332-00001 | | REC93317-22204 | | REC93332-00003 | | REC93306-001U1 |
| 50H EDO | 2000 | REC93315-32224 | REC93332-00001 | | REC93317-22204 | | REC93332-00003 | | REC93306-001U1 |
| 50H EDOL | 2001-02 | REC93315-32224 | REC93332-00001 | | REC93317-22204 | | REC93332-00003 | | REC93306-001U1 |
| 50H EDOS | | | | | | | | | |
| 50H MDO | 2000 | REC93315-32224 | REC93332-00001 | | REC93317-22204 | | REC93332-00003 | | REC93306-001U1 |
| 50H MO | | | | | | | | | |
| F50A | 1995 | REC93315-32224 | REC93332-000U3 | | REC93317-22204 | | REC93332-00003 | | REC93306-001U1 |
| F50A ED | 2000 | REC93315-32224 | REC93332-00001 | 06 | REC93317-22204 | | REC93332-00003 | | REC93306-001U1 |
| F50A EDL | 2001-06 | REC93315-32224 | REC93332-00001 | | REC93317-22204 | | REC93332-00003 | | REC93306-001U1 |
| F50A ET | 2000 | REC93315-32224 | REC93332-00001 | | REC93317-22204 | | REC93332-00003 | | REC93306-001U1 |
| F50A ETL | 2001-06 | REC93315-32224 | REC93332-00001 | | REC93317-22204 | | REC93332-00003 | | REC93306-001U1 |
| F50B | 1996-97 | REC93315-32224 | REC93332-00001 | | REC93317-22204 | | REC93332-00003 | | REC93306-001U1 |
| F50B | 1998-99 | REC93315-325V1 | REC93332-000U3 | | REC93317-22204 | | REC93332-000W7 | | REC93306-001U1 |
| F50B ET | 2000 | REC93315-32224 | REC93332-00001 | | REC93317-22204 | | REC93332-00003 | | REC93306-001U1 |
| F50F EDL | 2005-06 | REC93315-32224 | REC93332-00001 | | REC93317-22204 | | | | REC93306-001U1 |
| F50F ETL | | | | | | | | | |
| FT50B | 1998-99 | REC93315-32224 | REC93332-00001 | | REC93317-22204 | | REC93332-000W7 | | REC93306-001U1 |
| FT50B ETL | 2001-02 | REC93315-32224 | REC93332-00001 | | REC93317-22204 | | REC93332-00003 | | REC93306-001U1 |
| FT50C ETL | 2002-06 | REC93315-32224 | REC93332-00001 | | REC93317-22204 | | REC93332-00003 | | REC93306-001U1 |
| FT50G ETL | 2005-06 | | REC93332-000U3 | | REC93317-325U0 | | | | REC93306-001U1 |
| 55B | 1993-98 | REC93315-32224 | REC93332-00001 | | REC93317-22204 | | REC93332-00003 | | REC93306-00702 |
| 55B E | 1990-91 | REC93315-32224 | REC93332-00001 | | REC93317-22204 | | REC93332-00003 | | REC93306-00702 |
| 55B E | 1992 | REC93315-32224 | REC93332-00023 | | REC93317-22204 | | REC93332-00003 | | REC93306-00702 |
| 55B EHD | 2000 | REC93315-32224 | REC93332-00001 | | REC93317-22204 | | REC93332-00003 | | REC93306-00702 |
| 55B ET | 2000 | REC93315-32224 | REC93332-00001 | | REC93317-22204 | | REC93332-00003 | | REC93306-00702 |
| 55B ETL | 2001-02 | REC93315-32224 | REC93332-00001 | | REC93317-22204 | -06 | REC93332-00003 | | REC93306-00702 |
| 60F | 1984-98 | REC93315-325V1 | REC93332-00001 | | REC93317-22204 | | REC93332-000W7 | | REC93306-00702 |
| 60F EO | | | | | | | | | |
| 60F ETO | 2000 | REC93315-325V1 | REC93332-00001 | | REC93317-22204 | | REC93332-00003 | | REC93306-00702 |
| 60F ETOL | 2001-06 | REC93315-325V1 | REC93332-00001 | | REC93317-22204 | | REC93332-00003 | | REC93306-00702 |
| E60H MHDL | 2001-06 | REC93315-325V1 | REC93332-000U3 | | REC93317-325U0 | | REC93332-000W7 | | REC93306-207U0 |
| F60A ETL | 2002-06 | REC93315-32224 | REC93332-00001 | | REC93317-22204 | | | | REC93306-001U1 |
| F60C ETL | 2005-06 | REC93315-32224 | REC93332-00001 | | REC93317-22204 | | | | REC93306-001U1 |
| FT60B ETL | 2003-06 | | REC93332-000U3 | | REC93317-325U0 | | | | REC93306-207U0 |
| FT60D ETL | 2005-06 | | REC93332-000U3 | | REC93317-325U0 | | | | REC93306-207U0 |
| 70B | 1984-98 | REC93315-325V1 | REC93332-00001 | | REC93317-22204 | | REC93332-000W7 | | REC93306-00702 |
| 70B EDOL | 2001 | REC93315-325V1 | REC93332-00001 | | REC93317-22204 | | REC93332-00003 | | REC93306-00702 |
| 70B EO | | | | | | | | | |
| 70B ETO | 2000 | REC93315-325V1 | REC93332-00001 | | REC93317-22204 | | REC93332-00003 | | REC93306-00702 |
| 70B ETOL | 2001-06 | REC93315-325V1 | REC93332-00001 | | REC93317-22204 | | REC93332-00003 | | REC93306-00702 |
| 75A | 1990-98 | REC93315-325V1 | REC93332-000U3 | | REC93317-325U0 | | REC93332-000W7 | | REC93306-207U0 |
| 75A E | 1990-00 | REC93315-325V1 | REC93332-000U3 | | REC93317-325U0 | | REC93332-000U5 | | REC93306-207U0 |
| 75A EDL | 2001-06 | REC93315-325V1 | REC93332-000U3 | | REC93317-325U0 | | REC93332-000W7 | | REC93306-207U0 |
| 75A EM | 1992-93 | | REC93332-000U3 | | REC93317-325U0 | | REC93332-000U5 | | REC93306-207U0 |
| 75A ET | 2000 | REC93315-325V1 | | | REC93317-325U0 | | REC93332-000U5 | | REC93306-207U0 |
| 75A ETL | 2001-02 | REC93315-325V1 | REC93332-000U3 | | REC93317-325U0 | | REC93332-000W7 | | REC93306-207U0 |
| 75A MHD | 2000 | REC93315-325V1 | REC93332-000U3 | | REC93317-325U0 | | | | REC93306-207U0 |
| 75C | 1998 | REC93315-325V1 | | | REC93317-325U0 | | REC93332-000W7 | | REC93306-207U0 |
| 75C ETO | 2000 | REC93315-325V1 | REC93332-000U3 | | REC93317-325U0 | | REC93332-000W7 | | REC93306-207U0 |
| 75C ETOL | 2001-06 | REC93315-325V1 | REC93332-000U3 | | REC93317-325U0 | | REC93332-000W7 | | REC93306-207U0 |
| 80A | 1985-96 | REC93315-325V1 | REC93332-000U3 | | REC93317-325U0 | | REC93332-000U5 | | REC93306-207U0 |
| F80A | 1999 | | REC93332-000U3 | | REC93317-325U0 | REC93317-322V0 | | | REC93306-207U0 |
| F80A ET | 2000 | | REC93332-000U3 | | REC93317-325U0 | REC93317-322V0 | | | REC93306-207U0 |
| F80A ETL | 2001-06 | | REC93332-000U3 | | REC93317-325U0 | REC93317-322V0 | | | REC93306-207U0 |
| F80A ETX | 2001 | | REC93332-000U3 | | REC93317-325U0 | REC93317-322V0 | | | REC93306-207U0 |
| F80B ETL | 2005-06 | | REC93332-000U3 | | REC93317-325U0 | REC93317-322V0 | | | REC93306-207U0 |
| 85A | 1996-98 | REC93315-325V1 | REC93332-000U3 | | REC93317-325U0 | | REC93332-000W7 | | REC93306-207U0 |
| 85A E | 1990-00 | REC93315-325V1 | REC93332-000U3 | | REC93317-325U0 | | REC93332-000U5 | | REC93306-207U0 |
| 85A ET | 2000 | REC93315-325V1 | REC93332-000U3 | | REC93317-325U0 | | REC93332-000U5 | | REC93306-207U0 |
| 85A ETL | 2001-02 | REC93315-325V1 | REC93332-000U3 | | REC93317-325U0 | | REC93332-000W7 | | REC93306-207U0 |
| 90A | 1984-98 | REC93315-325V1 | REC93332-000U3 | | REC93317-325U0 | | REC93332-000W7 | | REC93306-207U0 |
| 90A ETO | 2000 | REC93315-325V1 | REC93332-000U3 | | REC93317-325U0 | | REC93332-000U7 | | REC93306-207U0 |
| 90A ETOL | 2001-06 | REC93315-325V1 | REC93332-000U3 | | REC93317-325U0 | | REC93332-000W7 | | REC93306-207U0 |
| 100A | 1998 | REC93315-628U9 | REC93315-430V5 REC93341-930V2 | | REC93315-430U8 | REC93315-425U7 | REC93332-000U7 | | REC93306-208U0 |
| 100A ETO | 2000 | REC93315-628U9 | REC93317-330U2 REC93341-930V2 | | REC93315-430U8 | REC93315-425U7 | | | REC93306-208U0 |
| 100A ETOL | 2001 | REC93315-628U9 | REC93317-330U2 REC93341-930V2 | | REC93315-430U8 | REC93315-425U7 | REC93332-000U7 | | REC93306-208U0 |
| F100A | 1999 | | REC93332-000U3 | | REC93317-325U0 | REC93317-322V0 | | | REC93306-207U0 |
| F100A ET | 2000 | | REC93332-000U3 | | REC93317-325U0 | REC93317-322V0 | | | REC93306-207U0 |
| F100A ETL | 2001-06 | | REC93332-000U3 | | REC93317-325U0 | REC93317-322V0 | | | REC93306-207U0 |
| F100A ETX | 2001 | | REC93332-000U3 | | REC93317-325U0 | REC93317-322V0 | | | REC93306-207U0 |

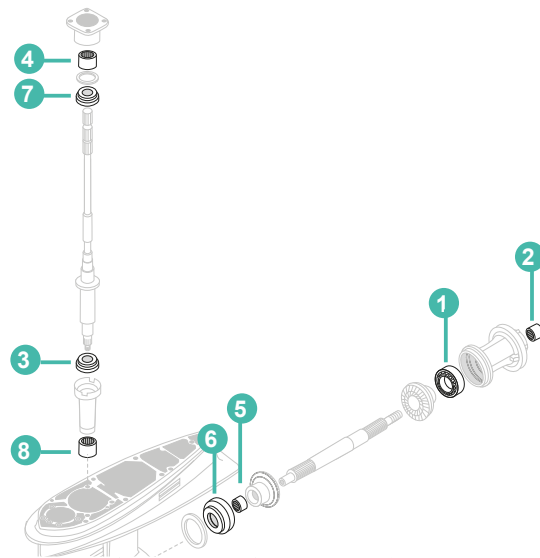

| | | 1 | 2 | 3 | 4 | 5 | 6 | 7 | 8 |
|------------------------|---------|----------------|----------------------------------|---|----------------|----------------|--|----------------|--|
| F100B ETX | 2005-06 | REC93315-628U9 | REC93317-330U2 REC93341-930V2 | | REC93315-430U8 | REC93315-425U7 | REC93332-000U7 | | REC93306-208U0 |
| F100D ETL | 2005-06 | | REC93332-000U3 | | REC93317-325U0 | REC93317-322V0 | | | REC93306-207U0 |
| 115A | 1984-87 | REC93315-628U9 | REC93317-330U2 REC93341-930V2 | | REC93315-430U8 | REC93315-425U7 | REC93332-000U7 | | REC93306-208U0 |
| 115B | 1988-95 | REC93315-628U9 | REC93317-330U2 REC93341-930V2 | | REC93315-430U8 | REC93315-425U7 | REC93332-000U7 | | REC93306-208U0 |
| 115B | 1996 | REC93315-628U9 | REC93315-430V5 REC93341-930V2 | | REC93315-430U8 | REC93315-425U7 | REC93332-000U7 | | REC93306-208U0 |
| 115B ETO | 1997-98 | REC93315-628U9 | REC93315-430V5 REC93341-930V2 | | REC93315-430U8 | REC93315-425U7 | REC93332-000U7 | | REC93306-208U0 |
| 115B ETO | 1999-00 | REC93315-628U9 | REC93317-330U2 | | | REC93315-425U7 | REC93332-000U7 | | REC93306-208U0 |
| 115B ETOL | 2001-02 | REC93315-628U9 | REC93317-330U2 REC93341-930V2 | | REC93315-430U8 | REC93315-425U7 | REC93332-000U7 | | REC93306-208U0 |
| 115C | 1990-95 | REC93315-628U9 | REC93317-330U2 REC93341-930V2 | | REC93315-430U8 | REC93315-425U7 | REC93332-000U7 | REC93315-430V5 | REC93306-208U0 |
| 115C ETO | 2000 | REC93315-628U9 | REC93317-330U2 REC93341-930V2 | | REC93315-430U8 | REC93315-425U7 | REC93332-000U7 | REC93315-430V5 | REC93306-208U0 |
| 115C ETOL | 2001-06 | REC93315-628U9 | REC93317-330U2 REC93341-930V2 | | REC93315-43061 | REC93315-425U7 | REC93332-000U7 | REC93315-430V5 | REC93306-208U0 |
| 115C ETOX | 2001-02 | REC93315-628U9 | REC93317-330U2 REC93341-930V2 | | REC93315-430U8 | REC93315-425U7 | REC93332-000U7 | REC93315-430V5 | REC93306-208U0 |
| F115A ET | 2000 | REC93315-628U9 | REC93317-330U2 REC93341-930V2 | | REC93315-430U8 | REC93315-425U7 | REC93332-000U7 | REC93315-430V5 | REC93306-208U0 |
| F115A ETL F115A ETX | 2001-06 | REC93315-628U9 | REC93317-330U2 REC93341-930V2 | | REC93315-430U8 | REC93315-425U7 | REC93332-000U7 | REC93315-430V5 | REC93306-208U0 |
| FL115A ET | 2000 | REC93315-628U9 | REC93317-330U2 REC93341-930V2 | | REC93315-430U8 | REC93315-425U7 | REC93332-000U7 | REC93315-430V5 | REC93306-208U0 |
| FL115A ETX | 2001-06 | REC93315-628U9 | REC93317-330U2 REC93341-930V2 | | REC93315-430U8 | REC93315-425U7 | REC93332-000U7 | REC93315-430V5 | REC93306-208U0 |
| 130B | 1990-94 | REC93315-628U9 | REC93317-330U2 REC93341-930V2 | | REC93315-430U8 | REC93315-425U7 | REC93332-000U7 | REC93315-430V5 | REC93306-208U0 |
| 130B ETO | 2000 | REC93315-628U9 | REC93317-330U2 REC93341-930V2 | | REC93315-430U8 | REC93315-425U7 | REC93332-000U7 | REC93315-430V5 | REC93306-208U0 |
| 130B ETOL | 2001-06 | REC93315-628U9 | REC93317-330U2 REC93341-930V2 | | REC93315-43061 | REC93315-425U7 | REC93332-000U7 | REC93315-430V5 | REC93306-208U0 |
| 130B ETOX | 2001 | REC93315-628U9 | REC93317-330U2 REC93341-930V2 | | REC93315-430U8 | REC93315-425U7 | REC93332-000U7 | REC93315-430V5 | REC93306-208U0 |
| L130B | 1991-94 | REC93315-628U9 | REC93317-330U2 REC93341-930V2 | | REC93315-430U8 | REC93315-425U7 | REC93332-000U7 | REC93315-430V5 | REC93306-208U0 |
| L130B | 1995-98 | REC93315-628U9 | REC93315-430V5 REC93341-930V2 | | REC93315-430U8 | REC93315-425U7 | REC93332-000U7 | | REC93306-208U0 |
| L130B ETO | 2000 | REC93315-628U9 | REC93317-330U2 | | REC93315-430U8 | REC93315-425U7 | REC93332-000U7 | REC93315-430V5 | REC93306-208U0 |
| L130B ETOX | 2001 | REC93315-628U9 | REC93317-330U2 REC93341-930V2 | | REC93315-430U8 | REC93315-425U7 | REC93332-000U7 | REC93315-430V5 | REC93306-208U0 |
| 140A | 1984-87 | REC93315-628U9 | REC93317-330U2 REC93341-930V2 | | REC93315-430U8 | REC93315-425U7 | REC93332-000U7 | | REC93306-208U0 |
| 140B | 1988-89 | REC93315-628U9 | REC93317-330U2 REC93341-930V2 | | REC93315-430U8 | REC93315-425U7 | REC93332-000U7 | | REC93306-208U0 |
| L140B | 1989 | REC93315-628U9 | REC93317-330U2 REC93341-930V2 | | REC93315-430U8 | REC93315-425U7 | REC93332-000U7 | REC93315-430V5 | REC93306-208U0 |
| 150A | 1984-89 | REC93311-928U5 | REC93317-330U2 REC93341-930V2 | | REC93315-430U8 | REC93315-425V3 | REC93332-000V3 STD. ROT REC93390-000U2 C.ROT. | REC93315-430V5 | REC93306-209U0 STD. ROT REC93332-00048 C.ROT. |
| 150A ET | 1998-00 | REC93311-928U5 | REC93317-330U2 REC93341-930V2 | | REC93315-430U8 | REC93315-425V3 | REC93332-000V3 | | REC93306-209U0 |
| 150A ETO | 1986-87 | | | | REC93315-430U8 | | REC93390-000U2 | | REC93390-000U2 |
| 150A ETL | 2001-02 | REC93311-928U5 | REC93317-330U2 REC93341-930V2 | | REC93315-430U8 | REC93315-425V3 | REC93332-000V3 | | REC93306-209U0 |
| 150A ETX | 2001-02 | REC93311-928U5 | REC93317-330U2 REC93341-930V2 | | REC93315-430U8 | REC93315-425V3 | REC93332-000V3 | | REC93306-209U0 |
| 150C | 1990-94 | REC93311-928U5 | REC93317-330U2 REC93341-930V2 | | REC93315-430U8 | REC93315-425V3 | REC93332-000V3 | | REC93306-209U0 |
| 150F | 1996-98 | REC93311-928U5 | REC93315-430V5 REC93341-930V2 | | REC93315-430U8 | REC93315-425V3 | REC93390-000U2 | | REC93332-00048 |
| 150F | 1997-98 | REC93311-928U5 | REC93315-430V5 REC93341-930V2 | | REC93315-430U8 | REC93315-425V3 | REC93332-000V3 STD. ROT REC93390-000U2 C.ROT. | | REC93306-209U0 STD. ROT REC93332-00048 C.ROT. |

| | | 1 | 2 | 3 | 4 | 5 | 6 | 7 | 8 |
|--------------------------|---------|----------------|----------------------------------|---|----------------|----------------|--|----------------|--|
| 200B | 1990-94 | REC93311-928U5 | REC93317-330U2 REC93341-930V2 | | REC93315-430U8 | REC93315-425V3 | REC93332-000V3 | | REC93306-209U0 |
| 200B | 1995 | REC93311-928U5 | REC93315-430V5 | | REC93315-430U8 | REC93315-425V3 | REC93390-000U2 REC93332-000V3 | | REC93332-00048 REC93306-209U0 |
| 200F | 1996-98 | REC93311-928U5 | REC93315-430V5 REC93341-930V2 | | REC93315-430U8 | REC93315-425V3 | STD. ROT REC93390-000U2 C.ROT. | | STD. ROT REC93332-00048 C.ROT. |
| 200F ETO | 2000 | REC93311-928U5 | REC93317-330U2 REC93341-930V2 | | REC93315-430U8 | REC93315-425V3 | REC93332-000V3 STD. ROT REC93390-000U2 C.ROT. | | REC93306-209U0 STD. ROT REC93332-00048 C.ROT. |
| 200F ETOL 200F ETOX | 2001-06 | REC93311-928U5 | REC93317-330U2 REC93341-930V2 | | REC93315-43061 | REC93315-425V3 | REC93332-000V3 STD. ROT REC93390-000U2 C.ROT. | | REC93306-209U0 STD. ROT REC93332-00048 C.ROT. |
| 200G | 1999 | REC93311-928U5 | REC93317-330U2 REC93341-930V2 | | REC93315-430U8 | REC93315-425V3 | REC93332-000V3 | | REC93306-209U0 |
| 200G ETO | 2000 | REC93311-928U5 | REC93317-330U2 REC93341-930V2 | | REC93315-430U8 | REC93315-425V3 | REC93332-000V3 | | REC93306-209U0 |
| 200G ETOL | 2001-03 | REC93311-928U5 | REC93317-330U2 REC93341-930V2 | | REC93315-430U8 | REC93315-425V3 | REC93332-000V3 | | REC93306-209U0 |
| F200A ETX | 2002-06 | REC93311-83280 | REC93317-330U2 | | REC93315-43061 | | REC93332-000W1 | | REC93306-209U0 STD. ROT REC93332-00048 C.ROT. |
| F200C ETX | 2006 | REC93311-83280 | REC93317-330U2 | | | | REC93332-000W1 | | REC93306-209U0 STD. ROT REC93332-00048 C.ROT. |
| FL200A ETX | 2002-06 | REC93311-83280 | REC93317-330U2 | | REC93315-43061 | | REC93332-000W1 | | REC93306-209U0 STD. ROT REC93332-00048 C.ROT. |
| FL200C ETX | 2006 | REC93311-83280 | REC93317-330U2 | | | | REC93332-000W1 | | REC93306-209U0 STD. ROT REC93332-00048 C.ROT. |
| L200A | 1988-89 | REC93311-928U5 | REC93317-330U2 REC93341-930V2 | | REC93315-430U8 | REC93315-425V3 | REC93390-000U2 | REC93315-430V5 | REC93332-00048 |
| L200B | 1990-94 | REC93311-928U5 | REC93317-330U2 REC93341-930V2 | | | REC93315-425V3 | REC93332-000V3 STD. ROT REC93390-000U2 C.ROT. | REC93315-430V5 | REC93306-209U0 |
| L200F | 1996-98 | REC93311-928U5 | REC93315-430V5 REC93341-930V2 | | REC93315-430U8 | REC93315-425V3 | REC93332-000V3 STD. ROT REC93390-000U2 C.ROT. | | REC93306-209U0 STD. ROT REC93332-00048 C.ROT. |
| L200F ETO | 2000 | REC93311-928U5 | REC93317-330U2 REC93341-930V2 | | REC93315-430U8 | REC93315-425V3 | REC93332-000V3 STD. ROT REC93390-000U2 C.ROT. | | REC93306-209U0 STD. ROT REC93332-00048 C.ROT. |
| L200F ETOL | 2001-06 | REC93311-928U5 | REC93317-330U2 REC93341-930V2 | | REC93315-43061 | REC93315-425V3 | REC93332-000V3 STD. ROT REC93390-000U2 C.ROT. | | REC93306-209U0 STD. ROT REC93332-00048 C.ROT. |
| L200F ETOX | 2001 | REC93311-928U5 | REC93317-330U2 | | REC93315-430U8 | REC93315-425V3 | REC93332-000V3 STD. ROT REC93390-000U2 C.ROT. | | REC93306-209U0 STD. ROT REC93332-00048 C.ROT. |
| LZ200N | 2000 | | | | | | REC93390-000U2 | | REC93390-000U2 |
| LZ200N ETO | 2000 | REC93311-928U5 | REC93317-330U2 | | REC93315-430U8 | REC93315-425V3 | REC93332-000V3 | | REC93306-209U0 STD. ROT REC93332-00048 C.ROT. |
| LZ200N ETOX | 2001-07 | REC93311-928U5 | REC93317-330U2 REC93341-930V2 | | REC93315-43061 | REC93315-425V3 | REC93332-000V3 STD. ROT REC93390-000U2 C.ROT. | | REC93306-209U0 STD. ROT REC93332-00048 C.ROT. |
| LZ200T R | 2005 | | | | | | REC93390-000U2 | | REC93390-000U2 |
| LZ200T XRC | 2004-06 | | | | | | REC93390-000U2 | | REC93390-000U2 |
| LZ200T XRD | 2005 | | | | | | REC93390-000U2 | | REC93390-000U2 |
| Z200N ETO | 2000 | REC93311-928U5 | REC93317-330U2 REC93341-930V2 | | REC93315-430U8 | REC93315-425V3 | REC93332-000V3 | | REC93306-209U0 STD. ROT REC93332-00048 C.ROT. |
| Z200N ETOL Z200N ETOX | 2001-06 | REC93311-928U5 | REC93317-330U2 REC93341-930V2 | | REC93315-43061 | REC93315-425V3 | REC93332-000V3 STD. ROT REC93390-000U2 C.ROT. | | REC93306-209U0 STD. ROT REC93332-00048 C.ROT. |
| Z200P ETOL | 2003-06 | REC93311-928U5 | REC93317-330U2 REC93341-930V2 | | REC93315-43061 | REC93315-425V3 | REC93332-000V3 | | REC93306-209U0 |
| 220A | 1984-86 | REC93311-928U5 | REC93317-330U2 REC93341-930V2 | | REC93315-430U8 | REC93315-425V3 | REC93332-000V3 | | REC93306-209U0 |
| 225A | 1987-89 | REC93311-928U5 | REC93317-330U2 REC93341-930V2 | | REC93315-430U8 | REC93315-425V3 | | | REC93306-209U0 |
| 225B | 1990-94 | REC93311-928U5 | REC93317-330U2 REC93341-930V2 | | REC93315-430U8 | REC93315-425V3 | REC93332-000V3 | | REC93306-209U0 |
| 225B | 1995 | REC93311-928U5 | REC93315-430V5 | | | REC93315-425V3 | REC93332-000V3 | | REC93306-209U0 |
| 225C | 1994 | REC93311-83280 | REC93317-330U2 | | REC93315-430U8 | | REC93332-000W1 | | REC93306-210U0 |

| | | 1 | 2 | 3 | 4 | 5 | 6 | 7 | 8 |
|---|---------|----------------|----------------------------------|---|----------------|----------------|----------------|----------------|--|
| 225C | 1995 | REC93311-83280 | REC93315-430V5 | | | | | | |
| 225D | 1996-98 | REC93311-928U5 | REC93315-430V5 REC93341-930V2 | | REC93315-430U8 | REC93315-425V3 | REC93332-000V3 | | REC93306-209U0 |
| 225D ETO | 2000 | REC93311-928U5 | REC93317-330U2 REC93341-930V2 | | REC93315-430U8 | REC93315-425V3 | REC93332-000V3 | | REC93306-209U0 |
| 225D ETOL 225D ETOX | 2001-03 | REC93311-928U5 | REC93317-330U2 REC93341-930V2 | | REC93315-430U8 | REC93315-425V3 | REC93332-000V3 | | REC93306-209U0 |
| 225G | 1999 | REC93311-83280 | REC93317-330U2 | | REC93315-43061 | | REC93332-000W1 | | REC93306-210U0 |
| 225G ETO | 2000 | REC93311-83280 | REC93317-330U2 | | REC93315-43061 | | REC93332-000W1 | | REC93306-210U0 |
| 225G ETOL | 2001-03 | REC93311-928U5 | REC93317-330U2 | | REC93315-43061 | | REC93332-000W1 | | REC93306-210U0 |
| F225A ETU | 2003-06 | | REC93317-330U2 | | REC93315-43061 | | REC93332-000W1 | | REC93306-209U0 STD. ROT REC93332-00048 C.ROT. |
| F225A ETX FL225A ETX | 2002-06 | REC93311-83280 | REC93317-330U2 | | REC93315-43061 | | REC93332-000W1 | | REC93306-209U0 STD. ROT REC93332-00048 C.ROT. |
| L225C | 1994 | REC93311-83280 | REC93317-330U2 | | REC93315-430U8 | | REC93332-000W1 | | REC93306-210U0 |
| L225C | 1995 | REC93311-83280 | REC93315-430V5 | | | | REC93332-000W1 | | REC93306-210U0 |
| 250A | 1990-94 | REC93311-83280 | REC93317-330U2 | | REC93315-430U8 | | REC93332-000W1 | | REC93306-210U0 |
| 250A | 1995-98 | REC93311-83280 | REC93315-430V5 | | | | REC93332-000W1 | | REC93306-210U0 |
| 250A ETO | 2000 | REC93311-83280 | REC93317-330U2 | | REC93315-430U8 | | REC93332-000W1 | | REC93306-210U0 |
| 250A ETOX | 2001-06 | REC93311-83280 | REC93317-330U2 | | REC93315-43061 | | REC93332-000W1 | | REC93306-210U0 |
| 250B | 1997-98 | REC93311-83280 | REC93317-330U2 | | REC93315-430U8 | | REC93332-000W1 | | REC93306-210U0 |
| 250B ETO | 2000 | REC93311-83280 | REC93317-330U2 | | REC93315-430U8 | | REC93332-000W1 | | REC93306-210U0 |
| 250B ETOX | 2001-03 | REC93311-83280 | REC93317-330U2 | | REC93315-430U8 | | REC93332-000W1 | | REC93306-210U0 |
| 250G ETOX | 2006 | REC93311-83280 | REC93317-330U2 | | REC93315-43061 | | REC93332-000W1 | | REC93306-210U0 |
| F250A ETU | 2006 | REC93311-83280 | REC93317-330U2 | | | | REC93332-000W1 | | REC93306-210U0 REC93306-209U0 STD. ROT REC93332-00048 C.ROT. |
| F250A ETX FL250A ETU FL250 ETX | 2006 | REC93311-83280 | REC93317-330U2 | | | | REC93332-000W1 | | REC93306-210U0 REC93306-209U0 STD. ROT REC93332-00048 C.ROT. |
| L250A | 1990-94 | REC93311-83280 | REC93317-330U2 | | REC93315-430U8 | | REC93332-000W1 | REC93315-430U8 | REC93315-430U8 |
| L250A | 1995-98 | REC93311-83280 | REC93315-430V5 | | | | REC93332-000W1 | | REC93306-210U0 |
| L250A ETO | 2000 | REC93311-83280 | REC93317-330U2 | | REC93315-430U8 | | REC93332-000W1 | | REC93306-210U0 |
| L250A ETOX | 2001-06 | REC93311-83280 | REC93317-330U2 | | REC93315-43061 | | REC93332-000W1 | | REC93306-210U0 |
| L250B | 1997-98 | REC93311-83280 | REC93317-330U2 | | REC93315-430U8 | | REC93332-000W1 | | REC93306-210U0 |
| L250B ETO | 2000 | REC93311-83280 | REC93317-330U2 | | REC93315-430U8 | | REC93332-000W1 | | REC93306-210U0 |
| L250B ETOX | 2001-03 | REC93311-83280 | REC93317-330U2 | | REC93315-430U8 | | REC93332-000W1 | | REC93306-210U0 |
| L250G ETOX | 2006 | REC93311-83280 | REC93317-330U2 | | REC93315-43061 | | REC93332-000W1 | | REC93306-210U0 |
| LZ250D EOX | 2003-06 | REC93311-83280 | REC93317-330U2 | | REC93315-43061 | | REC93332-000W1 | | REC93306-209U0 STD. ROT REC93332-00048 C.ROT. |
| Z250D ETOU | 2003 | REC93311-83280 | REC93317-330U2 | | REC93315-43061 | | REC93332-000W1 | | REC93306-209U0 STD. ROT REC93332-00048 C.ROT. |
| Z250D ETOX Z250F ETOL | 2003-06 | REC93311-83280 | REC93317-330U2 | | REC93315-43061 | | REC93332-000W1 | | REC93306-209U0 STD. ROT REC93332-00048 C.ROT. |
| LZ300A ETOX Z300A ETOU Z300A ETOX | 2004-06 | REC93311-83280 | REC93317-330U2 | | | | REC93332-000W1 | | REC93306-209U0 STD. ROT REC93332-00048 C.ROT. |

SISTEMA DE PROPULSIÓN PROPULSION SYSTEM

SISTEMA DI PROPULSIONE SYSTEME DE PROPULSION

HÉLICES ALUMINIO E INOXIDABLE DE 3 Y 4 PALAS 3 & 4 BLADE ALUMINIUM & SS PROPELLERS ELICHE ALLUMINIO E INOX DA 3 E 4 PALE HELICE ALUMINIUM ET INOX 3 ET 4 PALES

CÓDIGO DE REFERENCIAS PART NO. CODING SYSTEM SISTEMA DI CODICE CODAGE DES REFERENCES

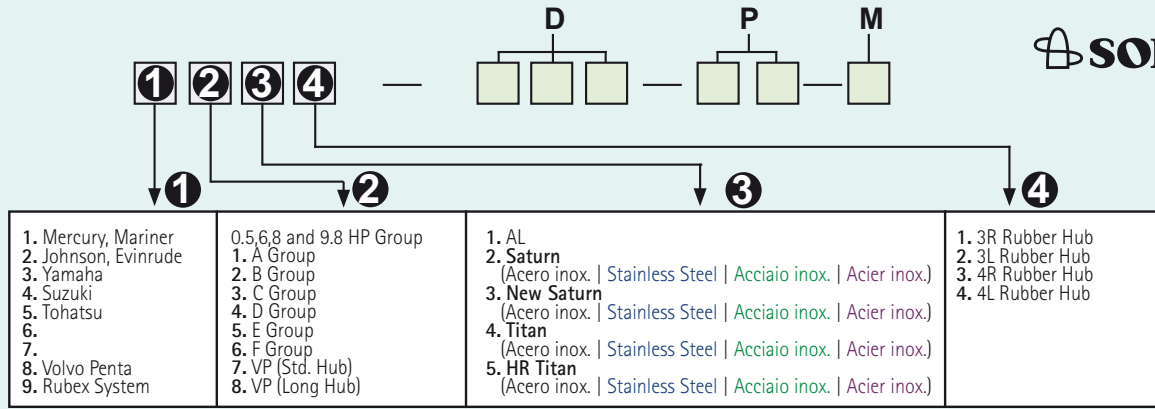

Ejemplo | Note | Esempio | Exemple

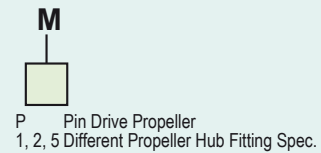
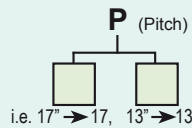
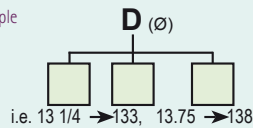

AMITA 3

Hélice de aluminio de 3 palas con núcleo de goma de gran resistencia.

3 blade aluminum propeller with heavy duty rubber hub.

Eliche di alluminio a 3 pale con mozzi in gomma ad alta resistenza.

Hélice en aluminium 3 pales avec moyeu en caoutchouc



AMITA 4

Hélices de aluminio de 4 palas con núcleo de goma de gran resistencia. Van muy suaves a poca velocidad y hace el barco muy manejable con la mar picada.

4 Blade aluminum propeller with heavy duty rubber hub. Smoother low speed makes the offshore boating activity much easier.

Eliche di alluminio a 4 pale con mozzo in gomma ad alta resistenza. Molto morbido a bassa velocità e rende la barca molto maneggevole con mare cattivo.

Hélice en aluminium 4 pales avec moyeu en caoutchouc. Permet d'aller doucement à basse vitesse et rend le bateau très maniable lorsque la mer est agitée



LEXOR

Hélices de acero inoxidable de 3 palas. Gran diámetro del área de las palas para barcos pesados. Gran rendimiento en alta velocidad sin sacrificar las velocidades medias. Excelente ahorro de combustible.

Three blade stainless steel propeller. Large diameter and blade area for big boat loads. Great high speed performance without sacrificing mid-range speeds. Excellent fuel economy.

Eliche di acciaio inox a 3 pale. Grande diametro delle pale per imbarcazioni pesanti. Grandi prestazioni ad alta velocità senza sacrificare velocità medie. Eccellente risparmio di carburante.

Hélice inox 3 Pales, grand diamètre pour bateaux lourds. Excellentes performances à grande vitesse sans sacrifier les vitesses moyennes. Excellente économie de carburant.



NEW SATURN

Hélices de acero inoxidable de 3 palas. Ofrece buena aceleración y rendimiento. Tamaño más pequeño que ofrece un diámetro extragrande.

Three blade stainless steel propeller. Offers good acceleration & all-round performance. Smaller pitch sizes offered in extra large diameter with increased blade area.

Eliche di acciaio inox a 3 pale. Buona accelerazione. Piccole dimensioni che offre un più grande diametro.

Hélice inox 3 pales, offrant de bonnes accélérations et performances. Taille de pas réduite pour les modèles de grands diamètres avec une surface de pale plus importante.

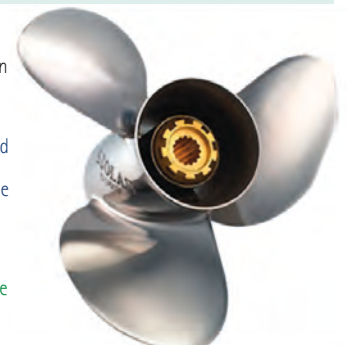

GUÍA DE HÉLICES CON NÚCLEO INTEGRADO

PROPELLERS APPLICATION WITH RUBBER HUB

GUIDA ELICHE CON MOZZO

GUIDE DES HELICES ET MOYEUX

| | 2T STROKES | 4T STROKES | R.O. OEM | A | G | B | D | P | R | AL | INOX STAINLESS STEEL | |
|--|-------------------|---------------|-----------------|-----|----------------|------------|-------------------|----|---|------------------|-------------------------|------------|
| 2.5 - 6 HP | ✓ | ✓ | 6L5-45949-00-EL | 9 | | | 7 ^{1/4} | 5 | R | SOL3011-073-05S | AMITA 3 | |
| | | | 6E0-45943-01-EL | | | | 7 ^{1/2} | 7 | R | SOL3011-075-07S | AMITA 3 | |
| | | | 6L5-45943-00-EL | | | | 7 ^{1/4} | 6 | R | PAF2.6-03010000 | | |
| | | | 6E0-45943-01-EL | | | | 7 ^{1/2} | 7 | R | PAF4-03070000 | | |
| 6.8 HP F6, F8, F9.9 | ✓ | ✓ | 6G1-45947-00-EL | 7 | | 3 | 8 ^{1/2} | 7 | R | SOL3011-085-07 | AMITA 3 | |
| | | | 6G1-45943-00-EL | | | | 8 ^{1/2} | 8 | R | SOL3011-085-08 | AMITA 3 | |
| | | | 6G1-45941-00-EL | | | | 8 ^{1/2} | 9 | R | SOL3011-085-09 | AMITA 3 | |
| 8 HP (1976-83) | ✓ | | 647-45943-00-EL | PIN | | 3 | 8 ^{3/4} | 8 | R | SOL2011-083-08P | AMITA 3 | |
| | | | | | | | 9 | 7 | R | SOL3011-090-07-P | AMITA 3 | |
| 9.9 15 T8 T9.9 F9.9 (2000-07) F15 F20 Hight Thrust | ✓ | ✓ | 683-45947-00-EL | 8 | 2 1/2 | 3 | 9 ^{1/4} | 7 | R | SOL3111-093-07 | AMITA 3 | |
| | | | 683-45945-00-EL | | | | 9 ^{1/4} | 8 | R | SOL3111-093-08 | AMITA 3 | |
| | | | 683-45942-00-EL | | | | 9 ^{1/4} | 9 | | SOL3111-093-09 | AMITA 3 | |
| | | | 683-45943-00-EL | | | | 9 ^{1/4} | 10 | R | SOL3111-093-10 | AMITA 3 | |
| | | | 63V-45943-10-00 | | | | 9 ^{1/4} | 11 | R | SOL3111-093-11 | AMITA 3 | |
| | | | 683-45941-00-00 | | | | 9 ^{1/4} | 11 | R | PAF15-06090000 | | |
| | | | 683-45941-00-00 | | | | 9 ^{1/4} | 12 | R | SOL3111-093-12 | AMITA 3 | |
| 20 (1996-97) 25 (1980 +) 30 (1979 +) F25 | ✓ | ✓ | 664-45941-01-EL | 10 | 3 | 3 | 9 ^{7/8} | 9 | R | SOL3211-099-09 | | |
| | | | 664-45945-00-EL | | | | 9 ^{7/8} | 10 | R | SOL3211-099-10 | | |
| | | | 664-45947-01-EL | | | | 9 ^{7/8} | 11 | R | SOL3211-099-11 | | |
| | | | 664-45954-00-EL | | | | 9 ^{7/8} | 12 | R | SOL3211-099-12 | | |
| | | | 664-45949-02-EL | | | | 9 ^{7/8} | 13 | R | SOL3211-099-13 | | |
| | | | 664-45972-00-98 | | | | 10 ^{3/4} | 10 | R | | SOL3231-108-10 | NEW SATURN |
| | | | 664-45970-00-98 | | | | 10 ^{1/2} | 11 | R | | SOL3231-105-11 | NEW SATURN |
| MAR-6YT30-02-12 | 10 ^{1/4} | 12 | R | | SOL3231-103-12 | NEW SATURN | | | | | | |
| 40 48 50 (NO T50) 55 60 (-1991) F30 F40 (1999+) F50 (1995+) F60 (1999+) | | | 663-45956-01-EL | 13 | 3 1/2 | 3 | 10 ^{1/8} | 13 | R | SOL3311-101-13 | | |
| | | | 663-45947-02-EL | | | | 10 ^{1/8} | 13 | R | SOL3311-101-13 | | |
| | | | 663-45952-02-EL | | | | 10 ^{1/8} | 13 | R | SOL3311-101-13 | | |
| | | | 663-45945-02-EL | | | | 10 ^{1/8} | 13 | R | SOL3311-101-13 | | |
| | | | 69W-45941-00-EL | | | | 10 ^{1/8} | 13 | R | PAT40-04070000 | | |
| | | | 663-45958-01-EL | | | | 11 ^{1/4} | 14 | R | SOL3311-111-14 | AMITA 3 | |
| | | | 663-45943-02-EL | | | | 11 | 15 | R | SOL3311-110-15 | AMITA 3 | |
| | | | 663-45949-01-EL | | | | 10 ^{3/4} | 16 | R | SOL3311-110-16 | AMITA 3 | |
| | | | 663-45941-01-EL | | | | 11 | 17 | R | SOL3311-110-17 | AMITA 3 | |
| | | | | | | | 11 ^{7/8} | 10 | R | | SOL3331-119-10 | NEW SATURN |
| | | | | | | | 11 ^{5/8} | 11 | R | | SOL3331-116-11 | NEW SATURN |
| | | | | | | | 11 ^{3/8} | 12 | R | | SOL3331-114-12 | NEW SATURN |
| | | | | | | | 11 ^{1/8} | 13 | R | | SOL3331-111-13 | NEW SATURN |
| | 11 ^{1/8} | 14 | R | | SOL3331-111-14 | NEW SATURN | | | | | | |
| 40 HP | | | | PIN | | 3 | 11 ^{1/2} | 10 | R | SOL3311-115-10-P | AMITA 3 | |
| | | | | | | | 11 ^{1/2} | 11 | R | SOL3311-115-11-P | AMITA 3 | |
| | | | | | | | 11 ^{1/2} | 12 | R | SOL3311-115-12-P | AMITA 3 | |
| 60 (1992+) 70 (1984+) 75 (1994+) 80 (1978-89) 85 (1991-97) 90 (1984+) 115 (1984+) 130 (1984+) F75 (2003+) F80 (1999+) F90 (2003+) F100 (1999+) F115 (2000+) T50 (1996+) T60 (2003+) F70 (2010+) | | | 6E5-45954-00-EL | 15 | 4 1/4 | 3 | 14 | 11 | R | SOL3411-140-11 | AMITA 3 | |
| | | | 6E5-45949-00-EL | | | | 13 ^{1/4} | 13 | R | SOL3411-138-13 | AMITA 3 | |
| | | | | | | | 13 ^{3/8} | 13 | L | SOL3412-138-13 | AMITA 4 | |
| | | | 6E5-45947-00-EL | | | | 13 ^{1/2} | 15 | R | SOL3411-135-15 | AMITA 3 | |
| | | | | | | | 13 ^{1/2} | 15 | L | SOL3413-130-15 | AMITA 4 | |
| | | | | | | | 13 ^{1/2} | 15 | L | SOL3412-135-15 | | |
| | | | 6E5-45945-00-EL | | | | 13 ^{1/4} | 17 | R | SOL3411-133-17 | AMITA 3 | |
| | | | | | | | 13 ^{1/4} | 17 | L | SOL3413-128-17 | AMITA 4 | |
| | | | | | | | 13 ^{1/4} | 17 | L | SOL3412-133-17 | | |
| | | | 6E5-45941-00-EL | | | | 13 | 19 | R | SOL3411-130-19 | AMITA 3 | |
| | | | | | | | 13 | 19 | R | SOL3413-125-19 | AMITA 4 | |
| | | | 6E5-45943-00-EL | | | | 13 | 21 | R | SOL3411-130-21 | AMITA 3 | |
| | | | | | | | 13 | 21 | R | SOL3413-125-21 | AMITA 4 | |
| | | | 688-45978-60-98 | | | | 13 ^{1/2} | 15 | R | | SOL3431-135-15 | NEW SATURN |
| | | | 688-45930-02-98 | | | | 13 | 17 | R | | SOL3431-133-17 | NEW SATURN |
| | | | | | | | 13 | 17 | L | | SOL3432-133-17 | NEW SATURN |
| | | | 688-45970-03-98 | | | | 13 | 19 | R | | SOL3431-130-19 | NEW SATURN |
| | 13 | 19 | L | | SOL3432-130-19 | NEW SATURN | | | | | | |
| 688-45972-02-98 | 13 | 21 | R | | SOL3431-130-21 | NEW SATURN | | | | | | |

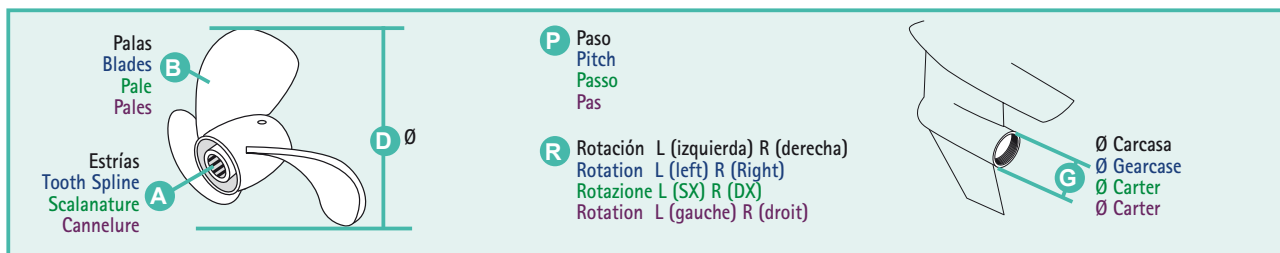

| 2T STROKES | 4T STROKES | R.O. OEM | A | G | B | D | P | R | AL | INOX STAINLESS STEEL | |
|-------------------|---------------|-----------------|---|---|---|-------------------|----|---|----------------------------------|-------------------------|------------|
| | | | | | | | | | | | |
| | | 6G5-45941-00-98 | | | | 15 | 15 | R | SOL3511-150-15 SOL3513-148-15 | | |
| | | 6G5-45952-00-98 | | | | 15 | 15 | L | SOL3512-150-15 SOL3514-148-15 | AMITA 3 AMITA 4 | |
| | | 6G5-45947-01-98 | | | | 14,8 | 17 | R | SOL3511-148-17 SOL3513-145-17 | AMITA 3 AMITA 4 | |
| | | 6K1-45947-00-98 | | | | 14,8 | 17 | L | SOL3512-148-17 SOL3514-145-17 | AMITA 3 AMITA 4 | |
| | | 6G5-45945-01-98 | | | | 14,5 | 19 | R | SOL3511-145-19 SOL3513-143-19 | AMITA 3 AMITA 4 | |
| | | 6K1-45945-01-98 | | | | 14,5 | 19 | L | SOL3512-145-19 SOL3514-143-19 | AMITA 3 AMITA 4 | |
| | | 6G5-45949-00-98 | | | | 14,3 | 21 | R | SOL3511-143-21 SOL3513-140-21 | AMITA 3 AMITA 4 | |
| 150 (1986+) | | | | | | 14,3 | 21 | L | SOL3512-143-21 SOL3514-140-21 | AMITA 3 AMITA 4 | |
| 175 (1984+) | | | | | | | | | | | |
| 200 (1984+) | | | | | | | | | | | |
| 200VMAX (2001+) | | 6G5-45949-00-98 | | | | 14,2 | 23 | R | SOL3511-142-23 | AMITA 3 | |
| 220 (1987-88) | | | | | | 14,2 | 23 | L | SOL3512-142-23 | AMITA 3 | |
| 225 (1986+) | | | | | | | | | | | |
| 250 (1990+) | | 6G5-45941-00-98 | | | | 15 ^{3/4} | 15 | R | | SOL3571-158-15 | LEXOR |
| 225VMAX (2001+) | | 6G5-45952-00-98 | | | | 15 ^{3/4} | 15 | L | | SOL3572-158-15 | LEXOR |
| 300 (2004+) | | 6G5-45947-01-98 | | | | 15 ^{1/2} | 17 | R | | SOL3571-155-17 | LEXOR |
| F150 (2004+) | | 6K1-45947-00-98 | | | | 15 ^{1/2} | 17 | L | | SOL3572-155-17 | LEXOR |
| F200 (2002+) | | 6G5-45945-01-98 | | | | 15 ^{1/4} | 19 | R | | SOL3571-153-19 | LEXOR |
| F225 (2002+) | | 6K1-45945-01-98 | | | | 15 ^{1/4} | 19 | L | | SOL3572-153-19 | LEXOR |
| F250 (2005+) | | 6G5-45949-00-98 | | | | 15 | 21 | R | | SOL3571-150-21 | LEXOR |
| F300 (2003+) | | | | | | 15 | 21 | R | | SOL3572-150-21 | LEXOR |
| dentro-fueraborda | | 6G5-45949-00-98 | | | | 14 | 23 | R | | SOL3571-148-23 | LEXOR |
| Intro-outboard | | | | | | 14 | 23 | L | | SOL3572-148-23 | LEXOR |
| Intro-Fuoribordo | | | | | | 14 | 25 | R | | SOL3571-145-25 | LEXOR |
| Intro-horsbord | | | | | | 14 | 27 | R | | SOL3571-145-27 | LEXOR |
| 3.0L-7.4L | | 6G5-45970-02-98 | | | | 15 ^{1/4} | 15 | R | | SOL3531-145-15 | NEW SATURN |
| | | 6K1-45970-01-98 | | | | 15 ^{1/4} | 15 | L | | SOL3532-145-15 | NEW SATURN |
| | | 6G5-45978-03-98 | | | | 13 ^{3/4} | 17 | R | | SOL3531-143-17 | NEW SATURN |
| | | 6K1-45978-02-98 | | | | 13 ^{3/4} | 17 | L | | SOL3532-143-17 | NEW SATURN |
| | | 6G5-45974-03-98 | | | | 13 ^{3/4} | 19 | R | | SOL3531-140-19 | NEW SATURN |
| | | 6K1-45974-02-98 | | | | 13 ^{3/4} | 19 | L | | SOL3532-140-19 | NEW SATURN |
| | | 6G5-45972-02-98 | | | | 13 ^{3/4} | 21 | R | | SOL3531-140-21 | NEW SATURN |
| | | 6K1-45972-01-98 | | | | 13 ^{3/4} | 21 | L | | SOL3532-140-21 | NEW SATURN |
| | | 6G5-45976-01-98 | | | | 13 ^{3/8} | 23 | R | | SOL3531-140-23 | NEW SATURN |
| | | 6K1-45976-00-98 | | | | 13 ^{3/8} | 23 | L | | SOL3532-140-23 | NEW SATURN |

HÉLICES PARA NÚCLEO INTERCAMBIABLE

PROPELLERS FOR INTERCHANGEABLE HUB

ELICHE PER MOZZO INTERCAMBIABILE

HELICES AVEC MOYEU INTERCHANGEABLE

| | B | D | P | R | AL |
|------------------------|----|-------|----------------|---|----------------|
| C 30-75 HP | 3 | 12.1 | 9 | R | SOL9311-121-09 |
| | | 12 | 10 | R | SOL9311-120-10 |
| | | 11-6 | 11 | R | SOL9311-116-11 |
| | | 11.4 | 12 | R | SOL9311-114-12 |
| | | 11.1 | 13 | R | SOL9311-111-13 |
| | | 11.1 | 14 | R | SOL9311-111-14 |
| D 40-140 HP | 3 | 14 | 9 | R | SOL9411-140-09 |
| | | 14 | 11 | R | SOL9411-140-11 |
| | | 13.75 | 13 | R | SOL9411-138-13 |
| | | 13.50 | 15 | R | SOL9411-135-15 |
| | | 13.25 | 17 | R | SOL9411-133-17 |
| | | 13.2 | 19 | R | SOL9411-132-19 |
| E 135-350 HP | 3 | 15.5 | 11 | R | SOL9511-155-11 |
| | | 15.3 | 13 | R | SOL9511-153-13 |
| | | 16 | 13 | R | SOL9511-160-13 |
| | | 15 | 15 | R | SOL9511-150-15 |
| | | 15 | 15 | L | SOL9511-150-15 |
| | | 14.8 | 17 | R | SOL9511-148-17 |
| | | 14.8 | 17 | L | SOL9511-148-17 |
| | | 14.5 | 19 | R | SOL9511-145-19 |
| | | 14.5 | 19 | L | SOL9511-145-19 |
| | | 14.3 | 21 | R | SOL9511-143-21 |
| 14.3 | 21 | L | SOL9511-143-21 | | |

| | B | D | P | R | INOX STAINLESS STEEL |
|------------------------|----|-----------------------|----------------|-------------------|-------------------------|
| C 30-75 HP | 3 | 11 ^{5/8} | 11 | R | SOL9331-116-11 |
| | | 11 ^{3/8} | 12 | R | SOL9331-114-12 |
| | | 11 ^{1/8} | 13 | R | SOL9331-111-13 |
| | | 11 ^{1/8} | 14 | R | SOL9331-111-14 |
| | | 11 | 15 | R | SOL9331-110-15 |
| | | D 40-140 HP | 3 | 13 ^{3/4} | 13 |
| 13 ^{3/4} | 13 | | | L | SOL9432-138-13 |
| 13 ^{1/2} | 15 | | | R | SOL9431-135-15 |
| 13 ^{1/2} | 15 | | | L | SOL9432-135-15 |
| 13 ^{1/4} | 17 | | | R | SOL9431-133-17 |
| 13 ^{1/4} | 17 | | | L | SOL9432-133-17 |
| E 90-140 HP | 3 | 13 | 19 | R | SOL9431-130-19 |
| | | 13 | 19 | L | SOL9432-130-19 |
| | | 13 | 21 | R | SOL9431-130-21 |
| | | 14 ^{1/2} | 15 | R | SOL9531-145-15 |
| | | 14 ^{1/2} | 15 | L | SOL9532-145-15 |
| | | 14 ^{1/4} | 17 | R | SOL9531-143-17 |
| | | 14 ^{1/4} | 17 | L | SOL9532-143-17 |
| | | 14 | 19 | R | SOL9531-140-19 |
| | | 14 | 19 | L | SOL9532-140-19 |
| | | 14 | 21 | R | SOL9531-140-21 |
| E 135-350 HP | 3 | 14 | 21 | L | SOL9532-140-21 |
| | | 14 | 23 | R | SOL9531-140-23 |
| | | 14 | 23 | L | SOL9532-140-23 |
| | | 15 ^{3/4} | 15 | R | SOL9571-158-15 |
| | | 15 ^{3/4} | 15 | L | SOL9572-158-15 |
| | | 15 ^{1/2} | 17 | R | SOL9571-155-17 |
| | | 15 ^{1/2} | 17 | L | SOL9572-155-17 |
| | | 15 ^{1/4} | 19 | R | SOL9571-153-19 |
| | | 15 ^{1/4} | 19 | L | SOL9572-153-19 |
| | | 15 | 21 | R | SOL9571-150-21 |
| 15 | 21 | L | SOL9572-150-21 | | |
| E 135-350 HP | 3 | 14 ^{3/4} | 23 | R | SOL9571-148-23 |
| | | 14 ^{3/4} | 23 | L | SOL9572-148-23 |
| | | 14 ^{1/2} | 25 | R | SOL9571-145-25 |
| | | 14 ^{1/2} | 25 | L | SOL9572-145-25 |

RUBEX





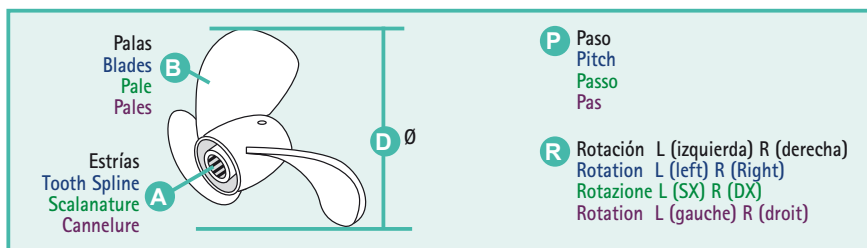

Núcleo intercambiable (no incluido).
Interchangeable hub (not included).
Mozzo intercambiable (non incluso).
Moyaux interchangeable (non inclus)



NÚCLEO INTERCAMBIABLE INTERCHANGEABLE HUB

MOZZO INTERCAMBIABILE

MOYEU INTERCHANGEABLE

|  |    | | REF |  |
|---|---|---------------|---------------|---|
| | 2T STROKES | 4T STROKES | | |
| F30 (2001-05) F40 (1999+); F50 (1995+) F60 (1999+) | | ✓ | 13 SOLRBX-117 | C |
| 40HP et 50HP (not T50), (1984+) 48HP (1995+) 55HP (1976-95) 60HP (1976-91) | | | 13 SOLRBX-117 | C |
| T50 (1996+) | | | 15 SOLRBX-108 | D |
| 60-100 HP (1984+) | ✓ | ✓ | 15 SOLRBX-108 | D |
| 80-140HP, (1978-83) | | | 15 SOLRBX-102 | D |
| 115HP FS115 | | ✓ | 15 SOLRBX-103 | D |
| 130HP, (1984+) | | | 15 SOLRBX-103 | D |
| 150-175HP, (1978-83) | | | 15 SOLRBX-102 | E |
| 150-300HP, (1984+) | | | 15 SOLRBX-103 | E |
| 225 EFI | | ✓ | 15 SOLRBX-103 | E |
| F300, F350 | | | 17 SOLRBX-127 | E+ |
| 300, 350HP, V8 | | ✓ | 17 SOLRBX-127 | E+ |
| Stern drives, (1989-93) | | | 15 SOLRBX-103 | E |



RUBEX

GUÍA DE RECAMBIOS DE HELICE

PROPELLER SPARE PARTS

GUIDA RICAMBIO ELICHE

GUIDE DES PIECES POUR HELICE

|  | 1 | 2 | 3 | 4 | 5 |
|---|-----------------|-----------------|----------------|-------------------|-----------------|
| F2.5A, F4B, F5A, F6C | PAF4-03000025 | | PAF4-03000026 | PAF4-03080000 | PAGB/T91-1.6X12 |
| F8C, F8F | | | REC90201-10M01 | REC90171-10M01 | REC91490-30025 |
| F9.9J | | | REC90201-10M01 | REC90171-10M01 | REC91490-30025 |
| F15C, F20B | REC6E7-45987-00 | | REC90201-10M01 | REC90171-10M01 | REC91490-30025 |
| F25D | REC6L2-45987-00 | REC689-45997-00 | PAGB/T97.1-14 | REC90171-14013-00 | REC91490-30030 |
| FT25F | REC663-45987-00 | | REC92990-16200 | REC90171-16011 | REC91490-30030 |
| F30, F40F, F50H, F60F | REC663-45987-00 | REC66T-45997-00 | REC90389-22M01 | REC90171-16011 | REC91490-30030 |
| FT50J, FT60G | REC688-45987-00 | REC67F-45997-00 | REC90389-25M00 | REC90171-16011 | REC91490-30030 |
| F70A, F80B, F100D | REC688-45987-00 | REC67F-45997-00 | REC90389-25M00 | REC90171-16011 | REC91490-30030 |
| F(L) 115A, F(L) 115B, F130A, F(L)150A, F(L)150D, F175A, F(L)200F | REC6E5-45987-00 | REC688-45997-00 | REC92990-18200 | REC90171-18M04 | REC91490-40030 |
| F(L)225F, F(L)250D, F(L)300B (4.2L) V6 | | REC688-45997-00 | REC92990-18200 | REC90171-18M04 | REC91490-40030 |

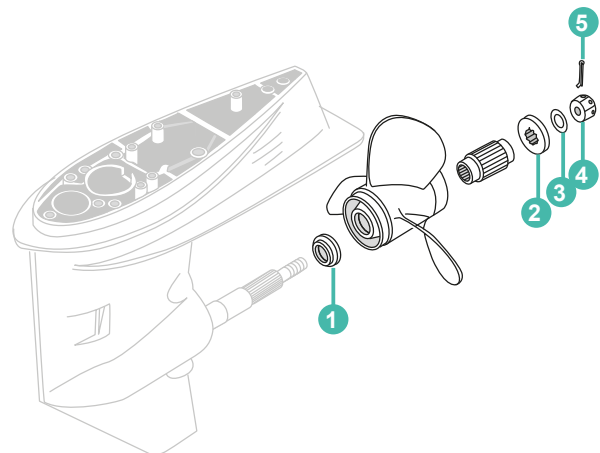

YAMAHA

RECAMBIOS MARINOS

REF --> RO / OEM

| REF | R.O. / OEM | |
|-----------------|-----------------|-------------------------------------|
| C | | |
| CEF500302 | 6G1-44352-00 | 143 |
| CEF500316 | 6H3-44352-00 | 143 |
| CEF500320 | 682-44352-03 | 143 |
| CEF500321 | 662-44352-01 | 143 |
| CEF500322 | 6L5-44352-00 | 143 |
| CEF500323 | 688-44352-03 | 143 |
| CEF500324 | 646-44352-01 | 143 |
| CEF500325 | 6E0-44352-00 | 143 |
| CEF500326 | 689-44352-02 | 143 |
| CEF500352 | 6F5-44352-00 | 143 |
| CEF500363 | 63V-44352-01 | 143 |
| CEF500364 | 67F-44352-00 | 143 |
| CEF500368 | 68T-44352-00 | 143 |
| CEF500371 | 6E5-44352-01 | 143 |
| CEF500384 | 6L2-44352-00 | 143 |
| CEF500385G | 6H4-44352-02 | 143 |
| CEF500389N | 6AW-44352-00 | 143-155 |
| CEF500401N | 6CE-44352-00 | 143 |
| CHAL77JC4 | | 108 |
| CHAL82C | | 108 |
| CHAL90C | | 108 |
| CHAQL77JC4 | | 108 |
| CHAQL78C | | 108 |
| CHAQL82C | | 108 |
| CHAQL86C | | 108 |
| CHARA8HC | | 108 |
| CHARC12YC | | 108 |
| CHARC9YC4 | | 108 |
| CHAZ9Y | | 108 |
| CM15008 | 66M-11325-00 | 159 |
| CM15008A | 66M-11325-00 | 159 |
| CM15026 | 6E5-11325-00 | 158-169 |
| CM15026A | 6E5-11325-00 | 65-70-72-73-158-169-187-209-213 |
| CM3082523 | 689-11325-00 | 158 |
| CM41106-ZW000 | 41106-ZW-000 | 158 |
| CM42121 | | 159 |
| CM43107M | 677-45251-00 | 169 |
| CM61A-11325-00 | 61A-11325-00 | 161 |
| CM61A-45371-00 | 61A-45371-00 | 160-169-383 |
| CM61A-45371-00A | 61A-45371-00 | 160-169-331-335-337 |
| CM61N-45251-01 | 61N-45251-01 | 160-169-291-351-355 |
| CM61N-45251-01A | 61N-45251-01 | 65-66-160-169 |
| CM62Y-11325-00 | 62Y-11325-00 | 158 |
| CM62Y-11325-00A | 62Y-11325-00 | 65-66-67-68-69-158-197-203-205-207 |
| CM63D-45251-01 | 63D-45251-01 | 159-169 |
| CM63D-45251-01A | | 169 |
| CM63P-11325-01 | 63P-11325-00 | 161 |
| CM63P-11325-01 | 63P-11325-01 | 161 |
| CM63P-11325-01 | | 169 |
| CM63P-11325-01A | 63P-11325-00 | 161 |
| CM63P-11325-01A | 63P-11325-01 | 161-211-214 |
| CM63P-11325-01A | | 70-71-73 |
| CM63P-11325-11 | 63P-11325-11 | 161-169 |
| CM63P-11325-11A | 63P-11325-11 | 71-73-161-211 |
| CM664-45371-01 | 664-45371-01 | 169-357-359-361 |
| CM664-45371-01 | 664-45371-01-00 | 353 |
| CM664-45371-01 | 664-45371-01A | 160 |
| CM664-45371-01A | 664-45371-01A | 66-160-169 |
| CM66M-11325-00A | | 65 |
| CM66M-45371-00 | 66M-45371-00 | 159-169-291 |
| CM679-45251-00 | 679-45251-00 | 160 |
| CM679-45251-00A | 679-45251-00 | 160 |
| CM67C-45251-00 | 67C-45251-00 | 158-169-361 |
| CM67C-45251-00A | 67C-45251-00 | 66-67-69-158-299-303-307-311 |
| CM67C-45371-00 | 67C-45371-00 | 160-169 |
| CM67C-45371-00A | 67C-45371-00 | 66-67-68-69-160-169-299-303-307-311 |
| CM67F-11325-00 | 67F-11325-00 | 159 |
| CM67F-11325-01 | 67F-11325-01 | 161 |
| CM67F-11325-01A | 67F-11325-01 | 70-71-72-73-161-211-213 |
| CM67F-45371-00 | 67F-45371-00 | 70-161 |
| CM67F-45371-00A | 67F-45371-00 | 68-69-161-315-319 |
| CM688-45251-01 | 688-45251-01 | 158-169 |
| CM688-45251-01A | 688-45251-01 | 67-68-69-158-169 |
| CM688-45371-02 | 688-45371-02 | 371 |
| CM688-45371-02 | 688-45371-02 | 160-169 |
| CM688-45371-02 | 688-45371-02-00 | 373 |
| CM688-45371-02A | | 160-169 |
| CM689-11325-00A | 689-11325-00 | 158 |
| CM68T-11325-00 | 68T-11325-00 | 161 |
| CM68T-11325-00A | 68T-11325-00 | 71-72-73-161-211 |
| CM68T-45251-00 | 68T-45251-00 | 158-169 |
| CM68T-45251-00A | 68T-45251-00 | 64-65-158-169-289 |
| CM68V-11325-01 | 68V-11325-01 | 158 |
| CM68V-11325-01A | 68V-11325-01 | 158 |
| CM68V-11325-01A | 68V-11325-02 | 209 |
| CM68V-11325-01A | | 69 |
| CM69L-45371-00 | 69L-45371-00 | 160-169 |
| CM69L-45371-00A | 69L-45371-00 | 160-169 |
| CM6AW-45251-00 | 6AW-45251-00 | 161-169 |

| REF | R.O. / OEM | |
|-----------------|-----------------|--------------------------------|
| CM6AW-45251-00A | 6AW-45251-00 | 72-161-169 |
| CM6AW-45373-00 | 6AW-45373-00 | 161-169 |
| CM6AW-45373-00A | 6AW-45373-00 | 161-169-341 |
| CM6AW-45619-00 | 6AW-45619-00 | 161 |
| CM6AW-45619-00A | 6AW-45619-00 | 161-341 |
| CM6BL-11325-00 | 6BL-11325-00 | 161 |
| CM6BL-11325-00A | 6BL-11325-00 | 66-161-195 |
| CM6E0-45251-11 | 6E0-45251-11 | 347 |
| CM6E0-45251-11 | 6E0-45251-11-00 | 158 |
| CM6E0-45251-11 | 6E0-45251-11 | 169 |
| CM6E0-45251-11A | 6E0-45251-11-00 | 65-66-67-68-69-158-169 |
| CM6E5-45251-00 | 6E5-45251-00 | 158-169 |
| CM6E5-45251-00A | | 66-158-169 |
| CM6E5-45371-01A | 6E5-45371-00 | 323 |
| CM6E5-45371-01A | 6E5-45371-01 | 161-379 |
| CM6E5-45371-01A | | 70-71-169 |
| CM6E5-45371-10 | 6E5-45371-10 | 160 |
| CM6E8-45251-00 | 6E8-45251-00 | 159 |
| CM6E8-45251-01 | 6E8-45251-02 | 159-169 |
| CM6G1-45251-02 | 6G1-45251-02 | 159-169 |
| CM6G1-45251-03 | 6G1-45251-03 | 159 |
| CM6G1-45251-03 | 6GH-45251-00 | 159 |
| CM6G1-45251-03 | 6N0-WG525-00 | 159 |
| CM6G1-45251-03 | 6G1-45251-03 | 169 |
| CM6G5-45251-01 | 6G5-45251-01 | 158-169 |
| CM6G5-45251-01A | 6G5-45251-01 | 70-158-169 |
| CM6G8-11325-00 | 6G8-11325-00 | 159-169-181 |
| CM6G8-11325-00A | 6G8-11325-00 | 65-159-180-187-195-201-203-205 |
| CM6G8-45251-01 | 6G8-45251-00 | 159-169 |
| CM6H1-45251-01 | 6H1-45251-01 | 158-169 |
| CM6H1-45251-01A | 6H1-45251-01 | 158 |
| CM6H1-45251-02 | 6H14525102 | 158-169 |
| CM6H1-45251-02A | 6H14525102 | 69-70-71-158-169 |
| CM6H3-11325-01A | 6H3-11325-01 | 241 |
| CM6J9-45371-01 | 6J9-45371-01 | 160-169 |
| CM6J9-45371-01A | 6J9-45371-01 | 72-160-169-327 |
| CM6K1-45371-00 | 6K1-45371-00 | 161-169 |
| CM6K1-45371-00A | 6K1-45371-00 | 161-169 |
| CM6K1-45371-02 | 6J9-45371-02 | 160-169 |
| CM6K1-45371-02A | 6J9-45371-02 | 72-160-169 |
| CM6L5-45251-02 | 6L5-45251-02 | 159-169-343 |
| CM6L5-45251-02 | 6L5-45251-03 | 345 |
| CM6L5-45251-02A | 6LD-G5251-00 | 287 |
| CM6L5-45251-02A | 6L5-45251-02 | 159 |
| CM6L5-45251-02A | | 64-169 |
| CM6T4-45836-00 | 6T4-45836-00 | 159 |
| CM6T5-45371-00 | 6T5-45371-00 | 161 |
| CM6T5-45373-00 | 6T545373-00 | 159 |
| CM6U0-45251-00 | 6U0-45251-00 | 159-169 |
| CM6U4-45251-00 | 6U4-45251-00 | 158-169 |
| CM825171 | | 158 |
| CM82795M | | 160 |
| CM82795MA | | 160 |
| CM85007 | 688-11325-00 | 160 |
| CM85007A | 688-11325-00 | 160 |
| CMY150CRKITA | | 71-162 |
| CMY150CRKITEM | | 162 |
| CMY150KITA | | 71-162 |
| CMY150KITM | | 162 |
| CMY200250KITA | | 72-73-162 |
| CMY200250KITM | | 162 |
| CMY200300KITA | | 162 |
| CMY300350KITA | | 73-162 |
| CMY300350KITM | | 162 |
| CMY300350XPKITA | | 73-162 |
| CMY300350XPKITM | | 162 |
| CMY4050KITA | | 162 |
| CMY4050KITM | | 162 |
| CMY4060KITA | | 162 |
| CMY4060KITM | | 162 |
| CMY6090KITA | | 162 |
| CMY6090KITM | | 162 |
| CMY80100KITA | | 162 |
| CMY80100KITM | | 162 |
| CMYHP200300KITA | | 162 |
| G | | |
| GS11290 | | 121 |
| GS11291 | | 121 |
| GS11292 | | 121 |
| GS11294 | | 121 |
| GS30435 | | 80 |
| GS31001 | | 80 |
| GS31002 | | 80 |
| GS31020 | | 77 |
| GS31064 | | 77 |
| GS31065 | YMM-2FE10-00 | 79 |
| GS31066 | YMM-2FS08-00 | 79 |
| GS31067 | YMM-2FS10-00 | 79 |
| GS31068 | | 76 |
| GS31069 | | 76 |
| GS31073 | | 77 |
| GS31074 | 6Y1-24305-05-00 | 76 |
| GS31074 | 6Y1-24305-06 | 76 |
| GS31074 | 6Y1-24305-06-00 | 76 |
| GS31074 | 6YL-24305-01-00 | 76 |
| GS31075 | 6G1-24305-00 | 76 |
| GS31075 | 6G1-24305-01 | 76 |
| GS31075 | 6G1-24305-02 | 76 |

| REF | R.O. / OEM | |
|-------------|-----------------|--------------------------------|
| GS31075 | 6G1-24305-02-00 | 76 |
| GS31075 | 6G1-24305-03 | 76 |
| GS31075 | 6G1-24305-03-00 | 76 |
| GS31075 | 6G1-24305-04 | 76 |
| GS31075 | 6G1-24305-04-00 | 76 |
| GS31075 | 6G1-24305-05 | 76 |
| GS31075 | 6G1-24305-05-00 | 76 |
| GS31075 | 6G1-24305-0500 | 76 |
| GS31075 | 6Y1-24305-00 | 76 |
| GS31075 | 6Y1-24305-01 | 76 |
| GS31075 | 6Y1-24305-02 | 76 |
| GS31075 | 6Y1-24305-05-00 | 76 |
| GS31075 | 6Y1-24305-06-00 | 76 |
| GS31075 | 6YL-24305-01-00 | 76 |
| GS31076 | 6E5-24305-05-00 | 76 |
| GS31076 | 6E5-24305-06 | 76 |
| GS31076 | 6E5-24305-06-00 | 76 |
| GS31076 | 6Y2-24305-05-00 | 76 |
| GS31076 | 6Y2-24305-06-00 | 76 |
| GS31076 | 6YK-24305-01-00 | 76 |
| GS31090 | 6Y2-24360-52 | 74 |
| GS31092 | | 77 |
| GS31095 | | 74 |
| GS31096 | | 74 |
| GS31097 | | 74 |
| GS31099 | | 74 |
| GS31155 | | 79 |
| GS31156 | | 79 |
| GS31157 | | 79 |
| GS31166 | YMM-2FE08-00 | 79 |
| GS31183 | 6Y1-24360-52-00 | 74 |
| GS31183 | 6Y1-24360-52-01 | 74 |
| GS31183 | 6Y1-24360-52-02 | 74 |
| GS31183 | 6Y1-24360-52-51 | 74 |
| GS31183 | 6Y1-24360-52-52 | 74 |
| GS31187 | 6Y1-24360-52 | 74 |
| GS35031 | 90890-56878 | 75 |
| GS35032 | 90790-77001 | 75 |
| GS40015 | YMD-RCBOX-00-10 | 127 |
| GS41084 | 6E5-61301-00 | 131 |
| GS41084 | 6E5-61301-01 | 131 |
| N | | |
| NGKB7HS | 94702-00040 | 220-235-239 |
| NGKB7HS-10 | 94702-00217 | 225-229 |
| NGKB7HS-10 | 94702-00271 | 227 |
| NGKB8HS | 94702-00041 | 239 |
| NGKB8HS-10 | 90472-00247 | 243 |
| NGKB8HS-10 | 94702-00160 | 239 |
| NGKBKR6EUK | 94702-00405-00 | 108 |
| NGKBKR7EUK | 94702-00404-00 | 108 |
| NGKBPR7HS | 94702-00248 | 175 |
| NGKBR5HS | 94702-00249-00 | 108 |
| NGKBR6FS | 94701-00365-00 | 108 |
| NGKBR6HS | 94701-00248-00 | 108 |
| NGKBR6HS | 94702-00248 | 64-173 |
| NGKBR6HS-10 | 94702-00274 | 64-65-180-223 |
| NGKBR6HS-10 | 94702-00274-00 | 108 |
| NGKBR7HS | 94701-00110 | 108 |
| NGKBR7HS | 94701-00110-00 | 108 |
| NGKBR7HS | 94702-00272 | 221-233 |
| NGKBR7HS-10 | 94702-00271 | 223-229-231-237 |
| NGKBR7HS-10 | 94702-00271-00 | 108 |
| NGKBR8ES | 94701-00204 | 108 |
| NGKBR8ES-11 | 94702-00396 | 108 |
| NGKBR8HS | 94701-00195 | 108 |
| NGKBR8HS | 94701-00195-00 | 108 |
| NGKBR8HS-10 | 94702-00247 | 237-241-245 |
| NGKBR8HS-10 | 94702-00247-00 | 108 |
| NGKBR8HS-10 | 94702-00271 | 247 |
| NGKBR9HS-10 | 94701-00309-00 | 108 |
| NGKBR9HS-10 | 94702-00309 | 245 |
| NGKCR5HSB | 94701-00300-00 | 108 |
| NGKCR6HS | 94701-00282 | 181 |
| NGKCR6HS | 94701-00282-00 | 108 |
| NGKCR6HS | 94702-00372-00 | 108 |
| NGKCR6HSB | 94702-00372 | 64-173-179 |
| NGKCR9EB | 94702-00409 | 108 |
| NGKDRP5EA-9 | 94701-00406-00 | 69-108 |
| NGKDRP6EA-9 | 94701-00375 | 65-66-67-68-197-207 |
| NGKDRP6EA-9 | 94701-00375-00 | 108 |
| NGKDRP6EB-9 | 94702-00418 | 65-66-67-68-69-187-195-201-203 |
| NGKDRP6EB-9 | 94702-00418-00 | 108 |
| NGKDRP7EA-9 | 94701-00375 | 185-191 |
| NGKLF5A-11 | 94702-00391 | 69-70-71-72-209-211 |
| NGKLF5A-11 | 94702-00391-00 | 108 |
| NGKLF6A-11 | 94702-00400 | 70-72-73-213-214 |
| NGKLF6A-11 | 94702-00400-00 | 108 |
| NGKLR6E | 94702-00437-00 | 71-108 |
| NGKLR6E-9N | 94702-00440 | 70 |
| NGKLR7E | 94702-00429 | 69-205 |
| NGKLR7E | 94702-00429 | |

| REF | R.O. / OEM | |
|------------------|-----------------|---|
| PA166F-010008 | 67D-12157-00 | 173-175-179 |
| PA166F-010009 | 67D-12151-00 | 173-175-179 |
| PA166F-010010 | 7FK-12165-00 | 173-175-179 |
| PA166F-010011 | 7FK-12158-00 | 173-175-179 |
| PAE4-10040100W | 703-82563-00 | 122-128 |
| PAE4-10040100W | 703-82563-01 | 122-128 |
| PAE4-10040100W | 703-82563-02 | 128 |
| PAF15-00000001 | 63V-43131-00-4D | 132 |
| PAF15-00000001 | 66M-44551-00-4D | 132 |
| PAF15-00000002 | 682-44555-30 | 135 |
| PAF15-00000003 | 66M-44557-00 | 135 |
| PAF15-00000005 | 66M-45113-00 | 271 |
| PAF15-00000013 | 93604-10M03 | 201-317-351 |
| PAF15-00000013 | 93604-12M07 | 171-173-283-289-291-293-351 |
| PAF15-00000014 | 66M-11351-10 | 183-217-218-233 |
| PAF15-01000001 | 65F-42537-00 | 133 |
| PAF15-01000004 | 90386-30048 | 133 |
| PAF15-01000006 | 90386-30M60 | 134 |
| PAF15-01010001 | 63V-43131-00 | 132 |
| PAF15-01010001 | 63V-43131-01 | 132 |
| PAF15-01010001 | 63V-43131-10 | 132 |
| PAF15-01010007 | 63V-43145-00 | 132 |
| PAF15-01010007 | 90185-22043 | 132 |
| PAF15-01010007 | 90185-22M11 | 132 |
| PAF15-01010100 | 63V-43111-00-4D | 131 |
| PAF15-01010100 | 63V-43111-01-4D | 131 |
| PAF15-01010100 | 63V-43111-A2-4D | 131 |
| PAF15-01010200 | 63V-43112-00-4D | 131 |
| PAF15-01010200 | 63V-43112-01-4D | 131 |
| PAF15-01010200 | 63V-W4311-00-4D | 131 |
| PAF15-01010200 | 63V-W4311-03-4D | 131 |
| PAF15-01010200 | 63V-WS431-B6-8D | 131 |
| PAF15-01010301S | 63V-43311-00-4D | 131 |
| PAF15-01010301S | 63V-43311-01-4D | 131 |
| PAF15-01010301S | 99999-03116 | 131 |
| PAF15-01010302 | 90386-22M15 | 133 |
| PAF15-01030100 | 65W-42138-00 | 131 |
| PAF15-02000005L | 66M-44361-10 | 291 |
| PAF15-02000005S | 66M-44361-00 | 291 |
| PAF15-02000006 | 63V-44365-10 | 289-291-351 |
| PAF15-02010000 | 66M-44514-00-4D | 135 |
| PAF15-03000003 | 66M-45115-00 | 268 |
| PAF15-04000002 | 90340-14M00 | 237-241 |
| PAF15-04000002 | 90340-14M06 | 191-195-197-201-203-205-207-209-211-213 |
| PAF15-04000003 | 90430-14115 | 195-197-201-207-209-211-213-235-237-239-241 |
| PAF15-04000003 | 90430-14M09 | 65-66-67-68-69-70-71-72-73-191 |
| PAF15-04000005 | 676-11372-00 | 173-179-181-183-195-213-225-227-229-231-233 |
| PAF15-04000005 | 6H1-11372-00 | 187 |
| PAF15-04010004 | 66M-41138-00 | 268 |
| PAF15-05000009 | 6BL-44391-00 | 139 |
| PAF15-05000009 | 6H3-44391-00 | 139 |
| PAF15-05000009 | 6H3-44391-01 | 139 |
| PAF15-05000011 | 688-24378-00 | 183-191-195-197-207 |
| PAF15-05000012 | 90445-09061 | 183 |
| PAF15-05000013 | 90445-09086 | 183 |
| PAF15-05000014 | 90445-09104 | 183-197-207 |
| PAF15-05170300W | 6G1-81941-10 | 111-114 |
| PAF15-06000001 | 63V-45311-01-4D | 351 |
| PAF15-06000002 | 63V-45215-00 | 293-350 |
| PAF15-06000002 | 6G1-45215-00 | 289 |
| PAF15-06000003 | 6G1-45214-00 | 289-293-350 |
| PAF15-06000004 | 61N-45251-00 | 295 |
| PAF15-06000006 | 63V-45536-00 | 291-292-351 |
| PAF15-06000007 | 6E8-45587-10 | 293 |
| PAF15-06000008 | 6E8-45587-10-13 | 291-351 |
| PAF15-06000009 | 6E7-45587-01-30 | 348 |
| PAF15-06000009 | 6E8-45587-30 | 293 |
| PAF15-06000010-1 | 664-45567-01-10 | 291-351 |
| PAF15-06000010-1 | 664-45567-05 | 349 |
| PAF15-06000010-1 | 664-45567-01 | 293 |
| PAF15-06000010-2 | 664-45567-10 | 293 |
| PAF15-06000010-2 | 664-45567-12 | 349 |
| PAF15-06000010-3 | 664-45567-20 | 293 |
| PAF15-06000010-4 | 664-45567-30 | 293 |
| PAF15-06000010-5 | 664-45567-40 | 349 |
| PAF15-06000010-6 | 664-45567-50 | 293 |
| PAF15-06000010-7 | 664-4556-50 | 349 |
| PAF15-06000010-7 | 664-45567-60 | 293 |
| PAF15-06000014 | 63V-44328-00 | 289-291-351 |
| PAF15-06000014 | 63V-44328-01 | 293 |
| PAF15-06000015 | 6E7-45587-01 | 351 |
| PAF15-06000016 | 90171-10M01 | 349 |
| PAF15-06000020-1 | 90201-15017 | 293 |
| PAF15-06020005 | 63V-45375-00 | 289-291-292-351 |
| PAF15-06030000L | 63V-44150-10 | 291-351 |
| PAF15-06030000S | 63V-44150-00 | 291-351 |
| PAF15-06040000S | 63V-45510-00 | 291 |
| PAF15-06070002 | 90501-14M06 | 291-349-351 |
| PAF15-06070002 | 90501-150A0 | 293 |
| PAF15-06080000 | 683-45361-02-8D | 293 |

| REF | R.O. / OEM | |
|------------------|-----------------|---|
| PAF15-06080003 | 93210-56M80 | 231-291-293-351 |
| PAF15-06080006-1 | 626-45577-00 | 293-351 |
| PAF15-06080006-1 | 626-45577-00-01 | 291-349 |
| PAF15-06080006-2 | 626-45577-10 | 293 |
| PAF15-06080006-3 | 626-45577-00-03 | 349 |
| PAF15-06080006-3 | 626-45577-20 | 293 |
| PAF15-06080006-4 | 626-45577-30 | 293 |
| PAF15-06080006-5 | 626-45577-00-05 | 349 |
| PAF15-06090000 | 626-45577-40 | 293 |
| PAF15-06090000 | 63V-45943-10-00 | 402 |
| PAF15-06100000L | 66M-45300-11-4D | 277-291 |
| PAF15-06100000S | 66M-45300-02-4D | 277-291 |
| PAF15-07000000 | 66M-W009B-15-1S | 185 |
| PAF15-07000001 | 99510-10114 | 180-183-185 |
| PAF15-07000001 | 91810-03014 | 181 |
| PAF15-070000013 | 93604-12M07 | 183 |
| PAF15-070000016 | 661-41262-01 | 100 |
| PAF15-070000016 | 661-41262-02 | 100 |
| PAF15-070000024 | 66M-46297-00 | 185 |
| PAF15-070000028 | 90105-08M78 | 180-185 |
| PAF15-070000030 | 97013-06035 | 197 |
| PAF15-070000031 | 66M-12411-00 | 137 |
| PAF15-070000031 | 66M-12411-01 | 137-179-180-183 |
| PAF15-070000031 | 6G8-12411-02 | 191 |
| PAF15-070000031 | 6G8-12411-03 | 66-67-68-69-137-195-197-201-203-205-207 |
| PAF15-07000100 | 66M-11181-10 | 185-215-218 |
| PAF15-07000200 | 66M-85580-00 | 107 |
| PAF15-07000300 | 66M-85520-00 | 106 |
| PAF15-07000400 | 66M-85533-00 | 104 |
| PAF15-07000500 | 66M-85540-10 | 118 |
| PAF15-07000600 | 66M-85570-00 | 104 |
| PAF15-07010000 | 66M-15100-02-1S | 183 |
| PAF15-07010003 | 6C5-12858-00 | 187 |
| PAF15-07010003 | 90401-20M00 | 183-191-197 |
| PAF15-07010004 | 90344-51003 | 203-205 |
| PAF15-07010006 | 6E5-24377-00 | 181-183 |
| PAF15-07010007 | 90445-10M46 | 183 |
| PAF15-07010008 | 66M-11325-00 | 183 |
| PAF15-07010009 | 66M-11328-00 | 65-66-67-68-69-183-191-197-203-205-207 |
| PAF15-07010011 | 66M-11327-00-94 | 168-183-191-197-203-205-207 |
| PAF15-07010012 | 66M-12535-00 | 183-191-197-203-205-207 |
| PAF15-07010014 | 66M-11357-00 | 183 |
| PAF15-07010015 | 90465-08M83 | 195 |
| PAF15-07010018 | 66M-41114-01 | 65-140-183 |
| PAF15-07010019 | 66M-41113-20-1S | 183 |
| PAF15-07010021 | 6H3-12413-00-1S | 197-207-241 |
| PAF15-07010021 | 6H3-12413-00-9M | 191 |
| PAF15-07010021 | 6H3-12413-001S | 183 |
| PAF15-07010022 | 62Y-12414-00 | 66-67-68-69-138-183-191-195-197-201 |
| PAF15-07010023 | 5GH-13440-00 | 183 |
| PAF15-07010024 | 66M-11416-00 | 183 |
| PAF15-07010026 | 6E5-11325-00 | 183 |
| PAF15-07010027 | 90480-12072 | 185-209-211 |
| PAF15-07010103 | 62Y-82504-10 | 103 |
| PAF15-07010103 | 65W-82504-00 | 103 |
| PAF15-07010200 | 66M-11168-001S | 183 |
| PAF15-07020001 | 66M-11631-00-96 | 183-219 |
| PAF15-07020005 | 93450-15023 | 183-219 |
| PAF15-07020006 | 634-11633-00 | 183-219 |
| PAF15-07020100 | 66M-11650-00 | 183 |
| PAF15-07030000 | 66M-11411-00 | 183-219 |
| PAF15-07030003 | 66M-11536-10 | 185 |
| PAF15-07030004 | 66M-11557-00 | 185 |
| PAF15-07030005 | 90170-28M37 | 185 |
| PAF15-07030006 | 93102-25014 | 189 |
| PAF15-07030006 | 93102-35M51 | 183 |
| PAF15-07030007 | 93102-25M52 | 183 |
| PAF15-07040000 | 66M-11111-01-1S | 185 |
| PAF15-07040001 | 66M-12111-00 | 185 |
| PAF15-07040002 | 66M-12121-00 | 185 |
| PAF15-07040004 | 66M-12116-00 | 185 |
| PAF15-07040005 | 66M-12113-00 | 185 |
| PAF15-07040006 | 30X-12117-00 | 189-193-195-199-201-203-207 |
| PAF15-07040007 | 30X-12118-00 | 185-189-193-195-199-201-203-207 |
| PAF15-07040008 | 93102-18M21 | 180-185 |
| PAF15-07040009 | 90387-13001 | 185 |
| PAF15-07040011 | 90387-13002 | 185 |
| PAF15-07040012 | 90387-13M56 | 180-185 |
| PAF15-07040013 | 90501-12M41 | 185 |
| PAF15-07040014 | 90501-12M40 | 180-185 |
| PAF15-07040015 | 66M-12146-00 | 185-189 |
| PAF15-07040016 | 66M-13329-10 | 185 |
| PAF15-07040017 | 90201-13201 | 180-185 |
| PAF15-07040018 | 66M-11537-00-94 | 185 |
| PAF15-07040200 | 66M-12170-00 | 185 |
| PAF15-07040301 | 66M-12151-10 | 185 |
| PAF15-07040300S | 62Y-12159-00 | 185-193-199 |
| PAF15-07040303 | 64J-12159-00 | 189 |
| PAF15-07040304 | 62Y-12158-00 | 185-189-193-195-199-201-203-205-207 |

| REF | R.O. / OEM | |
|------------------|--------------------|---|
| PAF15-07040500 | 66M-13300-10 | 185 |
| PAF15-07050001 | 66M-11191-00-1S | 185 |
| PAF15-07050002 | 66M-11356-00 | 185 |
| PAF15-07050003 | 90480-10M16 | 185 |
| PAF15-07050004 | 69M-E5363-00 | 171-180 |
| PAF15-07050004 | 69M-E5363-00 | 181-185-187-191-195-197-201-203-205-207-209-211-213-214 |
| PAF15-07050004 | 6G8-15363-00 | 185 |
| PAF15-07050006 | 30X-12117-00 | 185 |
| PAF15-07060001 | 6J8-81960-00 | 117 |
| PAF15-07070000 | 66M-85550-00 | 109 |
| PAF15-07070100W | 66M-85550-10 | 109 |
| PAF15-07080000 | 61N-24560-00 | 80 |
| PAF15-07080002 | 61N-24521-00 | 80 |
| PAF15-07090000 | 66M-14301-00 | 91 |
| PAF15-07090000W | 66M-14301-00 | 91 |
| PAF15-07130001 | 63V-15716-00 | 113 |
| PAF15-07130107 | 63V-15713-00 | 112 |
| PAF15-07130201 | 63V-15714-00 | 113 |
| PAF15-07130202 | 63V-15741-00 | 112 |
| PAF15-07130203 | 63V-15767-00 | 112 |
| PAF15-07130204 | 63V-15784-00 | 112 |
| PAF15-07140000 | 66M-24410-11 | 85 |
| PAF15-09000000 | 6G1-24306-55 | 74 |
| PAF15-09000000 | 6Y1-24306-55-00 | 74 |
| PAF15-10000002 | 6YJ-24167-00 | 76 |
| PAF15-10000003 | 6Y1-24268-00 | 76 |
| PAF15-10010000 | 6YJ-24610-00 | 75 |
| PAF15-10010000 | 6YJ-24610-01 | 75 |
| PAF15-10020000 | 6YJ-24260-00 | 76 |
| PAF15-10020000 | 6YJ-24260-01 | 76 |
| PAF15-10030001 | 66M-12138-60 | 185 |
| PAF15-11000002W | 703-48293-10 | 129 |
| PAF15-11020000W | 63V-61350-00 | 131 |
| PAF15-13000000W | 703-48230-10 | 126 |
| PAF15-13000100W | 688-82586-21 | 129 |
| PAF15-13000200W | 703-82510-12 | 113 |
| PAF15-13000300W | 703-83383-00/01/02 | 128 |
| PAF15-13000300W | 703-83383-10/11 | 128 |
| PAF15-13000500W | 703-48261-01 | 127 |
| PAF15-13010010W | 703-48245-00 | 129 |
| PAF15-13020007W | 703-48152-00 | 129 |
| PAF166-010003 | 51Y-12119-00 | 179-193 |
| PAF2.6-00000003 | 69M-45113-A0 | 173-217-218 |
| PAF2.6-00000004 | 69M-24575-00 | 76 |
| PAF2.6-02000003L | 69M-44361-10 | 283 |
| PAF2.6-02000003S | 69M-44361-00 | 283 |
| PAF2.6-03000001 | 69M-G5311-00-4D | 283 |
| PAF2.6-03000002 | 6L5-45317-09 | 283 |
| PAF2.6-03000003 | 6L5-45316-09 | 283 |
| PAF2.6-03000004 | 93103-09M41 | 283 |
| PAF2.6-03000007 | 69M-G5315-A0 | 283 |
| PAF2.6-03000008 | 69M-G5321-00-94 | 283 |
| PAF2.6-03000009 | 93210-05001 | 283 |
| PAF2.6-03000010 | 69M-G4323-00 | 148-154-283 |
| PAF2.6-03000011L | 69M-G5511-00 | 283 |
| | | |

| REF | R.O. / OEM | |
|-----------------|-----------------|-------------------------|
| PAF2.6-04020006 | 93450-13130 | 173 |
| PAF2.6-04020100 | 69M-11650-00 | 173 |
| PAF2.6-04030000 | 69M-11400-00 | 173-219 |
| PAF2.6-04040001 | 69M-E2155-00 | 173 |
| PAF2.6-04040100 | 69M-E1111-00-1S | 173 |
| PAF2.6-04050001 | 69M-E5111-00-1S | 171 |
| PAF2.6-04050100 | 69M-E3102-00 | 171 |
| PAF2.6-04060000 | 69M-E5396-00-5B | 171 |
| PAF2.6-04060001 | 69M-E5396-00 | 171 |
| PAF2.6-04060002 | 93210-09004 | 171 |
| PAF20-02000005 | 6AH-44368-00 | 293 |
| PAF20-02000007 | 6AH-44365-00 | 293 |
| PAF20-02000101L | 6AH-44361-11 | 293 |
| PAF20-02000101S | 6AH-44361-01 | 293 |
| PAF20-04000000L | 6AH-45300-10-4D | 277 |
| PAF20-04000000L | 6AH-45300-10-8D | 277-292 |
| PAF20-04000000L | 6AH-45300-00-4D | 277 |
| PAF20-04000000S | 6AH-45300-00-8D | 277-292 |
| PAF20-040000001 | 69G-45315-A0 | 292 |
| PAF20-04010001 | 69G-45331-01-CA | 292 |
| PAF20-04020000L | 6AH-44150-10 | 292 |
| PAF20-04020000S | 6AH-44150-00 | 292 |
| PAF20-04030000L | 6AH-45510-10 | 293 |
| PAF20-04030000S | 6AH-45510-00 | 293 |
| PAF20-04040001 | 6AH-44311-00 | 147-293 |
| PAF20-05000000 | 6AH-W009B-02-1S | 189 |
| PAF20-05000002 | 90105-090006 | 187 |
| PAF20-05000003 | 6AH-46241-00 | 189-267 |
| PAF20-05000016 | 6AH-12481-00 | 187 |
| PAF20-05000027 | 6AH-11536-00 | 189 |
| PAF20-05000028 | 6AH-11557-00 | 189 |
| PAF20-05000029 | 90170-30003 | 189 |
| PAF20-05000034 | 90480-10627 | 189 |
| PAF20-05000036 | 90480-06M19 | 189 |
| PAF20-05000100 | 6AH-85580-00 | 107 |
| PAF20-05000200 | 6AH-85510-00 | 121 |
| PAF20-05000300 | 6AH-85540-00 | 118 |
| PAF20-05000500 | 6AH-85550-00 | 109 |
| PAF20-05000500W | 6AH-85550-10 | 109 |
| PAF20-05000600 | 6AH-41113-01-1S | 187 |
| PAF20-05000602 | 6AH-41114-00 | 187 |
| PAF20-05000700 | 6AH-12413-00-1S | 187 |
| PAF20-05000702 | 6AH-12414-00 | 65-187 |
| PAF20-05000900W | 6AH-81800-00 | 111 |
| PAF20-05000900W | 6AH-81800-01 | 111 |
| PAF20-05010000 | 6AH-15100-00 | 187 |
| PAF20-05010003 | 6AH-11416-00 | 189 |
| PAF20-05010007 | 97013-06040 | 187 |
| PAF20-05020001 | 6AH-11631-00 | 189-219 |
| PAF20-05020002 | 93450-17129 | 189-219 |
| PAF20-05020003 | 137-11633-10 | 189-219 |
| PAF20-05020004 | 6AH-11411-00 | 189-219 |
| PAF20-05020100 | 6AH-11603-00 | 189-219 |
| PAF20-05020200 | 6AH-11650-10 | 189 |
| PAF20-05030001 | 6AH-12111-00 | 189 |
| PAF20-05030002 | 6AH-12121-10 | 189 |
| PAF20-05030003 | 62Y-12116-00 | 189 |
| PAF20-05030004 | 3YF-12113-00 | 189 |
| PAF20-05030005 | 93102-22010 | 189 |
| PAF20-05030006 | 90387-13006 | 189 |
| PAF20-05030007 | 90501-120A5 | 189 |
| PAF20-05030008 | 6AH-12279-00 | 189 |
| PAF20-05030009 | 6G8-11197-01 | 203-205 |
| PAF20-05030009 | 6G8-11197-A0 | 187 |
| PAF20-05030010 | 6AH-13329-10 | 189 |
| PAF20-05030011 | 90201-15423 | 189 |
| PAF20-05030012 | 6AH-11537-00 | 189 |
| PAF20-05030013 | 90201-08784 | 189 |
| PAF20-05030100 | 6AH-11111-10-1S | 187 |
| PAF20-05030200 | 6AH-12170-00 | 189 |
| PAF20-05030301 | 6AH-12151-00 | 189 |
| PAF20-05030400 | 6AH-13300-00 | 189 |
| PAF20-05040000 | 6AH-11191-001S | 187 |
| PAF20-05040002 | 6AH-11356-00 | 187 |
| PAF20-05040003 | 6AH-11688-00 | 187 |
| PAF20-05040004 | 6AH-11669-00 | 187 |
| PAF20-05040005 | 62Y-14485-00 | 195 |
| PAF20-05040005 | 6AH-11372-00 | 187 |
| PAF20-05050000 | 6AH-24410-00 | 85 |
| PAF20-05000702 | 6AH-12414-00 | 138 |
| PAF20-07000100W | 63AH-61350-00 | 131 |
| PAF25-00000011 | 90105-10M12 | 295 |
| PAF25-00000013 | 65W-11351-00 | 191 |
| PAF25-00000013 | 65W-11351-10 | 218217- |
| PAF25-00000014 | 93608-12063 | 235-239-241-243 |
| PAF25-00000014 | 99530-08012 | 191-197-201-203-205-207 |
| PAF25-01000001 | 90386-52M02 | 133 |
| PAF25-01000004 | 90386-44M03 | 133 |
| PAF25-01010002 | 90386-22M15 | 133 |
| PAF25-02000004L | 65W-44361-10 | 297 |
| PAF25-02000004S | 65W-44361-00 | 297 |
| PAF25-02000005 | 90430-12072 | 297 |
| PAF25-02000019 | 90202-12060 | 297-301-305-309-367-371 |
| PAF25-02010005 | 62Y-11325-00 | 191 |
| PAF25-02010007 | 67C-15312-00 | 271 |
| PAF25-03000007 | 90387-06M69 | 133 |
| PAF25-03000008 | 90445-09068 | 191-197-207 |
| PAF25-03000009 | 90445-09095 | 191-197-207 |
| PAF25-03000009 | 90445-09104 | 195 |
| PAF25-03000011 | 90445-09105 | 191 |
| PAF25-03000011 | 90445-09251 | 195 |
| PAF25-04000001 | 61N-45311-02-4D | 295 |

| REF | R.O. / OEM | |
|------------------|-----------------|---|
| PAF25-04000002 | 61N-45536-00 | 297-355 |
| PAF25-04000003-2 | 61N-45587-00-10 | 297 |
| PAF25-04000003-3 | 61N-45587-00-11 | 297 |
| PAF25-04000003-4 | 61N-45587-00-12 | 297 |
| PAF25-04000003-5 | 61N-45587-00-13 | 297 |
| PAF25-04000003-6 | 61N-45587-00-14 | 297 |
| PAF25-04000003-7 | 61N-45587-00-15 | 297 |
| PAF25-04000004-3 | 61N-45567-12 | 295 |
| PAF25-04000004-4 | 61N-45567-14 | 295 |
| PAF25-04000005 | 61N-45551-00 | 295 |
| PAF25-04000007 | 93604-08062 | 214-223-239-301-305-309-313-349-357-363-367 |
| PAF25-04000007 | 93604-10M03 | 195-203-205-297-321-355-371 |
| PAF25-04000008 | 65W-45331-00-5B | 297 |
| PAF25-04000009 | 61N-45315-00 | 297-355 |
| PAF25-04000012 | 65W-44176-00 | 297 |
| PAF25-04000013 | 61N-45127-00 | 297-355 |
| PAF25-04000015 | 90280-03024 | 155-297 |
| PAF25-04000016 | 65W-44328-00 | 297 |
| PAF25-04000017S | 61N-44362-10 | 297-355 |
| PAF25-04000021 | 61N-45214-00 | 295 |
| PAF25-04000022 | 61N-45214-00 | 295 |
| PAF25-04000023 | 61N-45215-00 | 295 |
| PAF25-04010000L | 61N-45510-10 | 297 |
| PAF25-04010000S | 61N-45510-00 | 297 |
| PAF25-04030000L | 65W-44150-10 | 297 |
| PAF25-04030000S | 65W-44150-00 | 297 |
| PAF25-04050000 | 61N-44311-01 | 297 |
| PAF25-04050001 | 61N-44311-01 | 148-154-155-297-355 |
| PAF25-04050003 | 93210-45161 | 66-154-155-297-355 |
| PAF25-04050004 | 61N-44367-00 | 293-297-355 |
| PAF25-04060000 | 648-45633-11 | 295 |
| PAF25-04060002 | 90501-10065 | 295-355-357 |
| PAF25-04060003 | 664-45631-02 | 295 |
| PAF25-04060007 | 90201-20417 | 295 |
| PAF25-04070000 | 61N-45361-01-8D | 295-388-389 |
| PAF25-04070001 | 61N-45361-01-4D | 295-355 |
| PAF25-04070004 | 61N-45571-00 | 295 |
| PAF25-04070005-1 | 61N-45577-00-10 | 295-355 |
| PAF25-04070005-3 | 61N-45577-00-12 | 295 |
| PAF25-04080000 | 664-45947-01-EL | 295 |
| PAF25-04090000L | 65W-45300-01-4D | 278 |
| PAF25-04090000L | 65W-45300-10-4D | 295 |
| PAF25-04090000S | 65W-45300-00-4D | 295 |
| PAF25-04090000S | 65W-45300-01-4D | 278 |
| PAF25-05000002 | 90119-09M00 | 191-197-207 |
| PAF25-05000003 | 65W-11356-00 | 191 |
| PAF25-05000004 | 65W-11191-00-94 | 191 |
| PAF25-05000005 | 65W-15121-00 | 191 |
| PAF25-05000007 | 90464-07M05 | 241 |
| PAF25-05000016 | 65W-11536-10 | 193-199 |
| PAF25-05000021 | 65W-11476-00 | 193-199 |
| PAF25-05000022 | 90280-04M06 | 199 |
| PAF25-05000024 | 90170-20137 | 195 |
| PAF25-05000026 | 90170-35M47 | 193 |
| PAF25-05000100 | 5GH-13440-00 | 191 |
| PAF25-05010000 | 65W-15100-00-94 | 191 |
| PAF25-05010103 | 65W-11168-00 | 191 |
| PAF25-05010106 | 65W-11119-00 | 197 |
| PAF25-05010106 | 66W-11119-00 | 191 |
| PAF25-05010107 | 65W-13286-00 | 191 |
| PAF25-05010108 | 65W-11169-00 | 191 |
| PAF25-05010111 | 65W-41114-00 | 141-191 |
| PAF25-05010112 | 65W-41113-01-94 | 191 |
| PAF25-05010113 | 62Y-11372-01 | 191 |
| PAF25-05010113 | 62Y-12481-10 | 203-205 |
| PAF25-05010201 | 65W-85790-00 | 103 |
| PAF25-05010302-1 | 62Y-11416-00 | 193-199 |
| PAF25-05010302-2 | 62Y-11416-10 | 193-199 |
| PAF25-05020001 | 65W-11411-01 | 193-219 |
| PAF25-05020002 | 93102-35M47 | 193-199 |
| PAF25-05020003 | 93102-43M42 | 193-199-199 |
| PAF25-05020100 | 65W-11631-00-96 | 193-199-219 |
| PAF25-05020101 | 65W-11631-00-96 | 193-199 |
| PAF25-05020105 | 62Y-11633-00 | 193-199-199-201-203-205-207-219 |
| PAF25-05020106 | 93450-17129 | 193-199-199-201-203-205-207-219-231 |
| PAF25-05020200 | 62Y-11650-10 | 199 |
| PAF25-05020200 | 67C-11650-00 | 193 |
| PAF25-05020200 | 6C5-11650-00 | 195-203-207 |
| PAF25-05020200 | 6C5-11650-10 | 201-205 |
| PAF25-05020203-1 | 62Y-11656-00 | 193-199 |
| PAF25-05020203-2 | 62Y-11656-10 | 193 |
| PAF25-05020204 | 62Y-11654-00 | 193-199 |
| PAF25-05020204 | 6AH-11654-00 | 189 |
| PAF25-05020204 | 6C5-11654-00 | 195-201-203-205-207 |
| PAF25-05020301 | 65W-11642-11 | 193 |
| PAF25-05020310 | 65W-11665-00 | 193 |
| PAF25-05040000 | 65W-11181-30 | 191-215-218 |
| PAF25-05050001 | 67C-12111-00 | 193-199 |
| PAF25-05050002 | 62Y-12121-00 | 193-199-207 |

| REF | R.O. / OEM | |
|-----------------|-----------------|-----------------------------|
| PAF25-05050003 | 62Y-12116-00 | 193-195-199-201-203-207 |
| PAF25-05050005 | 51Y-12114-00 | 193-195-199-201-203-207 |
| PAF25-05050006 | 90109-06M65 | 191-195-197-201-203-205-207 |
| PAF25-05050007 | 90430-06014 | 191-195-197-201-203-205-207 |
| PAF25-05050008 | 65W-12146-00 | 193 |
| PAF25-05050009 | 62Y-12238-00 | 193-207 |
| PAF25-05050011 | 62Y-12216-00 | 193-199-207 |
| PAF25-05050012 | 62Y-12231-00 | 193-207 |
| PAF25-05050013 | 93210-12MG9 | 193-199-207 |
| PAF25-05050014 | 93210-14515 | 193-199-207 |
| PAF25-05050015 | 93210-33MH2 | 193-199-207 |
| PAF25-05050016 | 93605-14143 | 193-199-207 |
| PAF25-05050017 | 65W-11537-01 | 193 |
| PAF25-05050018 | 90201-10144 | 201 |
| PAF25-05050018 | 90201-10M06 | 193-199-207 |
| PAF25-05050019 | 90109-08M63 | 193-199-207 |
| PAF25-05050021 | 93102-37M04 | 189 |
| PAF25-05050021 | 93102-37M40 | 193-195-199-201-203-205-207 |
| PAF25-05050100 | 65W-11111-02-94 | 191 |
| PAF25-05050200 | 65W-12171-10 | 193 |
| PAF25-05050300 | 65W-12151-00 | 193 |
| PAF25-05050301 | 65W-12151-00 | 193-199 |
| PAF25-05050400 | 65W-13300-00 | 193 |
| PAF25-05070000 | 65W-14901-12 | 91 |
| PAF25-05070019 | 6H4-14548-00 | 99 |
| PAF25-05080004 | 65W-14457-10 | 268 |
| PAF25-05110000 | 65W-85580-00 | 107 |
| PAF25-05120000 | 65W-85570-01 | 104 |
| PAF25-05130000 | 62Y-24410-04 | 85 |
| PAF25-05130005 | 62Y-24411-00 | 87 |
| PAF25-05140000 | 65W-85510-10 | 121 |
| PAF25-05150000 | 65W-85550-01 | 109 |
| PAF25-07000007W | 703-48345-01 | 127 |
| PAF25-07000300W | 65W-61350-00 | 131 |
| PAF4-00000001 | 90387-06806 | 285-287 |
| PAF4-00000001 | 90387-06M14 | 345 |
| PAF4-00000006 | 67D-45113-A0 | 175-217-218 |
| PAF4-01090100 | 6EG-G4138-00 | 131 |
| PAF4-01090100 | 6G1-42138-00 | 131 |
| PAF4-01090100 | 6G1-42138-01 | 131 |
| PAF4-01090300 | 68D-G2177-10 | 134 |
| PAF4-01090300 | 6EE-G2177-00 | 134 |
| PAF4-01090401 | 682-82556-00 | 120 |
| PAF4-02040001 | 68D-G4360-10 | 285 |
| PAF4-02040001S | 68D-G4360-00 | 285 |
| PAF4-02040002 | 68D-G4365-00 | 283-285 |
| PAF4-03000001 | 68D-G5300-11-4D | 285</ |

| REF | R.O. / OEM | |
|------------------|-----------------|-------------------------------------|
| PAF4-03050001 | 6E0-45361-01-4D | 345-387 |
| PAF4-03050002 | 93101-13M12 | 283-285 |
| PAF4-03060000 | 6E0-44352-00 | 64-285 |
| PAF4-03070000 | 6E0-45943-01 | 287 |
| PAF4-03070000 | 6E0-45943-01-EL | 285-402 |
| PAF4-03080000 | 6L5-45616-00 | 283-285-287-405 |
| PAF4-0310000L | 68D-65300-11-4D | 277 |
| PAF4-0310000L | 68D-G5300-10-4D | 285 |
| PAF4-0310000S | 68D-65300-03-4D | 277 |
| PAF4-0310000S | 68D-G5300-00-4D | 285 |
| PAF4-04000000 | 680-WE090-11-15 | 175 |
| PAF4-04000001 | 90105-08M76 | 171 |
| PAF4-04000001 | 97095-08020 | 331-335-337-341 |
| PAF4-04000001 | 97095-08020-00 | 177 |
| PAF4-04000002 | 68D-11351-A0 | 177-270 |
| PAF4-04000003 | 99510-10114 | 175-177-179 |
| PAF4-04000004 | 90201-266P2 | 175 |
| PAF4-04000006 | 90201-08818 | 177 |
| PAF4-04000006 | 90201-08818-00 | 171 |
| PAF4-04000006 | 90430-08143 | 197-209-211 |
| PAF4-04000006 | 90430-08800 | 179 |
| PAF4-04000006 | 90430-08800-00 | 175 |
| PAF4-04000006 | 90201-08818 | 64-66 |
| PAF4-04000007 | 68D-E5362-00 | 177 |
| PAF4-04000008 | 93210-24M79 | 177-180-185-201-203-205 |
| PAF4-04000009 | 68D-E1169-A0 | 177 |
| PAF4-04000010 | 68D-E1168-00 | 177 |
| PAF4-04000010 | 68D-E5362-00 | 179 |
| PAF4-04000011 | 68D-E2414-A0 | 64-138-173-175-179 |
| PAF4-04000012 | 90445-09807 | 175 |
| PAF4-04000014 | 67D-11181-A0 | 175-215-218 |
| PAF4-04000015 | 67D-12154-00 | 175 |
| PAF4-04000017 | 68D-E1193-A0 | 175 |
| PAF4-04000018 | 67D-11191-00 | 175 |
| PAF4-04000019 | 90280-04M06 | 193-207 |
| PAF4-04000030 | 90467-08004 | 75-243 |
| PAF4-04000030 | 90467-09M09 | 191-225 |
| PAF4-04000030 | 90467-09M09 | 64-65-67 |
| PAF4-04000033 | 90105-08046-00 | 175 |
| PAF4-04000034 | 90105-08M36 | 173-179-180 |
| PAF4-04000034 | 90105-08M36-00 | 175 |
| PAF4-04000036 | 6EE-E5362-00 | 177 |
| PAF4-04000038 | 67D-85640-00 | 106 |
| PAF4-04010003 | 68D-E5364-00 | 177 |
| PAF4-04010004 | 93102-25090 | 177 |
| PAF4-04010100 | 68D-E1311-02-15 | 177 |
| PAF4-04010102 | 650-24378-00 | 173-175-177-179-180-235-237-241 |
| PAF4-04010102 | 6E9-24378-00 | 187 |
| PAF4-04020001 | 68D-E1631-00-96 | 175 |
| PAF4-04020005 | 68D-E1633-00 | 175-219 |
| PAF4-04020006 | 93450-14088 | 175-219 |
| PAF4-04020100 | 67D-11650-00 | 175 |
| PAF4-04020103 | 67D-11654-00 | 175 |
| PAF4-04020200 | 68D-E1631-00-96 | 175-219 |
| PAF4-04030000 | 67D-11400-00 | 175-219 |
| PAF4-04040000 | 68D-E2170-00 | 175 |
| PAF4-04050100 | 68D-E3102-00 | 177 |
| PAF4-04050200 | 68D-E5111-00-1S | 177 |
| PAF4-04060000 | 6EE-E5396-00-CA | 177 |
| PAF4-04060001 | 68D-E5396-00-5B | 177-179 |
| PAF4-04060002 | 93210-35537 | 171-177 |
| PAF4-04060004 | 93102-10004 | 177-179 |
| PAF4-04070000 | 68D-E2413-00-1S | 179 |
| PAF4-04070001 | 67D-12413-00-1S | 175 |
| PAF4-04070003 | 68D-E1325-00 | 64-65-66-67-68-69-70-71-173-175-179 |
| PAF4-04070100 | 68D-E2413-001S | 175 |
| PAF4-04080005 | 67D-12111-00 | 175 |
| PAF4-04080006 | 67D-12121-00 | 175-180 |
| PAF4-04080007 | 68T-12116-00 | 175-179-180 |
| PAF4-04080008 | 68D-E2113-00 | 173-175 |
| PAF4-04080009 | 68D-E2155-00 | 175 |
| PAF4-04080101 | 68D-E1111-10-1S | 175 |
| PAF4-04090000 | 67D-24410-03 | 85 |
| PAF4-04120005 | 6L5-24251-00 | 64-80-81-82 |
| PAF4-04120100 | 67D-24610-00 | 75 |
| PAF4-04120100 | 67D-24610-02 | 75 |
| PAF4-04120100 | 67D-24610-03 | 75 |
| PAF4-04120100 | 67D-24610-04 | 75 |
| PAF4-04120100 | 68D-24610-10 | 75 |
| PAF4-04120103 | 62A-24634-00 | 75 |
| PAF4-04130100 | 6G1-15755-00 | 113 |
| PAF4-04130100 | 6G1-15779-00 | 113 |
| PAF4-04140000 | 67D-14301-03 | 91 |
| PAF4-05000010 | 90467-13M13 | 75 |
| PAF4-05000300 | 646-24251-01 | 80 |
| PAF4-05000300 | 646-24251-02 | 80 |
| PAF4-05000000L | 66T-45300-10-4D | 279 |
| PAF4-05000000L | 66T-45311-13-8D | 279 |
| PAF4-050000053 | 90445-10M40 | 209 |
| PAF4-05040003 | 62Y-12279-00 | 207 |
| PAF4-05040006 | 67C-11537-01 | 199 |
| PAF4-05070002 | 62Y-14485-00 | 197-201-203-207 |
| PAF4-0701000EI | 907-94469-05 | 79 |
| PAF4-013000000EI | 703-48272-12 | 126 |
| PAF6-00000001 | 6BX-45113-00 | 151-179-217 |
| PAF6-03000002 | 6BX-44322-00 | 154-287 |
| PAF6-04000001 | 6BX-11351-00 | 179 |

| REF | R.O. / OEM | |
|-----------------------|-----------------|---|
| PAF6-04000002 | 6BX-11181-00 | 179-215 |
| PAF6-04000003 | 6BX-12154-00 | 179 |
| PAF6-04000004 | 6BX-E1191-00-5B | 179 |
| PAF6-04000005 | 6BX-11356-00 | 179 |
| PAF6-04000009 | 6G0-82519-00 | 179 |
| PAF6-04000020 | 6BX-F4323-00 | 179 |
| PAF6-04010004 | 6BX-E1168-00 | 179 |
| PAF6-04030000 | 6BX-E2170-00 | 179 |
| PAF6-04050001 | 6BX-12111-00 | 179 |
| PAF6-04050002 | 6AU-12121-00 | 179 |
| PAF6-04050003 | 60R-12113-00 | 179 |
| PAF6-04050004 | 6BX-E2155-00 | 179 |
| PAF6-04050100 | 6BX-E1111-00-1S | 179 |
| PAF60-02000007 | 6C5-44361-00 | 313 |
| PAF60-04000000 | 69W-45300-00-4D | 278 |
| PAF60-04000000 | 69W-45300-00-8D | 278 |
| PAF60-04000000 | 69W-45300-01-8D | 278 |
| PAF60-04000000 | 69W-45300-04-8D | 311 |
| PAF60-04000001 | 69W-45301-00-8D | 311 |
| PAF60-04000002 | 69W-45551-00 | 311 |
| PAF60-04000003 | 62Y-44151-00 | 303-307-311 |
| PAF60-04000008 | 63D-45344-00 | 313 |
| PAF60-04000101 | 63D-45321-00 | 305-309-313 |
| PAF60-04000500 | 62Y-45571-00 | 311 |
| PAF60-04000600 | 69W-45560-00 | 311 |
| PAF60-04010000 | 69W-45501-00 | 313 |
| PAF60-04020001 | 63D-45611-00 | 303-307-311 |
| PAF60-04020002 | 90501-18001 | 303-307-311 |
| PAF60-04020003 | 62Y-45631-00 | 307-311 |
| PAF60-04020005 | 63D-45635-00 | 303-307-311 |
| PAF60-04030000 | 63D-45361-02-8D | 307-311 |
| PAF60-06000000 | 6C5-43800-11 | 124 |
| PAF60-06000000 | 6C5-43800-12 | 124 |
| PAF8-05000022 | 90119-06MA3 | 187 |
| PAF8-05030006 | 7NJ-12117-00 | 173-175 |
| PAF8-05030007 | 7NJ-12118-00 | 173-175-179 |
| PAGB/T1099-3X5X13 | 90280-03017 | 201 |
| PAGB/T1099-3X5X13 | 90280-03M01 | 180-185-189-195-203-205 |
| PAGB/T276-6004C2 | 93306-004UO | 345 |
| PAGB/T276-6004C2 | 93306-004YH | 289 |
| PAGB/T276-6004C2 | 93306-205YD | 177 |
| PAGB/T276-6006/P6 | 93306-00612 | 295 |
| PAGB/T276-62/22/P6 | 93306-272Y2 | 171 |
| PAGB/T290F-2020 | 93315-220V7 | 297 |
| PAGB/T345.2-D32.5XD1 | 93210-35537 | 179 |
| PAGB/T345.2-D32.5XD1 | 93210-35537 | 64-65-68-69-70-71-180-187-195-201-203-205 |
| PAGB/T3452.1-13X2 | 93210-13M63 | 355 |
| PAGB/T3452.1-25.8X2 | 93210-22164 | 297-355 |
| PAGB/T3452.1-25.8X2 | 93210-26130 | 297-355 |
| PAGB/T3452.1-32.5X1.8 | 93210-32738 | 65-66-67-68-69-70-71 |
| PAGB/T5287-6 | 90201-06M94 | 180-185 |
| PAGB/T5782-2000S | 90119-06M40 | 285 |
| PAGB/T5782-M6X125 | 95895-06035 | 295 |
| PAGB/T5782-M6X125 | 97013-06035 | 193-285 |
| PAGB/T5782-M6X25 | 97095-06025 | 209-213-231 |
| PAGB/T5782-M6X35 | 90119-06MA5 | 191-203-205-233-241 |
| PAGB/T5782-M6X45 | 90105-06M25 | 175 |
| PAGB/T5782-M6X45 | 947395-06040 | 349 |
| PAGB/T5782-M8X35 | 65W-08M87 | 191 |
| PAGB/T5782-M8X80 | 90119-08M01 | 191 |
| PAGB/T5783-M5X10 | 97013-05010 | 179 |
| PAGB/T5783-M5X12 | 68D-E5362-00 | 183 |
| PAGB/T5783-M5X12 | 90119-06M48 | 295 |
| PAGB/T5783-M5X12 | 90201-08818 | 183 |
| PAGB/T5783-M5X12 | 90465-08M99 | 171 |
| PAGB/T5783-M5X12 | 92995-06600 | 185-237 |
| PAGB/T5783-M5X12 | 93102-25090 | 183 |
| PAGB/T5783-M5X12 | 93306-205YD | 183 |
| PAGB/T5783-M5X12 | 95895-06016 | 287-289 |
| PAGB/T5783-M5X12 | 95895-06016-00 | 285 |
| PAGB/T5783-M5X12 | 95895-06020 | 283 |
| PAGB/T5783-M5X12 | 97013-06016 | 185-223-229 |
| PAGB/T5783-M5X12 | 97013-06045 | 171 |
| PAGB/T5783-M5X12 | 97095-05012 | 191 |
| PAGB/T5783-M5X12 | 97095-0512 | 183 |
| PAGB/T5783-M5X12 | 97095-06035 | 185 |
| PAGB/T5783-M5X12 | 97575-08550-00 | 183 |
| PAGB/T5783-M5X16 | 97095-05016 | 343 |
| PAGB/T5783-M6X10 | 97095-06010 | 197-349-363 |
| PAGB/T5783-M6X12 | 95817-06012 | 171 |
| PAGB/T5783-M6X12 | 95817-06012-00 | 177 |
| PAGB/T5783-M6X12 | 97013-06012 | 189 |
| PAGB/T5783-M6X14 | 90119-06M80-00 | 177 |
| PAGB/T5783-M6X14 | 95895-06012 | 287 |
| PAGB/T5783-M6X16 | 90105-06039 | 173 |
| PAGB/T5783-M6X16 | 90105-06M14 | 175 |
| PAGB/T5783-M6X16 | 92995-06600 | 371 |
| PAGB/T5783-M6X16 | 97090-06014 | 343 |
| PAGB/T5783-M6X16 | 97095-06016 | 221-223-225-227-231-235-239-321-339 |
| PAGB/T5783-M6X20 | 65W-12228-00 | 191 |
| PAGB/T5783-M6X20 | 90119-06MA2 | 179-227 |
| PAGB/T5783-M6X20 | 90119-06MA3 | 191 |
| PAGB/T5783-M6X20 | 90119-06MA3 | 171-173-179-180-191-195-197-201-203-205-207-209-213-233-237-241-291-347-351 |
| PAGB/T5783-M6X20 | 97095-06020 | 351 |

| REF | R.O. / OEM | |
|------------------|----------------|---|
| PAGB/T5783-M6X20 | 97095-06020-00 | 175 |
| PAGB/T5783-M6X20 | 97395-06020 | 349 |
| PAGB/T5783-M6X20 | 97575-06520 | 293 |
| PAGB/T5783-M6X20 | 97595-06520 | 185-187 |
| PAGB/T5783-M6X20 | 65W-12228-00 | 191 |
| PAGB/T5783-M6X25 | 90119-06MA3 | 187-191-235 |
| PAGB/T5783-M6X25 | 90119-06MA5 | 191 |
| PAGB/T5783-M6X25 | 90119-08MA5 | 235 |
| PAGB/T5783-M6X25 | 97513-06525 | 185 |
| PAGB/T5783-M6X30 | 90119-06M04 | 227 |
| PAGB/T5783-M6X30 | 90119-06MA4 | 235 |
| PAGB/T5783-M6X30 | 90119-06MA5 | 195 |
| PAGB/T5783-M6X30 | 95895-06035 | 293 |
| PAGB/T5783-M6X30 | 970-95-06030 | 231 |
| PAGB/T5783-M6X30 | 97095-06030 | 180-211-213-343-346 |
| PAGB/T5783-M6X35 | 90105-06035 | 189 |
| PAGB/T5783-M6X35 | 90119-06MA5 | 243 |
| PAGB/T5783-M6X35 | 90119-06MA5 | 191 |
| PAGB/T5783-M6X35 | 95895-06012 | 343-347 |
| PAGB/T5783-M8X14 | 97095-08014 | 171-179 |
| PAGB/T5783-M8X14 | 97095-08014-00 | 175 |
| PAGB/T5783-M8X20 | 97095-08020 | 179 |
| PAGB/T5783-M8X20 | 97095-08020-00 | 177 |
| PAGB/T5783-M8X25 | 90105-081A7 | 189 |
| PAGB/T5783-M8X25 | 97075-08025 | 209 |
| PAGB/T5783-M8X25 | 97080-08025 | 289-291-292-351 |
| PAGB/T5783-M8X25 | 97095-08025 | 299-303-307-311-325-329-333-339 |
| PAGB/T5783-M8X30 | 97575-08530 | 293 |
| PAGB/T5783-M8X35 | 90101-08001 | 235 |
| PAGB/T5783-M8X35 | 97075-08035 | 289 |
| PAGB/T5783-M8X35 | 97095-08035 | 303-307-311 |
| PAGB/T5787-1986 | 97575-08550-00 | 177 |
| PAGB/T6182-M5 | 90185-05002 | 289-293-315-319-323-327-331-335-337-341-350 |
| PAGB/T818-M4X10 | 97607-04210 | 187 |
| PAGB/T818-M4X10 | 98507-04010 | 195-197-201-203-205-207 |
| PAGB/T818-M4X6 | 98503-04066-00 | 177 |
| PAGB/T818-M5X12 | 97095-05012 | 197-203-205-207 |
| PAGB/T818-M5X16 | 98780-05016 | 211 |
| PAGB/T818-M5X25 | 97880-05025 | 173-179-203-205 |
| PAGB/T818-M5X25 | 97880-05025-00 | 175 |
| PAGB/T818-M5X25 | 98980-05025 | 187 |
| PAGB/T818-M6X16 | 98580-06016 | 365 |
| PAGB/T820-M4X12 | 98780-04015 | 213-239 |
| PAGB/T820-M4X12 | 98780-04016 | 187-209-237 |
| PAGB/T820-M5X20 | 90152-05011 | 293 |
| PAGB/T820-M5X25 | 90152-05M03 | 289 |
| PAGB/T820-M5X25 | 90152-05M04 | 350 |
| PAGB/T820-M5X30 | 6E0-W0078-00 | 345 |
| PAGB/T820-M5X30 | 6E0-W0078-01 | 345 |
| PAGB/T820-M5X30 | 6E0-W0078-02 | 345 |
| PAGB/T820-M5X30 | 90142-05M06 | 299 |
| PAGB/T820-M5X30 | 90151-05M05 | 295 |
| PAGB/T820-M5X30 | 90152-05 | |

| REF | R.O. / OEM | | REF | R.O. / OEM | | REF | R.O. / OEM | |
|----------------------|-----------------|---|-------------------|-----------------|-------------------------------------|----------------|------------------|---------|
| PAGB/T97.1-8 | 66M-11356-00 | 191 | PAT40-04060005-4 | 63D-45577-30 | 299-303-307-311 | PH130-0076 | 60X-81800-00 | 112 |
| PAGB/T97.1-8 | 92955-08600-00 | 177 | PAT40-04060005-5 | 63D-45577-40 | 299-303-307-311 | PH130-0076 | 60X-81800-00 | 112 |
| PAGB/T97.1-8 | 92990-08600 | 367 | PAT40-04060005-6 | 63D-45577-50 | 299-303-307-311 | PH130-0076 | 600-81800-00 | 112 |
| PAGB/T97.1-8 | 92990-14200 | 295 | PAT40-04060005-7 | 63D-45577-60 | 299-303-307-311 | PH130-0084 | 66M-81800-00 | 110 |
| PAGB/T97.1-8 | 92995-05600 | 183-203-205 185-227-229- 233-241 | PAT40-04070000 | 69W-45941-00-EL | 402 | PH130-0084 | 66M-81800-01 | 110 |
| PAGB/T97.1-8 | 92995-08600 | 179-209-214- 325-329-333- 335-337-341- 343-363-369- 377 | PAT40-05000100 | 6AH-82560-00 | 103 | PH130-0084 | 66M-81800-02 | 110 |
| PAGB/T97.1-8 | 92995-10600 | 295-299-303- 307-311-315- 319-331 | PAT40-10000000 | 65W-43800-00-4D | 124 | PH200-T029 | 6H1-43880-02 | 122 |
| PAGB/T97.1-8 | 93102-20108 | 183 | PAT40-10000000 | 65W-43800-01-4D | 124 | PH200-T030 | 6G5-43880-00 | 123 |
| PAGB/T97.1-8 | 97595-06520 | 183-191-193- 283 | PAT40-10000000 | 65W-43800-02-4D | 124 | PH200-T030 | 6G5-43880-01 | 123 |
| PAGBT3452.1-97.5X1.8 | 65W-15663-00 | 191 | PAT40-10000000 | 65W-43800-03-4D | 124 | PH200-T035 | 62X-43880-00 | 122 |
| PAHI-CAP32004JRKOYO | 93332-000W5 | 297 | PAT40-10000000 | 65W-43800-20-4D | 124 | PH200-T035 | 62X-43880-01 | 122 |
| PAHT-2.5X50 | 90465-11M10 | 293 | PAT40-10000000 | 65W-43800-21-4D | 124 | PH200-T035 | 62X-43880-09 | 122 |
| | | | PAT40-10000000 | 65W-43800-22-8D | 124 | PH200-T036 | 62Y-43880-01 | 122 |
| | | | PAT40-10000000 | 65W-43800-23-8D | 124 | PH200-T036 | 62Y-43880-02 | 122 |
| | | | PAT40-10020500 | 65W-43880-00 | 123 | PH200-T036 | 69W-43880-00 | 122 |
| | | | PAT40-10020500 | 65W-43880-01 | 123 | PH200-T036 | 69W-43880-01 | 122 |
| | | | PAT85-00000012 | 90105-10M00 | 323-327-331- 335-337-375- 379 | PH200-T036 | CS3-43880-00 | 122 |
| PAHT-2.5X60 | 90465-11M10 | 180-191-197- 207-209-213- 301-305-309- 313-317-321- 325 | PAT85-00000012 | 90105-16M67 | 315-319 | PH200-T037 | 688-43880-11 | 123 |
| PAHT-2.5X60 | 90467-06016 | 221-225-231- 237-239-241 | PAT85-00000017 | 90386-18M35 | 133 | PH200-T037 | 6E5-43880-01 | 123 |
| PAHT2.5X50 | 90465-11M10 | 187 | PAT85-01010203 | 90386-10M16 | 133 | PH200-T041 | 6E5-43880-02 | 123 |
| PAJASOF404-19-033 | 93210-33M49 | 335-339 | PAT85-01020003 | 90386-30M78 | 134 | PH200-T041 | 6H1-43880-00 | 122 |
| PAJASOF404-19-033 | 93210-33M85 | 64-154-283 | PAT85-01020005 | 90386-30M77 | 133 | PH200-T044 | 67F-43880-00 | 123 |
| PAJASOF404-31-045 | 93210-44398 | 351 | PAT85-01200005-B | 688-45587-01 | 317-321 | PH200-T045 | 6C5-43880-00 | 123 |
| PAJASOF40424-050 | 93210-48001 | 313 | PAT85-040000003-B | 688-45567-01 | 315-319 | PH200-T045 | 6C5-43880-01 | 123 |
| | | | PAT85-040000004-B | 688-45567-01 | 315-319 | PH200-T048 | 6H5-43880-00 | 122 |
| | | | PAT85-05000023 | 6C5-82105-01 | 113 | PH200-T048 | 6H5-43880-01 | 122 |
| | | | PAT85-05000023 | 6H0-82105-02 | 113 | PH200-T048 | 6H5-43880-02 | 122 |
| | | | PAT85-05000023 | 6H0-82105-J2 | 113 | PH200-T050 | 61A-43880-00 | 124 |
| | | | PAT85-05030300 | 6AH-81960-00 | 119 | PH200-T050 | 61A-43880-01 | 124 |
| PAJASOF40431-025 | 93210-24M79 | 64-65-69-70- 171-181-187- 191-195-197- 207-209-211- 213-214 | PAT85-08010000W | 703-48205-10 | 126 | PH200-T057 | 67H-43880-00 | 123 |
| | | | PAT85-08010100 | 688-8258A-20 | 128 | PH200-T057 | 68W-43880-03 | 123 |
| PAJB/T9740.1-M6 | 93700-06M03 | 133 | PH130-0005 | 6E5-81800-10 | 110 | PH200-T057 | 6AE-43880-01 | 123 |
| PAJSB2401P48 | 93210-48214 | 283-285 | PH130-0005 | 6E5-81800-11 | 110 | PH200-T057 | 6AE-43880-03 | 123 |
| PAKOYOHI-CAP32232 | 93332-00092 | 311 | PH130-0005 | 6E5-81800-12 | 110 | PH200-T057 | 6AE-43880-04 | 123 |
| PANTN16003EY | 93316-003Y0 | 283 | PH130-0007 | 676-81800-10 | 111 | PH200-T068 | 6D8-43880-00 | 123 |
| PANTN6205C3 | 93306-205B2 | 179 | PH130-0007 | 697-81800-10 | 111 | PH200-T068 | 6D8-43880-01 | 123 |
| | | | PH130-0007 | 697-81800-11 | 111 | PH200-T068 | 6D8-43880-09 | 123 |
| PAPS2700.04.03 | 51Y-12119-00 | 175-185-199- 203-205-207- 213 | PH130-0007 | 697-81800-12 | 111 | PH200-T069 | 60V-43880-00 | 123 |
| PAT15-04010202 | 624-14485-00 | 235 | PH130-0007 | 99999-03249 | 111 | PH200-T069 | 69J-43880-00 | 123 |
| PAT15-04010202 | 6H1-14485-00 | 171 | PH130-0028 | 67C-81800-00 | 110 | PH200-T069 | 69J-43880-01 | 123 |
| PAT20-13000500W | 703-48861-11 | 1276 | PH130-0028 | 67C-81800-01 | 110 | PH200-WH01 | 65W-81941-00 | 111-114 |
| PAT36-04000023 | 90465-06M86 | 179 | PH130-0028 | 67C-81800-02 | 110 | PH375-0034 | 65W-81941-00 | 111 |
| | | | PH130-0029 | 65W-81800-00 | 111 | PH375-0036 | 68N-81940-00 | 114 |
| PAT40-02000002 | 663-44367-00 | 301-305-309- 313-317-321- 367-371 | PH130-0029 | 65W-81800-01 | 111 | PH375-0042 | 68V-8194A-00 | 114 |
| | | | PH130-0029 | 65W-81800-02 | 111 | PH375-0042 | 6E5-81950-01 | 110-115 |
| | | | PH130-0029 | 65W-81800-03 | 111 | PH375-0047 | 6E5-8195A-01 | 115 |
| | | | PH130-0034 | 66M-81800-01 | 111 | PH375-0048 | 6E5-8195C-01 | 115 |
| | | | PH130-0034 | 66M-81800-02 | 111 | POWERHEAD2.6 | 69M-WE0090-01-1S | 173 |
| | | | PH130-0049 | 689-81800-10 | 110 | POWERHEAD20-25 | | 193 |
| PAT40-04000003-1 | 663-45587-01 | 309 | PH130-0049 | 689-81800-11 | 110 | PRE3300C05 | YMM-21005-00-00 | 130 |
| PAT40-04000003-1 | 663-45587-01-10 | 367 | PH130-0049 | 689-81800-12 | 110 | PRE3300C06 | YMM-21006-C8-00 | 130 |
| PAT40-04000003-2 | 663-45587-01-12 | 367 | PH130-0049 | 689-81800-13 | 110 | PRE3300C07 | YMM-21007-C8-00 | 130 |
| PAT40-04000003-2 | 663-45587-10 | 309 | PH130-0050 | 6H3-81800-10 | 111 | PRE3300C08 | YMM-21008-C8-00 | 130 |
| PAT40-04000003-3 | 663-45587-01-15 | 367 | PH130-0050 | 6H3-81800-11 | 111 | PRE3300C09 | YMM-21009-C8-00 | 130 |
| PAT40-04000003-3 | 663-45587-20 | 309 | PH130-0050 | 6H3-81800-12 | 111 | PRE3300C10 | YMM-21010-C8-00 | 130 |
| PAT40-04000003-3 | 663-45587-01-18 | 367 | PH130-0051 | 61H-81800-00 | 110 | PRE3300C11 | YMM-21011-C8-00 | 130 |
| PAT40-04000003-4 | 663-45587-30 | 309 | PH130-0051 | 61H-81800-01 | 110 | PRE3300C12 | YMM-21012-C8-00 | 130 |
| PAT40-04000003-5 | 663-45587-01-30 | 367 | PH130-0051 | 6K7-81800-10 | 110 | PRE3300C13 | YMM-21013-C8-00 | 130 |
| PAT40-04000003-5 | 663-45587-40 | 309 | PH130-0051 | 6N7-81800-00 | 110 | PRE3300C14 | YMM-21014-C8-00 | 130 |
| PAT40-04000003-6 | 663-45587-01-40 | 367 | PH130-0051 | 6N7-81800-01 | 110 | PRE3300C15 | YMM-21015-C8-00 | 130 |
| PAT40-04000003-6 | 663-45587-50 | 309 | PH130-0051 | 6N7-81800-02 | 110 | PRE3300C16 | YMM-21016-C8-00 | 130 |
| PAT40-04000003-7 | 663-45587-01-50 | 367 | PH130-0051 | 99999-03938 | 110 | PRE3300C17 | YMM-21017-C8-00 | 130 |
| PAT40-04000003-7 | 663-45587-60 | 309 | PH130-0055 | 67F-81800-01 | 112 | PRE3300C18 | YMM-21018-C8-00 | 130 |
| | | | PH130-0055 | 67F-81800-02 | 112 | PRE3300C19 | YMM-21019-C8-00 | 130 |
| PAT40-04000004-1 | 663-45567-01 | 299-303-307- 311 | PH130-0055 | 67F-81800-03 | 112 | PRE3300C20 | YMM-21020-C8-00 | 130 |
| PAT40-04000004-1 | 663-45567-01-10 | 365 | PH130-0055 | 67F-81800-04 | 112 | PRE3300C21 | YMM-21021-C8-00 | 130 |
| PAT40-04000004-2 | 663-45567-01-12 | 365 | PH130-0056 | 68F-81800-00 | 111 | PRE3300C22 | YMM-21022-C8-00 | 130 |
| | | | PH130-0056 | 68F-81800-01 | 111 | PRE3300C23 | YMM-21023-C8-00 | 130 |
| | | | PH130-0056 | 68F-81800-02 | 111 | PRE3300C24 | YMM-21024-C8-00 | 130 |
| PAT40-04000004-2 | 663-45567-10 | 299-303-307- 311 | PH130-0056 | 68F-81800-03 | 111 | PRE3300C25 | YMM-21025-C8-00 | 130 |
| PAT40-04000004-3 | 663-45567-01-15 | 365 | PH130-0056 | 6C5-81800-00 | 111 | PRE3300C26 | YMM-21026-C8-00 | 130 |
| PAT40-04000004-3 | 663-45567-20 | 299-303-307- 311 | PH130-0056 | 6CJ-81800-00 | 111 | PRE3300C27 | YMM-21027-C8-00 | 130 |
| PAT40-04000004-5 | 663-45567-01-30 | 365 | PH130-0057 | 68V-81800-00 | 111 | PRE3300C28 | YMM-21028-C8-00 | 130 |
| PAT40-04000004-5 | 663-45567-01-30 | 365 | PH130-0057 | 68V-81800-01 | 111 | PRE3300C29 | YMM-21029-C8-00 | 130 |
| PAT40-04000007 | 66T-45321-00 | 301 | PH130-0057 | 68V-81800-02 | 111 | PRE3300C30 | YMM-21030-C8-00 | 130 |
| | | | PH130-0058 | 688-81800-10 | 111 | | | |
| PAT40-04000008 | 90201-27M00 | 301-305-309- 313 | PH130-0058 | 688-81800-11 | 111 | | | |
| | | | PH130-0058 | 688-81800-12 | 111 | | | |
| PAT40-04000009 | 66T-45344-01 | 301-305-309 | PH130-0059 | 61A-81800-00 | 110 | | | |
| | | | PH130-0059 | 61A-81800-01 | 110 | | | |
| PAT40-04000014 | 63D-45375-00 | 301-305-309- 313 | PH130-0059 | 69L-81800-00 | 110 | RAC120R-RAC-01 | YMM-2W114-00 | 79 |
| | | | PH130-0059 | 69W-81800-00 | 110 | RAC320R-RAC-01 | YMM-2W227-01 | 78 |
| | | | PH130-0061 | 682-81800-10 | 110 | RAC320R-RAC-03 | | 78 |
| PAT40-04000022 | 63D-45214-00 | 299-303-307- 311 | PH130-0061 | 682-81800-11 | 110 | RAC490R-RAC-01 | YMM-2W227-01 | 79 |
| | | | PH130-0061 | 682-81800-12 | 110 | RACPF5510 | | 77 |
| PAT40-04000023 | 63D-45215-00 | 299-303-307- 311 | PH130-0061 | 682-81800-13 | 110 | RACRK22628 | | 79 |
| | | | PH130-0061 | 6L2-81800-10 | 110 | RACS3213 | MAR-24563-00 | 78 |
| PAT40-04000027 | 93332-00079 | 367 | PH130-0061 | 6L2-81800-11 | 110 | RACS3227 | YMM-2E227-00 | 79 |
| PAT40-04000003-1 | 663-45587-01 | 301-305-313 | PH130-0061 | 6L2-81800-12 | 110 | RACS3227 | YMM-2E227-01 | 79 |
| PAT40-04000003-2 | 663-45587-10 | 301-305-313 | PH130-0062 | 6F5-81800-10 | 110 | RACS3240 | YMM-2E114-00 | 79 |
| PAT40-04000003-3 | 663-45587-20 | 301-305-313 | PH130-0062 | 6F5-81800-11 | 110 | REC09168-12017 | 90430-10M11 | 64-65 |
| PAT40-04000003-4 | 663-45587-30 | 301-305-313 | PH130-0062 | 6F5-81800-12 | 110 | REC09401-11425 | 90465-11M59 | 75-213 |
| PAT40-04000003-5 | 6 | | | | | | | |

| REF | R.O. / OEM | |
|-----------------|-----------------|-------------------------|
| REC24942 | | 77 |
| REC24950 | | 78 |
| REC24952 | | 78 |
| REC25000 | | 77 |
| REC25010 | | 77 |
| REC25020 | | 77 |
| REC25030 | | 77 |
| REC25W40U3 | | 84 |
| REC2TU3 | YMD-63021-04 | 84 |
| REC2TU6 | YMD-63021-01 | 84 |
| REC35-802893Q | | 77 |
| REC35-802893Q01 | | 77 |
| REC35-80365M | 646-24251-01 | 80 |
| REC35-80365M | 646-24251-02 | 80-82-83 |
| REC35-822626Q15 | 69J-13440-00 | 83 |
| REC35-822626Q15 | 69J-13440-01 | 83-211-213 |
| REC35-822626Q15 | 69J-13440-03 | 71-72-73-83 |
| REC3FV-13440-00 | 3FV-13440-00 | 83 |
| REC3FV-13440-00 | 3FV-13440-10 | 83 |
| REC3FV-13440-00 | 3FV-13440-20 | 83 |
| REC3FV-13440-00 | 3FV-13440-30 | 67-83 |
| REC40135 | | 80 |
| REC40145 | 65W-24251-00 | 82 |
| REC40145 | 65W-24251-10 | 80 |
| REC40145 | | 65-67-81 |
| REC40155 | | 80 |
| REC40165 | 67F-24251-02 | 80-81-82 |
| REC405-A20 | 6E5-45300-16-8D | 375 |
| REC405-A20 | 6E5-45300-17-8D | 280 |
| REC405-A25 | 6E5-45300-26-8D | 375 |
| REC405-A25 | 6E5-45300-27-8D | 280 |
| REC40970 | | 121 |
| REC40990 | | 121 |
| REC416-A20 | 64D-45300-01-8D | 280 |
| REC416-A20 | 64D-45300-02-8D | 379 |
| REC416-A25 | 64D-45300-21-8D | 280 |
| REC416-A25 | 64D-45300-22-8D | 379 |
| REC416-B20 | 64K-45300-02-NA | 281 |
| REC416-B20F | 63P-45300-00-8D | 278 |
| REC416-B20F | 63P-45300-02-8D | 327 |
| REC416-B25F | 63P-45300-10-8D | 278 |
| REC416-B25F | 63P-45300-12-8D | 327 |
| REC418-A25 | 64P-45300-10-8D | 280 |
| REC418-B25F | 64P-45300-10-8D | 278 |
| REC418-B25F | 64P-45300-12-8D | 327 |
| REC421-A20 | 66K-45300-12-NA | 281 |
| REC421-A25 | 60V-45300-20-8D | 281 |
| REC421-B25F | 69J-45300-21-8D | 279 |
| REC421-B25F | 69J-45300-22-8D | 331 |
| REC421-B30F | 69J-45300-32-8D | 279 |
| REC422-B25F | 6P2-45300-20-8D | 278-339 |
| REC422-B25F | 6P2-45300-21-8D | 278-339 |
| REC422-B25F | 6P2-45300-40-8D | 278 |
| REC422-B25F | 6P2-45300-41-8D | 278 |
| REC422-B25F | 6P245300208D | 278 |
| REC422-B25F | 6P245300218D | 278 |
| REC422-B25F | 6P245300408D | 278 |
| REC422-B25F | 6P245300418D | 278 |
| REC428-A25 | 60W-45300-20-8D | 281 |
| REC428-B25F | 69K-45300-21-8D | 279 |
| REC428-B30F | 69K-45300-34-8D | 279 |
| REC429-B25F | 6P3-45300-40-8D | 278-339 |
| REC429-B25F | 6P3-45300-41-8D | 278-339 |
| REC429-B25F | 6P3-45300-42-8D | 278 |
| REC429-B25F | 6P345300408D | 278 |
| REC429-B25F | 6P345300418D | 278 |
| REC429-B25F | 6P345300428D | 278 |
| REC48630-92J00 | 61A-43811-00 | 125 |
| REC48630-92J00 | 63P-43811-10 | 125 |
| REC48630-92J00 | 63P-43811-20 | 125 |
| REC48630-92J00 | 64E-43811-02 | 125 |
| REC48630-92J00 | 64E-43821-05 | 125 |
| REC48630-92J00 | 6AW-4380R-01 | 125 |
| REC48630-92J00 | 6EK-4380R-00 | 125 |
| REC48630-94900 | 61A-43821-00 | 125 |
| REC48630-94900 | 61A-43821-01 | 125 |
| REC48630-94900 | 61A-43821-09 | 125 |
| REC48630-94900 | 67F-4380R-00 | 125 |
| REC48630-94900 | 67F-4380R-01 | 125 |
| REC48630-94900 | 67F-43811-00 | 125 |
| REC48630-96J03 | 64E-43820-00 | 125 |
| REC48630-96J03 | 64E-43820-08 | 125 |
| REC48630-96J03 | 64E-43820-09 | 125 |
| REC48630-96J03 | 64E-43820-00 | 125 |
| REC48630-96J03 | 64E-43820-08 | 125 |
| REC48630-96J03 | 64E-43821-00 | 125 |
| REC48630-96J03 | 64E-43821-08 | 125 |
| REC48630-96J03 | 64E-43821-09 | 125 |
| REC48630-96J03 | 6AW-4380R-00 | 125 |
| REC50M-14355-00 | 50M-14355-00 | 99 |
| REC5GH-13440-00 | 5GH-13440-00 | 83-183-191-197-209 |
| REC5GH-13440-00 | 5GH-13440-10 | 207 |
| REC5GH-13440-00 | 5GH-13440-30 | 83 |
| REC5GH-13440-00 | 5GH-13440-70 | 83 |
| REC5GH-13440-00 | 5GH-13440-70 | 65-66-67-68-69-70-71-83 |
| REC5GH-13440-60 | 5GH-13440-20 | 195-203 |
| REC5GH-13440-60 | 5GH-13440-50 | 83-201-205 |
| REC5GH-13440-60 | 5GH-13440-60 | 83-187 |
| REC5GH-13440-60 | 5GH-13440-60 | 65-66-67-68-69-83 |
| REC5W40U3 | | 84 |
| REC5W40U6 | | 84 |

| REF | R.O. / OEM | |
|----------------------|-----------------|---|
| REC60E-81950-00 | 60E-81950-00 | 115 |
| REC60H-12416-00 | 60H-12416-00 | 245-247 |
| REC60H-12416-00 | 6G5-12416-00 | 209-211 |
| REC60V-11181-00 | 60V-11181-00 | 249-254 |
| REC60V-12411-00 | 60V-12411-00 | 70-137 |
| REC60V-13621-A0 | 60V-13621-A0 | 276 |
| REC60V-13645-00 | 60V-13645-00 | 276 |
| REC60V-13907-00 | 60V-13907-00 | 86 |
| REC60V-24251-01 | 60V-24251-01 | 82 |
| REC60V-44150-00 | 60V-44150-00 | 385 |
| REC60V-45113-02 | 60V-45113-02 | 254 |
| REC60V-45332-00-94 | 60V-45332-00-94 | 383 |
| REC60V-45611-00 | 60V-45611-00 | 383 |
| REC60V-81950-00 | 60V-81950-00 | 115 |
| REC60V-81960-05 | 60V-81960-05 | 117 |
| REC60V-81960-05 | 60V-81960-02 | 117 |
| REC60V-81960-05 | 60V-81960-03 | 117 |
| REC60V-81960-05 | 60V-81960-04 | 117 |
| REC60V-81960-05 | 60V-81960-05 | 117 |
| REC60X-44315-A0 | 60X-44315-A0 | 339-386 |
| REC60X-W0078-00 | 60X-W0078-00 | 153-157-386 |
| REC61A-11181-A0 | 61A-11181-00 | 249-254 |
| REC61A-11193-A2 | 61A-11193-A2 | 255 |
| REC61A-11381-A0 | 61A-11381-A0 | 276 |
| REC61A-11650-00 | 61A-11650-00 | 261 |
| REC61A-12414-A0 | 61A-12414-A0 | 138-231 |
| REC61A-12414-A0 | 6J8-12414-A0 | 237 |
| REC61A-13411-00 | 61A-13411-00 | 83 |
| REC61A-13621-A0 | 61A-13621-A0 | 276 |
| REC61A-13645-00 | 61A-13645-00 | 276 |
| REC61A-13646-00 | 61A-13646-00 | 276 |
| REC61A-24563-00 | 61A-24563-00 | 81-82 |
| REC61A-41134-A0 | 61A-41134-A0 | 272 |
| REC61A-44311-00 | 61A-44311-00 | 385 |
| REC61A-44311-00 | 61A-44311-01 | 325-329-333-339-377-381-386 |
| REC61A-44311-00 | 61A-44311-00 | 155-156-157-325-329-333-339-377-381-386 |
| REC61A-44322-02 | 61A-44322-02 | 339-377-381-386 |
| REC61A-45113-A0 | 61A-45113-A0 | 254 |
| REC61A-45214-10 | 61A-45214-10 | 383 |
| REC61A-45214-11 | 61A-45214-11 | 331 |
| REC61A-45215-10 | 61A-45215-10 | 383 |
| REC61A-45215-11 | 61A-45215-11 | 331 |
| REC61A-45321-01 | 61A-45321-01 | 333-385 |
| REC61A-45331-00-94 | 61A-45331-00-94 | 333-385-386 |
| REC61A-45376-00-94 | 61A-45376-00-94 | 333-339 |
| REC61A-45376-00-94 | 61A-45376-00-94 | 341-385 |
| REC61A-45501-20 | 61A-45501-20 | 385 |
| REC61A-45501-30 | 61A-45501-30 | 385 |
| REC61A-45527-00 | 61A-45527-00 | 325-329-333-377-381-385 |
| REC61A-45538-00 | 61A-45538-00 | 325-329-333-377-381-385 |
| REC61A-45567-00/60-0 | 61A-45567-00 | 331-337 |
| REC61A-45577-00/60-0 | 61A-45577-00 | 331-337 |
| REC61A-45587-00/60-0 | 61A-45587-00 | 333-339 |
| REC61A-45587-00/60-0 | 61A-45587-00/60 | 385 |
| REC61A-45631-03 | 61A-45631-03 | 383 |
| REC61A-45632-00 | 61A-45632-00 | 331-337-383 |
| REC61A-45633-00 | 61A-45633-00 | 331-337-383-392 |
| REC61A-45634-01 | 61A-45634-01 | 331-337-341-383 |
| REC61A-45635-00 | 61A-45635-00 | 331-335-337-341-383 |
| REC61A-45641-02 | 61A-45641-02 | 331-337-383 |
| REC61A-81941-00 | 61A-81941-00 | 114 |
| REC61A-81941-11 | 6E5-81941-11 | 114 |
| REC61A-81941-01 | 61A-81941-00 | 110 |
| REC61A-81950-01 | 61A-81950-01 | 115 |
| REC61A-81950-01 | 61A-81950-01 | 115 |
| REC61A-81960-04 | 61A-81960-01 | 117 |
| REC61A-81960-04 | 61A-81960-01 | 117 |
| REC61A-81960-04 | 61A-81960-02 | 117 |
| REC61A-81960-04 | 61A-81960-04 | 117 |
| REC61A-W0001-01 | 61A-W0001-A1 | 252-254 |
| REC61A-W0078-A1 | 61A-W0078-01 | 153 |
| REC61A-W0078-A1 | 61A-W0078-A1 | 328-383 |
| REC61A-W0078-A1 | 61A-W0078-A3 | 71-72-155-157-333 |
| REC61A-W0093-01 | 61A-W0093-01 | 97 |
| REC61B-82510-02 | 61B-82510-01 | 113 |
| REC61N-11181-00 | 61N-11181-A1 | 229 |
| REC61N-11181-00 | 61N-11181-A2 | 248-254 |
| REC61N-11515-00 | 61N-11515-00 | 229 |
| REC61N-11603-00 | 61N-11603-00 | 229-263-266 |
| REC61N-11604-00 | 61N-11604-00 | 229-263 |
| REC61N-11605-00 | 61N-11605-00 | 229-263 |
| REC61N-11631-00-95 | 61N-11631-00-95 | 229-263-266 |
| REC61N-11635-00K | 61N-11635-00 | 229-263 |
| REC61N-11636-00K | 61N-11636-00 | 229-263 |
| REC61N-14198-00 | 61N-14198-00 | 274 |
| REC61N-14301-04 | 61N-14301-04 | 91-93 |
| REC61N-14392-00 | 61N-14392-00 | 93-98 |
| REC61N-24563-10 | 61N-24563-10 | 80-81 |
| REC61N-24563-10 | 61N-24563-10 | 80-82 |
| REC61N-24563-10 | 61N-24563-10 | 65-66-68-69-81 |

| REF | R.O. / OEM | |
|--------------------|-----------------|-------------------------------------|
| REC61N-26311-00 | 61N-26311-00 | 130 |
| REC61N-44146-00 | 61N-44146-00 | 361 |
| REC61N-44322-00 | 61N-44322-01 | 154-155-297-355 |
| REC61N-44323-00 | 61N-44323-00 | 149-154-155-297-355 |
| REC61N-45510-00 | 61N-45510-00 | 355-388-389 |
| REC61N-45510-10 | 61N-45510-10 | 355-388-389 |
| REC61N-45551-00 | 61N-45551-00 | 355-388-389 |
| REC61N-45560-10 | 61N-45560-00 | 295 |
| REC61N-45560-10 | 61N-45560-10 | 355-388-389 |
| REC61N-45570-00 | 61N-45571-00 | 355-388-389 |
| REC61N-85540-00 | 61N-85540-00 | 119 |
| REC61N-85570-01 | 61N-85570-01 | 105 |
| REC61N-85570-01 | 61N-85570-01 | 105 |
| REC61N-W0001-E1 | 61N-W0001-E1 | 145-354 |
| REC61N-W0078-11 | 61N-W0078-10 | 150 |
| REC61N-W0078-11 | 61N-W0078-11 | 65-66-150-154-155-297-354 |
| REC61N-W0093-00 | 61N-W0093-00 | 93-96-229 |
| REC61T-11193-A0 | 61T-11193-A1 | 229-255 |
| REC61T-45113-A0 | 61T-45113-A0 | 253 |
| REC61T-45113-A0 | 689-45113-A1 | 229 |
| REC61T-45113-A0 | 61T-45113-A0 | 254 |
| REC61T-W0001-02 | 61T-W0001-02 | 229-250-254-266-267 |
| REC624-14485-00 | 624-14485-00 | 221-225-227-231-233-237-239-241-243 |
| REC624-42542-00 | 90387-06119 | 98 |
| REC626-14390-90 | 626-14390-90 | 98 |
| REC626-44365-01 | 626-44365-01 | 349-353 |
| REC626-45316-09 | 626-45316-09 | 291-292-349 |
| REC626-45316-09 | 90381-14020 | 351 |
| REC62Y-15312-00 | 62Y-15312-00 | 271 |
| REC62Y-41133-00 | 62Y-41133-00 | 268 |
| REC62Y-45127-00 | 62Y-45127-00 | 268 |
| REC62Y-46241-00 | 62Y-46241-00 | 207-267 |
| REC62Y-W0001-22 | 62Y-W0001-20 | 146 |
| REC62Y-W0001-22 | 62Y-W0001-21 | 146 |
| REC62Y-W0001-22 | 62Y-W0001-22 | 146-306 |
| REC634-11633-00 | 634-11633-00 | 227-260-262 |
| REC63D-11181-A1 | 63D-11181-A2 | 237-248-254 |
| REC63D-11193-A0 | 63D-11193-A0 | 237-255 |
| REC63D-11603-00 | 63D-11603-00 | 237-263 |
| REC63D-11605-00 | 63D-11605-00 | 237-263 |
| REC63D-44311-01 | 63D-44311-00 | 148-156-309-313 |
| REC63D-44312-00 | 63D-44312-00 | 301-305-309-313-317-361 |
| REC63D-44316-00 | 63D-44316-00 | 301-305-309-313-361 |
| REC63D-44322-00 | 63D-44322-00 | 154-156-301-305-309-313-317-361 |
| REC63D-44323-00 | 63D-44323-00 | 305-309-313 |
| REC63D-44323-00 | 63D-44323-00-00 | 149 |
| REC63D-44323-00 | 63D-44323-00 | 154-156 |
| REC63D-44341-00 | 63D-44341-00 | 301-309-361 |
| REC63D-45114-A0 | 63D-45114-A0 | 272 |
| REC63D-45123-00 | 63D-45123-00 | 269 |
| REC63D-45361-02-4D | 63D-45361-02-4D | 299-307-361 |
| REC63D-45361-02-4D | 63D-45361-02-8D | 303-311 |
| REC63D-45361-02-4D | 63D-45361-02-8D | 389-390 |
| REC63D-85540-04 | 63D-85540-04 | 118 |
| REC63D-85540-04 | 63D-85540-01 | 118 |
| REC63D-85540-04 | 63D-85540-02 | 118 |
| REC63D-85540-04 | 63D-85540-03 | 118 |
| REC63D-85540-04 | 63D-85540-04 | 118 |
| REC63D-W0 | | |

| REF | R.O. / OEM | |
|--------------------|-----------------|-----------------------------|
| REC63P-81960-02 | 63P-81960-01 | 116 |
| REC63P-81960-02 | 63P-81960-02 | 116 |
| REC63P-82380-00 | 63P-82380-00 | 90-102 |
| REC63V-11181-A1 | 63V-11181-A1 | 248 |
| REC63V-11181-A1 | 63V-11181-A2 | 227-254 |
| REC63V-11412-00 | 63V-11412-00 | 227-256 |
| REC63V-11422-00 | 63V-11422-00 | 227-256 |
| REC63V-11432-00 | 63V-11432-00 | 227-256 |
| REC63V-11442-00 | 63V-11442-00 | 227-256 |
| REC63V-11445-00 | 63V-11445-00 | 227 |
| REC63V-11515-02 | 63V-11515-02 | 227 |
| REC63V-14126-00 | 63V-14126-00 | 94 |
| REC63V-14301-00 | 63V-14301-00 | 93 |
| REC63V-14984-00 | 63V-14984-00 | 94 |
| REC63V-14985-00 | 63V-14985-00 | 93-100 |
| REC63V-15396-01-CA | 63V-15396-01-CA | 227 |
| REC63V-24411-00 | 63V-24411-00 | 87 |
| REC63V-41111-00-1S | 63V-41111-00-1S | 227 |
| REC63V-41112-A0 | 63V-41112-A0 | 140-227 |
| REC63V-41113-00-1S | 63V-41113-00-1S | 227 |
| REC63V-41133-A1 | 63V-41133-A1 | 268 |
| REC63V-44301-00 | 63V-44301-00 | 289-291-351 |
| REC63V-44301-00 | 63V-44301-00-00 | 147 |
| REC63V-44301-00 | 63V-44301-00 | 154-155 |
| REC63V-44322-00 | 63V-44322-00 | 154-155-289-291-293-351 |
| REC63V-44323-00 | 63V-44323-00 | 351 |
| REC63V-44323-00 | 63V-44323-00-00 | 149 |
| REC63V-44352-01 | 63V-44352-01 | 143-154-155-291-293-351 |
| REC63V-44361-01 | 63V-44361-01 | 351 |
| REC63V-44361-11 | 63V-44361-11 | 351 |
| REC63V-44514-01-CA | 63V-44514-01-CA | 135 |
| REC63V-45113-A1 | 63V-45113-A1 | 227-253-254 |
| REC63V-45300-03-8D | 63V-45300-03-8D | 279 |
| REC63V-45300-03-8D | 63V-45300-03-8D | 279 |
| REC63V-45300-03-8D | 63V-45300-03-8D | 279 |
| REC63V-45300-13-8D | 63V-45300-13-8D | 279 |
| REC63V-45300-13-8D | 63V-45300-13-8D | 279 |
| REC63V-45300-13-8D | 63V-45300-13-8D | 279 |
| REC63V-45315-A0 | 63V-45315-A0 | 291-351 |
| REC63V-45331-00-5B | 63V-45331-00-5B | 291-351 |
| REC63V-45501-10 | 63V-45501-10 | 291-387-388 |
| REC63V-45510-01 | 63V-45510-01 | 351-387-388 |
| REC63V-45510-11 | 63V-45510-11 | 351-387-388 |
| REC63V-45551-00 | 63V-45551-00 | 291-293-351-387-388 |
| REC63V-85520-00 | 63V-85520-00 | 106 |
| REC63V-85533-00 | 63V-85533-00 | 104 |
| REC63V-85540-00-01 | 63V-85540-00 | 118-119 |
| REC63V-85540-00-01 | 63V-85540-01 | 118-119 |
| REC63V-85540-00-01 | 63V-85540-02 | 118 |
| REC63V-85570-00 | 63V-85570-00 | 105 |
| REC63V-85570-00 | 65E-85570-00 | 105 |
| REC63V-85580-01 | 63V-85580-01 | 107 |
| REC63V-W0001-00 | 63V-W0001-00 | 226 |
| REC63V-W0001-00 | 63V-W0001-01 | 249-254 |
| REC63V-W0001-21 | 63V-W0001-21 | 144 |
| REC63V-W0078-01 | 63V-W0078-00 | 150 |
| REC63V-W0078-01 | 63V-W0078-01 | 65-154-155-290-350 |
| REC63V-W0093-00 | 63V-W0093-00 | 93-95-226 |
| REC63W-13610-00 | 63W-13610-00 | 92-99 |
| REC646-11633-00 | 646-11633-00 | 220 |
| REC646-11651-02 | 646-11651-02 | 220-260 |
| REC646-11681-00 | 646-11681-00 | 220-260 |
| REC646-14623-A1 | 646-14623-A1 | 220-254-270 |
| REC646-44322-00 | 646-44322-00 | 343 |
| REC646-44323-00 | 646-44323-00 | 148-155-343 |
| REC646-44352-01 | 646-44352-01 | 143-155-343 |
| REC646-44365-00 | 646-44365-00 | 343 |
| REC646-44366-01 | 646-44366-01 | 343 |
| REC646-45551-00 | 646-45551-00 | 343-387 |
| REC646-45560-00 | 646-45560-00 | 343-387 |
| REC647-11610-00 | 647-11610-00 | 225-262-266 |
| REC647-11610-10 | 647-11610-10 | 225 |
| REC647-11610-20 | 647-11610-20 | 225 |
| REC647-14323-00 | 647-14323-00 | 98 |
| REC647-14385-00 | 647-14385-00 | 100 |
| REC647-14386-10 | 647-14386-10 | 99 |
| REC647-44366-00 | 647-44366-00 | 154-155-291-346-347-351 |
| REC647-45316-09 | 647-45316-09 | 347 |
| REC647-45551-00 | 647-45551-00 | 347-387 |
| REC647-45560-00 | 647-45560-00 | 347-387 |
| REC647-45570-01 | 647-45570-01 | 347-387 |
| REC647-45616-02 | 6L5-45616-02 | 345 |
| REC648-11633-00 | 648-11633-00 | 237-260-261-263-264 |
| REC648-11651-00 | 646-11651-00 | 260-261 |
| REC648-11681-00 | 646-11681-00 | 260 |
| REC648-13621-A0 | 648-13621-A1 | 273 |
| REC648-13645-A0 | 648-13645-A0 | 273 |
| REC648-14198-A0 | 648-14198-A0 | 274 |
| REC648-14384-01-00 | 648-14384-01 | 94 |
| REC648-14385-00 | 648-14385-00 | 100 |
| REC648-24411-00 | 648-24411-00 | 87 |
| REC648-24434-01 | 648-24434-01 | 88 |
| REC648-24435-02 | 648-24435-02 | 88 |
| REC648-44146-00 | 648-44146-00 | 134 |
| REC648-45633-00 | 648-45633-00 | 291-295-349-351-353-355-357 |
| REC648-45633-00 | 648-45633-11 | 293 |
| REC648-45633-00 | 648-45633-11 | 387-388-389 |

| REF | R.O. / OEM | |
|--------------------|-----------------|---|
| REC648-45635-00 | 648-45635-00 | 295-353-355 |
| REC64D-11603-01 | 64D-11603-01 | 245 |
| REC64D-11603-01 | 64D-11603-02 | 247-265-266-267 |
| REC64D-11604-01 | 64D-11603-04 | 265 |
| REC64D-11604-01 | 64D-11604-01 | 245-247 |
| REC64D-11604-01 | 64D-11604-02 | 247 |
| REC64D-11605-01 | 64D-11603-05 | 265 |
| REC64D-11605-01 | 64D-11605-01 | 245 |
| REC64D-11605-01 | 64D-11605-02 | 247 |
| REC64D-11631-00K | 64D-11631-02-90 | 247-265-267 |
| REC64D-11642-00K | 64D-11642-02-90 | 247-265-267 |
| REC64D-14384-1 | 64D-14384-01 | 94 |
| REC64D-14394-00 | 64D-14394-00 | 99 |
| REC64D-W0093-00 | 64D-W0093-00 | 97-247 |
| REC64E-13645-A0 | 64E-13645-A0 | 276 |
| REC64E-43821-05 | 64E-43821-00 | 125 |
| REC64E-43822-00 | 64E-43822-00 | 125 |
| REC64E-4384J-00 | 64E-4384J-00 | 125 |
| REC64J-24560-10 | 64J-24560-00 | 80 |
| REC64J-24560-10 | 64J-24560-10 | 80 |
| REC64J-W0001-20 | 64J-W0001-20 | 145-146 |
| REC64J-W0001-21 | 64J-W0001-21 | 146-333 |
| REC650-11370-00 | 650-11370-00 | 231 |
| REC650-11370-00 | 650-11370-01 | 225-235-237-239-241-243 |
| REC650-11651-04 | 650-11651-00 | 227-260 |
| REC650-14485-03 | 650-14485-03 | 227 |
| REC650-24351-51 | 650-24351-00 | 75 |
| REC650-24351-51 | 650-24351-01 | 75 |
| REC650-24351-51 | 650-24351-50 | 75 |
| REC650-24351-51 | 650-24351-51 | 75 |
| REC650-24431-A0 | 650-24431-A0 | 88 |
| REC650-44147-00 | 650-44147-00 | 134-363-367 |
| REC650-45635-00 | 650-45635-00 | 291-293-349-351 |
| REC655-12414-A1 | 655-12414-A1 | 138-229 |
| REC65L-13645-00 | 65L-13645-00 | 275 |
| REC65L-13646-00 | 65L-13646-00 | 275 |
| REC65L-13915-00 | 65L-13915-00 | 82 |
| REC65L-24563-00 | 65L-24563-00 | 71-72-81-82 |
| REC65N-45321-00 | 65N-45321-00 | 335 |
| REC65N-W0078-A1 | 65N-W0078-A1 | 152-157 |
| REC65W-46241-00 | 65W-46241-00 | 193-199-267 |
| REC65W-82575-01 | 65W-82575-01 | 120 |
| REC65W-W0001-00 | 65W-W0001-00 | 217 |
| REC65W-W0001-02 | 65W-W0001-02 | 190 |
| REC65W-W0001-02 | 65W-W0001-02 | 218 |
| REC65W-W0001-20 | 65W-W0001-20 | 145-297 |
| REC662-44352-01 | 662-44352-01 | 143-347 |
| REC663-11193-00 | 663-11193-A0 | 239-255 |
| REC663-11411-00 | 663-11411-01 | 239-256 |
| REC663-11561-00 | 663-11561-00 | 239 |
| REC663-11633-00 | 663-11633-00 | 239-243-260-261-264 |
| REC663-11634-00 | 663-11634-00 | 233-263 |
| REC663-11634-00 | 663-11634-00 | 235-263 |
| REC663-12414-00 | 663-12414-A0 | 138-239 |
| REC663-12416-00 | 663-12416-00 | 235-239 |
| REC663-13621-00 | 663-13621-A0 | 275 |
| REC663-14198-00 | 663-14198-A0 | 275 |
| REC663-14483-A0 | 663-14483-A0 | 275 |
| REC663-14548-00 | 663-14548-00 | 99 |
| REC663-14923-00 | 663-14923-00 | 99 |
| REC663-24411-00 | 663-24411-00 | 87 |
| REC663-41114-00 | 663-41114-A0 | 142-239 |
| REC663-42138-00 | 663-42138-00 | 129 |
| REC663-43118-01-4D | 663-43118-01-4D | 134 |
| REC663-44144-01 | 663-44144-01 | 369-371 |
| REC663-44151-00 | 663-44151-00 | 369-371 |
| REC663-44311-02 | 663-44311-02 | 359-369 |
| REC663-44311-02 | 663-44311-02-00 | 147 |
| REC663-44311-02 | 663-44341-00 | 369 |
| REC663-44311-02 | 618-44311-00 | 357 |
| REC663-44311-02 | 663-44311-02 | 155-156 |
| REC663-44315-A0 | 663-44315-A0 | 155-156-357-359-369 |
| REC663-44316-A0 | 663-44316-A0 | 357-359-369 |
| REC663-44322-00 | 663-44322-00 | 154-155-156-357-359-369 |
| REC663-44323-00 | 663-44323-00 | 149-155-156-357-359-369 |
| REC663-44324-A0 | 663-44324-A0 | 357-359-369 |
| REC663-44366-00 | 663-44366-00 | 301-305-309-313-317-321-333-337-359-361-363-367-369-371-373-385 |
| REC663-44366-00 | 663-44366-00 | 154-155-156 |
| REC663-44551-02-8D | 663-44551-02-8D | 135 |
| REC663-45123-00 | 663-45123-00 | 268 |
| REC663-45331-00-94 | 663-45331-00-94 | 369-390 |
| REC663-45375-00 | 663-45375-00 | 367 |
| REC663-45376-00 | 663-45376-00 | 305-325-335-367 |
| REC663-45376-00 | 663-45376-00-94 | 301-309-313-317-321-329 |
| REC663-45510-01 | 663-45510-01 | 369-390 |
| REC663-45552-00 | 663-45552-00 | 359-365-369 |
| REC663-45576-00 | 663-45576-00 | 365 |
| REC663-45631-00 | 663-45631-01 | 359-363-365-369-389-390 |
| REC663-45633-00 | 663-45633-00 | 359-361-363-365-369-389-390 |

| REF | R.O. / OEM | |
|------------------|-----------------|-----------------------------|
| REC663-45634-00 | 663-45634-00 | 303-307-311-359-363-365-369 |
| REC663-45987-00 | 663-45987-00 | 365 |
| REC663-45987-00 | 663-45987-02 | 299-303-307-311-359-361-369 |
| REC663-45987-00 | 663-45987-02 | 405 |
| REC663-48344-00 | 663-48344-00 | 127 |
| REC663-85518-00 | 663-85518-00 | 133 |
| REC663-85540-15 | 663-85540-15 | 119 |
| REC663-85540-15 | 663-85540-11 | 119 |
| REC663-W0078-01 | 663-W0078-00 | 368 |
| REC663-W0078-01 | 663-W0078-01 | 152-368 |
| REC663-W0078-A0 | 663-W0078-A0 | 151 |
| REC663-W0078-01 | 663-W0078-A0 | 156 |
| REC664-41114-A0 | 664-41114-A0 | 140 |
| REC664-41134-A0 | 664-41134-A0 | 268 |
| REC664-44338-00 | 63V-44338-00 | 351 |
| REC664-44338-00 | 664-44338-00 | 289-291-293-353 |
| REC664-44338-00 | 664-44338-00 | 154-155 |
| REC664-45384-00 | 664-45384-00 | 353-357 |
| REC664-45631-00 | 664-45631-02 | 355-388-389 |
| REC664-45631-01 | 664-45631-01 | 353 |
| REC664-45987-00 | 664-45987-00 | 353 |
| REC66K-13907-00 | 66K-13907-00 | 86 |
| REC66K-13915-00 | 66K-13915-00 | 82 |
| REC66K-14984-00 | 66K-14984-00 | 86-88 |
| REC66K-45501-00 | 66K-45501-00 | 385 |
| REC66M-46241-00 | 66M-46241-00 | 185-267 |
| REC66M-W0001-01 | 66M-W0001-01 | 182-216-218 |
| REC66M-W0001-20 | 66M-W0001-20 | 144-290 |
| REC66M-W0093-01 | 66M-W0093-01 | 95-182 |
| REC66N-11603-00 | 66N-11603-00 | 183-219 |
| REC66T-11181-00 | 66T-11181-A0 | 249 |
| REC66T-11181-00 | 66T-11181-A2 | 233-254 |
| REC66T-11193-A0 | 66T-11193-A0 | 233-255 |
| REC66T-11412-00 | 66T-11412-00 | 233-256 |
| REC66T-11422-00 | 66T-11422-00 | 233-256 |
| REC66T-11432-00 | 66T-11432-00 | 233-256 |
| REC66T-11442-00 | 66T-11442-00 | 233-256 |
| REC66T-11603-00 | 66T-11603-00 | 233-263 |
| REC66T-11604-00 | 66T-11604-00 | 233-263 |
| REC66T-11605-00 | 66T-11605-00 | 233-263 |
| REC66T-11631-01K | 66T-11631-01-93 | 233-263-266 |
| REC66T-11635-01K | 66T-11635-01 | 233-263 |
| REC66T-11636-01K | 66T-11636-01 | 233-263 |
| REC66T-11681-00 | 66T-11681-00 | 233-260-261 |
| REC66T-14301-60 | 66T-14301-60 | 92-93 |
| REC66T-14384-01 | 66T-14384-01 | 94 |
| REC66T-14536-01 | 66T-14536-01 | 94 |
| REC66T-14992- | | |

| REF | R.O. / OEM | | REF | R.O. / OEM | | REF | R.O. / OEM | |
|--------------------|-----------------|-----------------------------|--------------------|-----------------|-------------------------|--------------------|-----------------|---|
| REC676-41133-A0 | 676-41133-A0 | 269 | REC67F-44311-01 | 67F-44311-01-00 | 148-154-155 | REC688-12414-A1 | 688-12414-A1 | 138-139-243-245-247 |
| REC676-43160-02 | 676-43160-02 | 132 | REC67F-44322-00 | 67F-44322-00 | 321-154-155 | REC688-12416-00 | 688-12416-00 | 139-243 |
| REC676-43160-02 | 676-43160-01 | 132 | REC67F-44323-00 | 67F-44323-00 | 149-154-155-321 | REC688-13610-00 | 688-13610-00 | 99 |
| REC676-43160-02 | 676-43160-02 | 132 | REC67F-44352-00 | 67F-44352-00 | 143-321-154-155 | REC688-13621-A1 | 688-13621-A1 | 274 |
| REC676-44311-00 | 676-44311-00 | 148-156-363-367 | REC67F-45113-00 | 67F-45113-00 | 272 | REC688-14198-A1 | 688-14198-A2 | 274 |
| REC676-44315-00 | 676-44315-A0 | 367 | REC67F-45123-00 | 67F-45123-00 | 269 | REC688-14416-01 | 688-14416-01 | 274 |
| REC676-44315-00 | 676-44315-A1 | 156-363 | REC67F-45127-00 | 67F-45127-00 | 269 | REC688-14483-A0 | 688-14483-A0 | 274 |
| REC676-44316-A1 | 676-44316-A1 | 363 | REC67F-45331-00-CA | 67F-45331-00-94 | 319 | REC688-14548-00 | 688-14548-00 | 99 |
| REC676-44322-00 | 676-44322-00 | 156-367 | REC67F-45501-10 | 67F-45501-10 | 321-391 | REC688-14947-00 | 688-14947-00 | 98 |
| REC676-44323-00-40 | 676-44323-00 | 149-156-367-363 | REC67F-45560-00 | 67F-45560-00 | 319-390-391 | REC688-41112-A0 | 688-41112-A0 | 142-243 |
| REC676-44324-A0 | 676-44324-A0 | 367 | REC67F-45570-00 | 67F-45570-00 | 391 | REC688-41114-A0 | 688-41114-A0 | 142-243 |
| REC676-44324-A0 | 676-44324-A1 | 363 | REC67F-45576-00 | 67F-45576-00 | 315-319 | REC688-41134-00 | 688-41134-A0 | 269 |
| REC676-44341-00 | 676-44341-94 | 363 | REC67F-45611-01 | 67F-45611-01 | 315-319-391 | REC688-41211-01 | 688-41211-01 | 132 |
| REC676-44361-00 | 676-44361-00 | 367 | REC67F-45997-00 | 67F-45997-00 | 315-319-371-405 | REC688-41211-01 | 688-41211-01 | 132 |
| REC676-44361-10 | 676-44361-10 | 367 | REC67F-46241-00 | 67F-46241-00 | 209-267 | REC688-41217-00 | 688-41217-00 | 101 |
| REC676-44518-00 | 676-44518-00 | 135 | REC67F-81960-12 | 67F-81960-00 | 116 | REC688-43160-01 | 688-43160-01 | 132 |
| REC676-45114-A1 | 676-45114-A1 | 271 | REC67F-85570-00 | 67F-85570-00 | 105 | REC688-44120-12 | 688-44120-11 | 134 |
| REC676-45127-00 | 676-45127-00 | 269 | REC67F-W0001-00 | 67F-W0001-00 | 217 | REC688-44120-22 | 688-44120-22 | 134 |
| REC676-45128-00 | 676-45128-00 | 269 | REC67F-W0001-01 | 67F-W0001-01 | 209 | REC688-44311-01 | 688-44311-01 | 148-371 |
| REC676-45314-00 | 676-45314-00 | 363 | REC67F-W0001-01 | 67F-W0001-01 | 218 | REC688-44311-01 | 688-44311-01 | 156 |
| REC676-45361-00 | 676-45361-01-94 | 363-390 | REC67F-W0001-20 | 67F-W0001-20 | 145-318 | REC688-44311-01 | 688-44311-01-00 | 373 |
| REC676-45501-10 | 676-45501-10 | 363-389-390 | REC67F-W0078-00 | 67F-W0078-00 | 69-70-152-154-155-318 | REC688-44315-00 | 688-44315-A0 | 321-371 |
| REC676-45533-00 | 676-45533-00 | 363 | REC67F-W0093-00 | 67F-W0093-00 | 97-209 | REC688-44315-00 | 688-44315-A0-00 | 154-155-156 |
| REC676-45587-00 | 676-45587-00-70 | 363 | REC67H-11411-00 | 67H-11411-00 | 256 | REC688-44316-00 | 688-44316-00 | 373 |
| REC676-45587-00-75 | 676-45587-00-75 | 363 | REC67H-13907-00 | 67H-13907-00 | 86 | REC688-44316-00 | 688-44316-A0 | 321 |
| REC676-45587-00-80 | 676-45587-00-80 | 363 | REC67H-8592A-01 | 67H-8592A-01 | 103 | REC688-44316-00 | 688-44316-A0-00 | 373 |
| REC676-45635-00 | 676-45635-00 | 359-363-365 | REC682-11351-A0 | 682-11351-A0 | 253 | REC688-44322-00 | 688-44322-00 | 156-371 |
| REC677-11181-A0 | 677-11181-A1 | 225-248-254 | REC682-11412-00 | 682-11412-00 | 256 | REC688-44322-00 | 688-44322-00-00 | 373 |
| REC677-11412-02 | 677-11412-02 | 225-256 | REC682-11422-00 | 682-11422-00 | 256 | REC688-44323-00 | 688-44323-00-00 | 149-373 |
| REC677-11422-02 | 677-11422-02 | 225-256 | REC682-11432-00 | 682-11432-00 | 256 | REC688-44323-00 | 688-44323-00 | 156-371 |
| REC677-11432-02 | 677-11432-02 | 225-256 | REC682-11442-00 | 682-11442-00 | 256 | REC688-44324-00 | 688-44324-00 | 321-371 |
| REC677-11442-02 | 677-11442-02 | 225-256 | REC682-11610-01 | 682-11610-01 | 262 | REC688-44324-A0-00 | 688-44324-A0-00 | 373 |
| REC677-11631-00K | 677-11631-00-97 | 225-262-266 | REC682-11610-01 | 682-11610-01 | 227-266 | REC688-44341-01 | 688-44341-01-94 | 371 |
| REC677-11635-00K | 677-11635-00 | 225-262 | REC682-11610-21 | 682-11610-21 | 227-262 | REC688-44341-01 | 688-44341-01-94 | 321 |
| REC677-11636-00K | 677-11636-00 | 225-262 | REC682-11681-00 | 682-11681-00 | 227-260 | REC688-44341-01 | 688-44341-01-94 | 373 |
| REC677-11651-00 | 677-11651-00 | 260 | REC682-12413-00-1S | 682-12413-00-1S | 139-227 | REC688-44352-03 | 688-44352-03-00 | 143-156-371 |
| REC677-13621-00 | 677-13621-A1 | 273 | REC682-12413-00-9M | 682-12413-00-9M | 139 | REC688-44352-03 | 688-44352-03-00 | 373 |
| REC677-14198-A1 | 677-14198-A1 | 273 | REC682-12414-A1 | 682-12414-A1 | 138-139-227 | REC688-44361-10 | 688-44361-10 | 371 |
| REC677-14227-00 | 677-14227-01 | 94 | REC682-13621-A0 | 682-13621-A0 | 273 | REC688-44514-00 | 688-44514-00 | 135 |
| REC677-14343-68 | 677-14343-68 | 98 | REC682-41112-00 | 682-41112-A1 | 140 | REC688-45113-A0 | 688-45113-A0 | 243-253-254 |
| REC677-14384-01 | 677-14384-01 | 94 | REC682-41114-00 | 682-41114-A1 | 140 | REC688-45114-A1 | 688-45114-A1 | 272 |
| REC677-24434-02 | 677-24434-02 | 273 | REC682-41133-A0 | 682-41133-A0 | 268 | REC688-45123-00 | 688-45123-00 | 269 |
| REC677-24435-01 | 677-24435-01 | 87 | REC682-41237-50 | 682-41237-50 | 133 | REC688-45214-02 | 688-45214-02 | 323-365 |
| REC677-24471-01 | 677-24471-01 | 87 | REC682-41237-50 | 682-41237-50 | 349-357 | REC688-45215-02 | 688-45215-02 | 323-365 |
| REC677-26301-02 | 677-26301-02 | 130 | REC682-44147-00 | 682-44147-00 | 349 | REC688-45331-00-94 | 688-45331-00-94 | 371-373-388-390-391 |
| REC677-41112-A0 | 677-41112-A1 | 225 | REC682-44176-00 | 682-44176-00 | 349 | REC688-45341-00 | 688-45341-00 | 295-359-375 |
| REC677-41112-A0 | 677-41114-A0 | 140 | REC682-44312-00 | 682-44312-00 | 349 | REC688-45341-00 | 688-45341-00-00 | 373 |
| REC677-41112-A0 | 677-41114-A1 | 225-389 | REC682-44315-00 | 682-44315-00 | 154-155-156-349 | REC688-45341-00 | 688-45341-10 | 299-303-307-311-315-319-323-327-331-335-337-341-355-361-363-369-370-379 |
| REC677-45113-A0 | 677-45113-A0 | 225-252-254 | REC682-44322-00 | 682-44322-00 | 154-155-156-349 | REC688-45375-00 | 63D-45375-00 | 317-321-325 |
| REC677-W0093-00 | 677-W0093-00 | 95-225 | REC682-44323-40 | 682-44323-00 | 154-155-156-349 | REC688-45375-00 | 688-45375-00 | 329-371 |
| REC679-14923-00 | 679-14923-00 | 99 | REC682-44328-00 | 682-44328-00 | 349 | REC688-45383-01 | 688-45383-02 | 315-319-323-371-375 |
| REC679-44150-00 | 679-44150-00 | 367 | REC682-44352-01 | 682-44352-00 | 349 | REC688-45383-01 | 688-45383-02-00 | 373 |
| REC679-44150-10 | 679-44150-10 | 367 | REC682-44352-01 | 682-44352-03 | 143-154-155-156 | REC688-45384-00 | 688-45384-00 | 371-375 |
| REC679-44152-00 | 679-44152-00 | 367 | REC682-44352-01 | 682-44352-03 | 143-154-155-156 | REC688-45384-00 | 688-45384-02 | 315-319-323 |
| REC679-44316-A0 | 679-44316-A0 | 367 | REC682-44361-01 | 682-44361-01 | 349 | REC688-45384-00 | 688-45384-00-00 | 373 |
| REC679-44341-00 | 679-44341-00-94 | 367 | REC682-44361-10 | 682-44361-10 | 349 | REC688-45501-10 | 688-45501-10 | 390-391 |
| REC679-44514-00-94 | 679-44514-00-94 | 135 | REC682-44365-00 | 682-44365-00 | 154-155-156-349 | REC688-45501-11 | 688-45501-11 | 371-390-391 |
| REC679-45315-A1 | 679-45315-A1 | 365 | REC682-44514-01-94 | 682-44514-01-94 | 135 | REC688-45536-01 | 688-45536-01 | 317-321 |
| REC679-45321-02 | 679-45321-02 | 365 | REC682-45113-A0 | 682-45113-02 | 254-271 | REC688-45551-00 | 688-45551-01 | 371-390-391 |
| REC679-45331-00 | 679-45331-00-94 | 365 | REC682-45376-01 | 682-45376-01 | 349 | REC688-45551-00 | 688-45551-01-00 | 373 |
| REC679-45501-10 | 679-45501-10 | 367-389 | REC682-W0078-A1 | 682-W0078-A1 | 156-348 | REC688-45560-00 | 688-45560-00 | 371-390-391 |
| REC679-45536-00 | 679-45536-00 | 367 | REC683-44362-01 | 683-44362-01 | 349 | REC688-45560-00 | 688-45560-00-00 | 373 |
| REC679-45560-00 | 679-45560-00 | 365-389 | REC683-44365-01 | 683-44365-01 | 349 | REC688-45571-00-00 | 688-45571-01 | 371 |
| REC679-45571-00 | 679-45571-00 | 365 | REC683-44373-00 | 683-44373-00 | 349 | REC688-45611-00 | 688-45611-00 | 390-391 |
| REC679-45611-00 | 679-45611-01 | 359-365-389-390 | REC683-45315-A0 | 683-45315-00 | 349 | REC688-45611-00 | 688-45611-01 | 371-390-391 |
| REC679-W0078-A1 | 679-W0078-00 | 151-156 | REC683-45361-01-4D | 683-45361-00-EJ | 349 | REC688-45631-01 | 688-45631-01 | 371-390-391 |
| REC67C-11181-01 | 67C-11181-01 | 197-215-218 | REC683-45361-01-4D | 683-45361-02-4D | 291-351 | REC688-45633-00 | 688-45633-00-00 | 315-319-371-390-391 |
| REC67C-11351-01 | 67C-11351-01 | 197-207-218 | REC683-45361-01-4D | 683-45361-02-8D | 293 | REC688-45633-00 | 688-45633-00-00 | 373 |
| REC67C-11356-00 | 67C-11356-00 | 197 | REC683-45361-02-4D | 683-45361-02-8D | 387-388 | REC688-45634-00 | 688-45634-00 | 371 |
| REC67C-11603-00 | 67C-11603-00 | 193-195-199-201-203-205-219 | REC683-45611-00 | 683-45611-00 | 291-293-349-351-387-388 | REC688-45635-00 | 688-45635-00 | 369-371 |
| REC67C-15312-00 | 67C-15312-00 | 271 | REC683-W0001-21 | 683-W0001-21 | 351-387-388 | REC688-45987-00 | 688-45987-01 | 315-319-371-405 |
| REC67C-41114-00 | 67C-41114-00 | 141 | REC683-W0001-21 | 683-W0001-C1 | 144 | REC688-45987-00 | 688-45987-01-00 | 373 |
| REC67C-41114-00 | 67C-41114-10 | 197 | REC688-11111-02-1S | 688-11111-02-1S | 243 | REC688-45997-00 | 688-45997-00 | 383 |
| REC67C-41133-00 | 67C-41133-00 | 268 | REC688-11181-A1 | 688-11181-A1 | 243 | REC688-45997-01 | 688-45997-01 | 323-327-331-335-337-375-379-405 |
| REC67C-43880-01 | 67C-43880-00 | 122 | REC688-11181-A2 | 688-11181-A2 | 249-254 | REC688-45997-01 | 688-45997-01-00 | 373 |
| REC67C-43880-01 | 67C-43880-01 | 122 | REC688-11193-A1 | 688-11193-A1 | 243-255 | REC688-45997-01 | 688-45997-01 | 373 |
| REC67C-45113-00 | 67C-45113-00 | 271 | REC688-11370-00 | 688-11370-01 | 237-241-243 | REC688-45997-01 | 688-45997-01 | 373 |
| REC67C-45123-00 | 67C-45123-00 | 268 | REC688-11411-00 | 688-11411-01 | 243-256 | REC688-45997-01 | 688-45997-01 | 373 |
| REC67C-45501-00 | 67C-45501-00 | 301-305-389-390 | REC688-11603-A0 | 688-11603-A0 | 239-243-264-266 | REC688-4599 | | |

| REF | R.O. / OEM | |
|--------------------|-----------------|---------------------|
| REC688-W0001-A0 | 688-W0001-A0 | 254 |
| REC689-11181-00 | 689-11181-A2 | 248-254 |
| REC689-11610-00 | 689-11610-01 | 263-266 |
| REC689-11631-00K | 689-11631-00-95 | 263-266 |
| REC689-11633-00 | 689-11633-00 | 229-260-263 |
| REC689-11651-00 | 689-11651-00 | 229-260-261 |
| REC689-11681-00 | 689-11681-01 | 229-260-261 |
| REC689-15396-01-CA | 689-15396-01-5B | 229 |
| REC689-15755-00 | 689-15755-00 | 134 |
| REC689-41112-A0 | 689-41112-A0 | 141 |
| REC689-41114-A0 | 689-41114-A0 | 141 |
| REC689-44311-00 | 689-44311-03 | 147-155-353 |
| REC689-44315-A0 | 689-44315-A0 | 353 |
| REC689-44316-A0 | 689-44316-A0 | 353 |
| REC689-44323-00 | 689-44323-03 | 155-353 |
| REC689-44324-A0 | 689-44324-A0 | 155-353 |
| REC689-44352-02 | 689-44352-02 | 143-155-353 |
| REC689-44366-00 | 689-44366-00 | 155-353-355 |
| REC689-45501-10 | 689-45501-10 | 353-388-389 |
| REC689-45551-00 | 689-45551-00 | 353-388-389 |
| REC689-45560-00 | 689-45560-00 | 353-388-389 |
| REC689-45571-00-00 | 689-45571-00 | 353-388-389 |
| REC689-45611-00 | 689-45611-00 | 353-388-389 |
| REC689-45997-00 | 689-45997-00 | 295-353-355-357-405 |
| REC689-81311-40 | 66M-85570-00 | 105 |
| REC689-85540-21 | 689-85540-20 | 119 |
| REC689-85540-21 | 689-85540-21 | 119 |
| REC689-W0001-20 | 689-W0001-20 | 145 |
| REC689-W0001-21 | 689-W0001-21 | 145-353 |
| REC689-W0001-C2 | 689-W0001-C2 | 145 |
| REC689-W0078-04 | 689-W0078-04 | 151-155 |
| REC689-W0078-A6 | 689-W0078-A6 | 151-155-353 |
| REC689-W0093-02 | 689-W0093-02 | 95 |
| REC689-W4432-01 | 689-W4432-02 | 155-156-353 |
| REC68D-E1603-00 | 68D-E1603-00 | 175-219 |
| REC68F-11181-00 | 68F-11181-00 | 249-254 |
| REC68F-11193-02 | 68F-11193-02 | 255 |
| REC68F-11381-00 | 68F-11381-00 | 276 |
| REC68F-13440-00 | 68F-13440-00 | 83 |
| REC68F-13907-01 | 68F-13907-01 | 86 |
| REC68F-13915-00 | 68F-13915-00 | 82 |
| REC68F-24563-10 | 68F-24563-10 | 81 |
| REC68F-24563-10 | 68F-24563-10 | 81 |
| REC68F-41114-00 | 68F-41114-00 | 142 |
| REC68F-45113-01 | 68F-45113-01 | 253-254 |
| REC68F-8195A-00 | 68F-8195A-00 | 115 |
| REC68F-83688-00 | 68F-83688-00 | 90-102 |
| REC68F-83688-10 | 68F-83688-10 | 90-102 |
| REC68F-8592A-00 | 68F-8592A-00 | 103 |
| REC68F-W0001-01 | 68F-W0001-01 | 252-254 |
| REC68T-13475-00 | 68T-13475-00 | 271 |
| REC68T-24251-00 | 68T-24251-00 | 80-82 |
| REC68T-24251-01 | 68T-24251-01 | 80 |
| REC68T-24251-00 | 6EE-F4251-00 | 80 |
| REC68T-24251-00 | 68T-24251-00 | 64-65-81 |
| REC68T-24410-00-00 | 68T-24410-00 | 85 |
| REC68T-24410-00-00 | 68T-24410-01 | 85 |
| REC68T-44323-00 | 68T-44323-00 | 149-154-289-293 |
| REC68T-44352-00 | 68T-44352-00 | 143-154-289 |
| REC68T-44366-00 | 68T-44366-00 | 154-289 |
| REC68T-45551-00 | 60N-G5551-A0 | 289 |
| REC68T-46241-00 | 60R-G6241-00 | 180 |
| REC68T-46241-00 | 68T-46241-00 | 267 |
| REC68T-85540-00 | 68T-85540-00 | 118 |
| REC68T-W0001-20 | 68T-W0001-20 | 144-289 |
| REC68T-W0078-00 | 68T-W0078-00 | 150-289 |
| REC68T-W0078-01 | 68T-W0078-01 | 64-65-150-154 |
| REC68V-11351-00 | 68V-11351-00 | 209-218 |
| REC68V-12111-00 | 68V-12111-00 | 209 |
| REC68V-13761-10 | 68V-13761-10 | 90 |
| REC68V-13907-00 | 68V-13907-00 | 86 |
| REC68V-13907-01 | 68V-13907-01 | 86 |
| REC68V-13907-02 | 68V-13907-02 | 86 |
| REC68V-13907-03 | 68V-13907-03 | 86 |
| REC68V-13907-04 | 68V-13907-04 | 86 |
| REC68V-13915-00 | 68V-13915-00 | 72-82 |
| REC68V-14984-00 | 68V-14984-00 | 72-86-88 |
| REC68V-15312-00 | 68V-15312-00 | 272 |
| REC68V-24410-00 | 68V-24410-00 | 85 |
| REC68V-24563-00 | 68V-24563-00 | 68-80-81-82 |
| REC68V-44323-00 | 6EK-44323-00 | 149-155-269-325 |
| REC68V-45123-00 | 68V-45123-00 | 325 |
| REC68V-45501-10 | 68V-45501-10 | 269 |
| REC68V-81950-00 | 68V-81950-00 | 325 |
| REC68V-82380-00 | 68V-82380-00 | 115 |
| REC68V-85885-00 | 68V-85885-00 | 90-102 |
| REC68V-8A360-00 | 68V-8A360-00 | 90-102 |
| REC68V-8A360-00 | 68V-13761-00 | 89 |
| REC68V-8A360-00 | 68V-8A360-00 | 89-90 |
| REC68V-W0001-20 | 68V-W0001-20 | 147-322 |
| REC68V-W0078-00 | 68V-W0078-00 | 70-71-152-155-322 |
| REC692-14590-01 | 692-14590-00 | 98 |
| REC692-14590-01 | 692-14590-01 | 98 |
| REC692-14923-00 | 692-14923-00 | 98 |
| REC692-24410-00 | 692-24410-00 | 85 |
| REC692-24410-00 | 6A0-24410-00 | 85 |
| REC692-24410-00 | 6A0-24410-03 | 85 |
| REC692-24410-00 | 6A0-24410-04 | 85 |
| REC692-24410-00 | 6A0-24410-05 | 85 |
| REC692-24411-00 | 692-24411-00 | 85 |
| REC692-26301-03 | 692-26301-03 | 130 |
| REC692-26301-03 | 692-26301-01 | 130 |

| REF | R.O. / OEM | |
|--------------------|-----------------|-------------|
| REC692-26301-03 | 692-26301-02 | 130 |
| REC692-26301-03 | 692-26301-03 | 130 |
| REC692-41256-00 | 692-41256-00 | 101 |
| REC692-44120-22 | 692-44120-21 | 134 |
| REC692-44120-22 | 692-44120-22 | 134 |
| REC692-45300-16-8D | 692-45300-12-4D | 280 |
| REC692-45300-16-8D | 692-45300-13-4D | 280 |
| REC692-45300-16-8D | 692-45300-14-4D | 280-370 |
| REC692-W0078-02 | 692-W0078-00-00 | 373 |
| REC692-W0078-02 | 692-W0078-01-00 | 373 |
| REC692-W0078-02 | 692-W0078-00 | 152 |
| REC692-W0078-02 | 692-W0078-01 | 152 |
| REC692-W0078-02 | 692-W0078-02 | 152-156-370 |
| REC695-11181-00 | 695-11181-A1 | 248-254 |
| REC695-85540-11 | 695-85540-11 | 119 |
| REC695-85540-11 | 695-85540-12 | 119 |
| REC695-W0001-A2 | 695-W0001-01 | 250-254 |
| REC696-14590-01 | 696-14590-01 | 98 |
| REC696-45113-00 | 696-45113-00 | 239 |
| REC696-45113-00 | 696-45113-A0 | 253-254 |
| REC696-85540-12 | 696-85540-11 | 119 |
| REC696-85540-12 | 696-85540-12 | 119 |
| REC696-85540-12 | 696-85540-12 | 119 |
| REC696-W0093-00 | 696-W0093-00 | 239 |
| REC696-W0093-00 | 696-W0093-02 | 96 |
| REC697-11181-A1 | 697-11181-A2 | 239-249-254 |
| REC697-45114-00 | 697-45114-A0 | 254-271 |
| REC697-45384-00 | 697-45384-00 | 359-365-369 |
| REC697-45551-00 | 697-45551-00 | 369-390 |
| REC697-45560-00 | 697-45560-00 | 369-390 |
| REC697-45570-00 | 697-45571-00 | 369 |
| REC697-45571-00-00 | 697-45571-00 | 390 |
| REC697-45611-00 | 697-45611-00 | 369-388-390 |
| REC697-85570-00 | 697-85570-00 | 105 |
| REC697-85570-10 | 697-85570-11 | 105 |
| REC697-W0001-02 | 697-W0001-02 | 239 |
| REC697-W0001-02 | 697-W0001-A0 | 251 |
| REC697-W0001-02 | 697-W0001-A0 | 254 |
| REC698-W0001-21 | 698-W0001-21 | 145-368 |
| REC69D-45501-10 | 69D-45501-10 | 390 |
| REC69D-W0001-20 | 69D-W0001-20 | 146 |
| REC69G-45510-10 | 69G-45510-10 | 387 |
| REC69G-45510-20 | 69G-45510-20 | 387 |
| REC69G-W0001-20 | 69G-W0001-20 | 144-289 |
| REC69G-W0078-01 | 69G-W0078-00 | 150 |
| REC69G-W0078-01 | 69G-W0078-01 | 150 |
| REC69J-11181-03 | 69J-11181-03 | 216-218 |
| REC69J-11182-03 | 69J-11182-03 | 216-218 |
| REC69J-11351-11 | 69J-11351-11 | 213-218 |
| REC69J-12111-00 | 69J-12111-00 | 211 |
| REC69J-12119-00 | 69J-12119-00 | 211 |
| REC69J-13645-00 | 69J-13645-A1 | 273 |
| REC69J-13761-00 | 69J-13761-00 | 90 |
| REC69J-13906-00 | 69J-13906-00 | 89-90 |
| REC69J-13907-03 | 69J-13907-03 | 86 |
| REC69J-13907-03 | 69J-13907-01 | 86 |
| REC69J-13907-03 | 69J-13907-02 | 86 |
| REC69J-13907-03 | 69J-13907-03 | 86 |
| REC69J-13907-03 | 69J-13907-04 | 86 |
| REC69J-15451-00 | 69J-15451-00 | 213 |
| REC69J-15451-00 | 69J-15451-A1 | 273 |
| REC69J-24410-02 | 69J-24410-01 | 86 |
| REC69J-24410-02 | 69J-24410-02 | 86 |
| REC69J-24501-10 | 69J-24501-10 | 71-72-81 |
| REC69J-24502-00 | 69J-24502-00 | 81 |
| REC69J-41134-A0 | 69J-41134-A0 | 270 |
| REC69J-41135-A0 | 69J-41135-A0 | 270 |
| REC69J-41138-00 | 69J-41138-00 | 270 |
| REC69J-45123-00 | 69J-45123-00 | 270 |
| REC69J-45361-00-8D | 69J-45361-00-8D | 331-383 |
| REC69J-45375-00 | 69J-45375-00 | 331-383 |
| REC69J-45611-00 | 69J-45611-00 | 331-337-392 |
| REC69J-45631-00 | 69J-45631-00 | 331-337-392 |
| REC69J-46241-00 | 69J-46241-00 | 267 |
| REC69J-81960-13 | 69J-81960-10 | 116 |
| REC69J-81960-13 | 69J-81960-11 | 116 |
| REC69J-81960-13 | 69J-81960-12 | 116 |
| REC69J-81960-13 | 69J-81960-13 | 116 |
| REC69J-85885-00 | 69J-85885-00 | 90-102 |
| REC69J-W0001-20-00 | 69J-W0001-20 | 147 |
| REC69K-45611-00 | 69K-45611-00 | 331-337 |
| REC69L-11635-00-85 | 69L-11635-00-85 | 267 |
| REC69L-11642-00 | 69L-11642-00-85 | 267 |
| REC69M-E1603-01 | 69M-E1603-01 | 173-219 |
| REC69P-85541-09 | 69P-85541-09 | 107 |
| REC69W-82575-00 | 69W-82575-00 | 120 |
| REC6A0-14325-00 | 6A0-14325-00 | 99 |
| REC6A0-24410-04 | 6A0-24410-00 | 85 |
| REC6A0-24410-04 | 6A0-24410-01 | 85 |
| REC6A0-24410-04 | 6A0-24410-02 | 85 |
| REC6A0-24410-04 | 6A0-24410-03 | 85 |
| REC6A0-24410-04 | 6A0-24410-04 | 85 |
| REC6A0-82550-01 | 6A0-82550-01 | 120 |
| REC6A0-W0001-21 | 6A0-W0001-21 | 146 |
| REC6A1-14301-03 | 6A1-14301-03 | 92-93 |
| REC6A1-14613-A0 | 6A1-14613-00 | 270 |
| REC6A1-14613-A0 | 6A1-14613-01 | 270 |
| REC6A1-14613-A0 | 6A1-14613-A0 | 220-270 |
| REC6A1-44325-00 | 6A1-44325-00P | 343 |
| REC6A1-44361-00 | 6A1-44361-00 | 343 |
| REC6A1-85540-01 | 6A1-85540-00 | 118 |
| REC6A1-85540-01 | 6A1-85540-01 | 118 |
| REC6A1-85570-00 | 6A1-85570-00 | 105 |
| REC6A1-W0001-22 | 6A1-W0001-22 | 144 |

| REF | R.O. / OEM | |
|-----------------|--------------|-------------|
| REC6A1-W0001-23 | 6A1-W0001-23 | 144-343 |
| REC6A1-W0078-01 | 6A1-W0078-01 | 150-155-343 |
| REC6A1-W0093-01 | 6A1-W0093-01 | 93-95 |
| REC6AG-11181-00 | 6AG-11181-00 | 215 |
| REC6AG-11181-00 | 6AG-11181-10 | 187-218 |
| REC6AH-11351-00 | 6AH-11351-10 | 187-218 |
| REC6AH-12411-00 | 69M-12411-00 | 136 |
| REC6AH-12411-00 | 69M-12411-01 | 136-173-175 |
| REC6AH-12411-00 | 6AH-12411-00 | 136-187 |
| REC6AH-12411-00 | 6G8-12411-00 | 181 |
| REC6AH-12411-00 | 6AH-12411-00 | 65-137 |
| REC6AH-13329-00 | 6AH-13329-00 | 271 |
| REC6AH-15312-00 | 6AH-15312-00 | 271 |
| REC6AH-W0078-00 | 6AH-W0078-00 | 150-153-292 |
| REC6AH-W0078-00 | 6AH-W0078-01 | 150-292 |
| REC6AH-W0078-00 | 6AH-W0078-01 | 65-154 |
| REC6AW-11181-00 | 6AW-11181-00 | 214-216-218 |
| REC6AW-11182-00 | 6AW-11182-00 | 214-216-218 |
| REC6AW-11351-00 | 6AW-11351-00 | 214-218 |
| REC6AW-12411-00 | 6AW-12411-00 | 73-137-214 |
| REC6AW-13907-00 | 6AW-13907-00 | 86 |
| REC6AW-13907-00 | 6P2-13907-00 | 86 |
| REC6AW-14613-00 | 6AW-14613-00 | 272 |
| REC6AW-14623-00 | 6AW-14623-00 | 272 |
| REC6AW-14984-00 | 65L-13907-00 | 86 |
| REC6AW-14984-00 | 66K-13907-00 | 86 |
| REC6AW-14984-00 | 67H-13907-00 | 86 |
| REC6AW-14984-00 | 6AW-14984-00 | 73-88 |
| REC6AW-15312-00 | 6AW-15312-00 | 272 |
| REC6AW-15451-00 | 6AW-15451-00 | 214-272 |
| REC6AW-41134-01 | 6AW-41134-00 | 270 |
| REC6AW-43880-02 | 6AW-43880-00 | 123 |
| REC6AW-43880-02 | 6AW-43880-01 | 123 |
| REC6AW-43880-02 | 6AW-43880-02 | 123 |
| REC6AW-44311-01 | 6AW-44311-01 | 148-341 |
| REC6AW-44311-01 | 6AW-44311-01 | 148 |
| REC6AW-44312-00 | 6AW-44312-00 | 335-341 |
| REC6AW-44315-00 | 6AW-44315-00 | 341 |
| REC6AW-44322-00 | 6AW-44322-00 | 335-341 |

| REF | R.O. / OEM | |
|---------------------|-----------------|---------------------------------|
| REC6D8-12111-00 | 6D8-12111-00 | 209 |
| REC6D8-12121-00 | 6D8-12121-10 | 209 |
| REC6D8-13761-00 | 6D8-13761-00 | 89-90 |
| REC6D8-82310-00 | 6D8-24560-08/09 | 80-81 |
| REC6D8-82310-00 | 68V-24560-00/01 | 80-81 |
| REC6D8-43880-09 | 6D8-43880-00 | 123 |
| REC6D8-43880-09 | 6D8-43880-09 | 123 |
| REC6D8-WS24A-00 | 6D8-24563-00 | 80 |
| REC6D8-WS24A-00 | 6D8-WS24A-00 | 66-67-68-69-70-71-80-81 |
| REC6D9-12411-00 | 6D9-12411-00 | 70-137 |
| REC6D9-45551-00 | 6D9-45551-00 | 319 |
| REC6DA-11181-00 | 6DA-11181-00 | 216-218 |
| REC6DA-12411-01 | 6DA-12411-01 | 72-136-137 |
| REC6DA-13761-00 | 6DA-13761-00 | 90 |
| REC6E0-11193-A1 | 6E0-11193-A1 | 221 |
| REC6E0-11631-00-98K | 6E0-11631-00-98 | 221-262-266 |
| REC6E0-11651-01 | 6E0-11651-01 | 221-225-260 |
| REC6E0-24411-00 | 6E0-24411-00 | 87 |
| REC6E0-24434-00 | 6G1-24431-01 | 87 |
| REC6E0-24435-00 | 6E0-24435-00 | 87 |
| REC6E0-24471-00 | 6E0-24471-00 | 87 |
| REC6E0-26301-01 | 6E0-26301-01 | 130 |
| REC6E0-41112-A1 | 6E0-41112-A1 | 140-21 |
| REC6E0-41114-A1 | 6E0-41114-A1 | 140-221 |
| REC6E0-43118-01 | 6E0-43118-00 | 134 |
| REC6E0-43118-01 | 6E0-43118-01 | 134 |
| REC6E0-44322-02 | 6E0-44322-02 | 154-155-345 |
| REC6E0-44352-00 | 6E0-44352-00 | 143-154-155-287-345 |
| REC6E0-45113-A1 | 6E0-45113-A1 | 221-252 |
| REC6E0-45316-00 | 6E0-45316-09 | 345 |
| REC6E0-45317-00 | 6E0-45317-09 | 345 |
| REC6E0-45511-01 | 6E0-45511-01 | 345-387 |
| REC6E0-45511-11 | 6E0-45511-11 | 345-387 |
| REC6E0-45551-00 | 6E0-45551-00 | 345-387 |
| REC6E0-45560-00 | 6E0-45560-00 | 345-387 |
| REC6E0-45570-00 | 6E0-45570-00 | 345-387 |
| REC6E0-45611-01 | 6E0-45611-01 | 345 |
| REC6E0-45631-00 | 6E0-45631-00 | 345-387 |
| REC6E0-85540-71 | 6E0-85540-70 | 119 |
| REC6E0-85540-71 | 6E0-85540-71 | 119 |
| REC6E0-85570-00 | 6E0-85570-00 | 104 |
| REC6E0-W0001-C1 | 6E0-W0001-C1 | 144-285-345 |
| REC6E0-W0078-A2 | 6E0-W0078-00 | 150-153 |
| REC6E0-W0078-A2 | 6E0-W0078-01 | 150-153 |
| REC6E0-W0078-A2 | 6E0-W0078-02 | 150-153 |
| REC6E0-W0078-A2 | 6E0-W0078-A2 | 150-153-155-285-345 |
| REC6E3-14301-05 | 6E3-14301-05 | 92-93 |
| REC6E5-11181-A0 | 6E5-11181-A2 | 245-249-254 |
| REC6E5-11193-A0 | 6E5-11193-A0 | 245-255 |
| REC6E5-11381-A1 | 6E5-11381-A1 | 275 |
| REC6E5-11381-A1 | 6E5-11381-A2 | 245-247 |
| REC6E5-11411-00 | 6E5-11411-00 | 256 |
| REC6E5-11447-00 | 6E5-11447-00 | 245-247 |
| REC6E5-11610-02 | 6E5-11610-02 | 265-266-267 |
| REC6E5-11633-00 | 6E5-11633-01 | 261-265 |
| REC6E5-11634-00 | 6E5-11634-00 | 265 |
| REC6E5-11650-01 | 6E5-11650-01 | 261 |
| REC6E5-11651-00 | 6E5-11651-00 | 261 |
| REC6E5-12411-02 | 6E5-12411-00 | 136 |
| REC6E5-12411-02 | 6E5-12411-01 | 136-221-223-229-231-233 |
| REC6E5-12411-02 | 6E5-12411-02 | 136-137 |
| REC6E5-12411-30 | 6E5-12411-10 | 243 |
| REC6E5-12411-30 | 6E5-12411-10 | 137 |
| REC6E5-12411-30 | 6E5-12411-20 | 137 |
| REC6E5-12411-30 | 6E5-12411-30 | 137-227-237-245-247 |
| REC6E5-12411-30 | 6E5-12411-30 | 137 |
| REC6E5-13411-00 | 6E5-13411-00 | 83 |
| REC6E5-13621-A1 | 6E5-13621-A1 | 275 |
| REC6E5-13645-A1-00 | 6E5-13645-A1 | 275 |
| REC6E5-14198-A2 | 6E5-14198-A2 | 275 |
| REC6E5-14323-03 | 6E5-14323-03 | 99 |
| REC6E5-14328-01 | 6E5-14328-01 | 99 |
| REC6E5-14385-02 | 6E5-14385-02 | 93-100 |
| REC6E5-14386-01 | 6E5-14386-01 | 99 |
| REC6E5-14386-02 | 6E5-14386-02 | 99 |
| REC6E5-14416-A1 | 6E5-14416-A1 | 275 |
| REC6E5-14483-A1 | 6E5-14483-A1 | 275 |
| REC6E5-14546-00 | 6E5-14546-00 | 93-98 |
| REC6E5-24351-51 | 6E5-24351-00 | 75 |
| REC6E5-24351-51 | 6E5-24351-51 | 75 |
| REC6E5-24410-03 | 6E5-24410-01-00 | 85 |
| REC6E5-24411-00 | 6E5-24411-00-00 | 87 |
| REC6E5-24434-02 | 6E5-24434-02 | 88 |
| REC6E5-24435-00 | 6E5-24435-00 | 88 |
| REC6E5-24471-00 | 6E5-24471-00 | 87 |
| REC6E5-41112-A1 | 6E5-41112-A1 | 142-245 |
| REC6E5-41134-A0 | 6E5-41134-A0 | 269-270 |
| REC6E5-44150-02 | 6E5-44150-01 | 377 |
| REC6E5-44311-00 | 6E5-44311-00 | 155-156-157-381 |
| REC6E5-44312-00 | 6E5-44312-00 | 325-329-333-339-385-386 |
| REC6E5-44315-A0 | 6E5-44315-A0 | 156-157-325-329-333-377-381-385 |
| REC6E5-44322-00 | 6E5-44322-00 | 156-157-381 |
| REC6E5-44323-00-40 | 6E5-44323-00 | 149-155-156-157-377 |

| REF | R.O. / OEM | |
|--------------------|-----------------|---|
| REC6E5-44352-01 | 6E5-44352-01 | 143-155-156-157-325-329-333-339-377-381-385-386 |
| REC6E5-44365-00 | 6E5-44365-00 | 155-156-157-325-333-339-377-381-385-386 |
| REC6E5-44366-00 | 6E5-44366-00 | 155-156-157-325-333-339-377-381 |
| REC6E5-45113-A2 | 6E5-45113-A0 | 253-254 |
| REC6E5-45114-00 | 6E5-45114-A0 | 272 |
| REC6E5-45321-00 | 6E5-45321-00 | 325-329-377-381 |
| REC6E5-45331-00-94 | 6E5-45331-00-94 | 377-381 |
| REC6E5-45331-00-94 | 6E5-45331-00-9S | 325-329-391 |
| REC6E5-45332-00-94 | 6E5-45332-00-94 | 375 |
| REC6E5-45332-00-94 | 6E5-45332-00-CA | 323 |
| REC6E5-45344-00 | 6E5-45344-00 | 325-329-333-339-377-381-385 |
| REC6E5-45371-01 | 6E5-45371-01 | 161-169-375 |
| REC6E5-45501-01 | 6E5-45501-01 | 377-391 |
| REC6E5-45536-00 | 6E5-45536-00 | 325-377 |
| REC6E5-45536-01 | 6E5-45536-01 | 329 |
| REC6E5-45551-02 | 6E5-45551-02 | 375-391 |
| REC6E5-45560-00 | 6E5-45560-00 | 375-391 |
| REC6E5-45567-01 | 6E5-45567-01 | 323 |
| REC6E5-45567-01 | 6E5-45567-01-60 | 375 |
| REC6E5-45570-00 | 6E5-45571-01 | 375-391 |
| REC6E5-45576-00 | 6E5-45576-00 | 323-375 |
| REC6E5-45587-01 | 6E5-45587-01 | 325-329-377 |
| REC6E5-45611-00 | 6E5-45611-00 | 323 |
| REC6E5-45611-00 | 6E5-45611-01 | 375-391-392 |
| REC6E5-45631-00 | 6E5-45631-01 | 375-391-392 |
| REC6E5-45633-01 | 6E5-45633-01 | 323-327-335-375-379-391-392 |
| REC6E5-45634-01 | 6E5-45634-01 | 323-327-375 |
| REC6E5-45634-02 | 6E5-45634-02 | 327 |
| REC6E5-45641-03 | 6E5-45641-02 | 375 |
| REC6E5-45641-03 | 6E5-45641-03 | 327-379 |
| REC6E5-45987-00 | 63P-45987-00 | 323-327 |
| REC6E5-45987-00 | 6E5-45987-01 | 379 |
| REC6E5-45987-00 | 6E5-45987-01 | 375 |
| REC6E5-45987-01 | 6E5-45987-01 | 405 |
| REC6E5-81900-01 | 6E5-81900-01 | 84 |
| REC6E5-85510-11 | 6E5-85510-11 | 121 |
| REC6E5-85510-11 | 6E5-85510-11 | 121 |
| REC6E5-85540-12 | 6E5-85540-10 | 119 |
| REC6E5-85540-12 | 6E5-85540-12 | 119 |
| REC6E5-85570-11 | 6E5-85570-10 | 105 |
| REC6E5-85570-11 | 6E5-85570-11 | 105 |
| REC6E5-W0001-A2 | 6E5-W0001-A2 | 251 |
| REC6E5-W0001-A2 | 6E5-W0001-A2 | 245 |
| REC6E5-W0001-A2 | 6E5-W0001-A2 | 254 |
| REC6E5-W0001-F1 | 6E5-W0001-F1 | 147-374-378 |
| REC6E5-W0001-F1 | 6F3-W0001-21 | 147 |
| REC6E5-W0093-06 | 6E5-W0093-06 | 97-245 |
| REC6E5-W0093-07 | 6E5-W0093-07 | 97 |
| REC6E5-W0093-08 | 6E5-W0093-08 | 97 |
| REC6E7-11111-01-1S | 6E7-11111-01-1S | 227 |
| REC6E7-11181-00 | 6E7-11181-A2 | 248-254 |
| REC6E7-11631-00K | 6E7-11631-00 | 262 |
| REC6E7-11631-00K | 6E7-11631-00-97 | 227 |
| REC6E7-11631-00K | 6E7-11631-00-97 | 266 |
| REC6E7-11635-00K | 6E7-11635-00 | 227-262 |
| REC6E7-11636-00K | 6E7-11636-00 | 227-262 |
| REC6E7-14227-00 | 6E7-14227-00 | 94 |
| REC6E7-14385-00 | 6E7-14385-00 | 93-100 |
| REC6E7-44366-00 | 6E7-44366-00 | 349 |
| REC6E7-45331-00-CA | 6E7-45331-00-9M | 349 |
| REC6E7-45501-00 | 6E7-45501-00 | 349 |
| REC6E7-45501-11 | 6E7-45501-10 | 349-387-388 |
| REC6E7-45536-00 | 6E7-45536-00 | 349 |
| REC6E7-45551-00 | 6E7-45551-00 | 348-387-388 |
| REC6E7-45560-01 | 6E7-45560-00 | 349 |
| REC6E7-45560-01 | 6E7-45560-01 | 291-293-351-387-388 |
| REC6E7-45570-00 | 6E7-45570-00 | 293 |
| REC6E7-45570-00 | 6E7-45571-00 | 291-349-351-387-388 |
| REC6E7-45987-00 | 6E7-45987-00 | 291-349 |
| REC6E7-45987-00 | 6E7-45987-01 | 293-351-405 |
| REC6E7-85570-19 | 6E7-85570-19-00 | 106 |
| REC6E7-W0001-A1 | 6E7-W0001-00 | 249 |
| REC6E7-W0001-A1 | 6E7-W0001-A1 | 249-254 |
| REC6E7-W0093-01 | 6E7-W0093-04 | 95 |
| REC6E8-14390-12 | 6E8-14390-12 | 98 |
| REC6E9-11193-A0 | 6E9-11193-A0 | 255 |
| REC6E9-12413-00-1S | 6E9-12413-00-1S | 139-235 |
| REC6E9-12414-A1 | 6E9-12414-A1 | 138-139-235 |
| REC6E9-14198-A0 | 6E9-14198-A0 | 275 |
| REC6E9-41114-A0 | 6E9-41114-A0 | 142 |
| REC6E9-82575-02 | 6E9-82575-00 | 120 |
| REC6E9-W0093-02 | 6E9-W0093-02 | 96 |
| REC6E9-W0093-03 | 6E9-W0093-03 | 96 |
| REC6EE-W0078-01 | 6E8-W0078-00 | 150 |
| REC6EE-W0078-01 | 6EE-W0078-00 | 150 |
| REC6EE-W0078-01 | 6EE-W0078-01 | 150 |
| REC6EK-13761-00 | 6EK-13761-00 | 90 |
| REC6F3-W0001-04-00 | 6F3-W0001-A4 | 251 |
| REC6F5-11181-A2 | 6F5-11181-A1 | 235 |

| REF | R.O. / OEM | |
|--------------------|-----------------|---------------------|
| REC6F5-11181-A2 | 6F5-11181-A2 | 248-254 |
| REC6F5-11515-00 | 6F5-11515-00 | 233-235 |
| REC6F5-11610-00 | 6F5-11610-00 | 263 |
| REC6F5-11610-00 | 6F6-11610-00 | 235 |
| REC6F5-11610-10 | 6F5-11610-10 | 263 |
| REC6F5-11610-10 | 6F6-11610-10 | 235 |
| REC6F5-11610-20 | 6F5-11610-20 | 263 |
| REC6F5-11610-20 | 6F6-11610-20 | 235 |
| REC6F5-11633-00 | 6F5-11633-00 | 233-235-260-261-263 |
| REC6F5-11651-00 | 6F5-11651-00 | 233-235-260-261 |
| REC6F5-11681-00 | 6F5-11681-00 | 235-261 |
| REC6F5-12411-03 | 6F5-12411-03 | 137 |
| REC6F5-12411-03 | 6F5-12411-01 | 137 |
| REC6F5-12411-03 | 6F5-12411-02 | 137-235-239 |
| REC6F5-12411-03 | 6F5-12411-03 | 137 |
| REC6F5-12411-03 | 6F5-12411-03 | 137 |
| REC6F5-13621-A1 | 6F5-13621-A1 | 275 |
| REC6F5-13645-A0 | 6F5-13645-A1 | 274 |
| REC6F5-13646-A2 | 6F5-13646-A1 | 274 |
| REC6F5-14198-A1 | 6F5-14198-A1 | 275 |
| REC6F5-14323-00 | 6F5-14323-01 | 98 |
| REC6F5-14384-00 | 6F5-14384-00 | 94 |
| REC6F5-14390-21 | 6F5-14390-21 | 98 |
| REC6F5-14398-00 | 6F5-14398-00 | 94 |
| REC6F5-14483-00 | 6F5-14483-00 | 94 |
| REC6F5-15396-01-5B | 6F5-15396-01-5B | 235 |
| REC6F5-24563-00 | 6F5-24563-00 | 80-81-82 |
| REC6F5-26311-00 | 6F5-26311-00 | 130 |
| REC6F5-41111-01-1S | 6F5-41111-01-1S | 235 |
| REC6F5-41112-A0 | 6F5-41112-A0 | 141-235 |
| REC6F5-41113-A0-1S | 6F5-41113-A0-1S | 235 |
| REC6F5-41114-A0 | 6F5-41114-A0 | 142-235 |
| REC6F5-44352-00 | 6F5-44352-00 | 143-363 |
| REC6F5-44352-00 | 6F5-44352-02 | 156-367 |
| REC6F5-45113-A0 | 6F5-45113-A0 | 235-253-254 |
| REC6F5-45312-00-4D | 6F5-45312-01-4D | 363 |
| REC6F5-45551-00 | 6F5-45551-00 | 363-389-390 |
| REC6F5-45560-00 | 6F5-45560-00 | 363-389-390 |
| REC6F5-45570-00 | 6F5-45570-00 | 363-389-390 |
| REC6F5-85540-22 | 6F5-85540-22 | 119 |
| REC6F5-85570-01 | F5-85570-01 | 105 |
| REC6F5-W0001-C0 | 6F5-W0001-C0 | 145-363 |
| REC6F5-W0078-A0 | 6F5-W0078-A0 | 151 |
| REC6F5-W0078-A0 | 6F5-W0078-A0 | 156-363 |
| REC6F6-11111-00-1S | 6F6-11111-00-1S | 235 |
| REC6F6-11191-00-1S | 6F6-11191-00-1S | 235 |
| REC6F6-11193-A1 | 6F6-11193-A1 | 235-255 |
| REC6F6-11400-02 | 6F6-11400-01 | 235 |
| REC6F6-11631-00K | 6F6-11631-00-95 | 235-263 |
| REC6F6-11635-00K | 6F6-11635-00 | 235-263 |
| REC6F6-11636-00K | 6F6-11636-00 | 235-263 |
| REC6F6-13610-00 | 6F6-13610-00 | 99 |
| REC6F6-14301-06 | 6F6-14301-06 | 91 |
| REC6F6-14341-01 | 6F6-14341-01 | 98 |
| REC6F6-14385-00 | 6F6-14385-00 | 100 |
| REC6F6-45611-00 | 6F6-45611 | |

| REF | R.O. / OEM | |
|--------------------|-----------------|-----------------|
| REC6G1-45631-00 | 6G1-45631-00 | 346-387 |
| REC6G1-81970-62 | 664-81970-60 | 116 |
| REC6G1-81970-62 | 664-81970-61 | 116 |
| REC6G1-81970-62 | 664-81970-62 | 116 |
| REC6G1-81970-62 | 664-81970-63 | 116 |
| REC6G1-81970-62 | 676-81970-00 | 116 |
| REC6G1-81970-62 | 6E9-81970-70 | 116 |
| REC6G1-81970-62 | 6G1-81970-00 | 116 |
| REC6G1-81970-62 | 6G1-81970-60 | 116 |
| REC6G1-81970-62 | 6G1-81970-61 | 116 |
| REC6G1-81970-62 | 6G1-81970-62 | 116 |
| REC6G1-81970-62 | 6G1-81970-A0 | 116 |
| REC6G1-W0001-C1 | 6G1-W0001-C0 | 144 |
| REC6G1-W0001-C1 | 6N0-W0001-20 | 346 |
| REC6G1-W0078-A1 | 6G1-W0078-00 | 150 |
| REC6G1-W0078-A1 | 6G1-W0078-01 | 150 |
| REC6G1-W0078-A1 | 6G1-W0078-A0 | 150-346 |
| REC6G1-W0078-A1 | 6N0-W0078-A0 | 150 |
| REC6G1-W0078-A1 | 6G1-W0078-A1 | 155 |
| REC6G1-W0093-00 | 6G1-W0093-00 | 93-95-223 |
| REC6G5-11181-A2 | 6G5-11181-A3 | 247-249-254 |
| REC6G5-11193-A0 | 6F5-11193-A0 | 247 |
| REC6G5-11193-A0 | 6G5-11193-A1 | 255 |
| REC6G5-11382-A1 | 6G5-11382-A1 | 142-245-247 |
| REC6G5-11411-02 | 6G5-11411-02 | 247-256 |
| REC6G5-11631-00K | 6G5-11631-00-93 | 265-266-267 |
| REC6G5-11642-00K | 6G5-11642-00-93 | 265-266-267 |
| REC6G5-13645-A1 | 6G5-13645-A2 | 276 |
| REC6G5-14416-A1 | 6G5-14416-A1 | 275 |
| REC6G5-14483-01 | 6G5-14483-A1 | 276 |
| REC6G5-41112-A1 | 6G5-41112-A1 | 142-247 |
| REC6G5-41114-A0 | 6G5-41114-A0 | 142-247 |
| REC6G5-41134-A1 | 6G5-41134-A1 | 270 |
| REC6G5-41217-00 | 6G5-41217-01 | 101 |
| REC6G5-43864-00 | 6G5-43864-00 | 125 |
| REC6G5-44150-02 | 6G5-44150-02 | 381 |
| REC6G5-44323-00 | 6G5-44323-00 | 329-333-381-385 |
| REC6G5-44323-00 | 6G5-44323-01 | 149 |
| REC6G5-44323-00 | 6G5-44323-00 | 155-157 |
| REC6G5-45113-A1 | 6G5-45113-A1 | 245-247 |
| REC6G5-45113-A1 | 6G5-45113-A2 | 253-254 |
| REC6G5-45114-A0 | 6G5-45114-A1 | 272 |
| REC6G5-45383-01 | 6G5-45383-01 | 327-379 |
| REC6G5-45384-00 | 6G5-45384-00 | 327-379 |
| REC6G5-45501-21 | 6G5-45501-21 | 381-391-392 |
| REC6G5-45536-01 | 6G5-45536-01 | 381 |
| REC6G5-45551-00 | 6G5-45551-01 | 379-391-392 |
| REC6G5-45560-00 | 6G5-45560-01 | 379-391-392 |
| REC6G5-45571-00 | 6G5-45571-02 | 379-391-392 |
| REC6G5-45576-10 | 6G5-45576-10 | 327 |
| REC6G5-45631-00 | 6G5-45631-00 | 379-391-392 |
| REC6G5-81960-A0 | 6G5-81960-A0 | 116 |
| REC6G5-85510-11 | 6G5-85510-10 | 121 |
| REC6G5-85540-12 | 6G5-85540-10 | 119 |
| REC6G5-85540-12 | 6G5-85540-11 | 119 |
| REC6G5-85540-12 | 6G5-85540-12 | 119 |
| REC6G5-W0001-A3 | 6G5-W0001-03 | 252 |
| REC6G5-W0001-A3 | 6G5-W0001-A3-00 | 247 |
| REC6G5-W0001-A3 | 6G5-W0001-03 | 254 |
| REC6G5-W0078-A1 | 6G5-W0078-00 | 152 |
| REC6G5-W0078-A1 | 6G5-W0078-01 | 152 |
| REC6G5-W0078-A1 | 6G5-W0078-A1 | 152-157-378 |
| REC6G8-11181-A1 | 6G8-11181-00 | 181 |
| REC6G8-11181-A1 | 6G8-11181-A1 | 215-218 |
| REC6G8-11351-A0 | 6G8-11351-00 | 181 |
| REC6G8-11351-A0 | 6G8-11351-A0 | 217-218 |
| REC6G8-12414-A0 | 60R-E2414-A0 | 180 |
| REC6G8-12414-A0 | 6G8-12414-00 | 181 |
| REC6G8-12414-A0 | 6G8-12414-A0 | 138 |
| REC6G8-13440-00 | 6G8-13440-00 | 83 |
| REC6G8-13645-00 | 6G8-13645-00 | 273 |
| REC6G8-13646-A0 | 6G8-13646-00 | 273 |
| REC6G8-14198-A0 | 6G8-14198-00 | 273 |
| REC6G8-15374-00 | 6G8-15374-00 | 273 |
| REC6G8-41112-02 | 6G8-41112-02 | 140-181 |
| REC6G8-41114-00 | 6G8-41114-00 | 140 |
| REC6G8-45113-A1 | 6G8-45113-A1 | 271 |
| REC6G8-46241-00 | 6G8-46241-00 | 267 |
| REC6G8-81870-00 | 6G8-81870-00 | 120 |
| REC6G8-81960-A1 | 6G8-81960-A1 | 117 |
| REC6G8-W0001-A3 | 6G8-W0001-A3 | 181-216-218 |
| REC6G9-85540-29 | 6G9-85540-20 | 117-118 |
| REC6G9-85540-29 | 6G9-85540-21 | 117-118 |
| REC6G9-85540-29 | 6G9-85540-22 | 117-118 |
| REC6G9-85540-29 | 6G9-85540-29 | 117-118 |
| REC6G9-W0001-C4 | 6G9-W0001-C4 | 144 |
| REC6G9-W0001-C6 | 6G9-W0001-C6 | 144 |
| REC6H0-81960-00 | 6H0-81960-00 | 116 |
| REC6H0-W0093-00 | 6H0-W0093-00 | 97 |
| REC6H1-11631-03K | 6H1-11631-03-95 | 264-266 |
| REC6H1-15359-01-94 | 6H1-15359-01-94 | 243 |
| REC6H1-43800-17-8D | 6H1-43800-13-4D | 124 |
| REC6H1-43800-17-8D | 6H1-43800-14-4D | 124 |
| REC6H1-43800-17-8D | 6H1-43800-15-4D | 124 |
| REC6H1-43800-17-8D | 6H1-43800-16-4D | 124 |
| REC6H1-43800-17-8D | 6H1-43800-17-8D | 124 |
| REC6H1-44144-00 | 6H1-44144-00 | 373 |
| REC6H1-45214-00 | 6H1-45214-00 | 315-319 |
| REC6H1-45215-00 | 6H1-45215-00 | 315-319 |
| REC6H1-45611-00 | 6H1-45611-01-00 | 373-390-391 |
| REC6H1-45631-01 | 6H1-45631-01-00 | 373-390-391 |
| REC6H1-45634-02 | 6H1-45634-02 | 373 |

| REF | R.O. / OEM | |
|--------------------|-----------------|---------------------------------|
| REC6H1-45668-00 | 6H1-45668-00 | 315-319-331-335-337-341-373-383 |
| REC6H1-81950-01 | 6H1-81950-00 | 115 |
| REC6H1-81950-01 | 6H1-81950-01 | 115 |
| REC6H1-85510-00 | 6H1-85510-00 | 121 |
| REC6H1-W0001-00-00 | 6H1-W0001-A1 | 251 |
| REC6H1-W0093-01-00 | 6H1-W0093-01 | 97 |
| REC6H1-W0093-01-00 | 6H1-W0093-01-00 | 243 |
| REC6H1-W0093-10 | 6H1-W0093-10 | 97 |
| REC6H2-81960-10 | 6H2-81960-10 | 116 |
| REC6H2-85540-13 | 6H2-85540-10 | 118 |
| REC6H2-85540-13 | 6H2-85540-11 | 118 |
| REC6H2-85540-13 | 6H2-85540-12 | 118 |
| REC6H2-85540-13 | 6H2-85540-13 | 118 |
| REC6H2-W0001-20 | 6H2-W0001-20 | 146 |
| REC6H2-W0093-10 | 6H2-W0093-10 | 96-241 |
| REC6H3-11181-A0 | 6H3-11181-A2 | 241-248-254 |
| REC6H3-11193-A1 | 6H3-11193-A1 | 241-255 |
| REC6H3-11631-01K | 6H3-11631-01-96 | 241-262-266 |
| REC6H3-11633-00 | 6H3-11633-00 | 241-261-262-264 |
| REC6H3-11635-01K | 6H3-11635-01 | 241-262 |
| REC6H3-11636-01K | 6H3-11636-01 | 241-262 |
| REC6H3-12411-10 | 6H3-12411-00 | 137 |
| REC6H3-12411-10 | 6H3-12411-01 | 137 |
| REC6H3-12411-10 | 6H3-12411-10 | 137-241 |
| REC6H3-12411-10 | 6H3-12411-11 | 137 |
| REC6H3-12414-A1 | 62Y-12414-00 | 203-205-207 |
| REC6H3-12414-A1 | 6H3-12414-A1 | 138-241 |
| REC6H3-13621-A1 | 6H3-13621-A1 | 274 |
| REC6H3-13622-A1 | 6H3-13622-A1 | 274 |
| REC6H3-14198-A1 | 6H3-14198-A1 | 274 |
| REC6H3-14457-01 | 6H3-14457-01 | 94 |
| REC6H3-14590-00 | 6H3-14590-01 | 93-98 |
| REC6H3-41112-A0 | 6H3-41112-A0 | 141-241 |
| REC6H3-41114-A0 | 6H3-41114-A0 | 141-241 |
| REC6H3-41217-00 | 6H3-41217-00 | 101 |
| REC6H3-44311-00 | 6H3-44311-00 | 148 |
| REC6H3-44315-00 | 6H3-44315-00 | 154-156 |
| REC6H3-44323-00 | 6H3-44323-00-00 | 149-154-156 |
| REC6H3-44352-00 | 697-44352-00 | 369 |
| REC6H3-44352-00 | 6H3-44352-00 | 143-154-156-313-317 |
| REC6H3-45113-00 | 6H3-45113-00 | 241 |
| REC6H3-45113-00 | 6H3-45113-A0 | 253-254 |
| REC6H3-45114-A1 | 6H3-45114-A1 | 271 |
| REC6H3-45123-00 | 6H3-45123-00 | 269 |
| REC6H3-45127-00 | 6H3-45127-00 | 269 |
| REC6H3-82510-03 | 6H3-82510-03 | 114 |
| REC6H3-82510-03 | 6H3-82510-01 | 114 |
| REC6H3-82510-03 | 6H3-82510-02 | 114 |
| REC6H3-82510-03 | 6H3-82510-03 | 114 |
| REC6H3-85520-00 | 6H3-85520-00 | 107 |
| REC6H3-85540-11 | 6H3-85540-10 | 118 |
| REC6H3-85540-11 | 6H3-85540-11 | 118 |
| REC6H3-85540-11 | 6H3-85540-12 | 118 |
| REC6H3-85540-13 | 6H3-85540-11 | 118 |
| REC6H3-85540-13 | 6H3-85540-12 | 118 |
| REC6H3-85540-13 | 6H3-85540-13 | 118 |
| REC6H3-85570-10 | 6H3-85570-10 | 104 |
| REC6H3-W0001-02 | 6H3-W0001-02 | 241-250-254 |
| REC6H3-W0001-22 | 6H3-W0001-22 | 145 |
| REC6H3-W0078-02 | 6H3-W0078-00 | 68-69-152-154-156 |
| REC6H3-W0093-02 | 6H3-W0093-02 | 93-97 |
| REC6H4-11181-00 | 6H4-11181-A2 | 248-254 |
| REC6H4-11193-A1 | 6H4-11193-00 | 255 |
| REC6H4-11610-00-00 | 6H4-11610-00 | 264-266 |
| REC6H4-11631-00K | 6H4-11631-00-96 | 264-266 |
| REC6H4-11631-01K | 6H4-11631-01-95 | 237-263-266 |
| REC6H4-11634-01 | 6H4-11634-01 | 237-263-264 |
| REC6H4-11635-00K | 6H4-11635-00 | 264 |
| REC6H4-11635-01K | 6H4-11635-01 | 237-263 |
| REC6H4-11636-00K | 6H4-11636-00 | 264 |
| REC6H4-11636-01K | 6H4-11636-01 | 237-263 |
| REC6H4-11641-00 | 6H4-11641-00 | 237-261 |
| REC6H4-14198-01 | 6H4-14198-01 | 274 |
| REC6H4-14198-09 | 6H4-14198-00 | 274 |
| REC6H4-14984-00 | 6H4-14984-00 | 94 |
| REC6H4-14985-01 | 650-14385-00 | 100 |
| REC6H4-14985-01 | 6H4-14985-00 | 100 |
| REC6H4-14985-01 | 6H4-14985-01 | 100 |
| REC6H4-14985-01 | 6M6-14385-00 | 100 |
| REC6H4-15369-A1 | 6H4-15369-A1 | 237 |
| REC6H4-41112-A0 | 6H4-41112-A0 | 141-237 |
| REC6H4-41114-A0 | 6H4-41114-A0 | 141-237 |
| REC6H4-41134-A0 | 6H4-41134-A0 | 269 |
| REC6H4-44352-02 | 6H4-44352-00 | 309 |
| REC6H4-44352-02 | 6H4-44352-02 | 143-297-301-305-355-357-359-361 |
| REC6H4-44352-02 | 6H4-44352-02 | 154-155-156 |
| REC6H4-45113-00 | 6H4-45113-00 | 237 |
| REC6H4-45113-00 | 6H4-45113-A0 | 253-254 |
| REC6H4-45551-00 | 6H4-45551-00 | 359-389-390 |
| REC6H4-45560-00 | 6H4-45560-00 | 359-389-390 |
| REC6H4-45570-00 | 6H4-45571-00 | 359-389-390 |
| REC6H4-45631-00 | 6H4-45631-00 | 389-390 |
| REC6H4-W0001-04 | 6H4-W0001-04 | 237-250 |
| REC6H4-W0001-21 | 6H4-W0001-21 | 359 |
| REC6H4-W0001-A1 | 6H4-W0001-01 | 250-254 |
| REC6H4-W0078-00 | 6H4-W0078-00 | 151 |
| REC6H4-W0078-00 | 6H4-W0078-A0 | 359 |

| REF | R.O. / OEM | |
|--------------------|--|-----------------|
| REC6H4-W0078-00 | 6H4-W0078-A0 | 155-156 |
| REC6H4-W0093-01 | 6H4-W0093-01 | 96 |
| REC6H4-W0093-03 | 6H4-W0093-03 | 96-237 |
| REC6H9-45551-00 | 6H9-45551-00 | 365-389 |
| REC6J1-11610-00 | 6J1-11610-00 | 221 |
| REC6J8-11181-A2 | 6J8-11181-A1 | 231 |
| REC6J8-11181-A2 | 6J8-11181-A2 | 248 |
| REC6J8-11181-A2 | 6J8-11181-A2 | 254 |
| REC6J8-11631-02 | 6J8-11631-02-97 | 231-263-266 |
| REC6J8-13411-00 | 6J8-13411-00 | 83 |
| REC6J8-24471-00 | 6J8-24471-00 | 87 |
| REC6J8-45113-00 | 6J8-45113-A0 | 231-253-254 |
| REC6J8-85540-H2 | 6J8-85540-H2 | 120 |
| REC6J8-W0001-21 | 6J8-W0001-21 | 145-357 |
| REC6J8-W0078-A1 | 6J8-W0078-A1 | 150-151 |
| REC6J8-W0078-A2 | 6J8-W0078-A2 | 155-357 |
| REC6J9-45332-00-CA | 6J9-45332-00-CA | 327-379-391-392 |
| REC6J9-45611-00 | 6J9-45611-01 | 327-379-391-392 |
| REC6K1-82510-07 | 6K1-82510-06 | 113 |
| REC6K1-82570-13 | 6K1-82570-13 | 128 |
| REC6K4-11422-00 | 6K4-11422-00 | 256 |
| REC6K4-11432-00 | 6K4-11432-00 | 256 |
| REC6K4-11651-00 | 6K4-11651-00 | 260 |
| REC6K5-11601-02 | 6K5-11601-02 | 241-262-264-266 |
| REC6K5-11601-12 | 6K5-11601-12 | 241-262-264 |
| REC6K5-11601-22 | 6K5-11601-22 | 241-262-264 |
| REC6K5-11631-03K | 6K5-11631-03-95 | 264-266 |
| REC6K5-11635-03K | 6K5-11635-03 | 264 |
| REC6K5-11636-03K | 6K5-11636-03 | 264 |
| REC6K5-11681-00 | 6K5-11681-00 | 261 |
| REC6K5-14301-03 | 6K5-14301-03 + 6K5-14302-03 + 6K5-14303-03 | 92-93 |
| REC6K5-45551-00 | 6K5-45551-00 | 388-390 |
| REC6K5-45560-00 | 6K5-45560-00 | 388-390 |
| REC6K5-45570-00 | 6K5-45570-00 | 390 |
| REC6K5-W0001-02 | 6K5-W0001-02 | 251 |
| REC6K5-W0078-01 | 6K5-W0078-01 | 152-156 |
| REC6K7-11633-00 | 6K7-11633-00 | 261-265 |
| REC6K7-13645-A2 | 6K7-13645-A2 | 276 |
| REC6K7-13646-A2 | 6K7-13646-A2 | 276 |
| REC6K7-W0093-09 | 6K7-W0093-09 | 97 |
| REC6K8-41122-A1 | 6K8-41122-A1 | 141-229 |
| REC6K8-41124-A1 | 6K8-41124-A1 | 141-229 |

| REF | R.O. / OEM | |
|--------------------|--------------------|-----------------|
| REC6P2-81960-03 | 6P2-81960-03 | 116 |
| REC6P2-W0001-01 | 6P2-W0001-00 | 217 |
| REC6P2-W0001-01 | 6P2-W0001-01 | 213-217-218 |
| REC6P2-W0078-00 | 61P2-W0078-00 | 336 |
| REC6P2-W0078-00 | 6P2-W0078-00 | 73-153-155-157 |
| REC6P2-WS245-00 | 6P2-24563-00 | 81 |
| REC6P2-WS245-00 | 6P2-WS245-00 | 81 |
| REC6P3-24564-00 | 6P3-24564-00 | 71-72-73-81 |
| REC6P3-WS24A-00 | 6P3-24563-00 | 81 |
| REC6P3-WS24A-00 | 6P3-WS24A-00 | 81 |
| REC6P3-WS24A-00 | 6P3-WS24A-01 | 81 |
| REC6P3-WS24A-00 | 6P3-WS24A-01 | 71-72-73-81 |
| REC6R3-11411-00 | 6R3-11411-00 | 256 |
| REC6R3-24560-00 | 6R3-24560-00 | 80-81 |
| REC6R3-81960-10 | 6R3-81960-10 | 116 |
| REC6R3-82563-01 | 6R3-82563-00 | 122 |
| REC6R3-82563-01 | 6R3-82563-01 | 122 |
| REC6R3-85570-01 | 6R3-85570-01104 | 104 |
| REC6R3-W0001-03 | 6R3-W0001-A3 | 252 |
| REC6R4-13200-02 | 6R4-13200-00 | 84 |
| REC6R4-13200-02 | 6R4-13200-01 | 84 |
| REC6R4-13200-02 | 6R4-13200-02 | 84 |
| REC6R5-11603-00 | 6R5-11603-00 | 265-266-267 |
| REC6R5-11631-01K | 6R5-11631-11-93 | 265-266-267 |
| REC6R5-11631-11K | 6R5-11631-11-93 | 245 |
| REC6R5-11631-11K | 6R5-11631-11-93 | 265 |
| REC6R5-11631-11K | 6R5-11631-11-93 | 266-267 |
| REC6R5-11633-00 | 6R5-11633-10 | 245-247-261-265 |
| REC6R5-11634-00 | 6R5-11634-00 | 265 |
| REC6R5-11634-00 | 6R5-11634-10 | 245-247-265 |
| REC6R5-11642-01K | 6R5-11642-11-93 | 245-265-266-267 |
| REC6R5-11642-11K | 6R5-11642-11-93 | 265-266-267 |
| REC6R5-11650-10 | 6F5-11650-11 | 247 |
| REC6R5-11650-10 | 6R5-116950-0 | 245 |
| REC6R6-W0001-02-00 | 6R6-W0001-02 | 250-254 |
| REC6R7-11181-A0 | 6R7-11181-A1 | 248-254 |
| REC6S1-41136-00 | 6S1-41136-00 | 270 |
| REC6S1-85885-00 | 6S1-85885-00 | 90-102 |
| REC6X2-85885-10 | 61A-85885-00 | 103 |
| REC6X2-85885-10 | 6X2-85885-10 | 103 |
| REC703-48205-16 | 703-48205-10 | 126 |
| REC703-48205-16 | 703-48205-11 | 126 |
| REC703-48205-16 | 703-48205-12 | 126 |
| REC703-48205-16 | 703-48205-13 | 126 |
| REC703-48205-16 | 703-48205-14 | 126 |
| REC703-48205-16 | 703-48205-15 | 126 |
| REC703-48205-16 | 703-48205-16 | 126 |
| REC703-48205-16 | 703-48205-17 | 126 |
| REC703-48205-16 | 703-48205-18 | 126 |
| REC703-48205-16 | 703-48205-1A | 126 |
| REC703-48205-16 | 703-48205-1B | 126 |
| REC703-48205-16 | 703-48205-20 | 126 |
| REC703-48205-16 | 703-48205-21 | 126 |
| REC703-48230-14 | 703-48230-10 | 126 |
| REC703-48230-14 | 703-48230-11 | 126 |
| REC703-48230-14 | 703-48230-12 | 126 |
| REC703-48230-14 | 703-48230-13 | 126 |
| REC703-48230-14 | 703-48230-14 | 126 |
| REC703-48230-14 | 703-48230-15 | 126 |
| REC703-48230-14 | 703-48230-16 | 126 |
| REC703-48230-14 | 703-48230-17 | 126 |
| REC703-48230-14 | 703-48230-18 | 126 |
| REC703-48230-14 | 703-48230-1A | 126 |
| REC703-48230-14 | 703-48230-20 | 126 |
| REC703-48230-14 | 703-48230-21 | 126 |
| REC703-82510-44 | 703-82510-43 | 114 |
| REC703-82563-21 | 703-82563-20/21 | 128 |
| REC704-48205-R0 | 704-48205-11 | 127 |
| REC704-48205-R0 | 704-48205-12 | 127 |
| REC704-48205-R0 | 704-48205-13 | 127 |
| REC704-48205-R0 | 704-48205-14 | 127 |
| REC704-48205-R0 | 704-48205-15 | 127 |
| REC704-48205-R0 | 704-48205-B0 | 127 |
| REC704-48205-R0 | 704-48205-B1 | 127 |
| REC704-48205-R0 | 704-48205-P0 | 127 |
| REC704-48205-R0 | 704-48205-P1 | 127 |
| REC704-48207-R0 | 704-48207-20 | 127 |
| REC704-48207-R0 | 704-48207-21 | 127 |
| REC704-48207-R0 | 704-48207-22 | 127 |
| REC704-48207-R0 | 704-48207-30 | 127 |
| REC704-48207-R0 | 704-48207-31 | 127 |
| REC704-48207-R0 | 704-48207-39 | 127 |
| REC704-48207-R0 | 704-48207-P1 | 127 |
| REC704-48207-R0 | 704-48207-R0 | 127 |
| REC704-82563-J2 | 704-82563-J0/J1/J2 | 128 |
| REC704-82570-12 | 6E5-82570-05 | 128 |
| REC704-82570-12 | 704-82570-08 | 128 |
| REC704-82570-12 | 704-82570-10 | 128 |
| REC704-82570-12 | 704-82570-11 | 128 |
| REC704-82570-12 | 704-82570-12 | 128 |
| REC70720 | | 79 |
| REC84419M | 696-W0093-01 | 96 |
| REC84419M | 696-W0093-02 | 96 |
| REC8542561 | 65W-W0093-02 | 95-190-197 |
| REC855686 | | 77 |
| REC866169T01 | 6C5-13907-00 | 86 |
| REC881346T | 68V-81960-00 | 117 |
| REC881346T | 6D3-81960-00 | 117 |
| REC89-825096T01 | 66G1-81941-10 | 114 |
| REC89-825096T01 | 6E5-81950-01 | 114 |
| REC89-825096T01 | 6G1-81940-00 | 114 |
| REC89-825096T01 | 6G1-81941-10 | 110 |

| REF | R.O. / OEM | |
|-------------------|----------------|---|
| REC90101-06M56 | 90101-06M56 | 353 |
| REC90101-06M56 | 97095-06030 | 209 |
| REC90105-06M01 | 90105-06M01 | 363 |
| REC90109-08022 | 90109-08022 | 239-243-247 |
| REC90109-08M71 | 90109-08M71 | 245 |
| REC90119-06M10 | 90119-06M10 | 325-329-333-377-385 |
| REC90119-08M13 | 90119-08M13 | 321-357-371-317-325-329-333-335-339-341-377-381-385-386 |
| REC90119-08M14 | 90119-08M14 | 301-305-309-13-361 |
| REC90119-08M15 | 90119-08M15 | 231 |
| REC90119-08M21 | 90119-08M21 | 317 |
| REC90119-08M33 | 90119-08M33 | 321 |
| REC90119-08M87 | 90119-08M87 | 365 |
| REC90149-06M00 | 90149-06M00 | 315-319 |
| REC90151-05M00 | 90152-05000 | 365 |
| REC90170-12138 | 90170-12138 | 299-303-307-311-359-361-369 |
| REC90170-12138 | 90170-12138 | 315-319-323-327-371-375-379 |
| REC90170-16M01 | 90170-16M01 | 373 |
| REC90170-16M01 | 90170-16M01-00 | 373 |
| REC90170-16M19 | 90170-16M19 | 331-335-337-383 |
| REC90171-10M01 | 90171-10M01 | 289-291-293-405-351 |
| REC90171-14013-00 | 90171-14013 | 295-353-355-357-405 |
| REC90171-16011 | 90171-16011 | 299-303-307-311-315-319-359-361-365-369-371 |
| REC90171-16011 | 90171-16011 | 405 |
| REC90171-16011 | 90171-16011-00 | 373 |
| REC90171-18M04 | 90171-18M04 | 323-327-331-335-337-341-375-379-383-405 |
| REC90179-08M06 | 90179-08M06 | 291-293-348-351 |
| REC90179-09M02 | 90179-09M02 | 353 |
| REC90179-10M14 | 90179-10M14 | 295-355-357-315-319-331-335-337-341-373-383 |
| REC90183-02M03 | 90183-02M03 | 331-335-337-341-383 |
| REC90201-02M00 | 90201-02M00 | 341-383 |
| REC90201-10M01 | 90201-10M01 | 289-405 |
| REC90201-12565 | 90201-12565 | 225-260 |
| REC90201-14377 | 9020-14377 | 227-260 |
| REC90201-16M00 | 90201-16M00 | 331-335-337-383 |
| REC90201-17682 | 90201-17682 | 291-293-349-351 |
| REC90201-17M00 | 90201-17M00-00 | 373 |
| REC90201-20417 | 90201-20417 | 233-235-239-241-243-260-261-353-355-357 |
| REC90201-20M27 | 90201-20M27 | 229-260 |
| REC90201-21M75 | 90201-21M75 | 245-247-261-299-303-307-359-361-365-369 |
| REC90201-22429 | 90201-22429 | 325-329-333-377-381-385 |
| REC90201-22M01 | 90201-22M01 | 245-247-261-323-327-375-379 |
| REC90201-23M01 | 90201-23M01 | 379 |
| REC90201-30M92 | 90201-30M92 | 331-383 |
| REC90201-31M00 | 90201-31M00 | 339 |
| REC90201-42014 | 90201-42014 | 227 |
| REC90201-46M29 | 90201-46M29 | 325-329-333-377-381-385 |
| REC90206-22M19 | 90206-22M19 | 221-223-225-260 |
| REC90209-18112 | 90209-18112 | 227-260 |
| REC90209-20159 | 90209-20M23 | 229-260-261 |
| REC90209-24M03 | 90209-24M03 | 233-235-260-261 |
| REC90209-27M07 | 90209-27M07 | 261 |
| REC90209-27M11 | 90209-27M11 | 365-369 |
| REC90214-48M03 | 90214-48M03 | 343 |
| REC90250-03M10 | 90250-03M10 | 291-293-295-349-351-353-355-357 |
| REC90250-05010 | 90250-05010 | 347 |
| REC90250-05036 | 90250-05036 | 345 |
| REC90250-05046 | 90250-05046 | 299-303-307-311-359-361-363-365-369 |
| REC90250-06023 | 90250-06023 | 315-319-371 |
| REC90250-07M02 | 90250-07M02 | 373 |
| REC90250-07M02 | 90250-07M02-00 | 323-327-335-375-379 |
| REC90250-08M07 | 90250-08M07 | 154-155-156-309-313-346-347-349-357-359 |
| REC90280-03024 | 90280-03024 | 154-156-301-305-317-355-361-369 |
| REC90280-03M03 | 90280-03M03 | 335 |
| REC90280-04002 | 90280-04002 | 335 |
| REC90280-04M00 | 90280-04M00 | 156-363-367 |

| REF | R.O. / OEM | |
|-------------------|----------------|---|
| REC90280-04M04 | 90280-04M04 | 154-155-156-321-371 |
| REC90280-04M04 | 90280-04M04-00 | 373 |
| REC90280-04M05 | 90280-04M05 | 155-156-157-325-329-333-339-377-381-385-386 |
| REC90280-05049 | 90280-05049 | 229 |
| REC90282-04010 | 902082-04010 | 365 |
| REC90282-04010 | 90282-04010 | 315-319-323-353-357-359-369-371-373-375 |
| REC90282-04M00 | 90282-04M00 | 327 |
| REC90340-08002 | 6E0-45316-09 | 346 |
| REC90340-08002 | 90340-08002 | 283-285-287-289-291-282-299-303-307-311-315-319-323-327-331-335-337-341-345-350-353-357-361-363-369-370-373-379-383 |
| REC90340-08002 | 90340-08014 | 348-359 |
| REC90340-08002 | 90340-08M04 | 295-343-347-365-375 |
| REC90381-20001 | 90381-20001 | 133 |
| REC90386-18M63 | 90386-18M63 | 133 |
| REC90386-22M13 | 90386-22M13 | 133 |
| REC90386-22M98 | 90386-22M98 | 133 |
| REC90386-25M31 | 90386-25M31 | 133 |
| REC90386-30M77 | 90386-30M77 | 133 |
| REC90386-38M89 | 90386-38M89 | 133 |
| REC90387-32002 | 90387-32002 | 229 |
| REC90389-22M01 | 90389-22M01 | 299-303-307-311-361-365-405 |
| REC90389-25M00 | 90389-25M00 | 315-319-371-405 |
| REC90430-06M03 | 90430-06M03 | 209-211-213-214-347-363-365 |
| REC90430-08020 | 90430-08003 | 292-303-307-311-315-323-283-285-287-289-291-299-327-331-335-337-341-343-345-346-347-348-350-353-355-357-359-361-363-365-369-370-375-379-383-386 |
| REC90430-08020 | 90430-08020 | 295 |
| REC90430-08020 | 93210-06ME6 | 64-65-66-67-68-69-70-71-72-73 |
| REC90430-08020 | 90430-08020-00 | 373 |
| REC90430-12072 | 90430-12072 | 301-305-309-361-367-371 |
| REC90430-12072 | 90430-12072-00 | 373 |
| REC90480-18065 | 90480-18065 | 235-239 |
| REC90480-20M05 | 90480-20M05 | 139-209-211-243-245-247 |
| REC90501-10M77 | 90501-10M77 | 331-335-337-341-383 |
| REC90501-11M10-00 | 90501-11M10 | 329-333-339-381-385 |
| REC90501-12M48 | 90501-12M48 | 315-319-373 |
| REC90501-14M02 | 90501-14M02 | 235 |
| REC90501-16233 | 90501-16233 | 369-371 |
| REC90501-16M01 | 90501-16M01 | 359-365 |
| REC90501-16M11 | 90501-16M11 | 139-209-211-243-245-247 |
| REC90501-16M37 | 90501-16M37 | 323-327-375-379 |
| REC90501-450A2 | 90501-450A2 | 339 |
| REC90794-46866 | 907-94469-05 | 78 |
| REC90794-46868 | 907-94469-13 | 78 |
| REC91490-30025 | 91490-30020 | 289-291-293-351 |
| REC91490-30025 | 91490-30025 | 64-65-67-68-69-299-303-307-311-315-357-361-365-405 |
| REC91490-30030 | 91490-30030 | 353-359-405 |
| REC91490-30040 | 91490-30040 | 343 |
| REC91490-40030 | 91490-40025 | 319-369-371-68-69-70-71-72-73-323-327-331-335-337-341-375-379-383-405 |
| REC91490-40030 | 91490-40030-00 | 373 |
| REC92990-16200 | 92990-16200 | 359-369-405 |
| REC92990-18200 | 92990-18200 | 323-327-331-335-337-375-379-405 |
| REC93101-10M14 | 93101-10M14 | 345 |
| REC93101-10M25 | 93101-10M25 | 221 |
| REC93101-11M23 | 93101-11M23 | 289-346 |
| REC93101-12M70 | 93101-12M70 | 341 |
| REC93101-13018 | 93101-13018 | 227 |
| REC93101-13M12 | 93101-13M12 | 287-345 |
| REC93101-13M27 | 93101-13M27 | 270 |
| REC93101-14M01 | 93101-14M01 | 225 |

| REF | R.O. / OEM | |
|----------------|----------------|---|
| REC93101-15074 | 93101-15074 | 289-346-347 |
| REC93101-16001 | 93101-16001 | 229-233 |
| REC93101-17054 | 93101-17054 | 291-293-349-351 |
| REC93101-18050 | 93101-18050 | 347 |
| REC93101-20048 | 93101-20001 | 292 |
| REC93101-20048 | 93101-20048 | 291-349-351-363 |
| REC93101-20M07 | 93101-20M07 | 295-353-355-357 |
| REC93101-20M29 | 93101-20M29 | 221-225 |
| REC93101-20M34 | 93101-20M34 | 223 |
| REC93101-22067 | 93101-22067 | 353-355-359-365-367-369 |
| REC93101-22M00 | 93101-22067 | 297 |
| REC93101-22M00 | 93101-22M00 | 299-303-307-311-361-363 |
| REC93101-22M15 | 93101-22M15 | 245-247 |
| REC93101-22M60 | 93101-22M60 | 301-305-361 |
| REC93101-23070 | 93101-23070 | 317-357-359-369 |
| REC93101-25018 | 93101-250-18 | 227 |
| REC93101-25M03 | 93101-25M03 | 315-319-321-371 |
| REC93101-25M03 | 93101-25M03-00 | 373 |
| REC93101-25M35 | 93101-25M28 | 231 |
| REC93101-25M57 | 93101-25M57 | 309-313 |
| REC93101-28M16 | 93101-28M16 | 325-329-333-335-339-377-381-385-386-335-337 |
| REC93101-30002 | 93101-300002 | 323-327-331-375-379-383 |
| REC93101-30M17 | 93101-30M17 | 235 |
| REC93101-30M33 | 93101-30M33 | 220 |
| REC93102-15M32 | 93102-15M32 | 223-225 |
| REC93102-20M25 | 93102-20M25 | 237 |
| REC93102-23096 | 93102-23096 | 229 |
| REC93102-25008 | 93102-25008 | 237 |
| REC93102-25M28 | 93102-25M28 | 227 |
| REC93102-25M48 | 93102-25M48 | 231 |
| REC93102-26M27 | 93102-26M27 | 239 |
| REC93102-28135 | 93102-28135 | 243 |
| REC93102-30M05 | 93102-30M05 | 241 |
| REC93102-30M23 | 93102-30M23 | 233 |
| REC93102-30M56 | 93102-30M56 | 229-239 |
| REC93102-32M07 | 93102-32M07 | 245-247 |
| REC93102-35M13 | 93102-35M13 | 235 |
| REC93102-35M18 | 93102-35M18 | 243 |
| REC93102-36M02 | 93102-36M02 | 241 |
| REC93102-36M24 | 93102-36M24 | 211-213 |
| REC93102-38008 | 93102-38008 | 209 |
| REC93102-38008 | 93102-38M59 | 209 |
| REC93102-40M14 | 93102-40M14 | 245-247 |
| REC93102-48009 | 93102-48009 | 209 |
| REC93102-60004 | 93102-60004 | 211 |
| REC93102-63004 | 93102-63008 | 213 |
| REC93103-10052 | 93103-10052 | 343 |
| REC93103-11051 | 93103-11051 | 343 |
| REC93104-16M01 | 93104-16M01 | 235-237 |
| REC93104-16M01 | 93104-16M04 | 231 |
| REC93104-18049 | 93104-18049 | 239 |
| REC93104-20M02 | 93104-20M02 | 243 |
| REC93104-22M07 | 93104-22M07 | 335 |
| REC93106-09014 | 93106-09014 | 305-309-313-317-321-325-329-333-335-339-369-371-377-381-385 |
| REC93106-09014 | 93106-09014-00 | 373 |
| REC93106-18M01 | 93106-18M01 | 241 |
| REC93109-44M00 | 93109-44M00 | 132 |
| REC93110-23M00 | 93110-23M00 | 227 |
| REC93210-06ME6 | 93210-06ME6 | 289-291-292-297-301-351-361 |
| REC93210-07540 | 93210-07003 | 329 |
| REC93210-19MJ1 | 93210-19MJ1 | 211-213 |
| REC93210-22M02 | 93210-22M02 | 235 |
| REC93210-25552 | 93210-25552 | 211-213 |
| REC93210-32738 | 93210-32738 | 65-66-68-69-80-81 |
| REC93210-33MG4 | 93210-33MG4 | 301-305-309-313-361 |
| REC93210-37160 | 93210-37160 | 325-329-333-335-339-341-377-381 |
| REC93210-37M67 | 93210-37M67 | 385-386 |
| REC93210-41042 | 93210-41042 | 357-359-367-369 |
| REC93210-42101 | 93210-42101 | 343 |
| REC93210-42159 | 93210-42159 | 223-225-231-239 |
| REC93210-42M70 | 93210-42M70 | 225 |
| REC93210-44398 | 93210-44398 | 154-155-289-291 |
| REC93210-45161 | 93210-45161 | 155 |
| REC93210-46044 | 93210-46044 | 317-321-371 |
| REC93210-46044 | 93210-46044-00 | 373 |
| REC93210-46M16 | 93210-46M16 | 227-229-241-243 |
| REC93210-48214 | 93210-48214 | 287-341-345 |
| REC93210-48MG8 | 93210-48MG8 | 301-309-361 |
| REC93210-49046 | 93210-49046 | 154-289-293-317-321-346-359-369-371 |
| REC93210-49046 | 93210-49046-00 | 373 |
| REC93210-53M08 | 93210-53M08 | 289-346 |

| REF | R.O. / OEM | |
|-------------------|----------------|---|
| REC93210-54534 | 93210-54534 | 333-339-385 |
| REC93210-54534 | 93210-55M14 | 325-329-377-381 |
| REC93210-54M54 | 93210-54M54 | 223 |
| REC93210-57M00 | 93210-57M00 | 363 |
| REC93210-57M09 | 93210-57M09 | 291-293-349-351 |
| REC93210-58677 | 93210-58144 | 325-329-377-381 |
| REC93210-58677 | 93210-58677 | 347 |
| REC93210-58M21 | 93210-58M21 | 229-237 |
| REC93210-59MG7 | 93210-59MG7 | 154-156-301-305-309-313-361 |
| REC93210-60MA3 | 93210-60MA3 | 357 |
| REC93210-62269 | 93210-62269 | 239-243 |
| REC93210-64ME7 | 93210-64ME7 | 295-355 |
| REC93210-65752-00 | 93210-64488 | 333-335 |
| REC93210-65M50 | 93210-65M50 | 233-235-241-295-355 |
| REC93210-66M98 | 93210-66M98 | 359-365-369 |
| REC93210-69MG6 | 93210-69MG6 | 299-303-307-311-341-361 |
| REC93210-74M35 | 93210-74M35 | 245-247 |
| REC93210-74MG5 | 93210-74MG5 | 299-303-311-361 |
| REC93210-85M97 | 93210-85M97 | 371 |
| REC93210-85M97 | 93210-85M97-00 | 373 |
| REC93210-86M38 | 93210-86M38 | 155-156-157-325-329-333-339-377-381-385-386 |
| REC93210-86M39 | 93210-86M39 | 315-319-323-375 |
| REC93210-94003 | 93210-94003 | 335-341 |
| REC93210-97M55 | 93210-97M55 | 327-379 |
| REC93211-04001 | 93211-04001 | 245-247 |
| REC93211-04384 | 93211-04384 | 331-337-383 |
| REC93304-205U0 | 93304-205U0 | 257 |
| REC93306-001U1 | 93306-001U1 | 299-303-307-311-361-394-395-396 |
| REC93306-00501 | 93306-00501 | 291-293-349-351-393-394 |
| REC93306-00519 | 93306-00519 | 347-393 |
| REC93306-00612 | 93306-00612 | 353-355-357-394-395 |
| REC93306-00702 | 93306-00702 | 359-365-369-394-395-396 |
| REC93306-204U0 | 93306-204U0 | 221-223 |
| REC93306-204U0 | 93306-240U0 | 225-257 |
| REC93306-204Y7 | 93306-20401 | 363 |
| REC93306-205U2 | 93306-205U7 | 257 |
| REC93306-205U7 | 93306-205U7 | 227-257 |
| REC93306-206U5 | 93306-206U5 | 243-258 |
| REC93306-207U0 | 93306-207U0 | 315-319-371-395-396-397 |
| REC93306-207U0 | 93306-207U0-00 | 373 |
| REC93306-208U0 | 93306-208U0 | 245-247-258-259-323-375-393-397 |
| REC93306-209U0 | 93306-209U0 | 327-335-379-397-398-399-400 |
| REC93306-209U1 | 93306-209U1 | 259 |
| REC93306-210U0 | 93306-210U0 | 331-337-383-399-400 |
| REC93306-304U0 | 93306-304U0 | 257 |
| REC93306-305U0 | 93306-305U0 | 257-258 |
| REC93306-305U3 | 93306-305U3 | 229-231-257-258 |
| REC93306-305U8 | 93306-305-U8 | 237-258 |
| REC93306-306V1 | 93306-303V1 | 235 |
| REC93306-306V1 | 93306-306V1 | 241-257-258 |
| REC93306-306V5 | 9306-306V5 | 233-258 |
| REC93306-307U0 | 93306-307U0 | 233-235-258 |
| REC93310-112V0 | 93310-112V0 | 221-223-257-262 |
| REC93310-32337 | 93310-323V6 | 245 |
| REC93310-32337 | 93603-21111 | 265 |
| REC93310-32337 | 93310-32337 | 247-258-259-265 |
| REC93310-32668 | 93310-32668 | 247 |
| REC93310-326V4 | 93310-326V4 | 259 |
| REC93310-418U0 | 93310-418U0 | 225-257 |
| REC93310-418V0 | 93310-418V1 | 221-223-257 |
| REC93310-522W0 | 93310-522W0 | 257-258 |
| REC93310-527W1 | 93310-527W1 | 258 |
| REC93310-620V5 | 93310-620V5 | 227-257 |
| REC93310-624U5 | 93310-624U6 | 229-257-258 |
| REC93310-636U4 | 93310-636U4 | 243-258 |
| REC93310-727U0 | 93310-727U0 | 233-258 |
| REC93310-727V7 | 93310-727V7 | 235-258 |
| REC93310-730V6 | 93310-730V6 | 258 |
| REC93310-730V8 | 93310-730V8 | 239-243-258 |
| REC93310-835U8 | 93310-835U8 | 243-258 |
| REC93310-836U0 | 93310-836U0 | 258-259 |
| REC93310-836V2 | 93310-836V2 | 245-247-258-259 |
| REC93310-954U1 | 93310-954U1 | 245-247-258-259 |
| REC93310-954V3 | 93310-954V3 | 258-259 |
| REC93310-959U0 | 93310-959U0 | 247 |
| REC93311-632U1 | 93311-632U1 | 239-258 |
| REC93311-632U7 | 93311-632U7 | 231-257 |
| REC93311-632V4 | 93311-632V4 | 257-258 |
| REC93311-636U6 | 93311-636U6 | 241-257-258 |

| REF | R.O. / OEM | |
|-------------------|----------------|---|
| REC93311-83280 | 93311-83280 | 331-335-337-383-399-400 |
| REC93311-832U4 | 93311-832U4 | 239-258 |
| REC93311-85894 | 93311-85894 | 335 |
| REC93311-928U5 | 93311-928U5 | 329-381-397-398-399-400 |
| REC93311-940U3 | 93311-940U3 | 245-247-258-259 |
| REC93311-940V0 | 93311-940V0 | 247 |
| REC93315-017U4 | 93315-017U4 | 353-394-395 |
| REC93315-217U0 | 93315-217U0 | 363-395 |
| REC93315-22004 | 93315-22004 | 295-353-355-357-394-395 |
| REC93315-220V7 | 93315-220V7 | 355-357-394-395 |
| REC93315-314V8 | 93315-314V8 | 291-292-351-393-394 |
| REC93315-317U2 | 93315-317U2 | 291-293-349-351-393-394 |
| REC93315-32224 | 93315-32224 | 301-305-309-313-359-361-367-369-394-395-396 |
| REC93315-324U1 | 93315-324U1 | 363-395 |
| REC93315-325V1 | 93315-325V1 | 371-394-395-396 |
| REC93315-325V1 | 93315-325V1-00 | 373 |
| REC93315-425U7 | 93315-425U7 | 323-375-396-397 |
| REC93315-425V3 | 93315-425V3 | 327-379-397-398-399-400 |
| REC93315-43061 | 93315-43061 | 327-331-335-379-383-397-398-399-400 |
| REC93315-430U8 | 93315-430U8 | 323-375-396-397-398-399-400 |
| REC93315-430V5 | 93315-430V5 | 396-397-398-399-400 |
| REC93315-628U9 | 93315-628U9 | 325-377-396-397-398 |
| REC93317-22204 | 93317-22204 | 299-303-307-311-359-361-365-369-394-395-396 |
| REC93317-322V0 | 93317-322V0 | 315-319-396-397 |
| REC93317-325U0 | 93317-325U0 | 315-319-371-396-397 |
| REC93317-325U0 | 93317-325U0-00 | 373 |
| REC93317-330U2 | 93317-330U2 | 325-329-333-339-377-381-385-396-397-398-399-400 |
| REC93332-00001 | 93332-00001 | 301-305-309-313-357-361-369-394-395-396 |
| REC93332-00003 | 93332-00003 | 299-303-307-361-365-369-394-395-396 |
| REC93332-00005 | 93332-00005 | 291-293-295-349-351-353-355-393-394-395 |
| REC93332-00023 | 93332-00023 | 394-395-396 |
| REC93332-00048 | 93332-00048 | 327-331-397-398-399-400 |
| REC93332-000A5 | 93332-000A5 | 335 |
| REC93332-000U0 | 93332-000U0 | 363-395 |
| REC93332-000U3 | 93332-000U3 | 317-321-371-396-397 |
| REC93332-000U3 | 93332-000U3-00 | 373 |
| REC93332-000U5 | 93332-000U5 | 396 |
| REC93332-000U7 | 93332-000U7 | 323-375-396-397 |
| REC93332-000UE | 93332-000UE | 233-235-258 |
| REC93332-000V3 | 93332-000V3 | 327-379-397-398-399-400 |
| REC93332-000W1 | 93332-000W1 | 331-337-383-399-400 |
| REC93332-000W5 | 93332-000W5 | 355-394-395 |
| REC93332-000W7 | 93332-000W7 | 371-394-395-396 |
| REC93332-000W7-00 | 93332-000W7-00 | 373 |
| REC93340-67011 | 93340-67011 | 335-341 |
| REC93341-214U1 | 93314-314V8 | 291 |
| REC93341-214U1 | 93341-214U1 | 348-393-394 |
| REC93341-41414 | 93341-41414 | 351-393-394 |
| REC93341-93020 | 93341-93020 | 333-385 |
| REC93341-93020 | 93341-930U9 | 339 |
| REC93341-930V2 | 93341-930V2 | 325-329-377-381-396-397-398-399-400 |
| REC93342-624U0 | 93342-624U0 | 363 |
| REC93390-000U0 | 93390-000U0 | 363-395 |
| REC93390-000U2 | 93390-000U2 | 397-398-399 |
| REC93399-99951 | 93399-99951 | 229-257 |
| REC93440-52009 | 93440-52008 | 227 |
| REC93440-68M03 | 93440-68M03 | 233-235 |
| REC93450-13022 | 93450-13022 | 221-223-225-262 |
| REC93450-15023 | 93450-15023 | 227-262 |
| REC93501-04011 | 93501-04011 | 331-335-337-341-383 |
| REC93503-16003 | 93503-16003 | 315-319-323-327-373-375-379 |
| REC93507-32031 | 93507-32009 | 323-327 |

| REF | R.O. / OEM | |
|-------------------|----------------|---|
| REC93507-32031 | 93507-32031 | 375-379 |
| REC93511-32027 | 93511-32017 | 327 |
| REC93511-32027 | 93511-32027 | 323-375-379 |
| REC93602-14104 | 93602-14104 | 227-257-262 |
| REC93602-14118 | 93602-14118 | 225-257-262 |
| REC93602-18M12 | 93602-18M12 | 229 |
| REC93602-20M02 | 93602-20M02 | 229-237-257- 258-263-264 241-257-258- 262-264 |
| REC93603-18M09 | 93603-18M09 | 233-235-239- 243-258-259- 263-264-265 |
| REC93603-21111 | 93603-21111 | 205 |
| REC93606-12019 | 90606-12019 | 297 |
| REC93606-12019 | 93606-11M24 | 187-195-201- 203-207-209- 211-213-214- 221-227-229- 231-237-299- 303-307-311- 315-319-325- 329-333-335- 339-341-349- 367-371-377- 381-385 |
| REC93606-12019 | 93606-42019 | 386 |
| REC93608-12M05 | 93608-12M05 | 323-331-337- 341-383 |
| REC95380-06700 | 95380-06700 | 301-361 |
| REC97075-10040 | 97075-10040 | 299-303-307- 311-319-369- 370 |
| REC97080-08045 | 97080-08045 | 289-291-351 |
| REC97095-06040 | 97095-06040 | 347-355 |
| REC97095-06045 | 97095-06045 | 211-287-346 |
| REC97095-08045 | 97095-08045 | 293-363-367- 369 |
| REC97095-08045 | 97395-08045 | 359 |
| REC97095-08055 | 97095-08055 | 363-367-369 |
| REC97095-08055 | 97395-08055 | 359 |
| REC97395-08070 | 97395-08070-00 | 373 |
| REC99001-06600 | 99001-06600 | 287-346 305-309-313- 317-321-325- 329-333-335- 339-369-371- 377-381-385 337-383 |
| REC99001-08600-00 | 99001-08600 | 134 |
| REC99590-10114 | 99590-10114 | 209 |
| REC99999-02808 | 99999-02808 | 209 |
| RECK0A-A3721-00 | K0A-A3721-00 | 209 |
| RECK0A-A3722-00 | K0A-A3722-00 | 209 |
| RECKITF100D | | 70 |
| RECKITF100F | | 70 |
| RECKITF115A | | 70 |
| RECKITF115B | | 71 |
| RECKITF150CR | | 71 |
| RECKITF150G | | 72 |
| RECKITF150RR | | 71 |
| RECKITF15C | | 65 |
| RECKITF2.5A | | 64 |
| RECKITF2.5B | | 64 |
| RECKITF200A | | 72 |
| RECKITF200C | | 72 |
| RECKITF20A | | 65 |
| RECKITF20B | | 65 |
| RECKITF225B | | 72 |
| RECKITF225C | | 73 |
| RECKITF250D | | 73 |
| RECKITF25A | | 66 |
| RECKITF25D | | 66 |
| RECKITF25G | | 66 |
| RECKITF300A | | 73 |
| RECKITF30A | | 67 |
| RECKITF30B | | 67 |
| RECKITF350A | | 73 |
| RECKITF40B | | 67 |
| RECKITF4A | | 64 |
| RECKITF50A | | 67 |
| RECKITF50F | | 68 |
| RECKITF5A | | 64 |
| RECKITF60A | | 69 |
| RECKITF6A | | 64 |
| RECKITF6C | | 64 |
| RECKITF70A | | 69 |
| RECKITF80A | | 69 |
| RECKITF80B | | 70 |
| RECKITF9.9C | | 65 |
| RECKITFT25B | | 66 |
| RECKITFT25F | | 66 |
| RECKITFT50B | | 68 |
| RECKITFT50C | | 68 |
| RECKITFT50G | | 68 |
| RECKITFT60B | | 69 |
| RECKITFT8D | | 65 |
| RECIN26-13440-00 | N26-13440-00 | 83-214 |
| RECIN26-13440-00 | N26-13440-02 | 73-83 |
| RECOBRACKET | | 77 |
| RECOBELEMENT | | 78 |
| RECOBFILALU | | 78 |
| RECOBFILTER | | 78 |
| RECPIN4 | | 125 |
| RECPIN4.5 | | 125 |
| RECPIN6 | | 125 |
| RECTOOLTRIM1 | | 125 |
| RECTOOLTRIM2 | | 125 |

| REF | R.O. / OEM | |
|------------------|-----------------|-----|
| RECTOOLTRIM3 | | 125 |
| RECTOOLTRIMKIT | | 125 |
| RECYS-225-15 | | 78 |
| RM35-802893Q | | 78 |
| RM92-858026QB1U6 | 92-858026QB1 | 84 |
| RM92-858027QB1U3 | 92-858027QB1 | 84 |
| RM92-8M0086220U6 | 92-8M0086220 | 84 |
| RM92-8M0086221U3 | 92-8M0086221 | 84 |
| S | | |
| SIE18-8013 | | 74 |
| SIE18-8015 | | 74 |
| SOL2011-083-08P | | 402 |
| SOL3011-073-05S | 6L5-45949-00-EL | 402 |
| SOL3011-075-07S | 6E0-45943-01-EL | 402 |
| SOL3011-085-07 | 6G1-45947-00-EL | 402 |
| SOL3011-085-08 | 6G1-45943-00-EL | 402 |
| SOL3011-085-09 | 6G1-45941-00-EL | 402 |
| SOL3011-090-07-P | 647-45943-00-EL | 402 |
| SOL3111-093-07 | | 402 |
| SOL3111-093-08 | 683-45947-00-EL | 402 |
| SOL3111-093-09 | 683-45945-00-EL | 402 |
| SOL3111-093-10 | 683-45942-00-EL | 402 |
| SOL3111-093-11 | 683-45943-00-EL | 402 |
| SOL3111-093-12 | 683-45941-00-00 | 402 |
| SOL3211-099-09 | 664-45941-01-EL | 402 |
| SOL3211-099-10 | 664-45945-00-EL | 402 |
| SOL3211-099-11 | 664-45947-01-EL | 402 |
| SOL3211-099-12 | 664-45954-00-EL | 402 |
| SOL3211-099-13 | 664-45949-02-EL | 402 |
| SOL3231-101-13 | MAR-6YT30-02-12 | 402 |
| SOL3231-103-12 | 664-45970-00-98 | 402 |
| SOL3231-105-11 | 664-45972-00-98 | 402 |
| SOL3231-108-10 | | 402 |
| SOL3311-110-15 | 663-45943-02-EL | 402 |
| SOL3311-110-16 | 663-45949-01-EL | 402 |
| SOL3311-110-17 | 663-45941-01-EL | 402 |
| SOL3311-111-13 | 663-45945-02-EL | 402 |
| SOL3311-111-14 | 663-45958-01-EL | 402 |
| SOL3311-114-12 | 663-45952-02-EL | 402 |
| SOL3311-115-10-P | | 402 |
| SOL3311-115-11-P | | 402 |
| SOL3311-115-12-P | | 402 |
| SOL3311-116-11 | 663-45947-02-EL | 402 |
| SOL3311-121-09 | 663-45956-01-EL | 402 |
| SOL3331-111-13 | 663-45945-02-EL | 402 |
| SOL3331-111-14 | 663-45958-01-EL | 402 |
| SOL3331-114-12 | 663-45970-60-98 | 402 |
| SOL3331-116-11 | 663-45972-60-98 | 402 |
| SOL3331-119-10 | 663-45954-01-EL | 402 |
| SOL3411-130-19 | 6E5-45941-00-EL | 402 |
| SOL3411-130-21 | 6E5-45943-00-EL | 402 |
| SOL3411-133-17 | 6E5-45945-00-EL | 402 |
| SOL3411-135-15 | 6E5-45947-00-EL | 402 |
| SOL3411-138-13 | 6E5-45949-00-EL | 402 |
| SOL3411-140-11 | 6E5-45954-00-EL | 402 |
| SOL3412-133-17 | | 402 |
| SOL3412-135-15 | | 402 |
| SOL3412-138-13 | | 402 |
| SOL3413-125-19 | 6E5-45941-00-EL | 402 |
| SOL3413-125-21 | 6E5-45943-00-EL | 402 |
| SOL3413-128-17 | 6E5-45945-00-EL | 402 |
| SOL3413-130-15 | 6E5-45947-00-EL | 402 |
| SOL3413-133-13 | 6E5-45949-00-EL | 402 |
| SOL3431-130-19 | 688-45970-03-98 | 402 |
| SOL3431-130-21 | 688-45972-02-98 | 402 |
| SOL3431-133-17 | 688-45930-02-98 | 402 |
| SOL3431-135-15 | 688-45978-60-98 | 402 |
| SOL3432-130-19 | | 402 |
| SOL3432-133-17 | | 402 |
| SOL3511-142-23 | 6G5-45949-00-98 | 403 |
| SOL3511-143-21 | 6G5-45949-00-98 | 403 |
| SOL3511-145-19 | 6G5-45945-01-98 | 403 |
| SOL3511-148-17 | 6G5-45947-01-98 | 403 |
| SOL3511-150-15 | 6G5-45941-00-98 | 403 |
| SOL3512-142-23 | 6G5-45949-00-98 | 403 |
| SOL3512-143-21 | | 403 |
| SOL3512-145-19 | 6K1-45945-01-98 | 403 |
| SOL3512-148-17 | 6K1-45947-00-98 | 403 |
| SOL3512-150-15 | 6G5-45952-00-98 | 403 |
| SOL3513-140-21 | 6G5-45949-00-98 | 403 |
| SOL3513-143-19 | 6G5-45945-01-98 | 403 |
| SOL3513-145-17 | 6G5-45947-01-98 | 403 |
| SOL3513-148-15 | 6G5-45941-00-98 | 403 |
| SOL3514-140-21 | | 403 |
| SOL3514-143-19 | 6K1-45945-01-98 | 403 |
| SOL3514-145-17 | 6K1-45947-00-98 | 403 |
| SOL3514-148-15 | 6G5-45952-00-98 | 403 |
| SOL3531-140-19 | 6G5-45974-03-98 | 403 |
| SOL3531-140-21 | 6G5-45972-02-98 | 403 |
| SOL3531-140-23 | 6G5-45976-01-98 | 403 |
| SOL3531-143-17 | 6G5-45978-03-98 | 403 |
| SOL3531-145-15 | 6G5-45970-02-98 | 403 |
| SOL3532-140-19 | 6K1-45974-02-98 | 403 |
| SOL3532-140-21 | 6K1-45972-01-98 | 403 |
| SOL3532-140-23 | 6K1-45976-00-98 | 403 |
| SOL3532-143-17 | 6K1-45978-02-98 | 403 |
| SOL3532-145-15 | 6K1-45970-01-98 | 403 |
| SOL3571-145-25 | | 403 |
| SOL3571-148-23 | | 403 |
| SOL3571-150-21 | 6G5-45949-00-98 | 403 |
| SOL3571-153-19 | 6G5-45945-01-98 | 403 |
| SOL3571-155-17 | 6G5-45947-01-98 | 403 |
| SOL3571-158-15 | 6G5-45941-00-98 | 403 |

| REF | R.O. / OEM | |
|----------------|-----------------|---------------------|
| SOL3572-148-23 | | 403 |
| SOL3572-150-21 | | 403 |
| SOL3572-153-19 | 6K1-45945-01-98 | 403 |
| SOL3572-155-17 | 6K1-45947-00-98 | 403 |
| SOL3572-158-15 | 6G5-45952-00-98 | 403 |
| SOL9311-110-15 | | 404 |
| SOL9311-111-13 | | 404 |
| SOL9311-111-14 | | 404 |
| SOL9311-114-12 | | 404 |
| SOL9311-116-11 | | 404 |
| SOL9311-120-10 | | 404 |
| SOL9311-121-09 | | 404 |
| SOL9331-110-15 | | 404 |
| SOL9331-111-13 | | 404 |
| SOL9331-111-14 | | 404 |
| SOL9331-114-12 | | 404 |
| SOL9331-116-11 | | 404 |
| SOL9411-132-19 | | 404 |
| SOL9411-132-21 | | 404 |
| SOL9411-133-17 | | 404 |
| SOL9411-135-15 | | 404 |
| SOL9411-138-13 | | 404 |
| SOL9411-140-09 | | 404 |
| SOL9411-140-11 | | 404 |
| SOL9431-130-19 | | 404 |
| SOL9431-130-21 | | 404 |
| SOL9431-133-17 | | 404 |
| SOL9431-135-15 | | 404 |
| SOL9431-138-13 | | 404 |
| SOL9432-130-19 | | 404 |
| SOL9432-133-17 | | 404 |
| SOL9432-135-15 | | 404 |
| SOL9432-138-13 | | 404 |
| SOL9511-143-21 | | 404 |
| SOL9511-145-19 | | 404 |
| SOL9511-148-17 | | 404 |
| SOL9511-150-15 | | 404 |
| SOL9511-153-13 | | 404 |
| SOL9511-155-11 | | 404 |
| SOL9511-160-13 | | 404 |
| SOL9531-140-19 | | 404 |
| SOL9531-140-21 | | 404 |
| SOL9531-140-23 | | 404 |
| SOL9531-143-17 | | 404 |
| SOL9531-145-15 | | 404 |
| SOL9532-140-19 | | 404 |
| SOL9532-140-21 | | 404 |
| SOL9532-140-23 | | 404 |
| SOL9532-143-17 | | 404 |
| SOL9532-145-15 | | 404 |
| SOL9571-145-25 | | 404 |
| SOL9571-148-23 | | 404 |
| SOL9571-150-21 | | 404 |
| SOL9571-153-19 | | 404 |
| SOL9571-155-17 | | 404 |
| SOL9571-158-15 | | 404 |
| SOL9572-145-25 | | 404 |
| SOL9572-148-23 | | 404 |
| SOL9572-150-21 | | 404 |
| SOL9572-153-19 | | 404 |
| SOL9572-155-17 | | 404 |
| SOL9572-158-15 | | 404 |
| SOLRBX-102 | | 405 |
| SOLRBX-103 | | 405 |
| SOLRBX-108 | | 405 |
| SOLRBX-117 | | 405 |
| SOLRBX-127 | | 405 |
| STA93900 | | 136 |
| STA93922 | | 136 |
| STA93932 | | 136 |
| STA94100 | | 136 |
| T | | |
| TEN01100 | 664-45371-01 | 164-169 |
| TEN01100AL | 664-45371-01 | 164-169 |
| TEN01101 | 679-45371-00 | 164-169-365- 369 |
| TEN01101AL | 679-45371-00 | 164-169 |
| TEN01102 | | 164 |
| TEN01103 | 6L6-45371-00 | 164-169 |
| TEN01103AL | 6L6-45371-00 | 164-169 |
| TEN01104 | 688-45371-02 | 164-169 |
| TEN01104AL | 688-45371-02 | 164-169 |
| TEN01105 | 6E5-45251-00 | 164-169 |
| TEN01106 | 6E8-45251-00 | 164 |
| TEN01107 | | 165 |
| TEN01108 | 6G1-45251-02 | 165-169 |
| TEN01109 | 676-45251-00 | 163-169 |
| TEN01110 | 688-45251-01 | 163-169 |
| TEN01111 | | 163 |
| TEN01112 | 6G5-45251-01 | 166-169 |
| TEN01112 | 6G5-45251-02 | 166-169 |
| TEN01112AL | 6G5-45251-01 | 166-169 |
| TEN01112AL | 6G5-45251-02 | 166-169 |
| TEN01112-1 | 6AW-45251 | 166-169 |
| TEN01113 | 6H1-45251-03 | 166-169 |
| TEN01114 | | 167 |
| TEN01115 | 6H1-45251-02 | 166-169 |
| TEN01115AL | 6H1-45251-02 | 166-169 |
| TEN01116 | 6B4-45251-00 | 348 |
| TEN01116 | 6E8-45251-02 | 164 |
| TEN01116 | 6B4-45251-00 | 169 |
| TEN01117 | 6L5-45251-02 | 166-169 |
| TEN01118 | 6G1-45251-03 | 164 |
| TEN01118 | 6N0-G5251-00 | 346 |

| REF | R.O. / OEM | REF | R.O. / OEM | REF | R.O. / OEM | | | |
|------------|-----------------|-------------|--------------|--------------|-----------------|----------------------|-----------------|----------------|
| TEN01118 | 6G1-45251-03 | 169 | TEN01139 | 6T5-45251-00 | 167 | TEN01161 | 6BL-11325-00 | 166 |
| TEN01119 | 6T5-45371-00 | 165 | TEN01140 | 67F-45371-00 | 165 | TEN01162 | 682-11325-00 | 166-227 |
| TEN01120 | 6T5-45373-00 | 166 | TEN01141 | 67F-45371-00 | 165-169 | TEN01163 | 68T-11325-00 | 166 |
| TEN01121 | 689-11325-00 | 167-229 | TEN01141AL | 67F-45371-00 | 165-169 | TEN01164 | 63P-11325-11-00 | 166-169 |
| TEN01122 | 6T4-45836-00 | 164 | TEN01142 | 68T-45251-00 | 163-169 | TEN01165 | 63P-11325-21 | 211 |
| TEN01123 | 65W-45251-00 | 164-169 | TEN01143 | 6J9-45371-00 | 165 | TEN01165 | 63P-11325-21-00 | 163 |
| TEN01123 | 6E0-45251-11-00 | 164-169 | TEN01144 | 6K1-45371-00 | 168-169 | TEN01165 | 63P-11325-21 | 70-71 |
| TEN01123AL | 65W-45251-00 | 164-169 | TEN01144AL | 6K1-45371-00 | 168-169 | TEN01166 | 664-11325-00 | 225 |
| TEN01123AL | 6E0-45251-11-00 | 164-169 | TEN01145 | 69L-45371-00 | 168-169 | TEN01166 | 676-11325-00 | 166-233-235 |
| TEN01124 | 61A-45371-00 | 165-169 | TEN01146 | 67F-11325-00 | 163 | TEN01167 | 63P-11325-01-00 | 166-169 |
| TEN01124AL | 61A-45371-00 | 165-169 | TEN01146-1 | 67F-11325-01 | 163 | TEN01168 | 61A-11325-00 | 163 |
| TEN01125 | 6H1-45251-01 | 167 | TEN01147 | 688-11325-00 | 163-237-243 | TEN01169 | 6AW-45619-00 | 165 |
| TEN01126 | | 167 | TEN01148 | 6G8-11325-00 | 163-169 | TEN01170 | 6AW-11325-00 | 214 |
| TEN01127 | 676-45251-00 | 166-233-235 | TEN01149 | 62Y-11325-00 | 163 | TEN01170 | 6AW-11325-00 | 167 |
| TEN01128 | 682-45251-00 | 166 | TEN01150 | 6J8-11325-00 | 163-229-231 | TEN01170 | 6AW-11325-00 | 73-169 |
| TEN01129 | 6E5-45251-00 | 165 | TEN01151 | 66M-11325-00 | 163 | TEN01171 | 6AQ-1132N-00 | 73-167-169 |
| TEN01130 | 61N-45371-00 | 165-355 | TEN01152 | 6E5-11325-00 | 163-169-245-247 | TEN01172 | 6AW-1132R-00 | 73-167-169-214 |
| TEN01131 | 63D-45251-00 | 165 | TEN01153 | 6E5-45371-00 | 164 | TEN01173 | 6AW-1132L-00 | 73-167-169 |
| TEN01131 | 63D-45251-01 | 165 | TEN01153 | 6E5-45371-10 | 370-375 | TEN01174 | 6AW-1132U-00 | 73-167 |
| TEN01131 | 63D-45251-00 | 169 | TEN01154 | 6AH-45251-00 | 169 | TEN01175 | 6AW-1132T-00 | 73-167-169 |
| TEN01132 | 63D-45251-10 | 163 | TEN01154AL | 6AH-45251-00 | 65-165 | TEN01176 | 6AW-1132M-00 | 167-169 |
| TEN01132 | 67C-45251-00 | 163 | TEN01155 | 6AW-45373-00 | 166-169 | TEN01177 | 6AW-1132P-00 | 73-168-169-214 |
| TEN01132 | 63D-45251-10 | 169 | TEN01155AL | 6AW-45373-00 | 166-169 | TENKITYAMAHA150-200 | | 168 |
| TEN01133 | 6J9-45371-01 | 165-169 | TEN01156 | 68V-11325-02 | 72-167 | TENKITYAMAHA150-200C | | 168 |
| TEN01133AL | 6J9-45371-01 | 165-169 | TEN01156AL | 68V-11325-01 | 72-167 | TENKITYAMAHA200-250 | | 168 |
| TEN01134 | 6K1-45371-02 | 165-169 | TEN01156-1 | 68V-11325-01 | 167 | TENKITYAMAHA200-300 | | 168 |
| TEN01135 | 61N-45251-01 | 163-169 | TEN01156/1AL | 68V-11325-01 | 167 | TENKITYAMAHA40-60 | | 168 |
| TEN01135AL | 61N-45251-01 | 163-169 | TEN01157 | 6U0-45251-00 | 165-169 | TENKITYAMAHA60-90 | | 168 |
| TEN01136 | 66M-45371-00 | 65-164-169 | TEN01158 | 6U4-45373-00 | 166-169 | TRI305-0386 | | 74 |
| TEN01137 | 6G8-45251-00 | 164-169 | TEN01159 | 6U4-45251-00 | 167-169 | TRI305-0566 | | 74 |
| TEN01138 | 6AV-45251-00 | 164 | TEN01160T | N51-11325-01 | 167 | | | |
| TEN01138 | 6V3-45251-01 | 164 | | | | | | |

RO / OEM --> REF

| R.O. / OEM | REF | R.O. / OEM | REF | R.O. / OEM | REF | | | |
|-----------------|--------------------|---------------------------------|-----------------|----------------------|-----------------------------|-----------------|------------------|----------------------|
| 137-11633-10 | PAF20-05020003 | 189-219 | 60V-81960-03 | REC60V-81960-05 | 117 | 61A-45634-01 | REC61A-45634-01 | 331-337-341-383 |
| 30X-12117-00 | PAF15-07040006 | 189-193-195-199-201-203-207 | 60V-81960-04 | REC60V-81960-05 | 117 | 61A-45635-00 | REC61A-45635-00 | 331-335-337-341-383 |
| 30X-12117-00 | PAF15-07050006 | 185 | 60V-81960-05 | REC60V-81960-05 | 117 | 61A-45641-02 | REC61A-45641-02 | 331-337-383 |
| 30X-12118-00 | PAF15-07040007 | 185-189-193-195-199-201-203-207 | 60W-45300-20-8D | REC428-A25 | 281 | 61A-81800-00 | PH130-0059 | 110 |
| 3FV-13440-00 | REC3FV-13440-00 | 83 | 60X-44315-A0 | REC60X-44315-A0 | 339-386 | 61A-81800-01 | PH130-0059 | 110 |
| 3FV-13440-10 | REC3FV-13440-00 | 83 | 60X-81800-00 | PH130-0076 | 112 | 61A-81800-01 | PH130-0059 | 110 |
| 3FV-13440-20 | REC3FV-13440-00 | 83 | 60X-W0078-00 | REC60X-W0078-00 | 153-157-386 | 61A-81941-00 | REC61A-81941-00 | 110-114 |
| 3FV-13440-30 | REC3FV-13440-00 | 67-83 | 612-45611-00 | REC612-45611-00 | 295 | 61A-81950-00 | REC61A-81950-01 | 115 |
| 3YF-12113-00 | PAF20-05030004 | 189 | 61A-11193-A2 | REC61A-11193-A2 | 255 | 61A-81950-01 | REC61A-81950-01 | 115 |
| 41106-ZW-000 | CM41106-ZW000 | 158 | 61A-11325-00 | CM61A-11325-00 | 161 | 61A-81960-00 | REC61A-81960-04 | 117 |
| 50M-14355-00 | REC50M-14355-00 | 99 | 61A-11325-00 | TEN01168 | 163 | 61A-81960-01 | REC61A-81960-04 | 117 |
| 51Y-12114-00 | PAF25-05050005 | 193-195-199-201-203-207 | 61A-11381-A0 | REC61A-11381-A0 | 276 | 61A-81960-02 | REC61A-81960-04 | 117 |
| 51Y-12119-00 | PA166F-010003 | 173-180-189-195-201 | 61A-11650-00 | REC61A-11650-00 | 261 | 61A-81960-03 | REC61A-81960-04 | 117 |
| 51Y-12119-00 | PAF166-010003 | 179-193 | 61A-12414-A0 | REC61A-12414-A0 | 138-231 | 61A-81960-04 | REC61A-81960-04 | 117 |
| 51Y-12119-00 | PAPS2700.04.03 | 175-185-199-203-205-207-213 | 61A-13411-00 | REC61A-13411-00 | 83 | 61A-85885-00 | REC6X2-85885-10 | 103 |
| 5GH-13440-00 | PAF15-07010023 | 183 | 61A-13621-A0 | REC61A-13621-A0 | 276 | 61A-W0001-A1 | REC61A-W0001-01 | 252-254 |
| 5GH-13440-00 | PAF25-05000100 | 191 | 61A-13645-00 | REC61A-13645-00 | 276 | 61A-W0078-01 | REC61A-W0078-A1 | 153 |
| 5GH-13440-00 | REC5GH-13440-00 | 83-183-191-197-209 | 61A-13646-00 | REC61A-13646-00 | 276 | 61A-W0078-A1 | REC61A-W0078-A1 | 328-383 |
| 5GH-13440-10 | REC5GH-13440-00 | 207 | 61A-24563-00 | REC61A-24563-00 | 81-82 | 61A-W0078-A3 | REC61A-W0078-A1 | 71-72-155-157-333 |
| 5GH-13440-20 | REC5GH-13440-60 | 195-203 | 61A-43811-00 | REC48630-92J00 | 125 | 61A-W0093-01 | REC61A-W0093-01 | 97 |
| 5GH-13440-30 | REC5GH-13440-00 | 83 | 61A-43821-01 | REC48630-94900 | 125 | 61B-82510-01 | REC61B-82510-02 | 113 |
| 5GH-13440-50 | REC5GH-13440-60 | 83-201-205 | 61A-43821-01 | REC48630-94900 | 125 | 61H-81800-00 | PH130-0051 | 110 |
| 5GH-13440-60 | REC5GH-13440-60 | 65-66-67-68-69-83-187 | 61A-43880-00 | PH200-T050 | 124 | 61H-81800-01 | PH130-0051 | 110 |
| 5GH-13440-70 | REC5GH-13440-00 | 65-66-67-68-69-70-71-83 | 61A-43880-01 | PH200-T050 | 124 | 61N-11181-A1 | REC61N-11181-00 | 229 |
| 6AW-81800-00 | REC6AW-81800-00 | 112 | 61A-44311-00 | REC61A-44311-00 | 155-156-157-385 | 61N-11181-A2 | REC61N-11181-00 | 248-254 |
| 6CB-81800-00/01 | REC6CE-81800-01 | 112 | 61A-44311-01 | REC61A-44311-00 | 325-329-333-339-377-381-386 | 61N-11515-00 | REC61N-11515-00 | 229 |
| 6CB-82310-00 | REC6CB-82310-00 | 106 | 61A-45113-A0 | REC61A-45113-A0 | 386 | 61N-11603-00 | REC61N-11603-00 | 229-263-266 |
| 6CE-81800-00/01 | REC6CE-81800-01 | 112 | 61A-45214-10 | REC61A-45214-10 | 383 | 61N-11604-00 | REC61N-11604-00 | 229-263 |
| 6D8-24560-08/09 | REC6D8-24560-08 | 80-81 | 61A-45214-11 | REC61A-45214-10 | 331 | 61N-11605-00 | REC61N-11605-00 | 229-263 |
| 60E-81950-00 | REC60E-81950-00 | 115 | 61A-45215-10 | REC61A-45215-10 | 383 | 61N-11631-00-95 | REC61N-11631-00K | 229-263-266 |
| 60H-12416-00 | REC60H-12416-00 | 245-247 | 61A-45215-11 | REC61A-45215-10 | 331 | 61N-11635-00 | REC61N-11635-00K | 229-263 |
| 60R-12113-00 | PAF6-04050003 | 179 | 61A-45321-01 | REC61A-45321-01 | 333-385 | 61N-11636-00 | REC61N-11636-00K | 229-263 |
| 60R-E2414-A0 | REC6G8-12414-A0 | 180 | 61A-45331-00-94 | REC61A-45331-00-94 | 333-385-386 | 61N-14198-00 | REC61N-14198-00 | 274 |
| 60R-G6241-00 | REC68T-46241-00 | 180 | 61A-45371-00 | CM61A-45371 | 160-169-383 | 61N-14301-04 | REC61N-14301-04 | 91-93 |
| 60V-11181-00 | REC60V-11181-00 | 249-254 | 61A-45371-00 | CM61A-45371-00A | 160-169-331-335-337 | 61N-24521-00 | PAF15-07080002 | 80 |
| 60V-12411-00 | REC60V-12411-00 | 70-137 | 61A-45371-00 | TEN01124 | 165-169 | 61N-24560-00 | PAF15-07080000 | 80 |
| 60V-13621-A0 | REC60V-13621-A0 | 276 | 61A-45371-00 | TEN01124AL | 165-169 | 61N-24563-00 | REC61N-24563-10 | 80 |
| 60V-13645-00 | REC60V-13645-00 | 276 | 61A-45376-00 | REC61A-45376-00-94 | 333-339 | 61N-24563-10 | REC61N-24563-10 | 65-66-68-69-80-81-82 |
| 60V-13907-00 | REC60V-13907-00 | 86 | 61A-45376-00-94 | REC61A-45376-00-94 | 341-385 | 61N-26311-00 | REC61N-26311-00 | 130 |
| 60V-24251-01 | REC60V-24251-01 | 82 | 61A-45501-20 | REC61A-45501-20 | 385 | 61N-44146-00 | REC61N-44146-00 | 361 |
| 60V-43880-00 | PH200-T069 | 123 | 61A-45501-30 | REC61A-45501-30 | 385 | 61N-44311-01 | PAF25-04050000 | 297 |
| 60V-44150-00 | REC60V-44150-00 | 385 | 61A-45527-00 | REC61A-45527-00 | 325-329-333-377-381-385 | 61N-44311-01 | PAF25-04050001 | 148-154-155-297-355 |
| 60V-45113-02 | REC60V-45113-02 | 254 | 61A-45538-00 | REC61A-45538-00 | 325-329-333-377-381-385 | 61N-44322-00 | REC61N-44322-00 | 154-155-297-355 |
| 60V-45300-20-8D | REC421-A25 | 281 | 61A-45567-00 | REC61A-45567-00/60-0 | 331-337 | 61N-44323-00 | REC61N-44323-00 | 149-154-155-297-355 |
| 60V-45332-00-94 | REC60V-45332-00-94 | 383 | 61A-45577-00 | REC61A-45577-00/60-0 | 331-337 | 61N-44362-10 | PAF25-04000017S | 297-355 |
| 60V-45611-00 | REC60V-45611-00 | 383 | 61A-45587-00 | REC61A-45587-00/60-0 | 333-339 | 61N-44362-10 | PAF25-04000017 | 297-355 |
| 60V-81800-00 | PH130-0076 | 112 | 61A-45587-00/60 | REC61A-45587-00/60-0 | 385 | 61N-45127-00 | PAF25-04000021 | 297-355 |
| 60V-81950-00 | REC60V-81950-00 | 115 | 61A-45632-00 | REC61A-45632-00 | 331-337-383 | 61N-45214-00 | PAF25-04000021 | 295 |
| 60V-81960-00 | REC60V-81960-05 | 117 | 61A-45633-00 | REC61A-45633-00 | 331-337-383-392 | 61N-45251-00 | PAF15-06000004 | 295 |
| 60V-81960-01 | REC60V-81960-05 | 117 | | | | 61N-45251-01 | CM61N-45251-01 | 160-169-291-351-355 |
| 60V-81960-02 | REC60V-81960-05 | 117 | | | | 61N-45251-01 | CM61N-45251-01A | 65-66-160-169 |
| | | | | | | 61N-45251-01 | TEN01135 | 163-169 |
| | | | | | | 61N-45311-02-4D | TEN01135AL | 163-169 |
| | | | | | | | PAF25-04000001 | 295 |

| R.O. / OEM | REF | | R.O. / OEM | REF | | R.O. / OEM | REF | |
|-----------------|------------------|-------------------------------------|-----------------|--------------------|---------------------------------------|-----------------|--------------------|-------------------------|
| 61N-45315-00 | PAF25-04000009 | 297-355 | 62Y-43880-01 | PH200-T036 | 122 | 63P-14984-00 | REC63P-14984-00 | 71-86-88 |
| 61N-45361-01-4D | PAF25-04070001 | 295-355 | 62Y-43880-02 | PH200-T036 | 122 | 63P-15312-00 | REC63P-15312-00 | 272 |
| 61N-45361-01-8D | PAF25-04070000 | 295-388-389 | 62Y-44151-00 | PAF60-04000003 | 303-307-311 | 63P-41114-A1 | REC63P-41114-A3 | 211 |
| 61N-45371-00 | TEN01130 | 165-355 | 62Y-44555-00 | REC670-44555-00-94 | 135 | 63P-4380003 | REC63P-43800-20 | 124 |
| 61N-45510-00 | PAF25-04010000S | 297 | 62Y-45127-00 | REC62Y-45127-00 | 268 | 63P-4380004 | REC63P-43800-20 | 124 |
| 61N-45510-00 | REC61N-45510-00 | 355-388-389 | 62Y-45571-00 | PAF60-04000500 | 311 | 63P-4380006 | REC63P-43800-20 | 124 |
| 61N-45510-10 | PAF25-04010000L | 297 | 62Y-45631-00 | PAF60-04020003 | 307-311 | 63P-4380007 | REC63P-43800-20 | 124 |
| 61N-45510-10 | REC61N-45510-10 | 355-388-389 | 62Y-46241-00 | REC62Y-46241-00 | 207-267 | 63P-438002D | REC63P-43800-20 | 124 |
| 61N-45536-00 | PAF25-04000002 | 297-355 | 62Y-82504-10 | PAF15-07010103 | 103 | 63P-43811-10 | REC48630-92J00 | 125 |
| 61N-45551-00 | PAF25-04000005 | 295 | 62Y-W0001-20 | REC62Y-W0001-22 | 146 | 63P-43811-20 | REC48630-92J00 | 125 |
| 61N-45551-00 | REC61N-45551-00 | 355-388-389 | 62Y-W0001-21 | REC62Y-W0001-22 | 146 | 63P-43880-03-00 | REC18-6865 | 124 |
| 61N-45560-00 | REC61N-45560-10 | 295 | 62Y-W0001-22 | REC62Y-W0001-22 | 146-306 | 63P-43880-10 | REC63P-43880-22 | 124 |
| 61N-45560-10 | REC61N-45560-10 | 355-388-389 | 633-11634-00 | REC634-11634-00 | 233-263 | 63P-43880-11 | REC63P-43880-22 | 124 |
| 61N-45571-00 | PAF25-04070004 | 295 | 633-85518-00 | REC663-85518-00 | 133 | 63P-43880-12 | REC63P-43880-22 | 124 |
| 61N-45571-00 | REC61N-45570-00 | 355-388-389 | 634-11633-00 | PAF15-07020006 | 183-219 | 63P-43880-22 | REC63P-43880-22 | 124 |
| 61N-45587-00-10 | PAF25-04000003-2 | 297 | 634-11633-00 | REC634-11633-00 | 227-260-262 | 63P-45300-00-8D | REC416-B20F | 278 |
| 61N-45587-00-11 | PAF25-04000003-3 | 297 | 63AH-61350-00 | PAF20-07000100W | 131 | 63P-45300-02-8D | REC416-B20F | 327 |
| 61N-45587-00-12 | PAF25-04000003-4 | 297 | 63D-11181-A2 | REC63D-11181-A1 | 237-248-254 | 63P-45300-10-8D | REC416-B25F | 278 |
| 61N-45587-00-13 | PAF25-04000003-5 | 297 | 63D-11193-A0 | REC63D-11193-A0 | 237-255 | 63P-45300-12-8D | REC416-B25F | 327 |
| 61N-45587-00-14 | PAF25-04000003-6 | 297 | 63D-11603-00 | REC63D-11603-00 | 237-263 | 63P-45501-00 | REC63P-45501-00 | 329-333 |
| 61N-45587-00-15 | PAF25-04000003-7 | 297 | 63D-11605-00 | REC63D-11605-00 | 237-263 | 63P-45501-10 | REC63P-45501-10 | 329-333 |
| 61N-85540-00 | REC61N-85540-00 | 119 | 63D-44144-00 | PA60-04000004 | 305-309-313 | 63P-45551-00 | REC63P-45551-00 | 327 |
| 61N-85570-00 | REC61N-85570-01 | 105 | 63D-44311-00 | REC63D-44311-01 | 148-156-309-313 | 63P-45987-00 | REC6E5-45987-00 | 323-327 |
| 61N-85570-01 | REC61N-85570-01 | 105 | 63D-44312-00 | REC63D-44312-00 | 301-305-309-313-317-361 | 63P-46241-00 | REC63P-46241-00 | 211-267 |
| 61N-W0001-E1 | REC61N-W0001-E1 | 145-354 | 63D-44316-00 | REC63D-44316-00 | 301-305-309-313-361 | 63P-81800-00 | PH130-0073 | 112 |
| 61N-W0078-10 | REC61N-W0078-11 | 150 | 63D-44322-00 | REC63D-44322-00 | 301-305-309-313-361 | 63P-81950-00 | REC63P-81950-00 | 115 |
| 61N-W0078-11 | REC61N-W0078-11 | 154-155-297-354 | 63D-44323-00 | REC63D-44323-00 | 154-156-301-305-309-313-361 | 63P-81960-00 | REC63P-81960-02 | 116 |
| 61N-W0093-00 | REC61N-W0093-00 | 93-96-229 | 63D-44323-00-00 | REC63D-44323-00 | 149 | 63P-81960-01 | REC63P-81960-02 | 116 |
| 61P2-W0078-00 | REC6P2-W0078-00 | 336 | 63D-44341-00 | REC63D-44341-00 | 301-309-361 | 63P-81960-02 | REC63P-81960-02 | 116 |
| 61T-11193-A1 | REC61T-11193-A0 | 229-255 | 63D-45114-A0 | REC63D-45114-A0 | 272 | 63P-82380-00 | REC63P-82380-00 | 90-102 |
| 61T-45113-A0 | REC61T-45113-A0 | 253-254 | 63D-45123-00 | REC63D-45123-00 | 269 | 63P-85886-00 | REC13650-52G00 | 102 |
| 61T-W0001-02 | REC61T-W0001-02 | 229-250-254-266-267 | 63D-45214-00 | PAT40-04000022 | 299-303-307-311 | 63V-11181-A1 | REC63V-11181-A1 | 248 |
| 624-14485-00 | PAT15-04010202 | 235 | 63D-45215-00 | PAT40-04000023 | 299-303-307-311 | 63V-11181-A2 | REC63V-11181-A1 | 227-254 |
| 624-14485-00 | REC624-14485-00 | 221-225-227-231-233-237-239-241-243 | 63D-45251-00 | TEN01131 | 165-169 | 63V-11412-00 | REC63V-11412-00 | 227-256 |
| 624-24634-00 | PAF4-04120103 | 75 | 63D-45251-01 | CM63D-45251-01 | 159-169 | 63V-11422-00 | REC63V-11422-00 | 227-256 |
| 626-14390-90 | REC626-14390-90 | 98 | 63D-45251-01 | TEN01131 | 165 | 63V-11432-00 | REC63V-11432-00 | 227-256 |
| 626-44365-01 | REC626-44365-01 | 349-353 | 63D-45321-00 | PAF60-04000101 | 305-309-313 | 63V-11442-00 | REC63V-11442-00 | 227-256 |
| 626-45316-09 | REC626-45316-09 | 291-292-349 | 63D-45344-00 | PAF60-04000008 | 313 | 63V-11445-00 | REC63V-11445-00 | 227 |
| 626-45577-00 | PAF15-06080006-1 | 293-351 | 63D-45344-00 | PAF60-04000008 | 313 | 63V-11515-02 | REC63V-11515-02 | 227 |
| 626-45577-00-01 | PAF15-06080006-1 | 291-349 | 63D-45361-02-4D | REC63D-45361-02-4D | 299-307-361 | 63V-14126-00 | REC63V-14126-00 | 94 |
| 626-45577-00-03 | PAF15-06080006-3 | 349 | 63D-45361-02-8D | PAF60-04030000 | 307-311 | 63V-14301-00 | REC63V-14301-00 | 93 |
| 626-45577-00-05 | PAF15-06080006-5 | 349 | 63D-45361-02-8D | PAF60-04030000 | 303-311-389-390 | 63V-14984-00 | REC63V-14984-00 | 94 |
| 626-45577-10 | PAF15-06080006-2 | 293 | 63D-45375-00 | PAT40-04000014 | 301-305-309-313 | 63V-14985-00 | REC63V-14985-00 | 93-100 |
| 626-45577-20 | PAF15-06080006-3 | 293 | 63D-45375-00 | REC688-45375-00 | 317-321-325 | 63V-15396-01-CA | REC63V-15396-01-CA | 227 |
| 626-45577-30 | PAF15-06080006-4 | 293 | 63D-45577-10 | PAT40-04060005-2 | 299-303-307-311 | 63V-15713-00 | PAF15-07130107 | 112 |
| 626-45577-40 | PAF15-06080006-5 | 293 | 63D-45577-20 | PAT40-04060005-3 | 299-303-307-311 | 63V-15714-00 | PAF15-07130201 | 113 |
| 62P-14984-00 | REC6P2-14984-00 | 72-73-86-88 | 63D-45577-30 | PAT40-04060005-4 | 299-303-307-311 | 63V-15716-00 | PAF15-07130001 | 113 |
| 62X-43880-00 | PH200-T035 | 122 | 63D-45577-40 | PAT40-04060005-5 | 299-303-307-311 | 63V-15741-00 | PAF15-07130002 | 112 |
| 62X-43880-01 | PH200-T035 | 122 | 63D-45577-60 | PAT40-04060005-7 | 299-303-307-311 | 63V-15741-00 | PAF15-07130202 | 112 |
| 62X-43880-09 | PH200-T035 | 122 | 63D-45611-00 | PAF60-04020001 | 303-307-311 | 63V-15767-00 | PAF15-07130203 | 112 |
| 62Y-11325-00 | CM62Y-11325-00 | 158 | 63D-45635-00 | PAF60-04020005 | 303-307-311 | 63V-15784-00 | PAF15-07130204 | 112 |
| 62Y-11325-00 | CM62Y-11325-00A | 65-66-67-68-69-158-197-203-205-207 | 63D-85540-00 | REC63D-85540-04 | 118 | 63V-17411-00-1S | REC63V-41111-00-1S | 227 |
| 62Y-11325-00 | PAF25-02010005 | 191 | 63D-85540-01 | REC63D-85540-04 | 118 | 63V-41112-A0 | REC63V-41112-A0 | 140-227 |
| 62Y-11325-00 | TEN01149 | 163 | 63D-85540-02 | REC63D-85540-04 | 118 | 63V-41113-00-1S | REC63V-41113-00-1S | 227 |
| 62Y-11372-01 | PAF25-05010113 | 191 | 63D-85540-03 | REC63D-85540-04 | 118 | 63V-41133-A1 | REC63V-41133-A1 | 268 |
| 62Y-11416-00 | PAF25-05010302-1 | 193-199 | 63D-85540-04 | REC63D-85540-04 | 118 | 63V-43111-00-4D | PAF15-01010100 | 131 |
| 62Y-11416-10 | PAF25-05010302-2 | 193-199 | 63D-85540-05 | REC63D-85540-04 | 118 | 63V-43111-01-4D | PAF15-01010100 | 131 |
| 62Y-11633-00 | PAF25-05020105 | 193-199-199-201-203-205-207-219 | 63D-W0001-00 | REC63D-W0001-00 | 237-251-254-68-69-151-154-156-306-310 | 63V-43111-A2-4D | PAF15-01010100 | 131 |
| 62Y-11650-10 | PAF25-05020200 | 199 | 63D-W0078-01 | REC63D-W0078-01 | 211-215-218 | 63V-43112-00-4D | PAF15-01010200 | 131 |
| 62Y-11654-00 | PAF25-05020204 | 193-199 | 63P-11181-00 | REC63P-11181-00 | 161 | 63V-43131-00 | PAF15-01010001 | 132 |
| 62Y-11656-00 | PAF25-05020203-1 | 193-199 | 63P-11325-00 | CM63P-11325-01 | 161 | 63V-43131-10 | PAF15-01010001 | 132 |
| 62Y-11656-00 | PAF25-05020203-2 | 193 | 63P-11325-01 | CM63P-11325-01A | 161 | 63V-43145-00 | PAF15-01010007 | 132 |
| 62Y-11656-10 | PAF25-05020203-2 | 199 | 63P-11325-01 | CM63P-11325-01A | 161-211-214 | 63V-43311-00-4D | PAF15-01010301S | 131 |
| 62Y-12116-00 | PAF25-05030003 | 189 | 63P-11325-11 | CM63P-11325-11A | 71-73-161-211 | 63V-43311-01-4D | PAF15-01010301S | 131 |
| 62Y-12116-00 | PAF25-05050003 | 193-199-199-201-203-207 | 63P-11325-11-00 | TEN01164 | 166-169 | 63V-44150-00 | PAF15-06030000S | 291-351 |
| 62Y-12121-00 | PAF25-05050002 | 193-199-207 | 63P-11325-21-00 | TEN01165 | 70-71-211 | 63V-44150-10 | PAF15-06030000L | 291-351 |
| 62Y-12158-00 | PAF15-07040304 | 185-189-193-195-199-201-203-205-207 | 63P-11351-00 | REC63P-11351-01 | 211-218 | 63V-44301-00 | REC63V-44301-00 | 154-155 |
| 62Y-12159-00 | PAF15-07040303 | 185-193-199 | 63P-12414-00 | REC63P-12414-00 | 71-138-211 | 63V-44301-00-00 | REC63V-44301-00 | 147 |
| 62Y-12216-00 | PAF25-05050011 | 193-199-207 | 63P-12414-00 | REC63P-12414-00 | 90 | 63V-44322-00 | REC63V-44322-00 | 154-155-289-291-293-351 |
| 62Y-12231-00 | PAF25-05050012 | 193-207 | 63P-13761-00 | REC63P-13761-01 | 90 | 63V-44323-00-00 | REC63V-44323-00 | 351 |
| 62Y-12238-00 | PAF25-05050009 | 193-207 | 63P-13761-01 | REC63P-13761-01 | 90 | 63V-44328-00 | REC63V-44323-00 | 149 |
| 62Y-12279-00 | PAF40-05040003 | 207 | 63P-13906-00 | REC63P-13906-01 | 89-90 | 63V-44338-00 | PAF15-06000014 | 289-291-351 |
| 62Y-12414-00 | PAF15-07010022 | 66-67-68-69-138-183-191-195-197-201 | 63P-13907-00 | REC63P-13907-03 | 86 | 63V-44352-01 | PAF15-06000014 | 293 |
| 62Y-12414-00 | REC6H3-12414-A1 | 203-205-207 | 63P-13907-01 | REC63P-13907-03 | 86 | 63V-44352-01 | REC664-44338-00 | 351 |
| 62Y-12481-10 | PAF25-05010113 | 203-205 | 63P-13907-02 | REC63P-13907-03 | 86 | 63V-44352-01 | CEF500363 | 143 |
| 62Y-14392-00 | REC61N-14392-00 | 93-98 | 63P-13907-03 | REC63P-13907-03 | 86 | 63V-44352-01 | REC63V-44352-01 | 143-154-155-291-293-351 |
| 62Y-14485-00 | PAF20-05040005 | 195 | 63P-13915-00 | REC63P-13915-00 | 70-71-72-73-82 | 63V-44361-01 | REC63V-44361-01 | 351 |
| 62Y-14485-00 | PAF40-05070002 | 197-201-203-207 | | | | 63V-44361-11 | REC63V-44361-11 | 351 |
| 62Y-15312-00 | REC62Y-15312-00 | 271 | | | | 63V-44365-10 | | |

| R.O. / OEM | REF | R.O. / OEM | REF | R.O. / OEM | REF |
|-----------------|--------------------|-------------------------|-----------------|-----------------------|---------------------------------|
| 63V-45311-01-4D | PAF15-06000001 | 351 | 64D-14394-00 | REC64D-14394-00 | 99 |
| 63V-45315-A0 | REC63V-45315-A0 | 291-351 | 64D-45300-01-8D | REC416-A20 | 280 |
| 63V-45331-00-5B | REC63V-45331-00-5B | 291-351 | 64D-45300-02-8D | REC416-A20 | 379 |
| 63V-45375-00 | PAF15-06020005 | 289-291-292-351 | 64D-45300-21-8D | REC416-A25 | 280 |
| 63V-45510-00 | PAF15-06040000S | 291 | 64D-45300-22-8D | REC416-A25 | 379 |
| 63V-45510-01 | REC63V-45510-01 | 351-387-388 | 64D-W0093-00 | REC64D-W0093-00 | 97-247 |
| 63V-45510-11 | REC63V-45501-10 | 291-387-388 | 64E-13645-A0 | REC64E-13645-A0 | 276 |
| 63V-45510-11 | REC63V-45510-11 | 351-387-388 | 64E-43811-02 | REC48630-92J00 | 125 |
| 63V-45536-00 | PAF15-06000006 | 291-292-351 | 64E-43820-08 | REC48630-96J03 | 125 |
| 63V-45551-00 | REC63V-45551-00 | 291-293-351-387-388 | 64E-43820-08 | REC48630-96J03 | 125 |
| 63V-45551-00-4D | PAF15-00000001 | 132 | 64E-43820-09 | REC48630-96J03 | 125 |
| 63V-45943-10-00 | PAF15-06090000 | 402 | 64E-43821-00 | REC48630-96J03 | 125 |
| 63V-61350-00 | PAF15-11020000W | 131 | 64E-43821-05 | REC48630-92J00 | 125 |
| 63V-85520-00 | REC63V-85520-00 | 106 | 64E-43821-09 | REC48630-96J03 | 125 |
| 63V-85533-00 | REC63V-85533-00 | 104 | 64E-43822-00 | REC64E-43822-00 | 125 |
| 63V-85540-00 | REC63V-85540-00-01 | 118-119 | 64E-4384J-00 | REC64E-4384J-00 | 125 |
| 63V-85540-01 | REC63V-85540-00-01 | 118-119 | 64E-43880-02-40 | REC18-6865 | 124 |
| 63V-85540-02 | REC63V-85540-00-01 | 118 | 64E-43880-02-40 | REC63P-43800-20 | 124 |
| 63V-85570-00 | REC63V-85570-00 | 105 | 64J-12159-00 | PAF15-07040303 | 189 |
| 63V-85580-01 | REC63V-85580-01 | 107 | 64J-24560-00 | REC64J-24560-10 | 80 |
| 63V-W0001-00 | REC63V-W0001-00 | 226 | 64J-24560-10 | REC64J-24560-10 | 80 |
| 63V-W0001-01 | REC63V-W0001-00 | 249-254 | 64J-W0001-20 | REC64J-W0001-20 | 145 |
| 63V-W0001-21 | REC63V-W0001-21 | 144 | 64J-W0001-21 | REC64J-W0001-21 | 146 |
| 63V-W0078-00 | REC63V-W0078-01 | 150 | 64K-45300-02-NA | REC416-B20 | 281 |
| 63V-W0078-01 | REC63V-W0078-01 | 65-154-155-290-350 | 64P-45300-10-8D | REC418-A25 | 280 |
| 63V-W0093-00 | REC63V-W0093-00 | 93-95-226 | 64P-45300-10-8D | REC418-B25F | 278 |
| 63V-W4311-00-4D | PAF15-01010200 | 131 | 64P-45300-12-8D | REC418-B25F | 327 |
| 63V-W4311-03-4D | PAF15-01010200 | 131 | 650-11370-01 | REC650-11370-00 | 231 |
| 63V-WS431-B6-8D | PAF15-01010200 | 131 | 650-11370-01 | REC650-11370-00 | 225-235-237-239-241-243 |
| 63V-13610-00 | REC63W-13610-00 | 92-99 | 650-11651-00 | REC650-11651-04 | 227-260 |
| 646-11633-00 | REC646-11633-00 | 220 | 650-14385-00 | REC650-14385-01 | 100 |
| 646-11651-00 | REC648-11651-00 | 260-261 | 650-14485-03 | REC650-14485-03 | 227 |
| 646-11651-02 | REC646-11651-02 | 220-260 | 650-24351-00 | REC650-24351-01 | 75 |
| 646-11681-00 | REC646-11681-00 | 220-260 | 650-24351-01 | REC650-24351-51 | 75 |
| 646-14623-A1 | REC646-14623-A1 | 220-254-270 | 650-24351-50 | REC650-24351-51 | 75 |
| 646-24251-01 | PAF4-05000300 | 80 | 650-24351-51 | REC650-24351-51 | 75 |
| 646-24251-01 | REC35-80365M | 80 | 650-24378-00 | PAF4-04010102 | 173-175-177-179-180-235-237-241 |
| 646-24251-02 | PAF4-05000300 | 64-80-81 | 650-24431-A0 | REC650-24431-A0 | 88 |
| 646-24251-02 | REC35-80365M | 80-82-83 | 650-44147-00 | REC650-44147-00 | 134-363-367 |
| 646-44322-00 | REC646-44322-00 | 343 | 650-45635-00 | REC650-45635-00 | 291-293-349-351 |
| 646-44323-00 | REC646-44322-00 | 343 | 655-12414-A1 | REC655-12414-A1 | 138-229 |
| 646-44323-00 | REC646-44323-00 | 148-155 | 65E-85570-00 | REC63V-85570-00 | 105 |
| 646-44352-01 | CEF500324 | 143 | 65F-42537-00 | PAF15-01000001 | 133 |
| 646-44352-01 | REC646-44352-01 | 143-155-343 | 65L-13645-00 | REC65L-13645-00 | 275 |
| 646-44365-00 | REC646-44365-00 | 343 | 65L-13646-00 | REC65L-13646-00 | 275 |
| 646-44366-01 | REC646-44366-01 | 343 | 65L-13761-00 | REC65L-13761-00 | 89-90 |
| 646-45534-00-03 | PAF2.6-03000017 | 343 | 65L-13907-00 | REC6AW-14984-00 | 86 |
| 646-45551-00 | REC646-45551-00 | 343-387 | 65L-24563-00 | REC65L-24563-00 | 71-72-81-82 |
| 646-45560-00 | REC646-45560-00 | 343-387 | 65L-85886-00 | REC13650-56B00 | 102 |
| 647-11610-00 | REC647-11610-00 | 225-262-266 | 65N-45321-00 | REC65N-45321-00 | 335 |
| 647-11610-10 | REC647-11610-10 | 225 | 65N-W0078-A1 | REC65N-W0078-A1 | 152-157 |
| 647-11610-20 | REC647-11610-20 | 225 | 65W-08M87 | PAGB/T5782-M8X35 | 191 |
| 647-14323-00 | REC647-14323-00 | 98 | 65W-11111-02-94 | PAF25-05050100 | 191 |
| 647-14323-00 | REC6G1-14985-00 | 93-100 | 65W-11119-00 | PAF25-05010106 | 197 |
| 647-14385-00 | REC647-14385-00 | 100 | 65W-11168-00 | PAF25-05010103 | 191 |
| 647-14386-10 | REC647-14386-10 | 99 | 65W-11169-00 | PAF25-05010108 | 191 |
| 647-44366-00 | REC647-44366-00 | 154-155-291-346-347-351 | 65W-11181-30 | PAF25-05040000 | 191-215-218 |
| 647-45316-09 | REC647-45316-09 | 347 | 65W-11191-00-94 | PAF25-05000005 | 191 |
| 647-45551-00 | REC647-45551-00 | 347-387 | 65W-11351-00 | PAF25-00000013 | 191 |
| 647-45560-00 | REC647-45560-00 | 347-387 | 65W-11351-10 | PAF25-00000013 | 217-218 |
| 647-45570-01 | REC647-45570-01 | 347-387 | 65W-11356-00 | PAF25-05000004 | 191 |
| 647-45943-00-EL | SOL3011-090-07-P | 402 | 65W-11411-01 | PAF25-05002001 | 193-219 |
| 648-11633-00 | REC648-11633-00 | 237-260-261-263-264 | 65W-11476-00 | PAF25-05000022 | 193-199 |
| 648-13621-A1 | REC648-13621-A0 | 273 | 65W-11536-10 | PAF25-05000021 | 193-199 |
| 648-13645-A0 | REC648-13645-A0 | 273 | 65W-11537-01 | PAF25-05050017 | 193 |
| 648-14198-A0 | REC648-14198-A0 | 274 | 65W-11631-00-96 | PAF25-05020100 | 193-199-219 |
| 648-14384-01 | REC648-14384-01-00 | 94 | 65W-11631-00-96 | PAF25-05020101 | 193-199 |
| 648-14385-00 | REC648-14385-00 | 100 | 65W-11642-11 | PAF25-05020301 | 193 |
| 648-24411-00 | REC648-24411-00 | 87 | 65W-11665-00 | PAF25-05020310 | 193 |
| 648-24434-01 | REC648-24434-01 | 88 | 65W-12146-00 | PAF25-05050008 | 193 |
| 648-24435-02 | REC648-24435-02 | 88 | 65W-12151-00 | PAF25-05050300 | 193 |
| 648-44146-00 | REC648-44146-00 | 134 | 65W-12151-00 | PAF25-05050301 | 193-199 |
| 648-45633-00 | REC648-45633-00 | 291-295-349-351-353-355 | 65W-12171-10 | PAF25-05050200 | 193 |
| 648-45633-11 | PAF25-04060000 | 295 | 65W-12228-00 | PAGB/T5783-M6X20 | 191 |
| 648-45633-11 | REC648-45633-00 | 293-387-388-389 | 65W-13286-00 | PAF25-05010107 | 191 |
| 648-45635-00 | REC648-45635-00 | 295-353-355 | 65W-13300-00 | PAF25-05050400 | 193 |
| 64D-11603-01 | REC64D-11603-01 | 245 | 65W-14457-10 | PAF25-05080004 | 268 |
| 64D-11603-02 | REC64D-11603-01 | 247-265 | 65W-14901-12 | PAF25-05070000 | 91 |
| 64D-11603-02 | REC64D-11603-01 | 266-267 | 65W-15100-00-94 | PAF25-05010000 | 191 |
| 64D-11603-04 | REC64D-11604-01 | 265 | 65W-15121-00 | PAF25-05000007 | 191 |
| 64D-11603-05 | REC64D-11605-01 | 265 | 65W-15663-00 | PAGB/T3452-1-97.5X1.8 | 191 |
| 64D-11604-01 | REC64D-11604-01 | 245-247 | 65W-24251-00 | REC40145 | 82 |
| 64D-11604-02 | REC64D-11604-01 | 247 | 65W-24251-10 | REC40145 | 80 |
| 64D-11605-01 | REC64D-11605-01 | 245 | 65W-41113-01-94 | PAF25-05010112 | 191 |
| 64D-11605-02 | REC64D-11605-01 | 247 | 65W-41114-00 | PAF25-05010111 | 141-191 |
| 64D-11631-02-90 | REC64D-11631-00K | 247-265-267 | 65W-42138-00 | PAF15-01030100 | 131 |
| 64D-11642-02-90 | REC64D-11642-00K | 247-265-267 | 65W-43800-00-4D | PAT40-10000000 | 124 |
| 64D-14384-01 | REC64D-14384-1 | 94 | 65W-43800-01-4D | PAT40-10000000 | 124 |
| | | | 65W-43800-02-4D | PAT40-10000000 | 124 |
| 65W-43800-03-4D | PAT40-10000000 | 124 | | | |
| 65W-43800-20-4D | PAT40-10000000 | 124 | | | |
| 65W-43800-21-4D | PAT40-10000000 | 124 | | | |
| 65W-43800-22-8D | PAT40-10000000 | 124 | | | |
| 65W-43800-23-8D | PAT40-10000000 | 124 | | | |
| 65W-43880-00 | PAT40-10020500 | 123 | | | |
| 65W-43880-01 | PAT40-10020500 | 123 | | | |
| 65W-44150-00 | PAF25-04030000S | 297 | | | |
| 65W-44150-10 | PAF25-04030000L | 297 | | | |
| 65W-44176-00 | PAF25-040900012 | 297 | | | |
| 65W-44328-00 | PAF25-04000016 | 297 | | | |
| 65W-44361-00 | PAF25-02000004S | 297 | | | |
| 65W-44361-10 | PAF25-02000004L | 297 | | | |
| 65W-45251-00 | TEN01123 | 164-169 | | | |
| 65W-45251-00 | TEN01123AL | 164-169 | | | |
| 65W-45300-00-4D | PAF25-04090000S | 295 | | | |
| 65W-45300-01-4D | PAF25-04090000L | 278 | | | |
| 65W-45300-01-4D | PAF25-04090000S | 278 | | | |
| 65W-45300-10-4D | PAF25-04090000L | 295 | | | |
| 65W-45331-00-5B | PAF25-04000008 | 297 | | | |
| 65W-46241-00 | REC65W-46241-00 | 193-199-267 | | | |
| 65W-61350-00 | PAF25-07000300W | 131 | | | |
| 65W-81800-00 | PH130-0029 | 111 | | | |
| 65W-81800-01 | PH130-0029 | 111 | | | |
| 65W-81800-02 | PH130-0029 | 111 | | | |
| 65W-81800-03 | PH130-0029 | 111 | | | |
| 65W-81941-00 | PH375-0034 | 111-114 | | | |
| 65W-81941-00 | PH375-0036 | 110 | | | |
| 65W-82504-00 | PAF15-07010103 | 103 | | | |
| 65W-82575-01 | REC65W-82575-01 | 120 | | | |
| 65W-85510-10 | PAF25-05140000 | 121 | | | |
| 65W-85550-01 | PAF25-05150000 | 109 | | | |
| 65W-85570-01 | PAF25-05120000 | 104 | | | |
| 65W-85580-00 | PAF25-05110000 | 107 | | | |
| 65W-85790-00 | PAF25-05010201 | 103 | | | |
| 65W-W0001-00 | REC65W-W0001-00 | 217 | | | |
| 65W-W0001-02 | REC65W-W0001-00 | 190- | | | |
| 65W-W0001-02 | REC65W-W0001-00 | 218 | | | |
| 65W-W0001-20 | REC65W-W0001-20 | 145-297 | | | |
| 65W-W0093-02 | REC8542561 | 95-190-197 | | | |
| 661-41262-01 | PAF15-07000016 | 100 | | | |
| 661-41262-02 | PAF15-07000016 | 100 | | | |
| 662-44352-01 | CEF500321 | 143 | | | |
| 662-44352-01 | REC662-44352-01 | 143-347 | | | |
| 663-11193-A0 | REC663-11193-00 | 239-255 | | | |
| 663-11411-01 | REC663-11411-00 | 239-256 | | | |
| 663-11561-00 | REC663-11561-00 | 239 | | | |
| 663-11633-00 | REC663-11633-00 | 239-243-260-261-264 | | | |
| 663-11634-00 | REC663-11634-00 | 235-263 | | | |
| 663-12414-A0 | REC663-12414-00 | 138-239 | | | |
| 663-12416-00 | REC663-12416-00 | 235-239 | | | |
| 663-13621-A0 | REC663-13621-00 | 275 | | | |
| 663-14198-A0 | REC663-14198-00 | 275 | | | |
| 663-14483-A0 | REC663-14483-A0 | 275 | | | |
| 663-14548-00 | REC663-14548-00 | 99 | | | |
| 663-14923-00 | REC663-14923-00 | 99 | | | |
| 663-24411-00 | REC663-24411-00 | 87 | | | |
| 663-41114-A0 | REC663-41114-00 | 142-239 | | | |
| 663-42138-00 | REC663-42138-00 | 129 | | | |
| 663-43118-01-4D | REC663-43118-01-4D | 134 | | | |
| 663-44144-01 | REC663-44144-01 | 369-371 | | | |
| 663-44151-00 | REC663-44151-00 | 369-371 | | | |
| 663-443 | | | | | |

| R.O. / OEM | REF | | R.O. / OEM | REF | | R.O. / OEM | REF | |
|-----------------|------------------|-----------------------------|-----------------|-----------------|--|-----------------|--------------------|---|
| 663-45567-01-10 | PAT40-04000004-1 | 365 | 664-45987-00 | REC664-45987-00 | 353 | 66M-W0001-20 | REC66M-W0001-20 | 144-290 |
| 663-45567-01-12 | PAT40-04000004-2 | 365 | 664-81970-60 | REC6G1-81970-60 | 116 | 66M-W0093-01 | REC66M-W0093-01 | 95-182 |
| 663-45567-01-15 | PAT40-04000004-3 | 365 | 664-81970-61 | REC6G1-81970-62 | 116 | 66M-W009B-15-1S | PAF15-0700000 | 185 |
| 663-45567-01-30 | PAT40-04000004-5 | 365 | 664-81970-62 | REC6G1-81970-62 | 116 | 66N-11603-00 | REC66N-11603-00 | 183-219 |
| 663-45567-10 | PAT40-04000004-2 | 299-303-307-311 | 664-81970-63 | REC6G1-81970-62 | 116 | 66T-11181-A0 | REC66T-11181-A0 | 249 |
| 663-45567-20 | PAT40-04000004-3 | 299-303-307-311 | 665L-13915-00 | REC65L-13915-00 | 82 | 66T-11181-A2 | REC66T-11181-A2 | 233-254 |
| 663-45567-40 | PAT40-04000004-5 | 299-303-307-311 | 667-41114-A0 | REC66T-41114-A0 | 233 | 66T-11193-A0 | REC66T-11193-A0 | 233-255 |
| 663-45587-01 | PAT40-04000003-1 | 301-305-309-313 | 667-45551-00 | REC66T-45551-00 | 303 | 66T-11412-00 | REC66T-11412-00 | 233-256 |
| 663-45587-01-10 | PAT40-04000003-1 | 367 | 667-45571-00 | REC66T-45571-00 | 303 | 66T-11422-00 | REC66T-11422-00 | 233-256 |
| 663-45587-01-12 | PAT40-04000003-2 | 367 | 667-45997-00 | REC66T-45997-00 | 303-307-311 | 66T-11432-00 | REC66T-11432-00 | 233-256 |
| 663-45587-01-15 | PAT40-04000003-3 | 367 | 6689-W0001-C2 | REC689-W0001-C2 | 145 | 66T-11442-00 | REC66T-11442-00 | 233-256 |
| 663-45587-01-18 | PAT40-04000003-4 | 367 | 66G1-81941-10 | REC89-825096T01 | 114 | 66T-11603-00 | REC66T-11603-00 | 233-263-266 |
| 663-45587-01-30 | PAT40-04000003-5 | 367 | 66K-13907-00 | REC66K-13907-00 | 86 | 66T-11604-00 | REC66T-11604-00 | 233-263 |
| 663-45587-01-40 | PAT40-04000003-6 | 367 | 66K-13907-00 | REC6AW-14984-00 | 86 | 66T-11605-00 | REC66T-11605-00 | 233-263 |
| 663-45587-01-50 | PAT40-04000003-7 | 367 | 66K-13915-00 | REC66K-13915-00 | 82 | 66T-11631-01-93 | REC66T-11631-01K | 233-263-266 |
| 663-45587-10 | PAT40-04000003-2 | 301-305-309-313 | 66K-14984-00 | REC66K-14984-00 | 86-88 | 66T-11635-01 | REC66T-11635-01K | 233-263 |
| 663-45587-20 | PAT40-04000003-3 | 301-305-309-313 | 66K-45300-12-NA | REC421-A20 | 281 | 66T-11636-01 | REC66T-11636-01K | 233-263 |
| 663-45587-30 | PAT40-04000003-4 | 301-305-309-313 | 66K-45501-00 | REC66K-45501-00 | 385 | 66T-11681-00 | REC66T-11681-00 | 233-260-261 |
| 663-45587-40 | PAT40-04000003-5 | 301-305-309-313 | 66M-11111-01-1S | PAF15-07040000 | 185 | 66T-14301-60 | REC66T-14301-60 | 92-93 |
| 663-45587-50 | PAT40-04000003-6 | 301-305-309-313 | 66M-11168-001S | PAF15-07010200 | 183 | 66T-14384-01 | REC66T-14384-01 | 94 |
| 663-45587-60 | PAT40-04000003-7 | 301-305-309-313 | 66M-11181-10 | PAF15-07000100 | 185-215-218 | 66T-14536-01 | REC66T-14536-01 | 94 |
| 663-45631-01 | REC663-45631-00 | 359-363-365-369-389-390 | 66M-11191-00-1S | PAF15-07050001 | 185 | 66T-14992-00 | REC66T-14992-00 | 99 |
| 663-45633-00 | REC663-45633-00 | 359-361-363-365-369-389-390 | 66M-11325-00 | CM15008 | 159 | 66T-15713-00 | REC66T-15713-00 | 112 |
| 663-45634-00 | REC663-45634-00 | 303-307-311-359-363-365-369 | 66M-11325-00 | CM15008A | 159 | 66T-26301-00 | REC66T-26301-00 | 130 |
| 663-45941-01-EL | SOL3311-110-17 | 402 | 66M-11325-00 | PAF15-07010008 | 183 | 66T-41114-A0 | REC66T-41114-A0 | 141 |
| 663-45943-02-EL | SOL3311-110-15 | 402 | 66M-11325-00 | TEN01151 | 163 | 66T-41133-A0 | REC66T-41133-A1 | 269 |
| 663-45945-02-EL | SOL3311-111-13 | 402 | 66M-11327-00-94 | PAF15-07010011 | 168-183-191-197-203-205-207 | 66T-44311-00 | PAT40-04000201 | 148-301-305 |
| 663-45945-02-EL | SOL3311-111-13 | 402 | 66M-11328-00 | PAF15-07010009 | 65-66-67-68-69-183-191-197-203-205-207 | 66T-44323-00 | REC66T-44323-00 | 149-154-301-361 |
| 663-45947-02-EL | SOL3311-116-11 | 402 | 66M-11328-00 | PAGB/T97-1-8 | 193 | 66T-44514-00-4D | REC66T-44514-00-4D | 135 |
| 663-45949-01-EL | SOL3311-110-16 | 402 | 66M-11351-10 | PAF15-00000014 | 183-217 | 66T-45113-A0 | REC66T-45113-A0 | 233-253-254 |
| 663-45952-02-EL | SOL3311-114-12 | 402 | 66M-11351-10 | PAF15-00000014 | 233 | 66T-45114-A0 | REC66T-45114-A0 | 271 |
| 663-45954-01-EL | SOL3331-119-10 | 402 | 66M-11351-10 | PAF15-00000014 | 218 | 66T-45300-10-4D | PAF40-04000000L | 279 |
| 663-45956-01-EL | SOL3311-121-09 | 402 | 66M-11356-00 | PAF15-07050002 | 185 | 66T-45311-13-8D | PAF40-04000000L | 279 |
| 663-45958-01-EL | SOL3311-111-14 | 402 | 66M-11356-00 | PAGB/T97-1-8 | 191 | 66T-45321-00 | PAT40-04000007 | 301 |
| 663-45970-60-98 | SOL3331-114-12 | 402 | 66M-11357-00 | PAF15-07010014 | 183 | 66T-45344-01 | PAT40-04000009 | 301-305-309 |
| 663-45972-60-98 | SOL3331-116-11 | 402 | 66M-11411-00 | PAF15-07030000 | 183-219 | 66T-45501-01 | REC66T-45501-01 | 361-389 |
| 663-45987-00 | REC663-45987-00 | 365 | 66M-11416-00 | PAF15-07030000 | 183-219 | 66T-45501-11 | REC66T-45501-10 | 361-389-390 |
| 663-45987-02 | REC663-45987-00 | 299-303-307-311-359-361-369 | 66M-11416-00 | PAF15-07010024 | 183 | 66T-45551-00 | REC66T-45551-00 | 299-361-389-390 |
| 663-45987-02 | REC663-45987-00 | 405 | 66M-11536-10 | PAF15-07030003 | 185 | 66T-45560-01 | REC66T-45560-00 | 299-303-361-389-390 |
| 663-48344-00 | REC663-48344-00 | 127 | 66M-11537-00 | PAF15-07030003 | 185 | 66T-45571-00 | REC66T-45571-00 | 299-361-389-390 |
| 663-85540-11 | REC663-85540-15 | 119 | 66M-11537-00 | PAF15-07040018 | 185 | 66T-45611-00 | REC66T-45611-00 | 299-361-389-390 |
| 663-85540-15 | REC663-85540-15 | 119 | 66M-11537-00-94 | PAF15-07040018 | 185 | 66T-45631-00 | REC66T-45631-00 | 299-361-389-390 |
| 663-W0078-00 | REC663-W0078-01 | 152-368 | 66M-11557-00 | PAF15-07030004 | 185 | 66T-45635-00 | REC66T-45635-00 | 299-361 |
| 663-W0078-01 | REC663-W0078-01 | 151-156 | 66M-11631-00-96 | PAF15-07020001 | 183-219 | 66T-45997-00 | REC66T-45997-00 | 299-361-365-405 |
| 664-11325-00 | TEN01166 | 225 | 66M-11650-00 | PAF15-07020100 | 183 | 66T-82575-01 | REC66T-82575-01 | 120 |
| 664-41114-A0 | REC664-41114-A0 | 140 | 66M-12111-00 | PAF15-07040001 | 185 | 66T-85520-00 | REC66T-85520-00 | 106 |
| 664-41134-A0 | REC664-41134-A0 | 268 | 66M-12113-00 | PAF15-07040005 | 185 | 66T-85533-00 | REC66T-85533-00 | 104 |
| 664-44338-00 | REC664-44338-00 | 289-291-293-353 | 66M-12116-00 | PAF15-07040004 | 185 | 66T-85540-01 | REC66T-85540-00-01 | 119 |
| 664-44338-00 | REC664-44338-00 | 154-155 | 66M-12121-00 | PAF15-07040002 | 185 | 66T-85570-00 | REC66T-85570-00 | 105 |
| 664-45371-01 | CM664-45371-01 | 357-359-361 | 66M-12138-60 | PAF15-10030001 | 185 | 66T-85580-00 | REC66T-85580-00 | 107 |
| 664-45371-01 | CM664-45371-01 | 169 | 66M-12146-00 | PAF15-07040015 | 185-189 | 66T-W0001-01 | REC66T-W0001-01 | 233-250-254 |
| 664-45371-01 | TEN01100 | 164-169 | 66M-12151-00 | PAF15-07040301 | 185 | 66T-W0001-20 | REC66T-W0001-20 | 146-361 |
| 664-45371-01 | TEN01100AL | 164-169 | 66M-12170-00 | PAF15-07040200 | 185 | 66T-W0078-00 | REC66T-W0078-00 | 298-361 |
| 664-45371-01-00 | CM664-45371-01 | 353 | 66M-12411-00 | PAF15-07000031 | 137-179-180-183 | 66T-W0078-01 | REC66T-W0078-01 | 66-67-152-154 |
| 664-45371-01A | CM664-45371-01 | 160 | 66M-12411-01 | PAF15-07000031 | 183 | 66W-11119-00 | PAF25-05010106 | 191 |
| 664-45371-01A | CM664-45371-01A | 66-160-169 | 66M-12535-00 | PAF15-07010012 | 183-191-197-203-205-207 | 670-44514-00 | REC670-44514-00 | 135 |
| 664-45384-00 | REC664-45384-00 | 353-357 | 66M-13300-10 | PAF15-07040500 | 185 | 670-45997-02 | REC670-45997-02 | 359-369 |
| 664-4556-50 | PAF15-06000010-7 | 349 | 66M-13329-10 | PAF15-07040016 | 185 | 676-11181-A2 | REC676-11181-A1 | 249-254 |
| 664-45567-01 | PAF15-06000010-1 | 293 | 66M-14301-00 | PAF15-07090000 | 91 | 676-11325-00 | TEN01166 | 166-233-235 |
| 664-45567-01-10 | PAF15-06000010-1 | 291-351 | 66M-14301-00 | PAF15-07090000W | 91 | | | 173-179-181-183-195-213-225-227-229-231-233 |
| 664-45567-05 | PAF15-06000010-1 | 349 | 66M-15100-02-1S | PAF15-07010000 | 183 | | | |
| 664-45567-10 | PAF15-06000010-2 | 293 | 66M-24410-11 | PAF15-07140000 | 85 | | | |
| 664-45567-12 | PAF15-06000010-2 | 349 | 66M-41113-20-1S | PAF15-07010019 | 183 | | | |
| 664-45567-20 | PAF15-06000010-3 | 293 | 66M-41114-01 | PAF15-07010018 | 65-140-183 | | | |
| 664-45567-30 | PAF15-06000010-4 | 293 | 66M-41138-00 | PAF15-04010004 | 268 | | | |
| 664-45567-40 | PAF15-06000010-5 | 293 | 66M-44361-00 | PAF15-02000005S | 291 | | | |
| 664-45567-50 | PAF15-06000010-6 | 293 | 66M-44361-10 | PAF15-02000005L | 291 | | | |
| 664-45567-60 | PAF15-06000010-7 | 293 | 66M-44514-00-4D | PAF15-02010000 | 135 | | | |
| 664-45631-01 | REC664-45631-01 | 353 | 66M-44514-00-4D | PAF15-00000001 | 132 | | | |
| 664-45631-02 | PAF25-04060003 | 295 | 66M-44557-00 | PAF15-00000003 | 135 | | | |
| 664-45631-02 | REC664-45631-00 | 355-388-389 | 66M-45113-00 | PAF15-00000005 | 271 | | | |
| 664-45941-01-EL | SOL3211-099-09 | 402 | 66M-45115-00 | PAF15-03000003 | 268 | | | |
| 664-45945-00-EL | SOL3211-099-10 | 402 | 66M-45150-02-4D | PAF15-06100000S | 277-291 | | | |
| 664-45947-01-EL | PAF25-04080000 | 295 | 66M-45300-11-4D | PAF15-06100000L | 277-291 | | | |
| 664-45947-01-EL | SOL3211-099-11 | 402 | 66M-45371-00 | CM66M-45371-00 | 159-169-291 | | | |
| 664-45949-02-EL | SOL3211-099-13 | 402 | 66M-45371-00 | TEN01136 | 65-164-169 | | | |
| 664-45954-00-EL | SOL3211-099-12 | 402 | 66M-46241-00 | REC66M-46241-00 | 185-267 | | | |
| 664-45970-00-98 | SOL3231-103-12 | 402 | 66M-46297-00 | PAF15-07000024 | 185 | | | |
| 664-45972-00-98 | SOL3231-105-11 | 402 | 66M-81800-00 | PH130-0084 | 110 | | | |
| | | | 66M-81800-01 | PH130-0034 | 111 | | | |
| | | | 66M-81800-02 | PH130-0084 | 110 | | | |
| | | | 66M-81800-02 | PH130-0034 | 111 | | | |
| | | | 66M-81800-02 | PH130-0084 | 110 | | | |
| | | | 66M-85520-00 | PAF15-07000300 | 106 | | | |
| | | | 66M-85533-00 | PAF15-07000400 | 104 | | | |
| | | | 66M-85540-10 | PAF15-07000500 | 118 | | | |
| | | | 66M-85550-00 | PAF15-07070000 | 109 | | | |
| | | | | | | | | |

| R.O. / OEM | REF | | R.O. / OEM | REF | | R.O. / OEM | REF | |
|-----------------|--------------------|--|-----------------|--------------------|--------------------------------|-----------------|--------------------|-------------------------|
| 676-45127-00 | REC676-45127-00 | 269 | 67C-81800-02 | PH130-0028 | 110 | 67H-13907-00 | REC67H-13907-00 | 86 |
| 676-45128-00 | REC676-45128-00 | 269 | 67C-W0001-00 | REC67C-W0001-01 | 217 | 67H-13907-00 | REC6AW-14984-00 | 86 |
| 676-45251-00 | TEN01109 | 163-169 | 67C-W0001-01 | REC67C-W0001-01 | 197-217 | 67H-43880-00 | PH200-T057 | 123 |
| 676-45251-00 | TEN01127 | 166-233-235 | 67C-W0001-01 | REC67C-W0001-01 | 218 | 67H-8592A-01 | REC67H-8592A-01 | 103 |
| 676-45314-00 | REC676-45314-00 | 363 | 67C-W0001-20 | REC67C-W0001-20 | 298 | 680-WE090-11-15 | PAF4-04000000 | 175 |
| 676-45361-01-94 | REC676-45361-00 | 363-390 | 67D-11181-A0 | PAF4-04000014 | 175-215-218 | 682-11325-00 | TEN01162 | 166-227 |
| 676-45501-10 | REC676-45501-10 | 363-389-390 | 67D-11191-00 | PAF4-04000018 | 175 | 682-11351-A0 | REC682-11351-A0 | 253 |
| 676-45533-00 | REC676-45533-00 | 363 | 67D-11400-00 | PAF4-04030000 | 175-219 | 682-11412-00 | REC682-11412-00 | 256 |
| 676-45587-00-70 | REC676-45587-00 | 363 | 67D-11650-00 | PAF4-04020100 | 175 | 682-11422-00 | REC682-11422-00 | 256 |
| 676-45587-00-75 | REC676-45587-00-75 | 363 | 67D-11654-00 | PAF4-04020103 | 175 | 682-11432-00 | REC682-11432-00 | 256 |
| 676-45587-00-80 | REC676-45587-00-80 | 363 | 67D-12111-00 | PA166F-010001 | 173-180 | 682-11442-00 | REC682-11442-00 | 256 |
| 676-45635-00 | REC676-45635-00 | 359-363-365 | 67D-12111-00 | PAF4-04080005 | 175 | 682-11610-00 | REC682-11610-01 | 262 |
| 676-81800-10 | PH130-0007 | 111 | 67D-12121-00 | PA166F-010002 | 173 | 682-11610-01 | REC682-11610-01 | 227-266 |
| 676-81970-00 | REC6G1-81970-62 | 116 | 67D-12121-00 | PAF4-04080006 | 175-180 | 682-11610-11 | REC682-11610-11 | 227-262 |
| 677-11181-A1 | REC677-11181-A0 | 225-248-254 | 67D-12151-00 | PA166F-010009 | 173-175-179 | 682-11610-21 | REC682-11610-21 | 227-262 |
| 677-11412-02 | REC677-11412-02 | 225-256 | 67D-12154-00 | PAF4-04000015 | 175 | 682-11681-00 | REC682-11681-00 | 227-260 |
| 677-11422-02 | REC677-11422-02 | 225-256 | 67D-12157-00 | PA166F-010008 | 173-175-179 | 682-12413-00-1S | REC682-12413-00-1S | 139-227 |
| 677-11432-02 | REC677-11432-02 | 225-256 | 67D-12413-00-1S | PAF4-04070001 | 175 | 682-12413-00-9M | REC682-12413-00-9M | 139 |
| 677-11442-02 | REC677-11442-02 | 225-256 | 67D-14301-03 | PAF4-04140000 | 91 | 682-12414-A1 | REC682-12414-A1 | 138-139-227 |
| 677-11631-00-97 | REC677-11631-00K | 225-262-266 | 67D-24410-03 | PAF4-04090000 | 85 | 682-13621-A0 | REC682-13621-00 | 273 |
| 677-11635-00 | REC677-11635-00K | 225-262 | 67D-24610-00 | PAF4-04120100 | 75 | 682-41112-A1 | REC682-41112-00 | 140 |
| 677-11636-00 | REC677-11636-00K | 225-262 | 67D-24610-02 | PAF4-04120100 | 75 | 682-41114-A1 | REC682-41114-00 | 140 |
| 677-11650-01 | REC677-11651-00 | 260 | 67D-24610-03 | PAF4-04120100 | 75 | 682-41133-A0 | REC682-41133-A0 | 268 |
| 677-13621-A1 | REC677-13621-00 | 273 | 67D-24610-04 | PAF4-04120100 | 75 | 682-41237-50 | REC682-41237-50 | 133 |
| 677-14198-A1 | REC677-14198-A1 | 273 | 67D-44366-00 | PAF4-03000021 | 285-287 | 682-42137-00 | REC682-42137-00 | 133 |
| 677-14227-01 | REC677-14227-01 | 98 | 67D-45113-A0 | PAF4-00000006 | 175-217-218 | 682-44147-00 | REC682-44147-00 | 349-357 |
| 677-14343-68 | REC677-14343-68 | 94 | 67D-45560-00 | PAF4-03010000 | 285-287-387 | 682-44176-00 | REC682-44176-00 | 349 |
| 677-14384-01 | REC677-14384-01 | 94 | 67D-45570-00 | PAF4-03040000 | 285-287-387 | 682-44312-00 | REC682-44312-00 | 349 |
| 677-24434-02 | REC677-24434-02 | 273 | 67D-45631-01 | PAF4-03030002 | 285-287 | 682-44315-00 | REC682-44315-00 | 154-155-156-349 |
| 677-24435-01 | REC677-24435-01 | 87 | 67D-45635-00 | PAF4-03000008 | 285-287 | | | |
| 677-24471-01 | REC677-24471-01 | 87 | 67D-85640-00 | PAF4-04000038 | 106 | 682-44322-00 | REC682-44322-00 | 154-155-156-349 |
| 677-26301-02 | REC677-26301-02 | 130 | 67D-W0093-00 | REC67D-W0093-00 | 95-177 | 682-44323-00 | REC682-44323-00 | 154-155-156-349 |
| 677-41112-A1 | REC677-41112-A0 | 225 | 67F-11181-02 | REC67F-11181-03 | 209 | 682-44328-00 | REC682-44328-00 | 349 |
| 677-41114-A0 | REC677-41114-A0 | 140 | 67F-11181-03 | REC67F-11181-03 | 215-218 | 682-44352-00 | REC682-44352-01 | 349 |
| 677-41114-A1 | REC677-41114-A0 | 225-389 | 67F-11325-00 | CM67F-11325-00 | 159 | 682-44352-03 | CEF500320 | 143 |
| 677-45113-A0 | REC677-45113-A0 | 225-252-254 | 67F-11325-01 | TEN01146 | 163 | 682-44352-03 | REC682-44352-01 | 143 |
| 677-45251-00 | CM43107M | 169 | 67F-11325-01 | CM67F-11325-01 | 161 | 682-44352-03 | REC682-44352-01 | 143 |
| 677-45251-00 | CM6E0-45251-11 | 347 | 67F-11325-01 | CM67F-11325-01A | 70-71-72-73-161-211-213 | 682-44352-03 | REC682-44352-01 | 154-155-156-349 |
| 677-W0093-00 | REC677-W0093-00 | 95-225 | 67F-11325-01 | TEN01146-1 | 163 | 682-44361-10 | REC682-44361-01 | 349 |
| 679-14923-00 | REC679-14923-00 | 99 | 67F-11328-00 | REC67F-11328-00 | 209-211-214 | 682-44361-10 | REC682-44361-10 | 349 |
| 679-14966-00 | REC676-14966-00 | 100 | 67F-12411-00 | REC67F-12411-01 | 137 | 682-44365-00 | REC682-44365-00 | 154-155-156-349 |
| 679-44150-00 | REC679-44150-00 | 367 | | | | | | |
| 679-44150-10 | REC679-44150-10 | 367 | 67F-12411-01 | REC67F-12411-01 | 69-70-71-72-73-137-209-211-213 | 682-44514-01-94 | REC682-44514-01-94 | 135 |
| 679-44152-00 | REC679-44152-00 | 367 | | | | 682-44555-30 | PAF15-00000002 | 135 |
| 679-44316-A0 | REC679-44316-A0 | 367 | 67F-14371-01 | REC67F-14371-01 | 101 | 682-45113-02 | REC682-45113-A0 | 254-271 |
| 679-44341-00-94 | REC679-44341-00 | 367 | 67F-24251-02 | REC40165 | 80-81-82 | 682-45251-00 | TEN01128 | 166 |
| 679-44514-00-94 | REC679-44514-00-94 | 135 | 67F-41134-A0 | REC67F-41134-A0 | 269 | 682-45376-01 | REC682-45376-01 | 349 |
| 679-45251-00 | CM679-45251-00 | 160 | 67F-41138-00 | REC67F-41138-00 | 269 | 682-45631-00 | REC682-45631-00 | 291-293-349-351-387-388 |
| 679-45251-00 | CM679-45251-00A | 160 | 67F-4380R-00 | REC48630-94900 | 125 | 682-81800-10 | PH130-0061 | 110 |
| 679-45315-A1 | REC679-45315-A1 | 365 | 67F-4380R-01 | REC48630-94900 | 125 | 682-81800-11 | PH130-0061 | 110 |
| 679-45321-02 | REC679-45321-02 | 365 | 67F-43811-00 | REC48630-94900 | 125 | 682-81800-12 | PH130-0061 | 110 |
| 679-45331-00-94 | REC679-45331-00 | 365 | 67F-43880-00 | PH200-T044 | 123 | 682-82556-00 | PAF4-01090401 | 120 |
| 679-45371-00 | TEN01101 | 164-169-365-369 | 67F-44311-00 | REC67F-44311-01 | 321 | 682-W0078-A1 | REC682-W0078-A1 | 150-154-155-156-348 |
| 679-45371-00 | TEN01101AL | 164-169 | 67F-44311-01-00 | REC67F-44311-01 | 148-154-155 | 683-44361-01 | REC683-44361-01 | 349 |
| 679-45501-10 | REC679-45501-10 | 367-389 | 67F-44322-00 | REC67F-44322-00 | 321-154-155 | 683-44365-01 | REC683-44365-01 | 349 |
| 679-45536-00 | REC679-45536-00 | 367 | 67F-44323-00 | REC67F-44323-00 | 149-154-155-321 | 683-44373-00 | REC683-44373-00 | 349 |
| 679-45560-00 | REC679-45560-00 | 365-389 | 67F-44352-00 | CEF500364 | 143 | 683-45315-00 | REC683-45315-00 | 349 |
| 679-45571-00 | REC679-45571-00 | 365 | 67F-44352-00 | REC67F-44352-00 | 143-321-154-155 | 683-45361-00-EJ | REC683-45361-01-4D | 349 |
| 679-45611-01 | REC679-45611-00 | 359-365-389-390 | 67F-45113-00 | REC67F-45113-00 | 272 | 683-45361-02-4D | REC683-45361-01-4D | 291-351 |
| 679-W0078-00 | REC679-W0078-A1 | 151-156 | 67F-45123-00 | REC67F-45123-00 | 269 | 683-45361-02-8D | PAF15-06080000 | 293 |
| 67C-11181-01 | REC67C-11181-01 | 197-215-218 | 67F-45127-00 | REC67F-45127-00 | 269 | 683-45361-02-8D | REC683-45361-01-4D | 293 |
| 67C-11351-01 | REC67C-11351-00 | 197-207-218 | 67F-45331-00-94 | REC67F-45331-00-CA | 319 | 683-45361-02-8D | REC683-45361-02-4D | 387-388 |
| 67C-11356-00 | REC67C-11356-00 | 197 | 67F-45371-00 | CM67F-45371-00 | 70-161 | 683-45611-00 | REC683-45611-00 | 291-293-349-351-387-388 |
| 67C-11537-01 | PAF40-05040006 | 199 | 67F-45371-00 | CM67F-45371-00A | 68-69-161-315-319 | 683-45941-00-00 | SOL3111-093-12 | 402 |
| 67C-11603-00 | REC67C-11603-00 | 193-195-199-201-203-205-219 | 67F-45371-00 | TEN01140 | 165 | 683-45942-00-EL | SOL3111-093-10 | 402 |
| 67C-11650-00 | PAF25-05020200 | 193 | 67F-45371-00 | TEN01141 | 165-169 | 683-45943-00-EL | SOL3111-093-11 | 402 |
| 67C-12111-00 | PAF25-05050001 | 193-199 | 67F-45371-00 | TEN01141AL | 165-169 | 683-45945-00-EL | SOL3111-093-09 | 402 |
| 67C-15312-00 | PAF25-02010007 | 271 | 67F-45501-10 | REC67F-45501-10 | 321-391 | 683-45947-00-EL | SOL3111-093-08 | 402 |
| 67C-15312-00 | REC67C-15312-00 | 271 | 67F-45560-00 | REC67F-45560-00 | 319-390-391 | 683-W0001-21 | REC683-W0001-21 | 348 |
| 67C-41114-00 | REC67C-41114-00 | 141 | 67F-45570-00 | REC67F-45570-00 | 391 | 683-W0001-C1 | REC683-W0001-21 | 144 |
| 67C-41114-10 | REC67C-41114-00 | 197 | 67F-45576-00 | REC67F-45576-00 | 315-319 | 688-11111-02-1S | REC688-11111-02-1S | 243 |
| 67C-41133-00 | REC67C-41133-00 | 268 | 67F-45611-01 | REC67F-45611-01 | 315-319-391 | 688-11181-A1 | REC688-11181-A1 | 243 |
| 67C-43880-00 | REC67C-43880-01 | 122 | 67F-45997-00 | REC67F-45997-00 | 405 | 688-11181-A2 | REC688-11181-A1 | 249 |
| 67C-43880-01 | REC67C-43880-01 | 122 | 67F-46241-00 | REC67F-46241-00 | 209-267 | 688-11181-A2 | REC688-11181-A1 | 254 |
| 67C-45113-00 | REC67C-45113-00 | 271 | 67F-81800-01 | PH130-0055 | 112 | 688-11193-A1 | REC688-11193-A1 | 243-255 |
| 67C-45123-00 | REC67C-45123-00 | 268 | 67F-81800-02 | PH130-0055 | 112 | 688-11325-00 | CM85007 | 160 |
| 67C-45251-00 | CM67C-45251-00 | 158-169-361-66-67-69-158-299-303-307-311 | 67F-81800-03 | PH130-0055 | 112 | 688-11325-00 | CM85007A | 160 |
| 67C-45251-00 | CM67C-45251-00A | 163 | 67F-81800-04 | PH130-0055 | 112 | 688-11370-01 | TEN01147 | 163-237-243 |
| 67C-45371-00 | TEN01132 | 163 | 67F-81960-00 | REC67F-81960-12 | 116 | 688-11411-01 | REC688-11370-00 | 237-241-243 |
| 67C-45371-00 | CM67C-45371-00 | 160-169 | 67F-85570-00 | REC67F-85570-00 | 105 | | REC688-11411-01 | 243-256 |
| 67C-45371-00 | CM67C-45371-00A | 66-67-68-69-160-169-299-303-307-311 | 67F-W0001-00 | REC67F-W0001-00 | 217 | 688-11603-A0 | REC688-11603-A0 | 239-243-264-266 |
| 67C-45371-00 | CM67C-45371-00A | 160-169-299-303-307-311 | 67F-W0001-01 | REC67F-W0001-01 | 209-218 | 688-11605-A0 | REC688-11605-A0 | 239-243-264 |
| 67C-45501-00 | REC67C-45501-00 | 301-305-389-390 | 67F-W0001-20 | REC67F-W0001-20 | 145-318 | 688-11610-02 | REC688-11610-02 | 264-266 |
| 67C-45501-10 | REC67C-45501-10 | 301-305-389-390 | 67F-W0078-00 | REC67F-W0078-00 | 69-70-152-154-155-318 | 688-11631-02-95 | REC688-11631-02K | 264-266 |
| 67C-45633-00 | PAT40-04050005 | 307-311 | 67F-W0093-00 | REC67F-W0093-00 | 97-209 | 688-11631-03-94 | REC688-11631-03K | 239-243-264 |
| 67C-81800-00 | PH130-0028 | 110 | 67F-11416-10 | REC67F-11416-10 | 209 | 688-11631-81-96 | REC688-11631-81K | 264-266 |
| 67C-81800-01 | PH130-0028 | 110 | 67F-11416-20 | REC67F-11416-20 | 209 | 688-11634-00 | REC688-11634-00 | 229-239-243-263-264 |
| | | | 67H-11411-00 | REC67H-11411-00 | 256 | 688-116 | | |

| R.O. / OEM | REF | | R.O. / OEM | REF | | R.O. / OEM | REF | |
|-----------------|--------------------|---|-----------------|--------------------|-------------------------------------|-----------------|--------------------|--------------------|
| 688-11636-03 | REC688-11636-03K | 239 | 688-45930-02-98 | SOL3431-133-17 | 402 | 68D-E2414-A0 | PAF4-04000011 | 64-138-173-175-179 |
| 688-11650-03 | REC688-11650-03 | 239-243-264 | 688-45970-03-98 | SOL3431-130-19 | 402 | 68D-E3102-00 | PAF4-04050100 | 177 |
| 688-11651-00 | REC688-11651-00 | 261 | 688-45972-02-98 | SOL3431-130-21 | 402 | 68D-E5111-00-1S | PAF4-04050200 | 177 |
| 688-12411-10 | REC6E5-12411-30 | 243 | 688-45978-60-98 | SOL3431-135-15 | 402 | 68D-E5346-00 | PAF4-04010003 | 177 |
| 688-12413-00-1S | REC688-12413-00-1S | 139-243 | 688-45987-01 | REC688-45987-00 | 315-319-371-405 | 68D-E5362-00 | PAF4-04000007 | 177 |
| 688-12414-A1 | REC688-12414-A1 | 138-139-243-245-247 | 688-45987-01-00 | REC688-45987-00 | 373 | 68D-E5362-00 | PAF4-04000010 | 179 |
| 688-12416-00 | REC688-12416-00 | 139-243 | 688-45997-00 | REC688-45997-00 | 383 | 68D-E5362-00 | PAGB/T5783-M5X12 | 183 |
| 688-13610-00 | REC688-13610-00 | 99 | 688-45997-01 | REC688-45997-00 | 323-327-331-335-337-375-379-405 | 68D-E5396-00-5B | PAF4-04060001 | 177-179 |
| 688-13621-A1 | REC688-13621-A1 | 274 | 688-45997-01-00 | REC688-45997-00 | 373 | 68D-G2177-10 | PAF4-01090300 | 134 |
| 688-14198-A2 | REC688-14198-A1 | 274 | 688-81800-10 | PH130-0058 | 111 | 68D-G4150-00 | PAF4-03020000S | 285 |
| 688-14416-01 | REC688-14416-01 | 274 | 688-81800-11 | PH130-0058 | 111 | 68D-G4150-10 | PAF4-03020000L | 285 |
| 688-14483-A0 | REC688-14483-A0 | 274 | 688-81800-12 | PH130-0058 | 111 | 68D-G4311-01 | PAF4-03000019 | 147-285 |
| 688-14548-00 | REC688-14548-00 | 99 | 688-81950-10 | REC688-81950-10 | 111-114 | 68D-G4315-A0 | PAF4-03000018 | 285 |
| 688-14947-00 | REC688-14947-00 | 98 | 688-82560-10 | REC688-82560-10 | 103 | 68D-G4328-00 | PAF4-03000020 | 285-287 |
| 688-24378-00 | PAF15-05000011 | 183-191-195-197-207 | 688-82575-01 | REC688-82575-01 | 120 | 68D-G4360-00 | PAF4-02040001S | 285 |
| 688-41112-A0 | REC688-41112-A0 | 142-243 | 688-82586-21 | PAF15-13000100W | 129 | 68D-G4365-00 | PAF4-02040002 | 283-285 |
| 688-41114-A0 | REC688-41114-A0 | 142-243 | 688-8258A-10 | REC688-8258A-10 | 129 | 68D-G5251-00 | CM6L5-45251-02A | 287 |
| 688-41134-A0 | REC688-41134-A0 | 269 | 688-8258A-20 | PAT85-08010100 | 129 | 68D-G5251-00 | PAF4-03000022 | 64-283-285 |
| 688-41211-00 | REC688-41211-01 | 132 | 688-8258A-30 | REC688-8258A-30 | 129 | 68D-G5300-00-4D | PAF4-0310000S | 285 |
| 688-41211-01 | REC688-41211-01 | 132 | 688-85510-00 | REC688-85510-00 | 121 | 68D-G5300-10-4D | PAF4-0310000L | 285 |
| 688-41217-00 | REC688-41217-00 | 101 | 688-85510-01 | REC688-85510-01 | 121 | 68D-G5300-11-4D | PAF4-03000011 | 285-287 |
| 688-43160-01 | REC688-43160-01 | 132 | 688-85510-10 | REC688-85510-10 | 121 | 68D-G5321-00 | PAF4-03000012 | 285-287 |
| 688-43880-11 | PH200-T037 | 123 | 688-85540-00 | REC688-85540-00 | 117 | 68D-G5361-00-4D | PAF4-03050001 | 285-287 |
| 688-44120-11 | REC688-44120-12 | 134 | 688-85540-16 | REC688-85540-16 | 120 | 68D-G5511-00 | PAF4-03000004S | 287 |
| 688-44120-12 | REC688-44120-12 | 134 | 688-85540-02 | REC688-W0001-A0 | 243 | 68D-G5511-10 | PAF4-03000004L | 287 |
| 688-44120-22 | REC688-44120-22 | 134 | 688-W0001-20 | REC688-W0001-20 | 146 | 68D-G5978-00 | PAF4-03000025 | 283 |
| 688-44311-01 | REC688-44311-01 | 148-156-371 | 688-W0001-20-00 | REC688-W0001-22 | 373 | 68D-G5987-00 | PAF4-03000025 | 285-287 |
| 688-44311-01-00 | REC688-44311-01 | 373 | 688-W0001-22 | REC688-W0001-22 | 146-370 | 68F-11181-00 | REC688-11181-00 | 249-254 |
| 688-44315-A0 | REC688-44315-00 | 373 | 688-W0001-A0 | REC688-W0001-A0 | 251-254 | 68F-11193-02 | REC688-11193-02 | 255 |
| 688-44316-A0-00 | REC688-44316-00 | 321-371 | 689-11181-A2 | REC689-11181-00 | 248-254 | 68F-11381-00 | REC688-11381-00 | 276 |
| 688-44316-A0-00 | REC688-44316-00 | 373 | 689-11325-00 | CM3082523 | 158 | 68F-13440-00 | REC688-13440-00 | 83 |
| 688-44322-00 | REC688-44322-00 | 156-371 | 689-11325-00 | CM689-11325-00A | 158 | 68F-13907-01 | REC688-13907-01 | 86 |
| 688-44322-00-00 | REC688-44322-00 | 373 | 689-11325-00 | TEN01121 | 167-229 | 68F-13915-00 | REC688-13915-00 | 82 |
| 688-44323-00 | REC688-44323-00 | 156-371 | 689-11610-01 | REC689-11610-00 | 263-266 | 68F-24563-00 | REC688-24563-10 | 81 |
| 688-44323-00-00 | REC688-44323-00 | 149-373 | 689-11610-00-95 | REC689-11631-00K | 263-266 | 68F-24563-10 | REC688-24563-10 | 81 |
| 688-44324-A0 | REC688-44324-00 | 321-371 | 689-11633-00 | REC689-11633-00 | 229-260-263 | 68F-41114-00 | REC688-41114-00 | 142 |
| 688-44324-A0-00 | REC688-44324-00 | 373 | 689-11651-00 | REC689-11651-00 | 229-260-261 | 68F-45113-01 | REC688-45113-01 | 253-254 |
| 688-44341-01-94 | REC688-44341-01 | 371-373 | 689-11681-01 | REC689-11681-01 | 229-260-261 | 68F-81800-00 | PH130-0056 | 111 |
| 688-44352-03 | CEF500323 | 143 | 689-15396-01-5B | REC689-15396-01-CA | 229 | 68F-81800-03 | PH130-0056 | 111 |
| 688-44352-03 | REC688-44352-03 | 143-156-371 | 689-15755-00 | REC689-15755-00 | 134 | 68F-8195A-00 | REC688-8195A-00 | 115 |
| 688-44352-03-00 | REC688-44352-03 | 373 | 689-41112-A0 | REC689-41112-A0 | 141 | 68F-83688-00 | REC688-83688-00 | 90-102 |
| 688-44361-10 | REC688-44361-10 | 371 | 689-41114-A0 | REC689-41114-A0 | 141 | 68F-83688-10 | REC688-83688-10 | 90-102 |
| 688-44514-00 | REC688-44514-00 | 135 | 689-44311-03 | REC689-44311-00 | 147-155-353 | 68F-8592A-00 | REC688-8592A-00 | 103 |
| 688-44555-00 | REC688-44555-00 | 135 | 689-44315-A0 | REC689-44315-A0 | 353 | 68F-W0001-01 | REC688-W0001-01 | 252-254 |
| 688-45113-A0 | REC688-45113-A0 | 243-253-254 | 689-44316-A0 | REC689-44316-A0 | 353 | 68N-81940-00 | PH375-0042 | 114 |
| 688-45114-A1 | REC688-45114-A1 | 272 | 689-44323-03 | REC689-44323-00 | 155-353 | 68T-11325-00 | CM68T-11325-00 | 71-72-73-161-211 |
| 688-45123-00 | REC688-45123-00 | 269 | 689-44324-A0 | REC689-44324-A0 | 155-353 | 68T-11325-00 | TEN01163 | 166 |
| 688-45214-02 | REC688-45214-02 | 323-365 | 689-44352-02 | REC689-44352-02 | 143-155-353 | 68T-12116-00 | PAF4-04080007 | 175-179-180 |
| 688-45215-02 | REC688-45215-02 | 323-365 | 689-44366-00 | REC689-44366-00 | 155-353-355 | 68T-13475-00 | REC688-13475-00 | 271 |
| 688-45251-01 | CM688-45251-01 | 158-169 | 689-45113-A1 | REC689-45113-A0 | 229 | 68T-24251-01 | REC688-24251-00 | 64-65-80-81-82 |
| 688-45251-01 | CM688-45251-01A | 67-68-69-158-169 | 689-45501-10 | REC689-45501-10 | 353-388-389 | 68T-24410-00 | REC688-24410-00-00 | 85 |
| 688-45251-01 | TEN01110 | 163-169 | 689-45551-00 | REC689-45551-00 | 353-388-389 | 68T-24410-01 | REC688-24410-00-00 | 85 |
| 688-45331-00-94 | REC688-45331-00-94 | 371-373-388-390-391 | 689-45560-00 | REC689-45560-00 | 353-388-389 | 68T-44323-00 | REC688-44323-00 | 149-154-289-293 |
| 688-45341-00 | REC688-45341-00 | 295-359-375 | 689-45570-00 | REC689-45570-00-00 | 353-388-389 | 68T-44352-00 | CEF500368 | 143 |
| 688-45341-00-00 | REC688-45341-00 | 373 | 689-45611-00 | REC689-45611-00 | 295-353-355-357-405 | 68T-44352-00 | REC688-44352-00 | 143-154-289 |
| 688-45341-10 | REC688-45341-00 | 299-303-307-311-315-319-323-327-331-335-337-341-355-361-363-369-370-379 | 689-45997-00 | REC689-45997-00 | 110 | 68T-44366-00 | REC688-44366-00 | 154-289 |
| 688-45371-02 | CM688-45371-02 | 371 | 689-81800-10 | PH130-0049 | 110 | 68T-45251-00 | CM688-45251-00 | 158-169 |
| 688-45371-02 | CM688-45371-02 | 160-169 | 689-81800-11 | PH130-0049 | 110 | 68T-45251-00A | CM688-45251-00A | 64-65-158-169-289 |
| 688-45371-02 | TEN01104 | 164-169 | 689-81800-12 | PH130-0049 | 110 | 68T-45251-00 | TEN01142 | 163-169 |
| 688-45371-02-00 | TEN01104AL | 164-169 | 689-81800-13 | PH130-0049 | 110 | 68T-46241-00 | REC688-46241-00 | 267 |
| 688-45375-00 | REC688-45375-00 | 373 | 689-85540-20 | REC689-85540-21 | 119 | 68T-85540-00 | REC688-85540-00 | 118 |
| 688-45383-02 | REC688-45383-01 | 315-319-323-371-375 | 689-W0001-20 | REC689-W0001-20 | 145 | 68T-W0001-20 | REC688-W0001-20 | 144-289 |
| 688-45383-02-00 | REC688-45383-01 | 373 | 689-W0001-21 | REC689-W0001-21 | 145-353 | 68T-W0078-00 | REC688-W0078-00 | 150-289 |
| 688-45384-00 | REC688-45384-00 | 373 | 689-W0078-04 | REC689-W0078-04 | 151-155 | 68T-W0078-01 | REC688-W0078-01 | 64-65-150-154 |
| 688-45384-00-00 | REC688-45384-00 | 315-319-323 | 689-W0078-A6 | REC689-W0078-A6 | 151-155-353 | 68V-11325-01 | CM68V-11325-01 | 158 |
| 688-45501-10 | REC688-45501-10 | 390-391 | 689-W0093-02 | REC689-W0093-02 | 95 | 68V-11325-01 | TEN01156-1 | 167 |
| 688-45501-11 | REC688-45501-11 | 371-390-391 | 689-W4432-02 | REC689-W4432-01 | 155-156-353 | 68V-11325-01 | CM68V-11325-01A | 158 |
| 688-45536-01 | REC688-45536-01 | 317-321 | 68D-11351-A0 | PAF4-04000002 | 177-270 | 68V-11325-01 | TEN01156-1AL | 167 |
| 688-45551-01 | REC688-45551-01 | 371-390-391 | 68D-24610-10 | PAF4-04120100 | 75 | 68V-11325-02 | TEN01156AL | 72-167 |
| 688-45560-00 | REC688-45560-00 | 371-390-391 | 68D-65300-03-4D | PAF4-0310000S | 277 | 68V-11325-02 | REC688-11351-00 | 209-218 |
| 688-45560-00-00 | REC688-45560-00 | 373 | 68D-65300-11-4D | PAF4-0310000L | 277 | 68V-13761-00 | REC688-12111-00 | 209 |
| 688-45567-01 | PAT85-04000004-B | 315-319 | 68D-E1111-10-1S | PAF4-04080101 | 175 | 68V-13761-00 | REC688-8A360-00 | 89 |
| 688-45571-01 | REC688-45571-00-00 | 390-391 | 68D-E1168-00 | PAF4-04000010 | 177 | 68V-13761-10 | REC688-13761-10 | 90 |
| 688-45587-01 | PAT85-04000003-B | 317-321 | 68D-E1169-A0 | PAF4-04000009 | 177 | 68V-13907-00 | REC688-13907-00 | 86 |
| 688-45611-01 | REC688-45611-01 | 371-390-391 | 68D-E1193-A0 | PAF4-04000017 | 175 | 68V-13907-01 | REC688-13907-00 | 86 |
| 688-45631-01 | REC688-45631-00 | 371-390-391 | 68D-E1311-02-15 | PAF4-04010100 | 177 | 68V-13907-02 | REC688-13907-00 | 86 |
| 688-45633-00 | REC688-45633-00 | 315-319-371-390-391 | 68D-E1325-00 | PAF4-04070003 | 64-65-66-67-68-69-70-71-173-175-179 | 68V-13907-04 | REC688-13907-00 | 86 |
| 688-45633-00-00 | REC688-45633-00 | 373 | 68D-E1603-00 | REC688-E1603-00 | 175-219 | 68V-13907-07 | REC688-13907-00 | 86 |
| 688-45634-00 | REC688-45634-00 | 371 | 68D-E1631-00-96 | PAF4-04020001 | 175 | 68V-13907-03 | REC688-13907-00 | 86 |
| 688-45635-00 | REC688-45635-00 | 369-371 | 68D-E1633-00 | PAF4-04020005 | 175-219 | 68V-13907-04 | REC688-13907-00 | 86 |
| | | | 68D-E2113-00 | PAF4-04080008 | 173-175</ | | | |

| R.O. / OEM | REF | | R.O. / OEM | REF | | R.O. / OEM | REF | |
|-----------------|--------------------|-------------------|------------------|--------------------|-------------|-----------------|-----------------|----------------|
| 68V-24563-00 | REC68V-24563-00 | 68-80-81-82 | 69J-15451-A1 | REC69J-15451-00 | 273 | 69W-45300-01-8D | PAF60-04000000 | 278 |
| 68V-43880-03-40 | REC18-6865 | 124 | 69J-24410-00 | REC69J-24410-02 | 86 | 69W-45300-04-8D | PAF60-04000000 | 311 |
| 68V-43880-03-40 | REC63P-43800-20 | 124 | 69J-24410-01 | REC69J-24410-02 | 86 | 69W-45301-00-8D | PAF60-04000001 | 311 |
| 68V-45501-10 | REC68V-45501-10 | 325 | 69J-24410-02 | REC69J-24410-02 | 86 | 69W-45501-00 | PAF60-04010000 | 313 |
| 68V-81800-00 | PH130-0057 | 111 | 69J-24501-10 | REC69J-24501-10 | 71-72-81 | 69W-45551-00 | PAF60-04000002 | 311 |
| 68V-81800-01 | PH130-0057 | 111 | 69J-24502-00 | REC69J-24502-00 | 81 | 69W-45560-00 | PAF60-04000600 | 311 |
| 68V-81800-02 | PH130-0057 | 111 | 69J-41134-A0 | REC69J-41134-A0 | 270 | 69W-45941-00-EL | PAT40-04070000 | 402 |
| 68V-8194A-00 | PH375-0042 | 114 | 69J-41135-A0 | REC69J-41135-A0 | 270 | 69W-81800-00 | PH130-0059 | 110 |
| 68V-81950-00 | REC68V-81950-00 | 115 | 69J-41138-00 | REC69J-41138-00 | 270 | 69W-82575-00 | REC69W-82575-00 | 120 |
| 68V-81960-00 | REC881346T | 117 | 69J-43880-00 | PH200-T069 | 123 | 6A0-14325-00 | REC6A0-14325-00 | 99 |
| 68V-82380-00 | REC68V-82380-00 | 90-102 | 69J-43880-01 | PH200-T069 | 123 | 6A0-24410-00 | REC692-24410-00 | 85 |
| 68V-85885-00 | REC68V-85885-00 | 90-102 | 69J-45123-00 | REC69J-45123-00 | 270 | 6A0-24410-03 | REC6A0-24410-04 | 85 |
| 68V-8A360-00 | REC68V-8A360-00 | 89-90 | 69J-45300-21-8D | REC421-B25F | 279 | 6A0-24410-01 | REC6A0-24410-04 | 85 |
| 68V-W0001-20 | REC68V-W0001-20 | 147-322 | 69J-45300-22-8D | REC421-B25F | 331 | 6A0-24410-02 | REC6A0-24410-04 | 85 |
| 68V-W0078-00 | REC68V-W0078-00 | 70-71-152-155-322 | 69J-45300-32-8D | REC421-B30F | 279 | 6A0-24410-03 | REC692-24410-00 | 85 |
| 68W-43880-03 | PH200-T057 | 123 | 69J-45361-00-8D | REC69J-45361-00-8D | 331-383 | 6A0-24410-03 | REC6A0-24410-04 | 85 |
| 692-14590-00 | REC692-14590-01 | 98 | 69J-45375-00 | REC69J-45375-00 | 331-383 | 6A0-24410-04 | REC692-24410-00 | 85 |
| 692-14590-01 | REC692-14590-01 | 98 | 69J-45611-00 | REC69J-45611-00 | 331-337-392 | 6A0-24410-04 | REC6A0-24410-04 | 85 |
| 692-14923-00 | REC692-14923-00 | 98 | 69J-45631-00 | REC69J-45631-00 | 331-337-392 | 6A0-24410-05 | REC692-24410-00 | 85 |
| 692-24410-00 | REC692-24410-00 | 85 | 69J-46241-00 | REC69J-46241-00 | 267 | 6A0-82550-01 | REC6A0-82550-01 | 120 |
| 692-24411-00 | REC692-24411-00 | 87 | 69J-81800-00 | PH130-0074 | 112 | 6A0-W0001-21 | REC6A0-W0001-21 | 146 |
| 692-26301-00 | REC692-26301-03 | 130 | 69J-81800-01 | PH130-0074 | 112 | 6A1-14301-03 | REC6A1-14301-03 | 92-93 |
| 692-26301-01 | REC692-26301-03 | 130 | 69J-81960-10 | REC69J-81960-13 | 116 | 6A1-14613-00 | REC6A1-14613-A0 | 270 |
| 692-26301-02 | REC692-26301-03 | 130 | 69J-81960-11 | REC69J-81960-13 | 116 | 6A1-14613-01 | REC6A1-14613-A0 | 270 |
| 692-26301-03 | REC692-26301-03 | 130 | 69J-81960-12 | REC69J-81960-13 | 116 | 6A1-14613-A0 | REC6A1-14613-A0 | 220-270 |
| 692-41256-00 | REC692-41256-00 | 101 | 69J-81960-13 | REC69J-81960-13 | 116 | 6A1-44325-00P | REC6A1-44325-00 | 343 |
| 692-44120-21 | REC692-44120-22 | 134 | 69J-85885-00 | REC69J-85885-00 | 90-102 | 6A1-44361-00 | REC6A1-44361-00 | 343 |
| 692-44120-22 | REC692-44120-22 | 134 | 69J-W0001-20 | REC64J-W0001-20 | 146 | 6A1-85540-00 | REC6A1-85540-01 | 118 |
| 692-45300-12-4D | REC692-45300-16-8D | 280 | 69J-W0001-20 | REC69J-W0001-20-00 | 147-333 | 6A1-85540-01 | REC6A1-85540-01 | 118 |
| 692-45300-13-4D | REC692-45300-16-8D | 280 | 69K-45300-21-8D | REC428-B25F | 279 | 6A1-85570-00 | REC6A1-85570-00 | 105 |
| 692-45300-14-4D | REC692-45300-16-8D | 280-370 | 69K-45300-34-8D | REC428-B30F | 279 | 6A1-W0001-22 | REC6A1-W0001-22 | 144 |
| 692-W0078-00 | REC692-W0078-02 | 152 | 69K-45611-00 | REC69K-45611-00 | 331-337 | 6A1-W0001-23 | REC6A1-W0001-23 | 144-343 |
| 692-W0078-00-00 | REC692-W0078-02 | 373 | 69L-11181-00 | REC61A-11181-A0 | 249-254 | 6A1-W0078-01 | REC6A1-W0078-01 | 150-155-343 |
| 692-W0078-01 | REC692-W0078-02 | 152 | 69L-11635-00-85 | REC69L-11631-00K | 267 | 6A1-W0093-01 | REC6A1-W0093-01 | 93-95 |
| 692-W0078-01-00 | REC692-W0078-02 | 373 | 69L-11642-00-85 | REC69L-11642-00 | 267 | 6AE-43880-00 | PH200-T057 | 123 |
| 692-W0078-02 | REC692-W0078-02 | 152-156-370 | 69L-45371-00 | CM69L-45371-00 | 160-169 | 6AE-43880-01 | PH200-T057 | 123 |
| 695-11181-A1 | REC695-11181-00 | 248-254 | 69L-45371-00 | CM69L-45371-00A | 160-169 | 6AE-43880-03 | PH200-T057 | 123 |
| 695-85540-11 | REC695-85540-11 | 119 | 69L-45371-00 | TEN01145 | 168-169 | 6AE-43880-04 | PH200-T057 | 123 |
| 695-85540-12 | REC695-85540-11 | 119 | 69L-81800-00 | PH130-0059 | 110 | GAG-11181-00 | REC6AG-11181-00 | 215 |
| 695-W0001-01 | REC695-W0001-A2 | 250-254 | 69M-11181-00 | PAF2.6-04000001 | 173-215-218 | GAG-11181-10 | REC6AG-11181-00 | 187-218 |
| 696-14590-01 | REC696-14590-01 | 98 | 69M-11193-A0 | PAF2.6-04000005 | 173 | 6AH-11111-10-1S | PAF20-05030100 | 187 |
| 696-45113-00 | REC696-45113-00 | 239 | 69M-11351-A0 | PAF2.6-04000004 | 171-270 | 6AH-11168-00 | PAF20-05040003 | 187 |
| 696-45113-A0 | REC696-45113-00 | 253-254 | 69M-11400-00 | PAF2.6-04030000 | 173-219 | 6AH-11169-00 | PAF20-05040004 | 187 |
| 696-85540-10 | REC696-85540-12 | 119 | 69M-11650-00 | PAF2.6-04020100 | 173 | 6AH-11191-001S | PAF20-05040000 | 187 |
| 696-85540-11 | REC696-85540-12 | 119 | 69M-12154-00 | PAF2.6-04000002 | 173 | 6AH-11351-10 | REC6AH-11351-00 | 187-218 |
| 696-85540-12 | REC696-85540-12 | 119 | 69M-12170-01 | PAF2.6-04000100 | 173 | 6AH-11356-00 | PAF20-05040002 | 187 |
| 696-W0093-00 | REC696-W0093-00 | 239 | 69M-12411-00 | REC6AH-12411-00 | 136 | 6AH-11372-00 | PAF20-05040005 | 187 |
| 696-W0093-01 | REC84419M | 96 | 69M-12411-01 | REC6AH-12411-00 | 136-173-175 | 6AH-11411-00 | PAF20-05020004 | 189-219 |
| 696-W0093-02 | REC696-W0093-00 | 96 | 69M-14301-21 | PAF2.6-04000200 | 91 | 6AH-11416-00 | PAF20-05010003 | 189 |
| 696-W0093-02 | REC84419M | 96 | 69M-15361-00 | PAF2.6-04010102 | 171 | 6AH-11536-00 | PAF20-05000027 | 189 |
| 697-11181-A2 | REC697-11181-A1 | 239-249-254 | 69M-24575-00 | PAF2.6-00000004 | 76 | 6AH-11537-00 | PAF20-05030012 | 189 |
| 697-44352-00 | REC6H3-44352-00 | 369 | 69M-44361-00 | PAF2.6-02000003S | 283 | 6AH-11557-00 | PAF20-05000028 | 189 |
| 697-45114-A0 | REC697-45114-00 | 254-271 | 69M-44361-10 | PAF2.6-02000003L | 283 | 6AH-11603-00 | PAF20-05020100 | 189-219 |
| 697-45384-00 | REC697-45384-00 | 359-365-369 | 69M-45113-A0 | PAF2.6-00000003 | 173-217-218 | 6AH-11631-00 | PAF20-05020001 | 189-219 |
| 697-45551-00 | REC697-45551-00 | 369-390 | 69M-65300-01-4D | PAF2.6-03020000S | 277 | 6AH-11650-10 | PAF20-05020200 | 189 |
| 697-45560-00 | REC697-45560-00 | 369-390 | 69M-65300-11-4D | PAF2.6-03020000L | 277 | 6AH-11654-00 | PAF25-05020204 | 189 |
| 697-45571-00 | REC697-45570-00 | 369 | 69M-85640-00 | PAF2.6-04000600 | 106 | 6AH-12111-00 | PAF20-05030001 | 189 |
| 697-45571-00 | REC697-45571-00-00 | 390 | 69M-E1111-00-1S | PAF2.6-04040100 | 173 | 6AH-12121-10 | PAF20-05030002 | 189 |
| 697-45611-00 | REC697-45611-00 | 369-388-390 | 69M-E1191-00-1S | PAF2.6-04000006 | 173 | 6AH-12151-00 | PAF20-05030301 | 189 |
| 697-81800-10 | PH130-0007 | 111 | 69M-E1311-00-1S | PAF2.6-04010100 | 171 | 6AH-12170-00 | PAF20-05030200 | 189 |
| 697-81800-11 | PH130-0007 | 111 | 69M-E1603-01 | REC69M-E1603-01 | 173-219 | 6AH-12279-00 | PAF20-05030008 | 189 |
| 697-81800-12 | PH130-0007 | 111 | 69M-E1633-00 | PAF2.6-04020001 | 173-219 | 6AH-12411-00 | REC6AH-12411-00 | 65-136-137-187 |
| 697-85570-00 | REC697-85570-00 | 105 | 69M-E1633-00 | PAF2.6-04020005 | 173-219 | 6AH-12413-00-1S | PAF20-05000700 | 187 |
| 697-85570-11 | REC697-85570-10 | 105 | 69M-E2155-00 | PAF2.6-04040001 | 173 | 6AH-12414-00 | PAF20-05000702 | 65-138-187 |
| 697-W0001-02 | REC697-W0001-02 | 239 | 69M-E2413-00-1S | PAF2.6-04000501 | 173 | 6AH-12481-00 | PAF20-05000016 | 187 |
| 697-W0001-A0 | REC697-W0001-02 | 251-254 | 69M-E3102-00 | PAF2.6-04050100 | 171 | 6AH-13300-00 | PAF20-05030400 | 189 |
| 698-W0001-21 | REC698-W0001-21 | 145-368 | 69M-E5111-00-1S | PAF2.6-04050001 | 171 | 6AH-13329-00 | REC6AH-13329-00 | 271 |
| 69D-45501-10 | REC69D-45501-10 | 390 | 69M-E5363-00 | PAF15-07050004 | 171-180 | 6AH-13329-10 | PAF20-05030010 | 189 |
| 69D-W0001-20 | REC69D-W0001-20 | 146 | 69M-E5396-00 | PAF2.6-04060001 | 171 | 6AH-15100-00 | PAF20-05010000 | 187 |
| 69G-45315-A0 | PAF20-04000001 | 292 | 69M-E5396-00-5B | PAF2.6-04060000 | 171 | 6AH-15312-00 | REC6AH-15312-00 | 271 |
| 69G-45331-01-CA | PAF20-04010001 | 292 | 69M-G2743-00 | PAF2.6-04000008 | 171 | 6AH-24410-00 | PAF20-05050000 | 85 |
| 69G-45510-10 | REC69G-45510-10 | 387 | 69M-G4311-00 | PAF2.6-03000014 | 147-154-283 | 6AH-41113-01-1S | PAF20-05000600 | 187 |
| 69G-45510-20 | REC69G-45510-20 | 387 | 69M-G4323-00 | PAF2.6-03000010 | 148-154-283 | 6AH-41114-00 | PAF20-05000602 | 187 |
| 69G-W0001-20 | REC69G-W0001-20 | 144-289 | 69M-G4328-00 | PAF2.6-03000016 | 283 | 6AH-44150-00 | PAF20-04020000S | 292 |
| 69G-W0078-00 | REC69G-W0078-01 | 150 | 69M-G5300-00-4D | PAF2.6-03020000S | 283 | 6AH-44150-10 | PAF20-04020000L | 292 |
| 69G-W0078-01 | REC69G-W0078-01 | 150 | 69M-G5300-01-4D | PAF2.6-03020000L | 283 | 6AH-44311-00 | PAF20-04040001 | 147-293 |
| 69J-11181-03 | REC69J-11181-03 | 216-218 | 69M-G5311-00-4D | PAF2.6-03000001 | 283 | 6AH-44361-01 | PAF20-02000101S | 293 |
| 69J-11182-03 | REC69J-11182-03 | 216-218 | 69M-G5315-A0 | PAF2.6-03000007 | 283 | 6AH-44361-11 | PAF20-02000101L | 293 |
| 69J-11351-11 | REC69J-11351-11 | 213-218 | 69M-G5321-00-9A | PAF2.6-03000008 | 283 | 6AH-44365-00 | PAF20-02000007 | 293 |
| 69J-12111-00 | REC69J-12111-00 | 211 | 69M-G5361-00-4D | PAF2.6-03000300 | 283 | 6AH-44368-00 | PAF20-02000005 | 293 |
| 69J-12119-00 | REC69J-12119-00 | 211 | 69M-G5361-00-4D | PAF2.6-03000301 | 283 | 6AH-45251-00 | TEN01154 | 169 |
| 69J-13440-00 | REC35-822626Q15 | 83 | 69M-G5511-00 | PAF2.6-03000011S | 283 | 6AH-45251-00 | TEN01154AL | 65-165 |
| 69J-13440-01 | REC35-822626Q15 | 83-211-213 | 69M-G5635-00 | PAF2.6-03000020 | 283 | 6AH-45300-00-4D | PAF20-04000000S | 277 |
| 69J-13440-03 | REC35-822626Q15 | 71-72-73-83 | 69M-WE0090-01-1S | POWERHEAD2.6 | 173 | 6AH-45300-10-8D | PAF20-04000000S | 277-292 |
| 69J-13645-A1 | REC69J-13645-00 | 273 | 69P-11412-00 | REC6G0-11412-00 | 229-256 | 6AH-45300-10-4D | PAF20-04000000L | 277 |
| 69J-13761-00 | REC69J-13761-00 | 90 | 69P-11422-00 | REC6G0-11422-00 | 229-256 | 6AH-45300-10-8D | PAF20-04000000L | 277-292 |
| 69J-13906-00 | REC69J-13906-00 | 89-90 | 69P-11432-00 | REC6G0-11432-00 | 229-256 | 6AH-45510-10 | PAF20-04030000S | 293 |
| 69J-13907-00 | REC69J-13907-03 | 86 | 69P-11442-00 | REC6G0-11442-00 | 229-256 | 6AH-46241-00 | PAF20-05000003 | 189-267 |
| 69J-13907-01 | REC69J-13907-03 | 86 | 69P-85541-09 | REC69P-85541-09 | 107 | 6AH-81800-00 | PAF20-05000900W | 111 |
| 69J-13907-02 | REC69J-13907-03 | 86 | 69W-43880-00 | PH200-T036 | 122 | 6AH-81800-01 | | |

| R.O. / OEM | REF | | R.O. / OEM | REF | | R.O. / OEM | REF | |
|-----------------|-----------------|--------------------|-----------------|---------------------|----------------------|-----------------|--------------------|---------------------------------|
| 6AH-85510-00 | PAF20-05000200 | 121 | 6BX-E1111-00-1S | PAF6-04050100 | 179 | 6E0-43118-00 | REC6E0-43118-01 | 134 |
| 6AH-85540-00 | PAF20-05000300 | 118 | 6BX-E1168-00 | PAF6-04010004 | 179 | 6E0-43118-01 | REC6E0-43118-01 | 134 |
| 6AH-85550-00 | PAF20-05000500 | 109 | 6BX-E1191-00-5B | PAF6-04000004 | 179 | 6E0-44311-00 | PAF4-03000019 | 154-345 |
| 6AH-85550-10 | PAF20-05000500W | 109 | 6BX-E2155-00 | PAF6-04050004 | 179 | 6E0-44315-A0 | PAF4-03000018 | 345 |
| 6AH-85580-00 | PAF20-05000100 | 107 | 6BX-E2170-00 | PAF6-04030000 | 179 | 6E0-44322-02 | PAF4-03000017 | 285 |
| 6AH-W0078-00 | REC6AH-W0078-00 | 150-153-292 | 6BX-F4323-00 | PAF6-04000020 | 179 | 6E0-44322-02 | REC6E0-44322-02 | 154-155-345 |
| 6AH-W0078-01 | REC6AH-W0078-00 | 150-292 | 6BX-G4150-00 | PAF4-03020000S | 287 | 6E0-44323-00 | PAF4-03000015 | 154-155-285-345 |
| 6AH-W0078-01 | REC6AH-W0078-00 | 65-154 | 6BX-G4150-10 | PAF4-03020000L | 287 | 6E0-44328-00 | PAF4-03000020 | 345 |
| 6AH-W009B-02-1S | PAF20-05000000 | 189 | 6BX-G4315-01 | PAF4-03000018 | 287 | 6E0-44352-00 | CEF500325 | 143 |
| 6AQ-1132N-00 | TEN01171 | 73-167-169 | 6BX-WG0078-00 | REC6EE-W0078-01 | 150 | 6E0-44352-00 | PAF4-03060000 | 64-285 |
| 6AU-12121-00 | PAF6-04050002 | 179 | 6C5-11650-00 | PAF25-05020200 | 195-203-207 | 6E0-44352-00 | REC6E0-44352-00 | 143-154-155-287-345 |
| 6AV-45251-00 | TEN01138 | 164 | 6C5-11650-10 | PAF25-05020200 | 201-205 | 6E0-44366-00 | PAF4-03000021 | 345 |
| 6AW-11181-00 | REC6AW-11181-00 | 214-216-218 | 6C5-11654-00 | PAF25-05020204 | 195-201-203-205-207 | 6E0-45113-A1 | REC6E0-45113-A1 | 221-252 |
| 6AW-11182-00 | REC6AW-11182-00 | 214-216-218 | 6C5-12858-00 | PAF15-07010003 | 187 | 6E0-45251-11 | CM6E0-45251-11 | 169 |
| 6AW-11325-00 | TEN01170 | 214 | 6C5-13761-00 | REC6C5-13761-00 | 89-90 | 6E0-45251-11-00 | CM6E0-45251-11 | 158 |
| 6AW-11325-00 | TEN01170 | 167 | 6C5-13907-00 | REC866169T00 | 86 | 6E0-45251-11-00 | CM6E0-45251-11A | 65-66-67-68-69-158-169 |
| 6AW-11325-00 | TEN01170 | 73-169 | 6C5-13915-00 | REC6C5-13915-00 | 68-69-70-81 | 6E0-45251-11-00 | TEN01123 | 164-169 |
| 6AW-1132L-00 | TEN01173 | 73-167-169 | 6C5-14984-00 | REC6C5-14984-00 | 68-69-86-88 | 6E0-45251-11-00 | TEN01123AL | 164-169 |
| 6AW-1132M-00 | TEN01176 | 167-169 | 6C5-24251-00 | REC6C5-24251-00 | 67-68-69-70-80 | 6E0-45315-A0 | PAF4-03000011 | 345 |
| 6AW-1132P-00 | TEN01177 | 73-168-169-214 | 6C5-24410-00 | REC6C5-24410-00 | 85 | 6E0-45316-09 | PAF4-03000003 | 285-287 |
| 6AW-1132R-00 | TEN01172 | 73-167-169-214 | 6C5-43800-11 | PAF60-06000000 | 124 | 6E0-45316-09 | REC6E0-45316-00 | 345 |
| 6AW-1132T-00 | TEN01175 | 73-167-169 | 6C5-43800-12 | PAF60-06000000 | 124 | 6E0-45316-09 | REC90340-08002 | 346 |
| 6AW-1132U-00 | TEN01174 | 73-167 | 6C5-43880-00 | PH200-T045 | 123 | 6E0-45317-09 | PAF4-03000002 | 285-287 |
| 6AW-11351-00 | REC6AW-11351-00 | 214-218 | 6C5-43880-01 | PH200-T045 | 123 | 6E0-45317-09 | REC6E0-45317-00 | 345 |
| 6AW-12411-00 | REC6AW-12411-00 | 73-137-214 | 6C5-44361-00 | PAF60-02000007 | 313 | 6E0-45321-01-5B | PAF4-03000012 | 345 |
| 6AW-13907-00 | REC6AW-13907-00 | 86 | 6C5-46241-00 | REC6C5-46241-00 | 195-201-203-205-267 | 6E0-45361-01-4D | PAF4-03050001 | 345-387 |
| 6AW-14613-00 | REC6AW-14613-00 | 272 | 6C5-81800-00 | PH130-0056 | 111 | 6E0-45511-01 | PAF4-0300004S | 285 |
| 6AW-14623-00 | REC6AW-14623-00 | 272 | 6C5-82105-01 | PAT85-0500023 | 112 | 6E0-45511-01 | REC6E0-45511-01 | 345-387 |
| 6AW-14984-00 | REC6AW-14984-00 | 73-88 | 6C5-85885-00 | REC6C5-85885-00 | 90-102 | 6E0-45511-11 | PAF4-0300004L | 285 |
| 6AW-15312-00 | REC6AW-15312-00 | 272 | 6C9-81800-00 | PH130-0076 | 112 | 6E0-45511-11 | REC6E0-45511-11 | 345-387 |
| 6AW-15451-00 | REC6AW-15451-00 | 214-272 | 6CB-11181-00 | REC6CB-11181-00 | 216-218 | 6E0-45551-00 | PAF4-03000007 | 285 |
| 6AW-41134-00 | REC6AW-41134-01 | 270 | 6CB-13016-00 | REC6CB-13016-00 | 70-71-72-73-88 | 6E0-45551-00 | REC6E0-45551-00 | 345-387 |
| 6AW-4380R-00 | REC48630-96J03 | 125 | 6CB-14984-00 | REC6CB-14984-00 | 70-71-72-73-88 | 6E0-45560-00 | REC6E0-45560-00 | 345-387 |
| 6AW-4380R-01 | REC48630-92J00 | 125 | 6CB-24501-01 | REC6CB-24501-01 | 70-72-73 | 6E0-45570-00 | REC6E0-45570-00 | 345-387 |
| 6AW-43880-00 | REC6AW-43880-02 | 123 | 6CB-45611-00 | REC6CB-45611-00 | 335 | 6E0-45611-01 | REC6E0-45611-01 | 345 |
| 6AW-43880-01 | REC6AW-43880-02 | 123 | 6CE-12411-00 | REC6CE-12411-00 | 73-137 | 6E0-45631-00 | REC6E0-45631-00 | 345-387 |
| 6AW-43880-02 | REC6AW-43880-02 | 123 | 6CE-44311-00 | REC6CE-44311-01 | 148 | 6E0-45943-01 | PAF4-03070000 | 287 |
| 6AW-44311-00 | REC6AW-44311-01 | 148-341 | 6CE-44311-01 | REC6CE-44311-01 | 148-335 | 6E0-45943-01-EL | PAF4-03070000 | 285-402 |
| 6AW-44311-01 | REC6AW-44311-01 | 148 | 6CE-44315-00 | REC6CE-44315-00 | 335 | 6E0-45943-01-EL | SOL3011-075-07S | 402 |
| 6AW-44312-00 | REC6AW-44312-00 | 335-341 | 6CE-44323-01 | REC6CE-44323-01 | 335 | 6E0-45949-00 | PAF2.6-03010000 | 287 |
| 6AW-44315-00 | REC6AW-44315-00 | 341 | 6CE-44352-00 | CEF500401N | 143 | 6E0-85540-70 | REC6E0-85540-71 | 119 |
| 6AW-44322-00 | REC6AW-44322-00 | 335-341 | 6CE-44352-00 | REC6CE-44352-00 | 155-335 | 6E0-85540-71 | REC6E0-85540-71 | 119 |
| 6AW-44323-00 | REC6AW-44323-00 | 341 | 6CE-44352-00 | REC6CE-44352-00 | 155-335 | 6E0-85570-00 | REC6E0-85570-00 | 104 |
| 6AW-44336-00 | REC6AW-44336-00 | 341 | 6CE-W0078-00 | REC6CE-W0078-01 | 153 | 6E0-W0001-C1 | REC6E0-W0001-C1 | 144-285-345 |
| 6AW-44352-00 | CEF500389N | 143-155 | 6CE-W0078-01 | REC6CE-W0078-01 | 73-153-334 | 6E0-W0078-00 | PAGB/T820-M5X30 | 345 |
| 6AW-44352-00 | REC6AW-44352-00 | 143-341 | 6CJ-11181-00 | REC6CJ-11181-00 | 205-215-218 | 6E0-W0078-00 | REC6E0-W0078-A2 | 150-153 |
| 6AW-44365-00 | REC6AW-44365-00 | 335-341 | 6CJ-44323-00 | REC6CJ-44323-00 | 317 | 6E0-W0078-01 | PAGB/T820-M5X30 | 345 |
| 6AW-45113-00 | REC6AW-45113-00 | 272 | 6CJ-44324-00 | REC6CJ-44324-00 | 317 | 6E0-W0078-01 | REC6E0-W0078-A2 | 150-153 |
| 6AW-45251 | TEN01112-1 | 166-169 | 6CJ-81800-00 | PH130-0056 | 111 | 6E0-W0078-02 | PAGB/T820-M5X30 | 345 |
| 6AW-45251-00 | CM6AW-45251-00 | 161-169 | 6CJ-W0078-00 | REC6CJ-W0078-00 | 69-151-153-154-314 | 6E0-W0078-02 | REC6E0-W0078-A2 | 150-153-155-285-345 |
| 6AW-45251-00 | CM6AW-45251-00A | 72-161-169 | 6D0-11181-00 | REC6D0-11181-00 | 249-254 | 6E3-14301-05 | REC6E3-14301-05 | 92-93 |
| 6AW-45373-00 | CM6AW-45373-00 | 161-169 | 6D0-41134-00 | REC6D0-41134-00 | 272 | 6E5-11181-A2 | REC6E5-11181-A0 | 245-249-254 |
| 6AW-45373-00 | CM6AW-45373-00A | 161-169-341 | 6D0-44362-01 | REC6D0-44362-01 | 335-339 | 6E5-11193-A0 | REC6E5-11193-A0 | 245-255 |
| 6AW-45373-00 | TEN01155AL | 166-169 | 6D0-44367-00 | REC6D0-44367-00 | 335-339 | 6E5-11325-00 | CM15026A | 158-169 |
| 6AW-45619-00 | CM6AW-45619-00 | 161 | 6D0-45332-00-CA | REC6D0-45332-00-CA | 337 | | | 65-70-72-73-158-169-187-209-213 |
| 6AW-45619-00 | CM6AW-45619-00A | 161-341 | 6D0-45361-00-8D | REC6D0-45361-00-8D | 337 | 6E5-11325-00 | PAF15-07010026 | 183 |
| 6AW-45619-00 | TEN01169 | 165 | 6D0-81800-00 | PH130-0076 | 112 | 6E5-11325-00 | TEN01152 | 163-169-245-247 |
| 6AW-8194A-00 | REC6AW-8194A-00 | 115 | 6D0-W0001-00 | REC6D0-W0001-00 | 252-254 | 6E5-11381-A1 | REC6E5-11381-A1 | 275 |
| 6AW-81950-00 | REC6AW-81950-00 | 115 | 6D3-81960-00 | REC881346T | 117 | 6E5-11381-A2 | REC6E5-11381-A1 | 245-247 |
| 6AW-W0078-00 | REC6AW-W0078-00 | 73-153-155-341 | 6D8-11603-01 | REC6D8-11603-10 | 209 | 6E5-11411-00 | REC6E5-11411-00 | 256 |
| 6B4-11193-A0 | REC6B4-11193-A0 | 140 | 6D8-11604-01 | REC6D8-11604-10 | 209 | 6E5-11447-00 | REC6E5-11447-00 | 245-247 |
| 6B4-11351-A1 | REC6B4-11351-A1 | 252 | 6D8-12111-00 | REC6D8-12111-00 | 209 | 6E5-11610-02 | REC6E5-11610-02 | 265-266-267 |
| 6B4-14301-00 | REC6B4-14301-00 | 91-93 | 6D8-12121-10 | REC6D8-12121-10 | 209 | 6E5-11633-01 | REC6E5-11633-00 | 261-265 |
| 6B4-26301-00 | REC6B4-26301-00 | 130 | 6D8-13761-00 | REC6D8-13761-00 | 89-90 | 6E5-11634-00 | REC6E5-11634-00 | 265 |
| 6B4-45251-00 | TEN01116 | 169-348 | 6D8-24563-00 | REC6D8-WS24A-00 | 80 | 6E5-11650-01 | REC6E5-11650-01 | 261 |
| 6B4-85520-00 | REC6B4-85520-00 | 107 | 6D8-41114-A0 | REC67F-41114-A2 | 209 | 6E5-11651-00 | REC6E5-11651-00 | 261 |
| 6B4-85540-01 | REC6B4-85540-01 | 120 | 6D8-43880-00 | PH200-T068 | 123 | 6E5-12411-00 | REC6E5-12411-02 | 136 |
| 6B4-85570-00 | REC6B4-85570-01 | 104 | 6D8-43880-01 | REC6D8-43880-09 | 123 | 6E5-12411-01 | REC6E5-12411-02 | 136-221-223-229-231-233 |
| 6B4-85570-01 | REC6B4-85570-01 | 104 | 6D8-43880-01 | PH200-T068 | 123 | 6E5-12411-02 | REC6E5-12411-02 | 136-137 |
| 6B4-85580-00 | REC6B4-85580-00 | 107 | 6D8-43880-09 | REC6D8-43880-09 | 123 | 6E5-12411-10 | REC6E5-12411-30 | 137 |
| 6BG-11181-00 | REC6BG-11181-00 | 201-215-218 | 6D8-44341-01 | REC6D8-WS24A-00 | 80 | 6E5-12411-20 | REC6E5-12411-30 | 137 |
| 6BG-13761-00 | REC6BG-13761-00 | 89-90 | 6D8-WS24A-00 | REC6D8-WS24A-00 | 66-67-68-69-70-71-81 | 6E5-12411-30 | REC6E5-12411-30 | 137-227-237-245-247 |
| 6BG-13915-00 | REC6BG-13915-00 | 67-80 | 6D9-12411-00 | REC6D9-12411-00 | 70-137 | 6E5-13411-00 | REC6E5-13411-00 | 83 |
| 6BG-44341-00 | PAT40-04040001 | 313 | 6D9-45551-00 | REC6D9-45551-00 | 319 | 6E5-13645-A1 | REC6E5-13645-A1-00 | 275 |
| 6BG-W0078-00 | REC6BG-W0078-00 | 67-151-153-154-302 | 6DA-11181-00 | REC6DA-11181-00 | 216-218 | 6E5-14198-A2 | REC6E5-14198-A2 | 275 |
| 6BL-11181-00 | REC6BL-11181-00 | 195-215-218 | 6DA-12411-01 | REC6DA-12411-01 | 72-136-137 | 6E5-14323-03 | REC6E5-14323-03 | 99 |
| 6BL-11325-00 | CM6BL-11325-00 | 161 | 6DA-13761-00 | REC6DA-13761-00 | 90 | 6E5-14328-01 | REC6E5-14328-01 | 99 |
| 6BL-11325-00 | CM6BL-11325-00A | 161-195 | 6E0-11193-A1 | REC6E0-11193-A1 | 221 | 6E5-14385-02 | REC6E5-14385-02 | 93-100 |
| 6BL-11325-00 | TEN01161 | 166 | 6E0-11631-00-98 | REC6E0-11631-00-98K | 221-262-266 | 6E5-14386-01 | REC6E5-14386-01 | 99 |
| 6BL-44391-00 | PAF15-05000009 | 139 | 6E0-11651-01 | REC6E0-11651-01 | 221-225-260 | 6E5-14386-02 | REC6E5-14386-02 | 99 |
| 6BR-81800-00 | PH130-0073 | 112 | 6E0-24411-00 | REC6E0-24411-00 | 87 | 6E5-14416-A1 | REC6E5-14416-A1 | 275 |
| 6BR-81800-01 | PH130-0073 | 112 | 6E0-24435-00 | REC6E0-24435-00 | 87 | 6E5-14483-A1 | REC6E5-14483-A1 | 275 |
| 6BX-11181-00 | PAF6-04000002 | 179-215 | 6E0-24471-00 | REC6E0-24471-00 | 87 | 6E5-14546-00 | REC6E5-14546-00 | 93-9 |

| R.O. / OEM | REF | | R.O. / OEM | REF | | R.O. / OEM | REF | |
|-----------------|--------------------|---|-----------------|--------------------|---------------------|-----------------|--------------------|-----------------|
| 6E5-24305-06-00 | GS31076 | 76 | 6E5-81800-10 | PH130-0005 | 110 | 6F5-11650-11 | REC6R5-11650-10 | 247 |
| 6E5-24351-00 | REC6E5-24351-51 | 75 | 6E5-81800-11 | PH130-0005 | 110 | 6F5-11651-00 | REC6F5-11651-00 | 233-235-260-261 |
| 6E5-24351-51 | REC6E5-24351-51 | 75 | 6E5-81800-12 | PH130-0005 | 110 | 6F5-11681-00 | REC6F5-11681-00 | 235-261 |
| 6E5-24377-00 | PAF15-07010006 | 181-183 | 6E5-81900-01 | REC6E5-81900-01 | 84 | 6F5-12411-00 | REC6F5-12411-03 | 137 |
| 6E5-24410-01-00 | REC6E5-24410-03 | 85 | 6E5-81941-11 | REC61A-81941-00 | 114 | 6F5-12411-01 | REC6F5-12411-03 | 137 |
| 6E5-24411-00-00 | REC6E5-24411-00 | 87 | 6E5-81950-01 | PH375-0047 | 110-115 | 6F5-12411-02 | REC6F5-12411-03 | 137-235-239 |
| 6E5-24434-02 | REC6E5-24434-02 | 88 | 6E5-81950-01 | REC89-825096T01 | 114 | 6F5-12411-03 | REC6F5-12411-03 | 137 |
| 6E5-24435-00 | REC6E5-24435-00 | 88 | 6E5-8195A-01 | PH375-0048 | 115 | 6F5-13621-A1 | REC6F5-13621-A1 | 275 |
| 6E5-24471-00 | REC6E5-24471-00 | 87 | 6E5-8195C-01 | PH375-0048 | 115 | 6F5-13645-A1 | REC6F5-13645-A0 | 274 |
| 6E5-41112-A1 | REC6E5-41112-A1 | 142-245 | 6E5-82570-05 | REC704-82570-12 | 128 | 6F5-13646-A1 | REC6F5-13646-A2 | 274 |
| 6E5-41134-A0 | REC6E5-41134-A0 | 269-270 | 6E5-85510-10 | REC6E5-85510-11 | 121 | 6F5-14198-A1 | REC6F5-14198-A1 | 275 |
| 6E5-43880-00 | PH200-T037 | 123 | 6E5-85510-11 | REC6E5-85510-11 | 121 | 6F5-14323-01 | REC6F5-14323-00 | 98 |
| 6E5-43880-01 | PH200-T037 | 123 | 6E5-85540-10 | REC6E5-85540-12 | 119 | 6F5-14384-00 | REC6F5-14384-00 | 94 |
| 6E5-43880-02 | PH200-T037 | 123 | 6E5-85540-11 | REC6E5-85540-12 | 119 | 6F5-14390-21 | REC6F5-14390-21 | 98 |
| 6E5-44150-01 | REC6E5-44150-02 | 377 | 6E5-85540-12 | REC6E5-85540-12 | 119 | 6F5-14398-00 | REC6F5-14398-00 | 94 |
| 6E5-44311-00 | REC61A-44311-00 | 148 | 6E5-85570-10 | REC6E5-85570-11 | 105 | 6F5-14483-00 | REC6F5-14483-00 | 94 |
| 6E5-44311-00 | REC6E5-44311-00 | 155-156-157-381 | 6E5-85570-11 | REC6E5-85570-11 | 105 | 6F5-15396-01-5B | REC6F5-15396-01-5B | 235 |
| 6E5-44312-00 | REC6E5-44312-00 | 325-329-333-339-385-386 | 6E5-W0001-A2 | REC6E5-W0001-A2 | 251 | 6F5-15713-00 | REC66T-15713-00 | 112 |
| 6E5-44315-A0 | REC6E5-44315-A0 | 156-157-325-329-333-377-381-385 | 6E5-W0001-A2 | REC6E5-W0001-A2 | 254 | 6F5-15713-01 | REC66T-15713-01 | 112 |
| 6E5-44322-00 | REC6E5-44322-00 | 156-157-381 | 6E5-W0001-F1 | REC6E5-W0001-F1 | 147-374-378 | 6F5-24563-00 | REC6F5-24563-00 | 80-81-82 |
| 6E5-44323-00 | REC6E5-44323-00-40 | 149-155-156-157-377 | 6E5-W0078-02 | REC6N6-W0078-02 | 374 | 6F5-26311-00 | REC6F5-26311-00 | 130 |
| 6E5-44352-01 | CEF500371 | 143 | 6E5-W0093-06 | REC6E5-W0093-06 | 97-245 | 6F5-41111-01-1S | REC6F5-41111-01-1S | 235 |
| 6E5-44352-01 | REC6E5-44352-01 | 143-155-156-157-325-329-333-339-377-381-385-386 | 6E5-W0093-07 | REC6E5-W0093-07 | 97 | 6F5-41112-A0 | REC6F5-41112-A0 | 141-235 |
| 6E5-44365-00 | REC6E5-44365-00 | 155-157-325-329-333-339-377-381-385-386 | 6E5-W0093-08 | REC6E5-W0093-08 | 97 | 6F5-41113-01-1S | REC6F5-41113-01-1S | 235 |
| 6E5-44366-00 | REC6E5-44366-00 | 155-156-157-325-333-339-377-381 | 6E7-11111-01-1S | REC6E7-11111-01-1S | 227 | 6F5-41114-A0 | REC6F5-41114-A0 | 142-235 |
| 6E5-45113-A0 | REC6E5-45113-A2 | 253-254 | 6E7-11181-A2 | REC6E7-11181-00 | 248-254 | 6F5-44352-00 | CEF500352 | 143 |
| 6E5-45114-A0 | REC6E5-45114-00 | 272 | 6E7-11631-00 | REC6E7-11631-00K | 262 | 6F5-44352-02 | REC6F5-44352-00 | 143-363 |
| 6E5-45251-00 | CM6E5-45251-00 | 158-169 | 6E7-11631-00-97 | REC6E7-11631-00K | 227-266 | 6F5-44352-02 | REC6F5-44352-00 | 156-367 |
| 6E5-45251-00 | TEN01105 | 164-169 | 6E7-11635-00 | REC6E7-11635-00K | 227-262 | 6F5-45113-A0 | REC6F5-45113-A0 | 235-253-254 |
| 6E5-45251-00 | TEN01129 | 165 | 6E7-11636-00 | REC6E7-11636-00K | 227-262 | 6F5-45312-01-4D | REC6F5-45312-00-4D | 363 |
| 6E5-45300-16-8D | REC405-A20 | 375 | 6E7-14227-00 | REC6E7-14227-00 | 94 | 6F5-45551-00 | REC6F5-45551-00 | 363-389-390 |
| 6E5-45300-17-8D | REC405-A20 | 280 | 6E7-14385-00 | REC6E7-14385-00 | 93-100 | 6F5-45560-00 | REC6F5-45560-00 | 363-389-390 |
| 6E5-45300-26-8D | REC405-A25 | 375 | 6E7-44366-00 | REC6E7-44366-00 | 349 | 6F5-45570-00 | REC6F5-45570-00 | 363-389-390 |
| 6E5-45300-27-8D | REC405-A25 | 280 | 6E7-45331-00-9M | REC6E7-45331-00-CA | 349 | PH130-0062 | PH130-0062 | 110 |
| 6E5-45321-00 | REC6E5-45321-00 | 325-329-377-381 | 6E7-45501-00 | REC6E7-45501-00 | 349 | PH130-0062 | PH130-0062 | 110 |
| 6E5-45331-00-94 | REC6E5-45331-00-94 | 377-381 | 6E7-45501-11 | REC6E7-45501-11 | 349-387-388 | 6F5-81800-11 | REC6F5-81800-11 | 119 |
| 6E5-45331-00-9S | REC6E5-45331-00-94 | 325-329 | 6E7-45536-00 | REC6E7-45536-00 | 349 | 6F5-85540-22 | REC6F5-85540-22 | 119 |
| 6E5-45331-00-9S | REC6E5-45331-00-94 | 391 | 6E7-45551-00 | REC6E7-45551-00 | 348-387-388 | 6F5-W0001-C0 | REC6F5-W0001-C0 | 145-363 |
| 6E5-45332-00-94 | REC6E5-45332-00-94 | 375 | 6E7-45560-00 | REC6E7-45560-01 | 349 | 6F5-W0078-00 | REC6F5-W0078-A0 | 151 |
| 6E5-45332-00-CA | REC6E5-45332-00-94 | 323 | 6E7-45560-01 | REC6E7-45560-01 | 291-293-351-387-388 | 6F5-W0078-A0 | REC6F5-W0078-A0 | 156-363 |
| 6E5-45344-00 | REC6E5-45344-00 | 325-329-333-339-377-381-385 | 6E7-45570-00 | REC6E7-45570-00 | 293 | 6F6-11111-00-1S | REC6F6-11111-00-1S | 235 |
| 6E5-45371-00 | CM6E5-45371-01A | 323 | 6E7-45571-00 | REC6E7-45570-00 | 291-349-351-387-388 | 6F6-11191-00-1S | REC6F6-11191-00-1S | 235 |
| 6E5-45371-00 | TEN01153 | 164 | 6E7-45587-01-30 | PAF15-06000009 | 348 | 6F6-11193-A1 | REC6F6-11193-A1 | 235-255 |
| 6E5-45371-01 | CM6E5-45371-01A | 161-379 | 6E7-45987-01 | REC6E7-45987-00 | 291-349 | 6F6-11400-01 | REC6F6-11400-02 | 235 |
| 6E5-45371-01 | REC6E5-45371-01 | 161-169-375 | 6E7-45987-01 | PAF15-06000015 | 351 | 6F6-11610-00 | REC6F5-11610-20 | 235 |
| 6E5-45371-10 | CM6E5-45371-10 | 160 | 6E7-45987-01 | REC6E7-45987-00 | 293-351-405 | 6F6-11610-010 | REC6F5-11610-20 | 235 |
| 6E5-45371-10 | TEN01153 | 370-375 | 6E7-85570-19-00 | REC6E7-85570-19 | 106 | 6F6-11631-00-95 | REC6F6-11631-00K | 235-263 |
| 6E5-45501-01 | REC6E5-45501-01 | 377-391 | 6E7-W0001-00 | REC6E7-85570-19 | 106 | 6F6-11635-00 | REC6F6-11635-00K | 235-263 |
| 6E5-45536-00 | REC6E5-45536-00 | 325-377 | 6E7-W0001-01 | REC6E7-W0001-A1 | 249 | 6F6-11636-00 | REC6F6-11636-00K | 235-263 |
| 6E5-45536-01 | REC6E5-45536-00 | 329 | 6E7-W0001-A1 | REC6E7-W0001-A1 | 249-254 | 6F6-13610-00 | REC6F6-13610-00 | 99 |
| 6E5-45551-02 | REC6E5-45551-00 | 375-391 | 6E7-W0093-04 | REC6E7-W0093-04 | 95 | 6F6-14301-06 | REC6F6-14301-06 | 91 |
| 6E5-45560-01 | REC6E5-45560-00 | 375-391 | 6E8-14390-12 | REC6E8-14390-12 | 98 | 6F6-14341-00 | REC6F6-14341-00 | 98 |
| 6E5-45567-01 | REC6E5-45567-01 | 323 | 6E8-45251-00 | CM6E8-45251-00 | 159 | 6F6-14385-00 | REC6F6-14385-00 | 100 |
| 6E5-45576-00 | REC6E5-45576-00 | 375-391 | 6E8-45251-02 | TEN01106 | 164 | 6F6-45611-00 | REC6F6-45611-00 | 363-389-390 |
| 6E5-45576-01 | REC6E5-45576-01 | 323-375 | 6E8-45251-02 | CM6E8-45251-01 | 159-169 | 6F6-85530-01 | REC6F6-85530-01 | 106 |
| 6E5-45577-01 | REC6E5-45577-01 | 323-375 | 6E8-45587-10 | TEN01116 | 164 | 6F6-85540-01 | REC6F6-85540-01 | 118 |
| 6E5-45611-00 | REC6E5-45611-00 | 323 | 6E8-45587-10-13 | PAF15-06000008 | 293 | 6F6-W0001-02 | REC6F6-W0001-02 | 234-251 |
| 6E5-45631-01 | REC6E5-45631-00 | 375-391-392 | 6E9-11193-A0 | PAF15-06000008 | 291-351 | 6F6-W0093-00 | REC6F6-W0093-00 | 96-234 |
| 6E5-45633-01 | REC6E5-45633-01 | 323-327-335-375-379-391-392 | 6E9-12413-00-1S | PAF15-06000009 | 293 | 6F8-11181-A1 | REC6F8-11181-A0 | 220-248-254 |
| 6E5-45634-01 | REC6E5-45634-01 | 323-327-375 | 6E9-12414-A1 | REC6E9-12413-00-1S | 139-235 | 6FM-12411-00 | REC6FM-12411-00 | 66-136-137 |
| 6E5-45634-02 | REC6E5-45634-01 | 327 | 6E9-14198-A0 | REC6E9-12414-A1 | 138-139-235 | 6FM-13761-00 | REC6FM-13761-00 | 90 |
| 6E5-45641-02 | REC6E5-45641-03 | 375 | 6E9-24378-00 | REC6E9-12414-A1 | 275 | 6FP-12411-00 | REC6FP-12411-00 | 70-137 |
| 6E5-45641-03 | REC6E5-45641-03 | 327-379 | 6E9-41114-A0 | REC6E9-14198-A0 | 275 | 6G0-11181-00 | REC6G0-11181-00 | 261 |
| 6E5-45941-00-EL | SOL3411-130-19 | 402 | 6E9-81970-70 | PAF4-04010102 | 187 | 6G0-82519-00 | PAF6-04000009 | 179 |
| 6E5-45941-00-EL | SOL3413-125-19 | 402 | 6E9-82575-00 | REC6E9-41114-A0 | 142 | 6G0-85540-11 | REC6G0-85540-11 | 119 |
| 6E5-45943-00-EL | SOL3411-130-21 | 402 | 6E9-82575-02 | REC6E9-81970-62 | 116 | 6G1-11193-A1 | REC6G1-11193-A1 | 140-223 |
| 6E5-45943-00-EL | SOL3413-125-21 | 402 | 6E9-W0093-02 | REC6E9-82575-02 | 120 | 6G1-11610-00 | REC6G1-11610-00 | 221-262-266 |
| 6E5-45945-00-EL | SOL3411-133-17 | 402 | 6E9-W0093-02 | REC6E9-W0093-02 | 96 | 6G1-11633-00 | REC6G1-11633-00 | 221-225-260-262 |
| 6E5-45945-00-EL | SOL3413-128-17 | 402 | 6E9-W0093-03 | REC6E9-W0093-03 | 96 | 6G1-11681-00 | REC6G1-11681-00 | 221-223-225-260 |
| 6E5-45947-00-EL | SOL3411-135-15 | 402 | 6EE-E5362-00 | PAF4-04000036 | 177 | 6G1-13621-A1 | REC6G1-13621-A1 | 273 |
| 6E5-45947-00-EL | SOL3413-130-15 | 402 | 6EE-E5396-00-CA | PAF4-04060000 | 177 | 6G1-13645-A1 | REC6G1-13645-A1 | 273 |
| 6E5-45949-00-EL | SOL3411-138-13 | 402 | 6EE-F4251-00 | REC68T-24251-00 | 80 | 6G1-14198-A1 | REC6G1-14198-A1 | 273 |
| 6E5-45949-00-EL | SOL3413-133-13 | 402 | 6EE-G2177-00 | PAF4-01090300 | 134 | 6G1-14301-01 | REC6G1-14301-01 | 91-93 |
| 6E5-45954-00-EL | SOL3411-140-11 | 402 | 6EE-G4315-00 | PAF4-03000018 | 64-154 | 6G1-14546-01 | REC6G1-14546-00 | 93-98 |
| 6E5-45978-01 | REC6E5-45987-00 | 379 | 6EE-G4366-00 | PAF4-03000021 | 154-155 | 6G1-15755-00 | PAF4-04130100 | 113 |
| 6E5-45987-01 | REC6E5-45987-00 | 375-405 | 6EE-G5987-00 | PAF4-03000025 | 405 | 6G1-15779-00 | PAF4-04130100 | 113 |
| 6E5-61301-00 | GS41084 | 131 | 6EE-W0078-00 | REC6EE-W0078-01 | 150 | 6G1-24304-02 | REC6G1-24304-02 | 77 |
| 6E5-61301-01 | GS41084 | 131 | 6EE-W0078-01 | REC6EE-W0078-01 | 150 | 6G1-24305-02 | GS31075 | 76 |
| | | | 6EG-G2138-00 | REC6E9-11181-A2 | 235 | 6G1-24305-02-00 | GS31075 | 76 |
| | | | 6EK-13761-00 | REC6F5-11181-A2 | 248-254 | 6G1-24305-03 | GS31075 | 76 |
| | | | 6EK-4380R-00 | REC6G5-11193-A0 | 247 | 6G1-24305-03-00 | GS31075 | 76 |
| | | | 6EK-44323-00 | REC6F5-11515-00 | 233-235 | 6G1-24305-04 | GS31075 | 76 |
| | | | 6F3-W0001-21 | REC6F5-11610-00 | | | | |

| R.O. / OEM | REF | | R.O. / OEM | REF | | R.O. / OEM | REF | |
|-----------------|------------------|--------------|-----------------|--------------------|--------------|-----------------|--------------------|--------------|
| 6G1-24471-00 | REC6G1-24471-00 | 87 | 6G5-45949-00-98 | SOL3512-142-23 | 403 | 6H1-45611-01-00 | REC6H1-45611-00 | 373-390-391 |
| 6G1-41112-A1 | REC6G1-41112-A1 | 140-223 | 6G5-45949-00-98 | SOL3513-140-21 | 403 | 6H1-45631-01-00 | REC6H1-45631-01 | 373-390-391 |
| 6G1-41114-A0 | REC6G1-41114-A0 | 140-223 | 6G5-45949-00-98 | SOL3571-148-23 | 403 | 6H1-45634-02 | REC6H1-45634-02 | 373 |
| 6G1-41133-A0 | REC6G1-41133-A0 | 268 | 6G5-45949-00-98 | SOL3571-150-21 | 403 | | | 315-319-331- |
| 6G1-42138-00 | PAF4-01090100 | 131 | 6G5-45952-00-98 | SOL3512-150-15 | 403 | | | 335-337-341- |
| 6G1-42138-01 | PAF4-01090100 | 131 | 6G5-45952-00-98 | SOL3514-148-15 | 403 | 6H1-45668-00 | REC6H1-45668-00 | 373-383 |
| 6G1-44315-A0 | REC6G1-44315-A0 | 155-346 | 6G5-45952-00-98 | SOL3572-158-15 | 403 | 6H1-81950-00 | REC6H1-81950-01 | 115 |
| 6G1-44322-00 | REC6G1-44322-00 | 155-346 | 6G5-45970-02-98 | SOL3531-145-15 | 403 | 6H1-81950-01 | REC6H1-81950-01 | 115 |
| 6G1-44323-00 | REC6G1-44323-00 | 155-346 | 6G5-45972-02-98 | SOL3531-140-21 | 403 | 6H1-85510-00 | REC6H1-85510-00 | 121 |
| 6G1-44328-00 | REC6G1-44328-00 | 346 | 6G5-45974-03-98 | SOL3531-140-19 | 403 | 6H1-W0001-A1 | REC6H1-W0001-00-00 | 251 |
| 6G1-44352-00 | CEF500302 | 143 | 6G5-45976-01-98 | SOL3531-140-23 | 403 | 6H1-W0093-01 | REC6H1-W0093-01-00 | 97 |
| 6G1-44352-00 | REC6G1-44352-00 | 143-155-346 | 6G5-45978-03-98 | SOL3531-143-17 | 403 | 6H1-W0093-01-00 | REC6H1-W0093-01-00 | 243 |
| 6G1-45113-A1 | REC6G1-45113-A1 | 223-252 | 6G5-81960-A0 | REC6G5-81960-A0 | 116 | 6H1-W0093-10 | REC6H1-W0093-10 | 97 |
| 6G1-45214-00 | PAF15-06000003 | 289-293-350 | 6G5-85510-10 | REC6G5-85510-11 | 121 | 6H14525102 | CM6H1-45251-02 | 158-169 |
| 6G1-45215-00 | PAF15-06000002 | 289 | 6G5-85540-10 | REC6G5-85540-12 | 119 | | | 69-70-71- |
| 6G1-45251-02 | CM6G1-45251-02 | 159-169 | 6G5-85540-11 | REC6G5-85540-12 | 119 | | | 158-169 |
| 6G1-45251-02 | TEN01108 | 165-169 | 6G5-85540-12 | REC6G5-85540-12 | 119 | 6H2-81960-10 | REC6H2-81960-10 | 116 |
| 6G1-45251-03 | CM6G1-45251-03 | 159-169 | 6G5-W0001-03 | REC6G5-W0001-A3 | 252 | 6H2-85540-10 | REC6H2-85540-13 | 118 |
| 6G1-45251-03 | TEN01118 | 164-169 | 6G5-W0001-03 | REC6G5-W0001-A3 | 254 | 6H2-85540-11 | REC6H2-85540-13 | 118 |
| 6G1-45315-A0 | REC6G1-45315-A0 | 346 | 6G5-W0001-A3-00 | REC6G5-W0001-A3 | 247 | 6H2-85540-12 | REC6H2-85540-13 | 118 |
| 6G1-45316-09 | REC6G1-45316-09 | 289 | 6G5-W0078-00 | REC6G5-W0078-A1 | 152 | 6H2-85540-13 | REC6H2-85540-13 | 118 |
| 6G1-45317-09 | REC6G1-45317-09 | 289 | 6G5-W0078-01 | REC6G5-W0078-A1 | 152 | 6H2-W0001-20 | REC6H2-W0001-20 | 146 |
| 6G1-45362-09 | REC6G1-45362-09 | 289 | 6G5-W0078-A1 | REC6G5-W0078-A1 | 152 | 6H2-W0093-10 | REC6H2-W0093-10 | 96-241 |
| 6G1-45611-01 | REC6G1-45611-01 | 346-387 | 6G8-11181-00 | REC6G8-11181-A1 | 181 | 6H3-11181-A2 | REC6H3-11181-A0 | 241-248-254 |
| 6G1-45631-00 | REC6G1-45631-00 | 346-387 | 6G8-11181-A1 | REC6G8-11181-A1 | 215-218 | 6H3-11193-A1 | REC6H3-11193-A1 | 241-255 |
| 6G1-45941-00-EL | SOL3011-085-09 | 402 | 6G8-11197-01 | PAF20-05030009 | 203-205 | 6H3-11325-01 | CM6H3-11325-01A | 241 |
| 6G1-45943-00-EL | SOL3011-085-08 | 402 | 6G8-11197-A0 | PAF20-05030009 | 187 | 6H3-11631-01-96 | REC6H3-11631-01K | 241-262-266 |
| 6G1-45947-00-EL | SOL3011-085-07 | 402 | 6G8-11325-00 | CM6G8-11325-00 | 159-169-181 | 6H3-11633-00 | REC6H3-11633-00 | 241-261-262- |
| 6G1-81940-00 | REC89-825096T01 | 114 | | | 65-159-180- | | | 264 |
| 6G1-81941-10 | PAF15-05170300W | 111-114 | 6G8-11325-00 | CM6G8-11325-00A | 187-195-201- | 6H3-11635-01 | REC6H3-11635-01K | 241-262 |
| 6G1-81941-10 | REC89-825096T01 | 110 | | | 203-205 | 6H3-11636-01 | REC6H3-11636-01K | 241-262 |
| 6G1-81970-00 | REC6G1-81970-62 | 116 | 6G8-11325-00 | TEN01148 | 203-205 | 6H3-12411-00 | REC6H3-12411-10 | 137 |
| 6G1-81970-60 | REC6G1-81970-62 | 116 | 6G8-11351-00 | REC6G8-11351-A0 | 163-169 | 6H3-12411-01 | REC6H3-12411-10 | 137 |
| 6G1-81970-61 | REC6G1-81970-62 | 116 | 6G8-11351-A0 | REC6G8-11351-A0 | 181 | 6H3-12411-10 | REC6H3-12411-10 | 137 |
| 6G1-81970-62 | REC6G1-81970-62 | 116 | 6G8-11351-A0 | REC6G8-11351-A0 | 217 | 6H3-12411-11 | REC6H3-12411-10 | 137-241 |
| 6G1-81970-A0 | REC6G1-81970-62 | 116 | 6G8-12411-00 | REC6AH-12411-00 | 218 | 6H3-12411-11 | REC6H3-12411-10 | 137 |
| 6G1-W0001-C0 | REC6G1-W0001-C1 | 144 | 6G8-12411-02 | PAF15-07000031 | 181 | 6H3-12413-00-1S | PAF15-07010021 | 197-207-241 |
| 6G1-W0078-00 | REC6G1-W0078-A1 | 150 | 6G8-12411-03 | PAF15-07000031 | 191 | 6H3-12413-00-9M | PAF15-07010021 | 191 |
| 6G1-W0078-01 | REC6G1-W0078-A1 | 150 | | | 195-197-201- | 6H3-12413-00S | PAF15-07010021 | 183 |
| 6G1-W0078-A1 | REC6G1-W0078-A1 | 150-346 | | | 203-205-207 | 6H3-12414-A1 | REC6H3-12414-A1 | 138-241 |
| 6G1-W0078-A1 | REC6G1-W0078-A1 | 155 | | | 66-67-68-69- | 6H3-13621-A1 | REC6H3-13621-A1 | 274 |
| 6G1-W0093-00 | REC6G1-W0093-00 | 93-95-223 | 6G8-12414-00 | REC6G8-12414-A0 | 137 | 6H3-13622-A1 | REC6H3-13622-A1 | 274 |
| 6G5-11181-A3 | REC6G5-11181-A2 | 247-249-254 | 6G8-12414-A0 | REC6G8-12414-A0 | 181 | 6H3-14198-A1 | REC6H3-14198-A1 | 274 |
| 6G5-11193-A1 | REC6G5-11193-A0 | 255 | 6G8-12414-A0 | REC6G8-12414-A0 | 138 | 6H3-14457-01 | REC6H3-14457-01 | 94 |
| 6G5-11382-A1 | REC6G5-11382-A1 | 142-245-247 | 6G8-13440-00 | REC6G8-13440-00 | 83 | 6H3-14590-01 | REC6H3-14590-00 | 93-98 |
| 6G5-11411-02 | REC6G5-11411-02 | 247-256 | 6G8-13645-00 | REC6G8-13645-00 | 273 | 6H3-41112-A0 | REC6H3-41112-A0 | 141-241 |
| 6G5-11631-00-93 | REC6G5-11631-00K | 265-266-267 | 6G8-13646-00 | REC6G8-13646-A0 | 273 | 6H3-41114-A0 | REC6H3-41114-A0 | 141-241 |
| 6G5-11642-00-93 | REC6G5-11642-00K | 265-266-267 | 6G8-14198-00 | REC6G8-14198-A0 | 273 | 6H3-41217-00 | REC6H3-41217-00 | 101 |
| 6G5-12416-00 | REC60H-12416-00 | 209-211 | 6G8-15363-00 | PAF15-07050004 | 181-185-187- | 6H3-44311-00 | REC6H3-44311-00 | 148 |
| 6G5-13645-A2 | REC6G5-13645-A1 | 276 | | | 191-195-197- | 6H3-44315-00 | REC6H3-44315-00 | 154-156 |
| 6G5-14416-A1 | REC6G5-14416-A1 | 275 | | | 201-203-205- | 6H3-44323-00-00 | REC6H3-44323-00 | 149-154-156 |
| 6G5-14483-A1 | REC6G5-14483-01 | 276 | | | 207-209-211- | 6H3-44352-00 | CEF500316 | 143 |
| 6G5-41112-A1 | REC6G5-41112-A1 | 142-247 | 6G8-15374-00 | REC6G8-15374-00 | 213-214 | 6H3-44352-00 | REC6H3-44352-00 | 143-154-156- |
| 6G5-41114-A0 | REC6G5-41114-A0 | 142-247 | 6G8-41112-02 | REC6G8-41112-02 | 140-181 | 6H3-44391-00 | PAF15-05000009 | 313-317 |
| 6G5-41134-A1 | REC6G5-41134-A1 | 270 | 6G8-41114-00 | REC6G8-41114-00 | 171 | 6H3-44391-01 | PAF15-05000009 | 139 |
| 6G5-41217-01 | REC6G5-41217-01 | 101 | 6G8-44532-00 | PAF2.6-04000009 | 171 | 6H3-45113-00 | REC6H3-45113-00 | 241 |
| 6G5-43864-00 | REC6G5-43864-00 | 125 | 6G8-45113-A1 | REC6G8-45113-A1 | 271 | 6H3-45113-A0 | REC6H3-45113-00 | 253-254 |
| 6G5-43880-00 | PH200-T030 | 123 | 6G8-45251-00 | CM6G8-45251-01 | 159-169 | 6H3-45114-A1 | REC6H3-45114-A1 | 271 |
| 6G5-43880-01 | PH200-T030 | 123 | 6G8-45251-00 | TEN01137 | 164-169 | 6H3-45123-00 | REC6H3-45123-00 | 269 |
| 6G5-43880-02 | PH200-T030 | 123 | 6G8-46241-00 | REC6G8-46241-00 | 267 | 6H3-45127-00 | REC6H3-45127-00 | 269 |
| 6G5-44150-02 | REC6G5-44150-02 | 381 | 6G8-81800-10 | PH130-0062 | 110 | 6H3-81800-10 | PH130-0050 | 111 |
| 6G5-44323-00 | REC6G5-44323-00 | 329-333-381- | 6G8-81800-11 | PH130-0062 | 110 | 6H3-81800-11 | PH130-0050 | 111 |
| | | 385 | 6G8-81800-10 | REC6G8-81800-10 | 120 | 6H3-81800-11 | PH130-0050 | 111 |
| 6G5-44323-00 | REC6G5-44323-00 | 155-157 | 6G8-81960-A1 | REC6G8-81960-A1 | 117 | 6H3-82510-00 | REC6H3-82510-03 | 114 |
| 6G5-44323-01 | REC6G5-44323-01 | 149 | 6G8-W0001-A3 | REC6G8-W0001-A3 | 181-216-218 | 6H3-82510-01 | REC6H3-82510-03 | 114 |
| 6G5-45113-A1 | REC6G5-45113-A1 | 245-247 | 6G9-85540-20 | REC6G9-85540-29 | 117-118 | 6H3-82510-02 | REC6H3-82510-03 | 114 |
| 6G5-45113-A2 | REC6G5-45113-A1 | 253-254 | 6G9-85540-21 | REC6G9-85540-29 | 117-118 | 6H3-82510-03 | REC6H3-82510-03 | 114 |
| 6G5-45114-A1 | REC6G5-45114-A0 | 272 | 6G9-85540-22 | REC6G9-85540-29 | 117-118 | 6H3-85470-10 | REC6H3-85570-10 | 104 |
| 6G5-45251-01 | CM6G5-45251-01 | 158-169 | 6G9-85540-29 | REC6G9-85540-29 | 117-118 | 6H3-85520-00 | REC6H3-85520-00 | 107 |
| 6G5-45251-01 | CM6G5-45251-01A | 70-158-169 | 6G9-W0001-C4 | REC6G9-W0001-C4 | 144 | 6H3-85540-10 | REC6H3-85540-11 | 118 |
| 6G5-45251-01 | TEN01112 | 166-169 | 6G9-W0001-C6 | REC6G9-W0001-C6 | 144 | 6H3-85540-11 | REC6H3-85540-13 | 118 |
| 6G5-45251-01 | TEN0112AL | 166-169 | 6GH-45251-00 | CM6G1-45251-03 | 159 | 6H3-85540-12 | REC6H3-85540-11 | 118 |
| 6G5-45251-02 | TEN01112AL | 166-169 | 6H0-81960-00 | REC6H0-81960-00 | 116 | 6H3-85540-13 | REC6H3-85540-11 | 118 |
| 6G5-45383-01 | REC6G5-45383-01 | 327-379 | 6H0-82105-02 | PAT85-05000023 | 112 | 6H3-85540-12 | REC6H3-85540-13 | 118 |
| 6G5-45384-00 | REC6G5-45384-00 | 327-379 | 6H0-82105-J2 | PAT85-05000023 | 112 | 6H3-85540-13 | REC6H3-85540-13 | 118 |
| 6G5-45501-21 | REC6G5-45501-21 | 381-391-392 | 6H0-W0093-00 | REC6H0-W0093-00 | 97 | 6H3-W0001-02 | REC6H3-W0001-02 | 241-250-254 |
| 6G5-45536-01 | REC6G5-45536-01 | 381 | 6H1-11372-00 | PAF15-04000005 | 187 | 6H3-W0001-22 | REC6H3-W0001-22 | 145 |
| 6G5-45551-01 | REC6G5-45551-01 | 379-391-392 | 6H1-11631-03-95 | REC6H1-11631-03K | 264-266 | | | 68-69-152- |
| 6G5-45560-01 | REC6G5-45560-00 | 379-391-392 | 6H1-14485-00 | PAT15-04010202 | 171 | | | 154-156 |
| 6G5-45571-02 | REC6G5-45571-00 | 379-391-392 | 6H1-15359-01-94 | REC6H1-15359-01-94 | 243 | 6H3-W0078-00 | REC6H3-W0078-02 | 93-97 |
| 6G5-45576-10 | REC6G5-45576-10 | 327 | 6H1-43800-13-4D | REC6H1-43800-17-8D | 124 | 6H3-W0093-02 | REC6H3-W0093-02 | 248-254 |
| 6G5-45631-00 | REC6G5-45631-00 | 379-391-392 | 6H1-43800-14-4D | REC6H1-43800-17-8D | 124 | 6H4-11181-A2 | REC6H4-11181-00 | 255 |
| 6G5-45941-00-98 | SOL3511-150-15 | 403 | 6H1-43800-15-4D | REC6H1-43800-17-8D | 124 | 6H4-11193-00 | REC6H4-11193-A1 | 264-266 |
| 6G5-45941-00-98 | SOL3513-148-15 | 403 | 6H1-43800-16-4D | REC6H1-43800-17-8D | 124 | 6H4-11610-00 | REC6H4-11610-00-00 | 264-266 |
| 6G5-45945-01-98 | SOL3511-145-19 | 403 | 6H1-43800-17-8D | REC6H1-43800-17-8D | 124 | 6H4-11631-00-96 | REC6H4-11631-00K | 264-266 |
| 6G5-45945-01-98 | SOL3513-143-19 | 403 | 6H1-43880-00 | PH200-T041 | 122 | 6H4-11631-01-95 | REC6H4-11631-01K | 237-263-266 |
| 6G5-45947-01-98 | SOL3571-153-19 | 403 | 6H1-43880-02 | PH200-T029 | 122 | 6H4-11634-01 | REC6H4-11634-01 | 237-263-264 |
| 6G5-45947-01-98 | SOL3511-148-17 | 403 | 6H1-44144-00 | REC6H1-44144-00 | 373 | 6H4-11635-00 | REC6H4-11635-00K | 264 |
| 6G5-45947-01-98 | SOL3513-145-17 | 403 | 6H1-45214-00 | REC6H1-45214-00 | 315-319 | 6H4-11635-01 | REC6H4-11635-01K | 237-263 |
| 6G5-45947-01-98 | SOL3571-155-17 | 403 | 6H1-45215-00 | REC6H1-45215-00 | 315-319 | 6H4-11636-00 | REC6H4-11636-00K | 264 |
| 6G5-45949-00-98 | SOL3511-142-23 | 403 | 6H1-45251-01 | CM6H1-45251-01 | 158-169 | 6H4-11636-01 | REC6H4-11636-01K | 237-263 |
| 6G5-45949-00-98 | SOL3511-143-21 | 403 | 6H1-45 | | | | | |

| R.O. / OEM | REF | | R.O. / OEM | REF | | R.O. / OEM | REF | |
|-----------------|--------------------|-----------------|-----------------|--------------------|------------------------|-----------------|--------------------|-----------------|
| 6H4-14985-01 | REC6H4-14985-01 | 100 | 6K5-45560-00 | REC6K5-45560-00 | 388-390 | 6P2-11193-00 | REC6P2-11193-00 | 213 |
| 6H4-15369-A1 | REC6H4-15369-A1 | 237 | 6K5-45570-00 | REC6K5-45570-00 | 390 | 6P2-11194-00 | REC6P2-11194-00 | 213 |
| 6H4-41112-A0 | REC6H4-41112-A0 | 141-237 | 6K5-W0001-02 | REC6K5-W0001-02 | 251 | 6P2-1131B-00 | REC6P2-1131B-00 | 213 |
| 6H4-41114-A0 | REC6H4-41114-A0 | 141-237 | 6K5-W0078-01 | REC6K5-W0078-01 | 152-156 | 6P2-13761-00 | REC6P2-13761-00 | 89-90 |
| 6H4-41134-A0 | REC6H4-41134-A0 | 269 | 6K7-11633-00 | REC6K7-11633-00 | 261-265 | 6P2-13761-11 | REC6P2-13761-11 | 90 |
| 6H4-44352-00 | REC6H4-44352-02 | 309 | 6K7-13645-A2 | REC6K7-13645-A2 | 276 | 6P2-13906-00 | REC6P2-13906-00 | 89-90 |
| 6H4-44352-02 | CEF500385G | 143 | 6K7-13646-A2 | REC6K7-13646-A2 | 276 | 6P2-13907-00 | REC6AW-13907-00 | 86 |
| | | 143-297-301- | 6K7-81800-10 | PH130-0051 | 110 | 6P2-24563-00 | REC6P2-WS245-00 | 81 |
| | | 305-355-357- | 6K7-W0093-09 | REC6K7-W0093-09 | 97 | 6P2-41112-00 | REC6P2-41112-00 | 213 |
| | | 359-361 | 6K8-41122-A1 | REC6K8-41122-A1 | 141-229 | 6P2-41114-00 | REC6P2-41114-00 | 213 |
| 6H4-44352-02 | REC6H4-44352-02 | 154-155-156 | 6K8-41124-A1 | REC6K8-41124-A1 | 141-229 | 6P2-41122-00 | REC6P2-41122-00 | 213 |
| 6H4-45113-00 | REC6H4-45113-00 | 237 | 6L2-11181-A3 | REC6L2-11181-A1 | 248-254 | 6P2-44150-00 | REC6P2-44150-00 | 339 |
| 6H4-45113-A0 | REC6H4-45113-00 | 253-254 | 6L2-11193-A1 | REC6L2-11193-A1 | 255 | 6P2-44323-00 | REC6P2-44323-00 | 149 |
| 6H4-45536-00 | PAT40-04000002 | 301-305-309-313 | 6L2-13621-00 | REC6L2-13621-00 | 274 | 6P2-44323-00 | REC6P2-44323-00 | 155-157-339 |
| 6H4-45551-00 | REC6H4-45551-00 | 359-389-390 | 6L2-14384-00 | REC6L2-14384-00-00 | 94 | 6P2-45300-20-8D | REC422-B25F | 278-339 |
| 6H4-45560-00 | REC6H4-45560-00 | 359-389-390 | 6L2-14385-00 | REC6L2-14385-00 | 93-100 | 6P2-45300-21-8D | REC422-B25F | 278-339 |
| 6H4-45571-00 | REC6H4-45570-00 | 359-389-390 | 6L2-14399-00 | REC6L2-14399-00 | 94 | 6P2-45300-40-8D | REC422-B25F | 278 |
| 6H4-45631-00 | REC6H4-45631-00 | 389-390 | 6L2-26301-00 | REC6L2-26301-00 | 130 | 6P2-45300-41-8D | REC422-B25F | 278 |
| 6H4-81800-10 | PH130-0063 | 110 | 6L2-41112-A2 | REC6L2-41112-A3 | 141 | 6P2-45331-00-9S | REC6P2-45331-00-9S | 339 |
| 6H4-81800-11 | PH130-0063 | 110 | 6L2-41114-A1 | REC6L2-41114-A1 | 141 | 6P2-45501-00 | REC6P2-45501-01 | 339 |
| 6H4-81800-12 | PH130-0063 | 110 | 6L2-41133-A3 | REC6L2-41133-A3 | 268 | 6P2-45501-01 | REC6P2-45501-11 | 339 |
| 6H4-W0001-01 | REC6H4-W0001-A1 | 250-254 | 6L2-41134-00 | REC6L2-41134-00 | 268 | 6P2-46241-01 | REC6P2-46241-02 | 213 |
| 6H4-W0001-04 | REC6H4-W0001-04 | 237-250 | 6L2-44322-00 | REC6L2-44322-00 | 155 | 6P2-46241-02 | REC6P2-46241-02 | 267 |
| 6H4-W0001-21 | REC6H4-W0001-21 | 359 | 6L2-44352-00 | CEF500384 | 143 | 6P2-81960-02 | REC6P2-81960-03 | 116 |
| 6H4-W0078-00 | REC6H4-W0078-00 | 151 | 6L2-44352-00 | REC6L2-44352-00 | 66-143-155 | 6P2-81960-03 | REC6P2-81960-03 | 116 |
| 6H4-W0078-A0 | REC6H4-W0078-00 | 155-156-359 | 6L2-44367-00 | PAF25-04050004 | 66-154-155-293-297-355 | 6P2-W0001-00 | REC6P2-W0001-01 | 217 |
| 6H4-W0093-01 | REC6H4-W0093-01-00 | 96 | 6L2-45113-A1 | REC6L2-45113-A2 | 253-254 | 6P2-W0001-01 | REC6P2-W0001-01 | 213-217-218 |
| 6H4-W0093-03 | REC6H4-W0093-03 | 96-237 | 6L2-45214-00 | PAF25-04000022 | 295 | 6P2-W0078-00 | REC6P2-W0078-00 | 73-153-155-157 |
| 6H5-43880-00 | PH200-T048 | 122 | 6L2-45215-00 | PAF25-04000023 | 295 | 6P2-WS245-00 | REC6P2-WS245-00 | 81 |
| 6H5-43880-01 | PH200-T048 | 122 | 6L2-45567-12 | PAF25-04000004-3 | 295 | 6P245300208D | REC422-B25F | 278 |
| 6H5-43880-02 | PH200-T048 | 122 | 6L2-45567-14 | PAF25-04000004-5 | 295 | 6P245300218D | REC422-B25F | 278 |
| 6H5-43880-09 | PH200-T048 | 122 | 6L2-45577-00-10 | PAF25-04070005-1 | 295-355 | 6P245300408D | REC422-B25F | 278 |
| 6H9-45551-00 | REC6H9-45551-00 | 365-389 | 6L2-45577-00-12 | PAF25-04070005-3 | 295 | 6P245300418D | REC422-B25F | 278 |
| 6J1-11610-00 | REC6J1-11610-00 | 221 | 6L2-45611-00 | REC6L2-45611-00 | 355-388-389 | 6P3-24563-00 | REC6P3-WS24A-00 | 81 |
| 6J4-81800-00 | PH130-0062 | 110 | 6L2-45987-01 | REC6L2-45987-00 | 295-355-357-405 | 6P3-24564-00 | REC6P3-24564-00 | 71-72-73-81 |
| 6J4-81800-01 | PH130-0062 | 110 | 6L2-81800-10 | PH130-0061 | 110 | 6P3-45300-40-8D | REC429-B25F | 278-339 |
| 6J8-11181-A1 | REC6J8-11181-A2 | 231 | 6L2-81800-11 | PH130-0061 | 110 | 6P3-45300-41-8D | REC429-B25F | 278-339 |
| 6J8-11181-A2 | REC6J8-11181-A2 | 248-254 | 6L2-81800-12 | PH130-0061 | 110 | 6P3-45300-42-8D | REC429-B25F | 278 |
| 6J8-11325-00 | TEN01150 | 163-229-231 | 6L2-81800-12 | PH130-0061 | 110 | 6P3-WS24A-00 | REC6P3-WS24A-00 | 81 |
| 6J8-11631-02-97 | REC6J8-11631-02 | 231-263-266 | 6L2-W0001-A2 | REC6L2-W0001-03 | 250-254 | 6P3-WS24A-01 | REC6P3-WS24A-00 | 71-72-73-81 |
| 6J8-12414-A0 | REC61A-12414-A0 | 237 | 6L2-W0001-C3 | REC6L2-W0001-C3 | 145 | 6P345300408D | REC429-B25F | 278 |
| 6J8-13411-00 | REC6J8-13411-00 | 83 | 6L2-W0078-00 | REC6L2-W0078-00 | 151-155 | 6P345300418D | REC429-B25F | 278 |
| 6J8-24471-00 | REC6J8-24471-00 | 87 | 6L2-W0093-00 | REC6L2-W0093-00 | 95 | 6P345300428D | REC429-B25F | 278 |
| 6J8-44311-00 | REC663-44311-02 | 357 | 6L5-14301-03 | REC6L5-14301-03 | 91-93 | 6R0-44366-00 | PAF4-03000021 | 283 |
| 6J8-45113-A0 | REC6J8-45113-00 | 231-253-254 | 6L5-24251-00 | PAF4-04120005 | 64-80-81-82 | 6R3-11411-00 | REC6R3-11411-00 | 256 |
| 6J8-81960-00 | PAF15-07060001 | 117 | 6L5-44322-00 | PAF2.6-03000015 | 154-283 | 6R3-24560-00 | REC6R3-24560-00 | 80-81 |
| 6J8-85540-H2 | REC6J8-85540-H2 | 120 | 6L5-44323-00 | REC6L5-44323-00 | 149 | 6R3-81960-10 | REC6R3-81960-10 | 116 |
| 6J8-W0001-21 | REC6J8-W0001-21 | 145-357 | 6L5-44352-00 | CEF500322 | 143 | 6R3-82563-00 | REC6R3-82563-01 | 122 |
| 6J8-W0078-A1 | REC6J8-W0078-A2 | 150-151 | 6L5-44352-00 | PAF2.6-03000100 | 64-283 | 6R3-82563-01 | REC6R3-82563-01 | 122 |
| 6J8-W0078-A2 | REC6J8-W0078-A2 | 155-357 | 6L5-44352-00 | REC6L5-44352-00 | 143-154 | 6R3-85570-01104 | REC6R3-85570-01 | 104 |
| 6J9-45332-00-CA | REC6J9-45332-00-CA | 327-379-391-392 | 6L5-45251-02 | CM6L5-45251-02 | 159-343 | 6R3-W0001-A3 | REC6R3-W0001-03 | 252 |
| 6J9-45371-00 | TEN01143 | 165 | 6L5-45251-02 | CM6L5-45251-02A | 169 | 6R4-13200-00 | REC6R4-13200-02 | 84 |
| 6J9-45371-01 | CM6J9-45371-01 | 160-169 | 6L5-45251-02 | TEN01117 | 166-169 | 6R4-13200-01 | REC6R4-13200-02 | 84 |
| 6J9-45371-01 | CM6J9-45371-01A | 72-160-169-327 | 6L5-45251-03 | CM6L5-45251-02 | 345 | 6R4-13200-02 | REC6R4-13200-02 | 84 |
| 6J9-45371-01 | TEN01133 | 165-169 | 6L5-45316-09 | PAF2.6-03000003 | 283 | 6R5-11361-11-93 | REC6R5-11361-11K | 245 |
| 6J9-45371-01 | TEN01133AL | 165-169 | 6L5-45317-09 | PAF2.6-03000002 | 283 | 6R5-11603-00 | REC6R5-11603-00 | 265-266-267 |
| 6J9-45371-02 | CM6K1-45371-02 | 160-169 | 6L5-45533-00-20 | PAF2.6-03000017 | 283 | 6R5-11631-11-93 | REC6R5-11631-01K | 265-266-267 |
| 6J9-45371-02 | CM6K1-45371-02A | 72-160-169 | 6L5-45551-00 | PAF2.6-03000018 | 283 | 6R5-11631-11-93 | REC6R5-11631-11K | 245-247-261-265 |
| 6J9-45611-01 | REC6J9-45611-00 | 327-379-391-392 | 6L5-45560-00 | PAF2.6-03000019 | 283 | 6R5-11633-10 | REC6R5-11633-00 | 265 |
| 6K1-45371-00 | CM6K1-45371-00 | 161-169 | 6L5-45616-00 | PAF4-03080000 | 283-285-287-405 | 6R5-11634-00 | REC6R5-11634-00 | 245-247-265 |
| 6K1-45371-00 | CM6K1-45371-00A | 161-169 | 6L5-45616-02 | REC647-45616-02 | 345 | 6R5-11634-10 | REC6R5-11634-00 | 245-247-265 |
| 6K1-45371-00 | TEN01144 | 168-169 | 6L5-45631-00 | PAF2.6-03000201 | 283 | 6R5-11642-11-93 | REC6R5-11642-01K | 265-266-267 |
| 6K1-45371-00 | TEN01144AL | 168-169 | 6L5-45631-00 | PAF2.6-03000202 | 283 | 6R5-11642-11-93 | REC6R5-11642-11K | 265-266-267 |
| 6K1-45371-02 | TEN01134 | 165-169 | 6L5-45943-00-EL | PAF2.6-03010000 | 283 | 6R5-116950-00 | REC6R5-116950-00 | 245 |
| 6K1-45945-01-98 | SOL3512-145-19 | 403 | 6L5-45949-00-EL | PAF2.6-03010000 | 402 | 6R6-W0001-02 | REC6R6-W0001-02-00 | 250-254 |
| 6K1-45945-01-98 | SOL3514-143-19 | 403 | 6L5-45949-00-EL | SOL3011-073-05S | 402 | 6R7-11181-A1 | REC6R7-11181-A0 | 248-254 |
| 6K1-45945-01-98 | SOL3572-153-19 | 403 | 6L5-45987-01 | PAF4-03000025 | 345 | 6S1-41136-00 | REC6S1-41136-00 | 270 |
| 6K1-45947-00-98 | SOL3512-148-17 | 403 | 6L6-45371-00 | TEN01103 | 164-169 | 6S1-85885-00 | REC6S1-85885-00 | 90-102 |
| 6K1-45947-00-98 | SOL3514-145-17 | 403 | 6L6-45371-00 | TEN01103AL | 164-169 | 6T4-45836-00 | CM6T4-45836-00 | 159 |
| 6K1-45947-00-98 | SOL3572-155-17 | 403 | 6L8-G3118-01 | REC6L8-G3118-01 | 134 | 6T4-45836-00 | TEN01122 | 164 |
| 6K1-45970-01-98 | SOL3532-145-15 | 403 | 6M6-14385-00 | REC6H4-14985-01 | 100 | 6T5-45251-00 | TEN01139 | 167 |
| 6K1-45972-01-98 | SOL3532-140-21 | 403 | 6N0-E1603-00 | REC6G1-11610-00 | 223 | 6T5-45371-00 | CM6T5-45371-00 | 161 |
| 6K1-45974-02-98 | SOL3532-140-19 | 403 | 6N0-G2177-00 | REC6N0-G2177-00 | 134 | 6T5-45371-00 | TEN01119 | 165 |
| 6K1-45976-00-98 | SOL3532-140-23 | 403 | 6N0-G5251-00 | TEN01118 | 346 | 6T5-45373-00 | TEN01120 | 166 |
| 6K1-45978-02-98 | SOL3532-143-17 | 403 | 6N0-G5551-00 | REC6N0-G5551-00 | 346-387 | 6T545373-00 | CM6T5-45373-00 | 159 |
| 6K1-82510-06 | REC6K1-82510-07 | 113 | 6N0-G5551-A0 | REC68T-45551-00 | 289 | 6U0-45251-00 | TEN01157 | 165-169 |
| 6K1-82570-13 | REC6K1-82570-13 | 128 | 6N0-G5560-00 | REC6N0-G5560-00 | 346-387 | 6U4-45251-00 | CM6U4-45251-00 | 158-169 |
| 6K4-11422-00 | REC6K4-11422-00 | 256 | 6N0-G5571-00 | REC6N0-G5571-00 | 346-387 | 6U4-45251-00 | TEN01159 | 167-169 |
| 6K4-11432-00 | REC6K4-11432-00 | 256 | 6N0-W0001-20 | REC6G1-W0001-C1 | 346 | 6U4-45373-00 | TEN01158 | 166-169 |
| 6K4-11651-00 | REC6K4-11651-00 | 260 | 6N0-W0078-A0 | REC6G1-W0078-A1 | 150 | 6U0-45251-00 | CM6U0-45251-00 | 159-169 |
| 6K5-11601-02 | REC6K5-11601-02 | 241-262-264-266 | 6N0-WG525-00 | CM6G1-45251-03 | 159 | 6V3-45251-01 | TEN01138 | 164 |
| 6K5-11601-12 | REC6K5-11601-12 | 241-262-264 | 6N6-W0001-A3 | REC6E5-W0001-A2 | 245 | 6X2-85885-10 | REC6X2-85885-10 | 103 |
| 6K5-11601-22 | REC6K5-11601-22 | 241-262-264 | 6N6-W0078-00 | REC6N6-W0078-02 | 152 | 6Y1-24268-00 | PAF15-10000003 | 76 |
| 6K5-11631-03-95 | REC6K5-11631-03K | 264-266 | 6N6-W0078-02 | REC6N6-W0078-02 | 152-155-156-157 | 6Y1-24305-00 | GS31075 | 76 |
| 6K5-11635-03 | REC6K5-11635-03K | 264 | 6N6-W0093-02 | REC6N6-W0093-02 | 97-245 | 6Y1-24305-02 | GS31075 | 76 |
| 6K5-11636-03 | REC6K5-11636-03K | 264 | 6N7-11411-00 | REC6N7-11411-00 | 245-256 | 6Y1-24305-05-00 | GS31074 | 76 |
| 6K5-11681-00 | REC6K5-11681-00 | 261 | 6N7-81800-00 | PH130-0051 | 110 | 6Y1-24305-05-00 | GS31075 | 76 |
| 6K5-14301-03 + | | | 6N7-81800-01 | PH130-0051 | 110 | 6Y1-24305-06 | GS31074 | 76 |
| 6K5-14302-03 + | REC6K5-14301-03 | 92-93 | 6N7-81800-10 | PH130-0051 | 110 | 6Y1-24305-06-00 | GS31074 | 76 |
| 6K5-14303-03 | | | 6P2-11181-00 | REC6P2-11181-00 | 213-216-218 | 6Y1-24305-06-00 | GS31075 | 76 |
| 6K5-45551-00 | REC6K5-45551- | | | | | | | |

| R.O. / OEM | REF | |
|--------------------|------------------|-------------|
| 6Y1-24360-52 | GS31187 | 74 |
| 6Y1-24360-52-00 | GS31183 | 74 |
| 6Y1-24360-52-01 | GS31183 | 74 |
| 6Y1-24360-52-02 | GS31183 | 74 |
| 6Y1-24360-52-51 | GS31183 | 74 |
| 6Y1-24360-52-52 | GS31183 | 74 |
| 6Y2-24305-05-00 | GS31076 | 76 |
| 6Y2-24305-06-00 | GS31076 | 76 |
| 6Y2-24360-52 | GS31090 | 74 |
| 6YJ-24167-00 | PAF15-10000002 | 76 |
| 6YJ-24260-00 | PAF15-10020000 | 76 |
| 6YJ-24260-10 | PAF15-10020000 | 76 |
| 6YJ-24610-00 | PAF15-10010000 | 75 |
| 6YJ-24610-01 | PAF15-10010000 | 75 |
| 6YK-24305-01-00 | GS31076 | 76 |
| 6YL-24305-01-00 | GS31074 | 76 |
| 6YL-24305-01-00 | GS31075 | 76 |
| 703-48152-00 | PAF15-13020007W | 129 |
| 703-48205-10 | PAT85-08010000W | 126 |
| 703-48205-10 | REC703-48205-16 | 126 |
| 703-48205-11 | REC703-48205-16 | 126 |
| 703-48205-12 | REC703-48205-16 | 126 |
| 703-48205-13 | REC703-48205-16 | 126 |
| 703-48205-14 | REC703-48205-16 | 126 |
| 703-48205-15 | REC703-48205-16 | 126 |
| 703-48205-16 | REC703-48205-16 | 126 |
| 703-48205-17 | REC703-48205-16 | 126 |
| 703-48205-18 | REC703-48205-16 | 126 |
| 703-48205-1A | REC703-48205-16 | 126 |
| 703-48205-1B | REC703-48205-16 | 126 |
| 703-48205-20 | REC703-48205-16 | 126 |
| 703-48205-21 | REC703-48205-16 | 126 |
| 703-48230-10 | PAF15-13000000W | 126 |
| 703-48230-10 | REC703-48230-14 | 126 |
| 703-48230-11 | REC703-48230-14 | 126 |
| 703-48230-12 | REC703-48230-14 | 126 |
| 703-48230-13 | REC703-48230-14 | 126 |
| 703-48230-14 | REC703-48230-14 | 126 |
| 703-48230-15 | REC703-48230-14 | 126 |
| 703-48230-16 | REC703-48230-14 | 126 |
| 703-48230-17 | REC703-48230-14 | 126 |
| 703-48230-18 | REC703-48230-14 | 126 |
| 703-48230-1A | REC703-48230-14 | 126 |
| 703-48230-20 | REC703-48230-14 | 126 |
| 703-48230-21 | REC703-48230-14 | 126 |
| 703-48245-00 | PAF15-13010010W | 129 |
| 703-48261-01 | PAF15-13000500W | 127 |
| 703-48272-12 | PAF40-13000000EI | 126 |
| 703-48293-10 | PAF15-11000002W | 129 |
| 703-48345-01 | PAF25-07000007W | 127 |
| 703-48861-11 | PAT20-13000500W | 1276 |
| 703-82510-12 | PAF15-13000200W | 113 |
| 703-82510-43 | REC703-82510-44 | 114 |
| 703-82563-00 | PAE4-10040100W | 122-128 |
| 703-82563-01 | PAE4-10040100W | 122-128 |
| 703-82563-02 | PAE4-10040100W | 128 |
| 703-82563-20/21 | REC703-82563-21 | 128 |
| 703-83383-00/01/02 | PAF15-13000300W | 128 |
| 703-83383-10/11 | PAF15-13000300W | 128 |
| 704-48205-11 | REC704-48205-R0 | 127 |
| 704-48205-12 | REC704-48205-R0 | 127 |
| 704-48205-13 | REC704-48205-R0 | 127 |
| 704-48205-14 | REC704-48205-R0 | 127 |
| 704-48205-15 | REC704-48205-R0 | 127 |
| 704-48205-B0 | REC704-48205-R0 | 127 |
| 704-48205-B1 | REC704-48205-R0 | 127 |
| 704-48205-P0 | REC704-48205-R0 | 127 |
| 704-48205-P1 | REC704-48205-R0 | 127 |
| 704-48205-R0 | REC704-48205-R0 | 127 |
| 704-48207-20 | REC704-48207-R0 | 127 |
| 704-48207-21 | REC704-48207-R0 | 127 |
| 704-48207-22 | REC704-48207-R0 | 127 |
| 704-48207-30 | REC704-48207-R0 | 127 |
| 704-48207-31 | REC704-48207-R0 | 127 |
| 704-48207-39 | REC704-48207-R0 | 127 |
| 704-48207-P1 | REC704-48207-R0 | 127 |
| 704-48207-R0 | REC704-48207-R0 | 127 |
| 704-82563-40/41/42 | REC704-82563-41 | 128 |
| 704-82563-J0/J1/J2 | REC704-82563-J2 | 128 |
| 704-82570-08 | REC704-82570-12 | 128 |
| 704-82570-10 | REC704-82570-12 | 128 |
| 704-82570-11 | REC704-82570-12 | 128 |
| 704-82570-12 | REC704-82570-12 | 128 |
| 7FK-12158-00 | PA166F-010011 | 173-175-179 |
| 7FK-12165-00 | PA166F-010010 | 173-175-179 |
| 7NJ-12117-00 | PAF8-05030006 | 173-175 |
| 7NJ-12118-00 | PAF8-05030007 | 173-175-179 |
| 90101-06M56 | REC90101-06M56 | 353 |
| 90101-08001 | PAGB/T5783-M8X35 | 235 |
| 90105-06035 | PAGB/T5783-M6X35 | 189 |
| 90105-06039 | PAGB/T5783-M6X16 | 173 |
| 90105-06M01 | REC90105-06M01 | 363 |
| 90105-06M14 | PAGB/T5783-M6X16 | 175 |
| 90105-06M25 | PAGB/T5782-M6X45 | 175 |

| R.O. / OEM | REF | |
|----------------|-------------------|---|
| 90105-08046-00 | PAF4-04000033 | 175 |
| 90105-081A7 | PAGB/T5783-M8X25 | 189 |
| 90105-08M36 | PAF4-04000034 | 173-179-180 |
| 90105-08M36-00 | PAF4-04000034 | 175 |
| 90105-08M76 | PAF4-04000001 | 171 |
| 90105-08M78 | PAF15-07000028 | 180-185 |
| 90105-090006 | PAF20-05000002 | 187 |
| 90105-10M00 | PAT85-00000012 | 323-327-331-335-337-375-379 |
| 90105-10M12 | PAF25-00000011 | 295 |
| 90105-16M67 | PAT85-00000012 | 315-319 |
| 90109-06M65 | PAF25-05050006 | 191-195-197-201-203-205-207 |
| 90109-08022 | REC90109-08022 | 239-243-247 |
| 90109-08M63 | PAF25-05050019 | 193-199-207 |
| 90109-08M71 | REC90109-08M71 | 245 |
| 90119-06M04 | PAGB/T5783-M6X30 | 227 |
| 90119-06M10 | REC90119-06M10 | 325-329-333-377-385 |
| 90119-06M40 | PAGB/T5782-2000S | 285 |
| 90119-06M48 | PAGB/T5783-M5X12 | 295 |
| 90119-06M80-00 | PAGB/T5783-M6X14 | 177 |
| 90119-06MA2 | PAGB/T5783-M6X20 | 179-227 |
| 90119-06MA3 | PAF8-05000022 | 187 |
| 90119-06MA3 | PAGB/T5783-M6X20 | 191 |
| 90119-06MA3 | PAGB/T5783-M6X25 | 187-191-235 |
| 90119-06MA4 | PAGB/T5783-M6X30 | 235 |
| 90119-06MA5 | PAGB/T5782-M6X35 | 191-203-205-233-241 |
| 90119-06MA5 | PAGB/T5783-M6X25 | 191 |
| 90119-06MA5 | PAGB/T5783-M6X30 | 195 |
| 90119-06MA5 | PAGB/T5783-M6X35 | 243 |
| 90119-06MAS | PAGB/T5783-M6X35 | 191 |
| 90119-08M01 | PAGB/T5782-M8X80 | 191 |
| 90119-08M13 | REC90119-08M13 | 321-357-371 |
| 90119-08M14 | REC90119-08M14 | 317-325-329-333-335-339-341-377-381-385-386 |
| 90119-08M15 | REC90119-08M15 | 301-305-309-13-361 |
| 90119-08M21 | REC90119-08M21 | 231 |
| 90119-08M33 | REC90119-08M33 | 317 |
| 90119-08M87 | REC90119-08M87 | 321 |
| 90119-08MA5 | PAGB/T5783-M6X25 | 235 |
| 90119-09M00 | PAF25-05000002 | 191-197-207 |
| 90142-05M06 | PAGB/T820-M5X30 | 299 |
| 90149-06M00 | REC90149-06M00 | 365 |
| 90151-05M05 | PAGB/T820-M5X30 | 295 |
| 90152-05000 | REC90151-05M00 | 315-319 |
| 90152-05010 | PAGB/T820-M5X30 | 303-311 |
| 90152-05011 | PAGB/T820-M5X20 | 293 |
| 90152-05M03 | PAGB/T820-M5X25 | 289 |
| 90152-05M04 | PAGB/T820-M5X25 | 350 |
| 90152-05M06 | PAGB/T820-M5X30 | 307-365 |
| 90170-012138 | REC90170-12138 | 365 |
| 90170-12138 | REC90170-12138 | 299-303-307-311-359-361-369 |
| 90170-16M01 | REC90170-16M01 | 315-319-323-327-371-375-379 |
| 90170-16M01-00 | REC90170-16M01 | 373 |
| 90170-16M19 | REC90170-16M19 | 331-335-337-383 |
| 90170-20137 | PAF25-05000026 | 195 |
| 90170-28M37 | PAF15-07030005 | 185 |
| 90170-30003 | PAF20-05000029 | 189 |
| 90170-35M47 | PAF25-05000026 | 193 |
| 90171-10M01 | PAF15-06000016 | 349 |
| 90171-10M01 | REC90171-10M01 | 289-291-293-405-351 |
| 90171-14013 | REC90171-14013-00 | 295-353-355-357-405 |
| 90171-16011 | REC90171-16011 | 299-303-307-311-315-319-359-361-365-369-371 |
| 90171-16011 | REC90171-16011 | 405 |
| 90171-16011-00 | REC90171-16011 | 373 |
| 90171-18M04 | REC90171-18M04 | 323-327-331-335-337-341-375-379-383-405 |
| 90179-08M06 | REC90179-08M06 | 291-293-348-351 |
| 90179-09M02 | REC90179-09M02 | 353 |
| 90179-10M14 | REC90179-10M14 | 295-355-357 |
| 90183-02M03 | REC90183-02M03 | 315-319-331-335-337-341-373-383 |
| 90185-05002 | PAGB/T6182-M5 | 289-293-315-319-323-327-331-335-337-341-350 |
| 90185-05002 | PAGB/T889.1-2000 | 295 |
| 90185-22043 | PAF15-01010007 | 132 |
| 90185-22M11 | PAF15-01010007 | 132 |
| 9020-14377 | REC90201-14377 | 227-260 |

| R.O. / OEM | REF | |
|----------------|-------------------|---|
| 90201-02M00 | REC90201-02M00 | 331-335-337-341-383 |
| 90201-06M94 | PAGB/T5287-6 | 180-185 |
| 90201-08784 | PAF20-05030013 | 189 |
| 90201-08818 | PAF4-04000006 | 177 |
| 90201-08818 | PAF4-04000006 | 64-66 |
| 90201-08818 | PAGB/T5783-M5X12 | 183 |
| 90201-08818-00 | PAF4-04000006 | 171 |
| 90201-08M54 | PAF4-03000026 | 283-285-287-345-405 |
| 90201-10144 | PAF25-05050018 | 205 |
| 90201-10M01 | PAGB/T96-10 | 293-349 |
| 90201-10M01 | REC90201-10M01 | 289-405 |
| 90201-10M06 | PAF25-05050018 | 193-199-207 |
| 90201-11M49 | PAF4-03000006 | 287-343 |
| 90201-12565 | REC90201-12565 | 225-260 |
| 90201-13198 | PAF2.6-03000021 | 283 |
| 90201-13201 | PAF15-07040017 | 180-185 |
| 90201-15017 | PAF15-06000020-1 | 293 |
| 90201-15423 | PAF20-05030011 | 189 |
| 90201-16M00 | REC90201-16M00 | 331-335-337-383 |
| 90201-17682 | REC90201-17682 | 291-293-349-351 |
| 90201-17M00-00 | REC90201-17M00 | 373 |
| 90201-20417 | PAF25-04060007 | 295 |
| 90201-20417 | REC90201-20417 | 233-235-239-241-243-260-261-353-355-357 |
| 90201-20M27 | REC90201-20M27 | 229-260 |
| 90201-21M75 | REC90201-21M75 | 245-247-261 |
| 90201-22008 | PAT40-04050007 | 311 |
| 90201-22429 | REC90201-22429 | 299-303-307-359-361-365-369 |
| 90201-22M01 | REC90201-22M01 | 325-329-333-377-381-385 |
| 90201-23008 | PAF2.6-04000003 | 173 |
| 90201-23M01 | REC90201-23M01 | 245-247-261 |
| 90201-266P2 | PAF4-04000004 | 175 |
| 90201-27M00 | PAT40-04000008 | 301-305-309-313 |
| 90201-30M92 | REC90201-30M92 | 323-327-375-379 |
| 90201-31M00 | REC90201-31M00 | 331-383 |
| 90201-42014 | REC90201-42014 | 339 |
| 90201-46M29 | REC90201-46M29 | 227 |
| 90202-12060 | PAF25-02000019 | 297-301-305-309-367-371 |
| 90204-11M49 | PAF4-03000006 | 285-345 |
| 90206-22M19 | REC90206-22M19 | 325-329-333-377-381-385 |
| 902082-04010 | REC90282-04010 | 365 |
| 90209-18112 | REC90209-18112 | 221-223-225-260 |
| 90209-20M23 | REC90209-20159 | 227-260 |
| 90209-24M03 | REC90209-24M03 | 229-260-261 |
| 90209-27M07 | REC90209-27M07 | 233-235-260-261 |
| 90209-27M11 | REC90209-27M11 | 261 |
| 90214-48M03 | REC90214-48M03 | 365-369 |
| 90250-03M10 | REC90250-03M10 | 343 |
| 90250-05010 | REC90250-05010 | 291-293-295-349-351-353-355-357 |
| 90250-05036 | REC90250-05036 | 347 |
| 90250-05046 | REC90250-05046 | 345 |
| 90250-06023 | REC90250-06023 | 299-303-307-311-359-361-363-365-369 |
| 90250-07M02 | REC90250-07M02 | 315-319-371 |
| 90250-07M02-00 | REC90250-07M02 | 373 |
| 90250-08M07 | REC90250-08M07 | 323-327-335-375-379 |
| 90280-03017 | PAGB/T1099-3X5X13 | 201 |
| 90280-03024 | PAF25-04000015 | 155-297 |
| 90280-03024 | REC90280-03024 | 154-155-156-309-313-346-347-349-357-359 |
| 90280-03M01 | PAGB/T1099-3X5X13 | 180-185-189-195-203-205 |
| 90280-03M03 | REC90280-03M03 | 154-156-301-305-317-355-361-369 |
| 90280-04002 | REC90280-04002 | 335 |
| 90280-04M00 | REC90280-04M00 | 156-363-367 |
| 90280-04M04 | REC90280-04M04 | 154-155-156-321-371 |
| 90280-04M04-00 | REC90280-04M04 | 373 |
| 90280-04M05 | REC90280-04M05 | 155-156-157-325-329-333-339-377-381-385-386 |
| 90280-04M06 | PAF25-05000024 | 199 |
| 90280-04M06 | PAF4-04000019 | 193-207 |
| 90280-05049 | REC90280-05049 | 229 |
| 90282-04010 | REC90282-04010 | 315-319-323-353-357-359-369-371-373-375 |
| 90282-04M00 | REC90282-04M00 | 327 |

| R.O. / OEM | REF | | R.O. / OEM | REF | | R.O. / OEM | REF | |
|----------------|-----------------|---|----------------|-------------------|---|-------------|------------------|---|
| 90304-08002 | REC90340-08002 | 327-331-335-337-341 | 90445-10M46 | PAF15-07010007 | 183 | 92995-05600 | PAGB/T97.1-5 | 191-197-207 |
| | | 283-285-287-289-291-282-299-303-307-311-315-319-323-345-350-353-357-361-363-369-370-373-379-383-348-359 | 90464-07M05 | PAF25-05000016 | 241 | 92995-05600 | PAGB/T97.1-8 | 183-203-205 |
| 90340-08002 | REC90340-08002 | 191-195-197-201-203-205-207-209-211-213 | 90465-06M86 | PAT36-04000023 | 179 | 92995-06600 | PAGB/T5783-M5X12 | 185-237 |
| | | 207-209-211-213 | 90465-08M83 | PAF15-07010015 | 195 | 92995-06600 | PAGB/T5783-M6X16 | 371 |
| 90340-08014 | REC90340-08002 | 207-209-211-213 | 90465-08M99 | PAGB/T5783-M5X12 | 171 | 92995-06600 | PAGB/T96-6 | 195 |
| 90340-08M04 | REC90340-08002 | 207-209-211-213 | 90465-11M10 | PAHT-2.5X50 | 293 | | | 171-173-175-179-180-195-197-201-203-205-209-211-213-221-223-225-235-239-287-289-291-317-321-339-351-355 |
| 90340-14M00 | PAF15-04000002 | 207-209-211-213 | 90465-11M10 | PAHT-2.5X60 | 180-191-197-207-209-213-301-305-309-313-317-321-325 | 92995-06600 | PAGB/T97.1-6 | 205-209-211-213-221-223-225-235-239-287-289-291-317-321-339-351-355 |
| 90340-14M06 | PAF15-04000002 | 207-209-211-213 | 90465-11M59 | REC09401-11425 | 75-213 | | | 185-227-229-233-241 |
| 90344-51003 | PAF15-07010004 | 203-205 | 90467-06016 | PAHT-2.5X60 | 221-225-231-237-239-241 | 92995-06600 | PAGB/T97.1-8 | 179-209-214-325-329-333-335-337-341-343-363-369-377 |
| 90381-14020 | REC626-45316-09 | 351 | 90467-08M01 | PAF4-04000030 | 75-243 | | | 299 |
| 90381-20001 | REC90381-20001 | 133 | 90467-09M09 | PAF4-03000005 | 285-287-345 | 92995-08600 | PAGB/T97.1-8 | 295-299-303-307-311-315-319-331 |
| 90386-10M16 | PAT85-01010203 | 133 | 90467-13M13 | PAF4-04000030 | 64-65-67-191-225 | | | 233-258 |
| 90386-18M35 | PAT85-0000017 | 133 | 90472-00247 | PAF4-05000010 | 75 | | | 285-287 |
| 90386-18M63 | REC90386-18M63 | 133 | 90480-06M19 | NGKB8HS-10 | 243 | | | 345 |
| 90386-22M13 | REC90386-22M13 | 133 | 90480-10627 | PAF20-05000036 | 189 | | | 221 |
| 90386-22M15 | PAF15-01010302 | 133 | 90480-10M16 | PAF20-05000034 | 189 | | | 289-346 |
| 90386-22M15 | PAF25-01010002 | 133 | 90480-12072 | PAF15-07050003 | 185 | | | 341 |
| 90386-22M98 | REC90386-22M98 | 133 | 90480-18065 | PAF15-07010027 | 185-209-211 | | | 227 |
| 90386-25M31 | REC90386-25M31 | 133 | 90480-20M05 | REC90480-18065 | 235-239 | | | 287-345 |
| 90386-30048 | PAF15-01000004 | 133 | 90501-10064 | REC90480-20M05 | 243-245-247 | | | 270 |
| 90386-30M60 | PAF15-01000006 | 134 | 90501-10065 | PAF4-03030003 | 283 | | | 225 |
| 90386-30M77 | PAT85-01020005 | 133 | 90501-10065 | PAF25-04060002 | 295-355-357 | | | 227 |
| 90386-30M77 | REC90386-30M77 | 133 | 90501-10M77 | REC90501-10M77 | 331-335-337-341-383 | | | 283-285 |
| 90386-30M78 | PAT85-01020003 | 134 | 90501-11M10 | REC90501-11M10-00 | 329-333-339-381-385 | | | 287-345 |
| 90386-38M89 | REC90386-38M89 | 133 | 90501-120A5 | PAF20-05030007 | 189 | | | 270 |
| 90386-44M03 | PAF25-01000004 | 133 | 90501-12M40 | PAF15-07040014 | 180-185 | | | 225 |
| 90386-52M02 | PAF25-01000001 | 133 | 90501-12M41 | PAF15-07040013 | 185 | | | 289-346-347 |
| 90387-06119 | REC624-42542-00 | 98 | 90501-12M48 | REC90501-12M48 | 315-319-373 | | | 229-233 |
| 90387-06806 | PAF4-00000001 | 285-287 | 90501-14M02 | REC90501-14M02 | 235 | | | 291-293-349-351 |
| 90387-06M14 | PAF4-00000001 | 345 | 90501-14M06 | PAF15-06070002 | 291-349-351 | | | 351 |
| 90387-06M69 | PAF25-03000007 | 133 | 90501-150A0 | PAF15-06070002 | 293 | | | 347 |
| 90387-13001 | PAF15-07040009 | 185 | 90501-15M01 | PAT40-04050002 | 361 | | | 292 |
| 90387-13002 | PAF15-07040011 | 185 | 90501-16233 | REC90501-16233 | 369-371 | | | 291-349-351-363 |
| 90387-13006 | PAF20-05030006 | 189 | 90501-16M01 | REC90501-16M01 | 359-365 | | | 295-353-355-357 |
| 90387-13M56 | PAF15-07040012 | 180-185 | 90501-16M11 | REC90501-16M11 | 139-209-211-243-245-247-323-327-375-379 | | | 221-225 |
| 90387-32002 | REC90387-32002 | 229 | 90501-16M37 | REC90501-16M37 | 303-307-311 | | | 223 |
| 90389-22M01 | REC90389-22M01 | 299-303-307-311-361-365-405 | 90501-18001 | PAF60-04020002 | 339 | | | 353-355-359-365-367-369 |
| 90389-25M00 | REC90389-25M00 | 315-319-371-405 | 90501-450A2 | REC90501-450A2 | 205 | | | 297 |
| 90401-20M00 | PAF15-07010003 | 183-191-197 | 90606-12019 | REC93606-12019 | 79 | | | 299-303-307-311-361-363 |
| 90430-06014 | PAF25-05050007 | 191-195-197-201-203-205-207 | 907-94469-05 | PAF40-0701000E1 | 78 | | | 245-247 |
| 90430-06M03 | REC90430-06M03 | 209-211-213-214-347-363-365 | 907-94469-05 | REC90794-46866 | 78 | | | 301-305-361 |
| 90430-08003 | REC90430-08020 | 292-303-307-311-315-323-283-285-287-289-291-299-327-331-335-337-341-343-345-346-347-348-350-353-355-357-359-361-363-365-369-370-375-379-383-386-64-65-66-67-68-69-70-71-72-73 | 90790-77001 | GS35032 | 75 | | | 317-357-359-369 |
| 90430-08020 | REC90430-08020 | 315-319-371-405 | 90890-56878 | GS35031 | 75 | | | 227 |
| 90430-08020 | REC90430-08020 | 315-319-371-405 | 91490-25030 | PAGB/T91-1.6X12 | 283-285-287-345 | | | 315-319-321-371 |
| 90430-08020 | REC90430-08020 | 315-319-371-405 | 91490-30020 | PAGB/T91-2.5X20 | 349 | | | 373 |
| 90430-08143 | PAF4-04000006 | 197-209-211 | 91490-30020 | REC91490-30025 | 289-291-293-351 | | | 231 |
| 90430-08800 | PAF4-04000006 | 179 | 91490-30022 | PAGB/T91-1.6X12 | 64-65-66-295-355-405 | | | 309-313 |
| 90430-08800-00 | PAF4-04000006 | 175 | 91490-30025 | REC91490-30025 | 64-65-67-68-69-299-303-307-311-315-357-361-365-405 | | | 325-329-333-335-339-377-381-385-386 |
| 90430-10M11 | REC09168-12017 | 64-65 | 91490-30030 | REC91490-30030 | 353-359-405 | | | 335-337 |
| 90430-12072 | PAF25-02000005 | 297 | 91490-30040 | REC91490-30040 | 343 | | | 323-327-331-375-379-383 |
| 90430-12072 | REC90430-12072 | 301-305-309-361-367-371 | 91490-40025 | REC91490-40030 | 319-369-371-68-69-70-71-72-73-323-327-331-335-337-341-375-379-383-405 | | | 235 |
| 90430-12072-00 | REC90430-12072 | 373 | 91490-40030 | REC91490-40030 | 373 | | | 177-179 |
| 90430-14115 | PAF15-04000003 | 195-197-201-207-209-211-213-235-237-239-241 | 91810-03014 | PAF15-07000001 | 181 | | | 220 |
| 90430-14M09 | PAF15-04000003 | 191 | 92-858026QB1 | RM92-858026QB1U6 | 84 | | | 180-185 |
| 90430-14M09 | PAF15-04000003 | 65-66-67-68-69-70-71-72-73 | 92-858027QB1 | RM92-858027QB1U3 | 84 | | | 220 |
| 90445-07MA3 | PAF2.6-04000015 | 237 | 92-8M0086220 | RM92-8M0086220U6 | 84 | | | 171-177-179 |
| 90445-09061 | PAF15-05000012 | 183 | 92-8M0086221 | RM92-8M0086221U3 | 84 | | | 183 |
| 90445-09068 | PAF25-03000008 | 191-197-207 | 92885-06600 | PAGB/T97.1-6 | 177 | | | 183 |
| 90445-09086 | PAF15-05000013 | 183 | 92903-06600 | PAGB/T848-6 | 203-205 | | | 189 |
| 90445-09095 | PAF25-03000009 | 191-197-207 | 92903-06600 | PAGB/T97.1-6 | 187-197-207 | | | 237 |
| 90445-09104 | PAF15-05000014 | 183-197-207 | 92907-04600 | PAGB/T97.1-4 | 195 | | | 229 |
| 90445-09104 | PAF25-03000009 | 195 | 92955-08600-00 | PAGB/T97.1-8 | 177 | | | 189 |
| 90445-09105 | PAF25-03000011 | 191 | 92990-06300 | PAGB/T861.1-6 | 293 | | | 223-225 |
| 90445-09251 | PAF25-03000011 | 195 | 92990-06300 | PAGB/T861.1-87 | 283-287-289-295-343-347 | | | 189 |
| 90445-09807 | PAF4-04000012 | 175 | 92990-06600 | PAGB/T97.1-6 | 185-231-301-343-347-349-367 | | | 177 |
| 90445-09808 | PAF2.6-04000007 | 173 | 92990-08600 | PAGB/T97.1-8 | 367 | | | 183 |
| 90445-10M40 | PAF40-05000053 | 209 | 92990-14200 | PAGB/T97.1-14 | 355-357-405 | | | 227 |
| | | | 92990-14200 | PAGB/T97.1-8 | 295 | | | 183 |
| | | | 92990-16200 | REC92990-16200 | 359-369-405 | | | 243 |
| | | | 92990-18200 | REC92990-18200 | 323-327-331-335-337-375-379-405 | | | 241 |
| | | | | | | | | 189 |

| R.O. / OEM | REF | | R.O. / OEM | REF | | R.O. / OEM | REF | |
|----------------|-----------------------|---|----------------|--------------------|---|----------------|----------------------|---|
| 93102-37M40 | PAF25-05050021 | 193-195-199-201-203-205-207 | 93210-58144 | REC93210-58677 | 325-329-377-381 | 93311-632U1 | REC93311-632U1 | 239-258 |
| 93102-38008 | REC93102-38008 | 211-213 | 93210-58677 | REC93210-58677 | 347 | 93311-632U4 | REC93311-632U7 | 231-257 |
| 93102-38M59 | REC93102-38008 | 209 | 93210-58M21 | REC93210-58M21 | 229-237 | 93311-632V4 | REC93311-632V4 | 257-258 |
| 93102-40M14 | REC93102-40M14 | 245-247 | 93210-59MG7 | REC93210-59MG7 | 154-156-301-305-309-313-361 | 93311-636U6 | REC93311-636U6 | 241-257-258 |
| 93102-43M42 | PAF25-05020003 | 193-195-199-201-203-207 | 93210-60MA3 | REC93210-60MA3 | 357 | 93311-83280 | REC93311-83280 | 331-335-337-383-399-400 |
| 93102-48009 | REC93102-48009 | 209 | 93210-62269 | REC93210-62269 | 239-243 | 93311-832U4 | REC93311-832U4 | 239-258 |
| 93102-60004 | REC93102-60004 | 211 | 93210-64488 | REC93210-65752-00 | 333-335 | 93311-85894 | REC93311-85894 | 335 |
| 93102-63008 | REC93102-63004 | 213 | 93210-64ME7 | REC93210-64ME7 | 295-355 | 93311-928U5 | REC93311-928U5 | 329-381-397-398-399-400 |
| 93103-09M41 | PAF2.6-03000004 | 283 | 93210-65M50 | REC93210-65M50 | 233-235-241-295-355 | 93311-940U3 | REC93311-940U3 | 245-247-258-259 |
| 93103-10052 | REC93103-10052 | 343 | 93210-66M98 | REC93210-66M98 | 295-355 | 93311-940V0 | REC93311-940V0 | 247 |
| 93103-11051 | REC93103-11051 | 343 | 93210-69MG6 | REC93210-69MG6 | 359-365-369 | 93314-314V8 | REC93341-214U1 | 291 |
| 93104-16M01 | REC93104-16M01 | 235-237 | 93210-74MG5 | REC93210-74MG5 | 299-303-307-311-341-361 | 93315-017U4 | REC93315-017U4 | 353-394-395 |
| 93104-16M04 | REC93104-16M01 | 231 | 93210-74MG5 | REC93210-74MG5 | 245-247 | 93315-217U0 | REC93315-217U0 | 363-395 |
| 93104-18049 | REC93104-18049 | 239 | 93210-85M97 | REC93210-85M97 | 299-303-311-361 | 93315-220U4 | REC93315-220U4 | 295-353-355-357-394-395 |
| 93104-20M02 | REC93104-20M02 | 243 | 93210-85M97-00 | REC93210-85M97 | 373 | 93315-220V7 | PAGB/T290F-2020 | 297 |
| 93104-22M07 | REC93104-22M07 | 335 | 93210-86M38 | REC93210-86M38 | 155-156-157-325-329-333-339-377-381-385-386 | 93315-220V7 | REC93315-220V7 | 355-357-394-395 |
| 93106-09014 | REC93106-09014 | 305-309-313-317-321-325-329-333-335-339-369-371-377-381-385 | 93210-86M39 | REC93210-86M39 | 315-319-323-375 | 93315-314V8 | REC93315-314V8 | 291-292-351-393-394 |
| 93106-09014-00 | REC93106-09014 | 373 | 93210-94003 | REC93210-94003 | 335-341 | 93315-317U2 | REC93315-317U2 | 291-293-349-351-393-394 |
| 93106-18M01 | REC93106-18M01 | 241 | 93210-97M55 | REC93210-97M55 | 327-379 | 93315-32224 | REC93315-32224 | 301-305-309-313-359-361-367-369-394-395-396 |
| 93109-44M00 | REC93109-44M00 | 132 | 93211-04001 | REC93211-04001 | 245-247 | 93315-324U1 | REC93315-324U1 | 363-395 |
| 93110-23M00 | REC93110-23M00 | 227 | 93211-04384 | REC93211-04384 | 331-337-383 | 93315-325V1 | REC93315-325V1 | 371-394-395-396 |
| 93210-05001 | PAF2.6-03000009 | 283 | 93304-205U0 | REC93304-205U0 | 257 | 93315-325V1-00 | REC93315-325V1 | 373 |
| 93210-06ME6 | REC90430-08020 | 295 | 93306-001U1 | REC93306-001U1 | 299-303-307-311-361-394-395-396 | 93315-425U7 | REC93315-425U7 | 323-375-396-397 |
| 93210-06ME6 | REC93210-06ME6 | 289-291-292-297-301-351-361 | 93306-004U0 | PAGB/T276-6004C2 | 345 | 93315-425V3 | REC93315-425V3 | 327-379-397-398-399-400 |
| 93210-07003 | REC93210-07540 | 329 | 93306-004YH | PAGB/T276-6004C2 | 289 | 93315-43061 | REC93315-43061 | 327-331-335-379-383-397-398-399-400 |
| 93210-09004 | PAF2.6-04060002 | 171 | 93306-00501 | REC93306-00501 | 291-293-349-351-393-394 | 93315-430U8 | REC93315-430U8 | 323-375-396-397-398-399-400 |
| 93210-12MG9 | PAF25-05050013 | 193-199-207-64-65-68-69-70-71-180-187-195-201-203-205 | 93306-00519 | REC93306-00519 | 347-393 | 93315-430V5 | REC93315-430V5 | 325-377-396-397-398 |
| 93210-13M63 | PAGB/T3452.1-13X2 | 187-195-201-203-205 | 93306-00612 | REC93306-00612 | 295 | 93316-003Y0 | PANTN16003EY | 283 |
| 93210-14515 | PAF25-05050014 | 193-199-207 | 93306-00702 | REC93306-00702 | 353-355-357-394-395 | 93317-22204 | REC93317-22204 | 299-303-307-311-359-361-365-369-394-395-396 |
| 93210-19MJ1 | REC93210-19MJ1 | 211-213 | 93306-20401 | REC93306-204Y7 | 363 | 93317-322V0 | REC93317-322V0 | 315-319-396-397 |
| 93210-22164 | PAGB/T3452.1-25.8X2 | 355 | 93306-204U0 | REC93306-204U0 | 221-223 | 93317-325U0 | REC93317-325U0 | 315-319-371-396-397 |
| 93210-22M02 | REC93210-22M02 | 235 | 93306-205B2 | PANTN6205C3 | 179 | 93317-325U0-00 | REC93317-325U0 | 373 |
| 93210-24M79 | PAF4-04000008 | 177-180-185-201-203-205-64-65-69-70-171-181-187-191-195-197-207-209-211-213-214 | 93306-205U7 | REC93306-205U2 | 257 | 93317-330U2 | REC93317-330U2 | 325-329-333-339-377-381-385-396-397-398-399-400 |
| 93210-24M79 | PAJASOF40431-025 | 191-195-197-207-209-211-213-214 | 93306-205YD | REC93306-205U7 | 227-257 | 93332-00001 | REC93332-00001 | 301-305-309-313-357-361-369-394-395-396 |
| 93210-25552 | REC93210-25552 | 211-213 | 93306-205YD | PAGB/T276-6004C2 | 177 | 93332-00003 | REC93332-00003 | 299-303-307-361-365-369-394-395-396 |
| 93210-26130 | PAGB/T3452.1-25.8X2 | 297-355 | 93306-206U5 | REC93306-206U5 | 183 | 93332-00005 | REC93332-00005 | 291-293-295-349-351-353-355-393-394-395 |
| 93210-32738 | PAGB/T3452.1-32.5X1.8 | 65-66-67-68-69-70-71 | 93306-207U0 | REC93306-206U5 | 243-258 | 93332-00023 | REC93332-00023 | 394-395-396 |
| 93210-32738 | REC93210-32738 | 65-66-68-69 | 93306-207U0-00 | REC93306-207U0 | 315-319-371-395-396-397 | 93332-00048 | REC93332-00048 | 327-331-397-398-399-400 |
| 93210-33M49 | PAJASOF404-19-033 | 335-339 | 93306-208U0 | REC93306-208U0 | 373 | 93332-00079 | PAT40-04000027 | 367 |
| 93210-33M85 | PAJASOF404-19-033 | 283 | 93306-209U0 | REC93306-209U0 | 245-247-258-259-323-375-393-397 | 93332-00092 | PAKOYOHI-CAP322/32 | 311 |
| 93210-33M85 | PAJASOF404-19-033 | 64-154 | 93306-209U1 | REC93306-209U1 | 327-335-379-397-398-399-400 | 93332-000A5 | REC93332-000A5 | 335 |
| 93210-33MG4 | REC93210-33MG4 | 301-305-309-313-361 | 93306-210U0 | REC93306-210U0 | 227-257 | 93332-000U0 | REC93332-000U0 | 363-395 |
| 93210-33MH2 | PAF25-05050015 | 193-199-207 | 93306-210U0 | REC93306-210U0 | 177 | 93332-000U3 | REC93332-000U3 | 317-321-371-396-397 |
| 93210-35537 | PAF4-04060002 | 171-177 | 93306-240U0 | REC93306-240U0 | 183 | 93332-000U5 | REC93332-000U5 | 373 |
| 93210-35537 | PAGB/T345.2-D32.5XD1 | 179 | 93306-272Y2 | PAGB/T276-62/22/P6 | 225-257 | 93332-000U7 | REC93332-000U7 | 323-375-396-397 |
| 93210-37160 | REC93210-37160 | 325-329-333-335-339-341-377-381 | 93306-303V1 | REC93306-306V1 | 171 | 93332-000U7 | REC93332-000U7 | 233-235-258 |
| 93210-37M67 | REC93210-37M67 | 385-386 | 93306-304U0 | REC93306-304U0 | 235 | 93332-000V3 | REC93332-000V3 | 327-379-397-398-399-400 |
| 93210-41042 | REC93210-41042 | 357-359-367-369 | 93306-305U8 | REC93306-305U8 | 257 | 93332-000W1 | REC93332-000W1 | 331-337-383-399-400 |
| 93210-42101 | REC93210-42101 | 343 | 93306-30510 | REC93306-30510 | 237-258 | 93332-000W5 | PAHI-CAP32004JRKYOYO | 297 |
| 93210-42159 | REC93210-42159 | 223-225-231-239 | 93306-305U3 | REC93306-305U3 | 257-258 | 93332-000W7 | REC93332-000W7 | 371-394-395-396 |
| 93210-42M70 | REC93210-42M70 | 225 | 93306-306V1 | REC93306-306V1 | 229-231-257-258 | 93332-000WS | REC93332-000WS | 373 |
| 93210-44398 | PAJASOF404-31-045 | 351 | 93306-307U0 | REC93306-307U0 | 241-257-258 | 93340-67011 | REC93340-67011 | 335-341 |
| 93210-44398 | REC93210-44398 | 154-155-289-291 | 93310-112V0 | REC93310-112V0 | 233-235-258 | 93341-214U1 | REC93341-214U1 | 348-393-394 |
| 93210-45161 | PAF25-04050003 | 66-154-155-297-355 | 93310-32337 | REC93310-32337 | 221-223-257-262 | 93341-93020 | REC93341-93020 | 351-393-394 |
| 93210-45161 | REC93210-45161 | 155 | 93310-32337 | REC93310-32337 | 247-265 | 93341-930U9 | REC93341-930U9 | 333-385 |
| 93210-46044 | REC93210-46044 | 317-321-371 | 93310-323V6 | REC93310-32337 | 258-259 | 93341-930V2 | REC93341-930V2 | 325-329-377-381-396-397-398-399-400 |
| 93210-46044-00 | REC93210-46044 | 373 | 93310-32668 | REC93310-32668 | 245 | 93342-624U0 | REC93342-624U0 | 363 |
| 93210-46M16 | REC93210-46M16 | 227-229-241-243 | 93310-326V4 | REC93310-326V4 | 247 | 93390-000U2 | REC93390-000U2 | 397-398-399 |
| 93210-48001 | PAJASOF40424-050 | 313 | 93310-418U0 | REC93310-418U0 | 259 | | | |
| 93210-48214 | PAJISB2401P48 | 283-285 | 93310-418V1 | REC93310-418V1 | 221-223-257 | | | |
| 93210-48214 | REC93210-48214 | 287-341-345 | 93310-522W0 | REC93310-522W0 | 257-258 | | | |
| 93210-48MG8 | REC93210-48MG8 | 301-309-361 | 93310-527W1 | REC93310-527W1 | 258 | | | |
| 93210-49046 | REC93210-49046 | 154-289-293-317-321-346-359-369-371 | 93310-620V5 | REC93310-620V5 | 227-257 | | | |
| 93210-49046-00 | REC93210-49046 | 373 | 93310-62406 | REC93310-624U5 | 229-257-258 | | | |
| 93210-53M08 | REC93210-53M08 | 289-346 | 93310-636U4 | REC93310-636U4 | 243-258 | | | |
| 93210-54534 | REC93210-54534 | 333-339-385 | 93310-727U0 | REC93310-727U0 | 233-258 | | | |
| 93210-54M54 | REC93210-54M54 | 223 | 93310-727V7 | REC93310-727V7 | 235-258 | | | |
| 93210-55M14 | REC93210-54534 | 325-329-377-381 | 93310-730V6 | REC93310-730V6 | 258 | | | |
| 93210-56M80 | PAF15-06080003 | 231-291-293-351 | 93310-730V8 | REC93310-730V8 | 239-243-258 | | | |
| 93210-57M00 | REC93210-57M00 | 363 | 93310-835U8 | REC93310-835U8 | 243-258 | | | |
| 93210-57M09 | REC93210-57M09 | 291-293-349-351 | 93310-836U0 | REC93310-836U0 | 258-259 | | | |
| | | | 93310-836V2 | REC93310-836V2 | 245-247-258-259 | | | |
| | | | 93310-954U1 | REC93310-954U1 | 245-247-258-259 | | | |
| | | | 93310-954V3 | REC93310-954V3 | 258-259 | | | |
| | | | 93310-959U0 | REC93310-959U0 | 247 | | | |

| R.O. / OEM | REF | | R.O. / OEM | REF | | R.O. / OEM | REF | |
|----------------|-----------------|---|----------------|-------------------|---|-----------------|--------------------|---|
| 93390-000U0 | REC93390-000U0 | 363-395 | 94702-00271 | NGKBR7HS-10 | 223-229-231-237 | 97395-08055 | REC97095-08055 | 359 |
| 93399-99951 | REC93399-99951 | 229-257 | 94702-00271 | NGKBR8HS-10 | 247 | 97395-08070-00 | REC97395-08070 | 373 |
| 93420-22M03 | PAGB/T893.1-22 | 287 | 94702-00271-00 | NGKBR7HS-10 | 108 | 97513-06525 | PAGB/T5783-M6X25 | 185 |
| 93430-06005 | PAGB/T896-86 | 343 | 94702-00272 | NGKBR7HS | 221-233 | 97575-06520 | PAGB/T5783-M6X20 | 293 |
| 93430-10M00 | PAGB/T896-9 | 132 | 94702-00274 | NGKBR6HS-10 | 64-65-180-223 | 97575-08530 | PAGB/T5783-M8X30 | 293 |
| 93440-08819 | PAF2.6-03000012 | 283 | 94702-00274-00 | NGKBR6HS-10 | 108 | 97575-08550-00 | PAGB/T5783-M5X12 | 183 |
| 93440-52008 | REC93440-52009 | 227 | 94702-00309 | NGKBR9HS-10 | 245 | 97575-08550-00 | PAGB/T5787-1986 | 177 |
| 93440-68M03 | REC93440-68M03 | 233-235 | 94702-00372 | NGKCR6HSB | 64-173-179 | 97595-06520 | PAGB/T5783-M6X20 | 185-187 |
| 93450-13022 | REC93450-13022 | 221-223-225-262 | 94702-00372-00 | NGKCR6HS | 108 | 97595-06520 | PAGB/T97.1-8 | 183-191 |
| 93450-13130 | PAF2.6-04020006 | 173 | 94702-00391 | NGKLF5A-11 | 69-70-71-72-209-211 | 97595-06520 | PAGB/T97.1-8 | 191-193-283 |
| 93450-14088 | PAF4-04020006 | 175-219 | 94702-00391-00 | NGKLF5A-11 | 108 | 97607-04210 | PAGB/T818-M4X10 | 187 |
| 93450-15023 | PAF15-07020005 | 183-219 | 94702-00396 | NGKBR8ES-11 | 108 | 97780-40112 | PAGB/T845-ST4.2X16 | 349 |
| 93450-15023 | REC93450-15023 | 227-262 | 94702-00400 | NGKLF6A-11 | 70-72-73-213-214 | 97780-50510 | PAGB/T845-ST4.8X9 | 349 |
| 93450-17129 | PAF20-05020002 | 189-219 | 94702-00400-00 | NGKLF6A-11 | 108 | 97880-05025 | PAGB/T818-M5X25 | 173-179-203-205 |
| 93450-17129 | PAF25-05020106 | 193-195-199-201-203-205-207-219-231 | 94702-00404-00 | NGKBR7EJU | 108 | 97880-05025-00 | PAGB/T818-M5X25 | 175 |
| 93501-04011 | REC93501-04011 | 331-335-337-341-383 | 94702-00405-00 | NGKBR6EJU | 108 | 98503-04066-00 | PAGB/T818-M4X6 | 177 |
| 93503-16003 | REC93503-16003 | 315-319-323-327-373-375-379 | 94702-00409 | NGKCR9EB | 108 | 98507-04010 | PAGB/T818-M4X10 | 195-197-201-203-205-207 |
| 93507-32009 | REC93507-32031 | 323-327 | 94702-00418-00 | NGKDP6EB-9 | 65-66-67-68-69-187-195-201-203 | 98580-06016 | PAGB/T818-M6X16 | 365 |
| 93507-32031 | REC93507-32031 | 375-379 | 94702-00429 | NGKDP6EB-9 | 108 | 98780-04015 | PAGB/T820-M4X12 | 213-239 |
| 93511-32017 | REC93511-32027 | 327 | 94702-00429-00 | NGKDKR7E | 69-205 | 98780-04016 | PAGB/T820-M4X12 | 187-209-237 |
| 93511-32027 | REC93511-32027 | 323-375-379 | 94702-00437-00 | NGKDKR7E | 108 | 98780-05016 | PAGB/T818-M5X16 | 211 |
| 93602-14104 | REC93602-14104 | 227-257-262 | 94702-00440 | NGKDKR6E | 71-108 | 98980-05025 | PAGB/T818-M5X25 | 187 |
| 93602-14118 | REC93602-14118 | 225-257-262 | 947395-06040 | NGKDKR6E-9N | 70 | 99001-06600 | PAGB/T896-86 | 283-285-345 |
| 93602-18M12 | REC93602-18M12 | 229 | 95380-05600 | PAGB/T5782-M6X45 | 349 | 99001-06600 | REC99001-06600 | 287-346 |
| 93602-20M02 | REC93602-20M02 | 229-237-257-258-263-264 | 95380-06700 | PAGB/T889.1-M5 | 299-303-307-311-365 | 99001-08600 | REC99001-08600-00 | 305-309-313-317-321-325-329-333-335-339-369-371-377-381-385 |
| 93603-18M09 | REC93603-18M09 | 241-257-258-262-264 | 95817-06012 | REC95380-06700 | 301-361 | 99080-10600 | PAGB/T896-9 | 132 |
| 93603-21111 | REC93310-32337 | 265 | 95817-06012-00 | PAGB/T5783-M6X12 | 171 | 99510-10114 | PAGB/T818-M6X12 | 180-183-185 |
| 93603-21111 | REC93603-21111 | 233-235-239-243-258-259-263-264-265 | 95895-06012 | PAGB/T5783-M6X12 | 177 | 99510-10114 | PAF4-04000003 | 175-177-179 |
| 93604-07M13 | PAF2.6-03000013 | 64-154-283 | 95895-06012 | PAGB/T5783-M6X14 | 287 | 99530-08012 | PAF25-00000014 | 191-197-201-203-205-207 |
| 93604-08062 | PAF25-04000007 | 214-223-239-301-305-309-313-349-357-363-367 | 95895-06016 | PAGB/T5783-M5X12 | 343-347 | 99590-10114 | REC99590-10114 | 337-383 |
| 93604-09066 | PAF4-03000016 | 64-154-285-287-345 | 95895-06016-00 | PAGB/T5783-M5X12 | 287-289 | 99999-02808 | REC99999-02808 | 134 |
| 93604-09068 | PAF2.6-03000013 | 343 | 95895-06020 | PAGB/T5783-M5X12 | 283 | 99999-03116 | PAF15-01010301S | 131 |
| 93604-10M03 | PAF15-00000013 | 201-317-351 | 95895-06035 | PAGB/T5782-M6X125 | 295 | 99999-03249 | PH130-0007 | 111 |
| 93604-10M03 | PAF25-04000007 | 195-203-205-297-321-355-371 | 95895-06035 | PAGB/T5783-M6X30 | 293 | 99999-03938 | PH130-0051 | 110 |
| 93604-12M07 | PAF15-00000013 | 171-173-283-289-291-293-351 | 97013-05010 | PAGB/T5783-M6X30 | 231 | CS3-43880-00 | PH200-T036 | 122 |
| 93604-12M07 | PAF15-07000013 | 183 | 97013-06012 | PAGB/T5783-M5X10 | 179 | F5-85570-13 | REC6F5-85570-11 | 105 |
| 93604-18080 | PAF4-03000013 | 283-285-287-345 | 97013-06016 | PAGB/T5783-M6X12 | 189 | JA9-12153-00 | PA166F-000001 | 173-175-179 |
| 93605-14143 | PAF25-05050016 | 193-199-207 | 97013-06016 | PAGB/T5783-M5X12 | 185-223-229 | K0A-A3721-00 | RECK0A-A3721-00 | 209 |
| 93606-11M24 | REC93606-12019 | 297 | 97013-06035 | PAF15-07000030 | 197 | K0A-A3722-00 | RECK0A-A3722-00 | 209 |
| 93606-12019 | REC93606-12019 | 187-195-201-203-207-209-211-213-214-221-227-229-231-237-299-303-307-311-315-319-325-329-333-335-339-341-349-367-371-377-381-385 | 97013-06035 | PAGB/T5782-M6X125 | 193 | MAR-24563-00 | RACS3213 | 78 |
| 93606-42019 | REC93606-12019 | 386 | 97013-06040 | PAGB/T5783-M5X12 | 187 | MAR-6Y730-02-12 | SOL3231-101-13 | 402 |
| 93608-12063 | PAF25-00000014 | 235-239-241-243 | 97013-06040 | PAGB/T5783-M5X12 | 171 | N26-13440-00 | REC26-13440-00 | 83-214 |
| 93608-12M05 | REC93608-12M05 | 323-331-337-341-383 | 97013-06045 | PAGB/T5783-M8X25 | 209 | N26-13440-02 | REC26-13440-00 | 73-83 |
| 93700-06M03 | PAJB/T9740.1-M6 | 133 | 97075-08025 | PAGB/T5783-M8X35 | 289 | N51-11325-01 | TEN01160T | 167 |
| 94701-00110 | NGKBR7HS | 108 | 97075-10040 | REC97075-10040 | 289 | YMD-63021-01 | REC2TU6 | 84 |
| 94701-00110-00 | NGKBR7HS | 108 | 97075-10040 | REC97075-10040 | 289 | YMD-63021-04 | REC2TU3 | 84 |
| 94701-00195 | NGKBR8HS | 108 | 97075-10040 | REC97075-10040 | 289 | YMD-63050-01 | REC10W30U6 | 84 |
| 94701-00195-00 | NGKBR8HS | 108 | 97080-08025 | PAGB/T5783-M8X25 | 289-291-292-351 | YMD-63050-04 | REC10W30U3 | 84 |
| 94701-00204 | NGKBR8ES | 108 | 97080-08045 | REC97080-08045 | 289-291-351 | YMD-63060-01 | REC10W40U6 | 84 |
| 94701-00248-00 | NGKBR6HS | 108 | 97090-06014 | PAGB/T5783-M6X16 | 343 | YMD-63060-04 | REC10W40U3 | 84 |
| 94701-00282 | NGKCR6HS | 181 | 97095-05012 | PAGB/T5783-M5X12 | 191 | YMD-RCBOX-00-10 | GS40015 | 127 |
| 94701-00282-00 | NGKCR6HS | 108 | 97095-05012 | PAGB/T818-M5X12 | 197-203-205-207 | YMM-21005-00-00 | PRE3300C05 | 130 |
| 94701-00300-00 | NGKCR5HSB | 108 | 97095-05012 | PAGB/T818-M5X12 | 207 | YMM-21006-C8-00 | PRE3300C06 | 130 |
| 94701-00309-00 | NGKBR9HS-10 | 108 | 97095-05016 | PAGB/T5783-M5X16 | 343 | YMM-21007-C8-00 | PRE3300C07 | 130 |
| 94701-00365-00 | NGKBR6FS | 108 | 97095-0512 | PAGB/T5783-M5X12 | 183 | YMM-21008-C8-00 | PRE3300C08 | 130 |
| 94701-00375 | NGKDP6EA-9 | 65-66-67-68-197-207 | 97095-06010 | PAGB/T5783-M6X10 | 197-349-363 | YMM-21009-C8-00 | PRE3300C09 | 130 |
| 94701-00375 | NGKDP7EA-9 | 185-191 | 97095-06016 | PAGB/T5783-M6X16 | 221-223-225-227-231-235-239-321-339 | YMM-21010-C8-00 | PRE3300C10 | 130 |
| 94701-00375-00 | NGKDP6EA-9 | 108 | 97095-06016 | PAGB/T5783-M6X16 | 227-231-235-239-321-339 | YMM-21011-C8-00 | PRE3300C11 | 130 |
| 94701-00406-00 | NGKDP7EA-9 | 69-108 | 97095-06016 | PAGB/T97.1-6 | 371 | YMM-21012-C8-00 | PRE3300C12 | 130 |
| 94702-00040 | NGKB7HS | 220-235-239 | 97095-06016 | PAGB/T97.1-6 | 371 | YMM-21013-C8-00 | PRE3300C13 | 130 |
| 94702-00041 | NGKB8HS | 239 | 97095-06020 | PAGB/T5783-M6X20 | 171-173-179-180-191-195-197-201-203-205-207-209-213-233-237-241-291-347-351 | YMM-21014-C8-00 | PRE3300C14 | 130 |
| 94702-00160 | NGKB8HS-10 | 239 | 97095-06020-00 | PAGB/T5783-M6X20 | 175 | YMM-21015-C8-00 | PRE3300C15 | 130 |
| 94702-00217 | NGKB7HS-10 | 225-229 | 97095-06025 | PAGB/T5782-M6X25 | 209-213-231 | YMM-21016-C8-00 | PRE3300C16 | 130 |
| 94702-00247-00 | NGKBR8HS-10 | 237-241-245 | 97095-06030 | PAGB/T5783-M6X30 | 180-211-213-343-346 | YMM-21017-C8-00 | PRE3300C17 | 130 |
| 94702-00248 | NGKBR7HS | 175 | 97095-06030 | REC90101-06M56 | 209 | YMM-21018-C8-00 | PRE3300C18 | 130 |
| 94702-00248 | NGKBR6HS | 64-173 | 97095-06035 | PAGB/T5783-M5X12 | 185 | YMM-21019-C8-00 | PRE3300C19 | 130 |
| 94702-00249-00 | NGKBR5HS | 108 | 97095-06040 | REC97095-06040 | 347-355 | YMM-21020-C8-00 | PRE3300C20 | 130 |
| 94702-00271 | NGKB7HS-10 | 227 | 97095-06045 | REC97095-06045 | 211-287-346 | YMM-21021-C8-00 | PRE3300C21 | 130 |
| | | | 97095-08014 | PAGB/T5783-M8X14 | 171-179 | YMM-21022-C8-00 | PRE3300C22 | 130 |
| | | | 97095-08014-00 | PAGB/T5783-M8X14 | 175 | YMM-21023-C8-00 | PRE3300C23 | 130 |
| | | | 97095-08020 | PAF4-04000001 | 331-335-337-341 | YMM-21024-C8-00 | PRE3300C24 | 130 |
| | | | 97095-08020-00 | PAGB/T5783-M8X20 | 179 | YMM-21025-C8-00 | PRE3300C25 | 130 |
| | | | 97095-08025 | PAGB/T5783-M8X25 | 177 | YMM-21026-C8-00 | PRE3300C26 | 130 |
| | | | 97095-08035 | PAGB/T5783-M8X35 | 177 | YMM-21027-C8-00 | PRE3300C27 | 130 |
| | | | 97095-08045 | REC97095-08045 | 299-303-307-311-325-329-333-339 | YMM-21028-C8-00 | PRE3300C28 | 130 |
| | | | 97095-08055 | REC97095-08055 | 303-307-311 | YMM-21029-C8-00 | PRE3300C29 | 130 |
| | | | 97395-06020 | PAGB/T5783-M6X20 | 293-363-367-369 | YMM-21030-C8-00 | PRE3300C30 | 130 |
| | | | 97395-08045 | REC97095-08045 | 349 | YMM-2E114-00 | RACS3240 | 79 |
| | | | | | 359 | YMM-2E227-00 | RACS3227 | 79 |
| | | | | | | YMM-2E227-01 | RACS3227 | 79 |
| | | | | | | YMM-2FE08-00 | GS31166 | 79 |
| | | | | | | YMM-2FE10-00 | GS31065 | 79 |
| | | | | | | YMM-2FS08-00 | GS31066 | 79 |
| | | | | | | YMM-2FS10-00 | GS31067 | 79 |
| | | | | | | YMM-2W114-00 | RAC120R-RAC-01 | 79 |
| | | | | | | YMM-2W227-01 | RAC320R-RAC-01 | 78 |
| | | | | | | | RAC490R-RAC-01 | 79 |

SUZUKI

ES

| | | | | | |
|---|-----|---|-----|---|-----|
| GUÍA MANTENIMIENTO COLAS Y Y KITS | 439 | CLIP | 466 | JUNTA TAPA DE TERMOSTATO | 488 |
| SISTEMA DE ALIMENTACIÓN Y FILTRACIÓN | 442 | CONECTORES CABLES | 466 | PISTONES | 492 |
| ACEITE | 450 | DIRECCIÓN HIDRÁULICA | 467 | KIT DE PISTONES | 492 |
| BOMBA DE COMBUSTIBLE EN LÍNEA | 442 | PLACA CERRADURA SELECTOR | 466 | RETENES DE ACEITE | 488 |
| ABRAZADERA PARA MANGUERA | 443 | INTERRUPTORES PARA MANDOS | 465 | JUNTAS TAPÓN DRENAJE | 490 |
| ADAPTADOR LÍNEA DE COMBUSTIBLE | 443 | INTERRUPTOR PANEL COMPLETO O DOBLE ESTACIÓN | 465 | SISTEMA DE ESCAPE Y ADMISIÓN | 493 |
| BOMBA DE COMBUSTIBLE | 442 | INTERRUPTOR PANEL SIMPLE | 465 | SISTEMA DE ADMISIÓN 4 TIEMPOS | 494 |
| LÍNEA DE COMBUSTIBLE | 442 | MANDOS DE CONTROL | 464 | JUNTAS DE COLECTOR | 494 |
| MANGUERA DE COMBUSTIBLE | 442 | INTERRUPTORES DE TRIM PARA MANDOS | 464 | JUNTAS TAPA DE ESCAPE | 494 |
| MUELLE TUBO COMBUSTIBLE | 443 | MANDO LATERAL | 464 | SISTEMA DE ESCAPE 4 TIEMPOS | 493 |
| BOMBA DE COMBUSTIBLE | 450 | MANDO PARA CONSOLA | 465 | JUNTAS CARTER | 493 |
| BOMBA DE COMBUSTIBLE ALTA PRESIÓN | 451 | SISTEMA DE REFRIGERACIÓN | 468 | JUNTAS DE COLECTOR | 493 |
| BOMBA DE COMBUSTIBLE ELÉCTRICA | 450 | ÁNODOS | 476 | JUNTAS MÚLTIPLE DE ESCAPE | 493 |
| BOMBA DE COMBUSTIBLE MECÁNICA | 450 | ÁNODO CANADA METAL | 476 | SISTEMA DE ESCAPE 2 TIEMPOS | 495 |
| JUNTAS VST | 451 | ÁNODO TECNOSSEAL | 478 | JUNTAS DE ESCAPE | 495 |
| KITS MEMBRANAS Y JUNTAS | 451 | KITS DE ÁNODOS CANADA METAL | 476 | JUNTAS TAPA DE ESCAPE | 495 |
| CARBURADOR | 453 | TORNILLO INOX | 479 | JUNTAS TUBO DE ESCAPE | 495 |
| BOYAS | 453 | JUNTAS TAPA DEL ÁNODO | 479 | UNIDADES DE TRANSMISIÓN | 496 |
| CARBURADOR COMPLETO | 453 | JUNTAS TÓRICA | 479 | DESPIECE COLAS 4 TIEMPOS | 496 |
| KITS CARBURADORES | 453 | BOMBA DE AGUA | 471 | DF4 • DF5 • DF6 | 496 |
| COMPONENTES TANQUE Y CONECTORES | 443 | CASQUILLO INOX | 472 | DF8 • DF9.9 • DF15 • DF20 | 498 |
| CONECTOR DE DEPÓSITO | 443 | CUERPO BOMBA DE AGUA | 471 | DF20 • DF25 | 504 |
| PASAMAMPAROS | 444 | GUÍA KITS BOMBA DE AGUA | 476 | DF30 | 506 |
| FILTRO DE ACEITE | 449 | JUNTAS BOMBA | 473 | DF40 • DF50 | 508 |
| GUÍA FILTROS DE ACEITE | 449 | JUNTAS BASE DE BOMBA | 472 | DF60 | 510 |
| JUNTA TAPÓN DE CÁRTER | 449 | JUNTAS TÓRICA BOMBA DE AGUA | 472 | DF70 | 512 |
| FILTRO DE COMBUSTIBLE Y ELEMENTOS | 445 | KITS DE REPARACIÓN BOMBA DE AGUA | 474 | DF80 • DF90 • DF100 | 513 |
| BRACKET | 445 | TAPA DE LA BOMBA | 472 | DF115 • DF140 | 514 |
| FILTRO DECANTADOR DE COMBUSTIBLE COMPLETO CON VASO TRANSPARENTE | 445 | IMPULSORES | 469 | DF150 • DF175 • DF200 • DF225 • DF250 | 517 |
| FILTRO COMBUSTIBLE ALTA PRESIÓN | 448 | CHAVETA | 470 | DF300 | 519 |
| FILTRO DECANTADOR DE GASOLINA | 446 | GUÍA IMPULSORES | 469 | COMPONENTES DE COLA | 519 |
| FILTRO COMBUSTIBLE MONTAJE EN LÍNEA | 447 | TAPA DEL IMPULSOR | 471 | ARO TÓRICO DEL DIÁBOLO | 521 |
| FILTRO COMBUSTIBLE SEPARADOR AGUA | 445 | TERMOSTATO | 468 | ARO TÓRICO VARILLA DE CAMBIO | 520 |
| LLAVES PARA FILTRO | 447 | TAPÓN DE AGUA | 469 | DIÁBOLO | 521 |
| RACOR DE LATÓN | 447 | TERMOSTATO | 468 | FUELLES VARILLA DE CAMBIO | 520 |
| INYECTORES | 452 | PARTES DEL MOTOR | 480 | GUÍA KITS DE JUNTAS | 520 |
| GUÍA INYECTORES Y SENSORES | 452 | ÁRBOL DE LEVAS | 483 | KITS JUNTAS Y RETENES | 519 |
| SISTEMA ELÉCTRICO | 454 | CIGÜEÑAL | 490 | TORNILLOS Y JUNTAS DE DRENAJE | 521 |
| BOBINAS | 455 | ARANDELAS DE BIELA | 491 | TUBO DRENAJE BOMBA DE AGUA | 521 |
| REGULADOR-BOBINA | 455 | BIELAS | 491 | TUERCA VARILLA DE CAMBIO | 520 |
| BUJÍAS | 455 | PARTES CIGÜEÑAL | 490 | SELECTOR | 522 |
| CDI Y CAJAS NEGRAS | 460 | RODAMIENTOS | 490 | EXTREMO PARA SELECTOR | 523 |
| DESCONECTORES DE SEGURIDAD | 460 | RODAMIENTOS DE BIELA | 491 | MUELLE APRA SELECTOR | 522 |
| KITS | 461 | DESPIECE MOTOR DE 4 TIEMPOS | 481 | PASADOR PARA SELECTOR | 522 |
| LLAVES DE ARRANQUE | 458 | DF40 • DF50 | 481 | PIN | 522 |
| MOTORES DE ARRANQUE | 457 | DF70 • DF80 • DF90 • DF100 | 482 | VARILLA PARA SELECTOR | 523 |
| SOLENOIDE PARA MOTOR DE ARRANQUE | 458 | DESPIECE MOTOR DE 2 TIEMPOS | 480 | RODAMIENTOS | 523 |
| REGULADORES Y RECTIFICADORES | 458 | DT40 • DTW | 480 | ARANDELA / GRUOSOS | 526 |
| GUÍA REGULADORES Y RECTIFICADORES | 459 | GUÍA CORREAS DE DISTRIBUCIÓN | 492 | BOMBA DE ACEITE | 523 |
| RELÉ | 460 | JUNTAS DE MOTOR 4 TIEMPOS | 483 | BOMBA DE AGUA | 523 |
| RELÉ EMC | 460 | GUÍA JUNTAS DE CULATA | 484 | CIRCLIP BOMBA AGUA | 524 |
| SENSORES | 454 | JUNTAS BASE ACEITE | 485 | DIÁBOLO | 524 |
| SENSOR CMP | 454 | JUNTAS BASE DE MOTOR | 484 | EJE TRANSMISIÓN INFERIOR | 524 |
| SENSOR IAC | 454 | JUNTAS BASE RETÉN | 485 | EJE TRANSMISIÓN SUPERIOR | 524 |
| SENSOR MAP | 454 | JUNTAS CUERPO DE MARIPOSA | 485 | PIÑÓN DE ATAQUE | 525 |
| TRIM, TILT & POWER TRIM | 461 | JUNTAS DE ACEITE | 485 | PIÑÓN MARCHA ATRÁS | 526 |
| EXTRACTOR TAPONES DE TRIM | 463 | JUNTAS DE CULATA | 483 | PIÑÓN MARCHA AVANTE | 525 |
| INSTALACIÓN ELÉCTRICA | 461 | JUNTAS GUÍA CADENA | 485 | SISTEMA DE PROPULSIÓN | 527 |
| POWER TRIM COMPLETO | 462 | JUNTAS RETÉN SUPERIOR | 486 | HÉLICES ALUMINIO E INOXIDABLE DE 3 Y 4 PALAS | 527 |
| SENSORES DE TRIM | 463 | JUNTAS TAPA DE BALANCINES | 486 | GUÍA HÉLICES CON NÚCLEO INTEGRADO | 528 |
| TAPONES DE TRIM | 463 | JUNTAS TAPA DE FILTRO | 485 | GUÍA PIEZAS DE COLA | 531 |
| TRIM COMPLETO | 461 | JUNTAS TAPA DE TERMOSTATO | 486 | HÉLICES PARA NÚCLEO INTERCAMBIABLE | 530 |
| SISTEMA DE GOBIERNO | 464 | JUNTAS TAPA SILENBLOCK | 486 | KIT CIERRE DE HÉLICE | 531 |
| ARNÉS | 466 | JUNTAS VALVULA DE PRESIÓN | 486 | NÚCLEO INTERCAMBIABLE | 529 |
| EXTENSIÓN ARNÉS SISTEMAS ANALÓGICOS | 466 | KIT JUNTAS DE CULATA | 484 | PASADOR DE HÉLICE | 532 |
| COMPONENTES | 466 | JUNTAS DE MOTOR 2 TIEMPOS | 487 | PASADOR DE LA TUERCA DE HÉLICE | 532 |
| CABLES DE ACELERADOR | 467 | GUÍA JUNTAS DE CULATA | 487 | SEPARADOR DE HÉLICE | 532 |
| CABLES DE CONTROL | 467 | JUNTAS BASE DE ACEITE | 488 | TUERCA DE HÉLICE | 532 |
| CASQUILLO BASCULANTE | 466 | JUNTAS DE CULATA | 487 | REF --> RO | 533 |
| | | JUNTAS DE CULATÍN | 488 | RO --> REF | 538 |

SUZUKI

RECAMBIOS
MARINOS

| | | | | | |
|--|-----|-------------------------------------|-----|--|-----|
| DRIVES MAINTENANCE GUIDE & KITS | 439 | ENGINE CONTROLS | 464 | GASKET, EXHAUST TUBE | 495 |
| FUEL & FILTRATION SYSTEM | 442 | CONSOLE CONTROL | 465 | INTAKE SYSTEM 4 STROKES | 494 |
| CARBURATOR | 453 | SIDE CONTROL | 464 | GASKETS, COLLECTOR | 494 |
| CARBURETOR KITS | 453 | TRIM SWITCH | 464 | GASKETS, EXHAUST COVER | 494 |
| FLOATS | 453 | SWITCHES FOR ENGINE CONTROLS | 465 | UNIT DRIVES & COMPONENTS | 496 |
| FULL CARBURATOR | 453 | PANEL TWIN STATION | 465 | BEARING | 523 |
| FUEL FILTERS AND ELEMENTS | 445 | SWITCH | 465 | CLIP | 524 |
| BRACKET | 445 | COOLING SYSTEM | 468 | DIABOLO | 524 |
| COMPLET FUEL FILTER | 446 | ANODES | 476 | INITIATIVE GEAR | 525 |
| COMPLET FUEL FILTER WITH TRANSPARENT BOWL | 445 | ANODES CANADA METAL | 476 | LOWER, DRIVE SHAFT | 524 |
| FILTER KEY | 447 | ANODES KIT | 477 | OIL PUMP | 523 |
| HIGH PRESSURE FUEL FILTER | 448 | ANODES TECNOSEAL | 478 | POSITIVE GEAR | 525 |
| IN-LINE FUEL FILTER | 447 | GASKET, ANODE COVER | 479 | REVERSE GEAR | 526 |
| RACORS | 447 | O-RING | 479 | UPPER, DRIVE SHAFT | 524 |
| WATER SEPARATING FUEL FILTER | 445 | SS SCREW | 479 | WASHER / SHIM | 526 |
| FUEL PUMP | 450 | IMPELLERS | 469 | WATER PUMP | 523 |
| DIAPHRAGMS & GASKETS | 451 | IMPELLERS GUIDE | 469 | CLUTCH DOGS | 522 |
| FUEL PUMP ELECTRIC | 450 | IMPELLER PLATE | 471 | ARM, CLUTCH | 523 |
| FUEL PUMP, HIGH PRESSURE | 451 | KEY | 470 | CLUTCH DOGS | 522 |
| FUEL PUMP MECHANICAL | 450 | THERMOSTAT | 468 | CLUTCH PIN | 522 |
| VST GASKETS | 451 | WATER FLUSH PLUG | 469 | PIN | 522 |
| FUEL PUMP IN LINE | 442 | WATER PUMP | 471 | ROD PUSH | 523 |
| CLAMP SMALL | 443 | COVER | 472 | SPRING CLUTCH | 522 |
| COUPLER | 443 | GASKET | 473 | DRIVE COMPONENTS | 519 |
| FUEL HOSE | 442 | GASKET BASE | 472 | DIABOLO, O-RING | 521 |
| FUEL LINE ASSEMBLY | 442 | GUIDE, SERVICE KIT | 476 | DRAIN EATER TUBE | 521 |
| FUEL PUMP | 442 | HOUSING | 471 | DRAIN, SCREW AND GASKETS | 521 |
| SPRING, FUEL PIPE | 443 | INSERT CUP | 473 | GUIDE OF GASKETS KITS | 520 |
| FUEL TANK COMPONENTS & CONNECTORS | 443 | O-RING | 472 | SEAL KITS | 519 |
| TANK CONNECTOR | 443 | SERVICE KIT | 474 | SHIFT, BELOW | 520 |
| THRU HULL | 444 | ENGINE PARTS | 480 | SHIFT, O-RING | 520 |
| INJEKTOR | 452 | CAMSHAFT | 483 | TURNBUCKLE, CLUTCH ROD | 520 |
| GUIDE INJECTORS & SENDERS | 452 | CRANKSHAFT | 490 | GEAR CASE PARTS 4 STROKES | 496 |
| OIL | 450 | CRANKSHAFT BEARINGS | 490 | DF4 • DF5 • DF6 | 496 |
| OIL FILTER | 449 | CRANKSHAFT PARTS | 490 | DF8 • DF9.9 • DF15 • DF20 | 498 |
| OIL DRAIN PLUG GASKET | 449 | CONNECTING ROD | 491 | DF20 • DF25 | 504 |
| OIL FILTER GUIDE | 449 | CONNECTING ROD, BEARINGS | 491 | DF30 | 506 |
| ELECTRIC SYSTEM | 454 | CONNECTING ROD, THRUST WASHER | 491 | DF40 • DF50 | 508 |
| CDI & POWER PACK | 460 | ENGINE GASKETS 4 STROKES | 483 | DF60 | 510 |
| COILS | 455 | GASKET | 484 | DF70 | 512 |
| COIL | 455 | GASKET, CYLINDER COVER | 486 | DF80 • DF90 • DF100 | 513 |
| REGULATOR-COIL | 455 | GASKET, CYLINDER HEAD | 483 | DF115 • DF140 | 514 |
| CUT OFF SWITCHES | 460 | GASKET, FILTER COVER | 485 | DF150 • DF175 • DF200 • DF225 • DF250 | 517 |
| KIT | 461 | GASKET KIT, CYLINDER HEAD | 484 | DF300 | 518 |
| IGNITION STARTER SWITCH | 458 | GASKET, MOUNT OIL SEAL COVER | 485 | PROPULSION SYSTEM | 527 |
| REGULATOR AND RECTIFIERS | 458 | GASKET, OIL GALLERY | 485 | 3 & 4 BLADE ALUMINIUM & SS PROPELLERS | 527 |
| REGULATORS AND RECTIFIERS GUIDE | 459 | GASKET, PRESSURE VALVE | 486 | COTTER PIN | 532 |
| RELAY | 460 | GASKET, SILEMLOCK COVER | 486 | INTERCHANGEABLE HUB | 529 |
| SENSORS | 454 | GASKET, THERMOSTAT COVER | 486 | PROPELLERS APPLICATION WITH RUBBER HUB | 528 |
| SENSOR, CMP | 454 | GASKET, THROTTLE BODY | 485 | PROPELLERS FOR INTERCHANGEABLE HUB | 530 |
| SENSOR, IAC | 454 | GASKET, TIMING CHAIN GUIDE BASE | 485 | PROPELLER PIN | 532 |
| SENSOR, MAP | 454 | GASKET, UNDER OIL | 485 | PROPELLER NUT | 532 |
| SPARK | 455 | GASKET, UPPER SEAL | 486 | PROPELLER NUT KIT | 531 |
| STARTERS | 457 | ENGINE GASKET 2 STROKES | 487 | PROPELLER WASHER | 532 |
| SOLENOID FOR STARTER | 458 | CYLINDER HEAD GASKET | 487 | STERN DRIVE COMPONENTS, APPLICATION | 531 |
| STARTERS | 457 | CYLINDER HEAD GASKET GUIDA | 487 | REF --> OEM | 533 |
| TRIM, TILT & POWER TRIM | 461 | GASKET, HEAD COVER | 488 | OEM --> REF | 538 |
| COMPLETE POWER TRIM ASSEMBLY | 462 | GASKET, THERMOSTAT COVER | 488 | | |
| COMPLETE TRIM ASSEMBLY | 461 | GASKET, UNDER OIL | 488 | | |
| TRIM CAP | 463 | ENGINE PARTS 2 STROKES | 480 | | |
| TRIM PLUGS EXTRACTOR | 463 | DT40 • DTW | 480 | | |
| TRIM SENSORS | 463 | ENGINE PARTS 4 STROKES | 481 | | |
| WIRING HARNESS | 461 | DF40 • DF50 | 481 | | |
| STEERING SYSTEM | 464 | DF70 • DF80 • DF90 • DF100 | 482 | | |
| ARNES | 466 | GUIDE TIMING BELT | 492 | | |
| ARNES EXTENSION ANALOGIC SYSTEM | 466 | PISTONS | 492 | | |
| COMPONENTS | 466 | PISTON KITS | 492 | | |
| BLOCK CONTROL HANDLE | 466 | OIL SEALS | 488 | | |
| BUSH SWIVEL | 466 | OIL SEALS | 488 | | |
| CABLE CONNECTOR | 466 | O-RING DRAIN CAP | 490 | | |
| CLIP | 466 | EXHAUST & INTAKE SYSTEM | 493 | | |
| CONTROL CABLES | 467 | EXHAUST SYSTEM 4 STROKES | 493 | | |
| HYDRAULIC STEERING | 467 | GASKET, COLLECTOR | 493 | | |
| THROTTLE THROTTLE | 467 | OIL PAN, GASKET | 493 | | |
| | | MULTI-EXHAUST GASKET | 493 | | |
| | | EXHAUST SYSTEM 2 STROKES | 495 | | |
| | | GASKET, EXHAUST | 495 | | |
| | | GASKET, EXHAUST COVER | 495 | | |

| | | | | | |
|---|-----|---------------------------------------|-----|--|-----|
| GUIDA MANUTENZIONE E KIT | 439 | CAVO CONNETTORE | 466 | SISTEMA DI SCARICO E ASPIRAZIONE | 493 |
| SISTEMA DI ALIMENTAZIONE E FILTRAZIONE | 442 | CLIP | 466 | SISTEMA ASPIRAZIONE 4 TEMPI | 494 |
| CARBURATORE | 453 | PLACCA SERRATURA SELETORE | 466 | GUARNIZIONE COLLETORE | 494 |
| CARBURATORE COMPLETO | 453 | TAPO GIREVOLE | 466 | GUARNIZIONE COPERCHIO SCARICO | 494 |
| GALLEGGIANTE | 453 | TIMONERIA IDRAULICA | 467 | SISTEMA SCARICO 4 TEMPI | 493 |
| KIT CARBURATORI | 453 | INTERRUTTORI PER CONTROLLO | 465 | GUARNIZIONE CARTER | 493 |
| COMPONENTI SERBATOIO E CONNETTORI | 443 | INTERRUTTORE PANNELLO SINGOLO | 465 | GUARNIZIONE COLLETORE | 493 |
| ATTACCO SERBATOIO | 443 | PANNELLO DOPPIA STAZIONE | 465 | GUARNIZIONE SCARICO MULTIPLO | 493 |
| PASSASCAFO | 444 | SISTEMA DI RAFFREDDAMENTO | 468 | SISTEMA SCARICO 2 TEMPI | 495 |
| FILTRI BENZINA E RACCORDI | 445 | ANODI | 476 | GUARNIZIONE COPERTURA SCARICO | 495 |
| CHIAVE DA FILTRO | 447 | ANODI CANADA METAL | 476 | GUARNIZIONE SCARICO | 495 |
| FILTRO BENZINA ALTA PRESSIONE | 448 | ANODI TECNOSEAL | 478 | GUARNIZIONE TUBO SCARICO | 495 |
| FILTRO BENZINA PER MONTARE IN LINEA | 447 | KIT ANODI | 477 | UNITÀ DI TRASMISSIONE | 496 |
| FILTRO DECANTATORE BENZINA | 446 | GUARNIZIONE COPERCHIO ANODO | 479 | COMPONENTI PIEDI | 519 |
| FILTRO DI DECANTAZIONE BENZINA COMPLETO CON VASCHETTA TRASPARENTE | 445 | O-RING | 479 | DADO ASTA CAMBIO | 520 |
| FILTRO SEPARATORE ACQUA-BENZINA | 445 | VITE INOS | 479 | DIABOLO | 521 |
| RACCORDI | 447 | GIRANTE | 469 | GUIDA KIT GUARNIZIONE | 520 |
| SUPPORTO | 445 | CHIAVETTA | 470 | KIT GUARNIZIONE E TENUTE | 519 |
| FILTRO OLIO | 449 | COPERCHIO GIRANTE | 471 | MANICOTTO MARCE | 520 |
| GUIDA FILTRO OLIO | 449 | GUIDA GIRANTE | 469 | O-RING DIAVOLO | 521 |
| GUARNIZIONE, TAPO COPPA L'OLIO | 449 | POMPA ACQUA | 471 | O-RING MARCE | 520 |
| INIETTORE | 452 | GHIERA INOX | 473 | TUBO DRENAGGIO ACQUA | 521 |
| INIETTORE | 452 | GUIDA KIT POMPA ACQUA | 476 | VITI E GUARNIZIONE DRENAGGIO | 521 |
| GUIDA INIETTORI E SENSORI | 452 | COPERCHIO POMPA | 472 | CUSCINETTO | 523 |
| OLIO | 450 | CORPO, POMPA ACQUA | 471 | DIAVOLO | 524 |
| POMPA BENZINA | 450 | GUARNIZIONE BASE POMPA | 472 | CERCLIP | 524 |
| ADATTATORE | 443 | GUARNIZIONE POMPA | 472 | INFERIORE, ALBERO DI TRASMISSIONE | 524 |
| FASCETTE | 443 | KIT RICAMBI POMPA ACQUA | 474 | PIGNONE ATTACCO | 525 |
| GUARNIZIONE VST | 451 | TERMOSTATO | 468 | PIGNONE MARCIA AVANTI | 525 |
| MEMBRANA E GUARNIZIONI | 451 | TAPPO ACQUA | 469 | PIGNONE MARCIA INDIETRO | 526 |
| POMPA BENZINA ALTA PRESSIONE | 450 | PARTI MOTORE | 480 | POMPA OLIO | 523 |
| POMPA BENZINA ELETTRICA | 450 | ALBERO A CAMME | 483 | POMPA ACQUA | 523 |
| POMPA BENZINA MECCANICA | 450 | ALBERO MOTORE | 490 | RONDELLA / SPESSORE | 526 |
| POMPA BENZINA IN LINEA | 442 | BIELLA | 491 | SUPERIORE, ALBERO DI TRASMISSIONE | 524 |
| MOLLA TUBO COMBUSTIBILE | 443 | CUSCINETTI ALBERO MOTORE | 490 | PARTI PIEDI 4 TEMPI | 496 |
| POMPA BENZINA | 442 | CUSCINETTI BIELLA | 491 | DF4 • DF5 • DF6 | 496 |
| TUBO BENZINA | 442 | PARTE ALBERO MOTORE | 490 | DF8 • DF9,9 • DF15 • DF20 | 498 |
| TUBO CARBURANTE | 442 | RONDELLE BIELLA | 491 | DF20 • DF25 | 504 |
| SISTEMA ELETTRICO | 455 | GUARNIZIONI MOTORE 4 TEMPI | 483 | DF30 | 506 |
| BOBINE | 455 | GUARNIZIONE COPERCHIO PUNTERIE | 486 | DF40 • DF50 | 508 |
| REGOLATORE - BOBINA | 455 | GUARNIZIONE BASE MOTORE | 484 | DF60 | 510 |
| CANDELE | 455 | GUARNIZIONE BASE OLIO | 485 | DF70 | 512 |
| CDI E CENTRALINA | 460 | GUARNIZIONE BASE PARAOLIO | 485 | DF80 • DF90 • DF100 | 513 |
| CHIAVETTA DI SICUREZZA | 460 | GUARNIZIONE CARTER, CATENA GUIDA BASE | 485 | DF115 • DF140 | 514 |
| KIT | 461 | GUARNIZIONE COPERCHIO FILTRO | 485 | DF150 • DF175 • DF200 • DF225 • DF250 | 517 |
| CHIAVI DI ACCENSIONE | 458 | GUARNIZIONE COPERCHIO SILEMBLOCK | 486 | DF300 | 518 |
| GUIDA REGOLATORE E RETTIFICATORE | 459 | GUARNIZIONE COPERCHIO TERMOSTATO | 486 | SELETORE | 522 |
| MOTORINI AVVIAMENTO | 457 | GUARNIZIONE CORPO FARFALLATO | 485 | ASTA PRESSIONE | 523 |
| SOLENOIDE PER MOTORINI AVVIAMENTO | 458 | GUARNIZIONE OLIO | 485 | HEBEL | 523 |
| REGOLATORI E RADDRIZZATORI | 458 | GUARNIZIONE PARAOLIO SUPERIORE | 486 | MOLLA SELETORE | 522 |
| GUIDA REGOLATORI RADDRIZZATORI | 459 | GUARNIZIONE TESTATA | 483 | PIN SELETORE | 522 |
| RELE | 460 | GUARNIZIONE VALVOLA PRESSIONE | 486 | SELETORE | 522 |
| SENSORE | 454 | GUIDA GUARNIZIONE TESTATA | 484 | SPINOTTO | 522 |
| SENSORE CMP | 454 | KIT GUARNIZIONE TESTATA | 484 | SISTEMA DI PROPULSIONE | 527 |
| SENSORE IAC | 454 | GUARNIZIONI MOTORE 2 TEMPI | 487 | ELICHE ALLUMINIO E INOX DA 2 E 4 PALE | 527 |
| SENSORE MAP | 454 | GUARNIZIONE BASE OLIO | 488 | COPPIGLIA | 532 |
| TRIM, TILT & POWER TRIM | 461 | GUARNIZIONE COPERCHIO TERMOSTATO | 488 | DADO DI ELICA | 532 |
| ESTRATTORE PER TAPPI DI TRIM | 463 | GUARNIZIONE COPERCHIO TESTATA | 488 | DISTANZIALE ELICA | 532 |
| INSTALLAZIONE ELETTRICA | 461 | GUARNIZIONE DE TESTATA | 487 | ELICHE PER MOZZO INTERCAMBIABILE | 530 |
| MOTORINO POWER TRIM COMPLETO | 462 | GUIDA GUARNIZIONE TESTATA | 487 | GUIDA ELICHE CON MOZZO | 528 |
| MOTORINO TRIM COMPLETO | 461 | GUIDA CINGHIE DISTRIBUZIONE | 492 | GUIDA RICAMBIO PIEDE | 531 |
| SENSORI TRIM | 463 | PARAOLIO | 488 | KIT CHIUSURA ELICA | 531 |
| TAPPO TRIM | 463 | GUARNIZIONE TAPPO DRENAGIO | 490 | MOZZO INTERCAMBIABILE | 529 |
| SISTEMA DI GUIDA | 464 | PARTI MOTORE 4 TEMPI | 481 | PIN ELICA | 532 |
| CAVI | 466 | DF40 • DF50 | 481 | REF --> RO | 533 |
| ESTENSIONE SISTEMA ANALOGICO | 466 | DF70 • DF80 • DF90 • DF100 | 482 | RO --> REF | 538 |
| COMANDI DI CONTROLLO | 464 | PARTI MOTORE 2 TEMPI | 480 | | |
| COMANDO LATERALE | 464 | DT40 • DTW | 480 | | |
| COMANDO PER CONSOLLA | 465 | PISTONE | 492 | | |
| INTERRUTTORE COMANDO | 464 | KIT PISTONE | 492 | | |
| COMPONENTI | 466 | | | | |
| CAVO ACCELERATORE | 467 | | | | |
| CAVO COMANDO | 467 | | | | |

| | | | | | |
|--|-----|--|-----|---|-----|
| GUIDE MAINTENANCE KITS | 439 | CÂBLE D'ACCELERATEUR | 467 | ROULEMENTS DE BIELLE | 491 |
| SYSTÈME D'ALIMENTATION ET DE FILTRATION | 442 | CÂBLES DE COMMANDE | 467 | ROULEMENTS VILEBREQUIN | 490 |
| CARBURATEUR | 453 | CALE POIGNEE DE CONTRÔLE | 466 | SYSTÈME D'ÉCHAPPEMENT ET SYSTÈME D'ADMISSION | 493 |
| CARBURATEUR COMPLET | 453 | CLIP | 466 | SYSTÈME D'ADMISSION 4 TEMPS | 494 |
| FLOTTEUR DE CARBURATEUR | 453 | DIRECTION HYDRAULIQUE | 467 | JOINTS DE COLLECTEUR | 494 |
| KIT CARBURATEUR | 453 | EMBOUT DE CÂBLE | 466 | JOINTS DE COUVERCLE D'ÉCHAPPEMENT | 494 |
| COMPOSANTS ET CONNECTEURS DU RÉSERVOIR | 443 | FAISCEAU ELECTRIQUE | 466 | SYSTÈME D'ÉCHAPPEMENT 4 TEMPS | 493 |
| PASSE-CLOISON | 444 | RALLONGE FAISCEAU SYSTÈME ANALOGIQUE | 466 | JOINTS COLLECTEUR | 493 |
| RACCORDS DE RESERVOIR | 443 | INTERRUPTEUR DE CONTRÔLE | 465 | JOINTS DE CARTER | 493 |
| FILTRE À ESSENCE ET CARTOUCHE DE RECHANGE | 445 | BOITIER DE DEMARRAGE 2 MOTEURS | 465 | JOINTS DE PIPE D'ÉCHAPPEMENT | 493 |
| CLÉ À FILTRE | 447 | TABLEAU DE COMMANDE SIMPLE | 465 | SYSTÈME D'ÉCHAPPEMENT 2 TEMPS | 495 |
| FILTRE DÉCANTEUR ESSENCE | 446 | SYSTÈME DE REFROIDISSEMENT | 468 | JOINTS D'ÉCHAPPEMENT | 495 |
| FILTRE DÉCANTEUR ESSENCE AVEC BOL TRANSPARENT | 445 | ANODES | 476 | JOINTS DE PLAQUE D'ÉCHAPPEMENT | 495 |
| FILTRE À ESSENCE EN LIGNE | 447 | ANODE CANADA METAL | 476 | JOINTS DE TUBE D'ÉCHAPPEMENT | 495 |
| FILTRE À ESSENCE HAUTE PRESION | 448 | ANODE TECNOSEAL | 478 | EMBASES ET PIÈCES | 496 |
| FILTRE SÉPARATEUR EAU-ESSENCE | 455 | KIT ANODES | 476 | CRABOT | 522 |
| RACCORDS | 447 | JOINT, COUVERCLE D'ANODE | 479 | EMBOUT DE SELECTEUR | 523 |
| TÊTE DE FILTRE À ESSENCE | 445 | JOINT TORIQUE | 479 | PIN | 522 |
| FILTRE À HUILE | 449 | VIS INOX | 479 | PIVOT | 522 |
| GUIDE FILTRE A HUILE | 449 | GUIDE TURBINES | 469 | RESSORT DE SELECTEUR | 522 |
| JOINT DE VIDANGE | 449 | CLAVETTE | 470 | TIGE DE POUSSEE | 523 |
| HUILES | 450 | GUIDE DE TURBINES | 469 | PIÈCES D'EMBASES DE 4 TEMPS | 496 |
| INJECTEURS | 452 | PLAQUE DE POMPE À EAU | 471 | DF4 • DF5 • DF6 | 496 |
| GUIDE INJECTEURS ET SONDES | 452 | POMPE D'EAU | 471 | DF8 • DF9,9 • DF15 • DF20 | 498 |
| POIRE À CARBURANT | 442 | CORPS DE POMPE À EAU | 471 | DF20 • DF25 | 504 |
| COLLIER | 443 | GUIDE KITS POMPES A EAU | 476 | DF30 | 506 |
| POIRE À CARBURANT | 442 | INSERT INOX | 473 | DF40 • DF50 | 508 |
| RACCORD COUPLEUR | 443 | JOINTS, BASE DE POMPE À EAU | 472 | DF60 | 510 |
| RESSORT, TUYAU DE CARBURANT | 443 | JOINTS POMPE | 473 | DF70 | 512 |
| TUYAU CARBURANT | 442 | JOINTS, TORIQUE DE POMPE À EAU | 472 | DF80 • DF90 • DF100 | 513 |
| POMPE À ESSENCE | 450 | KIT REPARATION DE POMPE À EAU | 474 | DF115 • DF140 | 514 |
| JOINTS VST | 451 | PLAQUE DE POMPE À EAU | 472 | DF150 • DF175 • DF200 • DF225 • DF250 | 517 |
| MEMBRANES ET JOINTS | 451 | THERMOSTAT | 468 | DF300 | 518 |
| POMPE À ESSENCE ELECTRIQUE | 450 | BOUCHON DE REGROIDISSEMENT | 469 | PIÈCES D'EMBASES | 519 |
| POMPE À ESSENCE HAUTE PRESSION | 451 | PIÈCES MOTEUR | 480 | DIABOLO | 521 |
| POMPE À ESSENCE MECANIQUE | 450 | ARBRE À CAMES | 483 | ÉCROU DU LEVIER DE CHANGEMENT DE VITESSE | 520 |
| SYSTÈME ÉLECTRIQUE | 455 | GUIDE DES COURROIES DE DISTRIBUTION | 492 | GUIDE DES KITS JOINTS | 520 |
| BOBINES | 455 | JOINTS DE MOTEUR 4 TEMPS | 483 | JOINT TORIQUE DU LEVIER | 520 |
| REGULATEUR-BOBINE | 455 | GUIDE JOINTS DE CULASSE | 484 | JOINT TORIQUE DU DIABOLO | 521 |
| BOUGIES | 455 | JOINTS D'HUILE | 485 | KITS JOINTS D'EMBASES | 519 |
| CAPTEURS | 454 | JOINTS D'HUILE SUPERIEUR | 486 | SOUFFLET DU LEVIER DE CHANGEMENT DE VITESSE | 520 |
| CAPTEUR CMP | 454 | JOINTS DE CACHE CULBUTEUR | 486 | TUBE DE VIDANGE DE LA POMPE À EAU | 521 |
| CAPTEUR IAC | 454 | JOINTS DE COUVERCLE | 485 | VIS ET JOINTS DE VIDANGE | 521 |
| CAPTEUR MAP | 454 | JOINTS DE COUVERCLE SILEMBLOCK | 486 | ROULEMENT | 523 |
| CDI ET BOITIER ELECTRONIQUE | 460 | JOINTS DE COUVERCLE DE FILTRE | 485 | CLIPS | 524 |
| CONTACTEUR A CLÉ | 458 | JOINTS DE GUIDE CHAINE | 485 | DE DIABOLO | 524 |
| COUPE CIRCUIT DE SECURITE | 460 | JOINTS DE THROTTLE BODY | 485 | DE POMPE À EAU | 523 |
| KITS | 461 | JOINTS LOGEMENT THERMOSTAT | 486 | DE POMPE À HUILE | 523 |
| DEMARREUR | 457 | JOINTS SOUPAPE DE PRESSION | 486 | INFERIEUR D'ARBRE DE TRANSMISSION | 524 |
| SOLENOIDE POUR DEMARREUR | 458 | JOINTS BASE D'HUILE | 485 | PIGNON D'ATTAQUE | 525 |
| REGULATEURS ET RECTIFIEURS | 458 | JOINTS DE CULASSE | 483 | PIGNON DE MARCHÉ AVANT | 525 |
| GUIDE REGULATEURS ET RECTIFIEURS | 459 | JOINTS DE TÊTE MOTRICE | 484 | PIGNON DE MARCHÉ ARRIÈRE | 526 |
| RELAIS | 460 | KIT JOINTS DE MOTEUR | 484 | RONDELLE / CALE | 526 |
| TRIM, TILT & POWER TRIM | 461 | JOINTS DE MOTEUR 2 TEMPS | 487 | SUPERIEUR D'ARBRE DE TRANSMISSION | 524 |
| BOUCHON VERIN DE TRIM | 463 | GUIDE JOINTS DE CULASSE | 487 | SYSTEME DE PROPULSION | 527 |
| EMETTEUR DE TRIM | 463 | JOINT DE COUVRE CULASSE | 488 | HÉLICE ALUMINIUM ET INOX 3 ET 4 PALES | 527 |
| INSTALLATION ELECTRIQUE | 461 | JOINTS DE CULASSE | 487 | CLAVETTE D'HÉLICE | 532 |
| KIT EXTRACTEUR | 463 | JOINTS DE TÊTE MOTRICE | 488 | ÉCROU D'HÉLICE | 532 |
| MOTEUR DE TRIM | 461 | JOINTS LOGEMENT THERMOSTAT | 488 | ENTRETOIS D'HÉLICE | 532 |
| POWER TRIM COMPLET | 462 | JOINT SPI | 488 | GUIDE DES HÉLICES ET MOYEUX | 528 |
| SYSTÈME DE COMMANDE | 464 | JOINT DE VIDANGE | 490 | GUIDE DES PIÈCES D'EMBASE | 531 |
| BOITIER DE COMMANDE | 464 | PIECES MOTEURS DE 4 TEMPS | 481 | GOUPILLE D'ÉCROU D'HÉLICE | 532 |
| BOITIER LATERAL | 464 | DF40 • DF50 | 481 | HÉLICES AVEC MOYEU INTERCHANGEABLE | 530 |
| BOITIER POUR CONSOLE | 465 | DF70 • DF80 • DF90 • DF100 | 482 | KIT ÉCROU D'HÉLICE | 531 |
| INTERRUPTEUR TRIM | 464 | PIECES MOTEUR 2 TEMPS | 480 | MOYEU INTERCHANGEABLE | 529 |
| COMPOSANT | 466 | DT40 • DTW | 480 | REF --> RO | 533 |
| BAGUE | 466 | PISTONS | 492 | RO --> REF | 538 |
| | | BOITIER PISTON | 492 | | |
| | | VILEBREQUIN | 490 | | |
| | | BIELLE | 491 | | |
| | | PARTIES DE VILEBREQUIN | 490 | | |
| | | RONDELLE DE BIELLE | 491 | | |

GUÍA KITS
MANTENIMIENTO

MAINTENANCE
GUIDE & KITS

GUIDA
MANUTENZIONE
E KIT

GUIDE
MAINTENANCE
KITS

| | KIT | REF | | | | | | |
|--------------------------------|--------------------|-------------------------------------|--------------------|---------------------|-------------------|-------------------------|---------------------------|-----------------|
| DF2 DF2.5 (2006-11) | | REC17400-97820 | REC17461-97JMO | TURBINA | IMPELLER | GIRANTE | TURBINE | 1 |
| | | | NGKCR6HSA | BUJÍA | SPARK PLUG | CANDELE | BOUGIE | 1 |
| | | | PAGB/T91-1.6X12 | PIN BLOQUEADOR | COTTER PIN | COPPIGLIA | GOUPILLE | 1 |
| | | | REC09168-10022 | ARANDELA TAPÓN | CAP, O-RING | RONDELLA TAPPO | JOINT DE VIDANGE | 1 |
| | | | REC59178-97J00 | JUNTA DRENAJE COLA | DRAIN PLUG GASKET | GUARNIZIONE DRENAGGIO | JOINT DE VIDANGE D'EMBASE | 2 |
| | | | CM55321-87J00A | ÁNODO | ANODE | ANODO | ANODE | 1 |
| | | | PAJASOF404-19-033 | TÓRICA | O-RING | O-RING | JOINT TORIQUE | 1 |
| | | | PAGB/T879.1-2.5X14 | PIN | PIN | PIN | PIN | 1 |
| | | | REC17471-97J00 | PLACA | PLATE | PIASTRA | PLAQUE | 1 |
| | | | REC17472-97J00 | JUNTA BASE DE BOMBA | GASKET, CASE | GUARNIZIONE, BASE POMPA | JOINT, BASE POMPE | 1 |
| | | DF2 DF2.5 (2012+) | | REC17400-97810 | REC17461-97JMO | TURBINA | IMPELLER | GIRANTE |
| | NGKCR6HSA | | | BUJÍA | SPARK PLUG | CANDELE | BOUGIE | 1 |
| | REC91490-40030 | | | PIN BLOQUEADOR | COTTER PIN | COPPIGLIA | GOUPILLE | 1 |
| | REC09168-10022 | | | ARANDELA TAPÓN | CAP, O-RING | RONDELLA TAPPO | JOINT DE VIDANGE | 1 |
| | REC59178-97J00 | | | JUNTA DRENAJE COLA | DRAIN PLUG GASKET | GUARNIZIONE DRENAGGIO | JOINT DE VIDANGE D'EMBASE | 2 |
| | CM55321-87J00A | | | ÁNODO | ANODE | ANODO | ANODE | 1 |
| | PAJASOF404-19-033 | | | TÓRICA | O-RING | O-RING | JOINT TORIQUE | 1 |
| | PAGB/T879.1-2.5X14 | | | PIN | PIN | PIN | PIN | 1 |
| | REC17471-97JLO | | | PLACA | PLATE | PIASTRA | PLAQUE | 1 |
| | REC17472-97JLO | | | JUNTA BASE DE BOMBA | GASKET, CASE | GUARNIZIONE, BASE POMPA | JOINT, BASE POMPE | 1 |
| DF4 DF5 DF6 (2002-10) | | | | REC17400-91860 | REC17400-98661 | KIT BOMBA DE AGUA | WATER PUMP KIT | KIT POMPA ACQUA |
| | | | REC91490-40030 | PIN BLOQUEADOR | COTTER PIN | COPPIGLIA | GOUPILLE | 1 |
| | | | NGKBPR6ES | BUJÍA | SPARK PLUG | CANDELE | BOUGIE | 1 |
| | | | REC09168-10022 | ARANDELA TAPÓN | CAP, O-RING | RONDELLA TAPPO | JOINT DE VIDANGE | 3 |
| | | | CM55321-87J00A | ÁNODO | ANODE | ANODO | ANODE | 2 |
| DF4 DF5 DF6 (2011+) | | REC17400-91830 | REC17400-98661 | KIT BOMBA DE AGUA | WATER PUMP KIT | KIT POMPA ACQUA | KIT POMPE À EAU | 1 |
| | | | REC91490-40030 | PIN BLOQUEADOR | COTTER PIN | COPPIGLIA | GOUPILLE | 1 |
| | | | NGKCPR6EA-9 | BUJÍA | SPARK PLUG | CANDELE | BOUGIE | 1 |
| | | | REC09168-10022 | ARANDELA TAPÓN | CAP, O-RING | RONDELLA TAPPO | JOINT DE VIDANGE | 3 |
| | | | CM55321-87J00A | ÁNODO | ANODE | ANODO | ANODE | 2 |
| DF8A DF9.9A (2010+) | | REC17400-99840 | REC15410-98500 | FILTRO COMBUSTIBLE | FUEL FILTER | FILTRO COMBUSTIBILE | FILTRE À ESSENCE | 1 |
| | | | REC16510-05240 | FILTRO DE ACEITE | OIL FILTER | FILTRO OLIO | FILTRE A HUILE | 1 |
| | | | REC09204-02004 | PIN BLOQUEADOR | COTTER PIN | COPPIGLIA | GOUPILLE | 1 |
| | | | REC09280-54001 | TÓRICA | O-RING | O-RING | JOINT TORIQUE | 1 |
| | | | REC09168-12017 | JUNTA | GASKET | GUARNIZIONE | JOINT | 1 |
| | | | REC59178-97J00 | JUNTA DRENAJE COLA | DRAIN PLUG GASKET | GUARNIZIONE DRENAGGIO | JOINT DE VIDANGE D'EMBASE | 2 |
| | | | CM55321-87J00A | ÁNODO | ANODE | ANODO | ANODE | 2 |
| | | | REC09280-22019 | TÓRICA | O-RING | O-RING | JOINT TORIQUE | 1 |
| | | | NGKCR6E | BUJÍA | SPARK PLUG | CANDELE | BOUGIE | 2 |
| DF9.9 DF15 (2011-13) | | REC17400-94810 | REC17400-94J00 | KIT BOMBA DE AGUA | WATER PUMP KIT | KIT POMPA ACQUA | KIT POMPE À EAU | 1 |
| | | | REC09204-02004 | PIN BLOQUEADOR | COTTER PIN | COPPIGLIA | GOUPILLE | 1 |
| | | | NGKCPR6EA-9 | BUJÍA | SPARK PLUG | CANDELE | BOUGIE | 2 |
| | | | REC16510-05240 | FILTRO DE ACEITE | OIL FILTER | FILTRO OLIO | FILTRE A HUILE | 1 |
| | | | CM5033167 | ÁNODO | ANODE | ANODO | ANODE | 1 |
| | | | REC09168-12017 | JUNTA | GASKET | GUARNIZIONE | JOINT | 1 |
| | | | REC09168-10022 | ARANDELA TAPÓN | CAP, O-RING | RONDELLA TAPPO | JOINT DE VIDANGE | 2 |
| | | | REC15410-98500 | FILTRO COMBUSTIBLE | FUEL FILTER | FILTRO COMBUSTIBILE | FILTRE À ESSENCE | 1 |
| | | DF9.9B DF15A DF20A (2013+) | | REC17400-89810 | REC17400-99J01 | KIT BOMBA DE AGUA | WATER PUMP KIT | KIT POMPA ACQUA |
| | REC09204-02004 | | | PIN BLOQUEADOR | COTTER PIN | COPPIGLIA | GOUPILLE | 1 |
| | NGKCPR6EA-9 | | | BUJÍA | SPARK PLUG | CANDELE | BOUGIE | 2 |
| | REC16510-05240 | | | FILTRO DE ACEITE | OIL FILTER | FILTRO OLIO | FILTRE A HUILE | 1 |
| | REC09280-54001 | | | TÓRICA | O-RING | O-RING | JOINT TORIQUE | 1 |
| | CM55321-87J00A | | | ÁNODO | ANODE | ANODO | ANODE | 2 |
| | REC09280-22019 | | | TÓRICA | O-RING | O-RING | JOINT TORIQUE | 1 |
| | REC09168-12017 | | | JUNTA | GASKET | GUARNIZIONE | JOINT | 1 |
| | REC59178-97J00 | | | JUNTA DRENAJE COLA | DRAIN PLUG GASKET | GUARNIZIONE DRENAGGIO | JOINT DE VIDANGE D'EMBASE | 2 |
| DF20 DF25 V2 (2006+) | | REC17400-95870 | REC17400-95J02 | KIT BOMBA DE AGUA | WATER PUMP KIT | KIT POMPA ACQUA | KIT POMPE À EAU | 1 |
| | | | REC16510-87J00 | FILTRO DE ACEITE | OIL FILTER | FILTRO OLIO | FILTRE A HUILE | 1 |
| | | | NGKBKR6E | BUJÍA | SPARK PLUG | CANDELE | BOUGIE | 2 |
| | | | REC91490-40030 | PIN BLOQUEADOR | COTTER PIN | COPPIGLIA | GOUPILLE | 1 |
| | | | REC09168-10022 | ARANDELA TAPÓN | CAP, O-RING | RONDELLA TAPPO | JOINT DE VIDANGE | 2 |
| | | | REC09168-12012 | JUNTA | GASKET | GUARNIZIONE | JOINT | 1 |
| | | | CM55321-87J00A | ÁNODO | ANODE | ANODO | ANODE | 5 |
| | | | REC09280-22019 | TÓRICA | O-RING | O-RING | JOINT TORIQUE | 1 |
| | | | REC17413-95J00 | CASQUILLO INOX | SLEEVE WATER PUMP | CAPPUCCIO | INSERT DE POMPE À EAU | 1 |
| | REC15410-87J30 | FILTRO COMBUSTIBLE | FUEL FILTER | FILTRO COMBUSTIBILE | FILTRE À ESSENCE | 1 | | |

| | KIT | REF | | | | | | | | |
|-----------------------------|--------------------|------------------------------------|--------------------|-------------------|-----------------------|---------------------------|-----------------|-----------------|-----------------|---|
| DF25 DF30 (2001-10) | | REC17400-89820 | REC17400-96403 | KIT BOMBA DE AGUA | WATER PUMP KIT | KIT POMPA ACQUA | KIT POMPE À EAU | 1 | | |
| | | REC16510-87J00 | FILTRO DE ACEITE | OIL FILTER | FILTRO OLIO | FILTRE A HUILE | 1 | | | |
| | | NGKDCPR6E | BUJÍA | SPARK PLUG | CANDELE | BOUGIE | 3 | | | |
| | | REC91490-40030 | PIN BLOQUEADOR | COTTER PIN | COPPIGLIA | GOUPILLE | 1 | | | |
| | | REC09168-10022 | ARANDELA TAPÓN | CAP, O-RING | RONDELLA TAPPO | JOINT DE VIDANGE | 2 | | | |
| | | REC09168-12012 | JUNTA | GASKET | GUARNIZIONE | JOINT | 1 | | | |
| | | CM55321-87J00A | ANODO | ANODE | ANODO | ANODE | 1 | | | |
| | | REC15410-87J10 | FILTRO COMBUSTIBLE | FUEL FILTER | FILTRO COMBUSTIBILE | FILTRE À ESSENCE | 1 | | | |
| | | DF25A DF30A (2015+) | | REC17400-94821 | REC17400-94L00 | KIT BOMBA DE AGUA | WATER PUMP KIT | KIT POMPA ACQUA | KIT POMPE À EAU | 1 |
| | | | | REC91490-40030 | PIN BLOQUEADOR | COTTER PIN | COPPIGLIA | GOUPILLE | 1 | |
| NGKDCPR6EA-9 | BUJÍA | | | SPARK PLUG | CANDELE | BOUGIE | 3 | | | |
| REC16510-87J00 | FILTRO DE ACEITE | | | OIL FILTER | FILTRO OLIO | FILTRE A HUILE | 1 | | | |
| CM55321-87J00A | ANODO | | | ANODE | ANODO | ANODE | 5 | | | |
| REC09280-22019 | TÓRICA | | | O-RING | O-RING | JOINT TORIQUE | 1 | | | |
| REC09168-12017 | JUNTA | | | GASKET | GUARNIZIONE | JOINT | 1 | | | |
| REC59178-97J00 | JUNTA DRENAJE COLA | | | DRAIN PLUG GASKET | GUARNIZIONE DRENAGGIO | JOINT DE VIDANGE D'EMBASE | 2 | | | |
| REC15410-87L00 | FILTRO COMBUSTIBLE | | | FUEL FILTER | FILTRO COMBUSTIBILE | FILTRE À ESSENCE | 1 | | | |
| DF40 DF50 (2006-10) | | | | REC17400-87820 | REC17400-96403 | KIT BOMBA DE AGUA | WATER PUMP KIT | KIT POMPA ACQUA | KIT POMPE À EAU | 1 |
| | | REC16510-87J00 | FILTRO DE ACEITE | OIL FILTER | FILTRO OLIO | FILTRE A HUILE | 1 | | | |
| | | NGKDCPR6E | BUJÍA | SPARK PLUG | CANDELE | BOUGIE | 3 | | | |
| | | REC91490-40030 | PIN BLOQUEADOR | COTTER PIN | COPPIGLIA | GOUPILLE | 1 | | | |
| | | REC09168-10022 | ARANDELA TAPÓN | CAP, O-RING | RONDELLA TAPPO | JOINT DE VIDANGE | 2 | | | |
| | | REC09168-12012 | JUNTA | GASKET | GUARNIZIONE | JOINT | 1 | | | |
| | | CM55321-87J00A | ANODO | ANODE | ANODO | ANODE | 2 | | | |
| | | REC09280-22019 | TÓRICA | O-RING | O-RING | JOINT TORIQUE | 2 | | | |
| | | REC15410-87J30 | FILTRO COMBUSTIBLE | FUEL FILTER | FILTRO COMBUSTIBILE | FILTRE À ESSENCE | 1 | | | |
| | | DF40A DF50A DF60A (2010+) | | REC17400-88810 | REC17400-88L00 | KIT BOMBA DE AGUA | WATER PUMP KIT | KIT POMPA ACQUA | KIT POMPE À EAU | 1 |
| REC91490-40030 | PIN BLOQUEADOR | | | COTTER PIN | COPPIGLIA | GOUPILLE | 1 | | | |
| REC16510-87J00 | FILTRO DE ACEITE | | | OIL FILTER | FILTRO OLIO | FILTRE A HUILE | 1 | | | |
| NGKDCPR6E | BUJÍA | | | SPARK PLUG | CANDELE | BOUGIE | 3 | | | |
| REC09168-12012 | JUNTA | | | GASKET | GUARNIZIONE | JOINT | 1 | | | |
| REC09168-10022 | ARANDELA TAPÓN | | | CAP, O-RING | RONDELLA TAPPO | JOINT DE VIDANGE | 2 | | | |
| CM55321-87J00A | ANODO | | | ANODE | ANODO | ANODE | 3 | | | |
| REC09280-22019 | TÓRICA | | | O-RING | O-RING | JOINT TORIQUE | 2 | | | |
| REC15410-88L00 | FILTRO COMBUSTIBLE | | | FUEL FILTER | FILTRO COMBUSTIBILE | FILTRE À ESSENCE | 1 | | | |
| DF60 DF70 (1997-07) | | | | REC17400-99870 | REC17400-87E04 | KIT BOMBA DE AGUA | WATER PUMP KIT | KIT POMPA ACQUA | KIT POMPE À EAU | 1 |
| | | REC16510-87J00 | FILTRO DE ACEITE | OIL FILTER | FILTRO OLIO | FILTRE A HUILE | 1 | | | |
| | | NGKBPR6ES | BUJÍA | SPARK PLUG | CANDELE | BOUGIE | 4 | | | |
| | | REC91490-40030 | PIN BLOQUEADOR | COTTER PIN | COPPIGLIA | GOUPILLE | 1 | | | |
| | | REC09168-10022 | ARANDELA TAPÓN | CAP, O-RING | RONDELLA TAPPO | JOINT DE VIDANGE | 2 | | | |
| | | REC09168-12012 | JUNTA | GASKET | GUARNIZIONE | JOINT | 1 | | | |
| | | CM55321-87J00A | ANODO | ANODE | ANODO | ANODE | 1 | | | |
| | | REC15410-87J30 | FILTRO COMBUSTIBLE | FUEL FILTER | FILTRO COMBUSTIBILE | FILTRE À ESSENCE | 1 | | | |
| | | DF70A DF80A DF90A (2009+) | | REC17400-87810 | REC17400-87L01 | KIT BOMBA DE AGUA | WATER PUMP KIT | KIT POMPA ACQUA | KIT POMPE À EAU | 1 |
| | | | | REC16510-90J00 | FILTRO DE ACEITE | OIL FILTER | FILTRO OLIO | FILTRE A HUILE | 1 | |
| NGKDCPR6E | BUJÍA | | | SPARK PLUG | CANDELE | BOUGIE | 4 | | | |
| REC09168-12012 | JUNTA | | | GASKET | GUARNIZIONE | JOINT | 1 | | | |
| REC09168-10034 | JUNTA | | | GASKET | GUARNIZIONE | JOINT | 2 | | | |
| CM55321-87J00A | ANODO | | | ANODE | ANODO | ANODE | 3 | | | |
| REC91490-40030 | PIN BLOQUEADOR | | | COTTER PIN | COPPIGLIA | GOUPILLE | 1 | | | |
| REC09280-22019 | TÓRICA | | | O-RING | O-RING | JOINT TORIQUE | 3 | | | |
| REC15410-87L00 | FILTRO COMBUSTIBLE | | | FUEL FILTER | FILTRO COMBUSTIBILE | FILTRE À ESSENCE | 1 | | | |
| DF100 DF115 (2010-12) | | | | REC17400-92840 | REC17400-92J21 | KIT BOMBA DE AGUA | WATER PUMP KIT | KIT POMPA ACQUA | KIT POMPE À EAU | 1 |
| | | REC16510-90J00 | FILTRO DE ACEITE | OIL FILTER | FILTRO OLIO | FILTRE A HUILE | 1 | | | |
| | | NGKBKR6E | BUJÍA | SPARK PLUG | CANDELE | BOUGIE | 4 | | | |
| | | REC91490-40030 | PIN BLOQUEADOR | COTTER PIN | COPPIGLIA | GOUPILLE | 1 | | | |
| | | REC09168-10022 | ARANDELA TAPÓN | CAP, O-RING | RONDELLA TAPPO | JOINT DE VIDANGE | 2 | | | |
| | | REC09168-12012 | JUNTA | GASKET | GUARNIZIONE | JOINT | 1 | | | |
| | | CM55321-87J00A | ANODO | ANODE | ANODO | ANODE | 4 | | | |
| | | REC09280-22019 | TÓRICA | O-RING | O-RING | JOINT TORIQUE | 2 | | | |
| | | REC09420-05009 | CHAVETA | KEY | CHIAVETTA | CLAVETTE | 1 | | | |
| | | REC15410-87J30 | FILTRO COMBUSTIBLE | FUEL FILTER | FILTRO COMBUSTIBILE | FILTRE À ESSENCE | 1 | | | |

| | KIT | REF | | | | | | |
|--|--------------------|------------------|---------------------|-------------------|----------------|-----------------------|-----------------|---|
| DF100A DF115A DF140A (2013+) | | REC17400-92821 | REC17400-92J21 | KIT BOMBA DE AGUA | WATER PUMP KIT | KIT POMPA ACQUA | KIT POMPE À EAU | 1 |
| | | REC16510-90J00 | FILTRO DE ACEITE | OIL FILTER | FILTRO OLIO | FILTRE A HUILE | 1 | |
| | | NGKBKR6E | BUJÍA | SPARK PLUG | CANDELE | BOUGIE | 4 | |
| | | REC91490-40030 | PIN BLOQUEADOR | COTTER PIN | COPPIGLIA | GOUPILLE | 1 | |
| | | REC09168-10022 | ARANDELA TAPÓN | CAP, O-RING | RONDELLA TAPPO | JOINT DE VIDANGE | 2 | |
| | | REC09168-12012 | JUNTA | GASKET | GUARNIZIONE | JOINT | 1 | |
| | | CM55321-87J00A | ANODO | ANODE | ANODO | ANODE | 4 | |
| | | REC09280-22019 | TÓRICA | O-RING | O-RING | JOINT TORIQUE | 2 | |
| | | REC09420-05009 | CHAVETA | KEY | CHIAVETTA | CLAVETTE | 1 | |
| REC15412-92J00 | FILTRO COMBUSTIBLE | FUEL FILTER | FILTRO COMBUSTIBILE | FILTRE À ESSENCE | 1 | | | |
| DF140 (2010-12) | | REC17400-92850 | REC17400-92J21 | KIT BOMBA DE AGUA | WATER PUMP KIT | KIT POMPA ACQUA | KIT POMPE À EAU | 1 |
| | | REC16510-90J00 | FILTRO DE ACEITE | OIL FILTER | FILTRO OLIO | FILTRE A HUILE | 1 | |
| | | NGKBKR6E | BUJÍA | SPARK PLUG | CANDELE | BOUGIE | 4 | |
| | | REC91490-40030 | PIN BLOQUEADOR | COTTER PIN | COPPIGLIA | GOUPILLE | 1 | |
| | | REC09168-10022 | ARANDELA TAPÓN | CAP, O-RING | RONDELLA TAPPO | JOINT DE VIDANGE | 2 | |
| | | REC09168-12012 | JUNTA | GASKET | GUARNIZIONE | JOINT | 1 | |
| | | CM55321-87J00A | ANODO | ANODE | ANODO | ANODE | 4 | |
| | | REC09280-22019 | TÓRICA | O-RING | O-RING | JOINT TORIQUE | 2 | |
| | | REC09420-05009 | CHAVETA | KEY | CHIAVETTA | CLAVETTE | 1 | |
| REC15410-87J30 | FILTRO COMBUSTIBLE | FUEL FILTER | FILTRO COMBUSTIBILE | FILTRE À ESSENCE | 1 | | | |
| DF150 DF175 (2006+) | | REC17400-96821 | REC17400-96J03 | KIT BOMBA DE AGUA | WATER PUMP KIT | KIT POMPA ACQUA | KIT POMPE À EAU | 1 |
| | | REC16510-96J00 | FILTRO DE ACEITE | OIL FILTER | FILTRO OLIO | FILTRE A HUILE | 1 | |
| | | NGKBKR6E | BUJÍA | SPARK PLUG | CANDELE | BOUGIE | 4 | |
| | | REC91490-40030 | PIN BLOQUEADOR | COTTER PIN | COPPIGLIA | GOUPILLE | 1 | |
| | | REC09168-10034 | JUNTA | GASKET | GUARNIZIONE | JOINT | 2 | |
| | | REC09168-12012 | JUNTA | GASKET | GUARNIZIONE | JOINT | 1 | |
| | | CM55321-87J00A | ANODO | ANODE | ANODO | ANODE | 6 | |
| | | REC09280-22019 | TÓRICA | O-RING | O-RING | JOINT TORIQUE | 5 | |
| | | REC17413-96J01 | CASQUILLO INOX | SLEEVE WATER PUMP | CAPPUCCIO | INSERT DE POMPE À EAU | 1 | |
| REC15410-96J00 | FILTRO COMBUSTIBLE | FUEL FILTER | FILTRO COMBUSTIBILE | FILTRE À ESSENCE | 1 | | | |
| DF200 DF225 DF250 (2011+) | | REC17400-93851 | REC17400-93J01 | KIT BOMBA DE AGUA | WATER PUMP KIT | KIT POMPA ACQUA | KIT POMPE À EAU | 1 |
| | | REC16510-96J00 | FILTRO DE ACEITE | OIL FILTER | FILTRO OLIO | FILTRE A HUILE | 1 | |
| | | NGKBKR6E | BUJÍA | SPARK PLUG | CANDELE | BOUGIE | 6 | |
| | | REC91490-40030 | PIN BLOQUEADOR | COTTER PIN | COPPIGLIA | GOUPILLE | 1 | |
| | | REC09168-10034 | JUNTA | GASKET | GUARNIZIONE | JOINT | 2 | |
| | | REC09168-12012 | JUNTA | GASKET | GUARNIZIONE | JOINT | 1 | |
| | | CM55321-87J00A | ANODO | ANODE | ANODO | ANODE | 7 | |
| | | REC09280-22019 | TÓRICA | O-RING | O-RING | JOINT TORIQUE | 7 | |
| | | CM55321-94900A | ANODO | ANODE | ANODO | ANODE | 1 | |
| REC15412-93J10 | FILTRO COMBUSTIBLE | FUEL FILTER | FILTRO COMBUSTIBILE | FILTRE À ESSENCE | 1 | | | |
| DF200A/AP DF150AP DF175AP (2016+) | | REC17400-96832 | REC17400-96J02 | KIT BOMBA DE AGUA | WATER PUMP KIT | KIT POMPA ACQUA | KIT POMPE À EAU | 1 |
| | | REC16510-96J00 | FILTRO DE ACEITE | OIL FILTER | FILTRO OLIO | FILTRE A HUILE | 1 | |
| | | NGKLR6E | BUJÍA | SPARK PLUG | CANDELE | BOUGIE | 4 | |
| | | REC91490-40030 | PIN BLOQUEADOR | COTTER PIN | COPPIGLIA | GOUPILLE | 1 | |
| | | REC09168-10034 | JUNTA | GASKET | GUARNIZIONE | JOINT | 2 | |
| | | REC09168-12012 | JUNTA | GASKET | GUARNIZIONE | JOINT | 1 | |
| | | REC55321-87J01AL | ANODO | ANODE | ANODO | ANODE | 6 | |
| | | REC09280-22019 | TÓRICA | O-RING | O-RING | JOINT TORIQUE | 5 | |
| | | REC17413-96J01 | CASQUILLO INOX | SLEEVE WATER PUMP | CAPPUCCIO | INSERT DE POMPE À EAU | 1 | |
| REC15412-92J00 | FILTRO COMBUSTIBLE | FUEL FILTER | FILTRO COMBUSTIBILE | FILTRE À ESSENCE | 1 | | | |
| DF250A DF250S DF300 (A) (2011+) | | REC17400-98861 | REC17400-98J01 | KIT BOMBA DE AGUA | WATER PUMP KIT | KIT POMPA ACQUA | KIT POMPE À EAU | 1 |
| | | REC16510-96J00 | FILTRO DE ACEITE | OIL FILTER | FILTRO OLIO | FILTRE A HUILE | 1 | |
| | | NGKBKR6E | BUJÍA | SPARK PLUG | CANDELE | BOUGIE | 6 | |
| | | REC91490-40030 | PIN BLOQUEADOR | COTTER PIN | COPPIGLIA | GOUPILLE | 1 | |
| | | REC09168-10034 | JUNTA | GASKET | GUARNIZIONE | JOINT | 2 | |
| | | REC09168-12012 | JUNTA | GASKET | GUARNIZIONE | JOINT | 1 | |
| | | CM55321-87J00A | ANODO | ANODE | ANODO | ANODE | 8 | |
| | | REC09280-22019 | TÓRICA | O-RING | O-RING | JOINT TORIQUE | 7 | |
| | | CM55321-94900A | ANODO | ANODE | ANODO | ANODE | 1 | |
| REC15412-93J10 | FILTRO COMBUSTIBLE | FUEL FILTER | FILTRO COMBUSTIBILE | FILTRE À ESSENCE | 1 | | | |

SISTEMA DE ALIMENTACIÓN Y FILTRACIÓN FUEL & FILTRATION SYSTEM

SISTEMA DI ALIMENTAZIONE E FILTRAZIONE SYSTÈME D'ALIMENTATION ET DE FILTRATION

BOMBA DE COMBUSTIBLE

FUEL PUMP

POMPA BENZINA

POIRE À CARBURANT

BOMBA DE COMBUSTIBLE

FUEL PUMP

POMPA BENZINA





POIRE À CARBURANT

Fabricada con elastómeros termoplásticos inyectados, resistentes al alcohol y rayos UV.s

Premium quality bulb resistance to alcohol as well as UV and ozone.

Fabbricata con elastomero termoplastico, resistente ai solventi e raggi UV.

Fabriqué avec des élastomères thermo-plastiques injectés, résistant à l'alcool et aux rayons UV.

| REF | RO OEM |  |  |  |
|---------|-------------|---|---|--|
| GS31187 | 65770-95541 | 1/4" = 6 mm | 1 |  |
| GS31090 | 65770-95504 | 5/16" = 8 mm | 1 | |
| GS31095 | 65770-93J12 | 3/8" = 9.5 mm | 1 | |
| GS31090 | 65770-90J12 | 5/16" = 8 mm | 1 | |

LÍNEA DE COMBUSTIBLE

FUEL LINE ASSEMBLY

TUBO CARBURANTE



TUYAU CARBURANT

Universal. Manguera resistente al alcohol.



Universal. Alcohol resistant hose.

Universale. Tubo resistente ai solventi.

Universel. Tuyau résistant à l'alcool.

| REF |  |  |
|------------|---|---|
| GS31096 | 5/16" x 2 m | 1 |
| GS31097 | 3/8" x 2 m | 1 |
| GS31099 | 8 mm x 2 m | 1 |
| SIE18-8013 | 5/16" x 2 m | 1 |
| SIE18-8015 | 3/8" x 2 m | 1 |



| REF |  |  |
|---------|---|---|
| GS31189 | 3/8" x 2 m | 1 |

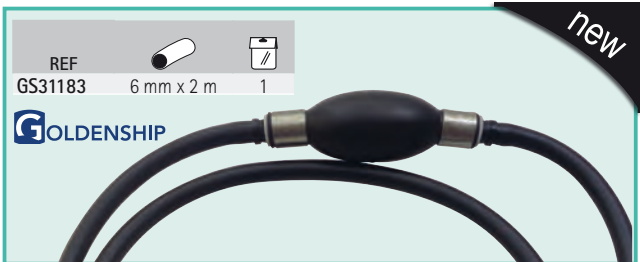

MANGUERA DE COMBUSTIBLE

FUEL HOSE

TUBO BENZINA





TUYAU CARBURANT

Manguera «Trident» para líneas de combustible. Con refuerzo termoplástico que le permite excelente flexibilidad y resistencia a los rayos UV. Color gris. Resistente al alcohol. Especialmente indicado para motores fueraborda. Garantía: 3 años

Marine fuel hose (distribution and vent) for outboards. Fuel resistant thermo-plastic formulation with 2 spiral reinforcement provides excellent bendability and resistance to UV, aging and permeation by all marine fuels (gasoline/petrol and diesel) including alcohol blends. Warranty: 3 years

Tubo «Trident» per linea combustibile. Con rinforzo termoplastico che gli permette un'eccellente flessibilità e resistenza ai raggi UV. Colore grigio. Resistente ai solventi. Indicato per i motori fuoribordo. Garanzia: 3 anni

Tuyau «Trident» pour carburant. Avec renfort thermoplastique qui permet une excellente flexibilité et résistance aux rayons UV. Gris. Résistant à l'alcool. Convient particulièrement aux moteurs hors-bord. Garantie: 3 ans

| REF |  |  |  |  |
|-------------|---|---|---|---|
| TRI305-0566 | 5/16" = 7,92 mm | 15 m | 1 | SAEJ1527 |
| TRI305-0386 | 3/8" = 9,53 mm | 15 m | 1 | ISO-8469 B1 CE |

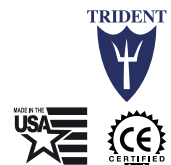

De goma para diesel y gasolina sin plomo. Ideal para fueraborda. Refuerzos textiles internos. Muy flexible. Contenido aromático 50%

Rubber Hose suitable for loading mineral oils, diesel and unloaded fuel

In gomma per diesel e benzina senza piombo. Ideale per motori fuoribordo. Tessuto interno rinforzato. Molto flessibile.

Caoutchouc pour diesel et essence sans plomb. Idéal pour le hors-bord. Renforts textiles internes. Très flexible

CARBUPOMP/10NL

| REF | Ø (mm) |  |  |  |  |  |
|---------|--------|---|---|---|---|---|
| GS35031 | 6x12 | 10 bar | 50 mm | -25°C → 80°C | 50 m | ISO R1307 |
| GS35032 | 8x15 | 10 bar | 65 mm | | 50 m | |

H.T. - CARBUPOMP/10NL - WP 10 BAR - R-1M Q/m - ISO R1307



MUELLE TUBO COMBUSTIBLE

SPRING, FUEL PIPE

MOLLA TUBO COMBUSTIBILE

RESSORT, TUYAU DE CARBURANT

new

| REF |
|---------------|
| PAF4-04000030 |
| PAF4-05000010 |



ABRAZADERA

CLAMP SMALL

FASCETTE

COLLIER

new

| REF | |
|-----------------|------|
| REC650-24351-51 | 6 mm |
| REC6E5-24351-51 | 8 mm |



| REF | OEM | | |
|--------------------|-------------|--------|----|
| REC09401-11425 | 09401-11425 | 6-8 mm | 1 |
| REC09401-11425BULK | 17822-90J00 | 6-8 mm | 25 |



ADPATADOR LÍNEA DE COMBUSTIBLE

COUPLER

ADATTATORE

RACCORD COUPLEUR

| REF | |
|-----------------|--------------------|
| REC22-8M0001721 | Ø 11 mm --> Ø 9 mm |



COMPONENTES TANQUE Y CONECTORES

FUEL TANK COMPONENTS & CONNECTORS

COMPONENTI SERBATOIO E CONNETTORI

COMPOSANTS ET CONNEXEURS DU RÉSERVOIR

CONECTOR DE DEPÓSITO

TANK CONNECTOR

ATTACCO SERBATOIO

RACCORDS DE RESERVOIR

Fabricado en latón.

Made in machined brass.

Fabbricato in ottone.

Coude MF 1/4" NPT en laiton.

| REF | | |
|---------|----------|---|
| GS31068 | 1/4" NPT | 1 |



Para conectar dos motores a un sólo depósito, o viceversa. Fabricado en latón.

To connect two motors to a single tank, or vice versa. Made in machined brass.

Per collegare due motori a un singolo serbatoio o viceversa. Fabbricato in ottone.

Té en laiton, pour connecter deux moteurs à un même réservoir, ou inversement.

| REF | | |
|---------|----------|---|
| GS31069 | 1/4" NPT | 1 |



| REF | OEM | |
|----------------|-------------|--------------------|
| REC65750-94404 | 65750-94404 | GS31039 GS31038 |
| | 65750-94403 | |
| | 65750-94402 | |
| | 65750-94401 | |

DT4 --> DT140



new

| REF | OEM | |
|----------------|-------------|---------|
| REC65720-986L0 | 65720-986L0 | GS31089 |
| | 65720-986A0 | |
| | 65720-986B0 | |

DF25 --> DF140



new

| REF | OEM |
|----------------|-------------|
| REC65720-98520 | 65720-98520 |
| | 65720-98500 |
| | 65720-98501 |
| | 65720-98502 |
| | 65720-98521 |
| | 65720-985L1 |

9.9, 15 HP 4 T/-strokes
2 --> 65 HP 2 T/-strokes





new

COMPATIBLE CON CONECTOR
COMPATIBLE WITH CONNECTOR
COMPATIBILE CON CONNETTORE
COMPATIBLE AVEC CONECTEUR

| REF | OEM |  | |
|---------|-------------|---|---------|
| GS31037 | 65740-99100 | 1/4" NPT | GS31035 |

2 --> 60 HP 2 T/Strokes

COMPATIBLE CON CONECTOR
COMPATIBLE WITH CONNECTOR
COMPATIBILE CON CONNETTORE
COMPATIBLE AVEC CONECTEUR

| REF | OEM |  | |
|---------|-------------|---|----------------|
| GS31038 | 65720-94411 | mm | REC65750-94404 |

DT75- 140 HP 2T/Strokes
antigüos | old | vecchio | ancien





COMPATIBLE CON CONECTOR
COMPATIBLE WITH CONNECTOR
COMPATIBILE CON CONNETTORE
COMPATIBLE AVEC CONECTEUR

| REF | OEM |  | |
|---------|-------------|---|----------------|
| GS31039 | 65720-94403 | 1/4" NPT | REC65750-94404 |



DT4--> 65 HP 2T/Strokes
antigüos | old | vecchio | ancien





COMPATIBLE CON CONECTOR
COMPATIBLE WITH CONNECTOR
COMPATIBILE CON CONNETTORE
COMPATIBLE AVEC CONECTEUR

| REF | OEM |  | |
|---------|-------------|---|---------|
| GS31070 | 65740-95D00 | 1/4" NPT | GS31072 |

COMPATIBLE CON CONECTOR
COMPATIBLE WITH CONNECTOR
COMPATIBILE CON CONNETTORE
COMPATIBLE AVEC CONECTEUR

| REF | OEM |  | |
|---------|-------------|---|---------|
| GS31035 | 65750-98505 | 5/16" | GS31037 |
| GS31036 | 65750-98505 | 3/8" | GS31037 |

-60HP 2 T/Strokes

Conector pequeño.
Little connector.
Connettore piccolo.
Conecteur petit.







COMPATIBLE CON CONECTOR
COMPATIBLE WITH CONNECTOR
COMPATIBILE CON CONNETTORE
COMPATIBLE AVEC CONECTEUR

| REF | OEM |  | |
|---------|-------------|---|----------------|
| GS31089 | 65750-89J11 | 3/8" | REC65720-986L0 |

DF4--> DF140 HP 4 T/Strokes

COMPATIBLE CON CONECTOR
COMPATIBLE WITH CONNECTOR
COMPATIBILE CON CONNETTORE
COMPATIBLE AVEC CONECTEUR

| REF | OEM |  | |
|---------|-------------|---|---------|
| GS31071 | 65750-95500 | 5/16" | GS31070 |
| GS31072 | 65750-95500 | 3/8" | GS31070 |

60HP+ 2 T/Strokes

Conector grande.
Big connector.
Connettore grande.
Conecteur grand.





| REF |  |  |
|---------|---|---|
| GS31092 | 8 mm | 1 |

Conector doble.
Double connector.
Connettore doppio.
Double connecteur..





PASAMAMPAROS THRU HULL PASSASCAFO PASSE-CLOISON

Para atravesar mamparos de hasta 12 mm. Fabricado en latón. For bulkhead up to 12 mm. Made in machined brass. Per attraversare paratie fino a 12 mm. Fabbriato in ottone. Pour traverser des cloisons jusqu'à 12 mm. Fait en laiton.

| REF |  |  |
|---------|---|---|
| GS31064 | 3/8" | 1 |





FILTRO DE COMBUSTIBLE Y ELEMENTOS

FUEL FILTERS AND ELEMENTS

FILTRI BENZINA E RACCORDI

FILTRE À ESSENCE ET CARTOUCHE DE RECHANGE

BRACKET

BRACKET

SUPPORTO

TÊTE DE FILTRE À ESSENCE

Con 2 tapones de bronce y 2 tubos de extensión. (2 entradas y 2 salidas).

With 2 brass plugs and 2 extension tubes. (2 inputs & 2 outputs).

Con 2 tappi di bronzo e 2 tubi di estensione. (2 ingressi entrata carburante e 2 uscite carburante).

Avec 2 bouchons en bronze et 2 tubes d'extension. (2 entrées et 2 sorties).

| REF |  |  |
|--------------|---|---|
| REC25000 | 1/4" | AL |
| REC25010 | 1/4" | INOX /SS AISI316 |
| REC25020 | 3/8" | AL |
| REC25030 | 3/8" | INOX /SS AISI316 |
| RECOBBRACKET | 1/4" | Plástico Plastic Plastica Plastique |



REC25000 - REC25020



REC25010 - REC25030



RECOBBRACKET

FILTRO COMBUSTIBLE SEPARADOR DE AGUA

WATER SEPARATING FUEL FILTER

FILTRO SEPARATORE ACQUA-BENZINA

FILTRE SEPARATEUR EAU-ESSENCE

| REF | MICRON |  |
|-----------------|--------|---|
| REC24942 | 10 | 4 ⁷ / ₁₆ " = 11 cm |
| REC35-802893Q01 | 10 | 3 ³ / ₄ " |
| REC855686 | 28 | 4 ⁷ / ₁₆ " |
| REC35-802893Q | 25 | 3 ³ / ₄ " |
| RACPF5510 | 10 | 4 ⁷ / ₁₆ " |

RACOR

RECMAR



RACPF5510



REC24942



REC35-802893Q01



REC855686



REC35-802893Q

Filtro original.

OEM filter.

Filtro benzina originale.

Filtre à essence d'origine

| REF | MICRON |  |
|--------------|--------|---|
| RM35-802893Q | 10 | 3 ³ / ₄ " |



FILTRO CON BRACKET

Con 2 tapones de bronce y 1 tubo de extensión.

OEM FILTER WITH BRACKET



With 2 brass plugs & 1 extension tube.

FILTRO BENZINA CON SUPPORTO

Con 2 tappi di bronzo e 1 tubo di estensione.

FILTRE À ESSENCE AVEC SUPPORT

Avec 2 bouchons en bronze et 1 tube d'extension

| REF | MICRON |  |  | BRACKET |
|----------|--------|---|---|---------|
| REC24950 | 25 | 1/4" | 50 GPH | AL |
| REC24952 | 10 | 1/4" | 50 GPH | AL |





RECMAR

FILTRO DECANTADOR DE COMBUSTIBLE COMPLETO CON VASO TRASPARENTE



COMPLET FUEL FILTER WITH TRANSPARENT BOWL

FILTRO DI DECANTAZIONE BENZINA COMPLETO CON VASCHETTA TRASPARENTE

FILTRE DÉCANTEUR ESSENCE AVEC BOL TRANSPARENT

| REF |  |  |
|----------------|---|---|
| RAC320R-RAC-01 | | AL |
| RAC320R-RAC-03 | RACS3213 LENS3213 | Plástico Plastic Plastique |

RACOR

| REF |  |  | BRACKET |
|------------|---|---|----------------------------------|
| RECOFILALU | | | AL |
| RECOFILTER | RECOBELEMENT LENS3213 | 150 l/h | Plástico Plastic Plastique |



RECMAR





FILTRO CON BOMBA CEBADORA

FILTER WITH PRIMMING PUMP

FILTRO CON POMPETTA PER RIEMPIRE

FILTRE À ESSENCE AVEC POMPE D'AMORCAGE



| REF | OEM |  | OEM  | MICRON |  |  |  |
|----------------|-----------------|---|---|--------|--|---|---|
| RAC490R-RAC-01 | 99105-20005-ASY | RACS3227 LENS3227 | 99105-20005 | 10 | 340 l/h | 3/8" NPTF | 150 hp |



FILTRO DECANTADOR GASOLINA

COMPLETE FUEL FILTER

FILTRO DECANTATORE BENZINA

FILTRE DÉCANTEUR ESSENCE

Filtro de combustible con braket.



Complete fuel filter with braket.

Filtro combustibile con supporto.

Filtre à carburant avec support.

| REF |  | |
|-------------|---|-----------------------|
| RAC23299-10 | RAC23289-10 | 130 HP (4 T/ Strokes) |



| REF | OEM |  | R.O. / OEM | MICRON |  |  |
|----------------|-------------|---|-------------|--------|---|---|
| REC90794-46866 | 65900-98J00 | REC90794-46868 | 65910-98J00 | 10 | 117 l/h | 175 hp |



LLAVE PARA FILTRO
FILTER KEY
CHIAVE DA FILTRO
CLÉ A FILTRE

REF
RECYS-225-15



| REF | MICRON |  |
|-----------------|--------|---|
| PAF40-0701000EI | 10 | 70 hp |



Ø 6 mm





new

RÁCORES



RACORS

RACCORDI

RACCORDS

| REF |  |  |  |
|---------|---|---|---|
| GS31065 | 1/4" NPT | 3/8" = 9.5 mm | 1 |
| GS31166 | 1/4" NPT | 5/16" = 7.9 mm | 2 |
| GS31155 | 3/8" NPT | 3/8" = 9.5 mm | 2 |
| GS31156 | 3/8" NPT | 5/16" = 7.9 mm | 2 |
| GS31157 | 3/8" NPT | 1/4" = 6.4 mm | 2 |



| REF |  |  |  |
|---------|---|---|---|
| GS31066 | 1/4" NPT | 5/16" = 7.9 mm | 2 |
| GS31067 | 1/4" NPT | 3/8" = 9.5 mm | 2 |





LLAVES PARA FILTRO

FILTER KEY

CHIAVE DA FILTRO

CLÉ À FILTRE

| REF | OEM |
|------------|-------------|
| RACRK22628 | 99105-20003 |





| REF | OEM |
|----------|-------------|
| REC70720 | 65 - 110 mm |



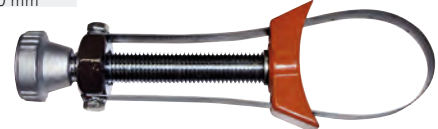





FILTRO COMBUSTIBLE PARA MONTAJE EN LÍNEA

IN-LINE FUEL FILTER

FILTRO BENZINA PER MONTARE IN LINEA

FILTRE A ESSENCE EN LIGNE

| REF |  |  |  |  |
|---------|---|---|---|---|
| GS31001 | 50 l/h | 6-8 mm | plástico plastic | 1 |
| GS31002 | 150 l/h | 8-10 mm | plástica plastique | 1 |



GS31001

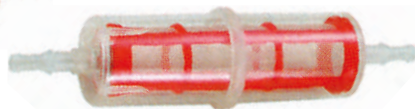

GS31002



| REF | OEM |
|----------------|-------------|
| REC15410-87L00 | 15410-87L00 |

 DF9.9B, DF15A, DF20A (2013)
DF25A, DF30A (2015)
DF90A, DF80A, DF90A (2009+)



| REF | OEM |
|----------------|-------------|
| REC15410-87J30 | 15410-87J30 |



 DF20R, DF25, DF25R V2 (2006-11)
DF40, DF50X-K10 (1999-10)
DF60, DF70W-K9 (1998-09)
DF90, DF100, DF115 K1-K11 (2001-11)
DF140 (2002-12)



| REF | OEM |
|----------------|-------------|
| REC15410-96J00 | 15410-96J00 |



 DF150T-Z, DF175T-Z (2006-13)
DF150T (G)Z, DF175T (G)Z (2014)



| REF |  |  |  |
|---------|---|---|---|
| GS30435 | 6, 8, 10 mm | metal + cristal metal + crystal metallo + cristallo métal + verre | 1 |





| REF | OEM |  |  |  |
|----------|-------|---|---|---|
| REC40145 | 40145 | 1/4" | 1/4" | plástico |
| REC40155 | 40155 | 5/16" | 5/16" | plastic |
| REC40165 | 40165 | 3/8" | 3/8" | plástica |
| REC40135 | 40135 | 5/16" | 3/8" | plastique |



| REF | OEM |
|----------------|-------------|
| REC15410-87J10 | 15410-87J10 |

 DF25, DF30Y-K6 (2000-06)
DF40, DF50X-K10 (1999-10)
DF60, DF70W-K9 (1998-09)
DF90, DF100, DF115K1-K11 (2001-11)
DF140 (2002-11)



| REF | OEM |
|-----------------|-------------|
| REC65L-24563-00 | 15412-93J00 |

 DF200, DF225, DF250 (2004-11)
DF300T-Z (2007-11)



| REF | OEM |  |
|----------------|-------------|---|
| PAF15-07080000 | 15410-94400 | 15 - 60 hp |

 DT9.9K, DT15K-G-Y (1986-00)
DT25C, DT30C-K-Y (1989-00)
DT20, DT25, DT30G-Y (1986-00)
DT55, DT65J-X (1988-99)
DT40C-W-G-X (1986-99)
DT5, DT6, DT8G-Y (1986-00)



| REF | OEM |
|----------------|-------------|
| REC15410-98500 | 15410-98500 |



DF4, DF5, DF6 (2002-14)
DF8A, DFAR, DF9.9A, DF9.9AR (2010+)
DF9.9, DF15T-K3 (1996-03)
DF9.9, DF15 (R) (2004-12)
DF40, DF50X-K10 (1999-10)
DF60, DF70W-K9 (1998-09)
DF150T-Z, DF175T-Z (2006-11)

| REF | OEM |
|----------------|-------------|
| REC15412-92J00 | 15412-92J00 |



DF100A, DF115, DF140A (2013+)
DF150, DF175, DF200 A/AP/AT (2015+)
DF70A, DF80A, DF0A, DF100B (2018+)

| REF | OEM |
|----------------|-------------|
| REC90794-46868 | 65910-98J00 |



DF8 --> DF300
DT9.9 40HP

| REF | OEM |
|-----------------|-------------|
| REC69J-24501-10 | 15643-93J00 |



DF200, DF225, DF250 (2004+)
DF250AP, DF300AP (2013+)
DF300T/Z (2007-11)
DF300AP (2012)

| REF | OEM |
|----------------|-------------|
| REC15410-88L00 | 15410-88L00 |



DF40A, DF50A, DF60A (2010+)

| REF | OEM |
|----------------|-------------|
| REC15412-93J10 | 15412-93J10 |



DF200, DF225, DF250 (2004+)
DF250AP, DF300AP (2015+)
DF300T/F (2004-11)
DF350A, DF325A (2018+)

| REF | OEM |
|----------------|-------------|
| REC15410-93J00 | 15410-93J00 |



DF200, DF225, DF250 (2004-11)
DF300T/Z (2007-11)

| REF | OEM |
|------------------|-------------|
| REC16910-GB2-005 | 15410-94350 |



DT40C-W-G-X (1986-99)
DT40WK1-K4 (2001-04)
DT5Y (1998-02)
DT9.9, DT15K1-K4 (2001-04)
DT9.9K, DT15KG-Y (1986-00)

FILTRO COMBUSTIBLE ALTA PRESION

HIGH PRESSURE FUEL FILTER

| REF | OEM |
|----------------|-------------|
| REC15410-87J00 | 15410-87J10 |



DF40, DF50X-K10 (1999-10)

FILTRO BENZINA ALTA PRESSIONE

FILTRE À ESSENCE HAUTE PRESION

| REF | OEM |
|----------------|-------------|
| REC15440-96J00 | 15440-96J00 |



DF150T/Z, DF175T/Z (2006-11)

| REF | OEM |
|----------------|-------------|
| REC15440-87L10 | 15440-87L10 |



DF70A, DF80A, DF90A (2009-12)

| REF | OEM |
|----------------|-------------|
| REC15440-90J00 | 15440-90J00 |



DF90, DF100, DF115 (2002-11)
DF140 (2002-12)

| REF | OEM |
|----------------|-------------|
| REC15440-96J01 | 15440-96J01 |



DF150, DF175, DF200 A/P (2015+)
DF150, DF175, DF200 G/Z/AT (2006+)

| REF | OEM |
|----------------|-------------|
| REC15440-93J00 | 15440-93J00 |



DF200, DF225, DF250 (2004-18)
DF250AP, DF300AP (2012+)
DF300T/Z (2007-11)

| REF | OEM |
|----------------|----------------------------|
| REC15440-99E01 | 15440-99E01 15440-99E00 |

DF60, DF70W-K9 (1998-09)





new

FILTRO DE ACEITE OIL FILTER FILTRO OLIO FILTRE À HUILE

| REF | OEM |
|----------------|----------------------------|
| REC16510-05240 | 16510-45H10 16510-05240 |

DF8A-AR, DF9.9A-AR (2010+)
DF9.9, DF15T-K3 (1996-03)
DF9.9, DF115(R) (2004-11)
DF9.9B, DF15A, DF20A (2013)
DF15 (2012)

| REF | OEM |
|----------------|----------------------------|
| REC09280-54001 | 09280-54001 09280-56001 |

| REF | OEM |
|----------------|--|
| REC16510-90J00 | 16510-90J00 16510-61A30 16510-61A31 16510-61A01 16510-61A20-MHL 16510-61A21-MHL |

DF70A, DF80A, DF90A (2009-11)
DF90, DF100, DF115 K1-K11 (2001-11)
DF115WT, DF140WT-K3 (2001-11)



| REF | OEM |
|----------------|----------------------------|
| REC16510-87J00 | 16510-87J00 16510-87JL0 |

DF20R, DF25-R-V2 (2006-11)
DF25, DF30Y-K6 (2000-06)
DF40, DF50X-K10 (1999-10)
DF40A, DF50A, DF60A (2010+)
DF60, DF70W-K9 (1998-09)



| REF | OEM |
|----------------|---|
| REC16510-82703 | 16510-82703 16510-92J00 16510-81420 |

DF140 (2002-12)
DF115WT, DF140WT-K3 (2003)



| REF | OEM |
|----------------|-------------|
| REC16510-96J00 | 16510-96J00 |
| REC16510-93J00 | 16510-96J10 |

DF150T-Z, DF175T-Z (G) (2006+)
DF150AP, DF175AP, DF200AP (2018+)
DF150AT, DF175AT, DF200AT (2019)
DF200, DF225, DF250 (2004+)
DF200A (2015+)
DF300AP (2012+)
DF300T-Z (2007-11)
DF350A, DF325A (2018+)



REC16510-93J00 CAMBIA | CHANGE | CAMBIA | CHANGE --> REC16510-96J00

GUÍA FILTROS DE ACEITE OIL FILTER GUIDE GUIDA FILTRO OLIO GUIDE FILTRE À HUILE

| REF | REF |
|--|----------------------|
| DF9.9, 9.9TH, 9.9A, 9.9B, 15, 15A, 20A | 1996+ REC16510-05240 |
| DF25, 25V Twin, 25A, 30, 30A | REC16510-87J00 |
| DF40, 40A, 50, 50A, 60, 60A, 70 | REC16510-87J00 |
| DF70A, 90A | 2009+ REC16510-90J00 |
| DF90, 115 | REC16510-90J00 |

| REF | REF |
|---------------------------|----------------------------------|
| DF115A, DF140A | REC16510-90J00 |
| DF140 | REC16510-82703 |
| DF150, 175, 200A | REC16510-96J00 REC16510-93J00 |
| DF200, 225, 250, 300, 350 | REC16510-96J00 REC16510-93J00 |

JUNTA TAPÓN DE CÁRTER OIL DRAIN PLUG GASKET GUARNIZIONE, TAPO COPPA L'OLIO JOINT DE VIDANGE

| REF | OEM |
|----------------|-------------|
| REC09168-12012 | 09168-12012 |

DF25 --> DF350



new

| REF | OEM |
|----------------|-------------|
| REC09168-12017 | 09168-12017 |

DF4 --> DF30





new

ACEITE



OIL

OLIO

HUILES

| REF |  |  | |
|------------|---|---|-----------|
| REC2TU6 | 1 L | 6 | 2 STROKES |
| REC2TU3 | 5 L | 3 | TC-W3 |
| REC5W40U6 | 1 L | 6 | SAE 5W40 |
| REC5W40U3 | 5 L | 3 | |
| REC10W30U6 | 1 L | 6 | SAE 10W30 |
| REC10W30U3 | 5 L | 3 | |
| REC10W40U6 | 1 L | 6 | SAE 10W40 |
| REC10W40U3 | 5 L | 3 | |
| REC25W40U3 | 5 L | 3 | SAE 25W40 |
| REC80W90U3 | 5 L | 3 | SAE 80W90 |
| REC80W90U6 | 1 L | 6 | |



| REF |  |  | |
|------------------|---|---|-----------|
| RM92-858026QB1U6 | 1 L | 6 | 2 STROKES |
| RM92-858027QB1U3 | 3,8 L | 3 | |
| RM92-8M0086220U6 | 1 L | 6 | SAE 10W30 |
| RM92-8M0086221U3 | 4 L | 3 | |



RM92-858026QB1U6

RM92-858027QB1U3

RM92-8M0086220U6

RM92-8M0086221U3

BOMBA DE COMBUSTIBLE

FUEL PUMP

POMPA BENZINA

POMPE À ESSENCE

BOMBA DE COMBUSTIBLE MECANICA

FUEL PUMP MECHANICAL

POMPA BENZINA MECCANICA

POMPE À ESSENCE MECANIQUE

| REF | OEM | 2T STROKES | 4T STROKES | |
|---------------|-------------|------------|------------|---|
| PAF4-04090000 | 15100-91J00 | | |  |
| | 15100-91J01 | | ✓ | |
| | 15100-91J02 | | | |

DF4, DF5, DF6 (2002+)

new

| REF | OEM | 2T STROKES | 4T STROKES | |
|-----------------|-------------|------------|------------|---|
| REC692-24410-00 | 15100-94311 | | |  |
| | 15100-94301 | | ✓ | |
| | 15100-94303 | | | |
| | 15100-94310 | | | |

DT20, DT25, DT30G-Y (1986-00)
DT25C, T30C K-Y (1989-00)
DT40C-W G-X (1986-99)
DT55, DT65 J-X (1988-99)
DT8, D9.9C J-V (1988-99)
DT25, DT30 K1-K2 (2001-02)
DT40W K1-K4 (2001-04)

new

BOMBA DE COMBUSTIBLE ELECTRICA

FUEL PUMP ELECTRIC

POMPA BENZINA ELETTRICA

POMPE À ESSENCE ÉLECTRIQUE

| REF | OEM | 2T STROKES | 4T STROKES | |
|-----------------|-------------|------------|------------|---|
| REC63P-13907-03 | 15200-90J00 | | |  |
| | 15200-92J00 | | ✓ | |
| | 15200-93J01 | | | |

REC63P-14984-00

DF70A, DF80A, DF90A (2009-12)
DF90, DF100, DF115 (2001-11)
DF140 (2002-12)
DF100A, DF115A (2013)
DF100A, DF115A, DF140A (2014+)
DF140A (2013)
DF7A, DF80A, DF90A (2014+)
DF200, DF225, DF250 (2004+)

| REF | OEM | 2T STROKES | 4T STROKES | |
|----------------|----------------------------|------------|------------|--|
| REC15200-96J00 | 15200-96J00 | | |  |
| | DF150, DF175T/Z (G) (2014) | | | |
| | DF150, DF175T/Z (2006-13) | | | |

DF200A (2015)

**BOMBA DE COMBUSTIBLE
ALTA PRESIÓN**

**HIGH PRESSURE
FUEL PUMP**

**POMPA BENZINA
ALTA PRESSIONE**

**POMPE À ESSENCE
HAUTE PRESSION**

new

| REF | OEM |
|----------------|----------------------------|
| REC15200-82J20 | 15200-92J00 15200-92J20 |

DF70A, DF80A, DF90A, DF100B (2014+)
DF100A, DF115A, DF140A (BG, BZG) (2013+)



**KITS
MEMBRANAS Y JUNTAS**

**DIAPHRAGMS & GASKETS
SETS**

**KIT
MEMBRANA E GUARNIZIONI**

**KIT
MEMBRANES ET JOINTS**

| REF | OEM |
|----------------|-------------|
| REC15170-93911 | 15170-93920 |

DT9.9K, DT15K-G-Y (1986-00)
DT9.9, DT15K1-K4 (2001-04)
DT8, DT9.9C-J-V (1988-97)
DT15C (1989-97)



| REF | OEM |
|----------------|-------------|
| REC15170-98110 | 15170-98110 |

DT4, J4, DT5Y (1988-00)
DT4 K1 (2001)
DT5Y (1998-02)
DT5, DT6, DT8G-Y (1986-00)
DT6, DT8Y-K2 (2000-02)

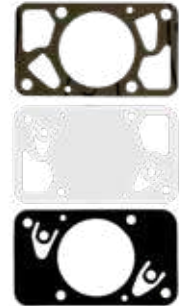

| REF | OEM |
|----------------|-------------|
| REC15170-94320 | 15170-94320 |

DT20, DT25, DT30G-Y (1986-00)
DT25, DT30 K1-K2 (2001-02)
DT25C, DT30C K-Y (1989-00)
DT40C-W-G-X (1986-99)
DT40W-K1-K4 (2001-04)
DT55, DT65J-X (1988-99)



| REF | OEM |
|----------------|-------------|
| REC15170-91J00 | 15170-91J00 |

DF4, DF5, DF6 (2002-11)



| REF | OEM |
|----------------|-------------|
| REC15170-94J00 | 15170-94J00 |

DF8A, DF8AR, DF9.9A, DF9.9AR (2010-11)
DF9.9, DF15 (R) (2004-11)



| REF | OEM |
|----------------|-------------|
| REC15170-99E00 | 15170-99E00 |

DF9.9, DF15R-K3 (1996-03)
DF25, DF30Y K6 (2000-06)
DF40, DF50Z-K10 (1999-10)
DF60, DF70W-K9 (1998-09)



JUNTAS VST

VST GASKETS

GUARNIZIONE VST

JOINTS VST

| REF | OEM |
|----------------|----------------------------|
| REC15626-99E00 | 15626-99E00 15643-99E00 |

DF40, DF50 X-K10 (1999-10)
DF60, DF70 W-K9 (1998-09)



new

| REF | OEM |
|----------------|-------------|
| REC15626-90J00 | 15626-90J00 |

DF70A, DF80A, DF90A (2009-12)
DF90, DF100, DF115 (2001-11)
DF140 (2002-12)
14002F
14002Z

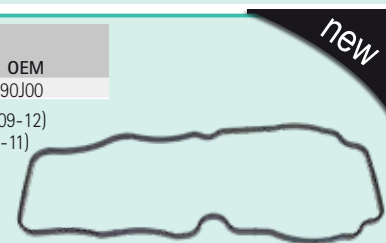

new

SUZUKI

RECAMBIOS
MARINOS

INYECTORES

INJEKTOR

INIETTORE



INJECTEURS



GUÍA INYECTORES Y SENSORES

GUIDE INJECTORS & SENDERS

GUIDA INIETTORI E SENSORI

GUIDE INJECTEURS ET SONDÉS

| | |  |  | |
|---------------|---------|---|---|----------------|
| | | MAP | IAC VALVE | |
| DF9.9B | 2013+ | REC15710-89L00 | REC18590-58M00 | |
| DF15A | 2013+ | REC15710-89L00 | REC18590-58M00 | |
| DF20A | 2013+ | REC15710-89L00 | REC18590-58M00 | |
| DF25A | 2015+ | REC15710-82M00 | REC18590-58M00 | |
| DF30A | 2015+ | REC15710-82M00 | REC18590-58M00 | |
| DF40 | 1999-10 | REC15710-87J00 | | |
| DF40A | 2010+ | REC15710-85K00 | | REC18137-88L01 |
| DF50 | 1999-01 | REC15710-87J00 | | |
| DF50A | 2010+ | REC15710-85K00 | | REC18137-88L01 |
| DF60 | | | | |
| (S/N 971543-) | 1998-09 | REC15710-99E00 | | |
| DF60 | | | | |
| (S/N 971544+) | 1998-09 | REC15710-66D00 | | |
| DF60A | 2010+ | REC15710-85K00 | | REC18137-88L01 |
| DF70 | | | | |
| (S/N 971543-) | 1998-09 | REC15710-99E00 | | |
| DF70 | | | | |
| (S/N 971544+) | 1998-09 | REC15710-66D00 | | |
| DF70A | 2009-11 | REC15710-87L00 | REC18590-68H00 | REC18137-87L01 |
| DF70A | 2012+ | REC15710-82K50 | REC18590-68H00 | REC18137-87L01 |
| DF80A | 2009-11 | REC15710-87L00 | REC18590-68H00 | REC18137-87L01 |
| DF80A | 2012+ | REC15710-82K50 | REC18590-68H00 | REC18137-87L01 |
| DF90 | 2001-07 | REC15710-65D00 | REC18590-68H00 | |
| DF90A | 2009-11 | REC15710-87L00 | REC18590-68H00 | REC18137-87L01 |
| DF90A | 2012+ | REC15710-82K50 | REC18590-68H00 | REC18137-87L01 |
| DF100 | 2001-07 | REC15710-65D00 | REC18590-68H00 | |
| DF115 | 2001-07 | REC15710-65D00 | REC18590-68H00 | |
| DF90 | 2008-11 | REC15710-65D00 | REC18590-72F21 | |
| DF100 | 2008-11 | REC15710-65D00 | REC18590-72F21 | |
| DF100A | 2013+ | REC15710-82K50 | REC18590-68H00 | |
| DF115WT | 2003-07 | REC15710-65D00 | REC18590-72F21 | |

| | |  |  | |
|---------------|---------|---|---|----------------|
| | | MAP | IAC VALVE | |
| DF115WT | 2008+ | REC15710-65D00 | REC18590-68H00 | |
| DF115 | 2008-11 | REC15710-65D00 | REC18590-72F21 | |
| DF115A | 2013+ | REC15710-82K50 | REC18590-68H00 | |
| DF140A | 2002-12 | REC15710-65D00 | REC18590-68H00 | |
| DF140WT K3 | 2003-07 | REC15710-65D00 | REC18590-72F21 | |
| DF140WT K3 | 2008+ | REC15710-65D00 | REC18590-68H00 | |
| DF140A | 2013+ | REC15710-82K50 | REC18590-68H00 | |
| DF150T/Z | 2006-12 | REC15710-96J00 | REC18590-68H00 | REC18137-52D00 |
| DF150 T/Z (G) | 2013+ | REC15710-96J00 | REC18590-68H00 | REC18137-93J00 |
| DF150AP | 2017+ | REC15710-96J00 | REC18590-68H00 | |
| DF150AT | 2019 | REC15710-96J00 | REC18590-68H00 | REC18137-93J00 |
| DF175T/Z | 2006-12 | REC15710-96J00 | REC18590-68H00 | REC18137-52D00 |
| DF175 T/Z (G) | 2013+ | REC15710-96J00 | REC18590-68H00 | REC18137-93J00 |
| DF175AP | 2017+ | REC15710-96J00 | REC18590-68H00 | |
| DF175AT | 2019 | REC15710-96J00 | REC18590-68H00 | REC18137-93J00 |
| DF200 | 2004-12 | REC15710-96J00 | REC18590-68H00 | REC18137-52D00 |
| DF200 | 2014+ | REC15710-93J00 | REC18590-68H00 | REC18137-93J00 |
| DF200A | 2015-17 | REC15710-96J00 | REC18590-68H00 | REC18137-93J00 |
| DF200AP | 2015+ | REC15710-96J00 | REC18590-68H00 | |
| DF200AT/AZ | 2018+ | REC15710-96J00 | REC18590-68H00 | REC18137-93J00 |
| DF225 | 2004-12 | REC15710-96J00 | REC18590-68H00 | REC18137-52D00 |
| DF225 | 2014+ | REC15710-93J00 | REC18590-68H00 | REC18137-93J00 |
| DF250AP | 2013-18 | REC15710-96J00 | REC18590-68H00 | |
| DF250 | 2004-12 | REC15710-96J00 | REC18590-68H00 | REC18137-52D00 |
| DF250 | 2014+ | REC15710-93J00 | REC18590-68H00 | REC18137-93J00 |
| DF300T/Z | 2007-11 | REC15710-96J00 | REC18590-68H00 | |
| DF300AP | 2012-18 | REC15710-96J00 | REC18590-68H00 | |
| DF325A | 2018+ | | REC18590-68H00 | |
| DF350A | 2018+ | | REC18590-68H00 | |

| INYECTOR | INJEKTOR | INIETTORE | INJECTEUR | | | | | | | | |
|--|----------------------------|-----------|----------------|-------------|--|--|--|-----|----------------|----------------------------|-------------|
| <table border="1"> <tr><th>REF</th><th>OEM</th></tr> <tr><td>REC15710-66D00</td><td>15710-66D00</td></tr> </table>  | REF | OEM | REC15710-66D00 | 15710-66D00 | | | <table border="1"> <tr><th>REF</th><th>OEM</th></tr> <tr><td>REC15710-87L00</td><td>15710-87L00</td></tr> </table>  | REF | OEM | REC15710-87L00 | 15710-87L00 |
| REF | OEM | | | | | | | | | | |
| REC15710-66D00 | 15710-66D00 | | | | | | | | | | |
| REF | OEM | | | | | | | | | | |
| REC15710-87L00 | 15710-87L00 | | | | | | | | | | |
| <table border="1"> <tr><th>REF</th><th>OEM</th></tr> <tr><td>REC15710-65D00</td><td>15710-65D00</td></tr> </table>  | REF | OEM | REC15710-65D00 | 15710-65D00 | | <table border="1"> <tr><th>REF</th><th>OEM</th></tr> <tr><td>REC15710-89L00</td><td>15710-89L00 15710-50M00</td></tr> </table>  | REF | OEM | REC15710-89L00 | 15710-89L00 15710-50M00 | |
| REF | OEM | | | | | | | | | | |
| REC15710-65D00 | 15710-65D00 | | | | | | | | | | |
| REF | OEM | | | | | | | | | | |
| REC15710-89L00 | 15710-89L00 15710-50M00 | | | | | | | | | | |
| <table border="1"> <tr><th>REF</th><th>OEM</th></tr> <tr><td>REC15710-87J00</td><td>15710-87J00</td></tr> </table>  | REF | OEM | REC15710-87J00 | 15710-87J00 | | <table border="1"> <tr><th>REF</th><th>OEM</th></tr> <tr><td>REC15710-82M00</td><td>15710-82M00</td></tr> </table>  | REF | OEM | REC15710-82M00 | 15710-82M00 | |
| REF | OEM | | | | | | | | | | |
| REC15710-87J00 | 15710-87J00 | | | | | | | | | | |
| REF | OEM | | | | | | | | | | |
| REC15710-82M00 | 15710-82M00 | | | | | | | | | | |
| <table border="1"> <tr><th>REF</th><th>OEM</th></tr> <tr><td>REC15710-99E00</td><td>15710-99E00</td></tr> </table>  | REF | OEM | REC15710-99E00 | 15710-99E00 | | <table border="1"> <tr><th>REF</th><th>OEM</th></tr> <tr><td>REC15710-85K00</td><td>15710-85K00</td></tr> </table>  | REF | OEM | REC15710-85K00 | 15710-85K00 | |
| REF | OEM | | | | | | | | | | |
| REC15710-99E00 | 15710-99E00 | | | | | | | | | | |
| REF | OEM | | | | | | | | | | |
| REC15710-85K00 | 15710-85K00 | | | | | | | | | | |

| REF | OEM |
|----------------|-------------|
| REC15710-96J00 | 15710-96J00 |



new

| REF | OEM |
|----------------|-------------|
| REC15710-82K50 | 15710-82K50 |



new

| REF | OEM |
|----------------|-------------|
| REC15710-93J00 | 15710-93J00 |



new

P 37

| REF |
|----------|
| STA93008 |
| STA93016 |



P 38

| REF |
|---------|
| GE22207 |



CARBURADOR

CARBURATOR

CARBURATORE

CARBURATEUR

CARBURADOR COMPLETO

FULL CARBURATOR

CARBURATORE COMPLETO

CARBURATEUR COMPLET

| REF | OEM |
|----------------|-------------|
| REC13200-91J70 | 13200-91J70 |

DF4, DF5, DF6 (2002-11)



new

| REF | OEM |
|----------------|----------------------------|
| REC13200-91D21 | 13200-91D21 13200-91D20 |

DT9.9, DT15 K1-K4 (2001-04)
DT9.9K, DT15KG-Y (1986-00)



new

KITS CARBURADORES

CARBURETOR KITS

KIT CARBURATORI

KIT CARBURATEUR

| REF | OEM |
|----------------|-------------|
| REC13910-87D00 | 13910-87D00 |

V6 MODELS (2T/STROKE)



| REF | OEM |
|----------------|-------------|
| REC13910-94701 | 13910-94701 |

DT55
DT75
DT115



| REF | OEM |
|----------------|-------------|
| REC13910-94400 | 13910-94400 |

DT40
DT65
DT85
DT140



| REF | OEM |
|----------------|-------------|
| REC13910-89J01 | 13910-89J01 |

DF25 (EXC V-TWIN)



BOYAS

FLOATS

GALLEGGIANTE

FLOTTEUR DE CARBURATEUR

| REF | OEM |
|----------------|-------------|
| REC13250-95D01 | 13250-95D01 |

DF9.9, DF15 T-K3 (1996-03)
DF9.9, DF15(R) (2004-11)
DT25C, DT30C K-Y (1989-00)



new

P 37

| REF |
|--------|
| GEGC15 |



SISTEMA ELÉCTRICO ELECTRIC SYSTEM

SISTEMA ELETTRICO SYSTEME ELECTRIQUE

SENSORES

SENSORS

SENSORE

CAPTEURS

SENSOR MAP

MAP SENSOR

SENSORE MAP

CAPTEUR MAP

| REF | OEM |
|----------------|-------------|
| REC18590-68H00 | 18590-68H00 |



new

| REF | OEM |
|----------------|-------------|
| REC18590-58M00 | 18590-58M00 |



new

| REF | OEM |
|----------------|-------------|
| REC18590-72F21 | 18590-72F21 |



new

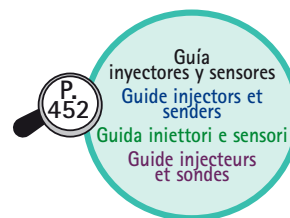

SENSOR IAC

IAC SENSOR

SENSORE IAC

CAPTEUR IAC

| REF | OEM |
|----------------|-------------|
| REC18137-93J00 | 18137-93J00 |
| REC18137-52D00 | 18137-52D00 |
| REC18137-88L01 | 18137-88L01 |
| REC18137-87L01 | 18137-87L01 |



new

| REF | OEM |
|----------------|-------------|
| REC13650-52G00 | 13650-52G00 |

DF9.9 --> DF350



new

| REF | OEM |
|----------------|-------------|
| REC13650-56B00 | 13650-56B00 |

DF60, DF70W-K9 (1998-09)



new

SENSOR CMP

CMP SENSOR

SENSORE CMP

CAPTEUR CMP

| REF | OEM |
|----------------|---|
| REC33220-76G02 | 33220-76G00 33220-76G01 33220-76G02 |

DF40, DF50X-K10 (1999-10)
DF90, DF100, DF115 (2001-11)
DF140 (2002-12)
DF115, DF140WT (2003)



new

| REF | OEM |
|----------------|-------------|
| REC33220-58J20 | 33220-58J20 |

DF150, DF175 (G)Z/T (2014)
DF150, DF175T/Z (2006-13)
DF40A, DF50A, DF60A (2009-12)
DF70A, DF80A, DF90A (2012)



new

BOBINAS

COILS

BOBINE

BOBINES

BOBINA

COIL

BOBINA

BOBINE

| REF | OEM |
|--------------------|--------------------------------|
| REC33410-94400-000 | 33410-94400-000 33410-93E10 |



 DF9.9, DF15T -K3 (1996-03)
 DF9.9, DF15(R)' (2004-10)
 DT40C-W-G-X (1986-99)
 DT40W-K1-K4 (2001-04)

| REF | OEM |
|----------------|-------------|
| REC32140-94400 | 32140-94400 |



 DT40C-WG-X (1986-99)
 DT40W K1-K4 (2001-04)

| REF | OEM |
|----------------|-------------|
| REC32900-96340 | 32900-96340 |



 DT20, DT25, DT30G-Y (1986-00)

| REF | OEM |
|----------------|-------------|
| REC32140-96310 | 32140-96310 |



 DT20, DT25, DT30G-Y (1986-00)
 DT25, DT30 K1-K2 (2001-02)

| REF | OEM |
|----------------|----------------------------|
| REC32900-93903 | 32900-93903 32900-93902 |



 DT9.9K, DT15G-Y (1986-00)

| REF | OEM |
|----------------|-------------|
| REC32140-93900 | 32140-93900 |



 DT9.9, DT15K1-K4 (2001-04)
 DT9.9K, DT15K-G-Y (1986-00)

| REF | OEM |
|----------------|-------------|
| REC33410-93J00 | 33410-93J00 |



 DF150/175T,Z (2006-18)
 DF200/225/250 (2004+)
 DF250AP/300AP (2012+)
 DF300T,Z (2007-11)

| REF | OEM |
|----------------|-------------|
| REC33410-96L00 | 33410-96L00 |



 DF150/175/200AT,AZ (2020+)
 DF150AP/175AP/200AP (2017+)
 DF150AT/175AT/200AT (2019+)
 DF200A, AP (2015-17)
 DF200AT, AZ (2018)

REGULADOR-BOBINA

REGULATOR-COIL

REGOLATORE-BOBINA

REGULATEUR-BOBINE

| REF | OEM |
|----------------|---|
| REC32900-94480 | 32900-94401 32900-94421 32900-94480 |



 DT40C-W-X-G (1986-99)

BUJÍAS

SPARK

CANDELE

BOUGIES



| STROKES | 4T | REF | RO / OEM |
|--------------|---------|-------------|-------------|
| | | NGK | |
| DF2.5, DF6 | | NGKCR6HSA | 09482-00406 |
| DF4, DF6 | 2003-10 | NGKBPR6ES | 09482-00299 |
| DF4, DF6 | 2011+ | NGKCPR6EA-9 | 09482-00L04 |
| DF9.9A | | NGKCR6E | 09482-00528 |
| DF9.9, DF15 | 2004- | NGKDCPR6E | 09482-00446 |
| DF9.9, DF15 | 2004-10 | NGKBKR6E | 09482-00427 |
| DF9.9, DF15 | 2010+ | NGKCPR6EA-9 | 09482-00L04 |
| DF25A, DF30A | | NGKDCPR6E | 09482-00446 |
| DF25 V-TWIN | | NGKBKR6E | 09482-00427 |
| DF40, DF50 | | NGKDCPR6E | 09482-00446 |
| DF60, DF70 | | NGKBPR6ES | 09482-00299 |

| STROKES | 4T | REF | RO / OEM |
|------------------------|----|-------------|-------------|
| | | NGK | |
| DF40A, DF50A, DF60A | | NGKDCPR6E | 09482-00446 |
| DF70A, DF90A | | NGKDCPR6E | 09482-00446 |
| DF90, DF115, DF140 | | NGKBKR6E | 09482-00427 |
| DF150, DF175 | | NGKBKR6E | 09482-00427 |
| DF200A, DF200AP | | NGKLR6E | 09482-00649 |
| DF200, DF225, DF250 | | NGKBKR6E | 09482-00427 |
| DF200SS | | NGKBKR6E | 09482-00427 |
| DF300 | | NGKBKR6E | 09482-00427 |
| DF300B, DF350A, DF325A | | NGKILZKR7D8 | 09482-00642 |





| 2T STROKES | | | 2T STROKES | | | 2T STROKES | | |
|------------|---------|-------------|-------------|---------|-------------|---------------|---------|--------------|
| | | REF NGK | | | REF NGK | | | REF NGK |
| DT2 | 1986-90 | NGKBR4HS | DT30 | 1983-85 | NGKBR7HS-10 | DT85WT | 2001 | NGKB8HS-10 |
| DT2 | 1991-99 | NGKBR5HS | DT30C | 1988-00 | NGKBR7HS-10 | DT85WT | 1995-96 | NGKB8HS-10 |
| DT2.2 | 1992 | NGKBR5HS | DT30E | 1983 | NGKBR7HS-10 | DT90 | -2000 | NGKBR8HCS-10 |
| DT4 | 1988-92 | NGKBP5HS | DT40 | -1983 | NGKB8HS | DT90 | 2001 | NGKBR8HS-10 |
| DT4 | 1993-01 | NGKBP5HS | DT40C | 1986-99 | NGKB8HS-10 | DT90TC | 1996-97 | NGKBR8HS |
| DT4.5 | | NGKBR6HS | DT40C/CR/TC | 1998 | NGKB8HS-10 | DT90TC | -1995 | NGKBR8HCS-10 |
| DT4L/S | 1994 | NGKBP5HS | DT40W | 1995 | NGKB7HS-10 | DT90TC | 1998 | NGKBR8HS-10 |
| DT4L/S | -1993 | NGKBP5HS | DT40WK | 1998 | NGKB7HS-10 | DT100 | 2001 | NGKBR8HS-10 |
| DT5 | 1986-92 | NGKBP6HS | DT40WK | -1997 | NGKB7HS | DT100 | 1996-00 | NGKBR8HS-10 |
| DT5 | 1993-94 | NGKBP6HS | DT48M | 2001 | NGKB8HS-10 | DT100 | 1990-95 | NGKBR8HCS-10 |
| DT5 | 1995-00 | NGKBR6HS | DT48M | -2000 | NGKB8HS | DT100 | 2000 | NGKBR8HCS-10 |
| DT5W | 1986-92 | NGKBR6HS | DT50 | 1979-83 | NGKB8HS | DT100TC | -1995 | NGKBR8HCS-10 |
| DT5Y | 1998-01 | NGKBP7HS-10 | DT50 | -1978 | NGKB7HS | DT100TC | 1998 | NGKBR8HS-10 |
| DT6 | 1986-92 | NGKB6HS-10 | DT50 | 1984-89 | NGKB8HS-10 | DT100TC | 1996-97 | NGKBR8HS |
| DT6 | 1993-02 | NGKBR6HS | DT50ACR | 1994-96 | NGKB8HS-10 | DT115 | -1990 | NGKB8HS |
| DT6 | -1985 | NGKB6HS | DT50ACR | 1993 | NGKBR8HS | DT115 | 1992 | NGKBR8HCS-10 |
| DT6 | 1995-99 | NGKBR6HS-10 | DT50C | 1984-00 | NGKB8HS-10 | DT115C | 1991-93 | NGKBR8HCS-10 |
| DT6S/5PS | -1992 | NGKB6HS | DT50K | | NGKB7HS | DT115C | -1990 | NGKB8HS |
| DT7.5 | | NGKBR6HS | DT50M/DT50 | 1986-89 | NGKB8HS-10 | DT115C | 2001 | NGKBR8HS-10 |
| DT8 | 1986-02 | NGKBP6HS | DT50M/DT50 | -1985 | NGKB8HS | DT115S | 1996 | NGKBR8HS-10 |
| DT8C | 1988-97 | NGKBR6HS-10 | DT50M/DT50 | 2001 | NGKBR8HS-10 | DT115TC | 1996 | NGKBR8HS-10 |
| DT9 | | NGKB6HS-10 | DT55C | 1988-98 | NGKBR8HS-10 | DT115TC | -1988 | NGKB8HS-10 |
| DT9.9 | 1986-99 | NGKBR7HS-10 | DT55M/MQ | -2000 | NGKB8HS | DT115TC | | NGKBR8HCS-10 |
| DT9.9 | 1977-78 | NGKB7HS | DT55M/MQ | 2001 | NGKBR8HS-10 | DT115TC (EFI) | | NGKBR8HS-10 |
| DT9.9 | 1879-84 | NGKBR6HS | DT55TC/CRQ | 1998 | NGKBR8HS-10 | DT140 | 1992 | NGKBR8HCS-10 |
| DT9.9 | 1976 | NGKB6HS | DT60 | | NGKB8HS-10 | DT1140 | -1990 | NGKB8HS |
| DT9.9C | 1988-97 | NGKBR6HS-10 | DT60C | 2001 | NGKBR8HS-10 | DT140 EFI | 1996 | NGKBR8HS-10 |
| DT9.9E | 1982 | NGKB6HS | DT60C | 1986-87 | NGKB8HS-10 | DT140C | 1991-96 | NGKBR8HCS-10 |
| DT9.9E | 1984 | NGKB7HS | DT65/T | -1983 | NGKBR8HS | DT1140C | -1990 | NGKB8HS |
| DT9.9E | 1983 | NGKBR7HS-10 | DT65C | 1988-99 | NGKBR8HS-10 | DT140C EFI | 1997 | NGKBR8HCS-10 |
| DT9.9K | 1985-86 | NGKB6HS | DT65TC | 1994-95 | NGKBR8HS-10 | DT140T | -2000 | NGKBR8HCS-10 |
| DT9.9K | -1985 | NGKBR6HS | DT75/85 | 1990-92 | NGKB8HS | DT140T | 2001 | NGKBR8HS-10 |
| DT9.9K | 1986-90 | NGKB6HS | DT75/85 | 1993-00 | NGKBR8HS-10 | DT140TC | -2000 | NGKBR8HCS-10 |
| DT9.9P | -1983 | NGKBP6HS | DT75C | 2001 | NGKBR8HS-10 | DT140TC EFI | | NGKBR8HS-10 |
| DT15 | 1986-02 | NGKBR7HS-10 | DT75C | 1993-00 | NGKB8HS | DT150 | 1987-02 | NGKBR8HS-10 |
| DT15C | 1989-97 | NGKBR7HS-10 | DT75M | 2001 | NGKBR8HS-10 | DT150G | | NGKBR8HS-10 |
| DT15K | -1985 | NGKBR6HS | DT75M | -2000 | NGKBR8HS | DT150S | | NGKBR8HS-10 |
| DT15K | 1986 | NGKB6HS | DT75TC | -2000 | NGKB8HS | DT150SS | | NGKBR8HS-10 |
| DT20 | 1997-00 | NGKBR7HS-10 | DT75TC | 2001 | NGKBR8HS-10 | DT150STC | | NGKBR8HS-10 |
| DT20/P | -1985 | NGKBR7HS | DT85 | -1992 | NGKBR8HS | DT150TC | 1989 | NGKBR8HS-10 |
| DT20/P | 1986 | NGKBR7HS-10 | DT85C | 2001 | NGKBR8HS-10 | DT150TC EFI | | NGKBR8HS-10 |
| DT20K | -1985 | NGKBR7HS-10 | DT85C | 1993-00 | NGKBR8HS | DT175 | 1989-02 | NGKBR8HS-10 |
| DT20K | 1986-87 | NGKB7HS-10 | DT85C | -1992 | NGKBR8HS | DT175TC | -1988 | NGKB8HS-10 |
| DT25 | -1985 | NGKBR7HS | DT85M | 2001 | NGKBR8HS-10 | DT175TC | 1989 | NGKBR8HS-10 |
| DT25 | 2000-01 | NGKBR7HS-10 | DT85M | -2000 | NGKBR8HS | DT200 | 1989-02 | NGKBR8HS-10 |
| DT25C | 1989-97 | NGKBR7HS-10 | DT85MQ | 1995-96 | NGKB8HS-10 | DT200G | | NGKBR8HS-10 |
| DT25E | 1983-85 | NGKBP7HS-10 | DT85Q | 2001 | NGKBR8HS-10 | DT200T | | NGKBR8HS-10 |
| DT25E | -1982 | NGKB7HS | DT85Q | -2000 | NGKBR8HS | DT200TC | 1989 | NGKBR8HS-10 |
| DT25E | 1986 | NGKBR7HS-10 | DT85TC | -2000 | NGKB8HS | DT200V | | NGKBR8HS-10 |
| DT25K | 1986 | NGKBR7HS-10 | DT85TC | 2001 | NGKBR8HS-10 | DT225 | 1991-02 | NGKBR8HS-10 |
| DT28/P/E | | NGKB7HS | DT85W | 2001 | NGKB8HS-10 | DT225TC | | NGKBR8HS-10 |
| DT30 | 1986 | NGKBR7HS-10 | DT85W | -2000 | NGKBR8HS | DT225TCL EFI | | NGKBR8HS |

| 2T STROKES | | | 2T STROKES | | |
|------------|---------|--------------|--------------|---------|--------------|
| | | REF CHAMPION | | | REF CHAMPION |
| DT2 | 1977-96 | CHAL90C | DT40 | 1980-98 | CHAQL78C |
| DT2.2 | 1997 | CHAL90C | DT50 | 1997-84 | CHAQL78C |
| DT3.5 | 1979-84 | CHAQL87YC | DT55 | 1985-97 | CHAQL78C |
| DT4 | 1985-98 | CHAQL87YC | DT60 | 1983-84 | CHAQL78C |
| DT4.5 | 1977 | CHAQL86C | DT65 | 1978-97 | CHAQL78C |
| DT5 | 1978-83 | CHAQL87YC | DT75 | 1983-97 | CHAQL78C |
| DT5Y | 1999-01 | CHAQL82YC | DT85 | 1979-97 | CHAQL78C |
| DT6 | 1984-97 | CHAQL87YC | DT85 | 1998 | CHAQL78C |
| DT6 | 1998-01 | CHAQL87YC | DT90 V4 | 1989-97 | CHAQL78C |
| DT7.5 | 1977-79 | CHAQL86C | DT100 V4 | 1989-01 | CHAQL78C |
| DT8 | 1980-87 | CHAQL87YC | DT115 Carb | 1981-97 | CHAQL78C |
| DT9 | 1977-79 | CHAQL86C | DT115 EFI | 1996-01 | CHAQL78C |
| DT9 | 1993 | CHAQL86C | DT115S EFI | 1998 | CHAQL78C |
| DT9.9C | 1983-97 | CHAQL82C | DT140 Carb | 1981-96 | CHAQL78C |
| DT15 | 1983-88 | CHAQL86C | DT140 EFI | 1997-01 | CHAQL78C |
| DT15C | 1989-97 | CHAQL82C | DT150 V6 | | |
| T16 | 1977-82 | CHAQL86C | DT150 V6 EFI | 1986-94 | CHAQL78C |
| DT20 | 1977-88 | CHAQL82C | DT175 V6 | 1991-93 | CHAQL78C |
| DT25C | 1977-00 | CHAQL82C | DT200 EFI | 1986 | CHAQL78C |
| DT30C | 1989 | CHAQL82C | DT225 EFI | 1991 | CHAQL78C |
| DT35 | 1989 | CHAQL82C | | | |

| 4T STROKES | | |
|------------|---------|--------------|
| | | REF CHAMPION |
| DF4 | 2003-04 | CHARN9YC |
| DF6 | 2003-04 | CHARN9YC |
| DF9.9 | 1997-04 | CHARA8HC |
| DF15 | 1997-04 | CHARA8HC |
| DF25 | 2000-04 | CHARA8HC |
| DF30 | 2000-04 | CHARA8HC |
| DF40 | 1999-04 | CHARA8HC |
| DF50 | 1999-04 | CHARA8HC |
| DF60 | 1998-04 | CHARN9YC |
| DF70 | 1998-04 | CHARN9YC |
| DF90 | 2001-04 | CHARC9YC |
| DF115 | 2001-04 | CHARC9YC |
| DF140 | 2002-04 | CHARC9YC |



CHAMPION



MOTORES DE ARRANQUE

STARTERS

MOTORINI AVVIAMENTO

DEMARREURS

MOTORES DE ARRANQUE

STARTERS

MOTORINI AVVIAMENTO

DEMARREURS

| REF | OEM | ⚡ | ☀️ | 2T STROKES | 4T STROKES |
|------------|-------------|-----|--------|---------------|---------------|
| PH130-0006 | 31100-96310 | 12V | 0.6 kw | 9 CCW | ✓ |
| | 31100-96311 | | | | |
| | 31100-94400 | | | | |
| | 31100-94401 | | | | |
| | 31100-94402 | | | | |
| | 31100-89J00 | | | | |

 DF9.9, DF15 (1996-11)
 DF25, DF30Y-K6 (2000-06)
 DF25A, DF30A (2015+)
 DT20, DT25, DT30G-Y (1986-00)
 DT25, DT30 (1998-00)
 DT40C-WG-X (1986-99)



| REF | OEM | ⚡ | ☀️ | 2T STROKES | 4T STROKES |
|------------|-------------|-----|--------|---------------|---------------|
| PH130-0060 | 31100-95600 | 12V | 0.9 kW | 8 | ✓ |
| | 31100-95601 | | | | |
| | 31100-95310 | | | | |
| | 31100-95312 | | | | |
| | 31100-95313 | | | | |
| | 31100-95521 | | | | |

 DT75-DT85Y-J (1988-00)



| REF | OEM | ⚡ | ☀️ | 2T STROKES | 4T STROKES |
|------------|-------------|-----|-------|---------------|---------------|
| PH130-0053 | 31100-94600 | 12V | 0.9kW | 9 CCW | ✓ |
| | 31100-94601 | | | | |
| | 31100-94610 | | | | |
| | 31100-94500 | | | | |
| | 31100-94510 | | | | |
| | 31100-94511 | | | | |

 DT115, DT140G-Y (1986-00)



| REF | OEM | ⚡ | ☀️ | 2T STROKES | 4T STROKES |
|------------|-------------|-----|-------|---------------|---------------|
| PH130-0052 | 31100-87000 | 12V | 0.9kW | 8 | ✓ |
| | 31100-87D00 | | | | |
| | 31100-87D10 | | | | |
| | 31100-92E00 | | | | |

 DT90, DT100L - Y (1990-00)
 DT150, DT200, DT225W-K3 (1998-03)
 V6H-Y (1987-00)



| REF | OEM | ⚡ | ☀️ | 2T STROKES | 4T STROKES |
|------------|-------------|-----|-----|---------------|---------------|
| PH130-0007 | 31100-95240 | 12V | 1kW | 9 CCW | ✓ |
| | 31100-95242 | | | | |
| | 31100-95243 | | | | |
| | 31100-95243 | | | | |

 DT50 (1980-83)
 DT65 (1980-82)



| REF | OEM | ⚡ | ☀️ | 2T STROKES | 4T STROKES |
|------------|-------------|-----|-------|---------------|---------------|
| PH130-0077 | 31100-95J00 | 12V | 9 CCW | ✓ | |
| | 31100-95J01 | | | | |
| | 31100-94J10 | | | | |
| | 31100-94J20 | | | | |
| | 31100-94J21 | | | | |
| | 31100-94J22 | | | | |

 DF8A, DF9.9A (AR) (2010-16)
 DF9.9, DF15 (R) (2004-11)
 DF9.9B, DF15A, DF20A (2013)
 DF15 (2012)
 DF20R (2006-2011)
 DF25, DF25R-V2 (2006-11)
 DF40, DF50X-K10 (1999-10)
 DF40A, DF50A, DF60A (2010-18)



| REF | OEM | ⚡ | ☀️ | 2T STROKES | 4T STROKES |
|------------|-------------|-----|-------|---------------|---------------|
| PH130-0075 | 31100-94702 | 12V | 1.4kW | 9 | ✓ |

 DT55, DT65X-J (1988-99)



| REF | OEM | ⚡ | ☀️ | 2T STROKES | 4T STROKES |
|------------|-------------|-----|-------|---------------|---------------|
| PH130-0071 | 31100-90J00 | 12V | 1.4kW | 9 CCW | ✓ |
| | 31100-90J01 | | | | |

 DF90, DF100, DF115K1-K11 (2001-1)
 DF100A, DF115A, DF140A (2013+)
 DF140 (2002-12)
 DF140A (2013)



| REF | OEM | ⚡ | ☀️ | 2T STROKES | 4T STROKES |
|------------|---------------------------|-----|----|---------------|---------------|
| PH130-0079 | 31100-87J00 | 12V | 8 | | ✓ |
| | 31100-87J10 | | | | |
| | 31100-87J11 | | | | |
| | 31100-87500 | | | | |
| | DF40, DF50X-K10 (1999-10) | | | | |
| | DF60, DF70W-K9 (1998-09) | | | | |

| REF | OEM | ⚡ | ☀️ | 2T STROKES | 4T STROKES |
|----------------|-------------------------------------|---------------|---------|---------------|---------------|
| REC31100-98L10 | 31100-98L10 | 12V 1.4 kw | 9 CW | | ✓ |
| | DF70A, DF80A, DF90A, DF100B (2018+) | | | | |
| | DF325A, DF350A (2018+) | | | | |
| | DF300B (2020+) | | | | |
| | DF250A0, DF300AP (2018+) | | | | |
| | DF200AT/AZ (2018) | | | | |
| | DF200, DF225, DF250 (2019+) | | | | |
| | DF150, DF175, DF200AP(AT) (2018+) | | | | |

| REF | OEM | ⚡ | ☀️ | 2T STROKES | 4T STROKES |
|-------------------------------------|-----------------------------------|-----|----|---------------|---------------|
| PH130-0078 | 31100-96J01 | 12V | 9 | | ✓ |
| | 31100-96J00 | | | | |
| | 31100-93J00 | | | | |
| | 31100-98L00 | | | | |
| | 31100-98L10 | | | | |
| | DF70A, DF80A, DF90A (2009+) | | | | |
| | DF70A, DF80A, DF90A -100B (2018+) | | | | |
| | DF150AP, DF175AP, DF200AP (2018+) | | | | |
| | DF150AT, DF175AT, DF200AT (2019) | | | | |
| | DF150T/Z, DF175T/Z (2018) | | | | |
| DF150G/T/Z (2006+) | | | | | |
| DF175G/T/Z (2006+) | | | | | |
| DF200, DF225, DF250 (2004-12, 2019) | | | | | |
| DF200AT/AZ (2018) | | | | | |
| DF250AP, DF300AP (2018+) | | | | | |
| DF300T/Z (2007-2011) | | | | | |
| DF300AP (2012) | | | | | |
| DF350, DF325A (2018+) | | | | | |

| SOLENOIDE PARA MOTOR DE ARRANQUE | | SOLENOID FOR STARTERS | | SOLENOIDE PER MOTORINI AVVIAMENTO | | SOLENOIDE POUR DEMARREUR | |
|----------------------------------|--|-----------------------|----|-----------------------------------|---------------|--------------------------|--|
| REF | OEM | ⚡ | ☀️ | 2T STROKES | 4T STROKES | | |
| REC89-825096T01 | 38410-94552 38410-89J00 38410-94550 38410-94551 31800-94400 31800-94401 | | | | | | |
| | DT40C-W G-X (1986-99) | | | | | | |
| | DT55, DT65 J-X (1988-99) | | | | | | |
| | DT75, DT85 J-Y (1988-00) | | | | | | |
| | DF25, DF30 Y-K6 (200-06) | | | | | | |
| | DT90, DT100L-Y (1990-00) | | | | | | |
| | V6 H-Y (1987-00) | | | | | | |
| | DT115, DT140G-Y (1986-00) | | | | | | |
| | DT150, DT200, DT225W-K3 (1998-03) | | | | | | |
| | DF40, DF50 X-K10 (1999-10) | | | | | | |
| | DF115WT, DF140WT K3 (2003) | | | | | | |
| | DF90, DF100, DF115 (2001-11) | | | | | | |
| | DF60, DF70 W-K9 (1998-09) | | | | | | |
| | DF140 (2002-11) | | | | | | |

| LLAVES DE ARRANQUE | | IGNITION STARTER SWITCH | | CHIAVI DI ACCENSIONE | | CONTACTEUR A CLÉ | |
|--------------------|---------------|-------------------------|---------------|----------------------|----------------------------|------------------|--|
| REF | OEM | 2T STROKES | 4T STROKES | REF | OEM | | |
| REC37110-99E00 | 37110-99E00 | ✓ | ✓ | REC37110-93J11 | 37110-93J11 37110-93J10 | | |
| | DF9.9 - DF250 | | | | | | |

| REGULADORES Y RECTIFICADORES | | REGULATOR AND RECTIFIERS | | REGOLATORI E RADDRIZZATORI | | REGULATEURS ET RECTIFIEURS | |
|------------------------------|---|--------------------------|--|----------------------------|----------------------------|----------------------------|--|
| REF | OEM | | | REF | OEM | | |
| REC32800-95D01 | 32800-95D01 32800-95D00 32800-95720 | | | REC32800-94620 | 32800-94620 92800-94610 | | |
| | DF9.9 / DF15 (1996-11) | | | | | | |
| | DT4-DT140 (1986-04) | | | | | | |
| | V6 H-Y (1987-00) | | | | | | |
| | DT115, DT140 | | | | | | |

| REF | OEM |
|----------------|----------------------------|
| REC32800-94J11 | 32800-94J11 32800-94J10 |

DF9.9B, DF15A, DF20A



new

| REF | OEM |
|----------------|-------------|
| REC32800-38F10 | 32800-38F10 |

DF40, DF50X-K10



new

| REF | OEM |
|----------------|-------------|
| REC32800-99J00 | 32800-99J00 |

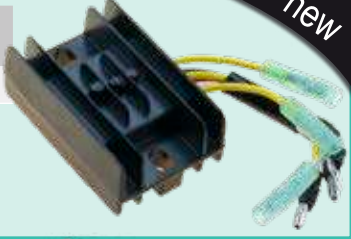

new

| REF | OEM |
|----------------|-------------|
| REC32800-88L00 | 32800-88L00 |

DF40A, DF50A, DF60A



new

| REF | OEM |
|----------------|----------------------------|
| REC32800-89L01 | 32800-89L01 32800-89L00 |

DF9.9B, DF15A, DF20A



new

| REF | OEM |
|----------------|-------------|
| REC32800-87L00 | 32800-87L00 |

DF70A, DF80A, DF90A, DF100B



new

| REF | OEM |
|----------------|-------------|
| REC32800-89J00 | 32800-89J00 |

DF25, DF30 Y-K6



new

| REF | OEM |
|----------------|-------------|
| REC32800-87J10 | 32800-87J10 |

DF40, DF50X-K10



new

| REF | OEM |
|----------------|----------------------------|
| REC32800-89J11 | 32800-89J10 32800-89J11 |

DF25, DF30 Y-K6



new

| REF | OEM |
|----------------|-------------|
| REC32800-92E20 | 32800-92E20 |

DT150, DT200, DT225 W-K3



new

| REF | OEM |
|----------------|---|
| REC32800-93J03 | 32800-93J03 32800-93J02 32800-93J01 |

DF200, DF225, DF250



new

| REF | OEM |
|----------------|-------------|
| REC32800-98J01 | 32800-98J01 |

DF250AP, DF300AP (2012+)
DF300T/Z (2007-11)



new

| GUÍA REGULADORES Y RECTIFICADORES | | | REGULATORS AND RECTIFIERS GUIDE | | | GUIDA REGOLATORE E RETTIFICATORE | | | GUIDE REGULATEURS ET RECTIFIEURS | | |
|-----------------------------------|---------|----------------------|---------------------------------|---------|-------------------------|----------------------------------|---------|----------------------|----------------------------------|---------|----------------------|
| REF | Year | Part | REF | Year | Part | REF | Year | Part | REF | Year | Part |
| REC32800-94J11 | 2013 + | DF9.9B, DF15A, DF20A | REC32800-87J10 | 1999-10 | DF40, DF50X-K10 | REC32800-98J01 | 2007-11 | DF300T/Z | REC32800-98J01 | 2007-11 | DF300T/Z |
| REC32800-89L01 | 2013 + | DF9.9B, DF15A, DF20A | REC32800-88L00 | 2010-17 | DF40A, 50A, 60A | REC32800-95D01 | 1998-01 | DT4, DT5 | REC32800-95D01 | 1998-01 | DT4, DT5 |
| REC32800-89J00 | 2000-06 | DF25, DF30 Y-K6 | REC32800-92E20 | 1998-09 | DF60, DF70 W-K9 | REC32800-95D01 | 1986-02 | DT15, 20, 25, 30, 40 | REC32800-95D01 | 1986-02 | DT15, 20, 25, 30, 40 |
| REC32800-89J11 | 2000-06 | DF25, DF30 Y-K6 | REC32800-87L00 | 2009 + | DF70A, 80A, 90A, DF100B | REC32800-95D01 | 1986-00 | DT115, DT140 | REC32800-95D01 | 1986-00 | DT115, DT140 |
| REC32800-88L00 | 2015-17 | DF25A, 30A | REC32800-93J03 | 2004 + | DF200, 225, 250 | REC32800-94620 | 1986-00 | DT150, 200, 225 W-K3 | REC32800-94620 | 1986-00 | DT150, 200, 225 W-K3 |
| REC32800-38F10 | 1999-10 | DF40, DF50X-K10 | REC32800-98J01 | 2012+ | DF250AP, 300AP | REC32800-92E20 | 1998-03 | | REC32800-92E20 | 1998-03 | |

RELÉ

RELAY

RELE

RELAIS

RELÉ ECM

ECM RELAY

RELE ECM

RELAIS ECM

| REF | OEM | 4T STROKES |
|----------------|-------------|------------|
| REC38860-76F01 | 38860-76F01 | 12V ✓ |

DF8 --> DF350



new

CDI Y CAJAS NEGRAS

CDI & POWER PACK

CDI E CENTRALINA

CDI ET BOITIER ELECTRONIQUE



| REF | OEM |
|----------------|-------------|
| REC32900-93910 | 32900-93911 |

DT9.9K, DT15K-G-Y (1986-00)

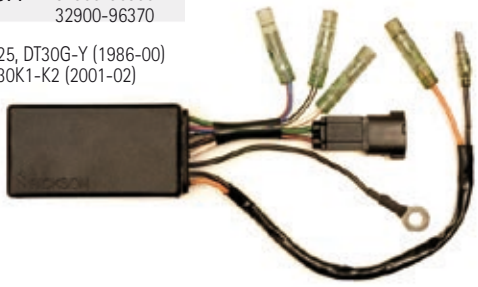

| REF | OEM |
|----------------|---|
| REC32900-96371 | 32900-96371 32900-96350 32900-96370 |

DT20, DT25, DT30G-Y (1986-00)
DT25, DT30K1-K2 (2001-02)

P 32

| REF | OEM |
|----------------|----------------------------|
| REC32900-94460 | 32900-94460 32900-94470 |

DT40C-W-G-X (1986-99)
DT40WK1-K4 (2001-04)



DESCONECTORES DE SEGURIDAD

CUT OFF SWITCHES

CHIAVETTA DI SICUREZZA

COUPE CIRCUIT DE SECURITE

| REF | OEM |
|----------------|----------------------------|
| REC37800-93954 | 37800-93954 37800-93953 |

DT2, DT2.2G-Y (1986-00)
DT20, DT25, DT30G-Y (1986-00)
DT25, DT30K1-K2 (2001-02)
DT40G-X-W-C (1986-99)
DT9.9, DT15K1-K5 (2001-04)
DT9.9K, DT15K-G-Y (1986-00)



| REF | OEM |
|----------------|-------------|
| REC37820-92E03 | 37820-92E00 |

DT4, DT140HP
DF9.9, DF140 HP
V6H-Y



| REF | OEM |
|----------------|----------------------------|
| REC37830-89E03 | 37830-95000 37830-89E02 |

DT15C (1989-97)
DT9.9, DT15K1-K4 (1986-00)
DT4, J4, DT5Y (1988-97)
DT5Y (1998-02)
DT5, DT6, DT8Y-G (1986-00)
DT6, DT8Y-K2 (2000-02)
DT8, DT9.9C-J-V (1988-97)
DT9.9K, DT15K-G-Y (1986-00)
DT75, DT85Y-J (1988-00)



| REF | OEM | 2T STROKES | 4T STROKES |
|----------------|-------------------------|------------|------------|
| REC37830-95D04 | 37830-95D00/01/02/03/04 | ✓ | ✓ |

4-->30HP





new

| KITS | KITS | KIT | KITS | | | | | | | | | | | | |
|---|---|--|--|----------|----------|--|-----|---|---------|--------------------------|--|---------|---------|---|--|
| Interruptor de encendido para todo tipo de motores fueraborda o intraborda | Emergency and stop switch for inboard or outboards. | Interruttore di accensione per tutti i tipi di motori fuoribordo o entrobordo. | Coupe circuit de sécurité pour moteur inboard ou hors-bord | | | | | | | | | | | | |
| <table border="1"> <tr> <th>REF KIT</th> <th>CUERDA WIRE CORDA CORDON</th> <th></th> </tr> <tr> <td>REC40970</td> <td>REC40990</td> <td>1</td> </tr> </table>  | REF KIT | CUERDA WIRE CORDA CORDON | | REC40970 | REC40990 | 1 | | <table border="1"> <tr> <th>REF KIT</th> <th>CUERDA WIRE CORDA CORDON</th> <th></th> </tr> <tr> <td>GS11290</td> <td>GS11291</td> <td>1</td> </tr> </table>  | REF KIT | CUERDA WIRE CORDA CORDON | | GS11290 | GS11291 | 1 | |
| REF KIT | CUERDA WIRE CORDA CORDON | | | | | | | | | | | | | | |
| REC40970 | REC40990 | 1 | | | | | | | | | | | | | |
| REF KIT | CUERDA WIRE CORDA CORDON | | | | | | | | | | | | | | |
| GS11290 | GS11291 | 1 | | | | | | | | | | | | | |
| <table border="1"> <tr> <th>REF KIT</th> <th></th> </tr> <tr> <td>GS11292</td> <td>1</td> </tr> </table>  | REF KIT | | GS11292 | 1 | | <table border="1"> <tr> <th>REF</th> <th></th> </tr> <tr> <td>GS11294</td> <td>1</td> </tr> </table>  | REF | | GS11294 | 1 | | | | | |
| REF KIT | | | | | | | | | | | | | | | |
| GS11292 | 1 | | | | | | | | | | | | | | |
| REF | | | | | | | | | | | | | | | |
| GS11294 | 1 | | | | | | | | | | | | | | |

TRIM, TILT & POWER TRIM

| INSTALACIÓN ELÉCTRICA | WIRING HARNESS | INSTALLAZIONE ELETTRICA | INSTALLATION ELECTRIQUE | | |
|--|--|--|---|--|--|
| KIT CONVERSIÓN Sustituye de 2 a 3 cables. | CONVERSION KIT Converts 3-wire Tilt and Trim motors to 2-Wire design | KIT CONVERSIONE Sustituisce da 2 a 3 cavi. | KIT DE CONVERSION. Passe un faisceau de 2 à 3 fils. | | |
| <table border="1"> <tr> <th>REF</th> </tr> <tr> <td>PH200-WH01</td> </tr> </table>  | REF | PH200-WH01 | | | |
| REF | | | | | |
| PH200-WH01 | | | | | |

| TRIM COMPLETO | COMPLETE TRIM ASSEMBLY | MOTORINO TRIM COMPLETO | MOTEUR DE TRIM | | | | | | | | | | | | | | |
|--|--|---|---|---|------------|------------|------------|------------|------------------------------------|--|--|---|---|--|--|--|------------|
| Motor de Trim para modelos antiguos. Motor de 3 cables, para 2 cables instalar PH200-WH01. | Trim for old models. Trim with 3 wires, for convert to 3 wires, it needs PH200-WH01. | Trim per modelli vecchio. Trim con 3 cavi, per 2 cavi installare PH200-WH01 | Pompe de Trim ancien modèle, avec faisceau 3 fils, pour les faisceaux à 2 fils il faut installer le kit PH200-WH01. | | | | | | | | | | | | | | |
| <table border="1"> <tr> <th>REF</th> <th>OEM</th> <th>⚡</th> <th>⚡</th> <th>⚡</th> <th>2T STROKES</th> <th>4T STROKES</th> </tr> <tr> <td>PH200-T027</td> <td>48500-95550-0ED 48500-95680-0ED</td> <td></td> <td></td> <td>⚡</td> <td>✓</td> <td></td> </tr> </table>  | REF | OEM | ⚡ | ⚡ | ⚡ | 2T STROKES | 4T STROKES | PH200-T027 | 48500-95550-0ED 48500-95680-0ED | | | ⚡ | ✓ | | | | new |
| REF | OEM | ⚡ | ⚡ | ⚡ | 2T STROKES | 4T STROKES | | | | | | | | | | | |
| PH200-T027 | 48500-95550-0ED 48500-95680-0ED | | | ⚡ | ✓ | | | | | | | | | | | | |

| REF | OEM | ⚡ | ⚡ | ⚡ | 2T STROKES | 4T STROKES |
|--------------------|---|-----|---|---|------------|------------|
| REC38100-87E10-0ED | 38100-87D00 38100-87D0IT 38100-87D02H 38100-87E10-0ED 38100-87D01-0ED 38100-87D01-02M | 12V | 3 | 3 | ✓ | |
| | DT90, DT100L-Y (1990-00) | | | | | |
| |  | | | | | |
| REF | OEM | ⚡ | ⚡ | ⚡ | 2T STROKES | 4T STROKES |
| REC38100-96J00 | 38100-92J02 38100-92J10 38100-92J01 38100-93J02 38100-96J00 38100-96J01 38100-92J12 | 12V | 4 | 2 | | ✓ |
| | DF90, DF100, DF115K1-K11 (2001-11) DF200, DF225, DF250 (2004-11) DF300T/Z (2007-2011) DF150T/Z (2006-12) | | | | | |
| |  | | | | | |

| REF | OEM | ⚡ | 🔩 | 🔗 | 2T STROKES | 4T STROKES |
|----------------|---------------------------------|-----|---|---|------------|------------|
| REC38100-87J00 | 37100-87J00-OEP 38100-87JOEP | 12V | 4 | 2 | | ✓ |

DF40, DF50X-K10 (1999-10)
TMY99-00



| REF | OEM | ⚡ | 🔩 | 🔗 | 2T STROKES | 4T STROKES |
|------------|---|-----|---|---|------------|------------|
| PH200-T024 | 38100-87D10-0ED 38100-87D10-35J 38100-87D10-0IT 38100-92E00-0ED 38100-87E20-0ED | 12V | 3 | 2 | | ✓ |

DT150, DT200, DT225W-K3 (1998-03)
V6H-Y (1987-00)



| REF | OEM | ⚡ | 🔩 | 🔗 | 2T STROKES | 4T STROKES |
|------------|----------------------------|-----|---|---|------------|------------|
| PH200-T046 | 38100-87J11 38100-87J20 | 12V | 4 | 2 | | ✓ |

DF40, DF50X-K10 (1999-10)



| REF | OEM | ⚡ | 🔩 | 🔗 | 2T STROKES | 4T STROKES |
|------------------|---|-----|---|---|------------|------------|
| REC36120-ZW4-H12 | 38100-88L12 38100-88L11 38100-88L00 | 12V | 4 | | | ✓ |

DF40A, DF50A, DF60A (2010+)



| REF | OEM | ⚡ | 🔩 | 🔗 | 2T STROKES | 4T STROKES |
|------------------|--|-----|---|---|------------|------------|
| REC36120-ZY9-003 | 38100-87L03 38100-87L02 38100-87L01 38100-87L00 | 12V | 4 | | | ✓ |

DF70A, DF80A, DF90A (2009-16)



| REF | OEM | ⚡ | 🔩 | 🔗 | 2T STROKES | 4T STROKES |
|------------------|--|-----|---|---|------------|------------|
| REC36120-ZY6-013 | 38100-90J40 38100-90J30 38100-93J13 38100-93J11 | 12V | 4 | | | ✓ |

DF60, DF70 W-K9 (1998-09)



| REF | OEM | ⚡ | 🔩 | 🔗 | 2T STROKES | 4T STROKES |
|--------------------|--|-----|---|---|------------|------------|
| REC38100-99E01-0EP | 38100-99E01-0EP 38100-99E01-00 38100-99E01-0ED | 12V | 2 | 2 | ✓ | ✓ |

DF60, DF70W-K9 (1998-09)
DT55, DT65J-X (1988-99)
DT75, DT85J-Y (1988-00)



| REF | OEM | ⚡ | 🔩 | 🔗 | 2T STROKES | 4T STROKES |
|--------------------|-----------------|-----|---|---|------------|------------|
| REC38100-97E00-0ED | 38100-97E00-0ED | 12V | 4 | 2 | | ✓ |

DT40C-W G-X (1986-99)



POWER TRIM COMPLETO COMPLETE POWER TRIM ASSEMBLY

| REF | OEM | 2T STROKES | 4T STROKES |
|------------|-----------------|------------|------------|
| REC18-6865 | 48600-94511-0ED | ✓ | ✓ |

3 RAM
115-225HP
SHOWA SYSTEM





MOTORINO POWER TRIM COMPLETO POWER TRIM COMPLET



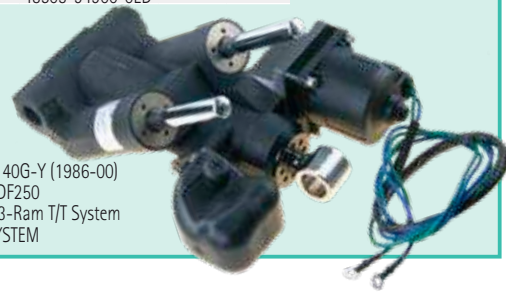



| REF | OEM | 2T STROKES | 4T STROKES |
|----------------|---|------------|------------|
| REC48503-93J12 | 48503-93J10 48503-93J12 48503-94900-0ED | ✓ | ✓ |



DT115, DT140G-Y (1986-00)
DF90 --> DF250
Complete 3-Ram T/T System
SHOWA SYSTEM



| RELÉ DE TRIM | TRIM RELAY | RELE TRIM | RELAIS DE TRIM |
|----------------|----------------------|---|--------------------------|
| REF | OEM |  | 2T 4T STROKES STROKES |
| REC38410-93J12 | 38410-93J12/11/10/00 | 40- 300 HP | ✓ |

| SENSORES DE TRIM | TRIM SENSORS | SENSORI TRIM | EMETTEUR DE TRIM |
|---|--|---|--|
| REF | OEM | REF | OEM |
| REC34801-93J03 | 34801-93J03 34801-93J02 34801-93J01 34801-93J00 | REC34801-94710 | 34801-94710 34801-94700 |
|  | DF200, DF225, DF250 (2004+) |  | DF25, DF30 Y-K6 (2000-06) DF40, DF50 X-K10 (1999-10) DF60, DF70 W-K9 (1998-09) DT55, DT65 J-X (1988-99) DT75, DT85 J-Y (1988-00) |

| TAPONES DE TRIM | TRIM CAP | TAPPO TRIM | BOUCHON VERIN DE TRIM |
|---|--|---|---|
| REF | OEM | REF | OEM |
| REC48630-96J03 | 48630-96J03 48630-96J02 48630-96J01 | REC48630-94900 | 48630-94900 |
|  | DF100A, DF115A, DF140A (2013-16) DF140 (2000-12) (14002F/14002Z) DF150T/Z, DF175T/Z (G) (2006-16) DF150T (881864+) DF150AP, DF175AP, DF200AP (2017+) DF200, DF225, DF250 (2004-16) DF200A/AP (2015-16) |  | DF60, DF70W-K9 (1998-09) DT115, DT140 G-Y (1986-00) |
| REF | OEM | REF | OEM |
| REC48630-92J00 | 48630-92J00 | REC48630-96J00 | 48630-96J00 |
|  | DF140WT, DF140WT (2003) DF140 (2002-11) DF115WT, SF115WT K3 (2003) |  | DF150, DF175 T/Z (2006-11) |
| REF | OEM | REF | OEM |
| REC48630-93J00 | 48630-93J00 | REC48630-98L01 | 48630-98L01 48630-98L00 |
|  | DF200, DF225, DF250 (2004-11) |  | DF250AP, DF300AP (2012-18) (25003P/30002P) DF200, DF225, DF250 (2004+) DF300T/Z (2007-11) DF350A, DF325A (2018+) DF300B (2020) |

| EXTRACTOR TAPONES TRIM | TRIM PLUGS EXTRACTOR | ESTRATTORE PER TAPPI DI TRIM | KIT EXTRACTEUR DE BOUCHONS TRIM |
|------------------------|---|------------------------------|---|
| REF | RECTOOLTRIMKIT | TRIM PISTON | TILT PISTON |
| | RECTOOLTRIM1 + RECTOOLTRIM2 + RECTOOLTRIM 3 | RECTOOLTRIM2 | RECTOOLTRIM3 |
| |  | |  |
| REF | RECTOOLTRIM1 | RECTOOLTRIM2 | RECTOOLTRIM3 |
| | 1/2" + RECPIN4 + RECPIN4.5 | 3 PIN x 4 mm | 3 PIN x 4.5 mm |
| | 38 mm | RECTOOLTRIM3 | 3 PIN x 6 mm |
| RECTOOLTRIM2 | 1/2" + RECPIN4 + RECPIN4.5 | | |
| | 32 mm | | |
| RECTOOLTRIM3 | 1/2" + RECPIN6 | | |
| | 35 mm | | |

Los pines de repuesto no tienen garantía.
Replacement pins are not guaranteed.
I perni di ricambio non sono garantiti.
Les pines de remplacement ne sont pas garanties

SISTEMA DE GOBIERNO STEERING SYSTEM

SISTEMA DI GUIDA SYSTÈME DE COMMANDE

MANDOS DE CONTROL

ENGINE CONTROLS

COMANDI DI CONTROLLO

BOITIER DE COMMANDE

MANDO LATERAL

SIDE CONTROL

COMANDO LATERALE

BOITIER LATERAL

| REF | OEM | POWER TRIM |
|----------------|-------------|------------|
| REC67200-94J20 | 67200-94J20 | |
| | 67200-91J00 | |
| | 67200-91J01 | |
| | 67200-91J04 | |

- DF8A, DF9.9A (2010+)
- DF9.9, DF15 (2005-10)
- DF25, DF30 (2005-08)
- DF25A, DF30A (2014+)
- DF25V-TWIN (2006+)

| REF | RO OEM | POWER TRIM |
|----------------|-----------------|------------|
| REC67200-99E56 | 67200-99E56 | |
| | 67200-99E10-OEP | |
| | 67200-99E30-OEP | ✓ |
| | 67200-99E50 | |
| | 67200-99E51 | |

- DF25, DF30 (W+W/O PT) (2000-04)
- DF40, DF50 (1999-04)
- DF60, DF70 (1998-04)

| REF | RO OEM | POWER TRIM |
|----------------|-------------|------------|
| REC67200-93J51 | 67200-93J51 | |
| | 67200-93J50 | |
| | 67200-93J06 | |
| | 67200-93J04 | |
| | 67200-93J03 | ✓ |
| | 67200-93J02 | |
| | 67200-93J01 | |
| | 67200-93J00 | |

- DF25A, DF30A (2014+)
- DF40, DF50 (2005-10)
- DF40A, DF50A, DF50AV, DF60A, DF60AV (2010+)
- DF60Q, DF70 (2005-10)
- DF70A, DF90A (2010+)
- DF90, DF115, DF140 (2005+)
- DF150, DF175, DF200A (2006+)
- DF200, DF225, DF250 (2005+)



RECmar®

new

REC67200-94J20

REC67200-99E56
REC67200-93J51

INTERRUPTOR DE TRIM MANDOS LATERALES

TRIM SWITCH SIDE CONTROLS

INTERRUTTORE TRIM COMANDO LATERALE

INTERRUPTEUR TRIM BOITIER LATERAL

| REF | OEM |
|----------------|-------------------------------|
| REC37850-90J06 | 37850-90J00,01,02,03,04,05,06 |

- DF25 -->DF250



new

MANDO PARA CONSOLA

CONSOLE CONTROL

COMANDO PER
CONSOLLA

BOITIER POUR CONSOLE

SUZUKI (BINACLE)

| REF | RO OEM | POWER TRIM |
|----------------|---|---------------|
| REC67200-88L00 | 67200-88L00 67200-93J12 67200-93J13 | ✓ |

RECMAR



| REF | RO OEM | POWER TRIM |
|----------------|----------------------------|---------------|
| REC67200-88L10 | 67200-88L10 67200-93J15 | ✓ |



new

INTERRUPTOR DE TRIM
MANDOS CONSOLA SIMPLE

TRIM SWITCH
SINGLE CONTROLS

INTERRUTTORE TRIM
PANNELLO SINGOLO

INTERRUPTEUR TRIM
CONSOLE SIMPLE

| REF | OEM |
|----------------|-------------|
| REC37850-93J10 | 37850-93J10 |

DF8 -->DF250



new

INTERRUPTOR DE TRIM
MANDOS CONSOLA DUAL

TRIM SWITCH
DUAL CONTROLS

INTERRUTTORE TRIM
PANNELLO DOPPIO

INTERRUPTEUR TRIM
CONSOLE DOUBLE

| REF | OEM |
|----------------|-------------|
| REC37220-92E00 | 37220-92E00 |

DF40 -->DF250

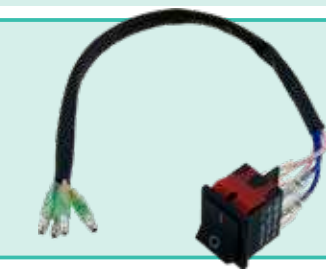

new

INTERRUPTORES
PARA MANDOS

SWITCHES FOR
ENGINE CONTROLS

INTERRUTTORI PER
CONTROLLO

INTERRUPTEUR DE
CONTRÔLE

INTERRUPTOR PANEL

SWITCH

INTERRUTTORE PANNELLO

TABLEAU DE DEMARRAGE

| REF | OEM | DF |
|----------------|-------------|----|
| REC37100-96J25 | 37100-96J20 | 1 |
| | 37100-96J21 | |
| | 37100-96J22 | |
| | 37100-96J23 | |
| | 37100-96J24 | |
| REC37100-96J15 | 37100-96J25 | 2 |
| | 37100-96J14 | |
| | 37100-96J15 | |



new

SUZUKI

RECAMBIOS
MARINOS

ARNÉS

ARNES

CAVI

FAISCEAU ELECTRIQUE

EXTENSIÓN DE ARNÉS SISTEMAS ANALÓGICOS

ARNES EXTENSION ANALOGIC SYSTEM

ESTENSIONE SISTEMA ANALOGICO

RALLONGE FAISCEAU SYSTEME ANALOGIQUE

| REF | OEM |  | POWER TRIM |
|----------------|-------------|---|------------|
| REC36620-93J02 | 36620-93J02 | 5 m | ✓ |
| REC36620-94J01 | 36620-94J01 | 5 m | |



REC36620-93J02



REC36620-94J01

COMPONENTES

COMPONENTS

COMPONENTI

COMPOSANT

CONECTORES DE CABLES

CABLE CONNECTOR

CAVO CONNETTORE

EMBOUT DE CABLE

| REF | OEM |
|-----------------|-------------|
| PAF25-07000007W | 67275-95600 |



CLIP

CLIP

CLIP

CLIP

| REF | OEM |
|-------------|-------------|
| PAGB/T896-6 | 57292-94300 |



PLACA CERRADURA SELECTOR

BLOCK CONTROL HANDLE

PLACCA SERRATURA SELETORE

CALE POIGNEE DE CONTROLÉ

| REF | OEM |
|-----------------|-------------|
| PAF15-13010010W | 67256-95600 |



CASQUILLO BASCULANTE

BUSH, SWIVEL

TAPPO GIREVOLE









BAGUE

| REF | OEM |
|----------------|----------------------------|
| REC43211-87JLO | 43211-87JLO 43211-94401 |

 DF8 (2010+)
 DF9.9 (2004+)
 DF15 (2004+)
 DF20 (2011+)





| REF | OEM |
|----------------|-------------|
| REC43211-94401 | 43211-94401 |

 DF15 (1989-97)
 DT35 (1986-89)
 DT40 (1986-98)
 DF9.9 (2006-10)
 DF15 (2004-10)
 DF25 (2000-07)
 DF30 (2000-07)
 DF40 (1999-10)
 DF50 (1999-10)



| REF | OEM |
|----------------|----------------------------|
| REC43711-97E11 | 43711-97E00 43711-97E11 |

 DT40 --> DT225 HP
 DF40 --> DF300 HP





CABLE DE ACELERADOR

THROTTLE CABLE

CAVO ACCELERATORE

CÂBLE D'ACCELERATEUR

| REF | OEM |  |  |
|--------------------|-----------------|---|---|
| REC63610-89E01 | 63610-89E01-000 | | DT15C (1989-97) |
| REC63610-93501 | 63610-93501-000 | | DT9.9 - 16 (1982-92) |
| REC63610-96302 | 63610-96302-000 | 490 mm | D20, DT25, DTG-Y (1986-00) |
| REC63610-96321-000 | 63610-96321-000 | 560 mm | DT9.9K, DT15K-G-Y (1986-00) DT9.9, DT15K1-K4 (2001-04) |
| REC63610-94402 | 63610-94402-000 | | DT40C-W-G-X (1986-99) DT40W-K1-K4 (2001-04) |
| REC63610-91J20 | 63610-91J20 | | DF4, DF5, DF6 (2002-15) new |
| | 63610-91J00 | | |
| | 63610-91J01 | | |
| | 63610-91J03 | | |
| | 63610-91J04 | | |



CABLES DE CONTROL

CONTROL CABLES

CAVI COMANDO

CÂBLES DE COMMANDE

Recorrido trabajo: 76 mm.
Rosca 10-32"

Travel 3"
Threaded 10-32"

Estensione 76 mm
Filetto 10-32"

Course: 76 mm.
Fil 10-32

maxflex



| REF | RO |  |
|------------|-----------------|---|
| PRE3300C08 | 99105-11002-008 | 8' / 2,45 m |
| PRE3300C09 | 99105-11002-009 | 9' / 2,75 m |
| PRE3300C10 | 99105-11002-010 | 10' / 3,05 m |
| PRE3300C11 | 99105-11002-011 | 11' / 3,35 m |
| PRE3300C12 | 99105-11002-012 | 12' / 3,65 m |
| PRE3300C13 | 99105-11002-013 | 13' / 3,95 m |
| PRE3300C14 | 99105-11002-014 | 14' / 4,25 m |
| PRE3300C15 | 99105-11002-015 | 15' / 4,60 m |
| PRE3300C16 | 99105-11002-016 | 16' / 4,90 m |
| PRE3300C17 | 99105-11002-017 | 17' / 5,20 m |
| PRE3300C18 | 99105-11002-018 | 18' / 5,50 m |
| PRE3300C19 | 99105-11002-019 | 19' / 5,80 m |
| PRE3300C20 | 99105-11002-020 | 20' / 6,10 m |
| PRE3300C21 | 99105-11002-021 | 21' / 6,40 m |
| PRE3300C22 | 99105-11002-022 | 22' / 6,70 m |
| PRE3300C23 | 99105-11002-023 | 23' / 7,00 m |
| PRE3300C24 | 99105-11002-024 | 24' / 7,30 m |
| PRE3300C25 | 99105-11002-025 | 25' / 7,60 m |
| PRE3300C26 | 99105-11002-026 | 26' / 7,90 m |
| PRE3300C27 | 99105-11002-027 | 27' / 8,25 m |
| PRE3300C28 | 99105-11002-028 | 28' / 8,55 m |
| PRE3300C29 | 99105-11002-029 | 29' / 8,85 m |
| PRE3300C30 | 99105-11002-030 | 30' / 9,15 m |

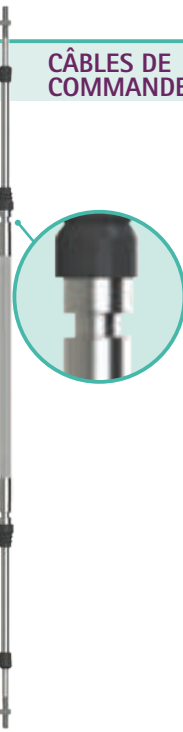
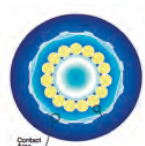

DIRECCIÓN HIDRÁULICA

HYDRAULIC STEERING

TIMONERIA IDRAULICA

DIRECTION HYDRAULIQUE

Bomba de aluminio, con válvula anti-retorno incorporada. Cilindro de aluminio y acero inoxidable, con purgadores. Se suministra completa con racors, tubo flexible de rilsan y 2L de aceite hidráulico

Helm pump made in aluminum, with non-return valve incorporated. Cylinder in aluminum and stainless steel, with breather valves. Completed with racors, rilsan tubing and 2L hydraulic oil.

Corpo pompa in alluminio, con valvola anti-retorno incorporata. Cilindro in alluminio e acciaio inox, con spurgo. Si vende completa di raccordi, tubo flessibile e 2 l di olio idraulico.

Corps de pompe en aluminium, avec clapet anti-retour intégré. Vérin en aluminium et acier inox, avec purge. Kit vendu complet avec raccords, flexible et 2L d'huile hydraulique.

| | | | | TX4200K 150 HP | TX6400K 300 HP |
|---------------------------|--------------------|-----------------------------|----------------------|--------------------------|--------------------------|
| Modelo bomba | Pump model | Modello pompa | Modèle pompe | BayStar | SeaStar |
| Capacidad bomba | helm volume | Cap. Pompa | Capacité | 23 cm ³ | 27,8 cm ³ |
| Modelo cilindro | Cylinder model | Mod. Cilindro | Mod. vérin | HC4645H | HC5345H |
| Capacidad cilindro | Cylinder volume | Cap. Cilindro | Capacité | 105 cm ³ | 139 cm ³ |
| Carrera del pistón | Cylinder travel | Corsa pistone | Course | 206 mm | 206 mm |
| Nº vueltas babor-estribor | Turns lock to lock | Nº giri a destra e sinistra | Nombre de tours | 5 | 5 |
| Manguera con racors | Hose with racors | Tubo con raccordo | Tuyaux avec raccords | 2 x 6 m | 2 x 7 m |
| Velocidad máxima | Max. speed | Velocità max | Vitesse max | 50 kn | 65 kn |



SUZUKI

RECAMBIOS MARINOS

SISTEMA DE REFRIGERACIÓN COOLING SYSTEM

SISTEMA DI RAFFREDDAMENTO SYSTÈME DE REFROIDISSEMENT

TERMOSTATO

THERMOSTAT

TERMOSTATO

THERMOSTAT

TERMOSTATO

THERMOSTAT

TERMOSTATO

THERMOSTAT

| REF | OEM | °C |
|-----------------|-------------|-----|
| REC67F-12411-01 | 17670-93J00 | 60° |

new



 DF70A, DF80A, DF90A (2009+)
 DF100B (2018+)
 DF90, DF100, DF115 (2001-11)
 DF140 (2002-12)
 DF115WT, DF140WTK-3 (2003)
 DF150T/Z, DF175T/Z (2006-11)
 DF200, DF225, DF250 (2004+)
 DF300T/Z (2007-11)

| REF | OEM | °C |
|----------------|----------------------------|-----|
| REC17670-91J01 | 17670-91J01 17670-91J00 | 50° |

new



 DF2.5 (2006)
 DF4, DF5, DF6 (2002+)
 DF9.9B, DF15A, DF20A (2013+)

| REF | OEM | °C |
|----------------|-------------|-----|
| REC17670-87J00 | 17670-87J00 | 72° |

new

 DF40, DF50X-K10 (1999-10)
 DF60, DF70W-K9 (1998-09)

| REF | OEM | °C |
|----------------|-------------|-----|
| REC17670-93962 | 17670-93962 | 50° |

new



 DF40, DF50X-K10 (1999-10)
 DF60, DF70W-K9 (1998-09)
 DT20, DT25, DT30G-Y (198600)
 DT25, DT30 K1-K2 (2001-02)
 DT40C-W G-X (1986-99)
 DT40WK1-K4 (2001-04)
 DT55, DT65J-X (1988-99)
 DT9.9, DT15K1-K4 (2001-04)
 DT9.9K, DT15K G-Y (1986-00)

| REF | OEM | °C |
|----------------|------------|-----|
| REC17670-90J10 | 1770-90J10 | 71° |

new

 DF100A, DF115A, DF140A (2013+)
 DF140 (2002-12)
 DF150, DF175 (2006+)
 DF200, DF250, DF225 (2004+)
 DF300 (2019+)
 DF70, DF80, DF90 (A) (2009+)
 DF100B (2018+)
 DF90, DF100, DF115 (2001-11)

| REF | OEM | °C |
|----------------|-------------|-----|
| REC17670-94402 | 17670-94402 | 60° |

new



 DF25, DF30Y-K6 (2000-06)
 DF640, DF50X-K10 (1999-10)
 DF60, DF70W-K9 (1998-09)
 DF9.9, DF15 (1996-11)
 DT20, DT25, DT30G-Y (1986-00)
 DT25, DT30K1-K2 (2001-02)
 DT40C-W G-X (1986-99)
 DT40W K1-K4 (2001-04)
 DT9.9, DT15 (1986-04)

| REF | OEM | °C |
|----------------|-------------|-----|
| REC17670-90J20 | 17670-90J20 | 50° |

new

 DF100, DF115, DF140 (2013+)
 DF150, DF175, DF200 (2018+)
 DF150, DF175 (2012+)
 DF200A/AP/AT (2015+)
 DF250AP, DF300AP (2012+)

| REF | OEM | °C |
|----------------|----------------------------|-----|
| REC17670-94J01 | 17670-94J01 17670-94J00 | 60° |

new

 DF8A, DF9.9A (AR) (2010+)
 DF9.9, DF15 (R) (2004-12)
 DF20R, DF25R/Q, V2 (2006-13)
 DF25A, DF30A (2015+)



TAPÓN DE AGUA

WATER FLUSH PLUG

TAPPO ACQUA

BOUCHON DE REFROIDISSEMENT

| REF | OEM |
|----------------|-------------|
| REC17913-93J00 | 17913-93J00 |

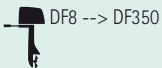

| REF | OEM |
|----------------|----------------------------|
| REC17914-93J00 | 17914-93J00 17914-93JLO |



new

IMPULSORES

IMPELLERS

GIRANTE

TURBINES

GUÍA DE IMPULSORES

IMPELLER GUIDE

GUIDA GIRANTE

GUIDE TURBINES

2T
STROKES

| | | REF | OEM | CEF | A (mm) | B (mm) | C (mm) |
|-------|-----------|----------------|-----------------------|------------|--------|--------|--------|
| DT4 | 1988-01 | REC17461-98503 | 17461-98501,2,3 | CEF500336 | 10,15 | 41 | 14 |
| DT5 | 1986-02 | REC17461-98503 | 17461-98501,2,3 | CEF500336 | 10,15 | 41 | 14 |
| DT6 | 1984-02 | REC17461-98503 | 17461-98501,2,3 | CEF500336 | 10,15 | 41 | 14 |
| DT8 | 1980-87 | REC17461-98503 | 17461-98501,2,3 | CEF500336 | 10,15 | 41 | 14 |
| DT8 | 1988-97 | REC17461-92D02 | 17461-92D02 | CEF500319 | 12,2 | 42 | 20 |
| DT9,9 | 1980-87 | REC17461-93004 | 17461-93001,3,4 | CEF500398 | 15 | 70 | 12,5 |
| DT9,9 | 1988-97 | REC17461-92D02 | 17461-92D02 | CEF500319 | 12,2 | 42 | 20 |
| DT14 | 1977-80 | REC17461-93004 | 17461-93001,3,4 | CEF500398 | 15 | 70 | 12,5 |
| DT15 | 1986-97 | REC17461-93903 | 17461-93901,2,3 | CEF500329 | 13,2 | 42 | 22 |
| DT16 | 1977-82 | REC17461-93004 | 17461-93001,2,3,4 | CEF500398 | 15 | 70 | 12,5 |
| DT20 | 1986-88 | REC17461-96312 | 17461-96301 | CEF500362G | 17,1 | 67,5 | 16,18 |
| DT25 | 1977-82 | REC17461-93004 | 17461-93001,2,3,4 | CEF500398 | 15 | 70 | 12,5 |
| DT25 | 1983-88 | REC17461-96312 | 17461-96301 | CEF500362G | 17,1 | 67,5 | 16,18 |
| DT25 | 1989-00 | | 17461-96400 | CEF500399 | 17,2 | 67 | 16,16 |
| DT28 | 1972-82 | REC17461-93004 | 17461-93002 | CEF500398 | 15 | 70 | 12,5 |
| DT30 | 1983-85 | REC17461-96312 | 17461-96301 | CEF500362G | 17,1 | 67,5 | 16,18 |
| DT30 | 1989-00 | | 17461-96400 | CEF500399 | 17,2 | 67 | 16,16 |
| DT35 | 1987-89 | REC17461-96312 | 17461-96301 | CEF500362G | 17,1 | 67,5 | 16,18 |
| DT40 | 1983 | REC17461-94700 | 17461-95201 | CEF500312 | 19,13 | 51,8 | 19 |
| DT40 | 1984-98 | REC17461-96312 | 17461-96310 | CEF500362G | 17,1 | 67,5 | 16,18 |
| DT50 | 1978-84 | REC17461-95300 | 17461-95501,95300 | CEF500360 | 20,1 | 67,5 | 19 |
| DT55 | 1985-97 | REC17461-94700 | 17461-94700,1 | CEF500361 | 17,1 | 67 | 19 |
| DT60 | 1983 | REC17461-94700 | 17461-95200 | CEF500361 | 17,1 | 67 | 19 |
| DT60 | 1984 | REC17461-96312 | 17451-96301 | CEF500362G | 17,1 | 67,5 | 16,18 |
| DT65 | 1985-97 | REC17461-94700 | 17461-94701 | CEF500361 | 17,1 | 67 | 19 |
| DT75 | 1983-97 | REC17461-95300 | 17461-95501,95300,1,2 | CEF500360 | 20,1 | 67,5 | 19 |
| DT85 | 1983-00 | REC17461-95300 | 17461-95501,95300,1,2 | CEF500360 | 20,1 | 67,5 | 19 |
| DT90 | 1988+ | REC17461-87E12 | 17461-87E12 | CEF500365 | 22,2 | 78,3 | 35,1 |
| DT100 | 1988+ | REC17461-87E12 | 17461-87E12 | CEF500365 | 22,2 | 78,3 | 35,1 |
| DT115 | 1986-01 | REC17461-90J01 | 17461-94510 | CEF500367 | 24,3 | 86 | 31,7 |
| DT140 | 1986-01 | REC17461-90J01 | 17461-94510 | CEF500367 | 24,3 | 86 | 31,7 |
| DT150 | 1987-96 | REC17461-90J01 | 17461-90J01 | CEF500367 | 24,3 | 86 | 31,7 |
| DT200 | 1998-03 | REC17461-90J01 | 17461-90J00 | CEF500367 | 24,3 | 86 | 31,7 |
| DT225 | 1998-2003 | REC17461-90J01 | 17461-90J00 | CEF500367 | 24,3 | 86 | 31,7 |

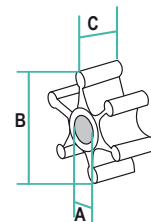

REC17461-98503



REC17461-92D02



REC17461-93004



REC17461-93903



REC17461-96312



REC17461-94700



REC17461-95300



REC17461-87E12



REC17461-90J01

SUZUKI

RECAMBIOS MARINOS

| | | REF | OEM | CEF | A (mm) | B (mm) | C (mm) |
|-------|---------|----------------|-------------------|------------|-----------|-----------|-----------|
| DF2.5 | 2003+ | REC17461-97JM0 | 17461-97110 | | | | |
| DF4 | 2003+ | REC17461-98503 | 17461-98503 | CEF500336 | 10,15 | 41 | 14 |
| DF6 | 2003+ | REC17461-98503 | 17461-98503 | CEF500336 | 10,15 | 41 | 14 |
| DF8 | 2010+ | REC17461-93903 | 17461-93903 | CEF500329 | 13,2 | 42 | 22 |
| DF9,9 | 2004+ | REC17461-93903 | 17461-93903 | CEF500329 | 13,2 | 42 | 22 |
| DF15 | 2004+ | REC17461-93903 | 17461-93903 | CEF500329 | 13,2 | 42 | 22 |
| DF25 | 1999-10 | REC17461-96312 | 17461-96312 | CEF500362G | 17,1 | 67,5 | 16,18 |
| DF25A | 2015+ | REC17461-96312 | 17461-94L00 | | | | |
| DF30 | 1999-07 | REC17461-96312 | 17461-96312 | CEF500362G | 17,1 | 67,5 | 16,18 |
| DF30A | 2015+ | REC17461-96312 | 17461-94L00 | | | | |
| DF40 | 1999+ | REC17461-96312 | 17461-96312 | CEF500362G | 17,1 | 67,5 | 16,18 |
| DF50 | 1999+ | REC17461-96312 | 17461-96312 | CEF500362G | 17,1 | 67,5 | 16,18 |
| DF60 | 1998-09 | REC17461-87E12 | 17461-87E10,11,12 | CEF500365 | 22,2 | 78,3 | 26 |
| DF70 | 1998+ | REC17461-87E12 | 17461-87E10,11,12 | CEF500365 | 22,2 | 78,3 | 26 |
| DF80 | 2010+ | REC17461-87E12 | 17461-87E10,11,12 | CEF500365 | 22,2 | 78,3 | 26 |
| DF90 | 2010+ | REC17461-87E12 | 17461-87E10,11,12 | CEF500365 | 22,2 | 78,3 | 26 |
| DF100 | 2001+ | REC17461-90J01 | 17461-90J01 | CEF500367 | 24,3 | 86 | 31,7 |
| DF115 | 2002+ | REC17461-90J01 | 17461-90J01 | CEF500367 | 24,3 | 86 | 31,7 |
| DF140 | 2002+ | REC17461-90J01 | 17461-90J01 | CEF500367 | 24,3 | 86 | 31,7 |
| DF150 | 2008+ | REC17461-90J01 | 17461-90J01 | CEF500367 | 24,3 | 86 | 31,7 |
| DF175 | 2007+ | REC17461-90J01 | 17461-90J01 | CEF500367 | 24,3 | 86 | 31,7 |
| DF200 | 2004+ | REC17461-93J00 | 17461-93J00 | CEF500393 | 24,3 | 87 | 39 |
| DF225 | 2004+ | REC17461-93J00 | 17461-93J00 | CEF500393 | 24,3 | 87 | 39 |
| DF250 | 2004+ | REC17461-93J00 | 17461-93J00 | CEF500393 | 24,3 | 87 | 39 |
| DF300 | 2007+ | REC17461-93J00 | 17461-93J00 | CEF500393 | 24,3 | 87 | 39 |

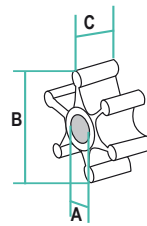

REC17461-97JM0



REC17461-98503



REC17461-96312



REC17461-87E12



REC17461-90J01



REC17461-93J00

CHAVETA

KEY

CHIAVETTA

CLAVETTE

| REF | OEM | |
|----------------|----------------------------|----------------|
| REC09420-03005 | 09420-03005 09420-03009 | REC17461-93903 |



DF15 (2012)
DF8Z, DF9.9A (AR) (2010+)
DF9.9, DF15 (R) (2004-11)
DF9.9B, DF15A, DF20A (2013+)



| REF | OEM |
|----------------|-------------|
| REC17462-93990 | 17462-93990 |



DT9.9 (1983-87)
DT15 (1983-97)
DF9.9 (2004-10)
DF15 (2004-10)



| REF | OEM | |
|----------------|-------------|----------------|
| REC09420-03002 | 09420-03002 | REC17461-98503 |



DF4, DF5, DF6 (2006+)
DT4/J4, DT5Y (1988-00)
DT4K1 (2001)
DT5, DT6, DT8G-Y (1986-00)
DT5Y (1998-02)
DT6, DT8Y-K2 (2000-02)



| REF | OEM |
|----------------|----------------------------|
| REC09420-05009 | 09420-05009 09420-05006 |



DF115WT, DF140WT K3 (2003)
DT115, DT140G-Y (1986-00)
DT150, DT200, DT225W-K3 (1989-03)
V6H-Y (1987-00)
DF100A, DF115, DF140A (2013+)
DF140 (2002-12)
DF150, DF175 (2006+)
DF200, DF225, DF250 (2004+)
DF250AP, DF300AP (2013+)
DF350, DF300 (2007)
DF90, DF100, DF115 (2001-11)



| REF | OEM | |
|----------------|-------------|----------------|
| REC09420-04006 | 09420-04006 | REC17461-96312 |



DF20R, DF25 (RVZ) (2006-11)
DF25/R/QVZ (2013)
DF25, DF30Y-K6 (2000-06)
DF40, DF50X-K10 (1999-10)
DF40A, DF50A, DF60A (2010+)
DT20, DT25, DT30G-Y (1986-00)
DT25, DT30 K1-K2 (2001-02)
DT25C, DT30C K-Y (1989-00)
DT40C-W G-X (1986-99)
DT40W K1-K4 (2001-04)



new

new

new

TAPA DEL IMPULSOR

IMPELLER PLATE

COPERCHIO GIRANTE

PLAQUE DE POMPE À EAU

| REF | OEM |
|----------------|---|
| REC17471-92J02 | 17471-93J02 17471-93J01 17471-93J00 |



DF150, DF175 (T/Z) (2006+)
DF200, DF225, DF250 (2004+)
DF150AP, DF175AP, DF200AP (2017+)
DF150AT, DF175AT, DF200AT (2019)
DF200A/AP (2015-17)
DF200AT/AZ (2018)

| REF | OEM |
|----------------|---|
| REC17471-92J00 | 17471-92J00 17471-87E00 17471-87E01 |



DT90, DT100L-Y (1990-00)
DF60, DF70W-K9 (1998-09)
DF90, DF100, DF115 (2001-11)
DF140 (2002-12)
DF100A, DF115A, DF140A (2013+)

| REF | OEM |
|----------------|----------------------------|
| REC17471-95J01 | 17471-95J01 17471-95J00 |



DF20R, DF25, DF25R/Q (V2) (2006-13)
DF40A, DF50A, DF60A (2010+)

| REF | OEM |
|----------------|----------------|
| REC17471-97J00 | 17471-97J00-00 |



DF2.5 (2006-11)

| REF | OEM |
|----------------|----------------------------|
| REC17471-98601 | 17471-98601 17471-98600 |



DT4-J4-DT5Y (1988-00)
DT4K1 (2001)
DT5Y (1998-02)

| REF | OEM |
|----------------|-------------|
| REC17471-97JL0 | 17471-97JL0 |



DT2.5 (2012+)

| REF | OEM |
|----------------|-------------|
| REC17471-94401 | 17471-94401 |

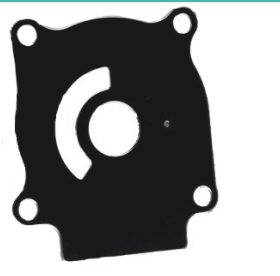

DF25, DF30Y-K6 (2000-06)
DF40, DF50X-K10 (1999-10)
DF20, DF25, DF30G-Y (1986-00)
DF25C, DT30C-K-Y (1989-00)
DT40C-W-G-X (1986-99)
DT25, DT30 K1-K2 (2001-02)
DT40W - K1-K4 (2001-04)

| REF | OEM |
|----------------|-------------|
| REC17471-93902 | 17471-93902 |



DF9.9(R)T-K3 (1996-11)
DF15(R)-K3 (1996-12)
DT15C (1989-97)
DT9.9, DT15K1-K4 (2001-04)
DT9.9K, DT15K-G-K4 (2001-04)
DT9.9K, DT15K-G-Y (1986-00)

BOMBA DE AGUA

WATER PUMP

POMPA ACQUA

POMPE À EAU

CUERPO BOMBA DE AGUA

HOUSING, WATER PUMP

CORPO, POMPA ACQUA

CORPS DE POMPE À EAU

| REF | OEM |
|----------------|----------------------------|
| REC17411-93901 | 17411-93901 17410-93910 |



DT9.9, DT15 K1-K4 (2001-04)
DT9.9K, DT15K-G-Y (1986-00)
DT15C (1989-97)
DF9.9, DF15 (R) (2004-11)
DF9.9, DF15T-K3 (1996-03)

| REF | OEM |
|----------------|--|
| REC17450-93921 | 17450-93921 17450-93920 17450-93930 17450-93440 |



DT9.9K, DT15K G-Y (1986-00)

| REF | OEM |
|----------------|----------------------------|
| REC17411-94421 | 17411-94421 17410-94431 |



DF40, DF50X-K10 (1999-10)
DT20, DT25, DT30G-Y (1986-00)
DT25, DT30 K1-K2 (2001-02)
DT40C-W-G-X (1986-99)
DT40W K1-K4 (2001-04)
DF25, FG30Y-K6 (2000-06)

TAPA DE LA BOMBA

WATER PUMP, COVER

COPERCHIO POMPA

PLAQUE DE POMPE À EAU

| REF | OEM |
|--------------------|------------------------------------|
| REC56130-94413-0EP | 56130-94413-0EP 56130-94411-0EP |

 DF40, DF50X-K10 (1999-10)
 DF40W-K1-K4 (2001-04)



| REF | OEM |
|--------------------|------------------------------------|
| REC56130-96331-0EP | 56130-96331-0EP 56130-96320-0EP |

 DT25, DT30



new

JUNTA BASE DE BOMBA

WATER PUMP, GASKET BASE

GUARNIZIONE BASE POMPA

JOINT, BASE DE POMPE À EAU

| REF | OEM |
|----------------|-------------|
| REC17472-98J00 | 17472-98J00 |

 DF250AP, DF300AP (2012+)
 DF300T/Z (2007-11)



| REF | OEM |
|----------------|-------------|
| REC17472-97JL0 | 17472-97JL0 |



 DF2.5 (2012+)



new

| REF | OEM |
|----------------|-------------|
| REC17472-97J00 | 17472-97J00 |

 DF2.5 (2006-11)



new

| REF | OEM |
|----------------|-------------|
| REC17472-87L00 | 17472-87L00 |



 DF70A, DF80A, DF90A (2009+)
 DF100B (2018+)



new

| REF | OEM |
|----------------|---|
| REC17472-96303 | 17472-96301 17472-96302 17472-96303 |



 DT20, DT25, DT30 (1986-04)
 DF25, DF30 (2000-06)
 DF20R, DF25R (VZ) (2006-13)
 DF40, DF50 (1999-10)
 DF40A, DF50A, DF60A (2010+)



new

| REF | OEM |
|----------------|----------------------------|
| REC17472-87E10 | 17472-87E10 17472-87E00 |

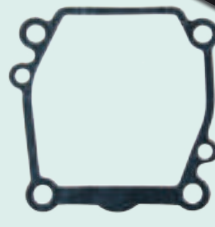
 DF100A, DF115A, DF140A (2013+)
 DF115WT, DF140WT K3 (2003)
 DF140 (2002-12)
 DF60, DF70 W-K9 (1998-09)
 DF90, DF100, DF115 (2001-11)
 DF40A, DF50A, DF60A (2014+)
 DT90, DT100L-Y (1990-00)



new

JUNTA TÓRICA BOMBA DE AGUA

WATER PUMP, O-RING

GUARNIZIONE

JOINT TORIQUE DE POMPE À EAU

| REF | OEM |
|----------------|-------------|
| REC17417-92J00 | 17417-92J00 |



 DF140 (2002-11)
 DF90, DF100, DF115 (2001-11)



new

| REF | OEM |
|----------------|-------------|
| REC17416-92J10 | 17416-92J10 |

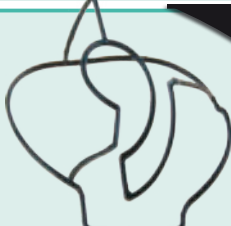

 DF100A, DF115A, DF140A (2013+)
 DF140 (2002-12)
 DF90, DF100, DF115 (2001-11)



new

| REF | OEM |
|----------------|-------------|
| REC17416-93J00 | 17416-93J00 |



 DF200, DF225, DF250 (2000+)
 DF250AP, DF300AP (2012+)
 DF300T/Z (2007-11)
 DF325A, DF350A (2018+)



new

| REF | OEM |
|----------------|-------------|
| REC17416-95J00 | 17416-95J00 |



 DF20R, DF25R (VZ) (2006-13)
 DF40A, DF50A, DF60A (2010+)



new

| REF | OEM |
|----------------|-------------|
| REC17416-96J00 | 17416-96J00 |



 DF150AP, DF175AP, DF200AP (2017+)
 DF150AT, DF175AT, DF200AT (2019)
 DF150T, DF175T (G)/Z (2006-18)
 DF200A, DF200AP (2015-17)
 DF200AT/AZ (2018)







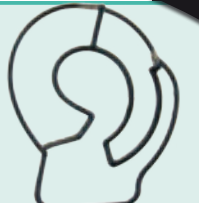





















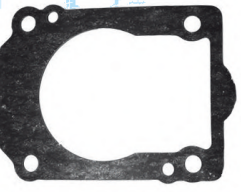

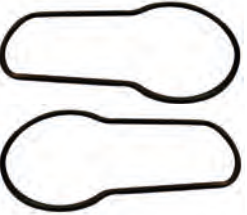





new

| REF | OEM |
|----------------|-------------|
| REC17416-99E10 | 17416-99E10 |

 DF40A, DF50A, DF60A (2014+)
 DF70A, DF80A, DF90A (2009+)
 DF100B (2018+)



new

| JUNTAS BOMBA | WATER PUMP GASKET | GUARNIZIONE POMPA | JOINTS POMPE | | | | | | | | | | |
|--|--|-------------------|----------------|-------------|---|--|--|-----|-----|----------------|-------------|---|--|
| <table border="1"> <thead> <tr> <th>REF</th> <th>OEM</th> </tr> </thead> <tbody> <tr> <td>REC17452-93910</td> <td>17452-93910</td> </tr> <tr> <td></td> <td>DF9.9, DF15T-K3 (1996-03) DT15C (1989-97) DT9.9K, DT15K-G-Y (1986-00) DT9.9, DT15 K1-K4 (2001-04)</td> </tr> </tbody> </table>  | REF | OEM | REC17452-93910 | 17452-93910 |  | DF9.9, DF15T-K3 (1996-03) DT15C (1989-97) DT9.9K, DT15K-G-Y (1986-00) DT9.9, DT15 K1-K4 (2001-04) | <table border="1"> <thead> <tr> <th>REF</th> <th>OEM</th> </tr> </thead> <tbody> <tr> <td>REC17472-92D10</td> <td>17472-92D10</td> </tr> <tr> <td></td> <td>DT8C, DT9.9C-J-V (1988-97)</td> </tr> </tbody> </table>  | REF | OEM | REC17472-92D10 | 17472-92D10 |  | DT8C, DT9.9C-J-V (1988-97) |
| REF | OEM | | | | | | | | | | | | |
| REC17452-93910 | 17452-93910 | | | | | | | | | | | | |
|  | DF9.9, DF15T-K3 (1996-03) DT15C (1989-97) DT9.9K, DT15K-G-Y (1986-00) DT9.9, DT15 K1-K4 (2001-04) | | | | | | | | | | | | |
| REF | OEM | | | | | | | | | | | | |
| REC17472-92D10 | 17472-92D10 | | | | | | | | | | | | |
|  | DT8C, DT9.9C-J-V (1988-97) | | | | | | | | | | | | |
| <table border="1"> <thead> <tr> <th>REF</th> <th>OEM</th> </tr> </thead> <tbody> <tr> <td>REC17472-91J00</td> <td>17472-91J00</td> </tr> <tr> <td></td> <td>DF4, DF5, DF6 (2002-14)</td> </tr> </tbody> </table>  | REF | OEM | REC17472-91J00 | 17472-91J00 |  | DF4, DF5, DF6 (2002-14) | <table border="1"> <thead> <tr> <th>REF</th> <th>OEM</th> </tr> </thead> <tbody> <tr> <td>REC17472-98611</td> <td>17472-98611</td> </tr> <tr> <td></td> <td>DT4 / J4, DT5Y (1988-00) DT4K1 (2001) DT5Y (1998-02)</td> </tr> </tbody> </table>  | REF | OEM | REC17472-98611 | 17472-98611 |  | DT4 / J4, DT5Y (1988-00) DT4K1 (2001) DT5Y (1998-02) |
| REF | OEM | | | | | | | | | | | | |
| REC17472-91J00 | 17472-91J00 | | | | | | | | | | | | |
|  | DF4, DF5, DF6 (2002-14) | | | | | | | | | | | | |
| REF | OEM | | | | | | | | | | | | |
| REC17472-98611 | 17472-98611 | | | | | | | | | | | | |
|  | DT4 / J4, DT5Y (1988-00) DT4K1 (2001) DT5Y (1998-02) | | | | | | | | | | | | |
| <table border="1"> <thead> <tr> <th>REF</th> <th>OEM</th> </tr> </thead> <tbody> <tr> <td>REC17472-93J00</td> <td>17472-93J00</td> </tr> <tr> <td></td> <td>DF200, DF225, DF250 (2004+) DF200A (2015) DF150, DF175T-Z (G) (2006-14)</td> </tr> </tbody> </table>  | REF | OEM | REC17472-93J00 | 17472-93J00 |  | DF200, DF225, DF250 (2004+) DF200A (2015) DF150, DF175T-Z (G) (2006-14) | <table border="1"> <thead> <tr> <th>REF</th> <th>OEM</th> </tr> </thead> <tbody> <tr> <td>REC55122-94400</td> <td>55122-88L00</td> </tr> <tr> <td></td> <td>DF40, DF50X-K10 (1999-10) DF40A, DF50A, DF60A (2010+)</td> </tr> </tbody> </table>  | REF | OEM | REC55122-94400 | 55122-88L00 |  | DF40, DF50X-K10 (1999-10) DF40A, DF50A, DF60A (2010+) |
| REF | OEM | | | | | | | | | | | | |
| REC17472-93J00 | 17472-93J00 | | | | | | | | | | | | |
|  | DF200, DF225, DF250 (2004+) DF200A (2015) DF150, DF175T-Z (G) (2006-14) | | | | | | | | | | | | |
| REF | OEM | | | | | | | | | | | | |
| REC55122-94400 | 55122-88L00 | | | | | | | | | | | | |
|  | DF40, DF50X-K10 (1999-10) DF40A, DF50A, DF60A (2010+) | | | | | | | | | | | | |
| <table border="1"> <thead> <tr> <th>REF</th> <th>OEM</th> </tr> </thead> <tbody> <tr> <td>REC17472-95310</td> <td>17472-95310</td> </tr> <tr> <td></td> <td>DT55, DT65J-X (1988-99)</td> </tr> </tbody> </table>  | REF | OEM | REC17472-95310 | 17472-95310 |  | DT55, DT65J-X (1988-99) | <table border="1"> <thead> <tr> <th>REF</th> <th>OEM</th> </tr> </thead> <tbody> <tr> <td>REC17472-98503</td> <td>17472-98503</td> </tr> <tr> <td></td> <td>DT5, DF6, DT8G-Y (1986-00) DT6, DT8Y-K2 (2000-02)</td> </tr> </tbody> </table>  | REF | OEM | REC17472-98503 | 17472-98503 |  | DT5, DF6, DT8G-Y (1986-00) DT6, DT8Y-K2 (2000-02) |
| REF | OEM | | | | | | | | | | | | |
| REC17472-95310 | 17472-95310 | | | | | | | | | | | | |
|  | DT55, DT65J-X (1988-99) | | | | | | | | | | | | |
| REF | OEM | | | | | | | | | | | | |
| REC17472-98503 | 17472-98503 | | | | | | | | | | | | |
|  | DT5, DF6, DT8G-Y (1986-00) DT6, DT8Y-K2 (2000-02) | | | | | | | | | | | | |
| <table border="1"> <thead> <tr> <th>REF</th> <th>OEM</th> </tr> </thead> <tbody> <tr> <td>REC17472-93911</td> <td>17472-93911</td> </tr> <tr> <td></td> <td>DF9.9, DF15T-K3 (1996-03) DT15C (1989-97) DT9.9K, DT15K-G-Y (1986-00) DT9.9, DT15K1-K4 (2001-04)</td> </tr> </tbody> </table>  | REF | OEM | REC17472-93911 | 17472-93911 |  | DF9.9, DF15T-K3 (1996-03) DT15C (1989-97) DT9.9K, DT15K-G-Y (1986-00) DT9.9, DT15K1-K4 (2001-04) | | | | | | | |
| REF | OEM | | | | | | | | | | | | |
| REC17472-93911 | 17472-93911 | | | | | | | | | | | | |
|  | DF9.9, DF15T-K3 (1996-03) DT15C (1989-97) DT9.9K, DT15K-G-Y (1986-00) DT9.9, DT15K1-K4 (2001-04) | | | | | | | | | | | | |

| CASQUILLO INOX | INSERT CUP | GHIERA INOX | INSERT INOX | | | | | | | | | | |
|--|--|-------------|----------------|-------------|---|--|---|-----|-----|----------------|----------------------------|---|---|
| <table border="1"> <thead> <tr> <th>REF</th> <th>OEM</th> </tr> </thead> <tbody> <tr> <td>REC17413-95J00</td> <td>17413-95J00</td> </tr> <tr> <td></td> <td>DF40A, DF50A, DF60A (2010+) DF20R, DF25, RVZ (2006-11) DF20, DF25R, DF25QVZ (2013)</td> </tr> </tbody> </table>  | REF | OEM | REC17413-95J00 | 17413-95J00 |  | DF40A, DF50A, DF60A (2010+) DF20R, DF25, RVZ (2006-11) DF20, DF25R, DF25QVZ (2013) | <table border="1"> <thead> <tr> <th>REF</th> <th>OEM</th> </tr> </thead> <tbody> <tr> <td>REC17413-92J01</td> <td>17413-92J01 17413-92J00</td> </tr> <tr> <td></td> <td>DF100A, DF115A, DF140A (2013+) DF140 (2002-12) DF90, DF100, DF115 (2001-11)</td> </tr> </tbody> </table>  | REF | OEM | REC17413-92J01 | 17413-92J01 17413-92J00 |  | DF100A, DF115A, DF140A (2013+) DF140 (2002-12) DF90, DF100, DF115 (2001-11) |
| REF | OEM | | | | | | | | | | | | |
| REC17413-95J00 | 17413-95J00 | | | | | | | | | | | | |
|  | DF40A, DF50A, DF60A (2010+) DF20R, DF25, RVZ (2006-11) DF20, DF25R, DF25QVZ (2013) | | | | | | | | | | | | |
| REF | OEM | | | | | | | | | | | | |
| REC17413-92J01 | 17413-92J01 17413-92J00 | | | | | | | | | | | | |
|  | DF100A, DF115A, DF140A (2013+) DF140 (2002-12) DF90, DF100, DF115 (2001-11) | | | | | | | | | | | | |
| <table border="1"> <thead> <tr> <th>REF</th> <th>OEM</th> </tr> </thead> <tbody> <tr> <td>REC17413-99E11</td> <td>17413-99E11</td> </tr> <tr> <td></td> <td>DF40A, DF50A, DF60A (2014+) DF70A, DF80A, DF90A (2009+) DF100B (2018+)</td> </tr> </tbody> </table>  | REF | OEM | REC17413-99E11 | 17413-99E11 |  | DF40A, DF50A, DF60A (2014+) DF70A, DF80A, DF90A (2009+) DF100B (2018+) | <table border="1"> <thead> <tr> <th>REF</th> <th>OEM</th> </tr> </thead> <tbody> <tr> <td>REC17413-96J01</td> <td>17413-96J01 17413-96J00</td> </tr> <tr> <td></td> <td>DF150, DF175 (2006+) DF200A, AP (2015+)</td> </tr> </tbody> </table>  | REF | OEM | REC17413-96J01 | 17413-96J01 17413-96J00 |  | DF150, DF175 (2006+) DF200A, AP (2015+) |
| REF | OEM | | | | | | | | | | | | |
| REC17413-99E11 | 17413-99E11 | | | | | | | | | | | | |
|  | DF40A, DF50A, DF60A (2014+) DF70A, DF80A, DF90A (2009+) DF100B (2018+) | | | | | | | | | | | | |
| REF | OEM | | | | | | | | | | | | |
| REC17413-96J01 | 17413-96J01 17413-96J00 | | | | | | | | | | | | |
|  | DF150, DF175 (2006+) DF200A, AP (2015+) | | | | | | | | | | | | |

KITS DE REPARACIÓN BOMBA DE AGUA

WATER PUMP SERVICE KITS

KIT RICAMBI POMPA ACQUA

KIT POMPE À EAU

| REF | OEM |
|----------------|---|
| REC17400-95351 | 17400-95550 17400-95350 17400-95351 |

 DT75, DT85J-Y (1988-00)



| REF | OEM |
|----------------|--|
| REC17400-93J01 | 17400-93J00 17400-93J01 17400-93J02 17400-93J03 |

 DF200, DF225, DF250 (2004+)



| REF | OEM |
|----------------|----------------------------|
| REC17400-94701 | 17400-94700 17400-94701 |

 DT55, DT65J-X (1988-99)



| REF | OEM |
|----------------|---|
| REC17400-98661 | 17400-98661 17400-986L0 17400-986L1 |

 DF4, DF5, DF6 (2002-15)



| REF | OEM |
|----------------|---|
| REC17400-96403 | 17400-96350 17400-96351 17400-96352 17400-96403 17400-96353 |

 DT20, DT25, DT30G-Y (1986-00)
DT40C-W-G-X (1986-99)
DT25C, DT30C-K-Y (1989-00)
DF25, DF30 (2000-07)
DF40, DF50 (1999-10)



| REF | OEM |
|----------------|---|
| REC17400-98J01 | 17400-98J00 17400-98J01 17400-98J02 |

 DF250AP, DF300AP (2012+)
DF300T/Z (2007-11)



| REF | OEM |
|----------------|---|
| REC17400-87D11 | 17400-87D10 17400-87D11 17400-87D00 |

 V6H-Y (1987-00)
DT150, DT200, DT225W-K3 (1998-03)



| REF | OEM |
|----------------|-------------|
| REC17400-98551 | 17400-98551 |

 DT5, DT6, DT8G-Y (1986-00)
DT6, DT8Y-K2 (2000-02)



| REF | OEM |
|----------------|-------------|
| REC17400-87E04 | 17400-87E03 |

 DT90, DT100L-Y (1990-00)
DF60, DF70W-K9 (1998-09)

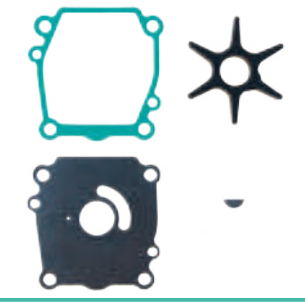

| REF | OEM |
|----------------|----------------------------|
| REC17400-98652 | 17400-98652 17400-98661 |

 DT4 /J4, DT5Y (1988-02)
DT4K1 (2001)



| REF | OEM |
|----------------|----------------------------|
| REC17400-92D01 | 17400-92D01 17400-92D11 |

 DT8C, DT9.9C-J-V (1988-97)

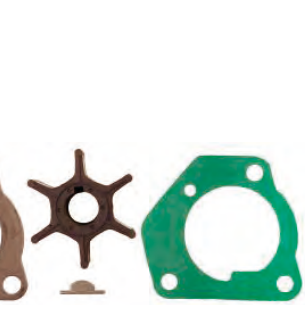

| REF | OEM |
|----------------|-------------|
| REC17400-93951 | 17400-93950 |

 DF9.9, DF15T-K3 (1996-03)
DT9.9K, DT15K-G-Y (1986-00)
DT15C (1989-97)

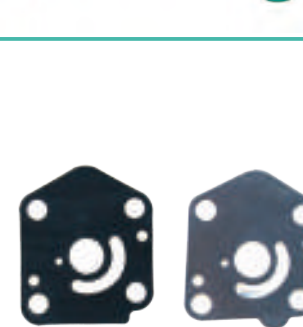

| REF | OEM |
|----------------|-------------|
| REC17400-94611 | 17400-94611 |

DT115, DT140G-Y (1986-00)

| REF | OEM |
|----------------|-------------|
| REC17400-94L00 | 17400-94L00 |

DF25A, DF30A (2014+)

| REF | OEM |
|----------------|-------------|
| REC17400-90J20 | 17400-90J11 |

DF90, DF100, DF115K1-K11 (2001-11)
DF140 (2002-11)

| REF | OEM |
|----------------|-------------|
| REC17400-92J21 | 17400-92J21 |

DF100A, DF115, DF115A
DF140A, DF150AP, DF175AP (2009+)

| REF | OEM |
|----------------|----------------------------|
| REC17400-99J01 | 17400-99J00 17400-99J01 |

DF9.9A/AR/B (2010+)
DF8A/AR
DF15A
DF20A

| REF | OEM |
|----------------|--------------|
| REC17400-92J00 | 17400-92J200 |

DF90, DF100, DF115, DF140 (2006-08)

| REF | OEM |
|----------------|----------------------------|
| REC17400-93912 | 17400-93911 17400-93912 |

DT9.9, DT15K1-K4 (2001-04)
DT9.9K, DT15KG-Y (1986-00)

| REF | OEM |
|----------------|----------------------------|
| REC17400-87L01 | 17400-87L00 17400-87L01 |

DF70A, DF80A, DF90A (2009+)

| REF | OEM |
|----------------|--|
| REC17400-96J03 | 17400-96J00 17400-96J01 17400-96J02 17400-96J03 |

DF150, DF150G, DF150AP
DF170, DF175G, DF175AP
DF200A, DF200AP (2006+)

| REF | OEM |
|----------------|-------------|
| REC17400-88L00 | 17400-88L00 |

DF40A, DF50A, DF60A (2010+)

new

| REF | OEM |
|----------------|--------------|
| REC17400-94J00 | 17400-94J200 |

DF9.9, DF15 (2007+)

new

| REF | OEM |
|----------------|----------------------------|
| REC17400-95J02 | 17400-95J01 17400-95J02 |

D25 V-TWIN (20106+)

**GUÍA
KITS DE BOMBA DE AGUA**

**GUIDE OF WATER PUMP
SERVICE KITS**

**GUIDA
KIT POMPA ACQUA**

**GUIDE
KIT POMPE À EAU**

| 2T STROKES | REF |
|---------------|------------------------|
| DT4 | 1984-98 REC17400-98652 |
| DT5 | 1992-02 REC17400-98652 |
| DT6 | 1984-02 REC17400-98551 |
| DT8 | 1986-97 REC17400-98551 |
| DT9.9 | 1985-87 REC17400-98551 |
| DT15C | 1989-97 REC17400-98551 |
| DT15 | 1983-88 REC17400-98551 |
| DT8 | 1988-97 REC17400-92D01 |
| DT9.9C | 1989-00 REC17400-96403 |
| DT25C | 1988-97 REC17400-96403 |
| DT30C | 1985-88 REC17400-96403 |
| DT20 | 1984-88 REC17400-96403 |
| DT25C | 1984-88 REC17400-96403 |
| DT30C | 1984-87 REC17400-96403 |
| DT35 | 1983-98 REC17400-96403 |
| DT40C | 1985-97 REC17400-94701 |
| DT55 | 1985-97 REC17400-94701 |
| DT65 | 1985-00 REC17400-95351 |
| DT75 | 1985-00 REC17400-95351 |
| DT85 | 1986-01 REC17400-94611 |
| DT115 | 1986-01 REC17400-94611 |
| DT140 | 1986-03 REC17400-87D11 |
| V6 | 1986-03 REC17400-87D11 |

| 4T STROKES | REF |
|---------------|------------------------|
| DF4 | 2002+ REC17400-98661 |
| DF6 | 2010+ REC17400-99J01 |
| DF9.9A | 2007+ REC17400-94J00 |
| DF9.9 | |
| DF15 | |
| DF9.9B | 1997-06 REC17400-93951 |
| DF15A | |
| DF20A | |
| DF25 | 2000-07 REC17400-96403 |
| DF30 | |
| DF40 | 1999-10 REC17400-96403 |
| DF50 | |
| DF25A | 2014+ REC17400-94L00 |
| DF30A | |
| DF60 | 1998-10 REC17400-87E04 |
| DF70 | |
| DF40A | |
| DF50A | 2010+ REC17400-88L00 |
| DF60A | |
| DF70A | |
| DF80A | 2009+ REC17400-87L01 |
| DF90A | |
| DF90 | |
| DF100 | 2006-08 REC17400-92J00 |
| DF115 | |
| DF140 | |

| REF | |
|---------|------------------------|
| DF90 | 2001-05 REC17400-90J20 |
| DF115 | |
| DF140 | |
| DF100A | |
| DF115 | 2009+ REC17400-92J21 |
| DF115A | |
| DF140A | |
| DF150AP | |
| DF175AP | |
| DF150 | |
| DF150G | |
| DF150AP | 2006+ REC17400-96J03 |
| DF175 | |
| DF175G | |
| DF175AP | |
| DF200A | |
| DF200AP | |
| DF200 | 2004+ REC17400-93J01 |
| DF225 | |
| DF250 | |
| DF250SS | |
| DF300A | 2007+ REC17400-98J01 |
| DF300AP | |



ÁNODO

ANODE

ANODI

ANODE

| ZN (KG) | AL (KG) | OEM |
|---------------------|----------------------|-------------|
| CM55300-95500 0,018 | CM55300-95500A 0,023 | 55300-95500 |

DF9.9 (2004-10)
DF15 (1996-03)
DF40, DF50 (1999-10)
DF40A, DF50A, DF60A (2010+)

| ZN (KG) | AL (KG) | OEM |
|--------------------|----------------------|----------------------------|
| CM55321-87J00 0,02 | CM55321-87J00A 0,007 | 55321-87J00 55321-87J01 |

TORNILLO PAGB/T5783-M6X14 TÓRICA REC09280-22019

| ZN (KG) | AL (KG) | OEM |
|--------------------|----------------------|-------------|
| CM55320-98400 0,05 | CM55320-98400A 0,046 | 55320-98400 |

DF9.9, DF15 (1997-10)

| ZN (KG) | AL (KG) | OEM |
|--------------------|------------|-------------|
| CM41811-98500 0,05 | | 41811-98500 |

DT4, DT15
DF9.9, DF15

| ZN (KG) | AL (KG) | OEM |
|--------------------|---------------------|-------------|
| CM55320-95310 0,08 | CM55320-95310A 0,03 | 55320-95310 |

DF25 --- DF300 (2000+)

| ZN (KG) | AL (KG) | OEM |
|--------------------|---------------------|-------------|
| CM55321-94900 0,51 | CM55321-94900A 0,21 | 55320-94900 |

DF60 --- DF300 HP

| ZN | (KG) | AL | (KG) | OEM |
|---------------|------|----------------|-------|-------------|
| CM55125-95500 | 0,25 | CM55125-95500A | 0,087 | 55125-87E01 |

DF40, DF50 (1999-10)
DF40A, DF50A, DF60A (2010+)



| ZN | (KG) | AL | (KG) | OEM |
|---------------|------|----|------|-------------|
| CM55125-94502 | 0,33 | | | 55125-94502 |

DT115 --> DT140 (1986-00)



| ZN | (KG) | AL | (KG) | OEM |
|---------------|------|----------------|------|-------------|
| CM55321-93900 | 0,08 | CM55321-93900A | 0,02 | 55320-93900 |

DF9.9, DF15 (1997-08)



| ZN | (KG) | AL | (KG) | OEM |
|---------------|------|----------------|-------|-------------|
| CM55320-98600 | 0,10 | CM55320-98600A | 0,034 | 55320-98600 |

DT4, DT5 (1988-02)



| ZN | (KG) | AL | (KG) | OEM |
|---------------|------|----------------|------|----------------------------|
| CM55125-87D00 | 0,34 | CM55125-87D00A | 0,14 | 55320-93900 55125-87801 |

50 --> 250 HP



| ZN | (KG) | AL | (KG) | OEM |
|---------------|------|----------------|-------|-------------|
| CM55321-90J01 | 0,08 | CM55321-90J01A | 0,036 | 55321-90J01 |

DF60, DF70, DF90, DF115, DF140 (1998-10)



| ZN | (KG) | AL | (KG) | OEM |
|---------------|------|----------------|------|-------------|
| CM55125-96310 | 0,13 | CM55125-96310A | 0,07 | 55125-96310 |

20, 25, 30, 40 50 HP (1983-10)
DF25, DF30 (2000-10)
DF25 V-TWIN (2006+)



| ZN | (KG) | AL | (KG) | OEM |
|---------------|------|----------------|------|-------------|
| CM11130-94600 | 0,02 | CM11130-94600A | 0,01 | 11130-94600 |

DT4 --> DT140 (1986-2002)

TORNILLO
PAGB/T5783-M6X14



| AL | (KG) | OEM |
|----------------|------|-------------|
| CM55125-95301A | 0,06 | 55125-95301 |

55, 65 HP



| KITS DE ÁNODOS | ANODES KIT | KIT ANODI | KIT ANODES | | | | |
|--|------------|---------------|------------|---|----|--------------|--|
| <table border="1"> <thead> <tr> <th>AL</th> </tr> </thead> <tbody> <tr> <td>CMSZ90140KITA</td> </tr> </tbody> </table> <p>90, 100, 115, 140 hp</p>  | AL | CMSZ90140KITA | | <table border="1"> <thead> <tr> <th>AL</th> </tr> </thead> <tbody> <tr> <td>CMSZ4050KITA</td> </tr> </tbody> </table> <p>40 - 50 hp</p>  | AL | CMSZ4050KITA | |
| AL | | | | | | | |
| CMSZ90140KITA | | | | | | | |
| AL | | | | | | | |
| CMSZ4050KITA | | | | | | | |

ÁNODO

ANODE

ANODI

ANODE

| ZN | OEM | (KG) |
|----------|-------------|------|
| TEN01208 | 55300-95500 | 0,08 |

DF9.9 (2004-10)
DF15 (1996-03)
DF40, DF50 (1999-10)
DF40A, DF50A, DF60A (2010+)



| ZN | OEM | (KG) | Ø |
|------------|-------------|------|------|
| TEN01210 | 55320-98400 | 0,05 | 7 mm |
| TEN01210/1 | 41811-98500 | 0,05 | M6 |

DF9.9, DF15 (1997-10)



| ZN | OEM | (KG) |
|----------|-------------|------|
| TEN01212 | 55321-90J01 | 0,10 |

DF60, DF140 (1998-10)



| ZN | OEM | (KG) | TORNILLO | TÓRICA |
|----------|----------------------------|------|------------------|----------------|
| TEN01213 | 55321-87J00 55321-87J01 | 0,02 | PAGB/T5783-M6X14 | REC09280-22019 |

DF8 --> DF300



| ZN | (KG) | AL | (KG) | OEM |
|----------|------|------------|------|-------------|
| TEN01214 | 0,51 | TEN01214AL | 0,20 | 55320-94900 |

DF60 --> DF30 HP



| ZN | (KG) | OEM |
|----------|-------|-------------|
| TEN01202 | 0,095 | 55320-98600 |

DT4, DT5 (1988-02)



| ZN | OEM | (KG) |
|----------|----------------------------|------|
| TEN01211 | 55125-87D00 55120-87801 | 0,31 |

50 --> 70 HP
DT150, DT175, DT200, DT225
4T



| ZN | OEM | (KG) |
|----------|-------------|------|
| TEN01215 | 55125-90J01 | 0,25 |

Serie 7DF60- DF70
DF90 --> DF140 (1998+)

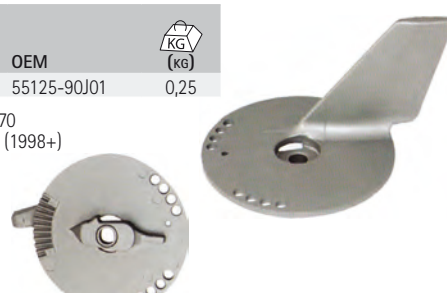

| ZN | OEM | (KG) |
|----------|-------------|------|
| TEN01200 | 55125-96310 | 0,15 |

20, 25, 30 HP
DF25, DF30 (2000-10)
DF25 V-TWIN (2006+)



| ZN | (KG) | AL | (KG) | OEM |
|----------|------|------------|------|----------------------------|
| TEN01204 | 0,08 | TEN01204AL | 0,03 | 55320-98311 55320-95310 |

DF25, DF300 (2010+)



| ZN | (KG) | OEM |
|----------|------|-------------|
| TEN01201 | 0,16 | 55125-95301 |

DF40, DF50 (1999-10)
DF40A, DF50A, DF60A (2010+)



| ZN | (KG) | OEM |
|----------|------|-------------|
| TEN01206 | 0,05 | 55321-93900 |

DF9.9, DF15 (1997-08)



| ZN | (KG) | OEM |
|----------|------|----------------------------|
| TEN01207 | 0,19 | 55321-95500 55320-98600 |

75, 85, 90 HP



| ZN | OEM |  (KG) |
|----------|-------------|--|
| TEN01203 | 41810-87D00 | 0,15 |



| ZN |  (KG) | OEM |
|----------|--|----------------------------|
| TEN01209 | 0,33 | 55321-94502 55125-94502 |

115 HP



| ZN |  (KG) | OEM | TORNILLO |
|----------|--|-------------|------------------|
| TEN01205 | 0,01 | 11130-94600 | PAGB/T5783-M6X14 |

DT4 --> DT140 (1986-02)



| ZN |  (KG) | OEM |
|----------|--|-------------|
| TEN01166 | 0,03 | 11281-94400 |

DT8 --> DT65 (1986-00)
DF60, DF70 (1998-09)



new

TORNILLO INOX SS SCREW VITE INOX VIS INOX

| REF | OEM | ÁNODO ANODE ANODO ANODE |
|------------------|-------------|--|
| PAGB/T5783-M6X14 | 09103-06281 | CM55321-87J00 CM11130-94600 TEN01213 TEN01205 |



new

| REF | OEM | ÁNODO ANODE ANODO ANODE |
|-----------------|-------------|----------------------------------|
| PAGB/T818-M6X14 | 09128-06221 | 11130-94600 |



new

| REF | OEM | ÁNODO ANODE ANODO ANODE | |
|----------------|-------------|----------------------------------|--------|
| REC09116-06121 | 09116-06121 | 55321-94900 | 6 X 25 |



new

| REF | OEM | ÁNODO ANODE ANODO ANODE | |
|----------------|-------------|----------------------------------|--------|
| REC09116-06094 | 09116-06094 | 55321-93J00 | 6 X 15 |



new

JUNTA TÓRICA O-RING O-RING JOINT TORIQUE

| REF | OEM | ÁNODO ANODE ANODO ANODE |
|----------------|-------------|----------------------------------|
| REC09280-22019 | 09280-22019 | CM55321-87J00 TEN01213 |



new

JUNTA TAPA DEL ÁNODO GASKET, ANODE COVER GUARNIZIONE, COPERCHIO ANODO JOINT, COUVERCLE D'ANODE

| REF | OEM |
|----------------|--------------------------------|
| REC11265-87E10 | 11265-87E00 11265-87E00-H17 |

DF25 --> DF140



new

PARTES DEL MOTOR ENGINE PARTS

PARTI MOTORE PIECES MOTEUR

DESPIECE MOTOR
DE 2 TIEMPOS

ENGINE PARTS
2 STROKES

PARTI MOTORI
2 TEMPI

PIECES DE MOTEURS
2 TEMPS

2T
STROKES DT40C-W-G-X (1986-99)
DTW-K1-KA (2001-04)

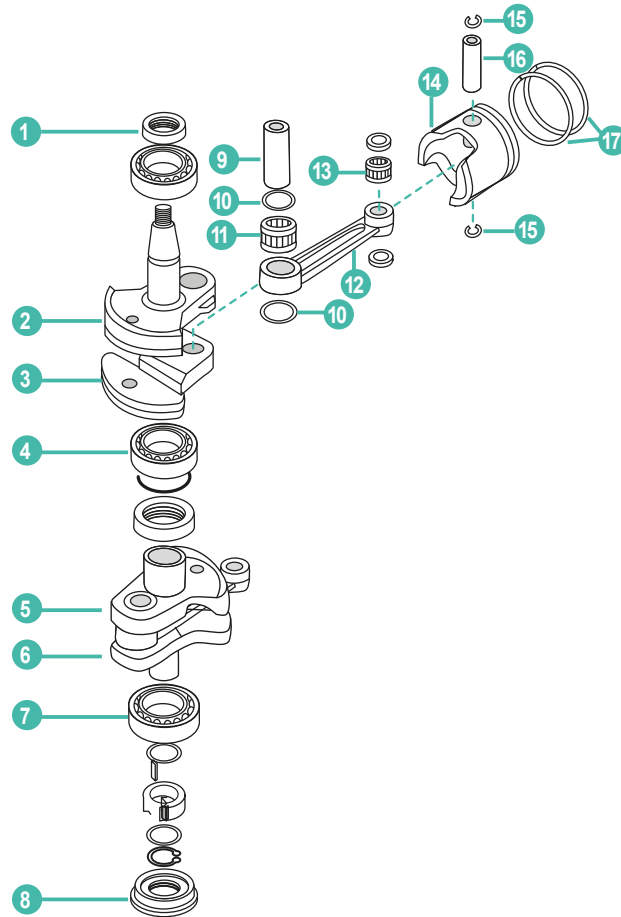

| | REF | OEM | | | | | UN. |
|----|-----------------|--------------|----------------|----------------|-------------------|---------------------|-----|
| 1 | REC09283-35043 | 09283-35043 | RETÉN | OIL SEAL | PARAOLIO | JOINT SPI | 1 |
| 2 | REC12221-94412 | 12221-94412 | CIGÜEÑAL 1 | CRANKSHAFT 1 | ALBERO MOTORE 1 | VILEBREQUIN 1 | 1 |
| 3 | REC12231-94413 | 12231-94413 | CIGÜEÑAL 2 | CRANKSHAFT 2 | ALBERO MOTORE 2 | VILEBREQUIN 2 | 1 |
| 4 | REC09269-30012 | 09269-30012 | RODAMIENTO | BEARING | CUSCINETTO | ROULEMENT | 1 |
| 5 | REC12232-94412 | 12232-94412 | CIGÜEÑAL 3 | CRANKSHAFT 3 | ALBERO MOTORE 3 | VILEBREQUIN 3 | 1 |
| 6 | REC12240-94432 | 12240-94432 | CIGÜEÑAL 4 | CRANKSHAFT 4 | ALBERO MOTORE 4 | VILEBREQUIN 4 | 1 |
| 7 | REC09262-35052 | 09262-35052 | RODAMIENTO | BEARING | CUSCINETTO | ROULEMENT | 1 |
| 8 | REC09283-30062 | 09283-30062 | RETÉN | OIL SEAL | PARAOLIO | JOINT SPI | 1 |
| 9 | REC12211-94410 | 12211-94410 | BULON CIGÜEÑAL | PIN CRANK | SPINOTTO | CLAVETTE | 2 |
| 10 | REC09160-27008 | 09160-27008 | ARANDELA | WASHER | RONDELLA | RONDELLE | 4 |
| 11 | REC09263-27005 | 09263-27005 | COJINETE BIELA | ROD BEARNG | CUSCINETTO BIELLA | ROULEMENT DE BIELLE | 2 |
| 12 | REC12161-94400 | 12161-94400 | BIELA | CONNECTING ROD | BIELLA | BIELLE | 2 |
| 13 | REC09263-20072 | 09263-20072 | COJINETE BIELA | ROD BEARNG | CUSCINETTO BIELLA | ROULEMENT DE BIELLE | 2 |
| 14 | REC12110-94400K | 12110-94400K | KIT PISTON | PISTON KIT | KIT PISTONE | KIT PISTON | 2 |
| 15 | REC09381-20003 | 09381-20003 | CLIP | CNAP RING | CLIP | CLIP | 4 |
| 16 | REC12151-94400 | 12151-94400 | PIN | PIN | SPINA | AXE DE PISTON | 2 |
| 17 | REC12140-94400 | 12140-94400 | KIT SEGMENTOS | RING SET | SET FASCE | KIT DE SEGMENTS | 2 |

DESPIECE MOTOR
DE 4 TIEMPOS

ENGINE PARTS
4 STROKES

PARTI MOTORI
4 TEMPI

PIECES DE MOTEURS
4 TEMPS

4T DF40, DF50 (1999-10)
STROKES

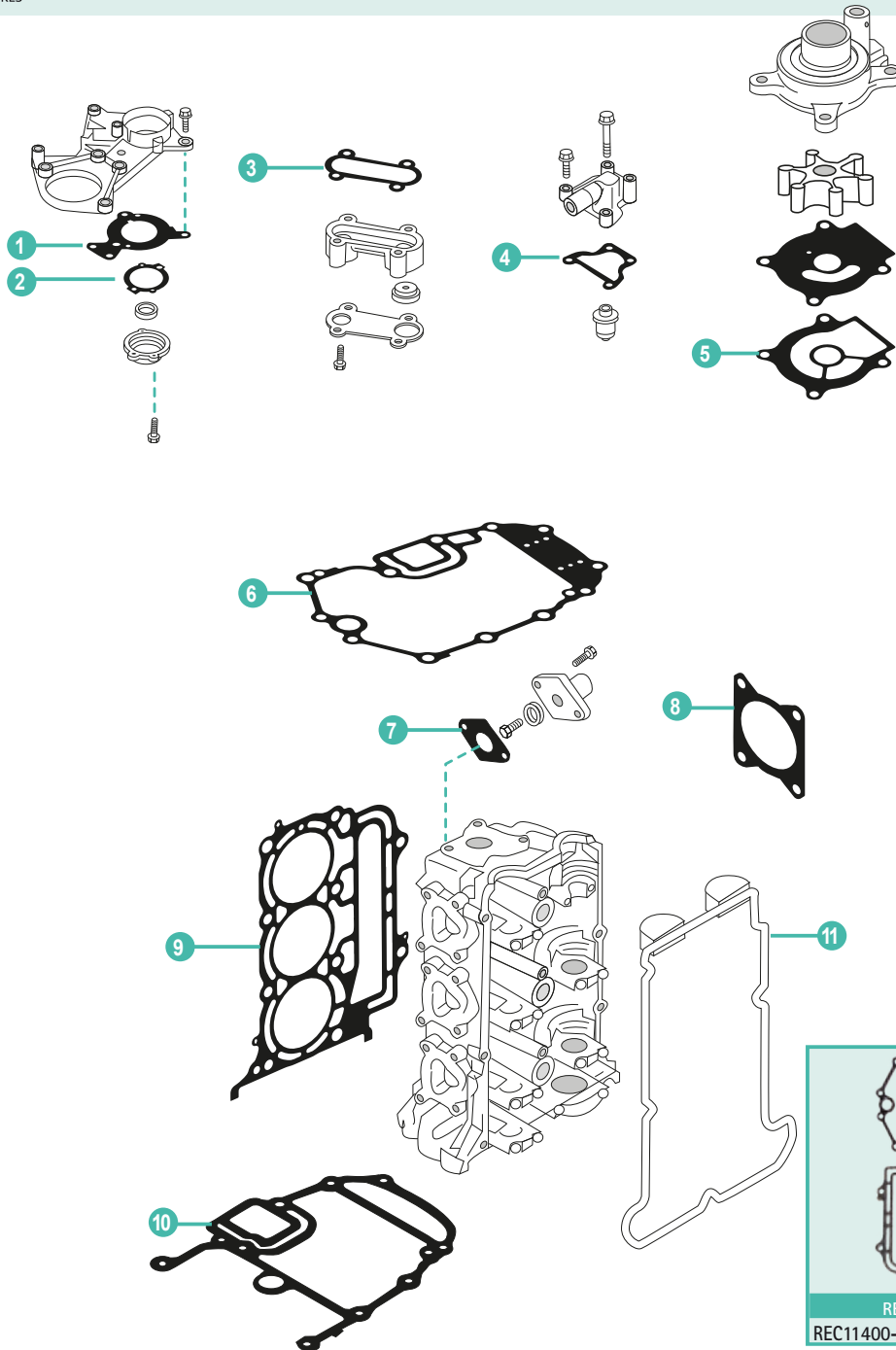

| REF | OEM |
|----------------|-------------|
| REC11400-87804 | 11400-87804 |

| | REF | OEM | | | | |
|----|----------------|-------------|--------------------------------|-------------------------|----------------------------------|-----------------------------|
| 1 | REC11413-87J00 | 11413-87J00 | RETÉN SUPERIOR | SEAL UPPER | PARAOLIO SUPERIORE | JOINT SPI |
| 2 | REC11433-87J00 | 11433-87J00 | JUNTA DEL RETÉN SUPERIOR | SEAL UPPER, GASKET | GUARNIZIONE PARAOLIO SUPERIORE | JOINT SPI |
| 3 | REC17616-87J00 | 17616-87J00 | JUNTA DE LA VÁLVULA DE PRESIÓN | PRESURE VALVE, GASKET | GUARNIZIONE, VALVOLA PRESIONE | JOINT SOUPAPE DE PRESSION |
| 4 | REC17685-87D10 | 17685-87D10 | JUNTA TAPA DE TERMOSTATO | THERMOSTAT COVER GASKET | GUARNIZIONE COPERCHIO TERMOSTATO | JOINT LOGEMENT THERMOSTAT |
| 5 | REC17472-96303 | 17472-96303 | JUNTA DE LA BOMBA DE AGUA | WATER PUMP, GASKET | GUARNIZIONE POMPA ACQUA | JOINT POMPE À EAU |
| 6 | REC11489-87J00 | 11489-87J00 | JUNTA DEL CÁRTER | OIL PAN, GASKET | GUARNIZIONE COPPA OLIO | JOINT DE CARTER |
| 7 | REC11265-87E10 | 11265-87E10 | JUNTA TAPA DEL ÁNODO | GASKET, COVER ANODE | GUARNIZIONE COPERCHIO ANODO | JOINT D'ANODE D'ECHAPPEMENT |
| 8 | REC13421-87J00 | 13421-87J00 | JUNTA DEL CUERPO DE MARIPOSA | THRPTTLE BODY GASKET | GUARNIZIONE CORPO FARFALLATO | JOINT DE THROTTLE BODY |
| 9 | REC11141-87J02 | 11141-87J02 | JUNTA DE CULATA | CYLINDER HEAD, GASKET | GUARNIZIONE TESTATA | JOINT DE CULASSE |
| 10 | REC51211-87J00 | 51211-87J00 | JUNTA BASE MOTOR | GASKET ENGINE | GUARNIZIONE BASE MOTORE | JOINT DE TÊTE MOTRICE |
| 11 | REC11189-87J00 | 11189-87J00 | JUNTA TAPA DE BALANCÍN | GASKET CYLINDER COVER | GUARNIZIONE COPERCHIO PUNTERIE | JOINT COUVERCLE |

4T DF70A, DF80A, DF90A, DF100B (2009+)
STROKES

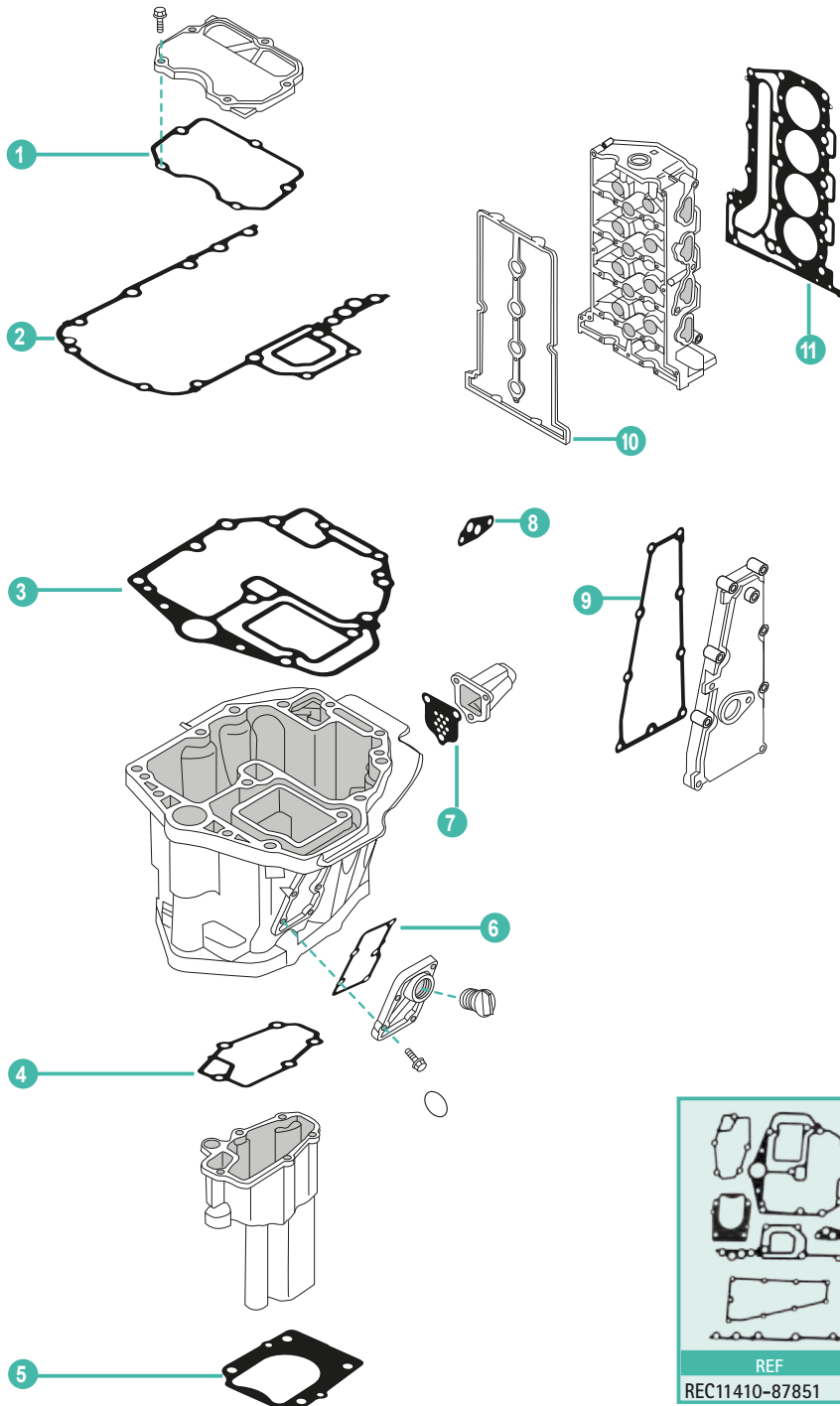

| REF | OEM | | | | | |
|-----|----------------|----------------------------|--------------------------------|----------------------------|----------------------------------|----------------------------------|
| 1 | REC51123-87L00 | 51123-87L00 | JUNTA DE LA TAPA DE SILEMBLOCK | GASKET, MOUNT CASE COVER | GUARNIZIONE COPERCHIO SILEMBLOCK | JOINT DE COUVERCLE SILEMBLOCK |
| 2 | REC51211-87L10 | 51211-87L00 51211-87L10 | JUNTA BASE MOTOR | ENGINE HOLDER GASKET | GUARNIZIONE BASE MOTORE | JOINT BASE MOTEUR |
| 3 | REC11489-87L00 | 11489-87L00 | JUNTA CARTER | OIL PAN GASKET | GUARNIZIONE COPPA | JOINT DE CARTER |
| 4 | REC52331-87L00 | 52331-87L00 | JUNTA TAPA DE ESCAPE | GASKET EXHAUST COVER | GUARNIZIONE COPERCHIO SCARICO | JOINT DE COUVERCLE D'ECHAPPEMENT |
| 5 | REC17472-87L00 | 17472-87L00 | JUNTA BOMBA DE AGUA | WATER PUMP GASKET | GUARNIZIONE POMPA ACQUA | JOINT DE POMPE À EAU |
| 6 | REC52331-87L00 | 52331-87L00 | JUNTA TAPA ESCAPE | GASKET EXHAUST COVER | GUARNIZIONE COPERCHIO SCARICO | JOINT DE COUVERCLE D'ECHAPPEMENT |
| 7 | REC11542-87L00 | 11542-87L00 | JUNTA MÚLTIPLE DE ESCAPE | MULTI EXHAUST GASKET | GUARNIZIONE SCARICO MULTIPLO | JOINT DE PIPE D'ECHAPPEMENT |
| 8 | REC16539-87L00 | 16539-87L00 | JUNTA ADAPTADOR DE FILTRO | FILTER ADAPTER GASKET | GUARNIZIONE ADATTATORE DE FILTRO | JOINT D'ADAPTEUR DE FILTRE |
| 9 | REC14151-87L00 | 11151-87L00 | JUNTA TAPA ESCAPE | GASKET EXHAUST COVER | GUARNIZIONE COPERCHIO SCARICO | JOINT DE COUVERCLE D'ECHAPPEMENT |
| 10 | REC11189-87L00 | 11189-87L00 | JUNTA TAPA DE CULATA | GASKET CYLINDER HEAD COVER | GUARNIZIONE COPERCHIO TESTATA | JOINT DE COUVERTURE DE CULASSE |
| 11 | REC11141-87L00 | 11141-87L00 | JUNTA DE CULATA | CYLINDER-HEAD GASKET | GUARNIZIONE TESTATA | JOINT DE CULASSE |

ÁRBOL DE LEVAS

CAMSHAFT

ALBERO A CAMME

ARBRE A CAMES

| REF | OEM |
|----------------|-------------|
| REC12710-97J00 | 12710-97J00 |

DF2.5 (2006+)



new



REF STA82910

JUNTAS DE MOTOR 4 TIEMPOS

ENGINE GASKET 4 STROKES

GUARNIZIONI MOTORE 4 TEMPI

JOINTS DE MOTEUR 4 TEMPS

4T
STROKES

JUNTAS DE CULATA

CYLINDER HEAD GASKET

GUARNIZIONE TESTA

JOINT DE CULASSE

| REF | OEM |
|----------------|----------------------------|
| REC11141-97J02 | 11141-97JL0 11141-97J01 |

DF2.5 (2006-15)



| REF | OEM |
|----------------|---|
| REC11141-87J02 | 11141-87J00 11141-87J01 11141-87J02 |

DF40, DF50 (1999-10)

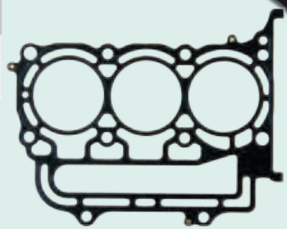

new

| REF | OEM |
|----------------|---|
| REC11141-91JL0 | 11141-91JL0 11141-91J01 11141-91J02 |

DF4, DF5, DF6 (2002-15)



new

| REF | OEM |
|----------------|-------------|
| REC11141-90J01 | 11141-90J00 |

DF90, DF100, DF115K1-K11 (2001-11)

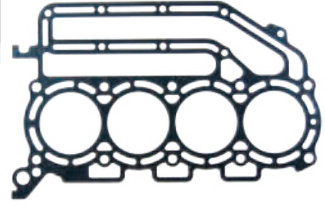

| REF | OEM |
|----------------|-------------|
| REC11141-93E20 | 11141-93E20 |

DF9.9, DF15T-K3 (1996-03)
DF9.9, DF15 (R) (2004-11) MY04



| REF | OEM |
|----------------|-------------|
| REC11141-92J01 | 11141-92J00 |

DF100A, DF115A, DF140A (2013+)
DF140 (2002-12)

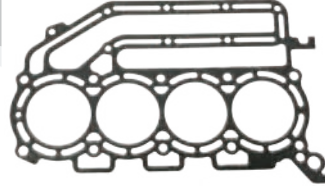

| REF | OEM |
|----------------|-------------|
| REC11141-95J00 | 11141-95J00 |

DF20, DF25, DF25R V2 (2006-11)



| REF | OEM |
|----------------|-------------|
| REC11142-93J10 | 11142-93J03 |
| REC11141-93J10 | 11141-93J03 |

DF200, DF225, DF250 (2004+)

BABOR | PORT | BABORDO | GAUCHE
ESTRIBOR | STD | TRIBORDO | DROIT



| REF | OEM |
|----------------|-------------|
| REC11141-87L00 | 11141-87L00 |

DF70A, DF80A, DF90A, DF100B (2009+)

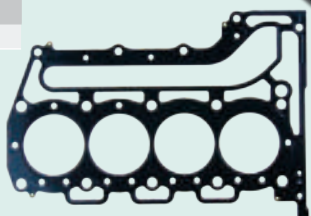

new

| REF | OEM |
|----------------|-------------|
| REC11142-98J10 | 11142-98J00 |
| REC11141-98J10 | 11141-98J01 |

DF300AP (2012)
DF300T-Z (2007-11)

BABOR | PORT | BABORDO | GAUCHE
ESTRIBOR | STD | TRIBORDO | DROIT



SUZUKI

RECAMBIOS MARINOS

4T
STROKESGUÍA
JUNTAS DE CULATACYLINDER HEAD GASKET
GUIDEGUIDA
GUARNIZIONE TESTAGUIDE
JOINTS DE CULASSE

| | | REF | RO OEM |
|-----------------------------|---------|----------------|-------------|
| DF2.5 | 2006-15 | REC11141-97J02 | 11141-97JL0 |
| | | | 11141-91JL0 |
| DF4, DF5, DF6 | 2002-15 | REC11141-91JL0 | 11141-91J01 |
| | | | 11141-91J02 |
| DF9.9, DF15 T-K3 | 1996-03 | REC11141-93E20 | 11141-93E20 |
| DF9.9, DF15 R | 2004-11 | REC11141-93E20 | 11141-93E20 |
| DF20, DF25 R-V2 | 2006-11 | REC11141-95J00 | 11141-95J00 |
| | | | 11141-87J00 |
| DF40, DF50 | 1999-10 | REC11141-87J02 | 11141-87J01 |
| | | | 11141-87J02 |
| DF70A, DF80A, DF90A, DF100B | 2009+ | REC11141-87L00 | 11141-87L00 |

| | | REF | RO OEM |
|-------------------------------|---------|----------------|-------------|
| DF90, DF100, DF115 K1-K11 | 2001-11 | REC11141-90J01 | 11141-90J01 |
| DF100A, DF115A, DF140A | 2013 | REC11141-92J01 | 11141-92J00 |
| DF140 | 2002-12 | REC11141-92J01 | 11141-92J00 |
| DF200, DF225, DF250 V6 (STB) | 2004 | REC11141-93J10 | 11141-93J03 |
| DF200, DF225, DF250 V6 (PORT) | 2004 | REC11142-93J10 | 11142-93J03 |
| DF300 T/Z V6 (STB) | 2007-11 | REC11141-98J10 | 11141-98J01 |
| DF300 T/Z V6 (PORT) | 2007-11 | REC11141-98J10 | 11142-98J00 |
| DF300 AP V6 (STB) | 2012-12 | REC11141-98J10 | 11141-98J01 |
| DF300 AP V6 (PORT) | 2012-12 | REC11141-98J10 | 11142-98J00 |

4T
STROKESKITS
JUNTAS DE CULATACYLINDER HEAD GASKET
KITKIT
GUARNIZIONE TESTAKITS
JOINTS MOTEUR

| REF | OEM |
|----------------|-------------|
| | 11400-87804 |
| | 11400-87803 |
| REC11400-87804 | 11400-87802 |
| | 11400-87801 |
| | 11400-87800 |

DF40, DF50 (1999-10)

| REF | OEM |
|----------------|-------------|
| REC11410-87851 | 11410-87851 |
| | 11410-87850 |

DF70A, DF80A, DF90A, DF100B (2009+)

4T
STROKES

JUNTAS BASE DE MOTOR

CYLINDER GASKET

GUARNIZIONE
BASE MOTORE

JOINTS DE TÊTE MOTRICE

| REF | OEM |
|----------------|-------------|
| REC51211-90J10 | 51211-90J00 |
| | 51211-90J01 |
| | 51211-90J02 |
| | 51211-90J10 |

DF90, DF100, DF115 K1-K11 (2001-11)
DF140 (2002-12)

Motores antiguos
Old engines
Motore vecchio
Moteurs anciennes

| REF | OEM |
|----------------|-------------|
| REC51211-87L10 | 51211-87L00 |
| | 51211-87L10 |

DF70A, DF80A, DF90A, DF100B (2009+)

| REF | OEM |
|----------------|-------------|
| REC51211-93J00 | 51211-93J00 |

DF200, DF225, DF250 (2004-15)
DF300AP (2012)
DF300T/Z (2007-11)

| REF | OEM |
|----------------|-------------|
| REC51211-87J00 | 51211-87J00 |

DF40, DF50 (1999-10)

| REF | OEM |
|---------------|-------------|
| REC51211-90J2 | 51211-90J21 |
| | 51211-90J22 |

DF90, DF100, DF115, DF140
DF100A, DF115A, DF140A (2013+)

Motores modernos
New engines
Motore moderno
Moteurs modernes

| REF | OEM |
|---------------|-------------|
| REC51211-90J2 | 51211-90J21 |
| | 51211-90J22 |

DF90, DF100, DF115, DF140
DF100A, DF115A, DF140A (2013+)

Motores modernos
New engines
Motore moderno
Moteurs modernes

SUZUKI

RECAMBIOS
MARINOS

4T STROKES **JUNTAS BASE ACEITE** **GASKET, UNDER OIL** **GUARNIZIONE BASE OLIO** **JOINTS BASE D'HUILE**

| REF | OEM |
|-----------------------------|-------------|
| REC51142-93J00 | 51142-93J00 |
| DF200, DF225, DF250 (2004+) | |
| DF300AP (2012) | |
| DF300T-Z (2007-11) | |



4T STROKES **JUNTAS BASE RETÉN** **GASKET, MOUNT OIL SEAL COVER** **GUARNIZIONE BASE PARAOLIO** **JOINT DE COUVERCLE**

| REF | OEM |
|-----------------------------|-------------|
| REC51123-93J00 | 51123-93J00 |
| DF200, DF225, DF250 (2004+) | |
| DF300AP (2012) | |
| DF300T/Z (2007-11) | |

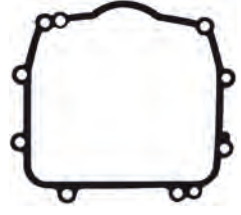

4T STROKES **JUNTAS GUÍA CADENA** **GASKET, TIMING CHAIN GUIDE BASE** **GUARNIZIONE CARTER CATENA GUIDA BASE** **JOINT DE GUIDE CHAINE**

| REF | OEM |
|-----------------------------|-------------|
| REC12778-93J00 | 12778-93J00 |
| DF200, DF225, DF250 (2004+) | |
| DF300AP (2012) | |
| DF300T/Z (2007-11) | |



4T STROKES **JUNTAS ACEITE** **GASKET, OIL GALLERY** **GUARNIZIONE OLIO** **JOINT D'HUILE**

| REF | OEM |
|-----------------------------|-------------|
| REC16433-93J00 | 16433-93J00 |
| DF200, DF225, DF250 (2004+) | |
| DF300AP (2012) | |
| DF300T/Z (2007-11) | |



| REF | OEM |
|-------------------------------------|-------------|
| REC11552-87L00 | 11552-87L00 |
| DF70A, DF80A, DF90A, DF100B (2000+) | |

| REF | OEM |
|---------------------------------|-------------|
| REC17693-95J00 | 17693-95J00 |
| DF20R, DF25, DF25R V2 (2006-11) | |



4T STROKES **JUNTAS CUERPO DE MARIPOSA** **GASKET, THROTTLE BODY** **GUARNIZIONE CORPO FARFALLATO** **JOINT DE THROTTLE BODY**

| REF | OEM |
|--------------------|-------------|
| REC13421-98J00 | 13421-98J00 |
| DF300AP (2012) | |
| DF300T/Z (2007-11) | |



| REF | OEM |
|----------------|-------------|
| REC13421-87J00 | 13421-87J00 |
| DF40, DF50 | |

4T STROKES **JUNTA TAPA DE FILTRO** **GASKET, FILTER COVER** **GUARNIZIONE COPERCHIO FILTRO** **JOINT COUVERCLE DE FILTRE**

| REF | OEM |
|-------------------------------------|-------------|
| REC16539-87L00 | 16539-87L00 |
| DF70A, DF80A, DF90A, DF100B (2009+) | |

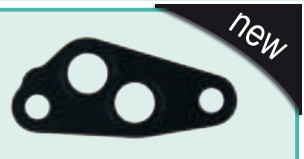

4T
STROKES

JUNTA TAPA DE SILEMBLOCK **GASKET, SILEMBLOCK COVER** **GUARNIZIONE COPERCHIO SILEMBLOCK** **JOINT DE COUVERCLE SILEMBLOCK**

| REF | OEM |
|----------------|-------------|
| REC51123-87L00 | 51123-87L00 |

DF70A, DF80A, DF90A, DF100B (2009+)

new

4T
STROKES

JUNTA TAPA DE BALANCINES **GASKET, CYLINDER COVER** **GUARNIZIONE COPERCHIO PUNTERIE** **JOINT DE CACHE CULBUTEUR**

| REF | OEM |
|----------------|-------------|
| REC11189-87L00 | 11189-87L00 |

DF70A, DF80A, DF90A, DF100B (2009+)

new

| REF | OEM |
|----------------|-------------|
| REC11189-87J00 | 11189-87J00 |

DF40, DF50 (1999-10)

new

4T
STROKES

JUNTA TAPA DE TERMOSTATO **GASKET, THERMOSTAT COVER** **GUARNIZIONE COPERCHIO TERMOSTATO** **JOINT LOGEMENT THERMOSTAT**

| REF | OEM |
|----------------|----------------------------|
| REC17685-87D10 | 17685-87D10 17685-87D00 |

DF40, DF50 (1999-10)
V6 H-Y (1987-00)

new

4T
STROKES

JUNTA VÁLVULA DE PRESION **GASKET, PRESSURE VALVE** **GUARNIZIONE VALVOLA PRESSIONE** **JOINT SOUPAPE DE PRESSION**

| REF | OEM |
|----------------|-------------|
| REC17616-87J00 | 17616-87J00 |

DF40, DF50 (1999-10)

new

4T
STROKES

JUNTA RETÉN SUPERIOR **GASKET, UPPER SEAL** **GUARNIZIONE PARAOLIO SUPERIORE** **JOINT D'HUILE SUPERIEUR**

| REF | OEM |
|----------------|-------------|
| REC11413-87J00 | 11413-87J00 |

DF40, DF50 (1999-10)

new

| REF | OEM |
|----------------|-------------|
| REC11433-87J00 | 11433-87J00 |

DF40, DF50 (1999-10)

new

2T
STROKES

**JUNTAS DE MOTOR
2 TIEMPOS**

**ENGINE GASKET
2 STROKES**

**GUARNIZIONI
MOTORE 2 TEMPI**

**JOINTS DE MOTEUR
2 TEMPS**

JUNTAS DE CULATA

CYLINDER HEAD GASKET

GUARNIZIONE TESTA

JOINT DE CULASSE

| REF | OEM |
|----------------|-------------|
| REC11141-98401 | 11141-98401 |

DT2, DT2.2 G-Y (1686-00)





| REF | OEM |
|----------------|-------------|
| REC11141-96344 | 11141-96344 |

DT25, DT30 K1-K2 (2001-02)





| REF | OEM |
|----------------|-------------|
| REC11141-98130 | 11141-98130 |

DT5, DT6, DT8 G-Y (1986-00)
DT6, DT8Y-KS (2000-02)



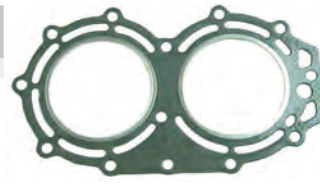

| REF | OEM |
|----------------|-------------|
| REC11141-94450 | 11141-94450 |

DT40C-W-G-X (1986-99)

| REF | OEM |
|----------------|-------------|
| REC11141-93960 | 11141-93950 |

DT9.9D, DT15K-G-Y (1986-00)
DT9.9, DT15K1-K4 (2001-04)
DT15C (1989-97)





| REF | OEM |
|----------------|----------------------------|
| REC11141-94720 | 11141-94701 11141-94720 |

DT55, DT65J-X (1988-99)



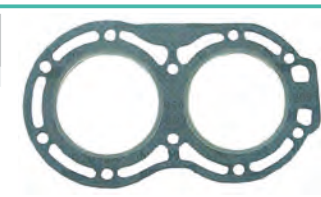

| REF | OEM |
|----------------|-------------|
| REC11141-96303 | 11141-96344 |

DT20, DT25, DT30G-Y (1986-00)

| REF | OEM |
|----------------|----------------------------|
| REC11141-95505 | 11141-95505 11141-95621 |

DT75, DT85J-Y (1988-00)





| REF | OEM |
|----------------|-------------|
| REC11141-95D40 | 11141-95D40 |

DT25C, DT30C-K-Y (1989-00)





| REF | OEM |
|----------------|----------------------------|
| REC11141-87E90 | 11141-87D90 11141-87E20 |

DT25C, DT30C-K-Y (1989-00)





| REF | OEM |
|----------------|----------------------------|
| REC11141-94506 | 11141-94506 11141-94620 |

DT115, DT140G-Y (1986-00)
4 In line



| REF | OEM |
|----------------|----------------------------|
| REC11141-87D90 | 11141-87D90 11141-87D61 |

150/200 HP (1986)
V6



2T
STROKES

**GUÍA
JUNTAS DE CULATA**

**CYLINDER HEAD GASKET
GUIDE**

**GUIDA
GUARNIZIONE TESTA**

**GUIDE
JOINTS DE CULASSE**

| | | REF | RO OEM |
|----------------------|---------|----------------|-------------|
| DT2.2, DT2.2 G-Y | 1986-00 | REC11141-98401 | 11141-98411 |
| DT5, DT6, DT8 G-Y | 1986-00 | REC11141-98130 | 11141-98130 |
| DT6, DT8 Y-K2 | 2000-02 | REC11141-98130 | 11141-98130 |
| DT9.9K, DT15 K-G-Y | 1986-00 | REC11141-93960 | 11141-93950 |
| DT9.9, DT15 K1-K4 | 2001-04 | REC11141-93960 | 11141-93950 |
| DT15C | 1989-97 | REC11141-93960 | 11141-93950 |
| DT20, DT25, DT30 G-Y | 1986-00 | REC11141-96303 | 11141-96344 |
| DT25, DT30 C-K-Y | 1989-00 | REC11141-95D40 | 11141-95D40 |
| DT25, DT30 K1-K2 | 2001-01 | REC11141-96344 | 11141-96343 |

| | | REF | RO OEM |
|--------------------------|---------|----------------|-------------|
| DT40 C-W-G-X | 1986-99 | REC11141-94450 | 11141-94440 |
| DT55, DT65 J-X | 1988-99 | REC11141-94720 | 11141-94720 |
| DT75, DT85 J-Y | 1988-00 | REC11141-95505 | 11141-95621 |
| DT90, DT100 L-Y | 1990-00 | REC11141-87E90 | 11141-87E20 |
| DT115, DT140 G-Y | 1986-00 | REC11141-94506 | 11141-94620 |
| DT150, DT200, V6 | 1986-86 | REC11141-87D90 | 11141-87D61 |
| DT150, DT200, DT225 W-K3 | 1998-03 | REC11141-87D92 | 11141-87D32 |

SUZUKI

RECAMBIOS
MARINOS

2T
STROKES

JUNTAS DE CULATÍN

GASKET, HEAD COVER

GUARNIZIONE COPERCHIO TESTA

JOINTS DE COUVRE CULASSE

| REF | OEM |
|----------------|-------------|
| REC11162-94410 | 11162-94410 |

DT40C-WG-X (1986-99)
DT40W K1-K4 (2001-04)

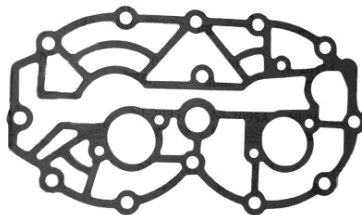

2T
STROKES

JUNTAS BASE ACEITE

GASKET, UNDER OIL

GUARNIZIONE BASE OLIO

JOINTS DE TÊTE MOTRICE

| REF | OEM |
|----------------|-------------|
| REC11433-93912 | 11433-93901 |

DT9.9, DT15 K1-K4 (2001-04)
DT9.9K, DT15K-G-Y (1986-00)

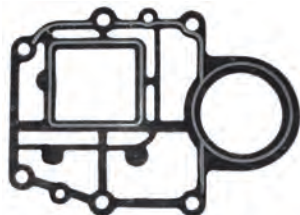

| REF | OEM |
|----------------|-------------|
| REC11433-96330 | 11433-96302 |

DT20, DT25, DT30G-Y (1986-00)
DT25, DT30 K1-K2 (2001-02)

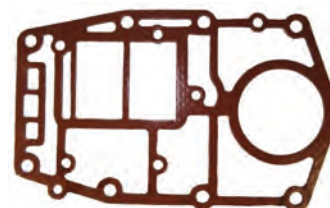

| REF | OEM |
|----------------|-------------|
| REC11433-94412 | 11433-94401 |

DT40C-W-G-X (1986-00)

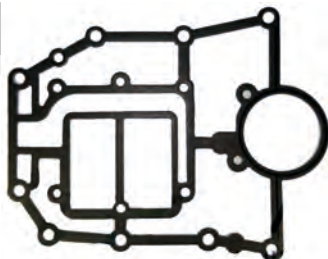

2T
STROKES

JUNTA TAPA DE TERMOSTATO

GASKET, THERMOSTAT COVER

GUARNIZIONE COPERCHIO TERMOSTATO

JOINT LOGEMENT THERMOSTAT

| REF | OEM |
|----------------|----------------------------|
| REC17685-87D10 | 17685-87D10 17685-87D00 |

DT150, DT200, DT225 (1998-03)
DT90, DT100 (1990-00)



new

RETENES DE ACEITE OIL SEALS

PARAOLIO

JOINT SPI

RETÉN DE ACEITE

OIL SEAL

PARAOLIO

JOINT SPI

| REF | OEM | Dimensions |
|----------------|-------------|------------------|
| REC09282-10008 | 09282-10008 | 10 x 21 x 4.5 mm |

DF2.5 (2006-13)
DF4, DF5, DF6 (2002+)
DT4/J4, DT5Y (1988-02)
DT4K1 (2001)



| REF | OEM | Dimensions |
|----------------|-------------|----------------|
| REC09283-17002 | 09283-17002 | 17 x 29 x 7 mm |

DT2, DT2.2G-Y (1986-00)
DT2.2 K1-K5 (2001-05)



| REF | OEM | Dimensions |
|----------------|-------------|------------------|
| REC09282-12008 | 09282-12008 | 12 x 24 x 4.5 mm |



DF2.5 (2012)
DTK1 (2001)
DF4, DF5, DF6 (2002-12)
DT4, J4, DT5Y (1988-02)
DT8, DT9.9C-J-V (1988-97)







| REF | OEM | Dimensions |
|----------------|-------------|----------------|
| REC09283-20018 | 09283-20018 | 20 x 37 x 9 mm |



DT4K1 (2001)
DT4, J4, DT5Y (1988-02)
DT8, DT9.9C-J-V (1988-97)
DT15C (1989-97)







| REF | OEM | |
|---|--|---|
| REC09282-12010 | 09282-12010 | 12 x 25 x 7 mm |
|  | DF9.9, DF15 (R) (2004-12) DF9.9, DF15T-K3 (1996-03) DT15C (1989-97) DT9.9K, DT15K-G-Y (1986-00) DT9.9, DT15K1-K4 (2001-04) |  |



| REF | OEM | |
|---|---|---|
| REC09282-15008 | 09282-15008 | 14.7 x 25 x 6.5 mm |
|  | DF20R, DF25, DF25RVZ (2006-11) DT20, DT25, DT30G-Y (1986-00) DT25, DT301-K2 (2001-02) |  |



| REF | OEM | |
|---|--|---|
| REC09282-17005 | 09282-17005 | 17 x 32 x 6 mm |
|  | DF40, DF50X-K10 (1999-10) DF40A, DF50A, DF60A (2010+) DT40X-W-G-X (1986-99) DT40W-K1-K4 (2001-04) |  |



| REF | OEM | |
|---|--|---|
| REC09282-17009 | 09282-17009 | 17 x 28 x 6 mm |
|  | DF25, DF30W-K6 (2000-06) DF40, DF50Y-K10 (1999-10) DT25C, DT30C-K-Y (1989-00) DT40C-W-G-X (1986-99) DT40W-K1-K4 (2001-04) DT55, DT65J-X (1988-99) |  |



| REF | OEM | |
|---|--|---|
| REC09283-10003 | 09283-10003 | 10 x 22 x 6 mm |
|  | DT4 J4, DT5Y (1988-02) DT4K1 (2001) DT5, DT6, DT8G-Y (1986-00) DT6, DT8Y-K2 (2000-02) |  |



| REF | OEM | |
|---|-----------------------|---|
| REC09283-10009 | 09283-10009 | 10 x 45 x 5 mm |
|  | DF4, DF5, DF6 (2002+) |  |



| REF | OEM | |
|---|--|---|
| REC09283-35043 | 09283-35043 | 35 x 55 x 7 mm |
|  | DT40C-W-G-X (1986-99) DT40WK1-K4 (2001-04) DT55, DT65J-X (1988-99) |  |



| REF | OEM | |
|---|--|---|
| REC09289-10005 | 09289-10005 | |
|  | DT2, DT2.2G-Y (1986-00) DT2.2 K1-K5 (2001-05) |  |



| REF | OEM | |
|---|--|---|
| REC09283-30064 | 09283-30064 | 30 x 55 x 10 mm |
|  | DT20, DT25, DT30G-Y (1986-00) DT25, DT30K1-K2 (2001-02) |  |



| REF | OEM | |
|---|---|---|
| REC09283-20045 | 09283-20045 | |
|  | DT4 -J4, DT5Y (1988-00) DT5Y (1998-02) DT4K1 (2001) |  |



| REF | OEM | |
|---|--|---|
| REC09283-25035 | 09283-25035 | 25 x 40 x 7 mm |
|  | DT15C (1989-97) DT9.9K, DT15K-G-Y (1986-00) DT9.9, DT15K1-K4 (2001-04) |  |



| REF | OEM | |
|---|---|---|
| REC09283-25075 | 09283-25075 | 25 x 52 x 7 mm |
|  | DT9.9K, DT15K-G-Y (1986-00) DT9.9, DT15K1-K4 (2001-04) |  |



| REF | OEM | |
|---|-----------------------|---|
| REC09283-25076 | 09283-25075 | 25 x 45 x 5 mm |
|  | DF4, DF5, DF6 (2002+) |  |

| REF | OEM | |
|---|--|---|
| REC09283-30062 | 09283-30062 | 30 x 55 x 8 mm |
|  | DT20, DT25, DT30G-Y (1986-00) DT25, DT30K1-K2 (2001-02) DT40C-W-G-X (1986-99) DT40W K1-K4 (2001-04) DT55, DT65J-X (1988-99) DT75, DT85J-Y (1988-00) |  |

| REF | OEM | |
|---|---|---|
| REC09289-12002 | 09289-12002 | 12 x 28 x 8 mm |
|  | DT2, DT2.2 G-Y (1986-00) DT2.2 K1-K5 (2001-05) |  |

| REF | OEM | |
|---|--|---|
| REC09289-17004 | 09289-17004 | 17 x 30 x 9 mm |
|  | DT20, DT25, DT30G-Y (1986-00) DT25, DT30K1-K2 (2001-02) |  |

| REF | OEM | |
|---|--|---|
| REC09289-17006 | 09289-17006 | 17 x 30 x 6 mm |
|  | DF8A-AR, DF9.9A-AR (2010-12) DF9.9, DF15(R) (2004-12) DF9.9, DF15T-K3 (1996-03) D9.9K, DT15K-G-Y (1986-00) DT9.9, DT15K1-K4 (2001-04) DT15C (1989-97) |  |

| REF | OEM | |
|---|--|---|
| REC09289-20009 | 09289-20009 | 20 x 34 x 6,5 mm |
|  | DF20R, DF25, DF25RVZ (2006-11) DF25, DF30Y-K6 (2000-06) DT20, DT25, DT30G-Y (1986-00) DT25, DT30K1-K2 (2001-02) DT25C, DT30C-K-Y (1989-00) |  |

| REF | OEM | |
|----------------|-------------|------------------|
| REC09289-22007 | 09289-22007 | 21.2 x 35 x 5 mm |



 DF40A, DF50A, DF60A (2010+)
 DF40, DF50X-K10 (1999-10)
 DT40X-W-G-X (1986-99)
 DT40C-W-G-X (1986-99)
 DT40W-K1-K4 (2001-04)
 DT55, DT65J-X (1988-99)

| REF | OEM | |
|----------------|-------------|-----------------|
| REC09289-12003 | 09289-12003 | 13 x 26 x 10 mm |



 DF15 (2012)
 DF9.9, DF15T-K3 (1996-03)
 DF9.9, DF15(R) (2004-11)
 DT15C (1989-97)
 DT9.9, DT15 K1-K4 (2001-04)
 DT9.9K, DT15K G-Y (1986-00)

| REF | OEM | |
|----------------|-------------|-----------------|
| REC09289-30008 | 09289-30008 | 30 x 52 x 10 mm |



 DT9.9K, DT15K-G-Y (1986-00)
 DT9.9, DT15K1-K4 (2001-04)

| REF | OEM | |
|----------------|----------------------------|----------------|
| REC93101-22067 | 09282-22007 09282-22004 | 22 x 36 x 6 mm |



 DT90, DT100 (1990-00)
 DF40A, DF50A, DF60A (2014+)
 DF60, DF70 (1998-09)
 DF70A, DF80A, DF90A (2009-14)

JUNTA TAPÓN DE DRENAJE

O-RING DRAIN CAP

GUARNIZIONE TAPPO DRENAGIO

JOINT DE VIDANGE

| REF | OEM | |
|----------------|-------------|------------------|
| REC09168-10022 | 09168-10022 | 10 x 17 x 1.5 mm |



 2.5 ---> 225 HP

CIGÜEÑAL

CRANKSHAFT

ALBERO MOTORE

VILEBREQUIN

PARTES DE CIGÜEÑAL

CRANKSHAFT PARTS

PARTE ALBERO MOTORE

PARTIES DE VILEBREQUIN

| | REF | OEM |
|---|----------------|-------------|
| 1 | REC12221-94412 | 12221-94412 |
| 2 | REC12231-94413 | 12231-94413 |
| 3 | REC12232-94412 | 12232-94412 |
| 4 | REC12240-94432 | 12240-94432 |

 DT40C-W-G-X (1986-99)
 DTW-K1-K4 (2001-04)

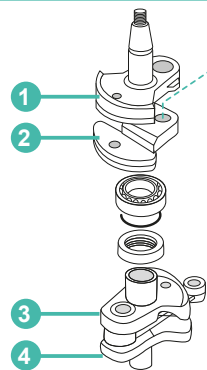



RODAMIENTOS DE CIGÜEÑAL

CRANKSHAFT BEARINGS

CUSCINETTI ALBERO MOTORE ROULEMENTS VILEBREQUIN

| REF | OEM | |
|----------------|-------------|-----------------|
| REC09262-25078 | 09262-25078 | 25 x 25 x 15 mm |



 DT9.9K, DT15K-G-Y (1986-00)
 DT9.9, DT15K1-K4 (2001-04)

| REF | OEM | |
|----------------|-------------|-----------------|
| REC09269-30012 | 09269-30012 | 30 x 72 x 19 mm |



 DT40X-W-G-X (1986-99)
 DT40WK1-K4 (2001-04)
 DT55, DT65J-X (1988-99)
 DT75, DT85J-Y (1988-00)

| REF | OEM | |
|----------------|-------------|-----------------|
| REC09262-30055 | 09262-30055 | 30 x 72 x 19 mm |



 DT20, DT25, DT30G-Y (1986-00)
 DT25, DT30K1-K2 (2001-04)
 DT75, DT85J-Y (1988-00)

| BIELAS | CONNECTING ROD | BIELLA | BIELLE | | | | | | | | | | | | | | | | |
|---|---|-------------------|----------------------|-------------|---|--|---|---|-----|---|----------------|-------------|---|---|----------------|-------------|---|--|--|
| <table border="1"> <thead> <tr> <th>REF</th> <th>OEM</th> </tr> </thead> <tbody> <tr> <td>REC12161-93902</td> <td>12161-93902</td> </tr> <tr> <td></td> <td>DT9.9K, DT15K-G-Y (1986-00) DT9.9, DT15K1-K4 (2001-04) DT15C (1989-97)</td> </tr> </tbody> </table>  | REF | OEM | REC12161-93902 | 12161-93902 |  | DT9.9K, DT15K-G-Y (1986-00) DT9.9, DT15K1-K4 (2001-04) DT15C (1989-97) | | <table border="1"> <thead> <tr> <th>REF</th> <th>OEM</th> </tr> </thead> <tbody> <tr> <td>REC12161-94400</td> <td>12161-94400</td> </tr> <tr> <td></td> <td>DT40C-W-G-Y (1986-99) DT40W K1-K4 (2001-04) DT55, DT65J-X (1988-99)</td> </tr> </tbody> </table>  | REF | OEM | REC12161-94400 | 12161-94400 |  | DT40C-W-G-Y (1986-99) DT40W K1-K4 (2001-04) DT55, DT65J-X (1988-99) | | | | | |
| REF | OEM | | | | | | | | | | | | | | | | | | |
| REC12161-93902 | 12161-93902 | | | | | | | | | | | | | | | | | | |
|  | DT9.9K, DT15K-G-Y (1986-00) DT9.9, DT15K1-K4 (2001-04) DT15C (1989-97) | | | | | | | | | | | | | | | | | | |
| REF | OEM | | | | | | | | | | | | | | | | | | |
| REC12161-94400 | 12161-94400 | | | | | | | | | | | | | | | | | | |
|  | DT40C-W-G-Y (1986-99) DT40W K1-K4 (2001-04) DT55, DT65J-X (1988-99) | | | | | | | | | | | | | | | | | | |
| <table border="1"> <thead> <tr> <th>REF</th> <th>OEM</th> </tr> </thead> <tbody> <tr> <td>REC12161-96300</td> <td>12161-96300</td> </tr> <tr> <td></td> <td>DT20, DT25, DT30G-Y (1986-00) DT25, DT30K1-K2 (2001-02)</td> </tr> </tbody> </table>  | REF | OEM | REC12161-96300 | 12161-96300 |  | DT20, DT25, DT30G-Y (1986-00) DT25, DT30K1-K2 (2001-02) | | | | | | | | | | | | | |
| REF | OEM | | | | | | | | | | | | | | | | | | |
| REC12161-96300 | 12161-96300 | | | | | | | | | | | | | | | | | | |
|  | DT20, DT25, DT30G-Y (1986-00) DT25, DT30K1-K2 (2001-02) | | | | | | | | | | | | | | | | | | |
| ARANDELAS DE BIELA | CONNECTING ROD, THRUST WASHER | RONDELLE BIELLA | RONDELLE DE BIELLE | | | | | | | | | | | | | | | | |
| <table border="1"> <thead> <tr> <th>REF</th> <th>OEM</th> </tr> </thead> <tbody> <tr> <td>REC09160-27008</td> <td>09160-27008</td> </tr> <tr> <td></td> <td>DT35 (1987-89) DT40 (1986-98) DT55 (1985-97) DT65 (1985-97)</td> </tr> </tbody> </table>  | REF | OEM | REC09160-27008 | 09160-27008 |  | DT35 (1987-89) DT40 (1986-98) DT55 (1985-97) DT65 (1985-97) | | <table border="1"> <thead> <tr> <th>REF</th> <th>OEM</th> </tr> </thead> <tbody> <tr> <td>REC09181-24001</td> <td>09181-24001</td> </tr> <tr> <td></td> <td>DT20, DT25, DT30G-Y (1986-00) DT25, DT30K1-K2 (2001-02)</td> </tr> </tbody> </table>  | REF | OEM | REC09181-24001 | 09181-24001 |  | DT20, DT25, DT30G-Y (1986-00) DT25, DT30K1-K2 (2001-02) | | | | | |
| REF | OEM | | | | | | | | | | | | | | | | | | |
| REC09160-27008 | 09160-27008 | | | | | | | | | | | | | | | | | | |
|  | DT35 (1987-89) DT40 (1986-98) DT55 (1985-97) DT65 (1985-97) | | | | | | | | | | | | | | | | | | |
| REF | OEM | | | | | | | | | | | | | | | | | | |
| REC09181-24001 | 09181-24001 | | | | | | | | | | | | | | | | | | |
|  | DT20, DT25, DT30G-Y (1986-00) DT25, DT30K1-K2 (2001-02) | | | | | | | | | | | | | | | | | | |
| <table border="1"> <thead> <tr> <th>REF</th> <th>OEM</th> </tr> </thead> <tbody> <tr> <td>REC09160-20052</td> <td>09160-20052</td> </tr> <tr> <td></td> <td>DT15C (1989-97) DT9.9, DT15K1-K4 (2001-04) DT9.9K, DT15K-G-Y (1986-00)</td> </tr> </tbody> </table>  | REF | OEM | REC09160-20052 | 09160-20052 |  | DT15C (1989-97) DT9.9, DT15K1-K4 (2001-04) DT9.9K, DT15K-G-Y (1986-00) | | | | | | | | | | | | | |
| REF | OEM | | | | | | | | | | | | | | | | | | |
| REC09160-20052 | 09160-20052 | | | | | | | | | | | | | | | | | | |
|  | DT15C (1989-97) DT9.9, DT15K1-K4 (2001-04) DT9.9K, DT15K-G-Y (1986-00) | | | | | | | | | | | | | | | | | | |
| COJINETES DE BIELA | CONNECTING ROD, BEARINGS | CUSCINETTI BIELLA | ROULEMENTS DE BIELLE | | | | | | | | | | | | | | | | |
| <table border="1"> <thead> <tr> <th>1</th> <th>REF</th> <th>OEM</th> </tr> </thead> <tbody> <tr> <td></td> <td>REC09263-14022</td> <td>09263-14022</td> </tr> <tr> <td></td> <td>DT9.9K, DT15K G-Y (1986-00) DT9.9, DT15K1-K4 (2001-04)</td> </tr> </tbody> </table>  | 1 | REF | OEM | | REC09263-14022 | 09263-14022 |  | DT9.9K, DT15K G-Y (1986-00) DT9.9, DT15K1-K4 (2001-04) | | <table border="1"> <thead> <tr> <th>2</th> <th>REF</th> <th>OEM</th> </tr> </thead> <tbody> <tr> <td></td> <td>REC09263-20051</td> <td>09263-20051</td> </tr> <tr> <td></td> <td>DT15C (1989-97) DT9.9, DT15K1-K4 (2001-04) DT9.9K, DT15K-G-Y (1986-00)</td> </tr> </tbody> </table>  | 2 | REF | OEM | | REC09263-20051 | 09263-20051 |  | DT15C (1989-97) DT9.9, DT15K1-K4 (2001-04) DT9.9K, DT15K-G-Y (1986-00) | |
| 1 | REF | OEM | | | | | | | | | | | | | | | | | |
| | REC09263-14022 | 09263-14022 | | | | | | | | | | | | | | | | | |
|  | DT9.9K, DT15K G-Y (1986-00) DT9.9, DT15K1-K4 (2001-04) | | | | | | | | | | | | | | | | | | |
| 2 | REF | OEM | | | | | | | | | | | | | | | | | |
| | REC09263-20051 | 09263-20051 | | | | | | | | | | | | | | | | | |
|  | DT15C (1989-97) DT9.9, DT15K1-K4 (2001-04) DT9.9K, DT15K-G-Y (1986-00) | | | | | | | | | | | | | | | | | | |
| <table border="1"> <thead> <tr> <th>1</th> <th>REF</th> <th>OEM</th> </tr> </thead> <tbody> <tr> <td></td> <td>REC09263-18016</td> <td>09263-14022</td> </tr> <tr> <td></td> <td>DT25 (1983-88) DT30 (1983-88)</td> </tr> </tbody> </table>  | 1 | REF | OEM | | REC09263-18016 | 09263-14022 |  | DT25 (1983-88) DT30 (1983-88) | | <table border="1"> <thead> <tr> <th>2</th> <th>REF</th> <th>OEM</th> </tr> </thead> <tbody> <tr> <td></td> <td>REC09263-20051</td> <td>09263-20051</td> </tr> <tr> <td></td> <td>DT15C (1989-97) DT9.9, DT15K1-K4 (2001-04) DT9.9K, DT15K-G-Y (1986-00)</td> </tr> </tbody> </table>  | 2 | REF | OEM | | REC09263-20051 | 09263-20051 |  | DT15C (1989-97) DT9.9, DT15K1-K4 (2001-04) DT9.9K, DT15K-G-Y (1986-00) | |
| 1 | REF | OEM | | | | | | | | | | | | | | | | | |
| | REC09263-18016 | 09263-14022 | | | | | | | | | | | | | | | | | |
|  | DT25 (1983-88) DT30 (1983-88) | | | | | | | | | | | | | | | | | | |
| 2 | REF | OEM | | | | | | | | | | | | | | | | | |
| | REC09263-20051 | 09263-20051 | | | | | | | | | | | | | | | | | |
|  | DT15C (1989-97) DT9.9, DT15K1-K4 (2001-04) DT9.9K, DT15K-G-Y (1986-00) | | | | | | | | | | | | | | | | | | |
| <table border="1"> <thead> <tr> <th>1</th> <th>REF</th> <th>OEM</th> </tr> </thead> <tbody> <tr> <td></td> <td>REC09263-20072</td> <td>09263-20072</td> </tr> <tr> <td></td> <td>DT40C-W-G-X (1986-99) DT40W K1-K4 (2001-04) DT55, DT65J-X (1988-99) DT90, DT100L-Y (1990-00)</td> </tr> </tbody> </table>  | 1 | REF | OEM | | REC09263-20072 | 09263-20072 |  | DT40C-W-G-X (1986-99) DT40W K1-K4 (2001-04) DT55, DT65J-X (1988-99) DT90, DT100L-Y (1990-00) | | <table border="1"> <thead> <tr> <th>2</th> <th>REF</th> <th>OEM</th> </tr> </thead> <tbody> <tr> <td></td> <td>REC09263-27005</td> <td>09263-27005</td> </tr> <tr> <td></td> <td>DT40C-W-G-X (1986-99) DT40W K1-K4 (2001-04) DT55, DT65J-X (1988-99)</td> </tr> </tbody> </table>  | 2 | REF | OEM | | REC09263-27005 | 09263-27005 |  | DT40C-W-G-X (1986-99) DT40W K1-K4 (2001-04) DT55, DT65J-X (1988-99) | |
| 1 | REF | OEM | | | | | | | | | | | | | | | | | |
| | REC09263-20072 | 09263-20072 | | | | | | | | | | | | | | | | | |
|  | DT40C-W-G-X (1986-99) DT40W K1-K4 (2001-04) DT55, DT65J-X (1988-99) DT90, DT100L-Y (1990-00) | | | | | | | | | | | | | | | | | | |
| 2 | REF | OEM | | | | | | | | | | | | | | | | | |
| | REC09263-27005 | 09263-27005 | | | | | | | | | | | | | | | | | |
|  | DT40C-W-G-X (1986-99) DT40W K1-K4 (2001-04) DT55, DT65J-X (1988-99) | | | | | | | | | | | | | | | | | | |
| <table border="1"> <thead> <tr> <th>1</th> <th>REF</th> <th>OEM</th> </tr> </thead> <tbody> <tr> <td></td> <td>REC09263-24018</td> <td>09263-24018</td> </tr> <tr> <td></td> <td>DF20 (1986-88) DT25 (1983-88) DT30 (1983-85) DT40 (1984-85) DT50 (1984+)</td> </tr> </tbody> </table>  | 1 | REF | OEM | | REC09263-24018 | 09263-24018 |  | DF20 (1986-88) DT25 (1983-88) DT30 (1983-85) DT40 (1984-85) DT50 (1984+) | | | | | | | | | | | |
| 1 | REF | OEM | | | | | | | | | | | | | | | | | |
| | REC09263-24018 | 09263-24018 | | | | | | | | | | | | | | | | | |
|  | DF20 (1986-88) DT25 (1983-88) DT30 (1983-85) DT40 (1984-85) DT50 (1984+) | | | | | | | | | | | | | | | | | | |



PISTONES

PISTONS

PISTONI

PISTONS

KITS DE PISTONES

PISTON KITS

KIT PISTONE

KIT PISTON

| | STD | |
|--|-----------------|-------------|
| | REF | OEM |
| | REC12110-93130K | 12110-93130 |
| | REC12140-93121 | 12140-93121 |
| | REC09263-14022 | 09263-14014 |



DT9.9, DT15K-G-Y (1986-00)
DT9.9, DT15K1-K4 (2001-04)

| | STD | |
|--|-----------------|--------------|
| | REF | OEM |
| | REC12110-94400K | 12110-94400K |
| | REC12140-94400 | 12140-94400 |
| | REC09263-20072 | 09263-20072 |



DT40C-W-G-X (1986-99)
DT40W-K1-K4 (2001-04)

| | STD | |
|--|-----------------|-------------|
| | REF | OEM |
| | REC12110-94350K | 12110-94350 |



DT35 (1980-82)
DT40 (1980-82)

GUÍA CORREAS DE DISTRIBUCIÓN

GUIDE TIMING BELT

GUIDA CINGHIE DISTRIBUZIONE

GUIDE DES COURROIES DE DISTRIBUTION

| | | | REF | | OEM | |
|--|------------------------------|---------|-----|----------------|-------------|--|
| | | | | | | |
| | DF8A, DF8AR, DF9.9A, DF9.9AR | 2010+ | 66 | REC12761-99J00 | 12761-99J00 | |
| | DF15 | 2012 | 69 | REC12761-93ELO | 12761-93ELO | |
| | DF9.9, DF15T-K3 | 1996-03 | 69 | REC12761-93ELO | 12761-93ELO | |
| | DF9.9, DF15 R | 2004-11 | 69 | REC12761-93ELO | 12761-93ELO | |
| | DF9.9B, DF15A | 2013+ | 69 | REC12761-93ELO | 12761-93ELO | |
| | DF60, DF70 W-K9 | 1998-09 | 89 | REC12761-72F00 | 12761-72F00 | |

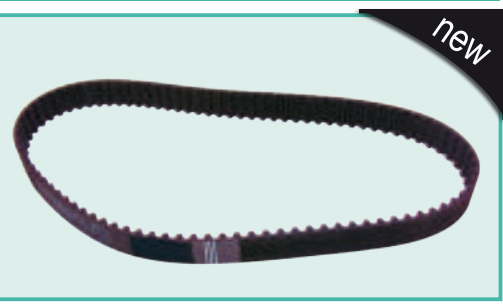

SISTEMA DE ESCAPE Y ADMISIÓN EXHAUST & INTAKE SYSTEM

SISTEMA DI SCARICO E ASPIRAZIONE SYSTÈME D'ÉCHAPPEMENT ET D'ADMISSION

4T
STROKES

| SISTEMA DE ESCAPE 4 TIEMPOS | EXHAUST SYSTEM 4 STROKES | SISTEMA SCARICO 4 TEMPI | SYSTÈME D'ÉCHAPPEMENT 4 TEMPS |
|-----------------------------|--------------------------|-------------------------------|-------------------------------|
| JUNTAS COLECTOR | GASKET, COLLECTOR | GUARNIZIONE COLLETTORE | JOINT DE COLLECTEUR |

| REF | OEM |
|---|--------------------------------------|
| REC13147-98J00 | 13147-98J00 |
|  | DF300AP (2012) DF300T/Z (2007-11) |

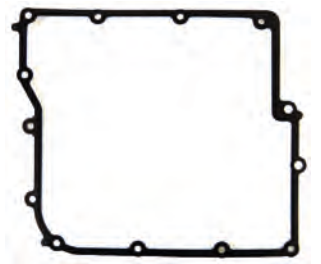

4T
STROKES

| JUNTAS CARTER | OIL PAN GASKET | GUARNIZIONE CARTER | JOINTS DE CARTER |
|---------------|----------------|--------------------|------------------|
|---------------|----------------|--------------------|------------------|

| REF | OEM |
|---|---|
| REC11489-90J00 | 11489-90J00 |
|  | DF90, DF100, DF115 K1-K11 (2001-11) DF140 (2002-12) DF115WT, DF140WT-K3 (2003) DF100A, DF115A 7, DF140 (2013+) |

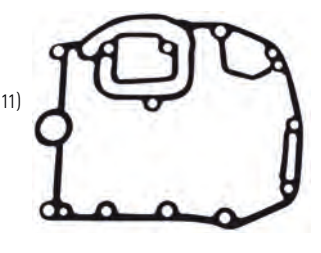

| REF | OEM |
|---|-------------------------------------|
| REC11489-87L00 | 11489-87L00 |
|  | DF70A, DF80A, DF90A, DF100B (2009+) |



| REF | OEM |
|---|--|
| REC11489-93E11 | 11489-93E10 |
|  | DF9.9, DF15 (R) (2004-11) DF15 (2012) |



| REF | OEM |
|---|----------------------|
| REC11489-87J00 | 11489-87J00 |
|  | DF40, DF50 (1999-10) |

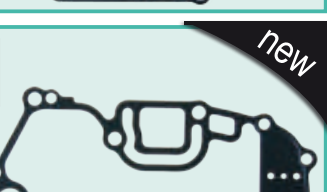

| REF | OEM |
|---|---|
| REC11489-93J00 | 11489-93J00 |
|  | DF200, DF225, DF250 (2004+) DF300AP (2012) DF300T-Z (2007-11) |

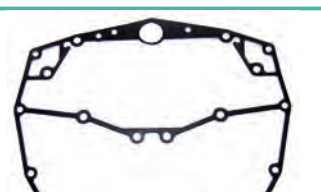

4T
STROKES

| JUNTA MÚLTIPLE DE ESCAPE | MULTI EXHAUST GASKET | GUARNIZIONE SCARICO MULTIPLO | JOINT DE PIPE D'ÉCHAPPEMENT |
|--------------------------|----------------------|------------------------------|-----------------------------|
|--------------------------|----------------------|------------------------------|-----------------------------|

| REF | OEM |
|---|-------------------------------------|
| REC11542-87L00 | 11542-87L00 |
|  | DF70A, DF80A, DF90A, DF100B (2009+) |

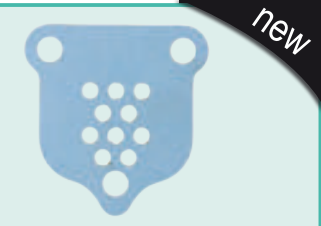

SUZUKI

RECAMBIOS MARINOS

SISTEMA DE ADMISION 4 TIEMPOS

INTAKE SYSTEM 4 STROKES

SISTEMA ASPIRAZIONE 4 TEMPI

SYSTEME D'ADMISSION 4 TEMPS

4T
STROKES

JUNTAS COLECTOR

GASKET, COLLECTOR

GUARNIZIONE COLLETTORE

JOINT DE COLLECTEUR

| REF | OEM |
|---|----------------------------------|
| REC13122-95J00 | 13122-95J00 |
|  | DF20R, DF25, DF25R V2 (2006 -11) |



| REF | OEM |
|---|-----------------------------|
| REC13119-93J00 | 13119-93J00 |
|  | DF200, DF225, DF250 (2004+) |



4T
STROKES

JUNTA TAPA ESCAPE

GASKET EXHAUST COVER

GUARNIZIONE COPERCHIO SCARICO

JOINT DE COUVERCLE D'ECHAPPEMENT

| REF | OEM |
|---|---|
| REC14212-93J00 | 14212-93J00 |
|  | DF200, DF225, DF250 (2004+) DF300AP (2012) DF300T/Z (2007-11) |



| REF | OEM |
|---|-----------------------------|
| REC52331-87L00 | 52331-87L00 |
|  | DF70A, DF80A, DF90A (2009+) |



| REF | OEM | |
|---|---|-----------------------------------|
| REC14152-93J00 | 14152-93J00 | BABOR PORT BABORDO GAUCHE |
| REC14151-93J00 | 14151-93J00 | ESTRIBOR STD TRIBORDO DROIT |
|  | DF200, DF225, DF250 (2004+) DF300AP (2015) DF300T/Z (2007-11) | |

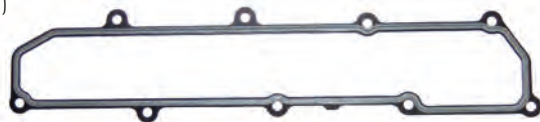

REC14151-93J00



REC14152-93J00

| REF | OEM |
|---|-------------------------------------|
| REC14151-87L00 | 14151-87L00 |
|  | DF70A, DF80A, DF90A, DF100B (2009+) |



new

SISTEMA DE ESCAPE 2 TIEMPOS

EXHAUST SYSTEM 2 STROKES

SISTEMA SCARICO 2 TEMPI

SYSTÈME D'ÉCHAPPEMENT 2 TEMPS

2T
STROKES

JUNTAS DE ESCAPE

GASKET, EXHAUST

GUARNIZIONE SCARICO

JOINTS D'ÉCHAPPEMENT

| REF | OEM |
|---|-----------------------|
| REC14212-94413 | 14212-94412 |
|  | DT40C-W-G-X (1986-99) |



| REF | OEM |
|---|--|
| REC52113-93910 | 52113-93901 |
|  | DT9.9, DT15 K1-K4 (2001-04) DT9.9K, DT15K-G-Y (1986-00) |

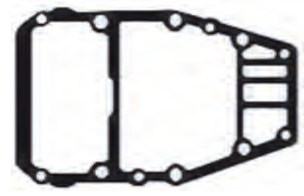

| REF | OEM |
|---|--|
| REC52113-96330 | 52113-96304 |
|  | DT20, DT25, DT30G-Y (1986-00) DT25, DT30K1-K4 (2001-02) |

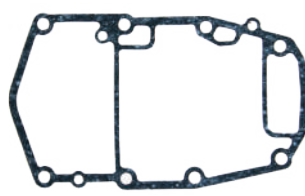

| REF | OEM |
|---|---|
| REC14151-96311 | 14151-96310 |
|  | DT20, DT25, DT30G-Y (1986-00) DT25, DT30 K1-K2 (2001-02) |

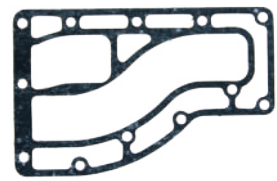

| REF | OEM |
|---|--|
| REC14151-93912 | 14151-93901 |
|  | DT9.9, DT15 K1-K4 (2001-04) DT9.9K, DT15K-G-Y (1986-00) |

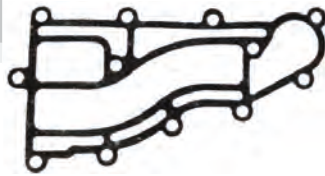

| REF | OEM |
|---|--|
| REC11434-94411 | 11434-94411 |
|  | DT40C-W-G-X (1986-99) DT40W K1-K4 (2001-04) |

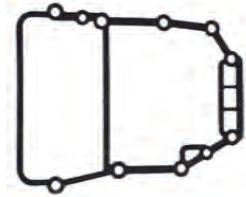

| REF | OEM |
|---|--|
| REC14151-94411 | 14151-94412 |
|  | DT40C-W-G-X (1986-99) DT40W K1-K4 (2001-04) |

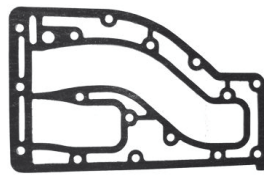

2T
STROKES

JUNTAS TAPA DE ESCAPE

GASKET, EXHAUST COVER

GUARNIZIONE COPERTURA SCARICO

JOINTS DE PLAQUE D'ÉCHAPPEMENT

| REF | OEM |
|---|--|
| REC14141-93952-0EP | 14141-93952-0EP |
|  | DT9.9, DT15 K1-K4 (2001-04) DT9.9K, DT15K G-Y (1986-00) |



2T
STROKES

JUNTAS TUBO DE ESCAPE

GASKET, EXHAUST TUBE

GUARNIZIONE TUBO DI SCARICO

JOINT TUBE D'ÉCHAPPEMENT

| REF | OEM |
|---|--|
| REC14212-91L00 | 14212-91L00 14212-96310 |
|  | DT20, DT25, DT30 G-Y (1986-00) DT25, DT30 K1-K2 (2001-02) |

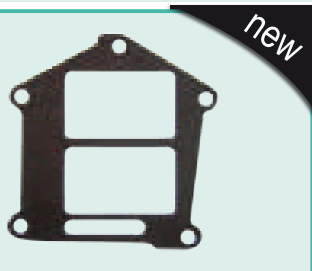

UNIDADES DE TRANSMISIÓN UNIT DRIVES & COMPONENTS

UNITÀ DI TRASMISSIONE EMBASSES ET PIÈCES

DESPIECE COLAS
4 TIEMPOS

GEAR CASE PARTS
4 STROKES

PARTI PIEDI
DE 4 TEMPI

PIÈCES D'EMBASSES
4 TEMPS

4T
STROKES
DF4, DF5, DF6

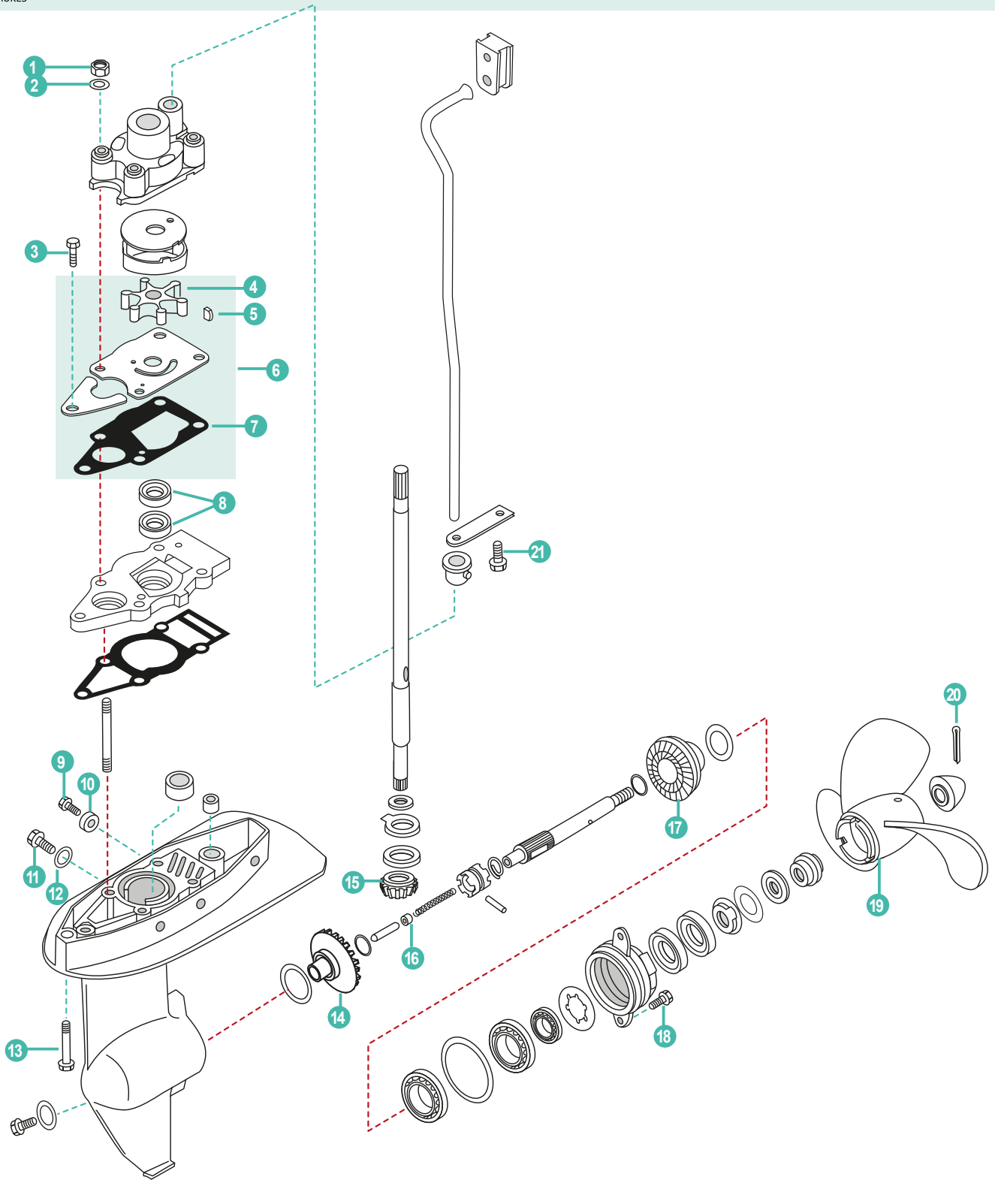

SUZUKI

RECAMBIOS
MARINOS

| | REF | OEM | | | | |
|----|------------------|-----------------|--------------------------|----------------------------|---------------------------|-------------------------|
| 1 | PAGB/T6170-M6 | 29141-93J00 | TUERCA HEXÁGONO M6 | NUT HEXAGON M6 | DADO ESAGONALE M6 | ECROU HEXAGONAL M6 |
| 2 | PAGB/T848-6 | 09160-06082 | ARANDELA | WASHER | RONDELLA | RONDELLE |
| 3 | PAGB/T5283-M6X25 | 09116-06229 | TORNILLO HEXAGONAL M6x25 | HEXAGON BOLT M6x25 | BULLONE ESAGONALE M6x25 | BOULON HEXAGONAL M6x25 |
| 4 | REC17461-98503 | 17461-985M0 | IMPULSOR | IMPELLER | GIRANTE | TURBINE |
| 5 | REC09420-03002 | 09420-03002 | CHAVETA IMPELLER | KEY | CHIUSSURA | CLAVETTE TURBINE |
| 6 | REC17400-98661 | 17400-98661 | KIT BOMBA AGUA | WATER PUMP KIT | KIT POMPA ACQUA | KIT POMPE À EAU |
| 7 | REC17472-91J00 | 17472-91J00 | JUNTA DE LA BOMBA | GASKET PUMPCASE | GUARNIZIONE POMPA | JOINT DE POMPE |
| 8 | REC09282-10008 | 09282-10008 | RETÉN ACEITE | OIL SEAL | PARAOLIO | JOINT SPI |
| 9 | PAGB/T5783-M6X14 | 09103-06281 | TORNILLO HEXAGONAL M6x14 | HEXAGON BOLT M6x14 | BULLONE ESAGONALE M6x14 | BOULON HEXAGONAL M6x14 |
| 10 | CM55321-87J00 | 55321-87J00 | ÁNODO | ANODE | ANODO | ANODE |
| 11 | REC09248-10008 | 09248-10008 | TORNILLO 10x7,5 | SCREW 10x7,5 | VITE 10x7,5 | VIS 10x7,5 |
| 12 | REC09168-10022 | 09168-10022 | ARANDELA TAPÓN | CAP, O-RING | RONDELLA TAPPO | JOINT DE VIDANGE |
| 13 | PAGB/T5787-1986 | 09116-08156 | TORNILLO HEXAGONAL M8x50 | HEXAGON BOLT M8x50 | BULLONE ESAGONALE M8x50 | BOULON HEXAGONAL M8x50 |
| 14 | REC57510-91J00 | 57510-91J00 | PIÑÓN MARCHA AVANTE | FORWARD GEAR | INGRANAGGIO MARCIA AVANTI | PIGNON MARCHE AV |
| 15 | REC57311-98600 | 57311-91J00 | PIÑÓN ATAQUE | INITIATIVE GEAR | PIGNONE | PIGNON D'ATTAQUE |
| 16 | REC57632-97L00 | 57632-98501 | PIN SELECTOR | SELECTOR PIN | PIN SELETTORE | CLAVETTE |
| 17 | REC57521-91J00 | 57521-91J00 | PIÑÓN MARCHA ATRÁS | RESERVE GEAR | PIGNONE MARCIA INDIETRO | PIGNON MARCHE AR |
| 18 | PAGB/T5783-M6X16 | 09116-06225 | TORNILLO HEXAGONAL M6x16 | HEXAGON BOLT M6x16 | BULLONE ESAGONALE M6x16 | BOULON HEXAGONAL M6x16 |
| 19 | SOL4011-079-075 | 58110-91JN0-019 | HÉLICE AMITA 3 7.9x6.75 | PROPELLER AMITA 3 7.9x6.75 | ELICA AMITA 3 7.9x6.75 | HELICE AMITA 3 7.9x6.75 |
| 20 | REC91490-40030 | 09204-03003 | PASADOR | PIN | FERMO | GOUPILLE |
| 21 | PAGB/T5783-M6X16 | 09116-06225 | TORNILLO HEXAGONAL M6x16 | HEXAGON BOLT M6x16 | BULLONE ESAGONALE M6x16 | BOULON HEXAGONAL M6x16 |



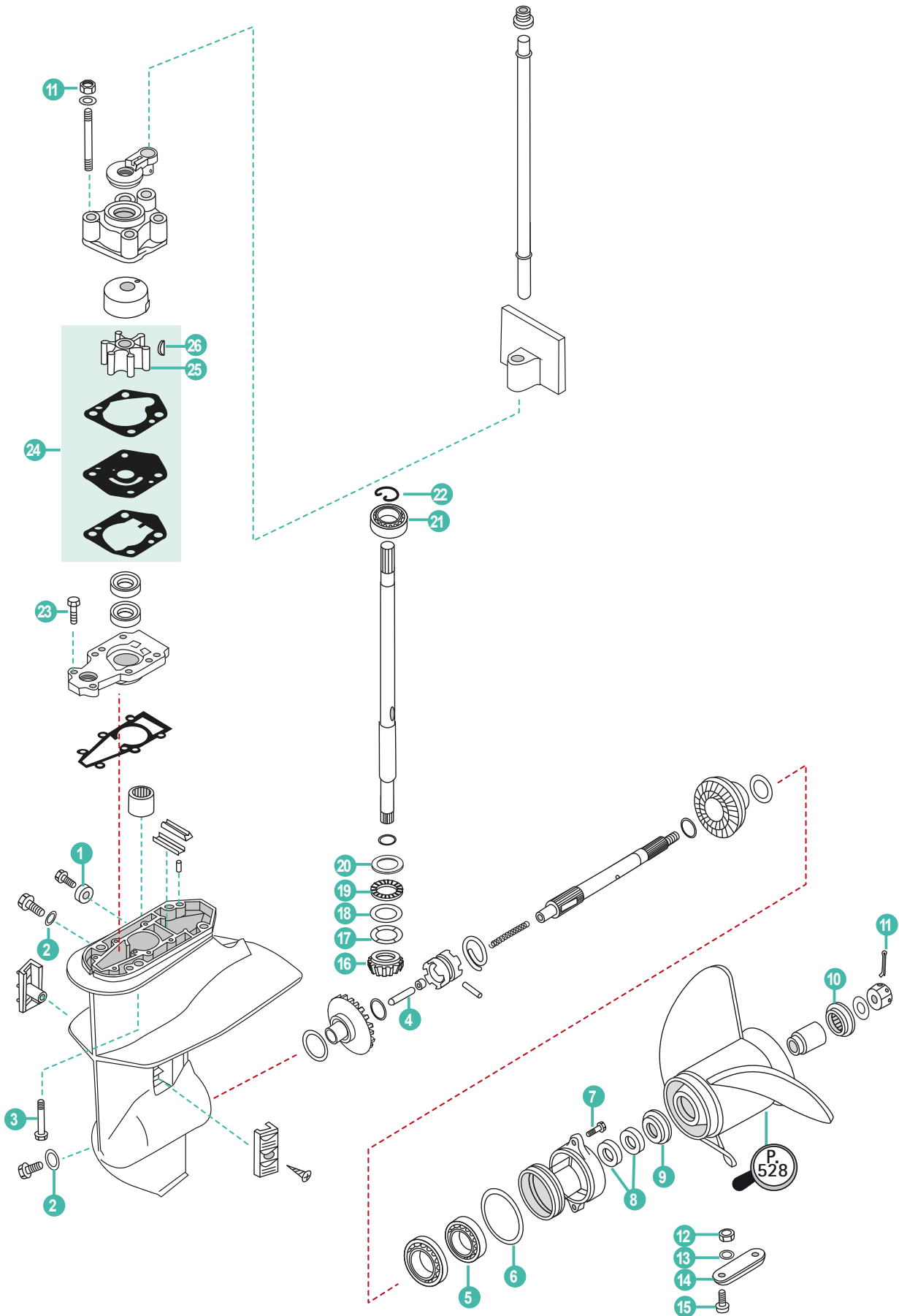

| | REF | OEM | | | | |
|----|------------------|-------------|--------------------|-------------------|-----------------------|--------------------|
| 1 | CM55321-87J00 | 55321-87J01 | ÁNODO | ANODE | ANODO | ANODE |
| 2 | REC59178-97J00 | 59178-97J00 | JUNTA DRENAJE COLA | DRAIN PLUG GASKET | GUARNIZIONE DRENAGGIO | JOINT DE VIDANGE |
| 3 | PAGB/T5783-M8X30 | 09116-08151 | PERNO M8x30 | BOLT M8x30 | BULLONE M8x30 | BOULON M8x30 |
| 4 | REC57631-93901 | 57631-93901 | VARILLA SELECTOR | ROD PUSH | ASTA SELETTORE | CLAVETTE |
| 5 | REC08110-60050 | 08110-60050 | RODAMIENTO | BEARING | CUSCINETTO | ROULEMENT |
| 6 | REC09280-57002 | 09280-57002 | ARO TORICO | O-RING | O-RING | JOINT TORIQUE |
| 7 | PAGB/T5787-M6X20 | 09116-06227 | TORNILLO | BOLT, FLANGE | VITE | VIS DE BRIDE |
| 8 | REC09289-17006 | 09289-17L02 | RETÉN ACEITE | OIL SEAL | PARAOLIO | JOINT SPI |
| 9 | REC57632-94J00 | 57632-94J00 | SEPARADOR HELICE | PROPELLER WASHER | DISTANZIALE ELICA | RONDELLE HÉLICE |
| 10 | REC57633-93901 | 57633-93901 | SEPARADOR | SPACER | DISTANZIALE | ENTRETOISE |
| 11 | REC09204-02004 | 09204-02004 | PIN BLOQUEADOR | COTTER PIN | COPPIGLIA | GOUPILLE |
| 12 | PAGB/T6170-M6 | 29141-93J00 | TUERCA HEXÁGONO M6 | NUT HEXAGON M6 | DADO ESAGONALE M6 | ECROU HEXAGONAL M6 |
| 13 | PAGB/T93-6 | 29162-93J00 | ARANDELA MUELLE 6 | WASHER SPRING 6 | RONDELLA MOLLA 6 | RESSORT 6 |
| 14 | CM55300-95500 | 55300-95500 | ÁNODO | ANODE | ANODO | ANODE |
| 15 | PAGB/T820-M6X20 | 09126-06006 | TORNILLO M6x20 | SCREW M6x20 | VITE M6x20 | VIS M6x20 |
| 16 | REC57311-99J10 | 57311-99J10 | PIÑÓN ATAQUE | INITIATIVE GEAR | PIGNONE | PIGNON D'ATTAQUE |
| | REC09160-20042 | 09160-20042 | GRUESO 1.10 | SHIM 1.10 | SPESSORE 1.10 | CALE 1.10 |
| 17 | REC09160-20043 | 09160-20043 | GRUESO 1.20 | SHIM 1.20 | SPESSORE 1.20 | CALE 1.20 |
| | REC09160-20044 | 09160-20044 | GRUESO 1.30 | SHIM 1.30 | SPESSORE 1.30 | CALE 1.30 |
| 18 | REC09160-20027 | 09160-20027 | ARANDELA PIÑÓN | WASHER GEAR | RONDELLA PIGNONE | RONDELLE DE PIGNON |
| 19 | REC09263-20L04 | 09263-20024 | RODAMIENTO | BEARING | CUSCINETTO | ROUEMENT |
| 20 | REC09160-21009 | 09160-21009 | ARANDELA PIÑÓN | WASHER GEAR | RONDELLA PIGNONE | RONDELLE DE PIGNON |
| 21 | REC08110-60020 | 08110-60020 | RODAMIENTO | BEARING | CUSCINETTO | ROULEMENT |
| 22 | REC09380-15001 | 09380-15001 | CIRCLIP | CLIP | CERCLIP | CLIPS |
| 23 | REC09116-06121 | 09116-06229 | TORNILLO | BOLT | VITE | VIS |
| 24 | REC17400-99J01 | 17400-99J01 | KIT BOMBA | PUMP KIT | KIT POMPA | KIT POMPA À EAU |
| 25 | REC17461-93903 | 17461-939M0 | IMPULSOR | IMPELLER | GIRANTE | TURBINE |
| 26 | REC09420-03005 | 09420-03009 | CHAVETA | KEY | CHIAVETTA | CLAVETTE |



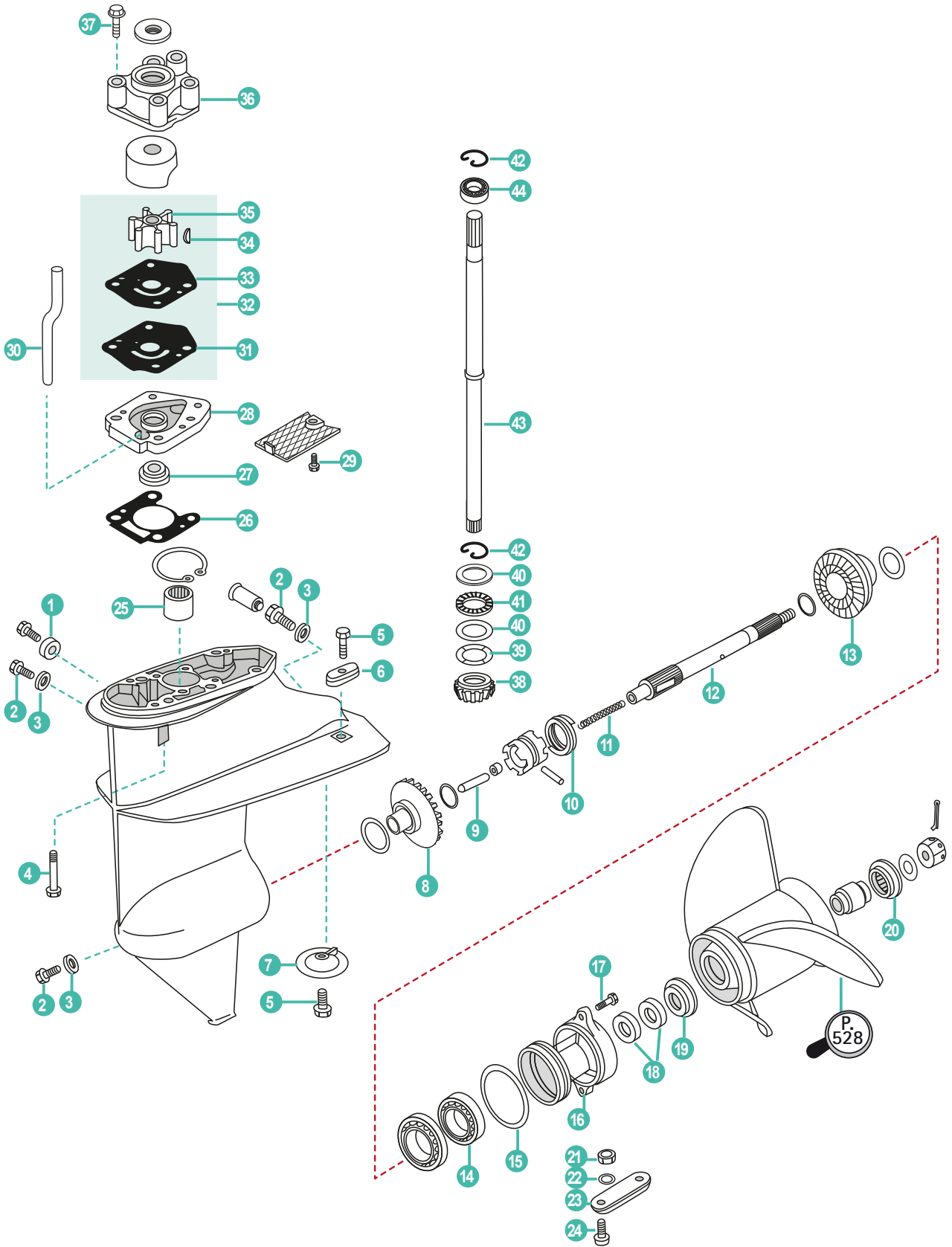

| | REF | OEM | | | | |
|----|------------------|-----------------|--------------------------|------------------------|-----------------------------|-----------------------|
| 1 | CM55321-87J00 | 55321-87J00 | ÁNODO | ANODE | ANODO | ANODE |
| 2 | REC09248-10008 | 09248-10008 | TORNILLO 10x7,5 | SCREW 10x7,5 | VITE 10x7,5 | VIS 10x7,5 |
| 3 | REC09168-10022 | 09168-10022 | ARANDELA TAPÓN | CAP, O-RING | RONDELLA TAPPO | JOINT DE VIDANGE |
| 4 | PAGB/T5783-M8X30 | 09117-08047 | TORNILLO M8X30 | BOLT M8X30 | BULLONE M8X30 | BOULON M8X30 |
| 5 | REC09116-06094 | 09116-06094 | TORNILLO 6x15 | SCREW 6x15 | VITE 6x15 | VIS 6x15 |
| 6 | CM41811-98500 | 41811-98500 | ÁNODO | ANODE | ANODO | ANODE |
| 7 | CM55321-93900 | 55321-93900 | ÁNODO | ANODE | ANODO | ANODE |
| 8 | REC57510-93910 | 57510-93910 | PIÑÓN MARCHA AVANTE | FORWARD GEAR | INGRANAGGIO MARCIA AVANTI | PIGNON MARCHE AVANT |
| 9 | REC57631-93901 | 67631-93901 | VARILLA SELECTOR | ROD PUSH | ASTA SELETTORE | CLAVETTE |
| 10 | REC09440-32008 | 09440-32008 | MUELLE | CLUTCH | MOLLA | RESSORT |
| 11 | REC09440-05027 | 09440-05027 | MUELLE SELECTOR | SELECTOR SPRING | MOLLA SELETTORE | RESSORT DE SELECTEUR |
| 12 | REC57610-93901 | 57610-93901 | EJE HELICE | PROPELLER SHAFT | ASSE ELICA | ARBRE D'HELICE |
| 13 | REC57521-93910 | 57521-93910 | PIÑÓN MARCHA ATRÁS | REVERSER GEAR | INGRANAGGIO MARCIA INDIETRO | PIGNON MARCHE ARRIÈRE |
| 14 | REC08110-60050 | 08110-60050 | RODAMIENTO | BEARING | CUSCINETTO | ROULEMENT |
| 15 | REC09280-57002 | 09280-57002 | ARO TORICO | O-RING | O-RING | JOINT TORIQUE |
| 16 | REC56120-93900 | 56120-93901-OEP | DIÁBOLO | CARRIER | DIABOLO | DIABOLO |
| 17 | PAGB/T5787-M6X20 | 29116-93J00 | TORNILLO | BOLT, FLANGE | VITE | VIS DE BRIDE |
| 18 | REC09289-17006 | 09289-17006 | RETÉN ACEITE | OIL SEAL | PARAOLIO | JOINT SPI |
| 19 | REC57632-94J00 | 57632-93902 | SEPARADOR HÉLICE | PROPELLER WASHER | DISTANZIALE ELICA | RONDELLE HÉLICE |
| 20 | REC57633-93901 | 57633-93901 | SEPARADOR | SPACER | DISTANZIALE | ENTRETOISE |
| 21 | PAGB/T6170-M6 | 29141-93J00 | TUERCA HEXÁGONAL M6 | HEXAGON NUT M6 | DADO ESAGONALE M6 | ECROU HEXAGONAL M6 |
| 22 | PAGB/T93-6 | 29162-93J00 | ARANDELA MUELLE 6 | SPRING WASHER 6 | RONDELLA MOLLA 6 | RESSORT RONDELLE 6 |
| 23 | CM55300-95500 | 55300-95500 | ÁNODO | ANODE | ANODO | ANODE |
| 24 | PAGB/T820-M6X20 | 09126-06006 | TORNILLO M6x20 | SCREW M6x20 | VITE M6x20 | VIS M6x20 |
| 25 | REC09263-15019 | 09263-15019 | RODAMIENTO | BEARING | CUSCINETTO | ROULEMENT |
| 26 | REC17452-93910 | 17452-93910 | JUNTA COLA | DRIVE GASKET | GUARNIZIONE PIEDE | JOINT D'EMBASE |
| 27 | REC09289-12003 | 09289-12003 | RETÉN | OIL SEAL | PARAOLIO | JOINT SPI |
| 28 | REC17450-93921 | 17450-93921 | CARCASA BOMBA AGUA | PUMP BASE | BASE POMPA ACQUA | CORPS DE POMPE À EAU |
| 29 | PAGB/T818-M6X10 | 09125-06063 | TORNILLO M6x10 | BOLT M6x10 | BULLONE M6x10 | BOULON M6x10 |
| 30 | REC17453-93901 | 17453-93900 | TUBO VACIADO DE AGUA | WATER TUBE | TUBO ACQUA | TUBE VIDANGE D'EAU |
| 31 | REC17472-93911 | 17472-93911 | JUNTA BOMBA AGUA | WATER PUMP GASKET | GUARNIZIONE POMPA ACQUA | JOINT DE POMPE À EAU |
| 32 | REC17400-93951 | 17400-93951 | KIT BOMBA AGUA | WATER PUMP SERVICE KIT | KIT POMPA ACQUA | KIT POMPE À EAU |
| 33 | REC17471-93902 | 17471-93902 | BASE BOMBA AGUA | WATER PUMP PLATE | COPERCHIO GIRANTE | BASE DE POMPE À EAU |
| 34 | REC17462-93990 | 17462-93990 | CHAVETA | KEY | CHIAVETTA | CLAVETTE |
| 35 | REC17461-93903 | 17461-93903 | IMPULSOR | IMPELLER | GIRANTE | TURBINE |
| 36 | REC17411-93901 | 17411-93901 | CUERPO BOMBA AGUA | HOUSING WATER PUMP | CORPO POMPA ACQUA | CORPS DE POMPE À EAU |
| 37 | PAGB/T5783-M8X55 | 09116-08117 | TORNILLO HEXAGONAL M8x55 | BOLT HEXAGON M8x55 | BULLONE ESAGONALE M8x55 | VIS HEXAGONAL M8x55 |
| 38 | REC57311-93910 | 57311-93910 | PIÑÓN ATAQUE | INITIATIVE GEAR | PIGNONE ATTACCO | PIGNON D'ATAQUE |
| | REC09160-20041 | 09160-20041 | GRUESO 1.00 | SHIM 1.00 | SPESSORE 1.00 | CALE 1.00 |
| 39 | REC09160-20042 | 09160-20042 | GRUESO 1.10 | SHIM 1.10 | SPESSORE 1.10 | CALE 1.10 |
| | REC09160-20043 | 09160-20043 | GRUESO 1.20 | SHIM 1.20 | SPESSORE 1.20 | CALE 1.20 |
| | REC09160-20044 | 09160-20044 | GRUESO 1.30 | SHIM 1.30 | SPESSORE 1.30 | CALE 1.30 |
| 40 | REC09160-21009 | 09160-21009 | ARANDELA PIÑÓN | WASHER GEAR | RONDELLA PIGNONE | RONDELLE DE PIGNON |
| 41 | REC09263-20L04 | 09263-20L04 | RODAMIENTO | BEARING | CUSCINETTO | ROULEMENT |
| 42 | REC09380-15001 | 09380-15001 | CIRCLIP | CLIP | CERCLIP | CLIPS |
| 43 | REC57100-93902 | 57100-93902 | EJE VERTICAL | DRIVE SHAFT | ASSE VERTICALE | ARBRE DE TRANSMISSION |
| 44 | REC08110-60020 | 08110-60020 | RODAMIENTO | BEARING | CUSCINETTO | ROULEMENT |



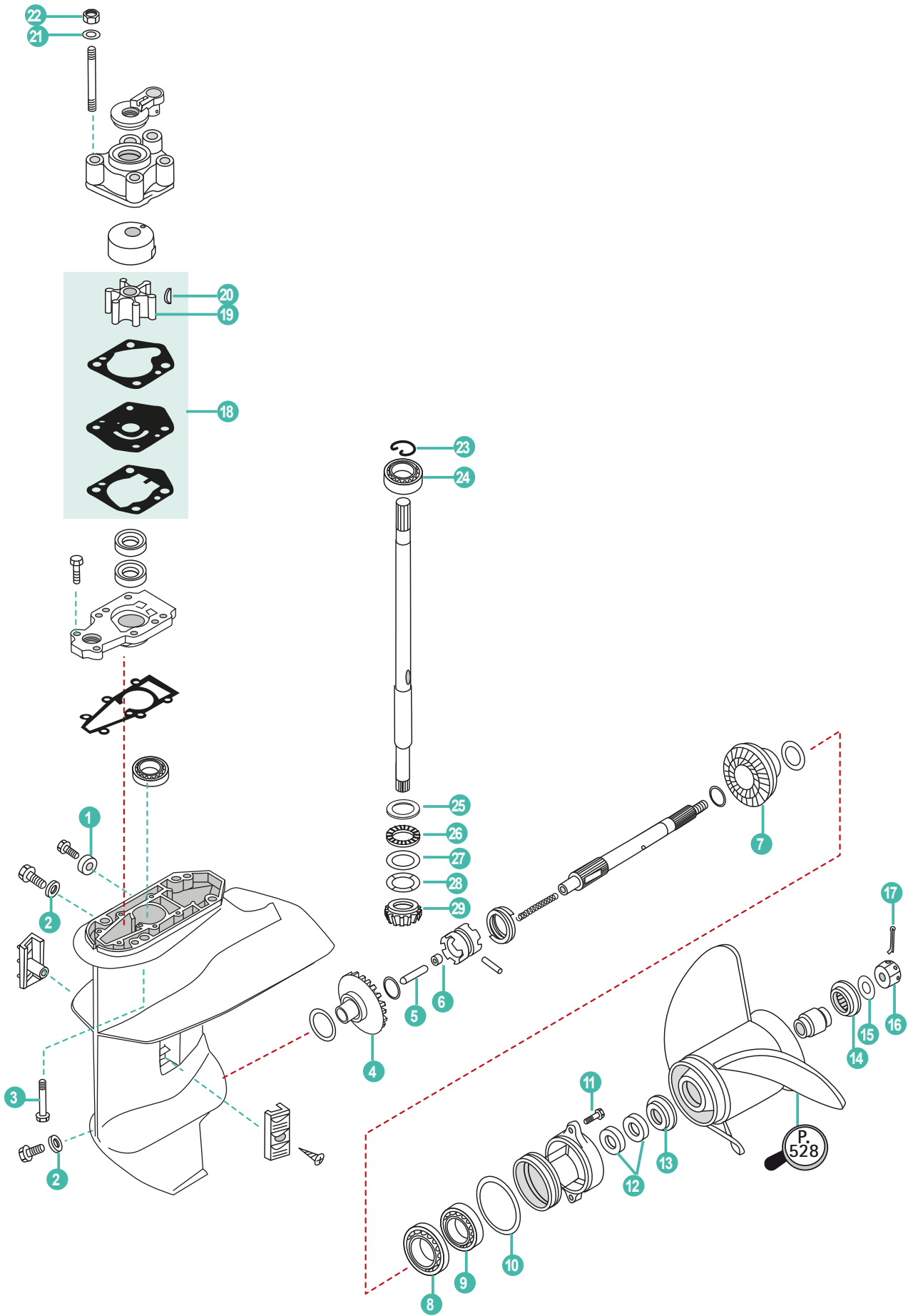

| | REF | OEM | | | | |
|----|------------------|-------------|----------------------------|-------------------------|-------------------------------|--------------------------|
| 1 | CM55321-87J00 | 55321-87J01 | ÁNODO | ANODE | ANODO | ANODE |
| 2 | REC59178-97J00 | 59178-97J00 | JUNTA DRENAJE COLA | DRAIN PLUG GASKET | GUARNIZIONE DRENAGGIO | JOINT DE VIDANGE |
| 3 | PAGB/T5783-M8X30 | 09116-08151 | TORNILLO M8x30 | BOLT M8x30 | BULLONE M8x30 | BOULON M8x30 |
| 4 | REC57510-99J11 | 57510-99J10 | PIÑÓN MARCHA AVANTE | POSITIVE GEAR | PIGNONE MARCIA AVANTI | PIGNON MARCHE AVANT |
| 5 | REC57631-93901 | 57631-93901 | VARILLA SELECTOR | ROD PUSH | ASTA SELETTORE | CLAVETTE |
| 6 | REC57632-97L00 | 57632-97L00 | PIN SELECTOR | SELECTOR PIN | PIN SELETTORE | CLAVETTE |
| 7 | REC57521-99J10 | 57521-99J10 | PIÑÓN MARCHA ATRÁS | REVERSE GEAR | PIGNONE MARCIA INDIETRO | PIGNON MARCHE ARRIÈRE |
| 8 | REC09262-25078 | 09262-25003 | COJINETE CIGÜEÑAL | CRANKSHAFT BEARING | CUSCINETTO ALBERO MOTORE | PALIER DE VILEBREQUIN |
| 9 | REC08110-60050 | 08110-60050 | RODAMIENTO | BEARING | CUSCINETTO | ROULEMENT |
| 10 | REC09280-57002 | 09280-57002 | ARO TORICO | O-RING | O-RING | JOINT TORIQUE |
| 11 | PAGB/T5787-M6X20 | 09116-06227 | TORNILLO | BOLT, FLANGE | VITE | VIS DE BRIDE |
| 12 | REC09289-17006 | 09289-17L02 | RETÉN ACEITE | OIL SEAL | PARAOLIO | JOINT SPI |
| 13 | REC57632-94J00 | 57632-94J00 | SEPARADOR HELICE TRASERO | PROPELLER WASHER, BACK | DISTANZIALE ELICA, POSTERIORE | RONDELLE HÉLICE, ARRIÈRE |
| 14 | REC57633-93901 | 57633-93901 | SEPARADOR HELICE DELANTERO | PROPELLER WASHER, FRONT | DISTANZIALE ELICA, ANTERIORE | RONDELLE HÉLICE, AVANT |
| 15 | REC09160-12066 | 09160-12066 | ARANDELA | WASHER | RONDELLA | RONDELLE |
| 16 | REC09141-12005 | 09141-12005 | TUERCA HÉLICE | PROPELLER NUT | DADO ELICA | ECROU D'HELICE |
| 17 | REC09204-02004 | 09204-02004 | PIN BLOQUEADOR | COTTER PIN | COPPIGLIA | GOUPILLE |
| 18 | REC17400-99J01 | 17400-99J01 | KIT BOMBA | PUMP KIT | KIT POMPA | KIT POMPA À EAU |
| 19 | REC17461-93903 | 17461-93903 | IMPULSOR | IMPELLER | GIRANTE | TURBINE |
| 20 | REC09420-03005 | 09420-03005 | CHAVETA | KEY | CHIAVETTA | CLAVETTE |
| 21 | PAGB/T848-6 | 09160-06082 | ARANDELA | WASHER | RONDELLA | RONDELLE |
| 22 | PAGB/T6184-2000 | 29141-93J00 | TUERCA M6 | NUT M6 | DADO M6 | ÉCROU M6 |
| 23 | REC09380-15001 | 09380-15001 | CIRCLIP | CLIP | CERCLIP | CLIPS |
| 24 | REC08110-60020 | 08110-60020 | RODAMIENTO | BEARING | CUSCINETTO | ROULEMENT |
| 25 | REC09160-21009 | 09160-21009 | ARANDELA PIÑÓN | WASHER GEAR | RONDELLA PIGNONE | RONDELLE DE PIGNON |
| 26 | REC09263-20L04 | 09263-20L04 | RODAMIENTO | BEARING | CUSCINETTO | ROULEMENT |
| 27 | REC09160-20027 | 09160-20027 | ARANDELA PIÑÓN | WASHER GEAR | RONDELLA PIGNONE | RONDELLE DE PIGNON |
| | REC09160-20041 | 09160-20041 | GRUESO 1.00 | SHIM 1.00 | SPESSORE 1.00 | CALE 1.00 |
| | REC09160-20042 | 09160-20042 | GRUESO 1.10 | SHIM 1.10 | SPESSORE 1.10 | CALE 1.10 |
| 28 | REC09160-20043 | 09160-20043 | GRUESO 1.20 | SHIM 1.20 | SPESSORE 1.20 | CALE 1.20 |
| | REC09160-20044 | 09160-20044 | GRUESO 1.30 | SHIM 1.30 | SPESSORE 1.30 | CALE 1.30 |
| 29 | REC57311-99J10 | 57311-97J10 | PIÑÓN ATAQUE | INITIATIVE GEAR | PIGNONE | PIGNON D'ATTAQUE |



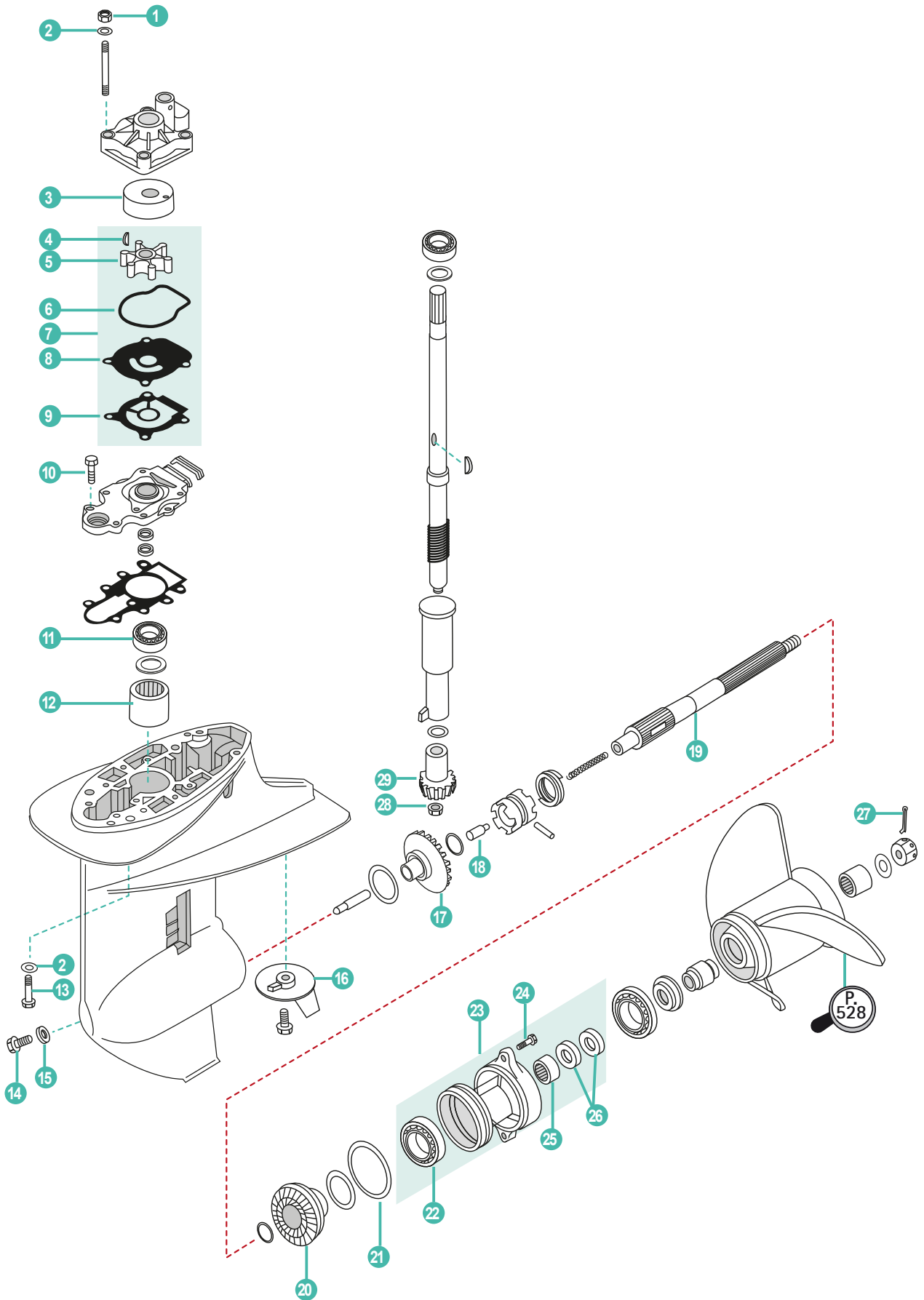

| | REF | OEM | | | | |
|----|--------------------|-----------------|---------------------------|-----------------------|-------------------------|-----------------------|
| 1 | PAGB/T6170-M6 | 29141-93J00 | TUERCA HEXÁGONO M6 | NUT HEXAGON M6 | DADO ESAGONALE M6 | ECROU HEXAGONAL M6 |
| 2 | PAGB/T848-6 | 09160-06082 | ARANDELA | WASHER | RONDELLA | RONDELLE |
| 3 | REC17413-95J00 | 17413-95J00 | CASQUILLO INOX | SLEEVE WATER PUMP | CAPPUCCIO | INSERT DE POMPE À EAU |
| 4 | REC09420-04006 | 09420-04006 | CHAVETA | KEY | CHIAVETTA | CLAVETTE |
| 5 | REC17461-96312 | 17461-96312 | IMPULSOR | IMPELLER | GIRANTE | TURBINE |
| 6 | REC17416-95J00 | 17416-95J00 | ARO TÓRICO | O-RING | FASCIA TONDA | JOINT TORIQUE |
| 7 | REC17400-95J02 | 17400-95J02 | KIT BOMBA DE AGUA | WATER PUMP KIT | KIT POMPA ACQUA | KIT POMPE A EAU |
| 8 | REC17471-95J01 | 17471-95J01 | TAPA DEL IMPULSOR | OUTER PLATE CARTRIDGE | COPERCHIO GIRANTE | PLAQUE DE POMPE À EAU |
| 9 | REC17472-96303 | 17472-96303 | JUNTA DE LA BOMBA DE AGUA | WATER PUMP, GASKET | GUARNIZIONE POMPA ACQUA | JOINT POMPE À EAU |
| 10 | REC09116-06094 | 09116-06094 | TORNILLO 6x15 | SCREW 6x15 | VITE 6x15 | VIS 6x15 |
| 11 | REC09265-17002 | 09265-17002 | RODAMIENTO | BEARING | CUSCINETTO | ROULEMENT |
| 12 | REC09263-20046 | 09263-20046 | RODAMIENTO | BEARING | CUSCINETTO | ROULEMENT |
| 13 | PAGB/T5787-M6X30 | 09116-08122 | TORNILLO M6x30 | BOLT M6x30 | BULLONE M6x30 | BOULON M6x30 |
| 14 | REC09248-10008 | 09248-10008 | TORNILLO 10x7,5 | SCREW 10x7,5 | VITE 10x7,5 | VIS M10x7,5 |
| 15 | REC09168-10022 | 09168-10022 | ARANDELA TAPÓN | CAP, O-RING | RONDELLA TAPPO | JOINT DE VIDANGE |
| 16 | CM55125-96310 | 55125-96310 | ÁNODO | ANODE | ANODO | ANODE |
| 17 | REC57510-89J00 | 57510-89J00 | PIÑÓN MARCHA AVANTE | POSITIVE GEAR | PIGNONE MARCIA AVANTI | PIGNON MARCHE AVANT |
| 18 | REC09209-08016 | 09209-08016 | VARILLA PRESION ACEITE | ROD PUSH | ASTA PRESSIONE OLIO | CLAVETTE |
| 19 | REC57610-96311 | 57610-96311 | EJE HELICE | PROPELLER SHAFT | ASSE ELICA | ARBRE D'HELICE |
| 20 | REC57521-89J00 | 57521-89J00 | PIÑÓN MARCHA ATRÁS | REVERSER GEAR | PIGNONE MARCIA INDIETRO | PIGNON MARCHE ARRIÈRE |
| 21 | REC09280-75001 | 09280-75001 | ARO TÓRICO | O-RING | FASCIA TONDA | JOINT TORIQUE |
| 22 | REC08113-60060 | 08113-60060 | RODAMIENTO | BEARING | CUSCINETTO | ROULEMENT |
| 23 | REC56120-96332-0EP | 56120-96332-0EP | DIÁBOLO | CARRIER | DIABOLO | DIABOLO |
| 24 | REC09116-06121 | 09116-06121 | TORNILLO | BOLT | VITE | VIS |
| 25 | REC09263-20047 | 09263-20047 | RODAMIENTO | BEARING | CUSCINETTO | ROULEMENT |
| 26 | REC09289-20009 | 09289-20009 | RETÉN ACEITE | OIL SEAL | PARAOILIO | JOINT SPI |
| 27 | REC91490-40030 | 09204-03003 | PIN BLOQUEADOR | COTTER PIN | COPPIGLIA | GOUPILLE |
| 28 | REC90179-08M06 | 09159-08046 | TUERCA DE PIÑÓN M8X1 | NUT, PINION M8X1 | DADO PIGNONE M8X1 | ECROU DE PIGNON M8 |
| 29 | REC57311-96320 | 57311-96320 | PIÑÓN ATAQUE | INITIATIVE GEAR | PIGNONE ATTACCO | PIGNON D'ATTAQUE |

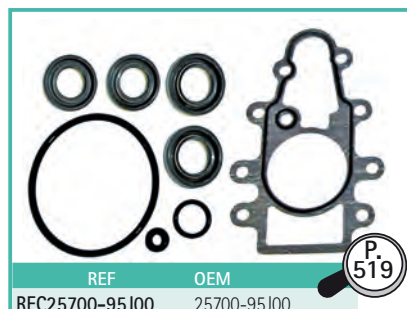

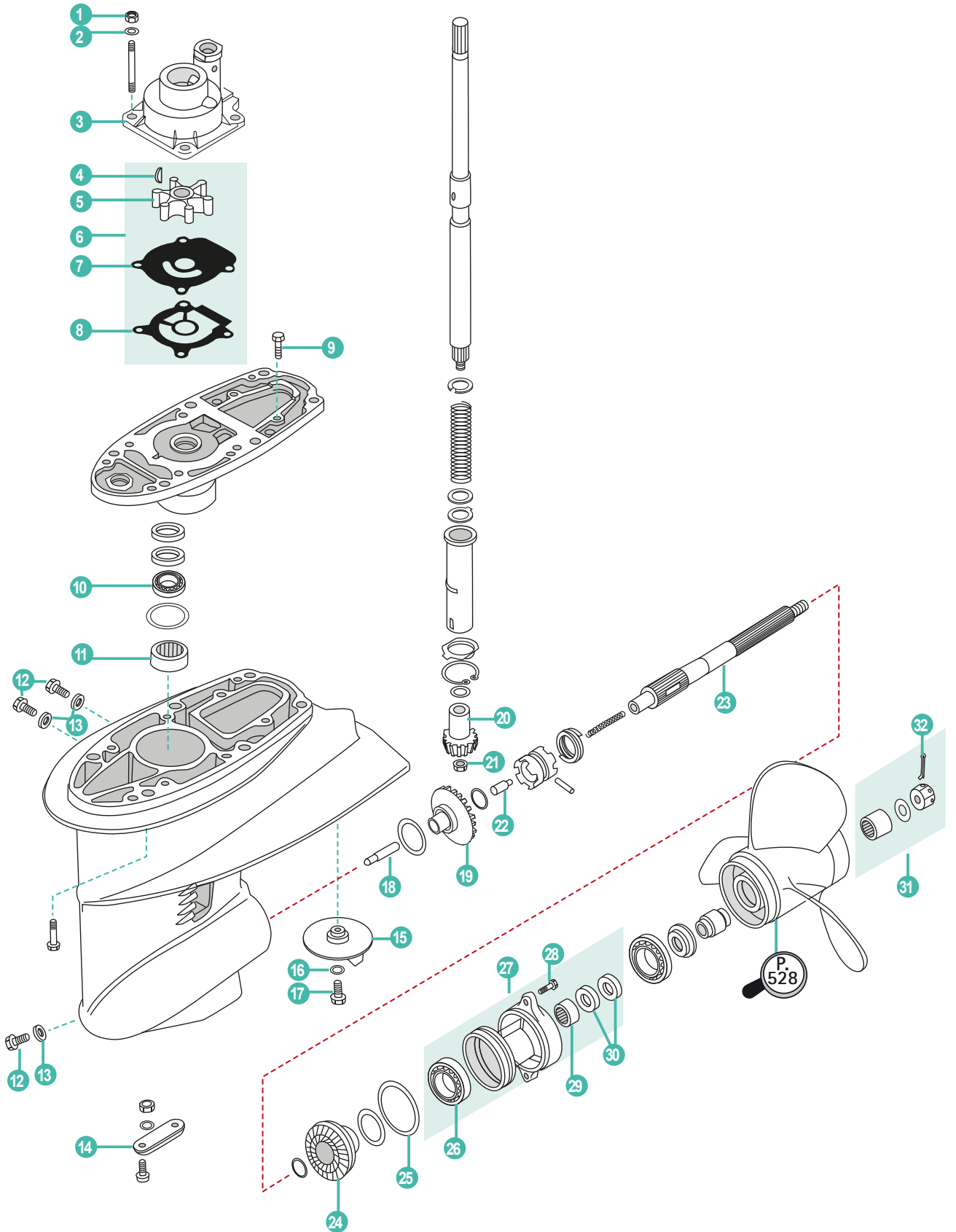

| | REF | OEM | | | | |
|----|--------------------|-----------------|---------------------------|--------------------|-------------------------|-------------------------|
| 1 | PAGB/T6184-2000 | 09141-06020 | TUERCA M6 | NUT M6 | DADO M6 | ÉCROU M6 |
| 2 | PAGB/T848-6 | 09162-06006 | ARANDELA | WASHER | RONDELLA | RONDELLE |
| 3 | REC17411-94421 | 17411-94421 | CUERPO BOMBA AGUA | HOUSING WATER PUMP | CORPO POMPA ACQUA | CORPS DE POMPE À EAU |
| 4 | REC09420-04006 | 09420-04006 | CHAVETA | KEY | CHIAVETTA | CLAVETTE |
| 5 | REC17461-96312 | 17461-96312 | IMPULSOR | IMPELLER | GIRANTE | TURBINE |
| 6 | REC17400-96403 | 17400-96352 | KIT BOMBA DE AGUA | WATER PUMP KIT | KIT POMPA ACQUA | KIT POMPE A EAU |
| 7 | REC17471-94401 | 17471-94401 | BASE BOMBA AGUA | PLATE, WATER PUMP | BASE POMPA ACQUA | BASE DE POMPE À EAU |
| 8 | REC17472-96303 | 17472-96303 | JUNTA DE LA BOMBA DE AGUA | WATER PUMP, GASKET | GUARNIZIONE POMPA ACQUA | JOINT POMPE À EAU |
| 9 | PAGB/T5787-M6X20 | 09116-06106 | TORNILLO | BOLT, FLANGE | VITE | VIS DE BRIDE |
| 10 | REC09265-17002 | 09265-17002 | RODAMIENTO | BEARING | CUSCINETTO | ROULEMENT |
| 11 | REC09263-20046 | 09263-20046 | RODAMIENTO | BEARING | CUSCINETTO | ROULEMENT |
| 12 | REC09248-10008 | 09248-10008 | TORNILLO 10x7,5 | SCREW 10x7,5 | VITE 10x7,5 | VIS 10x7,5 |
| 13 | REC09168-10022 | 09168-10022 | ARANDELA TAPÓN | CAP, O-RING | RONDELLA TAPPO | JOINT DE VIDANGE |
| 14 | CM55300-95500 | 55300-95500 | ÁNODO | ANODE | ANODO | ANODE |
| 15 | CM55125-96310 | 55125-96310 | ÁNODO | ANODE | ANODO | ANODE |
| 16 | PAGB/T97.1-8 | | ARANDELA 8 | WASHER 8 | RONDELLA 8 | RONDELLE 8 |
| 17 | PAGB/T5783-M8X16 | 09117-08037 | TORNILLO M8x16 | BOLT M8x16 | BULLONE M8x16 | BOULON M8x16 |
| 18 | REC57631-96301 | 57631-96301 | VARILLA PRESION ACEITE | ROD PUSH | ASTA PRESSIONE OLIO | CLAVETTE |
| 19 | REC57510-89J00 | 57510-89J00 | PIÑÓN MARCHA AVANTE | POSITIVE GEAR | PIGNONE MARCIA AVANTI | PIGNON MARCHE AVANT |
| 20 | REC57311-96320 | 57311-96320 | PIÑÓN ATAQUE | INITIATIVE GEAR | PIGNONE ATTACCO | PIGNON D'ATTAQUE |
| 21 | REC90179-08M06 | 09159-08046 | TUERCA DE PIÑÓN M8X1 | NUT, PINION M8X1 | DADO PIGNONE M8X1 | ECROU DE PIGNON M8 |
| 22 | REC09209-08016 | 09209-08016 | VARILLA PRESION ACEITE | ROD PUSH | ASTA PRESSIONE OLIO | CLAVETTE |
| 23 | REC57610-96311 | 57610-96311 | EJE HELICE | PROPELLER SHAFT | ASSE ELICA | ARBRE D'HELICE |
| 24 | REC57521-89J00 | 57521-89J00 | PIÑÓN MARCHA ATRÁS | REVERSER GEAR | PIGNONE MARCIA INDIETRO | PIGNON MARCHE ARRIÈRE |
| 25 | REC925093 | 09280-75002 | ARO TORICO SUPERIOR | O-RING UPPER | O-RING SUPERIORE | JOINT TORIQUE SUPERIEUR |
| 26 | REC08113-60060 | 08113-60060 | RODAMIENTO | BEARING | CUSCINETTO | ROULEMENT |
| 27 | REC56120-96332-OEP | 56120-96332-OEP | DIÁBOLO | CARRIER | DIABOLO | DIABOLO |
| 28 | REC09116-06121 | 09116-06121 | TORNILLO | BOLT | VITE | VIS |
| 29 | REC09263-20047 | 09263-20047 | RODAMIENTO | BEARING | CUSCINETTO | ROULEMENT |
| 30 | REC09289-20009 | 09289-20009 | RETÉN ACEITE | OIL SEAL | PARAOLIO | JOINT SPI |
| 31 | REC57630-96300 | 57630-96300 | KIT CIERRE DE HÉLICE | PROP NUT KIT | KIT CHIUSURA ELICA | KIT ECROU D'HELICE |
| 32 | REC91490-40030 | 09204-03003 | PIN BLOQUEADOR | COTTER PIN | COPPIGLIA | GOUPILLE |

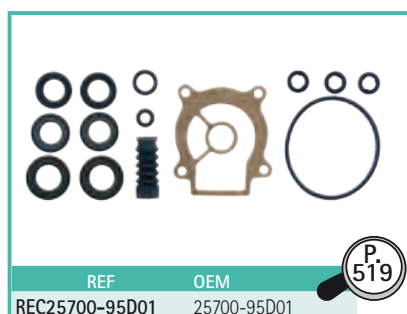

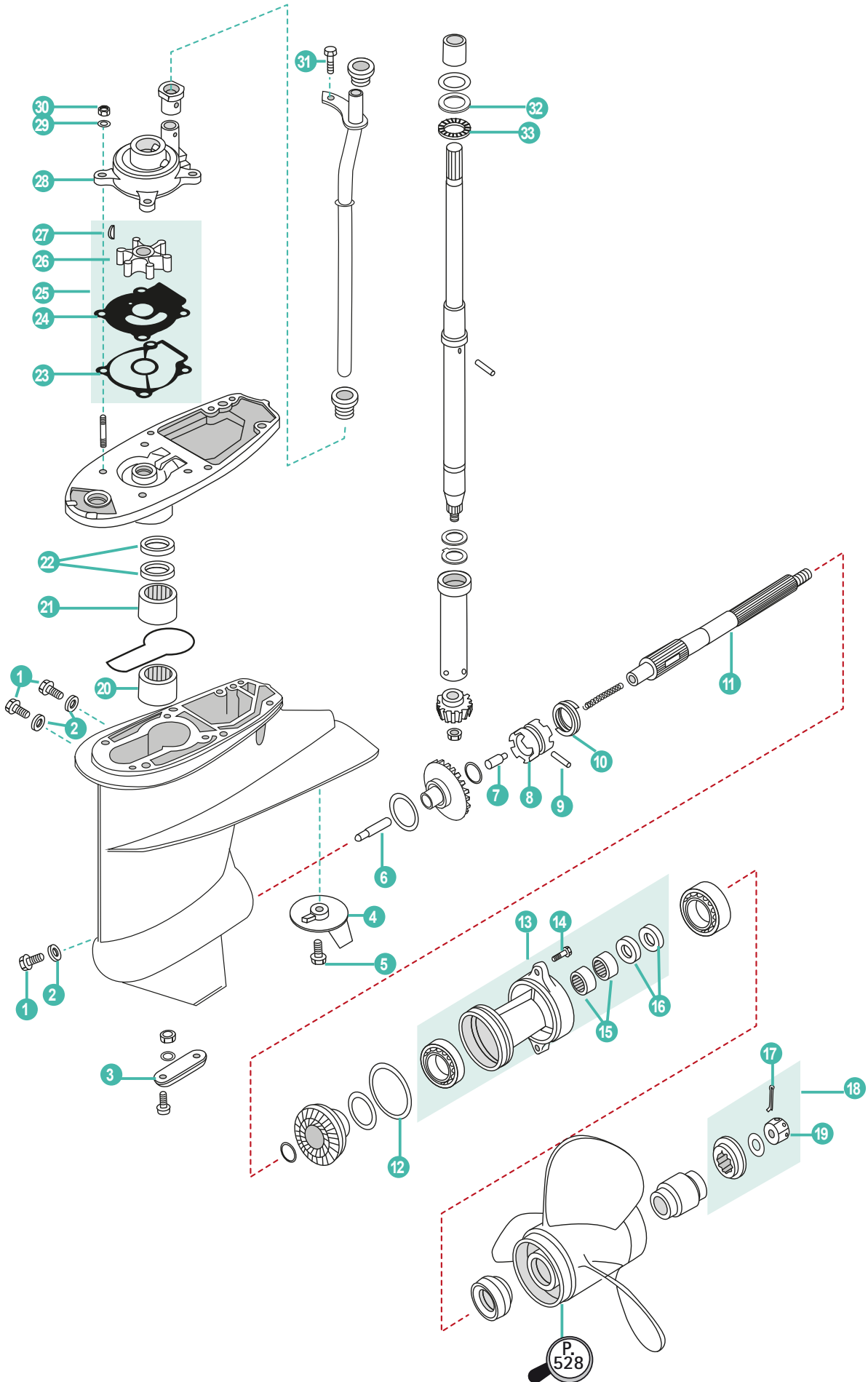

| | REF | OEM | | | | |
|----|--------------------|-----------------|---------------------------|--------------------|-------------------------|----------------------|
| 1 | REC09248-10008 | 09248-10008 | TORNILLO 10x7,5 | SCREW 10x7,5 | VITE 10x7,5 | VIS M10x7,5 |
| 2 | REC09168-10022 | 09168-10022 | ARANDELA TAPÓN | CAP, O-RING | RONDELLA TAPPO | JOINT DE VIDANGE |
| 3 | CM55300-95500 | 55300-95500 | ÁNODO | ANODE | ANODO | ANODE |
| 4 | CM55125-95500 | 55125-95500 | ÁNODO | ANODE | ANODO | ANODE |
| 5 | PAGB/T5783-M8X16 | 09117-08109 | TORNILLO M8x16 | BOLT M8x16 | BULLONE M8x16 | BOULON M8x16 |
| 6 | REC57631-95303 | 57631-95303 | VARILLA PRESION ACEITE | ROD PUSH | ASTA PRESSIONE OLIO | CLAVETTE |
| 7 | REC57634-88L00 | 57634-88L00 | PIN SELECTOR | CLUTCH PIN | PIN SELETTORE | CALVETTE |
| 8 | REC57621-94403 | 57621-87J03 | SELECTOR | SELETTORE | CLUTCH DOG | CRABOT |
| 9 | REC09202-04002 | 09202-04002 | PIN HELICE | PROPELLER PIN | PIN ELICA | CLAVETTE D'HELICE |
| 10 | REC09440-40002 | 09440-40002 | MUELLE SELECTOR | SPRING CLUTCH | MOLLA SELETTORE | RESSORT |
| 11 | REC57610-94402 | 57610-94402 | EJE HELICE | PROPELLER SHAFT | ASSE ELICA | ARBRE D'HELICE |
| 12 | REC09280-75001 | 09280-75001 | ARO TÓRICO | O-RING | FASCIA TONDA | JOINT TORIQUE |
| 13 | REC56120-94321-0EP | 56120-94321-0EP | DIÁBOLO | CARRIER | DIABOLO | DIABOLO |
| 14 | PAGB/T5783-M8X30 | 09117-08047 | TORNILLO M8x30 | BOLT M8x30 | BULLONE M8x30 | BOULON M8x30 |
| 15 | REC09263-22020 | 09263-22020 | RODAMIENTO | BEARING | CUSCINETTO | ROULEMENT |
| 16 | REC09289-22007 | 09289-22007 | RETÉN ACEITE | OIL SEAL | PARAOILIO | JOINT SPI |
| 17 | REC91490-40030 | 09204-03003 | PIN BLOQUEADOR | COTTER PIN | COPPIGLIA | GOUPILLE |
| 18 | REC57630-94300 | 57630-94301 | KIT CIERRE DE HÉLICE | PROP NUT KIT | KIT CHIUSURA ELICA | KIT ECROU D'HELICE |
| 19 | REC90171-18M04 | 09141-18005 | TUERCA | NUT | DADO | ÉCROU |
| 20 | REC09263-22L03 | 09263-22039 | RODAMIENTO | BEARING | CUSCINETTO | ROULEMENT |
| 21 | REC09263-25025 | 09263-25025 | RODAMIENTO | BEARING | CUSCINETTO | ROULEMENT |
| 22 | REC09282-17005 | 09282-17005 | RETÉN ACEITE | OIL SEAL | PARAOILIO | JOINT SPI |
| 23 | REC17472-96303 | 17472-96303 | JUNTA DE LA BOMBA DE AGUA | WATER PUMP, GASKET | GUARNIZIONE POMPA ACQUA | JOINT POMPE À EAU |
| 24 | REC17471-94401 | 17471-94401 | BASE BOMBA AGUA | PLATE, WATER PUMP | BASE POMPA ACQUA | BASE DE POMPE À EAU |
| 25 | REC17400-96403 | 17400-96403 | KIT BOMBA DE AGUA | WATER PUMP KIT | KIT POMPA ACQUA | KIT POMPE A EAU |
| 26 | REC17461-96312 | 17461-96312 | IMPULSOR | IMPELLER | GIRANTE | TURBINE |
| 27 | REC09420-04006 | 09420-04006 | CHAVETA | KEY | CHIAVETTA | CLAVETTE |
| 28 | REC17411-94421 | 17411-94421 | CUERPO BOMBA AGUA | HOUSING WATER PUMP | CORPO POMPA ACQUA | CORPS DE POMPE À EAU |
| 29 | PAGB/T93-6 | 29162-93J00 | ARANDELA 6 | WASHER 6 | RONDELLA 6 | RONDELLE 6 |
| 30 | PAGB/T6170-M6 | 29141-93J00 | TUERCA HEXÁGONO M6 | NUT HEXAGON M6 | DADO ESAGONALE M6 | ECROU HEXAGONAL M6 |
| 31 | REC09116-06094 | 09116-06094 | TORNILLO 6x15 | SCREW 6x15 | VITE 6x15 | VIS 6x15 |
| 32 | REC09160-26015 | 09160-26015 | ARANDELA PIÑÓN | WASHER GEAR | RONDELLA PIGNONE | RONDELLE DE PIGNON |
| 33 | REC09263-25062 | 09263-25062 | RODAMIENTO | BEARING | CUSCINETTO | ROULEMENT |

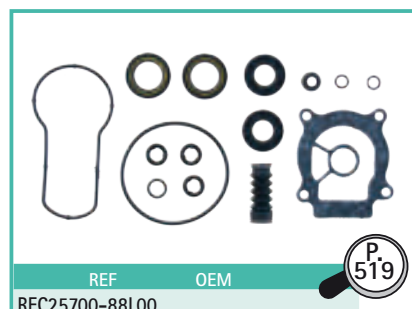
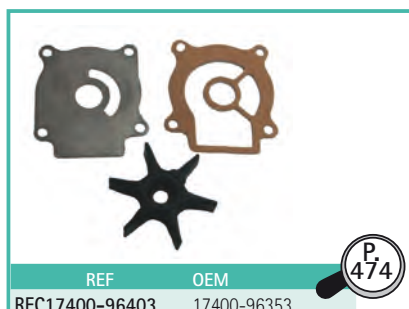

4T DF40A, DF50A, DF60A
STROKES

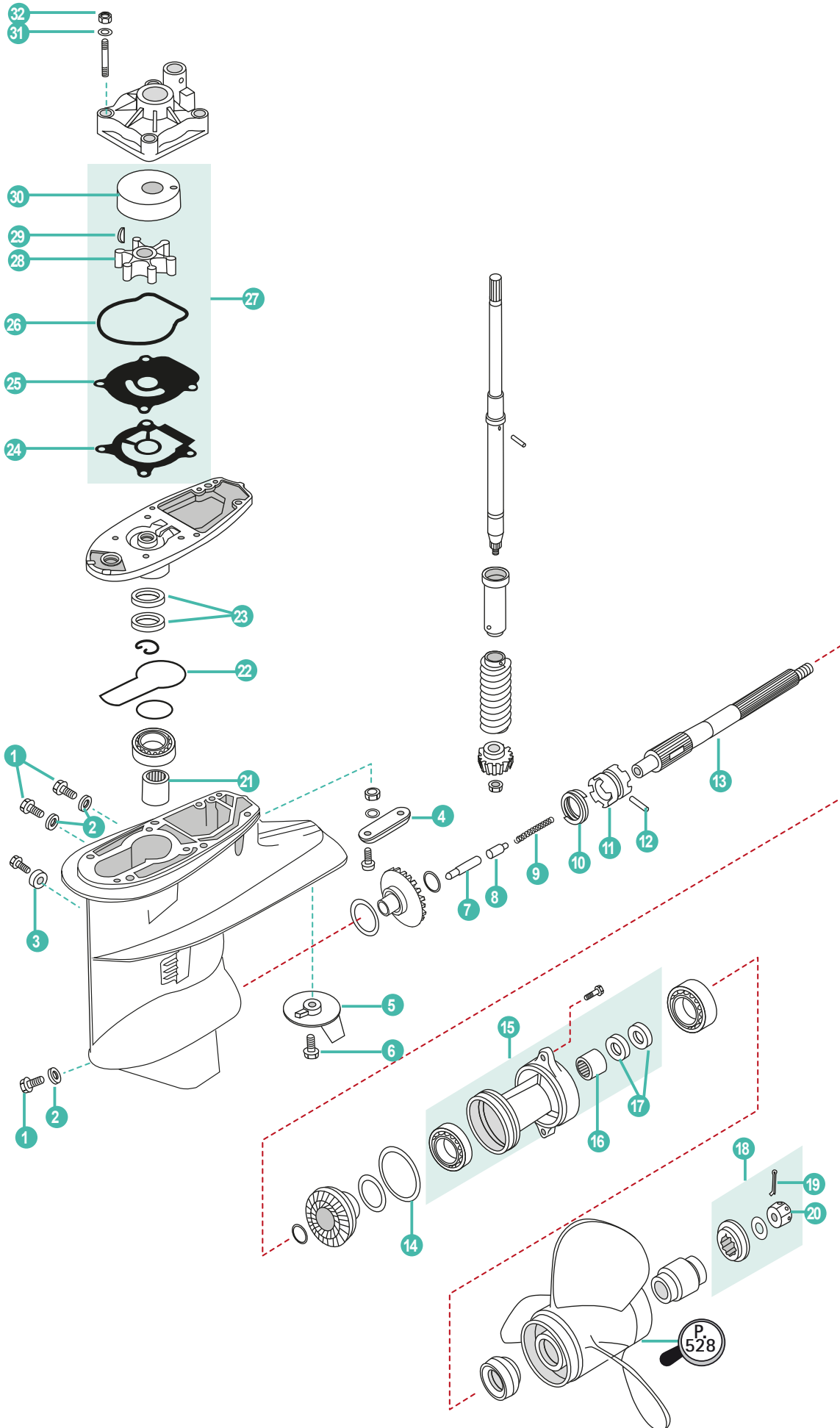

| | REF | OEM | | | | |
|----|--------------------|-----------------|---------------------------|-----------------------|-------------------------|-----------------------|
| 1 | REC09248-10008 | 09248-10008 | TORNILLO 10x7,5 | SCREW 10x7,5 | VITE 10x7,5 | VIS 10x7,5 |
| 2 | REC09168-10022 | 09168-10022 | ARANDELA TAPÓN | CAP, O-RING | RONDELLA TAPPO | JOINT DE VIDANGE |
| 3 | CM55321-87J00 | 55321-87J00 | ÁNODO | ANODE | ANODO | ANODE |
| 4 | CM55300-95500 | 55300-95500 | ÁNODO | ANODE | ANODO | ANODE |
| 5 | CM55125-94400 | 55125-94400 | ÁNODO | ANODE | ANODO | ANODE |
| 6 | PAGB/T5783-M8X16 | 09117-08109 | TORNILLO M8x16 | BOLT M8x16 | BULLONE M8x16 | BOULON M8x16 |
| 7 | REC57631-95303 | 57631-95303 | VARILLA DE PRESIÓN | ROD PUSH | ASTA PRESSIONE OLIO | DOIGT |
| 8 | REC57634-88L00 | 57634-88L00 | PIN SELECTOR | CLUTCH PIN | PIN SELETTORE | CALVETTE |
| 9 | REC09440-08043 | 09440-08043 | MUELLE SELECTOR | SPRING CLUTCH | MOLLA SELETTORE | RESSORT DE SELECTEUR |
| 10 | REC09440-40002 | 09440-40002 | MUELLE SELECTOR | SPRING CLUTCH | MOLLA SELETTORE | RESSORT DE SELECTEUR |
| 11 | REC57621-94403 | 57621-87J03 | SELECTOR | SELETTORE | CLUTCH DOG | CRABOT |
| 12 | REC09202-05022 | 09202-05022 | PIN SELECTOR | CLUTCH PIN | PIN SELETTORE | CALVETTE |
| 13 | REC57610-94402 | 57610-94402 | EJE HELICE | PROPELLER SHAFT | ASSE ELICA | ARBRE D'HELICE |
| 14 | REC09280-75001 | 09280-75001 | ARO TÓRICO | O-RING | FASCIA TONDA | JOINT TORIQUE |
| 15 | REC56120-94321-0EP | 56120-94321-0EP | DIÁBOLO | CARRIER | DIABOLO | DIABOLO |
| 16 | REC09263-22020 | 09263-22020 | RODAMIENTO | BEARING | CUSCINETTO | ROULEMENT |
| 17 | REC09289-22007 | 09289-22007 | RETÉN ACEITE | OIL SEAL | PARAOLIO | JOINT SPI |
| 18 | REC57630-94300 | 57630-94300 | KIT CIERRE DE HéLICE | PROP NUT KIT | KIT CHIUSURA ELICA | KIT ECROU D'HELICE |
| 19 | REC91490-40030 | 09204-03003 | PIN BLOQUEADOR | COTTER PIN | COPPIGLIA | GOUPILLE |
| 20 | REC90171-18M04 | 09141-18005 | TUERCA | NUT | DADO | ÉCROU |
| 21 | REC09263-22L03 | 09263-22039 | RODAMIENTO | BEARING | CUSCINETTO | ROULEMENT |
| 22 | REC55122-94400 | 55122-88L00 | JUNTA TORICA | O-RING | O-RING | JOINT TORIQUE |
| 23 | REC09282-17005 | 09282-17005 | RETÉN ACEITE | OIL SEAL | PARAOLIO | JOINT SPI |
| 24 | REC17472-96303 | 17472-96303 | JUNTA DE LA BOMBA DE AGUA | WATER PUMP, GASKET | GUARNIZIONE POMPA ACQUA | JOINT POMPE À EAU |
| 25 | REC17471-95J01 | 17471-95J01 | TAPA DEL IMPULSOR | OUTER PLATE CARTRIDGE | COPERCHIO GIRANTE | PLAQUE DE POMPE À EAU |
| 26 | REC17416-95J00 | 17416-95J00 | ARO TÓRICO | O-RING | FASCIA TONDA | JOINT TORIQUE |
| 27 | REC17400-88L00 | 17400-88L00 | KIT BOMBA DE AGUA | WATER PUMP KIT | KIT POMPA ACQUA | KIT POMPE A EAU |
| 28 | REC17461-96312 | 17461-96312 | IMPULSOR | IMPELLER | GIRANTE | TURBINE |
| 29 | REC09420-04006 | 09420-04006 | CHAVETA | KEY | CHIAVETTA | CLAVETTE |
| 30 | REC17413-95J00 | 17413-95J00 | CASQUILLO INOX | SLEEVE WATER PUMP | CAPPUCCIO | INSERT DE POMPE À EAU |
| 31 | PAGB/T93-6 | 29162-93J00 | ARANDELA MUELLE 6 | WASHER SPRING 6 | RONDELLA MOLLA 6 | RESSORT 6 |
| 32 | PAGB/T6170-M6 | 29141-93J00 | TUERCA HEXÁGONO M6 | NUT HEXAGON M6 | DADO ESAGONALE M6 | ECROU HEXAGONAL M6 |

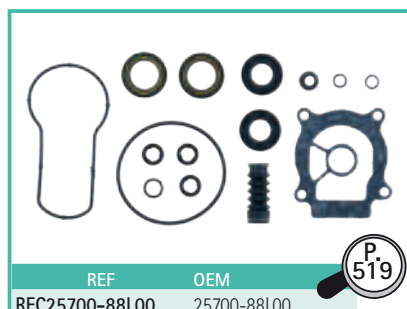

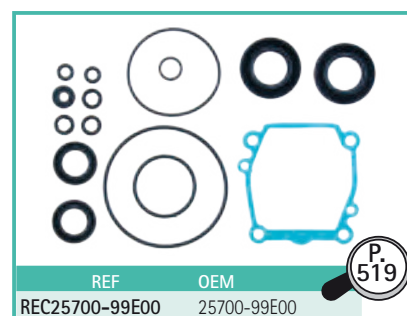
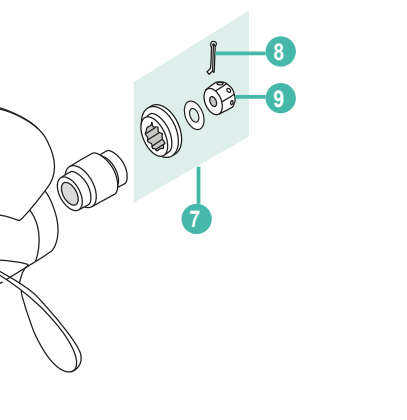
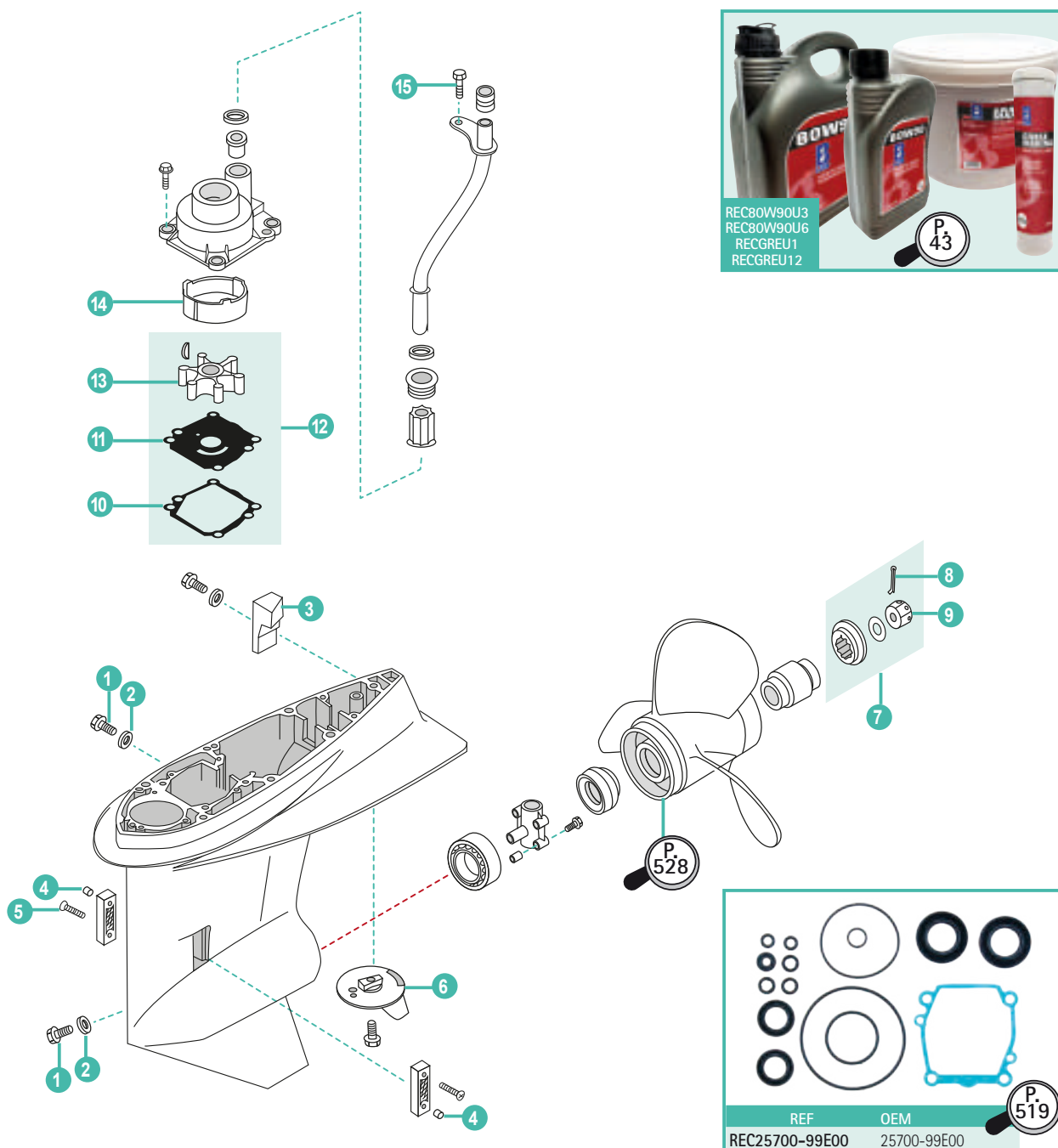

| | REF | OEM | | | | |
|----|------------------|-------------|---------------------------|----------------------|-----------------------------|-------------------------|
| 1 | REC09248-10008 | 09248-10008 | TORNILLO 10x7,5 | SCREW 10x7,5 | VITE 10x7,5 | VIS 10x7,5 |
| 2 | REC09168-10022 | 09168-10022 | ARANDELA TAPÓN | CAP, O-RING | RONDELLA TAPPO | JOINT DE VIDANGE |
| 3 | CM55321-90J01 | 55321-90J01 | ÁNODO | ANODE | ANODO | ANODE |
| 4 | PAGB/T889.1-M4 | 09140-04007 | TUERCA HEXAGONAL M4 | NUT HEXAGON M4 | DADO ESAGONALE M4 | ECROU HEXAGONAL M4 |
| 5 | PAGB/T818-M4X30 | 09125-04023 | TORNILLO M4x30 | SCREW PAN HEAD M4x30 | VITE TESTA M4x30 | VIS M4x30 |
| 6 | TEN01215 | 55125-90J01 | ÁNODO | ANODE | ANODO | ANODE |
| 7 | REC57630-94500 | 57630-94500 | KIT CIERRE HELICE | PROP NUT KIT | KIT CHIUSURA ELICA | KIT ECROU D'HELICE |
| 8 | REC91490-40030 | 09204-03003 | PIN BLOQUEADOR | COTTER PIN | COPPIGLIA | GOUPILLE |
| 9 | REC90171-18M04 | 09141-18005 | TUERCA | NUT | DADO | ÉCROU |
| 10 | REC17472-87E10 | 17472-87E10 | JUNTA BOMBA AGUA | WATER PUMP GASKET | GUARZIONE POMPA ACQUA | JOINT DE POMPE À EAU |
| 11 | REC17471-92J00 | 17471-87E01 | PLACA BOMBA DE AGUA | PATE, WATER PUMP | PLACCA POMPA ACQUA | PLAQUE DE POMPE A EAU |
| 12 | REC17400-87E04 | 17400-87E03 | KIT REPARACION BOMBA AGUA | WATER PUMP KIT | KIT RIPARAZIONE POMPA ACQUA | KIT TURBINE |
| 13 | REC17461-87E12 | 17461-87E12 | IMPULSOR | IMPELLER | GIRANTE | TURBINE |
| 14 | REC17413-99E11 | 17413-99E10 | CASQUILLO INOX | INSERT CUP | GHIERA INOX | INSERT INOX POMPE A EAU |
| 15 | PAGB/T5783-M6X16 | 09116-06225 | TORNILLO HEXAGONAL M6x16 | BOLT HEXAGON M6x16 | BULLONE ESAGONALE M6x16 | BOULON HEXAGONAL M6x16 |

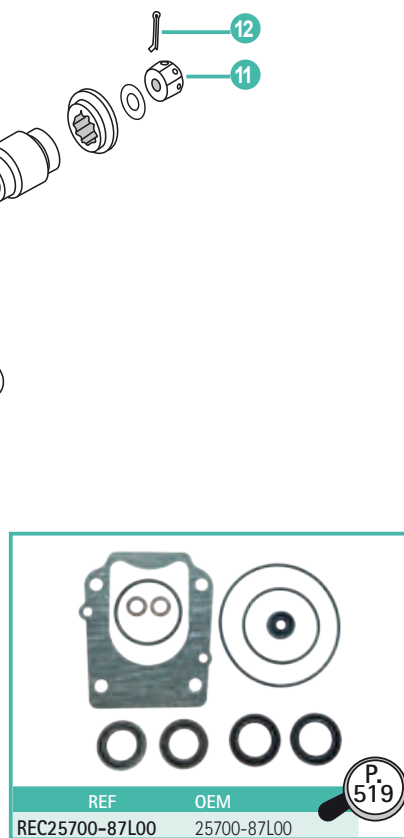
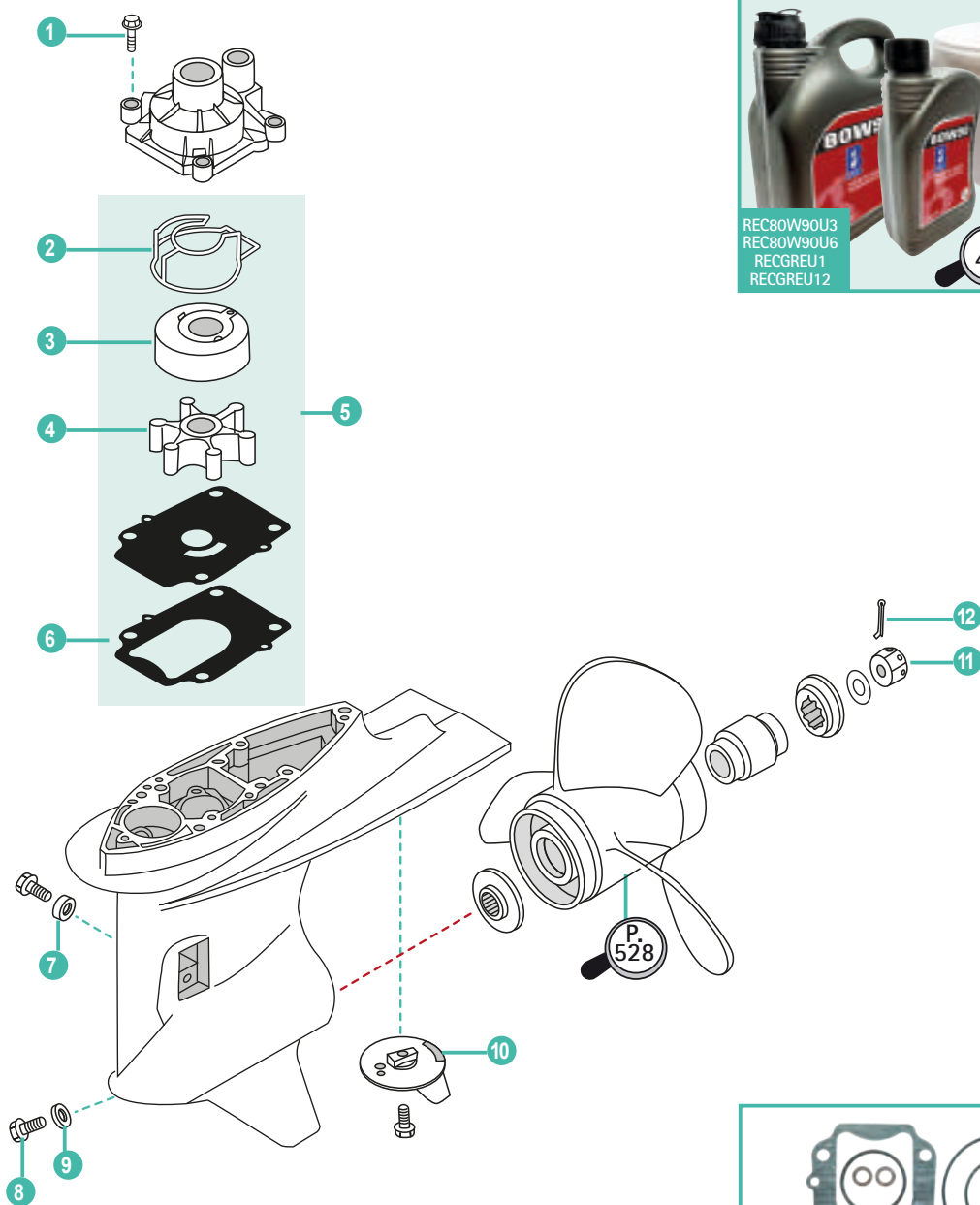

| REF | OEM | | | | | |
|-----|----------------|-------------|-------------------|-------------------|-----------------------|-------------------------|
| 1 | PAF8-00000003 | 29116-93J10 | TORNILLO M8x35 | BOLT M8x35 | BULLONE M8x35 | BOULON M8x35 |
| 2 | REC17416-99E10 | 17416-99E10 | JUNTA TORICA | O-RING | O-RING | JOINT TORIQUE |
| 3 | REC17413-99E11 | 17413-99E10 | CASQUILLO INOX | INSERT CUP | GHIERA INOX | INSERT INOX POMPE A EAU |
| 4 | REC17461-87E12 | 17461-87E12 | IMPULSOR | IMPELLER | GIRANTE | TURBINE |
| 5 | REC17400-87L01 | 17400-87L01 | KIT BOMBA DE AGUA | WATER PUMP KIT | KIT POMPA ACQUA | KIT POMPE A EAU |
| 6 | REC17472-87L00 | 17472-87L00 | JUNTA BOMBA AGUA | WATER PUMP GASKET | GUARZIONE POMPA ACQUA | JOINT DE POMPE À EAU |
| 7 | CM55321-87J00 | 55321-87J00 | ÁNODO | ANODE | ANODO | ANODE |
| 8 | REC09248-10008 | 09248-10008 | TORNILLO 10x7,5 | SCREW 10x7,5 | VITE 10x7,5 | VIS 10x7,5 |
| 9 | REC09168-10034 | 09168-10034 | JUNTA | GASKET | GUARNIZIONE | JOINT DE VIDANGE |
| 10 | TEN01215 | 55125-90J01 | ÁNODO | ANODE | ANODO | ANODE |
| 11 | REC90171-18M04 | 09141-18005 | TUERCA | NUT | DADO | ECROU D'HELICE |
| 12 | REC91490-40030 | 09204-03003 | PIN BLOQUEADOR | COTTER PIN | COPPIGLIA | GOUPILLE |

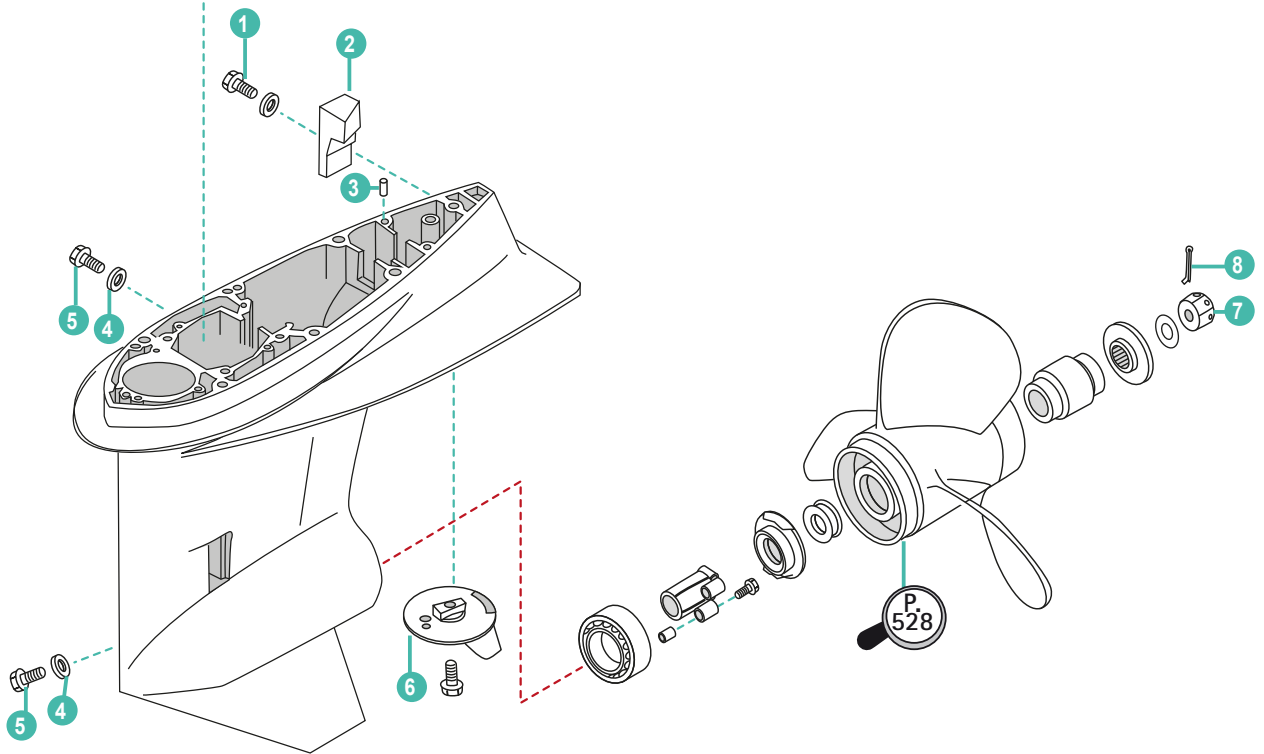
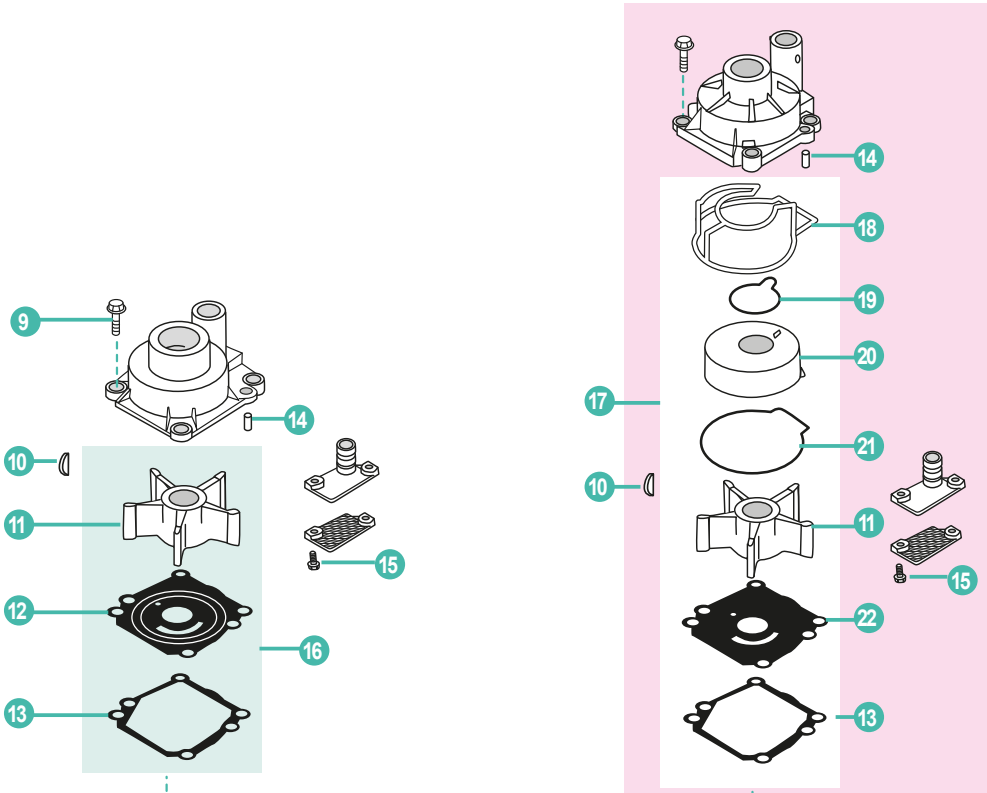

| | REF | OEM | | | | |
|----|------------------|-------------|----------------------|-----------------------|-----------------------|-------------------------|
| 1 | PAGB/T5783-M6X12 | 09100-06130 | TORNILLO M6x12 | BOLT M6x12 | BULLONE M6x12 | BOULON M6x12 |
| 2 | CM55321-90J01 | 55321-90J01 | ÁNODO | ANODE | ANODO | ANODE |
| 3 | PAF25-00000014 | 09202-08006 | PIN CENTRADOR F8x12 | PIN, DOWEL F8x12 | PIN, CENTRAGGIO F8x12 | GOUPILLE FENDUE 8x12 |
| 4 | REC09168-10022 | 09168-10022 | TORNILLO 10x7,5 | SCREW 10x7,5 | VITE 10x7,5 | VIS M10x7,5 |
| 5 | REC09248-10008 | 09248-10008 | ARANDELA TAPÓN | CAP, O-RING | RONDELLA TAPPO | JOINT DE VIDANGE |
| 6 | TEN01215 | 55125-90J01 | ÁNODO | ANODE | ANODO | ANODE |
| 7 | REC90171-18M04 | 09141-18005 | TUERCA | NUT | DADO | ÉCROU |
| 8 | REC91490-40030 | 08204-03003 | PIN BLOQUEADOR | COTTER PIN | COPPIGLIA | GOUPILLE |
| | | | MODELOS ANTIGUOS | OLDER MODELS | MODELLI VECCHIO | ANCIENS MODELES |
| 9 | PAGB/T5783-M8X25 | 09117-08057 | PERNO M8X25 | BOLT M8X25 | BULLONE M8 | BOULON M8X25 |
| 10 | REC09420-05009 | 09420-05009 | CHAVETA | KEY | CHIAVETTA | CLAVETTE |
| 11 | REC17461-90J01 | 17461-90J01 | IMPULSOR | IMPELLER | GIRANTE | TURBINE |
| 12 | REC17471-92J00 | 17471-92J00 | TAPA DEL IMPULSOR | OUTER PLATE CARTRIDGE | COPERCHIO GIRANTE | PLAQUE DE POMPE À EAU |
| 13 | REC17472-87E10 | 17472-87E10 | JUNTA BOMBA AGUA | WATER PUMP GASKET | GUARZIONE POMPA ACQUA | JOINT DE POMPE À EAU |
| 14 | REC93606-12019 | 09202-06031 | PIN F6X12 | PIN F6X12 | SPINOTTO F6X12 | LEVIER F6X12 |
| 15 | PAGB/T8.8-2000 | 09125-05046 | TORNILLO M5X12 | SCREW, PAN HEAD M5X12 | VITE M5X12 | VIS M5X12 |
| 16 | REC17400-90J20 | 17400-90J20 | KIT BOMBA DE AGUA | WATER PUMP KIT | KIT POMPA ACQUA | KIT POMPE A EAU |
| | | | MODELOS MODERNOS | NEWER MODELS | MODELLI MODERNI | MODELES RECENTS |
| 17 | REC17400-92J21 | 17400-92J21 | KIT BOMBA DE AGUA | WATER PUMP KIT | KIT POMPA ACQUA | KIT POMPE A EAU |
| 18 | REC17416-92J10 | 17416-92J10 | TÓRICA BOMBA DE AGUA | WATER PUMP, SEAL | FASCIA TONDA | JOINT TORIQUE |
| 19 | REC17417-92J00 | 17417-92J00 | JUNTA TORICA | O-RING | O-RING | JOINT TORIQUE |
| 20 | REC17413-92J01 | 17416-92J01 | CASQUILLO INOX | INSERT CUP | GHIERA INOX | INSERT INOX POMPE A EAU |
| 21 | REC17416-92J00 | 17416-92J00 | JUNTA TORICA | O-RING | O-RING | JOINT TORIQUE |
| 22 | REC17471-92J00 | 17471-92J00 | TAPA DEL IMPULSOR | OUTER PLATE CARTRIDGE | COPERCHIO GIRANTE | PLAQUE DE POMPE À EAU |

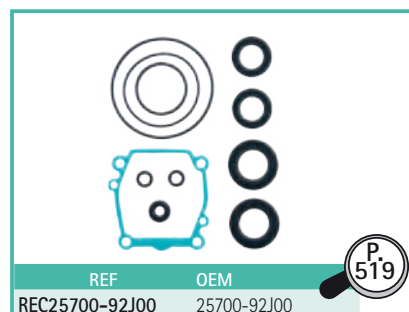
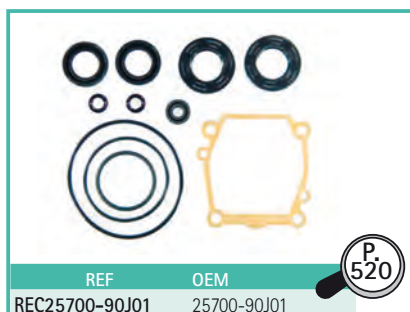

4T DF100A, DF115A, DF140A

STROKES

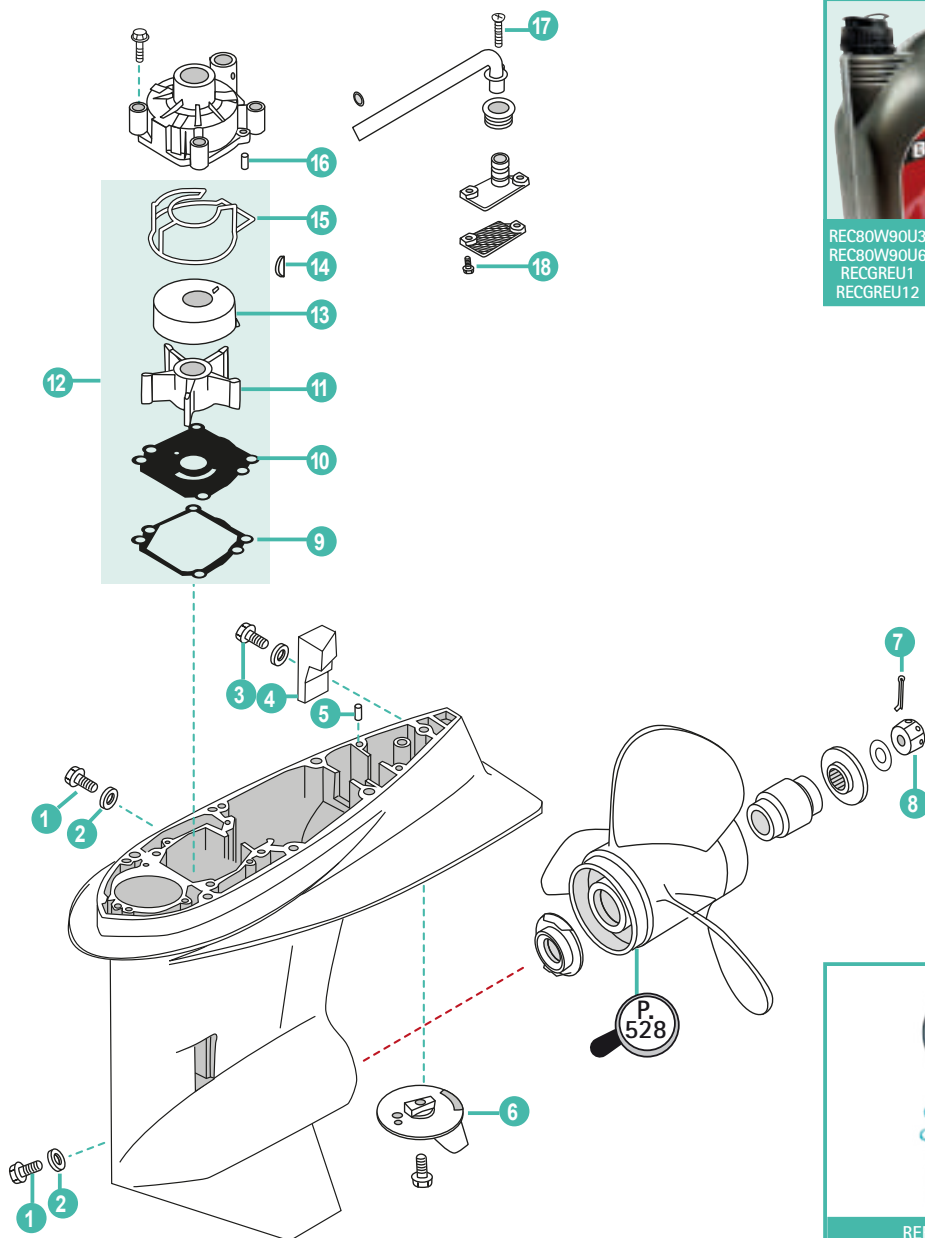

REC80W90U3
REC80W90U6
REC9REU1
REC9REU12

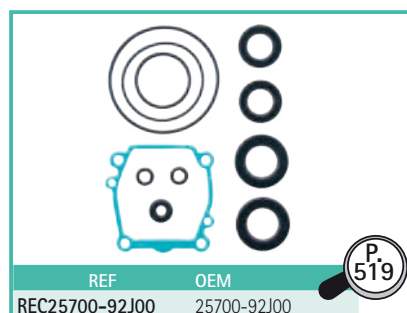

| REF | OEM |
|----------------|-------------|
| REC25700-92J00 | 25700-92J00 |

| | REF | OEM | | | | |
|----|------------------|-------------|----------------------|-----------------------|-----------------------|-------------------------|
| 1 | REC09248-10008 | 09248-10008 | TORNILLO 10x7,5 | SCREW 10x7,5 | VITE 10x7,5 | VIS 10x7,5 |
| 2 | REC09168-10022 | 09168-10022 | ARANDELA TAPÓN | CAP, O-RING | RONDELLA TAPPO | JOINT DE VIDANGE |
| 3 | PAGB/T5783-M6X12 | 09100-06130 | TORNILLO M6x12 | BOLT M6x12 | BULLONE M6x12 | BOULON M6x12 |
| 4 | CM55321-90J01 | 55321-90J01 | ÁNODO | ANODE | ANODO | ANODE |
| 5 | PAF25-00000014 | 09202-08006 | PIN CENTRADOR F8x12 | PIN, DOWEL F8x12 | PIN, CENTRAGGIO F8x12 | GOUPILLE FENDUE 8x12 |
| 6 | TEN01215 | 55125-90J01 | ÁNODO | ANODE | ANODO | ANODE |
| 7 | REC91490-40030 | 09240-03003 | PIN BLOQUEADOR | COTTER PIN | COPPIGLIA | GOUPILLE |
| 8 | REC90171-18M04 | 09141-18005 | TUERCA | NUT | DADO | ÉCROU |
| 9 | REC17472-87E10 | 17472-87E10 | JUNTA BOMBA AGUA | WATER PUMP GASKET | GUARZIONE POMPA ACQUA | JOINT DE POMPE À EAU |
| 10 | REC17471-92J00 | 17471-92J00 | TAPA DEL IMPULSOR | OUTER PLATE CARTRIDGE | COPERCHIO GIRANTE | PLAQUE DE POMPE À EAU |
| 11 | REC17461-90J01 | 17461-90J01 | IMPULSOR | IMPELLER | GIRANTE | TURBINE |
| 12 | REC17400-92J21 | 17400-92J21 | KIT BOMBA DE AGUA | WATER PUMP KIT | KIT POMPA ACQUA | KIT POMPE A EAU |
| 13 | REC17413-92J01 | 17413-92J01 | CASQUILLO INOX | INSERT CUP | GHIERA INOX | INSERT INOX POMPE A EAU |
| 14 | REC09420-05009 | 09420-05009 | CHAVETA | KEY | CHIAVETTA | CLAVETTE |
| 15 | REC17416-92J10 | 17416-92J10 | TÓRICA BOMBA DE AGUA | WATER PUMP, SEAL | FASCIA TONDA | JOINT TORIQUE |
| 16 | REC93606-12019 | 09202-06031 | PIN F6x12 | PIN F6x12 | SPINOTTO F6X12 | LEVIER F6X12 |
| 17 | PAGB/T818-M6X10 | 09125-06063 | TORNILLO M6x10 | BOLT M6x10 | BULLONE M6x10 | BOULON M6x10 |
| 18 | PAGB/T8.8-2000 | 09125-05046 | TORNILLO M5X12 | SCREW, PAN HEAD M5X12 | VITE M5X12 | VIS M5X12 |

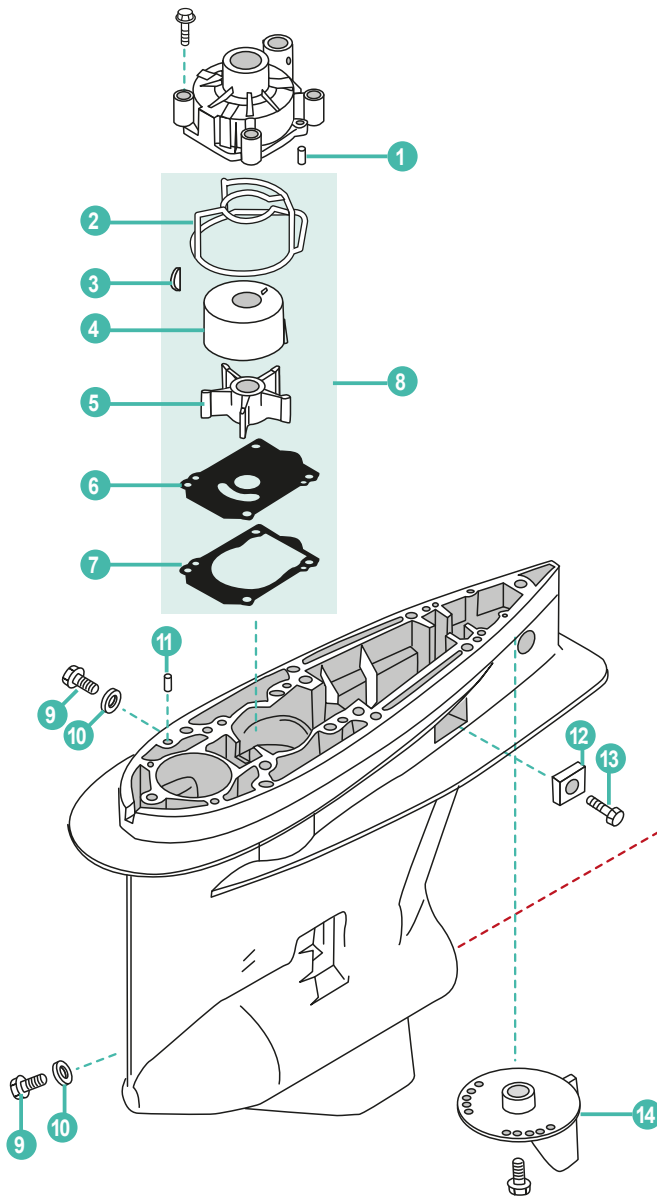

REC80W90U3
REC80W90U6
REC80W90U1
REC80W90U2

P. 43

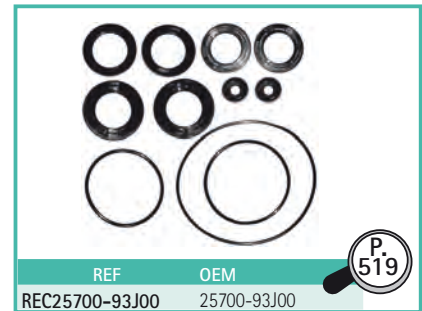
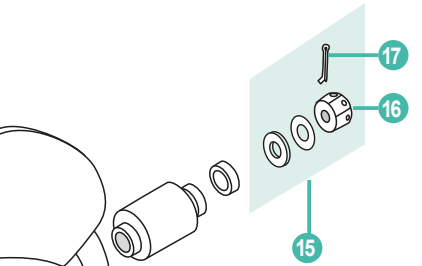

| REF | OEM |
|----------------|-------------|
| REC25700-93J00 | 25700-93J00 |

| | REF | OEM | | | | |
|----|----------------|-------------|---------------------|-------------------|-----------------------|-----------------------|
| 1 | REC93606-12019 | 09202-06031 | PIN F6X12 | PIN F6X12 | SPINOTTO F6X12 | LEVIER F6X12 |
| 2 | REC17416-96J00 | 17416-96J00 | JUNTA TORICA | O-RING | O-RING | JOINT TORIQUE |
| 3 | REC09420-05009 | 09420-05009 | CHAVETA | KEY | CHIAVETTA | CLAVETTE |
| 4 | REC17413-96J01 | 17413-96J01 | CASQUILLO INOX | SLEEVE WATER PUMP | CAPPUCCIO | INSERT DE POMPE À EAU |
| 5 | REC17461-90J01 | 17461-90J01 | IMPULSOR | IMPELLER | GIRANTE | TURBINE |
| 6 | REC17471-92J02 | 17471-93J02 | TAPA DEL IMPULSOR | IMPELLER PLATE | COPERCHIO GIRANTE | PLAQUE DE POMPE À EAU |
| 7 | REC17472-93J00 | 17472-93J00 | JUNTA | GASKET | GUARNIZIONE | JOINT |
| 8 | REC17400-96J03 | 17400-96J03 | KIT BOMBA DE AGUA | WATER PUMP KIT | KIT POMPA ACQUA | KIT POMPE A EAU |
| 9 | REC55128-93J10 | 55128-93J10 | TAPON DRENAJE COLA | WATER PLUG DRAIN | GUARNIZIONE DRENAGGIO | BOUCHON DE VIDANGE |
| 10 | REC09168-10034 | 09168-10034 | JUNTA | GASKET | GUARNIZIONE | JOINT |
| 11 | PAF25-00000014 | 09202-08006 | PIN CENTRADOR F8x12 | PIN, DOWEL F8x12 | PIN, CENTRAGGIO F8x12 | GOUPILLE FENDUE 8x12 |
| 12 | CM55320-95310 | 55320-95311 | ÁNODO | ANODE | ANODO | ANODE |
| 13 | REC09116-06094 | 09116-06094 | TORNILLO 6x15 | SCREW 6x15 | VITE 6x15 | VIS M6x15 |
| 14 | TEN01215 | 55125-98J00 | ÁNODO | ANODE | ANODO | ANODE |
| 15 | REC57630-92E00 | 57630-92E00 | KIT CIERRE HELICE | PROP NUT KIT | KIT CHIUSURA ELICA | KIT ECROU D'HELICE |
| 16 | REC90171-18M04 | 09141-18005 | TUERCA | NUT | DADO | ÉCROU |
| 17 | REC91490-40030 | 09204-03003 | PIN BLOQUEADOR | COTTER PIN | COPPIGLIA | GOUPILLE |

4T DF250AP, DF350AP

STROKES

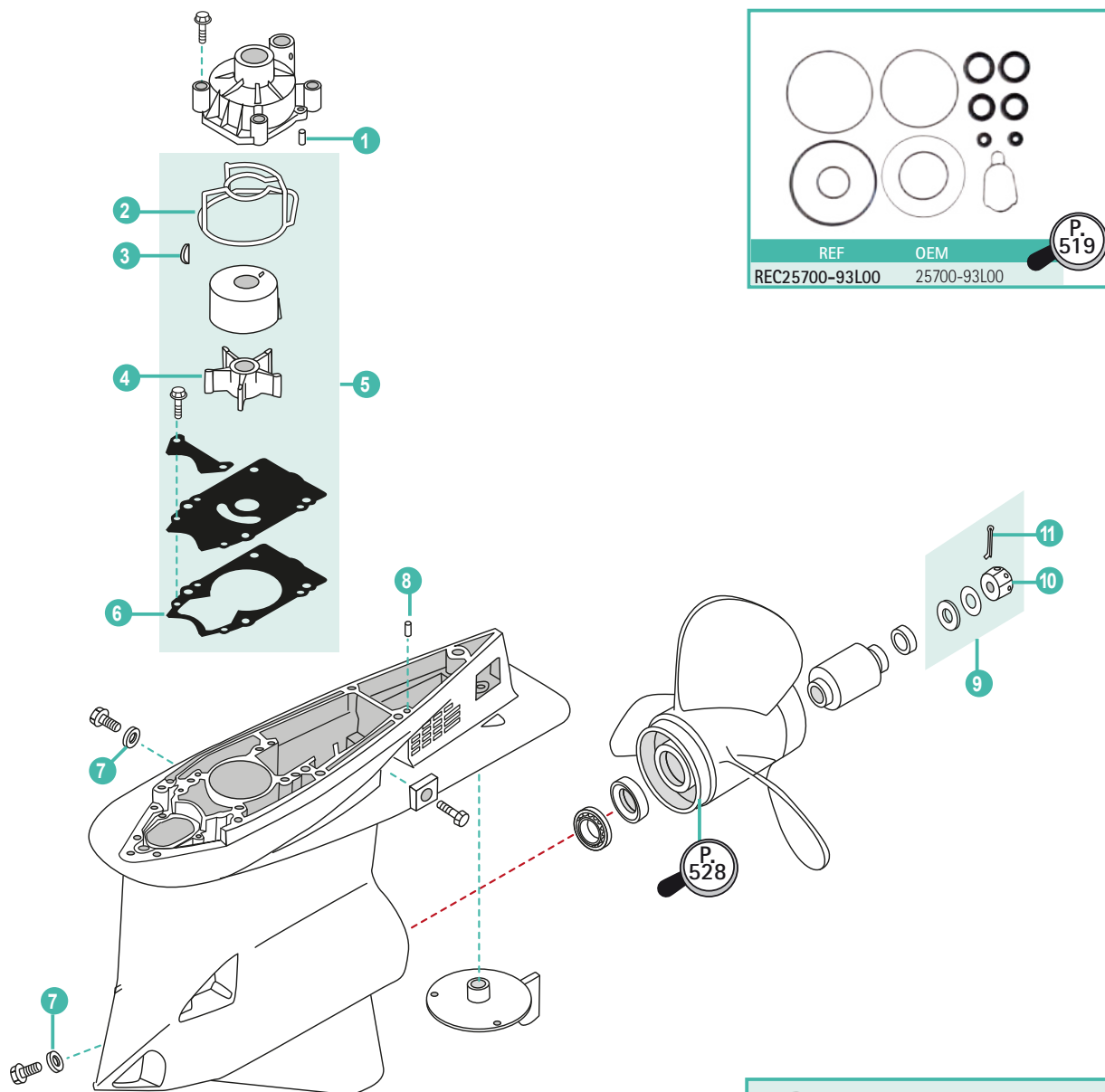

| | REF | OEM | | | | |
|----|----------------|-------------|----------------------|-------------------|------------------------|----------------------|
| 1 | REC93606-12019 | 09202-06031 | PIN F6X12 | PIN F6X12 | SPINOTTO F6X12 | LEVIER F6X12 |
| 2 | REC17416-93J00 | 17416-93J00 | TÓRICA BOMBA DE AGUA | WATER PUMP, SEAL | FASCIA TONDA | JOINT TORIQUE |
| 3 | REC09420-05009 | 09420-05009 | CHAVETA | KEY | CHIAVETTA | CLAVETTE |
| 4 | REC17461-93J00 | 17461-93J00 | IMPULSOR | IMPELLER | GIRANTE | TURBINE |
| 5 | REC17400-98J01 | 17400-98J01 | KIT BOMBA DE AGUA | WATER PUMP KIT | KIT POMPA ACQUA | KIT POMPE A EAU |
| 6 | REC17472-98J00 | 17472-98J00 | JUNTA BASE BOMBA | CASE PANEL GASKET | GUARNIZIONE BASE POMPA | JOINT DE BASE |
| 7 | REC09168-10034 | 09168-10034 | JUNTA | GASKET | GUARNIZIONE | JOINT |
| 8 | PAF25-00000014 | 09202-08006 | PIN CENTRADOR F8x12 | PIN, DOWEL F8x12 | PIN, CENTRAGGIO F8x12 | GOUPILLE FENDUE 8x12 |
| 9 | REC57630-92E00 | 57630-92E00 | KIT CIERRE HELICE | PROP NUT KIT | KIT CHIUSURA ELICA | KIT ECROU D'HELICE |
| 10 | REC90171-18M04 | 90171-18M04 | TUERCA | NUT | DADO | ÉCROU |
| 11 | REC91490-40030 | 09204-03003 | PIN BLOQUEADOR | COTTER PIN | COPPIGLIA | GOUPILLE |

COMPONENTES DE COLA

DRIVE COMPONENTS

COMPONENTI PIEDI PIECES D' EMBASES

KITS JUNTAS Y RETENES

SEALS KITS

KIT GUARNIZIONE E TENUTE

KITS JOINTS D'EMBASES

| REF | OEM |
|----------------|-------------|
| REC25700-87E00 | 25700-87E00 |

 DF60, DF70 W-K9 (1998-09)
 DT90, DT100L-Y (1990-00)

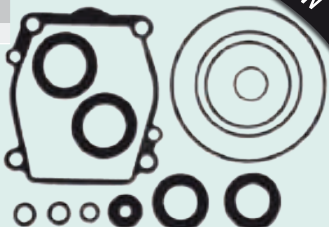

new

| REF | OEM |
|----------------|-------------|
| REC25700-87L00 | 25700-87L00 |

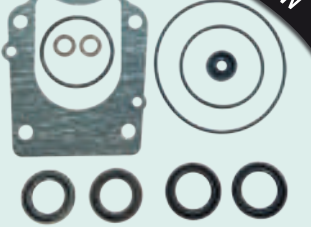
 DF70A, DF80A, DF90A (2009+)



new

| REF | OEM |
|----------------|-------------|
| REC25700-93L00 | 25700-93L00 |

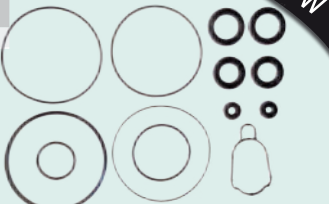
 DF250AP, DF300AP



new

| REF | OEM |
|----------------|-------------|
| REC25700-92J00 | 25700-92J00 |

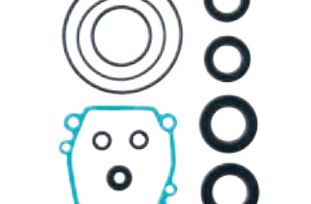
 DF100A, DF115A, DF140A (2013+)
 DF140 (2002-12)



| REF | OEM |
|----------------|----------------------------|
| REC25700-95D01 | 25700-95D01 25700-95D00 |

 DF25, DF30Y-K6 (2000-06)
 DT25C, DT30C-K-Y (1989-00)



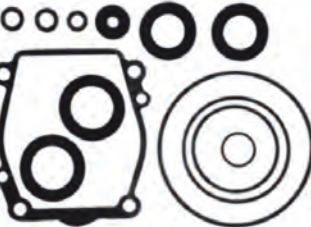

| REF | OEM |
|----------------|-------------|
| REC25700-87D00 | 25700-87D00 |

 DT150, DT200,
 DT225W-K3 (1998-03)
 V6H-Y (1987-00)



| REF | OEM |
|----------------|----------------------------|
| REC25700-88L00 | 25700-94400 25700-88400 |

 DF40, DF50X-K10 (1999-10)
 DF40A, DF50A, DF60A (2010+)





| REF | OEM |
|----------------|-------------|
| REC25700-93J00 | 25700-93J00 |

 DF150, DF175T/Z (G) (2006-14)
 DF200, DF225, DF250 (2004+)
 DF200A (2015)



| REF | OEM |
|----------------|-------------|
| REC25700-94700 | 25700-94700 |

 DT55, DT65J-X (1988-99)



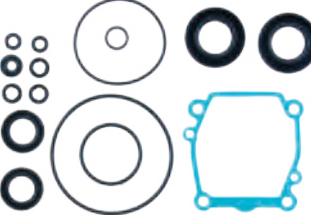

| REF | OEM |
|----------------|-------------|
| REC25700-99E00 | 25700-99E00 |

 DF40A, DF50A, DF60A (2014+)
 DF60, DF70W-K9 (1998-09)



| REF | OEM |
|----------------|-------------|
| REC25700-95501 | 25700-95500 |

 DT75, DT85J-Y (1988-00)



| REF | OEM |
|----------------|-------------|
| REC25700-95J00 | 25700-95J00 |

 DF20R, DF25, DF25R-V2 (2006-11)

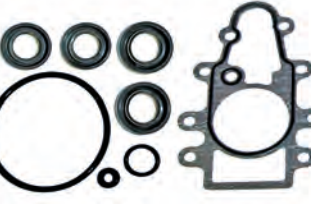

| REF | OEM |
|----------------|-------------|
| REC25700-98J00 | 25700-98J00 |

 DF300T/Z (2007-11)



| REF | OEM |
|----------------|-------------|
| REC25700-94500 | 25700-94500 |



DT115, DT140G-Y (1986-00)

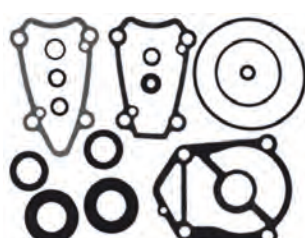



| REF | OEM |
|----------------|-------------|
| REC25700-90J01 | 25700-90J01 |





DF90, DF100, DF115 K1-K11 (2001-11)
DF115WT, DF140WT-K3 (2003)



| GUÍA KITS DE JUNTAS | GUIDE OF GASKETS KITS | GUIDA KIT GUARNIZIONE | GUIDE DES KITS JOINTS | | | | | | | | | | | | | | | | | | | | | | | | | | | | | | | | | | | | | |
|---|-----------------------|-----------------------|-----------------------|--------------|----------------|---------------------|----------------|------|---|-----|--|--------------|----------------|-------------------------|--|--------|---|------------------|--------------------|----------------|--|----------------|---------|----------------|---------|----------------|-------|---|-----|-----|----------------|--|----------------|--|----------------|--|----------------|--|----------------|--|
|  <table border="1"> <thead> <tr> <th>REF</th> </tr> </thead> <tbody> <tr> <td>DT25C DT30C</td> </tr> <tr> <td>DT55 DT65</td> </tr> <tr> <td>DT75 DT85</td> </tr> <tr> <td>DT115 DT140</td> </tr> <tr> <td>V6 2-STROKE 1989-03</td> </tr> <tr> <td>DF25 DF30</td> </tr> <tr> <td>DF25</td> </tr> </tbody> </table> | REF | DT25C DT30C | DT55 DT65 | DT75 DT85 | DT115 DT140 | V6 2-STROKE 1989-03 | DF25 DF30 | DF25 |  <table border="1"> <thead> <tr> <th>REF</th> </tr> </thead> <tbody> <tr> <td>DT40C DF40 DF50 DF40A DF50A DF60A</td> </tr> <tr> <td>DF60 DF70</td> </tr> <tr> <td>DF60 DF70</td> </tr> <tr> <td>DF70A DF80A DF90A</td> </tr> </tbody> </table> | REF | DT40C DF40 DF50 DF40A DF50A DF60A | DF60 DF70 | DF60 DF70 | DF70A DF80A DF90A |  <table border="1"> <thead> <tr> <th>REF</th> </tr> </thead> <tbody> <tr> <td>DF90 DF100 DF115 DF115A DF140 DF150 DF175 DF200 DF225/ DF250</td> </tr> <tr> <td>DF250SS DF300</td> </tr> <tr> <td>DF250AP DF300AP</td> </tr> </tbody> </table> | REF | DF90 DF100 DF115 DF115A DF140 DF150 DF175 DF200 DF225/ DF250 | DF250SS DF300 | DF250AP DF300AP | | | | | | | | | | | | | | | | | | | | | |
| REF | | | | | | | | | | | | | | | | | | | | | | | | | | | | | | | | | | | | | | | | |
| DT25C DT30C | | | | | | | | | | | | | | | | | | | | | | | | | | | | | | | | | | | | | | | | |
| DT55 DT65 | | | | | | | | | | | | | | | | | | | | | | | | | | | | | | | | | | | | | | | | |
| DT75 DT85 | | | | | | | | | | | | | | | | | | | | | | | | | | | | | | | | | | | | | | | | |
| DT115 DT140 | | | | | | | | | | | | | | | | | | | | | | | | | | | | | | | | | | | | | | | | |
| V6 2-STROKE 1989-03 | | | | | | | | | | | | | | | | | | | | | | | | | | | | | | | | | | | | | | | | |
| DF25 DF30 | | | | | | | | | | | | | | | | | | | | | | | | | | | | | | | | | | | | | | | | |
| DF25 | | | | | | | | | | | | | | | | | | | | | | | | | | | | | | | | | | | | | | | | |
| REF | | | | | | | | | | | | | | | | | | | | | | | | | | | | | | | | | | | | | | | | |
| DT40C DF40 DF50 DF40A DF50A DF60A | | | | | | | | | | | | | | | | | | | | | | | | | | | | | | | | | | | | | | | | |
| DF60 DF70 | | | | | | | | | | | | | | | | | | | | | | | | | | | | | | | | | | | | | | | | |
| DF60 DF70 | | | | | | | | | | | | | | | | | | | | | | | | | | | | | | | | | | | | | | | | |
| DF70A DF80A DF90A | | | | | | | | | | | | | | | | | | | | | | | | | | | | | | | | | | | | | | | | |
| REF | | | | | | | | | | | | | | | | | | | | | | | | | | | | | | | | | | | | | | | | |
| DF90 DF100 DF115 DF115A DF140 DF150 DF175 DF200 DF225/ DF250 | | | | | | | | | | | | | | | | | | | | | | | | | | | | | | | | | | | | | | | | |
| DF250SS DF300 | | | | | | | | | | | | | | | | | | | | | | | | | | | | | | | | | | | | | | | | |
| DF250AP DF300AP | | | | | | | | | | | | | | | | | | | | | | | | | | | | | | | | | | | | | | | | |
| <table border="1"> <thead> <tr> <th>REF</th> <th>OEM</th> </tr> </thead> <tbody> <tr> <td>REC25700-95D01</td> <td></td> </tr> <tr> <td>REC25700-94700</td> <td></td> </tr> <tr> <td>REC25700-95501</td> <td></td> </tr> <tr> <td>REC25700-94500</td> <td></td> </tr> <tr> <td>REC25700-87D00</td> <td></td> </tr> <tr> <td>REC25700-95D01</td> <td>V-TWIN</td> </tr> <tr> <td>REC25700-95J00</td> <td>V-TWIN</td> </tr> </tbody> </table> | REF | OEM | REC25700-95D01 | | REC25700-94700 | | REC25700-95501 | | REC25700-94500 | | REC25700-87D00 | | REC25700-95D01 | V-TWIN | REC25700-95J00 | V-TWIN | <table border="1"> <thead> <tr> <th>REF</th> <th>OEM</th> </tr> </thead> <tbody> <tr> <td>REC25700-88L00</td> <td></td> </tr> <tr> <td>REC25700-87E00</td> <td>1989-00</td> </tr> <tr> <td>REC25700-99E00</td> <td>2001-10</td> </tr> <tr> <td>REC25700-87L00</td> <td>2009+</td> </tr> </tbody> </table> | REF | OEM | REC25700-88L00 | | REC25700-87E00 | 1989-00 | REC25700-99E00 | 2001-10 | REC25700-87L00 | 2009+ | <table border="1"> <thead> <tr> <th>REF</th> <th>OEM</th> </tr> </thead> <tbody> <tr> <td>REC25700-90J01</td> <td></td> </tr> <tr> <td>REC25700-92J00</td> <td></td> </tr> <tr> <td>REC25700-93J00</td> <td></td> </tr> <tr> <td>REC25700-98J00</td> <td></td> </tr> <tr> <td>REC25700-93L00</td> <td></td> </tr> </tbody> </table> | REF | OEM | REC25700-90J01 | | REC25700-92J00 | | REC25700-93J00 | | REC25700-98J00 | | REC25700-93L00 | |
| REF | OEM | | | | | | | | | | | | | | | | | | | | | | | | | | | | | | | | | | | | | | | |
| REC25700-95D01 | | | | | | | | | | | | | | | | | | | | | | | | | | | | | | | | | | | | | | | | |
| REC25700-94700 | | | | | | | | | | | | | | | | | | | | | | | | | | | | | | | | | | | | | | | | |
| REC25700-95501 | | | | | | | | | | | | | | | | | | | | | | | | | | | | | | | | | | | | | | | | |
| REC25700-94500 | | | | | | | | | | | | | | | | | | | | | | | | | | | | | | | | | | | | | | | | |
| REC25700-87D00 | | | | | | | | | | | | | | | | | | | | | | | | | | | | | | | | | | | | | | | | |
| REC25700-95D01 | V-TWIN | | | | | | | | | | | | | | | | | | | | | | | | | | | | | | | | | | | | | | | |
| REC25700-95J00 | V-TWIN | | | | | | | | | | | | | | | | | | | | | | | | | | | | | | | | | | | | | | | |
| REF | OEM | | | | | | | | | | | | | | | | | | | | | | | | | | | | | | | | | | | | | | | |
| REC25700-88L00 | | | | | | | | | | | | | | | | | | | | | | | | | | | | | | | | | | | | | | | | |
| REC25700-87E00 | 1989-00 | | | | | | | | | | | | | | | | | | | | | | | | | | | | | | | | | | | | | | | |
| REC25700-99E00 | 2001-10 | | | | | | | | | | | | | | | | | | | | | | | | | | | | | | | | | | | | | | | |
| REC25700-87L00 | 2009+ | | | | | | | | | | | | | | | | | | | | | | | | | | | | | | | | | | | | | | | |
| REF | OEM | | | | | | | | | | | | | | | | | | | | | | | | | | | | | | | | | | | | | | | |
| REC25700-90J01 | | | | | | | | | | | | | | | | | | | | | | | | | | | | | | | | | | | | | | | | |
| REC25700-92J00 | | | | | | | | | | | | | | | | | | | | | | | | | | | | | | | | | | | | | | | | |
| REC25700-93J00 | | | | | | | | | | | | | | | | | | | | | | | | | | | | | | | | | | | | | | | | |
| REC25700-98J00 | | | | | | | | | | | | | | | | | | | | | | | | | | | | | | | | | | | | | | | | |
| REC25700-93L00 | | | | | | | | | | | | | | | | | | | | | | | | | | | | | | | | | | | | | | | | |

| FUELLES VARILLA DE CAMBIO | SHIFT, BELOW | MANICOTTO MARCE | SOUFFLET DU LEVIER DE CHANGEMENT DE VITESSE | | | | | | |
|---|--------------|-----------------|---|-------------|--|-----|-----|----------------|-------------|
| <table border="1"> <thead> <tr> <th>REF</th> <th>OEM</th> </tr> </thead> <tbody> <tr> <td>REC25222-93901</td> <td>25222-93901</td> </tr> </tbody> </table>  <p>DF4, DF5, DF6 (2002-12) DF9.9, DF15 (1996-12) DT7, DT5 (1988-01) DT9.9, DT15 (1986-04)</p>  | REF | OEM | REC25222-93901 | 25222-93901 | <table border="1"> <thead> <tr> <th>REF</th> <th>OEM</th> </tr> </thead> <tbody> <tr> <td>REC25222-96300</td> <td>25222-96300</td> </tr> </tbody> </table>  <p>DF25, DF30 Y-K6 (2000-06) DT20, T25, DT30 (1986-02) DT40C-W G-X (1986-99)</p>  | REF | OEM | REC25222-96300 | 25222-96300 |
| REF | OEM | | | | | | | | |
| REC25222-93901 | 25222-93901 | | | | | | | | |
| REF | OEM | | | | | | | | |
| REC25222-96300 | 25222-96300 | | | | | | | | |

| ARO TÓRICO VARILLA DE CAMBIO | SHIFT, O-RING | O-RING MARCE | JOINT TORIQUE DU LEVIER | | | | | | |
|--|---------------|--------------|-------------------------|-------------|---|-----|-----|----------------|-------------|
| <table border="1"> <thead> <tr> <th>REF</th> <th>OEM</th> </tr> </thead> <tbody> <tr> <td>REC09280-08005</td> <td>09280-08005</td> </tr> </tbody> </table>  <p>DF20R, DF25RVZ (2006-13) DF25, DF30Y-K6 (2000-06) DF40, DF50X-K10 (1999-10) DF40A, DF50A, DF60A (2010+) DT20, DT25, DT30G-Y (1986-00) DT25, DT30 K1-K2 (2001-02) DT40C-W G-X (1986-99) DT55, DT60J-Z (1988-99) DT75, DT85J-Y (1988-00)</p>  | REF | OEM | REC09280-08005 | 09280-08005 | <table border="1"> <thead> <tr> <th>REF</th> <th>OEM</th> </tr> </thead> <tbody> <tr> <td>REC09280-11005</td> <td>09280-11005</td> </tr> </tbody> </table>  <p>DF40, DF50X-K10 (1999-10) DF40A, DF50A, DF60A (2010+) DF70A, DF80A, DF90A (2009+) DF100B (2018+) DT40C-W G-X (1986-99) DT4W K1-K4 (2001-04) DT55, DT65J-X (1988-99) DT75, DT85J-Y (1988-00)</p>  | REF | OEM | REC09280-11005 | 09280-11005 |
| REF | OEM | | | | | | | | |
| REC09280-08005 | 09280-08005 | | | | | | | | |
| REF | OEM | | | | | | | | |
| REC09280-11005 | 09280-11005 | | | | | | | | |

| TUERCA VARILLA DE CAMBIO | TURNBUCKE CLUTCH ROD | DADO ASTA CAMBIO | ECROU DU LEVIER DE CHANGEMENT DE VITESSE | | | | | | | | | | | | | | | | |
|--|----------------------|------------------|--|-------------|--|-----|-----|----------------|-------------|--|-----|-----|----------------|-------------|--|-----|-----|----------------|-------------|
| <table border="1"> <thead> <tr> <th>REF</th> <th>OEM</th> </tr> </thead> <tbody> <tr> <td>REC23311-95DL0</td> <td>23311-95DL0</td> </tr> </tbody> </table>  <p>DF25, DF30Y-K6 (2000-06) DF40, DF50X-K10 (1999-10) DF9.9, DF15T-K3 (1996-03) DF9.9, DF15 (R) (2004-11) DT9.9, DT40</p>  | REF | OEM | REC23311-95DL0 | 23311-95DL0 | <table border="1"> <thead> <tr> <th>REF</th> <th>OEM</th> </tr> </thead> <tbody> <tr> <td>REC23311-95DL0</td> <td>23311-95DL0</td> </tr> </tbody> </table> | REF | OEM | REC23311-95DL0 | 23311-95DL0 | <table border="1"> <thead> <tr> <th>REF</th> <th>OEM</th> </tr> </thead> <tbody> <tr> <td>REC23311-95DL0</td> <td>23311-95DL0</td> </tr> </tbody> </table> | REF | OEM | REC23311-95DL0 | 23311-95DL0 | <table border="1"> <thead> <tr> <th>REF</th> <th>OEM</th> </tr> </thead> <tbody> <tr> <td>REC23311-95DL0</td> <td>23311-95DL0</td> </tr> </tbody> </table> | REF | OEM | REC23311-95DL0 | 23311-95DL0 |
| REF | OEM | | | | | | | | | | | | | | | | | | |
| REC23311-95DL0 | 23311-95DL0 | | | | | | | | | | | | | | | | | | |
| REF | OEM | | | | | | | | | | | | | | | | | | |
| REC23311-95DL0 | 23311-95DL0 | | | | | | | | | | | | | | | | | | |
| REF | OEM | | | | | | | | | | | | | | | | | | |
| REC23311-95DL0 | 23311-95DL0 | | | | | | | | | | | | | | | | | | |
| REF | OEM | | | | | | | | | | | | | | | | | | |
| REC23311-95DL0 | 23311-95DL0 | | | | | | | | | | | | | | | | | | |

**TUBO DRENAJE
BOMBA DE AGUA****DRAIN EATER TUBE****TUBO DRENAGGIO ACQUA****TUBE DE VIDANGE DE
LA POMPE A EAU**

| REF | OEM |
|----------------|----------------------------|
| REC17453-93901 | 17453-93900 17453-93901 |



DT15C (1989-97)
DT9.9, DT15 K1-K4 (2001-04)
DT9.9K, DT15K G-Y (1986-00)
DF15 (2012)
DF9.9, DF15T-K3 (1996-03)
DF9.9, DF15(R) (2004-11)



new

| REF | OEM |
|----------------|---|
| REC17431-92L20 | 17431-92L20 17431-94441 17431-94440 |



DT40C-W G-X (1986-99)
DT40W K1-K4 (2001-04)



new

| REF | OEM |
|----------------|--|
| REC17560-91L00 | 17560-91L00 17560-96304 17560-96301 17560-96300 |



DT20, DT25, DT30G-Y (1986-00)
DT25, DT30 K1-K2 (2001-02)

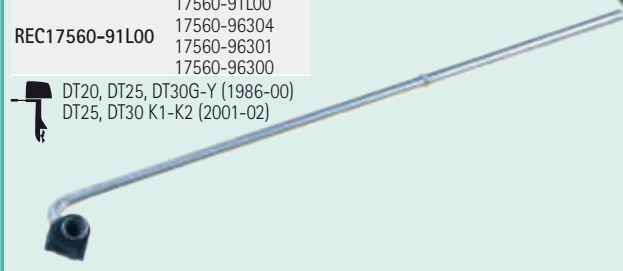

new

**TORNILLOS Y JUNTAS DE
DRENAJE****DRAIN, SCREW AND
GASKETS****VITI E GUARNIZIONE,
DRENAGGIO****VIS ET JOINTS DE VIDANGE**

| REF | OEM |
|----------------|-------------------------|
| REC09248-10008 | 09248-10008 10 x 7.2 mm |



new

| REF | OEM |
|----------------|----------------------------|
| REC55128-93J10 | 55128-93J00 55128-93J10 |



DF70 --> DF300

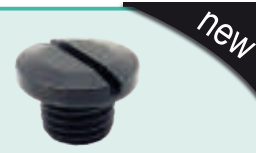

new

| REF | OEM |
|----------------|-------------|
| REC09168-10034 | 09168-10034 |



DF70 --> DF350



new

| REF | OEM |
|----------------|-------------|
| REC59178-97J00 | 59178-97J00 |



DF2.5 --> DF30

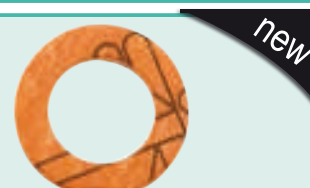

new

DIÁBOLO**DIABOLO****DIABOLO****DIABOLO**

| REF | OEM |
|----------------|---|
| REC56120-93900 | 56120-93900-OEP 56120-93901-OED 56120-93900-002M 56120-90L00-OEP 56120-90L01-OEP 56120-90L02-OEP |



DF9.9, DF15T-K3 (1996-03)
DF9.9, DF15(R) (2004-12)
DT9.9, DT15K1-K4 (1986-04)
DT15 (1989-97)



new

| REF | OEM |
|--------------------|-----------------|
| REC56120-96332-OEP | 56120-96332-OEP |



DF20R, DF25, DF25RVZ (2006-11)
DF25, DF30Y-K6 (2000-06)
DT25, DT30K1-K2 (2001-02)



new

| REF | OEM |
|--------------------|-----------------|
| REC56120-94321-OEP | 56120-94321-OEP |



DF40, DF50X-K10 (1999-10)
DF40A, DF50A, DF60A (2010-16)
DT40W-K1-K4 (2001-04)



new

**ARO TÓRICO DEL DIÁBOLO
DIABOLO, O-RING****O-RING DIABOLO****JOINT TORIQUE DU
DIABOLO**

| REF | OEM |
|----------------|---------------------------|
| REC09280-57002 | 09280-57002 3.5 x 65.2 mm |



DF15 (2012)
DF8A, DF9.9A (AR) (2010+)
DF9.9, DF15T-K3 (1996-03)
DF9.9, DF15(R) (2004-11)
DF9.9B, DF15A, DF20A (2013+)
DT15C (1989-97)
DT9.9, DT15 K1-K4 (2001-04)
DT9.9K, DT15K-G (1986-00)



new

| REF | OEM |
|----------------|-------------------------|
| REC09280-75001 | 09280-75001 3.3 x 75 mm |



DF40, DF50X-K10 (1999-10)
DF40A, DF50A, DF60A (2010+)
DT40C-W G-X (1986-99)
DT40W K1-K4 (2001-04)

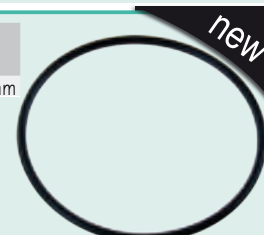

new

SELECTOR

CLUTCH DOGS

SELETTORE

CRABOT

SELECTOR

CLUTCH DOGS

SELETTORE

CRABOT

| REF | OEM |
|----------------|-------------|
| 57621-94400 | |
| 57621-94403 | |
| REC57621-94403 | 57621-87J03 |
| | 57621-87J00 |
| | 57621-87J01 |
| | 57621-87J02 |



new

DT40C-W G-X (1986-99)
DT40W K1-K4 (2001-04)
DF40, DF50X-K10 (1999-10)
DF40A, DF50A, DF60A (2010+)

| REF | OEM |
|----------------|-------------|
| 57621-91L10 | |
| REC57621-91L10 | 57621-96300 |
| | 57621-96310 |



new

DT20, DT25, DT30G-Y (1986-00)
DT25, DT30K1-K2 (2001-02)
DT25C, DT30C K-Y (1989-00)
DF25A, DF30A (2015)

MUELLE PARA SELECTOR

SPRING CLUTCH

MOLLA SELETTORE

RESSORT DE SELECTEUR

| REF | OEM |
|----------------|-------------|
| REC09440-32008 | 09440-32008 |



new

DF9.9, DF15TK3 (1996-03)
DF9.9, DF15(R) (2004-11)
DF15 (2012)
DT15C (1989-97)
DT9.9, DT15 K1-K4 (2001-04)
DT9.9K, DT15K G-Y (1986-00)

| REF | OEM |
|----------------|-------------|
| REC09440-08043 | 09440-08043 |



new

DF40, DF50X-K10 (1999-10)
DF40A, DF50A, DF60A (2010+)

| REF | OEM |
|----------------|----------------|
| REC09440-40002 | 09440-40002 |
| | REC57621-94403 |



new

DF40, DF50X-K10 (1999-10)
DF40A, DF50A, DF60A (2010+)
DT40C-W G-X (1986-99)
DT40W K1-K4 (2001-04)
DT55, DT60J-X (1988-99)

| REF | OEM |
|----------------|-------------|
| REC09440-05027 | 09440-05027 |



new

DF9.9, DF15T-K3 (1996-03)
DF9.9, DF15(R) (2004-11)
DT15C (1989-97)
DT8, DT9.9C J-V (1988-97)
DT9.9, DT15 K1-K4 (2001-04)
DT9.9, DT15K G-Y (1986-00)

PIN

PIN

SPINOTTO

PIN

| REF | OEM |
|----------------|-------------|
| 57632-97L00 | |
| REC57632-97L00 | 57632-98500 |
| | 57632-98501 |



new

DF15 (2012)
DF4, DF5, DF6 (2002-15)
DF8A, DF9.9A (AR) (2010+)
DF9.9, DF15T-K3 (1996-03)
DF9.9, DF15(R) (2004-11)
DT15C (1989-97)
DT4-J4, DT5Y (1988-00)
DT5, DT6, DT8G-Y (1986-00)
DF9.9B, DF15A, DF20A (2013+)

| REF | OEM |
|----------------|-------------|
| REC09202-05022 | 09202-05022 |



new

DF40, DF50X-K10 (1999-10)
DF40A, DF50A, DF60A (2010+)
DT40C-W G-X (1986-99)
DT40W K1-K4 (2001-04)

PASADOR PARA SELECTOR

CLUTCH PIN

PIN SELETTORE

PIVOT

| REF | OEM |
|----------------|-------------|
| REC57634-88L00 | 57634-88L00 |



new

DF40, DF50X-K10 (1999-10)
DF40A, DF50A, DF60A (2010+)

| REF | OEM |
|----------------|-------------|
| REC09209-08016 | 09209-08016 |



new

DF20R, DF25, DF25RVZ (2006-13)
DF25, DF30Y-K6 (2000-06)
DF25A, DF30A (2015+)
DT20, DT25, DT30G-Y (1986-00)
DT25, DT30 K1-K2 (2001-02)
DT25C, DT30C K-Y (1989-00)

VARILLA PARA SELECTOR **ROD PUSH** **ASTA PRESSIONE** **TIGE DE POUSSEE**

| REF | OEM |
|----------------|-------------|
| REC57631-93901 | 57631-93901 |



new

 DF15 82012)
 DF8A, DF9.9A 8AR) (2010+)
 DF9.9, DF15(R) (2004-11)
 DF9.9B, DF15A, DF20A (2013+)
 DT15C (1989-97)
 DT9.9, DT15 K1-K4 (2001-04)
 DT9.9K, DT15K G-Y (1986-00)

| REF | OEM |
|----------------|-------------|
| REC57631-95303 | 57631-95303 |
| | 57631-94700 |
| | 57631-95302 |
| | 57631-95301 |



new

 DF40, DF50X-K10 (1999-10)
 DF40A, DF50A, DF60A (2010+)
 DT40C-W G-X (1986-99)
 DT40W K1-K4 (2001-04)
 DT55, DT65J-X (1988-99)

| REF | OEM |
|----------------|-------------|
| REC57631-96301 | 57631-96301 |



new

 DF25, DF30Y-K6 (2000-06)
 DT20, DT25, DT30G-Y (1986-00)
 DT25, D30 K1-K2 (2001-02)
 DT25C, DT30C K-Y (1989-00)

EXTREMO PARA SELECTOR **ARM, CLUTCH** **HEBEL** **EMBOUT DE SELECTEUR**

| REF | OEM |
|----------------|-----|
| REC23211-94401 | |



 DT25C, DT30C-K-Y (1989-00)
 DT40C-W G-X (1986-99)
 DT40W-K1K4 (2001-04)

RODAMIENTOS **BEARING** **CUSCINETTO** **ROULEMENT**

BOMBA DE ACEITE **OIL PUMP** **POMPA OLIO** **DE POMPE À HUILE**

| REF | OEM |
|----------------|-------------|
| REC08110-60020 | 08110-60020 |



new

 DF150 --> DF350

BOMBA DE AGUA **WATER PUMP** **POMPA ACQUA** **ROULEMENT DE POMPE À EAU**

| REF | OEM |
|----------------|-------------|
| REC09263-25062 | 09263-25062 |



new

 DF40, DF40X-K10 (1999-10)
 DT40C-W G-X (1986-99)
 DT40W K1-K4 (2001-04)

| REF | OEM |
|----------------|-------------|
| REC09263-25025 | 09263-25025 |
| | 09263-25048 |
| | 09263-25L02 |



new

**CIRCLIP,
BOMBA DE AGUA**

CLIP

CLIP

CLIPS

| REF | OEM |
|----------------|-------------|
| REC09380-15001 | 09380-15001 |

new

 DF8A, DF9.9A (AR) (2010+)
 DF9.9B, DF15A, DF20A (2015+)
 DT9.9, DT15 (1989-04)

**EJE TRANSMISIÓN
SUPERIOR**

UPPER,
DRIVE SHAFT

ALBERO DI TRASMISSIONE
SUPERIORE

SUPERIEUR D'ARBRE DE
TRANSMISSION

| REF | OEM |
|----------------|-------------|
| REC08110-60020 | 08110-60020 |

new

 DF8 --> DF20
 DT9.9, DT15

| REF | OEM |
|----------------|-------------|
| REC09265-17002 | 09265-17002 |

new

 DT20R, DF25, DF25V2 (2006-13)
 DF25, DF30Y-K6 (2000-06)
 DF25A, DF30A (2015+)
 DT20, DT25, DF30G-Y (1986-00)
 DT25, DT30 K1-K2 (2001-02)
 DT25C, DT30C K-Y (1989-00)

**EJE TRANSMISIÓN
INFERIOR**

LOWER,
DRIVE SHAFT

ALBERO DI TRASMISSIONE
INFERIORE

INFERIEUR D'ARBRE DE
TRANSMISSION

| REF | OEM |
|----------------|----------------------------|
| REC09263-22L03 | 09263-22L03 09263-22039 |

new

 DF40A, DF50A, DF60A (2010-19)
 DF40, DF50X-K10 (1999-10)
 DT40C-W G-X (1986-99)
 DT40W K1-K4 (2001-04)

| REF | OEM |
|----------------|-------------|
| REC09263-20046 | 09263-20046 |

new

 DF20R, DF25, RVZ (2006-13)
 DF25 (R) QVZ (2013)
 DF255, DF30Y K-6 (200-06)
 DF25A, DF30A (2015+)
 DT20, DT25, DT30G-Y (1986-00)
 DT25, DT30 K1-K2 (2001-02)
 DT25C, DT30K-Y (1989-00)

| REF | OEM |
|----------------|-------------|
| REC09263-15019 | 09263-15019 |

new

 DF15 (2012) 01503F
 DF9.9, DF15T-K3 (1996-03)
 DF9.9, DF15(R) (2004-11)
 DT15C (1989-1997)
 DT5, DT6, DT8 G-Y (1986-00)
 DT6, DT8 Y-K2 (2000-02)
 DT9.9, DT15 K1-K4 (2001-04)
 DT9.9K, DT15K G-Y (1986-00)

DIÁBOLO

DIABOLO

DIABOLO

DE DIABOLO

| REF | OEM |
|----------------|-------------|
| REC08110-60050 | 08110-60050 |

new

 DF8A, DF9A (2012+)
 DF9.9, DF15 (1996-2012)
 DF9.9B, DF15A, DF20A (2015+)
 DT9.9, DT15 (1986-04)

| REF | OEM |
|----------------|-------------|
| REC08113-60060 | 08113-60060 |

new

 DF25A, DF30A (2015+)
 DF20R, DF25RVZ (2006-11)
 DF25, DF30Y-K6 (2000-06)
 DT20, DT25, DT30 (1986-02)

| REF | OEM |
|----------------|-------------|
| REC09263-20047 | 09263-20047 |

new

 DF25A, DF30A (2015+)
 DF25, DF30Y-K6 (2000-06)
 DF25, DF25R, DF25QVZ (2013)
 DF20R, DF25, DF25RVZ (2006-11)
 DT20, DT25, DT30G-Y (1986-00)
 DT25, DT30 K1-K2 (2001-02)
 DT25C, DT30C K-Y (1989-00)

| REF | OEM |
|----------------|-------------|
| REC09263-22020 | 09263-22020 |

new

 DF40A, DF50A, DF60A (2010+)
 DF40, DF50X-K10 (1999-10)
 DT40C-W G-X (1986-99)
 DT40W K1-K4 (2001-04)
 DT55, DT65 J-X (1988-99)

PIÑÓN DE ATAQUE

INITIATIVE GEAR

PIGNONE ATTACCO

PIGNON D'ATTAQUE

| REF | OEM |
|----------------|----------------------------|
| REC09263-20L04 | 09263-20L04 09263-20024 |

 **new**

 DF8A /AR, DF9.9A/AR (2013-16)
DF9.9B, DF15A, DF20A (2013-16)

| REF | OEM |
|----------------|-------------|
| REC57311-99J10 | 57311-99J10 |

 **new**

 DF8A, DF9.9A (AR) (2012+)
DF9.9B, DF15A, DF20A (2013+)

| REF | OEM |
|----------------|----------------------------|
| REC57311-98600 | 57311-98601 57311-98600 |

 **new**

 DF4, DF5, DF6 (2002-11)
DT4-J4, DT5Y (1988-00)
DT4 K1 (2001)
DT5Y (1998-02)

| REF | OEM |
|----------------|----------------------------|
| REC57311-94402 | 57311-94401 57311-94402 |

 **new**

 DT40 (1986-04)

| REF | OEM |
|----------------|--|
| REC57311-96311 | 57311-96310 57311-96311 57311-96320 57311-91L00 |

 **new**

 DT20, DT25, DT30 (1986-06)
DF20, DF25 (RVZ) (2006-13)

| REF | OEM |
|----------------|-------------|
| REC57311-93901 | 57311-93901 |

 **new**

 DT415C (1989-97)

| REF | OEM |
|----------------|----------------------------|
| REC57311-93910 | 57311-93910 57311-90L00 |

 **new**

 DT9.9, DT15 (2001-04)
DF9.9, DF15 (1996-04)

PIÑÓN MARCHA AVANTE

POSITIVE GEAR

PIGNONE MARCIA AVANTI

PIGNON DE MARCHÉ AVANT

| REF | OEM |
|----------------|--|
| REC57510-91J00 | 57510-91J00 57510-98600 57510-98610 57510-98611 |

 **new**

 DT4/J4, DT5Y (1988-00)
DT4 K1 (2001)
DT5Y (1998-02)
DF4, DF5, DF6 (2002+)

| REF | OEM |
|----------------|----------------------------|
| REC57510-89J00 | 57510-89J00 57510-91L00 |

 **new**

 DT25, DT30 (2001-02)
DF25, DF30 (2000-06)
DF20R, DF25 (R) (VZ) (2006-13)

| REF | OEM |
|----------------|-------------|
| REC57510-93902 | 57510-93902 |

 **new**

 DT15C (1989-97)

| REF | OEM |
|----------------|----------------------------|
| REC57510-93910 | 57510-93910 57510-90L00 |

 **new**

 DT9.9, DT15 (2001-04)
DF9.9, DF15 (1996-11)

| REF | OEM |
|----------------|---|
| REC57510-94402 | 57510-94402 57510-94401 57510-94400 |

 **new**

 DT40 (1986-04)

PIÑÓN MARCHA ATRÁS

REVERSE GEAR

| REF | OEM |
|---|---|
| REC57521-91J00 | |
|  | DF4, DF5, DF6 (2002-15) DT4/J4, DT5Y (1988-00) DT4K1 (2001) DT5Y (1998-02) |





| REF | OEM |
|---|----------------------------|
| REC57521-93902 | 57521-93902 57310-93850 |
|  | DT15C (1989-97) |





| REF | OEM |
|---|----------------------------|
| REC57521-94400 | 57521-94400 57310-94401 |
|  | DT40 (1986-04) |

PIGNONE MARCIA
INDIETROPIGNON DE MARCHÉ
ARRIERE

| REF | OEM |
|---|--|
| REC57521-89J00 | 57521-89J00 |
|  | DF25, DF30 82000-06) DF20R, DF25 (R,Q) (VZ) (2006-13) |



| REF | OEM |
|---|--|
| REC57521-93910 | 57521-93910 57521-90L00 |
|  | DF9.9, DF15 (1996-11) DT9.9, DT15 (2001-04) |





| REF | OEM |
|---|----------------------------|
| REC57521-96312 | 57521-96312 57521-96311 |
|  | DT20, DT25, DT30 (1986-02) |



ARANDELA / GRUESOS

WASHER / SHIM

| REF | OEM |
|---|---|
| REC09160-26015 | 09160-26015 26.2 x 42 x 4.0 mm |
|  | DF40, DF50X-K10 (1999-10) DT40C-W G-X (1986-99) DT40W K1-K4 (2001-04) |



| REF | OEM |
|---|---|
| REC09160-20027 | 09160-20027 |
|  | DF9.9 (2004-10) DT15, DF15 (1983-15) DF20 (2011-15) DF8A/AR, DF9.9A/AR (2010+) DF9.9B, DF15A, DF20A (2013+) |





| REF | OEM |
|---|-----------------------------------|
| REC09160-20041 | 09160-20041 T: 1.0 |
|  | DT9.9 (1983-87) DT15 (1983-97) |





RONDELLA / SPESSORE

RONDELLE / CALE

| REF | OEM |
|---|---|
| REC09160-21009 | 09160-21009 21 x 35 x 2.75 mm |
|  | DF8A, DF8AR, DF9.9A, DF9.9AR (2010+) DF9.9, DF15T-K3 (1996-03) DF15 (2012) DF9.9, DF15(R) (2004-11) DF9.9B, DF15A, DF20A (2013) DT9.9K, DT15G-Y (1986-00) DT15C (1989-97) DT9.9, DT15K1-K4 (2001-04) |



| REF | OEM |
|---|---|
| REC09160-20042 | 09160-20042 T:1.1 |
| REC09160-20043 | 09160-20043 T:1.2 |
| REC09160-20044 | 09160-20044 T:0.7 |
|  | DF8A, DF8AR, DF9.9A, DF9.9AR (2010+) DF9.9, DF15T-K3 (1996-03) DF15 (2012) DF9.9, DF15(R) (2004-11) DF9.9B, DF15A, DF20A (2013) DT9.9K, DT15G-Y (1986-00) DT15C (1989-97) DT9.9, DT15K1-K4 (2001-04) |



SISTEMA DE PROPULSIÓN PROPULSION SYSTEM

SISTEMA DI PROPULSIONE SYSTEME DE PROPULSION

| HÉLICES ALUMINIO E INOXIDABLE DE 3 Y 4 PALAS | 3 & 4 BLADE ALUMINIUM & SS PROPELLERS | ELICHE ALLUMINIO E INOX DA 3 E 4 PALE | HELICE ALUMINIUM ET INOX 3 ET 4 PALES |
|--|--|---|--|
| CÓDIGO DE REFERENCIAS | PART NO. CODING SYSTEM | SISTEMA DI CODICE | CODAGE DES REFERENCES |
| | | | |
| 1. Mercury, Mariner 2. Johnson, Evinrude 3. Yamaha 4. Suzuki 5. Tohatsu 6. 7. 8. Volvo Penta 9. Rubex System | 0.5, 6, 8 and 9.8 HP Group 1. A Group 2. B Group 3. C Group 4. D Group 5. E Group 6. F Group 7. VP (Std. Hub) 8. VP (Long Hub) | 1. AL 2. Saturn (INOX Stainless Steel) 3. New Saturn (INOX Stainless Steel) 4. Titan (INOX Stainless Steel) 5. HR Titan (INOX Stainless Steel) 6. Scorpion (INOX Stainless Steel) 7. Lexor (INOX Stainless Steel) | 1. 3R Rubber Hub 2. 3L Rubber Hub 3. 4R Rubber Hub 4. 4L Rubber Hub |



AMITA 3



Hélice de aluminio con núcleo de goma de gran resistencia.

Aluminum propeller with heavy duty rubber hub.

Eliche di alluminio con mozzi in gomma ad alta resistenza.

Hélice en aluminium avec moyeu en caoutchouc



AMITA 4



Hélices de aluminio con núcleo de goma de gran resistencia. Van muy suaves a poca velocidad y hace el barco muy manejable con la mar picada.

Aluminum propeller with heavy duty rubber hub. Smoother low speed makes the offshore boating activity much easier.

Eliche di alluminio con mozzo in gomma ad alta resistenza. Molto morbido a bassa velocità e rende la barca molto maneggevole con mare cattivo.

Hélice en aluminium avec moyeu en caoutchouc. Permet d'aller doucement à basse vitesse et rende le bateau très maniable lorsque la mer est agitée



LEXOR



Hélices de acero inoxidable. Gran diámetro del área de las palas para barcos pesados. Gran rendimiento en alta velocidad sin sacrificar las velocidades medias. Excelente ahorro de combustible.

Stainless steel propeller. Large diameter and blade area for big boat loads. Great high speed performance without sacrificing mid-range speeds. Excellent fuel economy.

Eliche di acciaio inox. Grande diametro delle pale per imbarcazioni pesanti. Grandi prestazioni ad alta velocità senza sacrificare velocità medie. Eccellente risparmio di carburante.

Hélice inox, grand diamètre pour bateaux lourds. Excellentes performances à grande vitesse sans sacrifier les vitesses moyennes. Excellente économie de carburant.



NEW SATURN



Hélices de acero inoxidable. Ofrece buena aceleración y rendimiento. Tamaño más pequeño que ofrece un diámetro extragrande.

Stainless steel propeller. Offers good acceleration & all-round performance. Smaller pitch sizes offered in extra large diameter with increased blade area.

Eliche di acciaio inox. Buona accelerazione. Piccole dimensioni che offre un più grande diametro.

Hélice inox, offrant de bonnes accélérations et performances. Taille de pas réduite pour les modèles de grands diamètres avec une surface de pale plus importante.

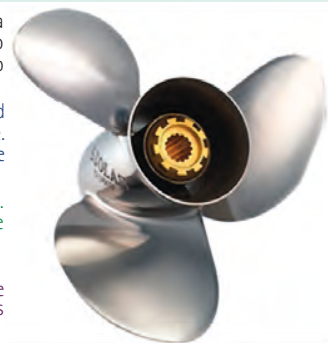

HR TITAN 3 PROP



Hélice de acero inoxidable. Alto rendimiento para cascos de alta velocidad. La inclinación de la hoja proporciona un excelente elevación de proa y aceleración. El diseño de copa grande aumenta la mordida y reduce el deslizamiento.

Stainless steel propeller. Performance prop for high speed planning hulls. High rake blade design provides excellent bow lift and acceleration. Heavy cup design increases bite and reduces slip.

Eliche in acciaio inox. Alte prestazioni per scafi ad alta velocità. Il passo della pala fornisce un'eccellente spinta e accelerazione. Il disegno aumenta le prestazioni.

Hélice en acier inoxydable. Hélice de performance pour les coques de planification à grande vitesse. La conception de la lame à haut râteau offre une excellente portance et accélération de l'arc. La conception lourde de la tasse augmente la morsure et réduit le glissement.



GUÍA DE HÉLICES CON NÚCLEO INTEGRADO **PROPELLERS APPLICATION WITH RUBBER HUB** **GUIDA ELICHE CON MOZZO** **GUIDE DES HELICES ET MOYEUX**

|  2T STROKES 4T STROKES R.O. OEM A B D P R AL | INOX STAINLESS STEEL | | |
|--|----------------------|-----------------|--|
| | AMITA 3 | AMITA 4 | NEW SATURN LEXOR HR TITAN 3 |
| DF4 | | | |
| DF5 | ✓ | 58110-91JN0-019 | 10 3 8 7 R SOL4011-079-07S |
| DF6 (2004+) | | | |
| DT9.9 (1983-97) | | 58100-89L00-019 | 7 SOL4111-093-07A |
| DT15 (1983-97) | | 58100-90L41-019 | 8 SOL4111-093-08A |
| DF8 (2010+) | ✓ | 58100-89L20-019 | 10 3 9,25 9 R SOL4111-093-09A |
| DF9.9 (1996+) | ✓ | 58100-89L60-019 | 10 SOL4111-093-10A |
| DF15 (1996+) | | 58100-89L70-019 | 11 SOL4111-093-11A |
| DF20 (2013+) | | 58100-89L50-019 | 12 SOL4111-093-12A |
| DT20 | | 58100-96410-019 | 10 ^{1/4} 10 SOL4211-110-09 |
| DT25/C | | 58100-96420-019 | 11 SOL4211-105-11 |
| DT30/C | | 58100-96430-019 | 12 SOL4211-103-12 |
| DF25 | ✓ | 58100-96440-019 | 10 3 13 R SOL4211-101-13 |
| DF30 | | 58100-95D00-019 | 14 SOL4211-100-14 |
| Thru-Hub | | 58100-96460-019 | 15 SOL4211-100-15 |
| DT35 | | 58100-94302-019 | 11 ^{1/2} 9 SOL4311-121-09 |
| DT40 | | 58100-95212-019 | 11 ^{1/2} 10 SOL4311-120-10 |
| DT50 | | 58100-95222-019 | 11 ^{1/2} 11 SOL4311-118-11 |
| DT55 | | | |
| DT60 | ✓ | 58100-95393-019 | 13 3 11 ^{5/8} 12 R SOL4311-116-12 |
| DT65 | ✓ | 58100-94313-019 | 11 ^{1/2} 13 SOL4311-116-13 |
| DF40 | | 58100-95353-019 | 11 ^{3/8} 14 SOL4311-116-14 |
| DF50 | | | |
| DF60 (2010+) | | 58100-95363-019 | 11 15 SOL4311-110-15 |
| | | | 14 11 SOL4411-140-11 |
| | | | 13 ^{3/4} 13 SOL4411-138-13 SOL4413-133-13 |
| | | 58100-94500-019 | 13 ^{1/2} 15 V1500 SOL4411-135-15 SOL4413-130-15 SOL4431-135-15 |
| | | 58100-94512-019 | 13 ^{1/4} 17 V1700 SOL4411-133-17 SOL4413-128-17 SOL4431-133-17 |
| DT75 | | 58100-94522-019 | 13 19 V1900 SOL4411-130-19 SOL4413-125-19 SOL4431-130-19 |
| DT85 | | 58100-94532-019 | 13 21 V2100 SOL4411-130-21 SOL4413-125-21 SOL4431-130-21 |
| DT90 | | 58100-95511-019 | 13 ^{1/4} 17 U1700 SOL2431-135-15 |
| DT100 | | 58100-95521-019 | 13 19 U1900 SOL2431-133-17 |
| DT115 | | | |
| DT140 | ✓ | 58100-95530-019 | 13 3 13 21 R U2100 SOL2431-130-19 |
| DF60 | | 58100-94554-019 | 13 ^{1/2} 15 SOL4431-135-15 |
| DF70 (1998-08) | | 58100-94581-019 | 13 ^{1/4} 17 SOL4431-133-17 |
| | | 58100-94561-019 | 13 19 SOL4431-130-19 |
| Thru-hub | | 58100-94571-019 | 13 21 SOL4431-130-21 |
| | | 99105-00100-16P | 13 ^{1/4} 16 SOL4431-135-15 |
| | | 99105-00100-18P | 13 ^{1/4} 18 SOL4431-133-17 |
| | | 99105-00100-20P | 13 ^{1/4} 20 SOL4431-130-19 |
| | | 99105-00100-22P | 13 ^{1/4} 22 SOL4431-130-21 |
| | | 58100-90J40-019 | 15 15 R SOL3413-138-15 |
| | | 58100-90J00-019 | 14 ^{3/4} 17 R SOL3411-139-17 SOL3413-138-17 SOL3451-139-17 |
| | | 58100-90J10-019 | 14 ^{1/2} 19 R SOL3411-139-19 SOL3413-138-19 SOL3451-139-19 |
| | | 58100-90J20-019 | 14 ^{1/4} 21 R SOL3411-139-21 SOL3413-138-21 SOL3451-139-21 |
| DF70A | | 58100-90J22-019 | 14 23 R SOL3451-139-23 |
| DF80A | | | |
| DF90 | | 99105-00700-18P | 18 R SOL3451-139-17 |
| DF115 | ✓ | 99105-0070L-18P | 15 3 18 L SOL3452-139-17 |
| DF140 | | 99105-00700-20P | 20 R SOL3451-139-19 |
| Thru-hub | | 99105-0070L-20P | 2 L SOL3452-139-19 |
| | | 99105-00700-22P | 22 R SOL3451-139-21 |
| | | 99105-0070L-22P | 22 L SOL3452-139-21 |
| | | 99105-00700-24P | 24 R SOL3451-139-23 |

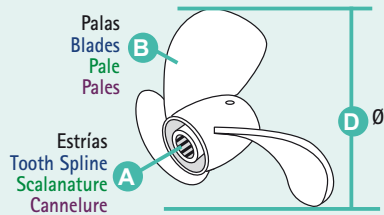

P Paso Pitch Passo Pas
R Rotación L (izquierda) R (derecha)
 Rotation L (left) R (Right)
 Rotazione L (SX) R (DX)
 Rotation L (gauche) R (droit)

| | 2T STROKES | 4T STROKES | R.O. OEM | A B D P R | | | | | AL | | INOX STAINLESS STEEL | | |
|--|---------------|---------------|-------------------|------------------------|------------------------|---------|---|------------|----------------|----------------|-------------------------|----------------|----------------|
| | | | | AMITA 3 | | AMITA 4 | | NEW SATURN | LEXOR | HR TITAN 3 | | | |
| DT150 DT175 DT200 DT225 | | | 58200-87D61-019 | 14 ^{1/2} | 16 | R | | | SOL4513-148-15 | | | SOL4551-148-16 | |
| | | | 58200-87D62-019 | 14 ^{1/2} | 16 | L | | | | | | SOL4552-148-16 | |
| | | | 58200-87D01-019 | 14 ^{1/2} | 18 | R | | | SOL4513-145-17 | | | SOL4551-148-18 | |
| | | | 58200-87D02-019 | 14 ^{1/2} | 18 | L | | | | | | SOL4552-148-18 | |
| | | | 58200-87D11-019 | 14 ^{1/2} | 20 | R | | | SOL4513-143-19 | | | SOL4551-148-20 | |
| | | | 58200-87D12-019 | 14 ^{1/2} | 20 | L | | | | | | SOL4552-148-20 | |
| | | | 58200-87D21-019 | 14 ^{1/2} | 22 | R | | | SOL4513-140-21 | | | SOL4551-143-22 | |
| | | | 58200-87D22-019 | 14 ^{1/2} | 22 | L | | | | | | SOL4552-143-22 | |
| | Thru-hub | | | 99105-00200-16P | 15-14 ^{1/4} | 15-16 | R | | | SOL4511-150-15 | | | SOL4551-148-16 |
| | | | | 99105-0020L-16P | 15-14 ^{1/4} | 15-16 | L | | | SOL4512-150-15 | | | SOL4552-148-16 |
| | | | | 99105-00200-18P | 14.8-14 ^{1/4} | 18 | R | | | SOL4511-148-17 | | | SOL4551-148-18 |
| | | | | 99105-0020L-18P | 14.8-14 ^{1/4} | 18 | L | | | SOL4512-148-17 | | | SOL4552-148-18 |
| | | | | 99105-00200-20P | 14.5-14 ^{1/4} | 20 | R | | | SOL4511-145-19 | | | SOL4551-148-20 |
| | | | | 99105-0020L-20P | 14.5-14 ^{1/4} | 20 | L | | | SOL4512-145-19 | | | SOL4552-148-20 |
| | | | | 99105-00200-22P | 14.3-14 ^{1/4} | 22 | R | | | SOL4511-143-21 | | | SOL4551-143-22 |
| | | | 99105-0020L-22P | 14.3-14 ^{1/4} | 22 | L | | | SOL4512-143-21 | | | SOL4552-143-22 | |
| | | | 99105-00200-24P | 14.2-14 ^{1/4} | 23-24 | R | | | SOL4511-142-23 | | | SOL4551-140-24 | |
| | | | 99105-0020L-24P | 14.2-14 ^{1/4} | 23-24 | L | | | SOL4512-142-23 | | | SOL4552-140-24 | |
| DF150 DF175 DF200 DF225 DF250 DF300 | | | | 99105-00200-16P | 15.8 | 15 | R | | | SOL4511-150-15 | | | |
| | | | | | 15.8 | 15 | L | | | SOL4512-158-15 | | | |
| | | | | 99105-00200-18P | 15.5 | 17 | R | | | SOL4511-155-17 | | | |
| | | | | | 15.5 | 17 | L | | | SOL4512-155-17 | | | |
| | | | | | 15 ^{3/8} | 18 | R | | | | | | SOL4571-154-18 |
| | | | | 15 ^{3/8} | 18 | L | | | | | | SOL4572-154-18 | |
| | | | 99105-00200-20P | 15.3 | 19 | R | | | SOL4511-153-19 | | | | |
| | | | | 15.3 | 19 | L | | | SOL4512-153-19 | | | | |
| | | | | 15 ^{1/8} | 20 | R | | | | | | SOL4571-151-20 | |
| | | | | 15 ^{1/8} | 20 | L | | | | | | SOL4572-151-20 | |
| | | | 99105-00200-22P | 15.3 | 21 | R | | | SOL4511-153-21 | | | | |
| | | | | 15.3 | 21 | L | | | SOL4512-153-21 | | | | |
| | | | | 14 ^{7/8} | 22 | R | | | | | | SOL4571-149-22 | |
| | | | | 14 ^{7/8} | 22 | L | | | | | | SOL4572-149-22 | |
| | | | | 14 ^{3/4} | 23 | R | | | | | | SOL4571-148-23 | |
| | | | 14 ^{3/4} | 23 | L | | | | | | SOL4572-148-23 | | |

NÚCLEO INTERCAMBIABLE INTERCHANGEABLE HUB **MOZZO INTERCAMBIABILE MOYEU INTERCHANGEABLE**

| | 2T STROKES | 4T STROKES | A | REF | |
|------------------------------|---------------|---------------|----|------------|---|
| DT50, DT50M (1983-84) | | | | | |
| DT55 (1985-97) | | | 13 | SOLRBX-115 | C |
| DT60 (1983-84) | | | | | |
| DT65 (1985-97) | | | | | |
| DF70A, DF80A, DF90A (2009+) | ✓ | | 15 | SOLRBX-150 | D |
| DF90, DF115 (2001+) | ✓ | | 15 | SOLRBX-125 | D |
| DF140 (2001+) | ✓ | | 15 | SOLRBX-126 | D |
| 75-140 HP DF60, DF70 (1979+) | | | 13 | SOLRBX-110 | D |
| DT150-225 HP (1986+) | ✓ | | 15 | SOLRBX-104 | E |
| DF150-300 HP | ✓ | ✓ | | | |



RUBEX

HÉLICES PARA NÚCLEO INTERCAMBIABLE

PROPELLERS FOR INTERCHANGEABLE HUB

ELICHE PER MOZZO INTERCAMBIABILE

HELICES AVEC MOYEU INTERCHANGEABLE

| | B | D | P | R | AL |
|------------------------|---|-------|----|---|----------------|
| C 30-75 HP | 3 | 12.1 | 9 | R | SOL9311-121-09 |
| | | 12 | 10 | R | SOL9311-120-10 |
| | | 11.6 | 11 | R | SOL9311-116-11 |
| | | 11.4 | 12 | R | SOL9311-114-12 |
| | | 11.1 | 13 | R | SOL9311-111-13 |
| | | 11.1 | 14 | R | SOL9311-111-14 |
| | | 11 | 15 | R | SOL9311-110-15 |
| D 40-140 HP | 3 | 14 | 9 | R | SOL9411-140-09 |
| | | 14 | 11 | R | SOL9411-140-11 |
| | | 13.75 | 13 | R | SOL9411-138-13 |
| | | 13.50 | 15 | R | SOL9411-135-15 |
| | | 13.25 | 17 | R | SOL9411-133-17 |
| | | 13.2 | 19 | R | SOL9411-132-19 |
| | | 13.2 | 21 | R | SOL9411-132-21 |
| E 135-350 HP | 3 | 15.5 | 11 | R | SOL9511-155-11 |
| | | 15.3 | 13 | R | SOL9511-153-13 |
| | | 16 | 13 | R | SOL9511-160-13 |
| | | 15 | 15 | R | SOL9511-150-15 |
| | | 15 | 15 | L | SOL9511-150-15 |
| | | 14.8 | 17 | R | SOL9511-148-17 |
| | | 14.8 | 17 | L | SOL9511-148-17 |
| | | 14.5 | 19 | R | SOL9511-145-19 |
| | | 14.5 | 19 | L | SOL9511-145-19 |
| | | 14.3 | 21 | R | SOL9511-143-21 |
| | | 14.3 | 21 | L | SOL9511-143-21 |

| | B | D | P | R | INOX STAINLESS STEEL |
|-----------------------|----|------------------------|----------------|--------|-------------------------|
| C 30-75 HP | 3 | 11 5/8 | 11 | R | SOL9331-116-11 |
| | | 11 3/8 | 12 | R | SOL9331-114-12 |
| | | 11 1/8 | 13 | R | SOL9331-111-13 |
| | | 11 1/8 | 14 | R | SOL9331-111-14 |
| | | 11 | 15 | R | SOL9331-110-15 |
| | | 13 3/4 | 13 | R | SOL9431-138-13 |
| | | 13 3/4 | 13 | L | SOL9432-138-13 |
| D 40-140 HP | 3 | 13 1/2 | 15 | R | SOL9431-135-15 |
| | | 13 1/2 | 15 | L | SOL9432-135-15 |
| | | 13 1/4 | 17 | R | SOL9431-133-17 |
| | | 13 1/4 | 17 | L | SOL9432-133-17 |
| | | 13 | 19 | R | SOL9431-130-19 |
| | | 13 | 19 | L | SOL9432-130-19 |
| | | 13 | 21 | R | SOL9431-130-21 |
| E 90-140 HP | 3 | 14 1/2 | 15 | R | SOL9531-145-15 |
| | | 14 1/2 | 15 | L | SOL9532-145-15 |
| | | 14 1/4 | 17 | R | SOL9531-143-17 |
| | | 14 1/4 | 17 | L | SOL9532-143-17 |
| | | 14 | 19 | R | SOL9531-140-19 |
| | | 14 | 19 | L | SOL9532-140-19 |
| | | 14 | 21 | R | SOL9531-140-21 |
| | | 14 | 21 | L | SOL9532-140-21 |
| | | 14 | 23 | R | SOL9531-140-23 |
| | | 14 | 23 | L | SOL9532-140-23 |
| | | E 135-350 HP | 3 | 15 3/4 | 15 |
| 15 3/4 | 15 | | | L | SOL9572-158-15 |
| 15 1/2 | 17 | | | R | SOL9571-155-17 |
| 15 1/2 | 17 | | | L | SOL9572-155-17 |
| 15 1/4 | 19 | | | R | SOL9571-153-19 |
| 15 1/4 | 19 | | | L | SOL9572-153-19 |
| 15 | 21 | | | R | SOL9571-150-21 |
| 15 | 21 | | | L | SOL9572-150-21 |
| 14 3/4 | 23 | | | R | SOL9571-148-23 |
| 14 3/4 | 23 | | | L | SOL9572-148-23 |
| 14 1/2 | 25 | | | R | SOL9571-145-25 |
| 14 1/2 | 25 | L | SOL9572-145-25 | | |

RUBEX



Núcleo intercambiable (no incluido).
Interchangeable hub (not included).
Mozzo intercambiable (non incluso).
Moyeu interchangeable (non inclus)

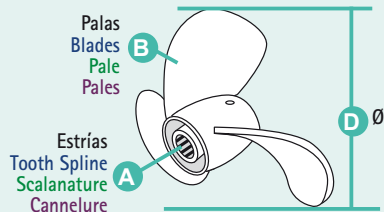

- P** Paso
Pitch
Passo
Pas
- R** Rotación L (izquierda) R (derecha)
Rotation L (left) R (Right)
Rotazione L (SX) R (DX)
Rotation L (gauche) R (droit)

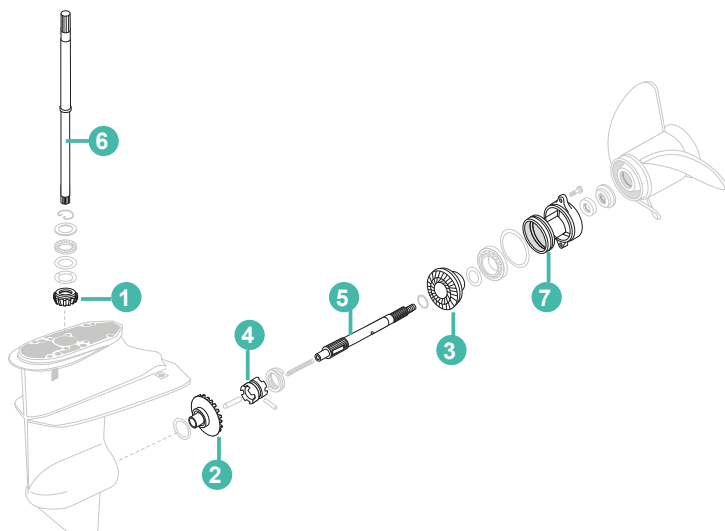

| GUÍA PIEZAS DE COLA | STERN DRIVE COMPONENTS APPLICATIONS | | | GUIDA RICAMBI PIEDE | | GUIDE DES PIÈCES D'EMBASE | | |
|------------------------|--|--|--|------------------------|--|------------------------------|--|--|
|------------------------|--|--|--|------------------------|--|------------------------------|--|--|

| | 1 | 2 | 3 | 4 | 5 | 6 L | 6 S | 7 |
|-------------------------|---------|----------------|----------------|----------------|----------------|----------------|----------------|----------------|
| DT2 | 1986-00 | REC57311-98400 | | | | | | |
| DT2.2 K1-K5 | 2001-05 | REC57311-98400 | | | | | | |
| DT9.9K DT15K-G-Y | 1986-00 | REC57311-93901 | REC57510-93902 | REC57521-93902 | REC57610-93901 | REC57100-93902 | REC57110-93912 | REC56120-93900 |
| DT9.9 DT15K1-K4 | 2001-04 | REC57311-93910 | REC57510-93910 | REC57521-93910 | REC57610-93901 | REC57100-93902 | REC57110-93912 | REC56120-93900 |
| DF9.9 DF15T-K3 | 1996-03 | REC57311-93910 | REC57510-93910 | REC57521-93910 | REC57610-93901 | REC57100-93902 | REC57110-93912 | REC56120-93900 |
| DF9.9 DF15R | 2004-11 | REC57311-93910 | REC57510-93910 | REC57521-93910 | REC57610-93901 | REC57100-93902 | REC57110-93912 | REC56120-93900 |
| DT15C | 1989-97 | REC57311-93901 | REC57510-93902 | REC57521-93902 | REC57610-93901 | | | REC56120-93900 |
| DF15 | 2012 | | | | REC57610-93901 | REC57100-93902 | REC57110-93912 | |
| DT20 DT25 DT30G-Y | 1986-00 | REC57311-96311 | REC57510-89J00 | REC57521-96312 | | | | |
| DT25C DT30C-K-Y | 1989-00 | REC57311-96311 | REC57510-89J00 | REC57521-96312 | | | | |
| DT25 DT30K1-K2 | 2001-02 | REC57311-96320 | REC57510-89J00 | REC57521-89J00 | | | | |
| DF25 DF30Y-K6 | 2000-06 | REC57311-96320 | REC57510-89J00 | REC57521-89J00 | | | | |
| DT40C-W G-X | 1986-99 | REC57311-94402 | REC57510-94402 | REC57521-94400 | | REC57110-94441 | REC57110-94411 | |
| DT40W K1-K4 | 2001-04 | REC57311-94402 | REC57510-94402 | REC57521-94400 | | REC57110-94441 | REC57110-94411 | |
| DF40 DF50X-K10 | 1999-10 | | | REC57621-94403 | | | | |

| KIT CIERRE DE HÉLICE | PROPELLER NUT KIT | KIT CHIUSURA ELICA | KIT ECROU D'HELICE |
|----------------------|-------------------|--------------------|--------------------|
|----------------------|-------------------|--------------------|--------------------|

| REF | OEM | | REF | OEM | |
|---------------------------------|-------------|-------------------------|-----------------------------|----------------------------|--|
| REC57630-96300 | 57630-96300 | | REC57630-94300 | 57630-94300 57630-94301 | |
| DF20R, DF25, DF25R V2 (2006-11) | | | DF40, DF50X-K10 (1999-10) | | |
| DF25, DF30Y-K6 (2000-06) | | | DF40A, DF50A, DF60A (2010+) | | |
| DT20, DT25, DT30G-Y (1986-00) | | | DT40C-W G-X (1986-99) | | |
| DT25, DT30K1-K2 (2001-02) | | | DT40W K1-K4 (2001-04) | | |
| DT25C, DT30C-K-Y (1989-00) | | DT55, DT65J-X (1988-99) | | | |

| REF | OEM | | REF | OEM | |
|----------------------------|-------------|-----------------------------------|------------------------------|-------------|--|
| REC57630-94500 | 57630-94500 | | REC57630-92E00 | 57630-92E00 | |
| DF40A, DF50A, DF60A (2014) | | | DF150, DF175Z-T(G) (2006-14) | | |
| DF60, DF70W-K9 (1998-09) | | | DF200, DF225, DF250 (2004+) | | |
| DT75, DT85J-Y (1988-00) | | | DF200A (20015+) | | |
| DT90, DT100L-Y (1990-00) | | | DF300A-T-Z (2007-12) | | |
| DT115, DT140G-Y (1986-00) | | DF150, DT200, DT225W-K3 (1998-03) | | | |
| DF60, DF70 V-STYLE | | V6 H-Y (1987-00) | | | |

PASADOR DE HÉLICE

PROPELLER PIN

PIN ELICA

CLAVETTE D'HELICE

| REF | OEM |
|---------------|-------------|
| REC9202-04002 | 09202-04002 |

 DF2.5 (2006-13)
DF4, DF5, DF6 (2002-11)
DT2, DT2.2 G-Y (1986-00)
DT4/J4 (1988-00)
DT5Y (1988-02)



new

PASADOR DE LA TUERCA DE HÉLICE

COTTER PIN

COPPIGLIA

GOUPILLE D'ECROU D'HELICE

| REF | OEM |
|----------------|-------------|
| REC91490-40030 | 09204-03003 |

 2.5 --> 350 HP



new

| REF | OEM |
|---------------|-------------|
| REC9204-02004 | 09204-02004 |

 8 --> 20HP



new

| REF | OEM |
|-----------------|-------------|
| PAGB/T91-1.6X12 | 09204-02001 |

 DF2.5
DT2, DT2.2HP
HÉLICE DE PLÁSTICO
PLASTIC PROPELLER
ELICA IN PLASTICA
HELICE DE PLASTIQUE



new

TUERCA DE HÉLICE

PROPELLER NUT

DADO DI ELICA

ÉCROU D'HÉLICE

| REF | OEM |
|----------------|-------------|
| REC09141-12005 | 09141-12005 |

 DF8A, DF9.9A (AR) (2010+)
DF9.9, DF15T-K3 (1996-03)
DF9.9, DF15(R) (2004-11)
DF9.9B, DF15A, DF20A (2013+)
DT15C (1989-97)
DT9.9, DT15K1-K4 (2001-04)
DT9.9K, DT15K G-Y (1986-00)



new

| REF | OEM |
|----------------|-------------|
| REC90171-18M04 | 09141-18005 |

 40 --> 300 HP
DT & DF



new

SEPARADOR DE HÉLICE

PROPELLER WASHER

DISTANZIALE ELICA

ENTRETOISE D'HELICE

| REF | OEM |
|----------------|-------------|
| REC57632-94J00 | 57632-94J00 |

DF8A, DF9.9A (AR) (2010+)
DF9.9, DF15(R) (2004-11)
DF9.9B, DF15A, DF20A (2013+)

TRASERO | BACK | POSTERIORE | ARRIERE



new

| REF | OEM |
|----------------|----------------------------|
| REC57633-93901 | 57633-93901 57633-93900 |

 DF8A, DF9.9A (AR) (2010+)
DF9.9, DF15(R) (2004-11)
DF9.9B, DF15A, DF20A (2013+)

DELANTERO | FRONT | ANTERIORE | AVANT



new

REF --> RO / OEM

| REF | R.O. / OEM | |
|----------------|-------------|-----------------------------|
| C | | |
| CEF500312 | 17461-95201 | 469 |
| CEF500319 | 17461-92D02 | 469 |
| CEF500329 | 17461-93901 | 469 |
| CEF500329 | 17461-93902 | 469 |
| CEF500329 | 17461-93903 | 469-470 |
| CEF500336 | 17461-98501 | 469 |
| CEF500336 | 17461-98502 | 469 |
| CEF500336 | 17461-98503 | 469-470 |
| CEF500360 | 17461-95300 | 469 |
| CEF500360 | 17461-95301 | 469 |
| CEF500360 | 17461-95302 | 469 |
| CEF500360 | 17461-95501 | 469 |
| CEF500361 | 17461-94700 | 469 |
| CEF500361 | 17461-94701 | 469 |
| CEF500361 | 17461-95200 | 469 |
| CEF500362G | 17451-96301 | 469 |
| CEF500362G | 17461-96301 | 469 |
| CEF500362G | 17461-96310 | 469 |
| CEF500362G | 17461-96312 | 470 |
| CEF500365 | 17461-87E10 | 470 |
| CEF500365 | 17461-87E11 | 470 |
| CEF500365 | 17461-87E12 | 469-470 |
| CEF500367 | 17461-90J00 | 469 |
| CEF500367 | 17461-90J01 | 469-470 |
| CEF500367 | 17461-94510 | 469 |
| CEF500393 | 17461-93J00 | 470 |
| CEF500398 | 17461-93001 | 469 |
| CEF500398 | 17461-93002 | 469 |
| CEF500398 | 17461-93003 | 469 |
| CEF500398 | 17461-93004 | 469 |
| CEF500399 | 17461-96400 | 469 |
| CM11130-94600 | 11130-94600 | 477-479 |
| CM11130-94600A | 11130-94600 | 477 |
| CM41811-98500 | 41811-98500 | 476-501 |
| CM5033167 | 41810-98500 | 439 |
| CM55125-87D00 | 55125-87801 | 477 |
| CM55125-87D00 | 55320-93900 | 477 |
| CM55125-87D00A | 55125-87801 | 477 |
| CM55125-87D00A | 55320-93900 | 477 |
| CM55125-94400 | 55125-94400 | 511 |
| CM55125-94502 | 55125-94502 | 477 |
| CM55125-95301A | 55125-95301 | 477 |
| CM55125-95500 | 55125-87E01 | 477 |
| CM55125-95500 | 55125-95500 | 509 |
| CM55125-95500A | 55125-87E01 | 477 |
| CM55125-96310 | 55125-96310 | 477-505-507 |
| CM55125-96310A | 55125-96310 | 477 |
| CM55300-95500 | 55300-95500 | 476-499-501-507-509-511 |
| CM55300-95500A | 55300-95500 | 476 |
| CM55320-95310 | 55320-95310 | 476 |
| CM55320-95310 | 55320-95311 | 517 |
| CM55320-95310A | 55320-95310 | 476 |
| CM55320-98400 | 55320-98400 | 476 |
| CM55320-98400A | 55320-98400 | 476 |
| CM55320-98600 | 55320-98600 | 477 |
| CM55320-98600A | 55320-98600 | 477 |
| CM55321-87J00 | 55321-87J00 | 476-497-501-511 |
| CM55321-87J00 | 55321-87J01 | 476-479-499-503 |
| CM55321-87J00A | 55321-87J00 | 476 |
| CM55321-87J00A | 55321-87J01 | 476 |
| CM55321-87J00A | 55321-87J01 | 439-440-441-477-512-515-516 |
| CM55321-90J01 | 55321-90J01 | 516 |
| CM55321-90J01A | 55321-90J01 | 477 |
| CM55321-93900 | 55320-93900 | 477 |
| CM55321-93900 | 55321-93900 | 501 |
| CM55321-93900A | 55320-93900 | 477 |
| CM55321-94900 | 55320-94900 | 476 |
| CM55321-94900A | 55320-94900 | 441 |
| CMSZ4050KITA | | 477 |
| CMSZ90140KITA | | 477 |
| CHAL90C | | 456 |
| CHAQL78C | | 456 |
| CHAQL82C | | 456 |
| CHAQL82YC | | 456 |
| CHAQL86C | | 456 |
| CHAQL87YC | | 456 |
| CHARA8HC | | 456 |
| CHARC9YC | | 456 |
| CHARN9YC | | 456 |
| G | | |
| GS11290 | | 461 |
| GS11291 | | 461 |
| GS11292 | | 461 |
| GS11294 | | 461 |
| GS30435 | | 447 |
| GS31001 | | 447 |
| GS31002 | | 447 |
| GS31035 | 65750-98505 | 444 |
| GS31036 | 65750-98505 | 444 |
| GS31037 | 65740-99100 | 444 |
| GS31038 | 65720-94411 | 444 |
| GS31039 | 65720-94403 | 444 |
| GS31064 | | 444 |
| GS31065 | | 447 |
| GS31066 | | 447 |
| GS31067 | | 447 |
| GS31068 | | 443 |
| GS31069 | | 443 |

| REF | R.O. / OEM | |
|--------------------|-------------|-----------------------------|
| GS31070 | 65740-95D00 | 444 |
| GS31071 | 65750-95500 | 444 |
| GS31072 | 65750-95500 | 444 |
| GS31089 | 65750-89J11 | 444 |
| GS31090 | 65770-95504 | 442 |
| GS31092 | | 444 |
| GS31095 | 65770-93J12 | 442 |
| GS31096 | | 442 |
| GS31097 | | 442 |
| GS31099 | | 442 |
| GS31155 | | 447 |
| GS31156 | | 447 |
| GS31157 | | 447 |
| GS31166 | | 447 |
| GS31183 | | 442 |
| GS31187 | | 442 |
| GS31189 | | 442 |
| GS35031 | | 442 |
| GS35032 | | 442 |
| L | | |
| LENS3213 | | 445 |
| LENS3227 | 99105-20005 | 446 |
| N | | |
| NGKB6HS | | 456 |
| NGKB6HS-10 | | 456 |
| NGKB7HS | | 456 |
| NGKB7HS-10 | | 456 |
| NGKB8HS | | 456 |
| NGKB8HS-10 | | 456 |
| NGKBKR6E | 09482-00427 | 439-440-441-455 |
| NGKBP5HS | | 456 |
| NGKBP6HS | | 456 |
| NGKBPR5HS | | 456 |
| NGKBPR6ES | 09482-00299 | 439-440-455 |
| NGKBPR6HS | | 456 |
| NGKBPR7HS-10 | | 456 |
| NGKBR4HS | | 456 |
| NGKBR5HS | | 456 |
| NGKBR6HS | | 456 |
| NGKBR6HS-10 | | 456 |
| NGKBR7HS | | 456 |
| NGKBR7HS-10 | | 456 |
| NGKBR8HCS-10 | | 456 |
| NGKBR8HIX | | 456 |
| NGKBR8HS | | 456 |
| NGKBR8HS-10 | 94702-00271 | 456 |
| NGKCRPR6EA-9 | 09482-00L04 | 439-440-455 |
| NGKCR6E | 09482-00528 | 439-455 |
| NGKCR6HSA | 09482-00406 | 439-455 |
| NGKDCPR6E | 09482-00446 | 440-455 |
| NGKDKR6E | 09482-00649 | 455 |
| P | | |
| PAF15-07080000 | 15410-94400 | 447 |
| PAF15-13010010W | 67256-95600 | 466 |
| PAF25-00000014 | 09202-08006 | 515-516-517-518 |
| PAF25-07000007W | 67275-95600 | 466 |
| PAF4-04000030 | | 443 |
| PAF4-04090000 | 15100-91J00 | 450 |
| PAF4-04090000 | 15100-91J01 | 450 |
| PAF4-04090000 | 15100-91J02 | 450 |
| PAF4-05000010 | | 443 |
| PAF40-0701000EI | | 446 |
| PAF8-00000003 | 29116-93J10 | 513 |
| PAGB/T5283-M6X25 | 09116-06229 | 497 |
| PAGB/T5783-M6X12 | 09100-06130 | 515-516-476-477-478-479-497 |
| PAGB/T5783-M6X14 | 09103-06281 | 497-512 |
| PAGB/T5783-M6X16 | 09116-06225 | 507 |
| PAGB/T5783-M8X16 | 09117-08037 | 509-511 |
| PAGB/T5783-M8X16 | 09117-08109 | 515 |
| PAGB/T5783-M8X25 | 09117-08057 | 499-503 |
| PAGB/T5783-M8X30 | 09116-08151 | 501-509 |
| PAGB/T5783-M8X30 | 09117-08047 | 501 |
| PAGB/T5783-M8X55 | 09116-08117 | 497 |
| PAGB/T5787-1986 | 09116-08156 | 507 |
| PAGB/T5787-M6X20 | 09116-06106 | 499-503 |
| PAGB/T5787-M6X20 | 09116-06227 | 501 |
| PAGB/T5787-M6X20 | 29116-93J00 | 505 |
| PAGB/T5787-M6X30 | 09116-08122 | 497-499-501-505-509-511 |
| PAGB/T6170-M6 | 29141-93J00 | 507 |
| PAGB/T6184-2000 | 09141-06020 | 503 |
| PAGB/T6184-2000 | 29141-93J00 | 515-516 |
| PAGB/T8.8-2000 | 09125-05046 | 512 |
| PAGB/T818-M4X30 | 09125-04023 | 501-516 |
| PAGB/T818-M6X10 | 09125-06063 | 479 |
| PAGB/T818-M6X14 | 09128-06221 | 499-501 |
| PAGB/T820-M6X20 | 09126-06006 | 497-503-505 |
| PAGB/T848-6 | 09160-06082 | 507 |
| PAGB/T848-6 | 09162-06006 | 439 |
| PAGB/T879.1-2.5X14 | 09202-02006 | 512 |
| PAGB/T889.1-M4 | 09140-04007 | 466 |
| PAGB/T896-6 | 57292-94300 | 439-532 |
| PAGB/T91.1-1.6X12 | 09204-02001 | 499-501-509-511 |
| PAGB/T93-6 | 29162-93J00 | 507 |
| PAGB/T97.1-8 | | 439 |
| PAJASOF404-19-033 | 09280-33005 | 457 |
| PH130-0006 | 31100-89J00 | 457 |
| PH130-0006 | 31100-94400 | 457 |

| REF | R.O. / OEM | |
|----------------|-----------------|---------------------|
| PH130-0006 | 31100-944002 | 457 |
| PH130-0006 | 31100-94401 | 457 |
| PH130-0006 | 31100-95D00 | 457 |
| PH130-0006 | 31100-96310 | 457 |
| PH130-0006 | 31100-96311 | 457 |
| PH130-0007 | 31100-95240 | 457 |
| PH130-0007 | 31100-95242 | 457 |
| PH130-0007 | 31100-95243 | 457 |
| PH130-0052 | 31100-87000 | 457 |
| PH130-0052 | 31100-87D00 | 457 |
| PH130-0052 | 31100-87D10 | 457 |
| PH130-0052 | 31100-92E00 | 457 |
| PH130-0053 | 31100-94500 | 457 |
| PH130-0053 | 31100-94510 | 457 |
| PH130-0053 | 31100-94511 | 457 |
| PH130-0053 | 31100-94512 | 457 |
| PH130-0053 | 31100-94600 | 457 |
| PH130-0053 | 31100-94601 | 457 |
| PH130-0053 | 31100-94610 | 457 |
| PH130-0060 | 31100-95310 | 457 |
| PH130-0060 | 31100-95312 | 457 |
| PH130-0060 | 31100-95313 | 457 |
| PH130-0060 | 31100-95521 | 457 |
| PH130-0060 | 31100-95600 | 457 |
| PH130-0060 | 31100-95601 | 457 |
| PH130-0071 | 31100-90J00 | 457 |
| PH130-0071 | 31100-90J01 | 457 |
| PH130-0075 | 31100-94702 | 457 |
| PH130-0077 | 31100-94J10 | 457 |
| PH130-0077 | 31100-94J20 | 457 |
| PH130-0077 | 31100-94J21 | 457 |
| PH130-0077 | 31100-94J22 | 457 |
| PH130-0077 | 31100-95J00 | 457 |
| PH130-0077 | 31100-95J01 | 457 |
| PH130-0078 | 31100-93J00 | 458 |
| PH130-0078 | 31100-96J00 | 458 |
| PH130-0078 | 31100-96J01 | 458 |
| PH130-0078 | 31100-98L00 | 458 |
| PH130-0078 | 31100-98L10 | 458 |
| PH130-0079 | 31100-87500 | 458 |
| PH130-0079 | 31100-87J00 | 458 |
| PH130-0079 | 31100-87J10 | 458 |
| PH130-0079 | 31100-87J11 | 458 |
| PH200-T024 | 38100-87D10-OED | 462 |
| PH200-T024 | 38100-87D10-OIT | 462 |
| PH200-T024 | 38100-87D10-35J | 462 |
| PH200-T024 | 38100-87E20-OED | 462 |
| PH200-T024 | 38100-92E00-OED | 462 |
| PH200-T027 | 48500-95550-OED | 461 |
| PH200-T027 | 48500-95680-OED | 461 |
| PH200-T046 | 38100-87J11 | 462 |
| PH200-T046 | 38100-87J20 | 462 |
| PH200-WH01 | | 461 |
| PRE3300C08 | 99105-11002-008 | 467 |
| PRE3300C09 | 99105-11002-009 | 467 |
| PRE3300C10 | 99105-11002-010 | 467 |
| PRE3300C11 | 99105-11002-011 | 467 |
| PRE3300C12 | 99105-11002-012 | 467 |
| PRE3300C13 | 99105-11002-013 | 467 |
| PRE3300C14 | 99105-11002-014 | 467 |
| PRE3300C15 | 99105-11002-015 | 467 |
| PRE3300C16 | 99105-11002-016 | 467 |
| PRE3300C17 | 99105-11002-017 | 467 |
| PRE3300C18 | 99105-11002-018 | 467 |
| PRE3300C19 | 99105-11002-019 | 467 |
| PRE3300C20 | 99105-11002-020 | 467 |
| PRE3300C21 | 99105-11002-021 | 467 |
| PRE3300C22 | 99105-11002-022 | 467 |
| PRE3300C23 | 99105-11002-023 | 467 |
| PRE3300C24 | 99105-11002-024 | 467 |
| PRE3300C25 | 99105-11002-025 | 467 |
| PRE3300C26 | 99105-11002-026 | 467 |
| PRE3300C27 | 99105-11002-027 | 467 |
| PRE3300C28 | 99105-11002-028 | 467 |
| PRE3300C29 | 99105-11002-029 | 467 |
| PRE3300C30 | 99105-11002-030 | 467 |
| R | | |
| RAC23289-10 | | 446 |
| RAC23299-10 | | 446 |
| RAC320R-RAC-01 | | 445 |
| RAC320R-RAC-03 | | 445 |
| RAC490R-RAC-01 | 99105-20005-ASY | 446 |
| RACPF5510 | | 445 |
| RACRK22628 | 99105-20003 | 447 |
| RACS3213 | | 445 |
| RACS3227 | 99105-20005 | 446 |
| REC08110-60020 | 08110-60020 | 499-501-503-523-524 |
| REC08110-60050 | 08110-60050 | 499-501-503-524 |
| REC08113-60060 | 08113-60060 | 505-507-524 |
| REC09116-06094 | 09116-06094 | 479-501-505-509-517 |
| REC09116-06094 | 55321-93J00 | 479 |
| REC09116-06121 | 09116-06121 | 479-505-507 |
| REC09116-06121 | 09116-06229 | 499 |
| REC09116-06121 | 55321-94900 | 479 |
| REC09141-12005 | 09141-12005 | 503-532 |
| REC09160-12066 | 09160-12066 | 503 |
| REC09160-20027 | 09160-20027 | 499-503-526 |
| REC09160-20041 | 09160-20041 | 501-503-526 |
| REC09160-20042 | 09160-20042 | 49 |

| REF | R.O. / OEM | |
|--------------------|-------------|---|
| REC09160-20043 | 09160-20043 | 499-501-503-526 |
| REC09160-20044 | 09160-20044 | 499-501-503-526 |
| REC09160-20052 | 09160-20052 | 491 |
| REC09160-21009 | 09160-21009 | 499-501-503-526 |
| REC09160-26015 | 09160-26015 | 509-526 |
| REC09160-27008 | 09160-27008 | 480-491 |
| REC09168-10022 | 09168-10022 | 490-497-501-505-507-509-511-512-515-516-439-440-441 |
| REC09168-10034 | 09168-10034 | 513-517-518-521-440-441 |
| REC09168-12012 | 09168-12012 | 439-440-441-449 |
| REC09168-12017 | 09168-12017 | 439-440-449 |
| REC09181-24001 | 09181-24001 | 491 |
| REC09202-04002 | 09202-04002 | 509-532 |
| REC09202-05022 | 09202-05022 | 511-522 |
| REC09204-02004 | 09204-02004 | 439-499-503-532 |
| REC09209-08016 | 09209-08016 | 505-507-522 |
| REC09248-10008 | 09248-10008 | 497-501-505-507-509-511-512-513-515-516-521 |
| REC09262-25078 | 09262-25003 | 503 |
| REC09262-25078 | 09262-25078 | 490 |
| REC09262-30055 | 09262-30055 | 490 |
| REC09262-35052 | 09262-35052 | 480 |
| REC09263-14022 | 09263-14014 | 492 |
| REC09263-14022 | 09263-14022 | 491 |
| REC09263-15019 | 09263-15019 | 501-524 |
| REC09263-18016 | 09263-14022 | 491 |
| REC09263-20046 | 09263-20046 | 505-507-524 |
| REC09263-20047 | 09263-20047 | 505-507-524 |
| REC09263-20051 | 09263-20051 | 491 |
| REC09263-20072 | 09263-20072 | 480-491-492 |
| REC09263-20L04 | 09263-20024 | 525 |
| REC09263-20L04 | 09263-20L04 | 499-501-503-525 |
| REC09263-22020 | 09263-22020 | 509-511-524 |
| REC09263-22L03 | 09263-22039 | 509-511-524 |
| REC09263-22L03 | 09263-22L03 | 524 |
| REC09263-24018 | 09263-24018 | 491 |
| REC09263-25025 | 09263-25025 | 509-523 |
| REC09263-25025 | 09263-25048 | 523 |
| REC09263-25025 | 09263-25L02 | 523 |
| REC09263-25062 | 09263-25062 | 509-523 |
| REC09263-27005 | 09263-27005 | 480-491 |
| REC09265-17002 | 09265-17002 | 505-507-524 |
| REC09269-30012 | 09269-30012 | 480-490 |
| REC09280-08005 | 09280-08005 | 520 |
| REC09280-11005 | 09280-11001 | 520 |
| REC09280-11005 | 09280-11005 | 520 |
| REC09280-22019 | 09280-22019 | 439-440-441-476-478-479 |
| REC09280-54001 | 09280-54001 | 449 |
| REC09280-54001 | 09280-56001 | 449 |
| REC09280-54001 | 09280-54001 | 439 |
| REC09280-57002 | 09280-57002 | 499-501-503-521 |
| REC09280-75001 | 09280-75001 | 505-509-511-521 |
| REC09282-10008 | 09282-10008 | 488-497 |
| REC09282-12008 | 09282-12008 | 488 |
| REC09282-12010 | 09282-12010 | 489 |
| REC09282-15008 | 09282-15008 | 489 |
| REC09282-17005 | 09282-17005 | 489-509-511 |
| REC09282-17009 | 09282-17009 | 489 |
| REC09283-10003 | 09283-10003 | 489 |
| REC09283-10009 | 09283-10009 | 489 |
| REC09283-17002 | 09283-17002 | 488 |
| REC09283-20018 | 09283-20018 | 488 |
| REC09283-20045 | 09283-20045 | 489 |
| REC09283-25035 | 09283-25035 | 489 |
| REC09283-25075 | 09283-25075 | 489 |
| REC09283-25076 | 09283-25075 | 489 |
| REC09283-30062 | 09283-30062 | 480-489 |
| REC09283-30064 | 09283-30064 | 489 |
| REC09283-35043 | 09283-35043 | 480-489 |
| REC09289-10005 | 09289-10005 | 489 |
| REC09289-12002 | 09289-12002 | 489 |
| REC09289-12003 | 09289-12003 | 490-501 |
| REC09289-17004 | 09289-17004 | 489 |
| REC09289-17006 | 09289-17006 | 489-501 |
| REC09289-17006 | 09289-17L02 | 499-503 |
| REC09289-20009 | 09289-20009 | 489-505-507 |
| REC09289-22007 | 09289-22007 | 490-509-511 |
| REC09289-30008 | 09289-30008 | 490 |
| REC09380-15001 | 09380-15001 | 499-501-503-524 |
| REC09381-20003 | 09381-20003 | 480 |
| REC09401-11425 | 09401-11425 | 443 |
| REC09401-11425 | 17822-90J00 | 443 |
| REC09401-11425BULK | 09401-11425 | 443 |
| REC09401-11425BULK | 17822-90J00 | 443 |
| REC09420-03002 | 09420-03002 | 470-497 |
| REC09420-03005 | 09420-03005 | 470-503 |
| REC09420-03005 | 09420-03009 | 470-499 |

| REF | R.O. / OEM | |
|-----------------|-----------------|-----------------------------|
| REC09420-04006 | 09420-04006 | 470-505-507-509-511 |
| REC09420-05009 | 09420-05006 | 470 |
| REC09420-05009 | 09420-05009 | 470-515-516-517-518-440-441 |
| REC09440-05027 | 09440-05027 | 501-522 |
| REC09440-08043 | 09440-08043 | 511-522 |
| REC09440-32008 | 09440-32008 | 501-522 |
| REC09440-40002 | 09440-40002 | 509-511-522 |
| REC10W30U3 | | 450 |
| REC10W30U6 | | 450 |
| REC10W40U3 | 990C0-01E30-GLN | 450 |
| REC10W40U3 | 990C0-10W40-1GL | 450 |
| REC10W40U3 | 990C0-10W40-GAL | 450 |
| REC10W40U3 | 990C0-10W40-GLN | 450 |
| REC10W40U6 | 990C0-01E30-GLN | 450 |
| REC10W40U6 | 990C0-10W40-1GL | 450 |
| REC10W40U6 | 990C0-10W40-GAL | 450 |
| REC10W40U6 | 990C0-10W40-GLN | 450 |
| REC1141-87D90 | 1141-87D61 | 487 |
| REC1141-87D90 | 1141-87D90 | 487 |
| REC1141-87D92 | 1141-87D32 | 487 |
| REC1141-87E90 | 1141-87D90 | 487 |
| REC1141-87E90 | 1141-87E20 | 487 |
| REC1141-87J02 | 1141-87J00 | 483-484 |
| REC1141-87J02 | 1141-87J01 | 483-484 |
| REC1141-87J02 | 1141-87J02 | 481-483-484 |
| REC1141-87L00 | 1141-87L00 | 482-483-484 |
| REC1141-90J01 | 1141-90J00 | 483 |
| REC1141-90J01 | 1141-90J01 | 484 |
| REC1141-91J10 | 1141-91J01 | 483-484 |
| REC1141-91J10 | 1141-91J02 | 483-484 |
| REC1141-91J10 | 1141-91J10 | 483-484 |
| REC1141-92J01 | 1141-92J00 | 483-484 |
| REC1141-93960 | 1141-93950 | 487 |
| REC1141-93E20 | 1141-93E20 | 483-484 |
| REC1141-93J10 | 1141-93J03 | 483-484 |
| REC1141-94450 | 1141-94440 | 487 |
| REC1141-94450 | 1141-94450 | 487 |
| REC1141-94506 | 1141-94506 | 487 |
| REC1141-94506 | 1141-94620 | 487 |
| REC1141-94720 | 1141-94701 | 487 |
| REC1141-94720 | 1141-94720 | 487 |
| REC1141-95505 | 1141-95505 | 487 |
| REC1141-95505 | 1141-95621 | 487 |
| REC1141-95D40 | 1141-95D40 | 487 |
| REC1141-95J00 | 1141-95J00 | 483-484 |
| REC1141-96303 | 1141-96344 | 487 |
| REC1141-96344 | 1141-96344 | 487 |
| REC1141-96344 | 1141-96344 | 487 |
| REC1141-97J02 | 1141-97J01 | 483 |
| REC1141-97J02 | 1141-97J10 | 483-484 |
| REC1141-98J10 | 1141-98J10 | 487 |
| REC1141-98401 | 1141-98401 | 487 |
| REC1141-98401 | 1141-98411 | 487 |
| REC1141-98J10 | 1141-98J01 | 483-484 |
| REC1141-98J10 | 1142-98J00 | 484 |
| REC1142-93J10 | 1142-93J03 | 483-484 |
| REC1142-98J10 | 1142-98J00 | 483 |
| REC1162-94410 | 1162-94410 | 488 |
| REC1189-87J00 | 1189-87J00 | 481-486 |
| REC1189-87L00 | 1189-87L00 | 482-486 |
| REC11265-87E10 | 11265-87E00 | 479 |
| REC11265-87E10 | 11265-87E10 | 479 |
| REC11400-87804 | 11400-87800 | 484 |
| REC11400-87804 | 11400-87801 | 484 |
| REC11400-87804 | 11400-87802 | 484 |
| REC11400-87804 | 11400-87803 | 484 |
| REC11410-87851 | 11410-87850 | 481-484 |
| REC11410-87851 | 11410-87851 | 484 |
| REC11413-87J00 | 11413-87J00 | 482-484 |
| REC11413-87J00 | 11413-87J00 | 481-486 |
| REC11433-87J00 | 11433-87J00 | 481-486 |
| REC11433-93912 | 11433-93901 | 488 |
| REC11433-94412 | 11433-94401 | 488 |
| REC11433-96330 | 11433-96302 | 488 |
| REC11434-94411 | 11434-94411 | 495 |
| REC11489-87J00 | 11489-87J00 | 481-493 |
| REC11489-87L00 | 11489-87L00 | 482-493 |
| REC11489-90J00 | 11489-90J00 | 493 |
| REC11489-93E11 | 11489-93E10 | 493 |
| REC11489-93J00 | 11489-93J00 | 493 |
| REC11542-87L00 | 11542-87L00 | 482-493 |
| REC11552-87L00 | 11552-87L00 | 485 |
| REC12110-93130K | 12110-93130 | 492 |
| REC12110-94350K | 12110-94350 | 492 |
| REC12110-94400K | 12110-94400K | 480-492 |
| REC12140-93121 | 12140-93121 | 492 |
| REC12140-94400 | 12140-94400 | 480-492 |
| REC12151-94400 | 12151-94400 | 480 |
| REC12161-93902 | 12161-93902 | 491 |
| REC12161-94400 | 12161-94400 | 480-491 |
| REC12161-96300 | 12161-96300 | 491 |
| REC12211-94410 | 12211-94410 | 480 |
| REC12221-94412 | 12221-94412 | 480-490 |
| REC12231-94413 | 12231-94413 | 480-490 |
| REC12232-94412 | 12232-94412 | 480-490 |
| REC12240-94432 | 12240-94432 | 480-490 |
| REC12710-97J00 | 12710-97J00 | 483 |
| REC12761-72F00 | 12761-72F00 | 492 |
| REC12761-93E10 | 12761-93E10 | 492 |
| REC12761-99J00 | 12761-99J00 | 492 |

| REF | R.O. / OEM | |
|--------------------|-----------------|-----------------|
| REC12778-93J00 | 12778-93J00 | 485 |
| REC13119-93J00 | 13119-93J00 | 494 |
| REC13122-95J00 | 13122-95J00 | 494 |
| REC13147-98J00 | 13147-98J00 | 493 |
| REC13200-91D21 | 13200-91D20 | 453 |
| REC13200-91D21 | 13200-91D21 | 453 |
| REC13200-91J70 | 13200-91J70 | 453 |
| REC13250-95D01 | 13250-95D01 | 453 |
| REC13421-87J00 | 13421-87J00 | 481-485 |
| REC13421-98J00 | 13421-98J00 | 485 |
| REC13650-52G00 | 13650-52G00 | 454 |
| REC13650-56B00 | 13650-56B00 | 454 |
| REC13910-87D00 | 13910-87D00 | 453 |
| REC13910-89J01 | 13910-89J01 | 453 |
| REC13910-94400 | 13910-94400 | 453 |
| REC13910-94701 | 13910-94701 | 453 |
| REC14141-93952-OEP | 14141-93952-OEP | 495 |
| REC14151-87L00 | 11151-87L00 | 482 |
| REC14151-87L00 | 14151-87L00 | 494 |
| REC14151-93912 | 14151-93901 | 495 |
| REC14151-93J00 | 14151-93J00 | 494 |
| REC14151-94411 | 14151-94412 | 495 |
| REC14151-96311 | 14151-96310 | 495 |
| REC14152-93J00 | 14152-93J00 | 494 |
| REC14212-91L00 | 14212-91L00 | 495 |
| REC14212-91L00 | 14212-96310 | 495 |
| REC14212-93J00 | 14212-93J00 | 494 |
| REC14212-94413 | 14212-94412 | 495 |
| REC15170-91J00 | 15170-91J00 | 451 |
| REC15170-93911 | 15170-93920 | 451 |
| REC15170-94320 | 15170-94320 | 451 |
| REC15170-94J00 | 15170-94J01 | 451 |
| REC15170-98110 | 15170-98110 | 451 |
| REC15170-99E00 | 15170-99E00 | 451 |
| REC15200-82J20 | 15200-82J00/02 | 451 |
| REC15200-96J00 | 15200-96J00 | 450 |
| REC15410-87J00 | 15410-87J10 | 448 |
| REC15410-87J30 | 15410-87J30 | 440-447 |
| REC15410-87L00 | 15410-87L00 | 439-440-441-447 |
| REC15410-88L00 | 15410-88L00 | 440-448 |
| REC15410-93J00 | 15410-93J00 | 448 |
| REC15410-96J00 | 15410-96J00 | 441-447 |
| REC15410-98500 | 15410-98500 | 439-448 |
| REC15412-92J00 | 15412-92J00 | 441-448 |
| REC15412-93J10 | 15412-93J10 | 441-448 |
| REC15440-87L10 | 15440-87L10 | 448 |
| REC15440-90J00 | 15440-90J00 | 448 |
| REC15440-93J00 | 15440-93J00 | 448 |
| REC15440-96J00 | 15440-96J00 | 448 |
| REC15440-96J01 | 15440-96J01 | 448 |
| REC15440-99E01 | 15440-99E01 | 449 |
| REC15440-99E01 | 15440-99E01 | 449 |
| REC15626-90J00 | 15626-90J00 | 451 |
| REC15626-99E00 | 15626-99E00 | 451 |
| REC15626-99E00 | 15643-99E00 | 451 |
| REC15710-65D00 | 15710-65D00 | 451 |
| REC15710-66D00 | 15710-66D00 | 452 |
| REC15710-82K50 | 15710-82K50 | 453 |
| REC15710-82M00 | 15710-82M00 | 452 |
| REC15710-85K00 | 15710-85K00 | 452 |
| REC15710-87J00 | 15710-87J00 | 452 |
| REC15710-87L00 | 15710-87L00 | 452 |
| REC15710-89L00 | 15710-89L00 | 451 |
| REC15710-89L00 | 15710-89L00 | 452 |
| REC15710-93J00 | 15710-93J00 | 453 |
| REC15710-96J00 | 15710-96J00 | 453 |
| REC15710-99E00 | 15710-99E00 | 452 |
| REC16433-93J00 | 16433-93J00 | 485 |

| REF | R.O. / OEM | |
|----------------|--------------|---------------------------------|
| REC17400-87E04 | 17400-87E03 | 440-474-476-512 |
| REC17400-87L01 | 17400-87L00 | 475 |
| REC17400-87L01 | 17400-87L01 | 475-513 |
| REC17400-87L01 | 17400-87L01 | 440-476 |
| REC17400-88810 | 17400-88810 | 440 |
| REC17400-88L00 | 17400-88L00 | 440-475-476-511 |
| REC17400-89810 | 17400-89810 | 439 |
| REC17400-89820 | 17400-89820 | 440 |
| REC17400-90J20 | 17400-90J11 | 475 |
| REC17400-90J20 | 17400-90J20 | 476-515 |
| REC17400-91830 | 17400-91830 | 439 |
| REC17400-91860 | 17400-91860 | 439 |
| REC17400-92821 | 17400-92821 | 441 |
| REC17400-92840 | 17400-92840 | 440 |
| REC17400-92850 | 17400-92850 | 441 |
| REC17400-92D01 | 17400-92D01 | 474 |
| REC17400-92D01 | 17400-92D11 | 474 |
| REC17400-92D01 | 17400-92D01 | 476 |
| REC17400-92J00 | 17400-92J200 | 475-476-440-441-475-476-515-516 |
| REC17400-92J21 | 17400-92J21 | 441 |
| REC17400-93851 | 17400-93851 | 475 |
| REC17400-93912 | 17400-93912 | 475 |
| REC17400-93912 | 17400-93912 | 475 |
| REC17400-93951 | 17400-93950 | 474-501 |
| REC17400-93951 | 17400-93951 | 476-501 |
| REC17400-93J01 | 17400-93J00 | 474 |
| REC17400-93J01 | 17400-93J01 | 474 |
| REC17400-93J01 | 17400-93J02 | 474 |
| REC17400-93J01 | 17400-93J03 | 474 |
| REC17400-93J01 | 17400-93J01 | 441-476 |
| REC17400-94611 | 17400-94611 | 475-476 |
| REC17400-94701 | 17400-94700 | 474 |
| REC17400-94701 | 17400-94701 | 474 |
| REC17400-94701 | 17400-94701 | 476 |
| REC17400-94810 | 17400-94810 | 439 |
| REC17400-94821 | 17400-94821 | 440 |
| REC17400-94J00 | 17400-94J200 | 439-476 |
| REC17400-94L00 | 17400-94L00 | 440-475-476 |
| REC17400-95351 | 17400-95350 | 474 |
| REC17400-95351 | 17400-95351 | 474 |
| REC17400-95351 | 17400-95550 | 474 |
| REC17400-95351 | 17400-95351 | 476 |
| REC17400-95870 | 17400-95870 | 439 |
| REC17400-95J02 | 17400-95J01 | 476 |
| REC17400-95J02 | 17400-95J02 | 439-476-505 |
| REC17400-96403 | 17400-96350 | 474 |
| REC17400-96403 | 17400-96351 | 474 |
| REC17400-96403 | 17400-96352 | 474-507 |
| REC17400-96403 | 17400-96353 | 509 |
| REC17400-96403 | 17400-96403 | 440-474-476-509 |
| REC17400-96821 | 17400-96821 | 441 |
| REC17400-96J02 | 17400-96J00 | 441 |
| REC17400-96J03 | 17400-96J00 | 475 |
| REC17400-96J03 | 17400-96J01 | 475 |
| REC17400-96J03 | 17400-96J02 | 475 |
| REC17400-96J03 | 17400-96J03 | 441-475-476-517 |
| REC17400-97810 | 17400-97810 | 439 |
| REC17400-97820 | 17400-97821 | 439 |
| REC17400-98551 | 17400-98551 | 474-476 |
| REC17400-98652 | 17400-98652 | 474 |
| REC17400-98652 | 17400-98661 | 474 |
| REC17400-98652 | 17400-98652 | 476 |
| REC17400-98661 | 17400-98661 | 474-497 |
| REC17400-98661 | 17400-986L0 | 474 |
| REC17400-98661 | 17400-986L1 | 474 |
| REC17400-98661 | 17400-98661 | 439-476 |
| REC17400-98861 | 17400-98861 | 441 |
| REC17400-98J01 | 17400-98J00 | 474 |
| REC17400-98J01 | 17400-98J01 | 474-518 |
| REC17400-98J01 | 17400-98J02 | 441-474-476 |
| REC17400-99840 | 17400-99840 | 439 |
| REC17400-99870 | 17400-99870 | 440 |
| REC17400-99J01 | 17400-99J00 | 475 |
| REC17400-99J01 | 17400-99J01 | 439-475-476-499-503 |
| REC17411-93901 | 17410-93910 | 471 |
| REC17411-93901 | 17411-93901 | 471-501 |
| REC17411-94421 | 17410-94431 | 471 |
| REC17411-94421 | 17411-94421 | 471-507-509 |
| REC17413-92J01 | 17413-92J00 | 473 |
| REC17413-92J01 | 17413-92J01 | 473-515-516 |
| REC17413-95J00 | 17413-95J00 | 439-473-505-511 |
| REC17413-96J01 | 17413-96J00 | 473 |
| REC17413-96J01 | 17413-96J01 | 441-473-517 |
| REC17413-99E11 | 17413-99E10 | 512-513 |
| REC17413-99E11 | 17413-99E11 | 473 |
| REC17416-92J00 | 17416-92J00 | 515 |
| REC17416-92J10 | 17416-92J10 | 472-515-516 |
| REC17416-93J00 | 17416-93J00 | 472-518 |
| REC17416-95J00 | 17416-95J00 | 472-505-511 |
| REC17416-96J00 | 17416-96J00 | 472-517 |
| REC17416-99E10 | 17416-99E10 | 472-513 |
| REC17417-92J00 | 17417-92J00 | 472-515 |
| REC17431-92L20 | 17431-92L20 | 521 |
| REC17431-92L20 | 17431-94440 | 521 |
| REC17431-92L20 | 17431-94441 | 521 |
| REC17450-93921 | 17450-93440 | 471 |
| REC17450-93921 | 17450-93920 | 471 |

| REF | R.O. / OEM | |
|----------------|-----------------|-------------------------|
| REC17450-93921 | 17450-93921 | 471-501 |
| REC17450-93921 | 17450-93930 | 471 |
| REC17452-93910 | 17452-93910 | 473-501 |
| REC17453-93901 | 17453-93900 | 501-521 |
| REC17453-93901 | 17453-93901 | 521 |
| REC17461-87E12 | 17461-87E10 | 470 |
| REC17461-87E12 | 17461-87E11 | 470 |
| REC17461-87E12 | 17461-87E12 | 469-470-512-513 |
| REC17461-90J01 | 17461-90J00 | 469 |
| REC17461-90J01 | 17461-90J01 | 469-470-515-516-517 |
| REC17461-90J01 | 17461-94510 | 469 |
| REC17461-92D02 | 17461-92D02 | 469 |
| REC17461-93004 | 17461-93001 | 469 |
| REC17461-93004 | 17461-93002 | 469 |
| REC17461-93004 | 17461-93003 | 469 |
| REC17461-93004 | 17461-93004 | 469 |
| REC17461-93903 | 17461-93901 | 469 |
| REC17461-93903 | 17461-93902 | 469 |
| REC17461-93903 | 17461-93903 | 469-470-501-503 |
| REC17461-93903 | 17461-939M0 | 499 |
| REC17461-93903 | 17461-93903 | 470 |
| REC17461-93J00 | 17461-93J00 | 470-518 |
| REC17461-94700 | 17461-94700 | 469 |
| REC17461-94700 | 17461-94701 | 469 |
| REC17461-94700 | 17461-95200 | 469 |
| REC17461-94700 | 17461-95201 | 469 |
| REC17461-95300 | 17461-95300 | 469 |
| REC17461-95300 | 17461-95301 | 469 |
| REC17461-95300 | 17461-95303 | 469 |
| REC17461-95300 | 17461-95501 | 469 |
| REC17461-96312 | 17451-96301 | 469 |
| REC17461-96312 | 17461-94L00 | 470 |
| REC17461-96312 | 17461-96301 | 469 |
| REC17461-96312 | 17461-96310 | 469 |
| REC17461-96312 | 17461-96312 | 470-505-507-509-511 |
| REC17461-97J00 | 17461-97J10 | 439-470 |
| REC17461-98503 | 17461-98501 | 469 |
| REC17461-98503 | 17461-98502 | 469 |
| REC17461-98503 | 17461-98503 | 469-470 |
| REC17461-98503 | 17461-985M0 | 470-497 |
| REC17462-93990 | 17462-93990 | 470-501 |
| REC17471-92J00 | 17471-87E00 | 471 |
| REC17471-92J00 | 17471-87E01 | 471-512 |
| REC17471-92J00 | 17471-92J00 | 471-515-516 |
| REC17471-92J02 | 17471-93J00 | 471 |
| REC17471-92J02 | 17471-93J01 | 471 |
| REC17471-92J02 | 17471-93J02 | 471-517 |
| REC17471-93902 | 17471-93902 | 471-501 |
| REC17471-94401 | 17471-94401 | 471-507-509 |
| REC17471-95J01 | 17471-95J00 | 471 |
| REC17471-95J01 | 17471-95J01 | 471-505-511 |
| REC17471-97J00 | 17471-97J00-00 | 439-471 |
| REC17471-97JL0 | 17471-97JL0 | 439-471 |
| REC17471-98601 | 17471-98600 | 471 |
| REC17471-98601 | 17471-98601 | 471 |
| REC17472-87E10 | 17472-87E00 | 472 |
| REC17472-87E10 | 17472-87E10 | 472-512-515-516 |
| REC17472-87L00 | 17472-87L00 | 472-482-513 |
| REC17472-91J00 | 17472-91J00 | 473-497 |
| REC17472-92D10 | 17472-92D10 | 473 |
| REC17472-93911 | 17472-93911 | 473-501 |
| REC17472-93J00 | 17472-93J00 | 473-517 |
| REC17472-95310 | 17472-95310 | 473 |
| REC17472-96303 | 17472-96301 | 472 |
| REC17472-96303 | 17472-96302 | 472 |
| REC17472-96303 | 17472-96303 | 472-481-505-507-509-511 |
| REC17472-97J00 | 17472-97J00 | 439-472 |
| REC17472-97JL0 | 17472-97JL0 | 439-472 |
| REC17472-98503 | 17472-98503 | 473 |
| REC17472-98611 | 17472-98611 | 473 |
| REC17472-98J00 | 17472-98J00 | 472-518 |
| REC17560-91L00 | 17560-91L00 | 521 |
| REC17560-91L00 | 17560-96300 | 521 |
| REC17560-91L00 | 17560-96301 | 521 |
| REC17560-91L00 | 17560-96304 | 521 |
| REC17616-87J00 | 17616-87J00 | 468-481-486 |
| REC17670-90J10 | 17670-90J10 | 468 |
| REC17670-90J20 | 17670-90J20 | 468 |
| REC17670-91J01 | 17670-91J00 | 468 |
| REC17670-91J01 | 17670-91J01 | 468 |
| REC17670-93962 | 17670-93962 | 468 |
| REC17670-94402 | 17670-94402 | 468 |
| REC17670-94J01 | 17670-94J00 | 468 |
| REC17670-94J01 | 17670-94J01 | 468 |
| REC17685-87D10 | 17685-87D00 | 486-488 |
| REC17685-87D10 | 17685-87D10 | 481-486-488 |
| REC17693-95J00 | 17693-95J00 | 485 |
| REC17913-93J00 | 17913-93J00 | 469 |
| REC17914-93J00 | 17914-93J00 | 469 |
| REC17914-93J00 | 17914-93JL0 | 469 |
| REC18-6865 | 48600-94511-OED | 462 |
| REC18137-52D00 | 18137-52D00 | 452-454 |
| REC18137-88L01 | 18137-88L01 | 452-454 |
| REC18137-88L01 | 18137-88L01 | 452-454 |
| REC18137-93J00 | 18137-93J00 | 452-454 |
| REC18590-58M00 | 18590-58M00 | 452-454 |
| REC18590-68H00 | 18590-68H00 | 452-454 |
| REC18590-72F21 | 18590-72F21 | 452-454 |

| REF | R.O. / OEM | |
|-----------------|-------------|-----------------|
| REC22-8M0001721 | | 443 |
| REC23211-94401 | 23211-94401 | 523 |
| REC23311-95DL0 | 23311-95DL0 | 520 |
| REC24942 | | 445 |
| REC24950 | | 445 |
| REC24952 | | 445 |
| REC25000 | | 445 |
| REC25010 | | 445 |
| REC25020 | | 445 |
| REC25030 | | 445 |
| REC25222-93901 | 25222-93901 | 520 |
| REC25222-96300 | 25222-96300 | 520 |
| REC25700-87D00 | 25700-87D00 | 519 |
| REC25700-87D00 | 25700-87D00 | 520 |
| REC25700-87E00 | 25700-87E00 | 519 |
| REC25700-87E00 | 25700-87E00 | 520 |
| REC25700-87L00 | 25700-87L00 | 513-519-520 |
| REC25700-88L00 | 25700-88400 | 519 |
| REC25700-88L00 | 25700-88L00 | 511 |
| REC25700-88L00 | 25700-94400 | 519 |
| REC25700-88L00 | 25700-88L00 | 509-520 |
| REC25700-90J01 | 25700-90J01 | 515-520 |
| REC25700-92J00 | 25700-92J00 | 515-516-519-520 |
| REC25700-93J00 | 25700-93J00 | 517-519-520 |
| REC25700-93L00 | 25700-93L00 | 518-519-520 |
| REC25700-94500 | 25700-94500 | 520 |
| REC25700-94700 | 25700-94700 | 519-520 |
| REC25700-95501 | 25700-95500 | 519-520 |
| REC25700-95D01 | 25700-95D00 | 519 |
| REC25700-95D01 | 25700-95D01 | 507-519-520 |
| REC25700-95J00 | 25700-95J00 | 505-519-520 |
| REC25700-98J00 | 25700-98J00 | 519-520 |
| REC25700-99E00 | 25700-99E00 | 512-519-520 |
| REC25W40U3 | | 450 |
| REC2TU3 | | 450 |
| REC2TU6 | | 450 |
| REC31100-98L10 | 31100-98L10 | 458 |
| REC32140-93900 | 32140-93900 | 455 |
| REC32140-94400 | 32140-94400 | 455 |
| REC32140-96310 | 32140-96310 | 455 |
| REC32800-38F10 | 32800-38F10 | 459 |
| REC32800-87J10 | 32800-87J10 | 459 |
| REC32800-87L00 | 32800-87L00 | 459 |
| REC32800-88L00 | 32800-88L00 | 459 |
| REC32800-89J00 | 32800-89J00 | 459 |
| REC32800-89J11 | 32800-89J10 | 459 |
| REC32800-89J11 | 32800-89J11 | 459 |
| REC32800-89J11 | 32800-89J11 | 459 |
| REC32800-89L01 | 32800-89L00 | 459 |
| REC32800-89L01 | 32800-89L01 | 459 |
| REC32800-89L01 | 32800-89L01 | 459 |
| REC32800-92E20 | 32800-92E20 | 459 |
| REC32800-93J03 | 32800-93J03 | 459 |
| REC32800-93J03 | 32800-93J03 | 459 |
| REC32800-93J03 | 32800-93J03 | 459 |
| REC32800-94620 | 32800-94620 | 458 |
| REC32800-94620 | 32800-94620 | 458 |
| REC32800-94J11 | 32800-94J10 | 459 |
| REC32800-94J11 | 32800-94J11 | 459 |
| REC32800-95D01 | 32800-95720 | 458 |
| REC32800-95D01 | 32800-95D00 | 4 |

| REF | R.O. / OEM | |
|--------------------|-----------------|---------|
| REC36120-ZY6-013 | 38100-90J40 | 462 |
| REC36120-ZY6-013 | 38100-93J11 | 462 |
| REC36120-ZY6-013 | 38100-93J13 | 462 |
| REC36120-ZY9-003 | 38100-87L00 | 462 |
| REC36120-ZY9-003 | 38100-87L01 | 462 |
| REC36120-ZY9-003 | 38100-87L02 | 462 |
| REC36120-ZY9-003 | 38100-87L03 | 462 |
| REC36620-93J02 | 36620-93J02 | 466 |
| REC36620-94J01 | 36620-94J01 | 466 |
| REC37100-96J15 | 37100-96J14 | 465 |
| REC37100-96J15 | 37100-96J15 | 465 |
| REC37100-96J25 | 37100-96J20 | 465 |
| REC37100-96J25 | 37100-96J21 | 465 |
| REC37100-96J25 | 37100-96J22 | 465 |
| REC37100-96J25 | 37100-96J23 | 465 |
| REC37100-96J25 | 37100-96J24 | 465 |
| REC37100-96J25 | 37100-96J25 | 465 |
| REC37110-93J11 | 37110-93J10 | 458 |
| REC37110-93J11 | 37110-93J11 | 458 |
| REC37110-99E00 | 37110-99E00 | 458 |
| REC37220-92E00 | 37220-92E00 | 465 |
| REC37800-93954 | 37800-93953 | 460 |
| REC37800-93954 | 37800-93954 | 460 |
| REC37820-92E03 | 37820-92E00 | 460 |
| REC37830-89E03 | 37830-89E02 | 460 |
| REC37830-89E03 | 37830-95000 | 460 |
| REC37830-95D04 | 37830-95D00 | 460 |
| REC37830-95D04 | 37830-95D01 | 460 |
| REC37830-95D04 | 37830-95D02 | 460 |
| REC37830-95D04 | 37830-95D03 | 460 |
| REC37830-95D04 | 37830-95D04 | 460 |
| REC37850-90J06 | 37850-90J00 | 464 |
| REC37850-90J06 | 37850-90J01 | 464 |
| REC37850-90J06 | 37850-90J02 | 464 |
| REC37850-90J06 | 37850-90J03 | 464 |
| REC37850-90J06 | 37850-90J04 | 464 |
| REC37850-90J06 | 37850-90J05 | 464 |
| REC37850-90J06 | 37850-90J06 | 464 |
| REC37850-93J10 | 37850-93J10 | 465 |
| REC38100-87E10-OED | 38100-87D00 | 461 |
| REC38100-87E10-OED | 38100-87D01-02M | 461 |
| REC38100-87E10-OED | 38100-87D01-OED | 461 |
| REC38100-87E10-OED | 38100-87D02H | 461 |
| REC38100-87E10-OED | 38100-87D0IT | 461 |
| REC38100-87E10-OED | 38100-87E10-OED | 461 |
| REC38100-87J00 | 37100-87J00-OEP | 462 |
| REC38100-87J00 | 38100-87J0EP | 462 |
| REC38100-87J00 | 38100-92J01 | 461 |
| REC38100-87J00 | 38100-92J02 | 461 |
| REC38100-87J00 | 38100-92J10 | 461 |
| REC38100-87J00 | 38100-92J12 | 461 |
| REC38100-87J00 | 38100-93J02 | 461 |
| REC38100-87J00 | 38100-96J00 | 461 |
| REC38100-87J00 | 38100-96J01 | 461 |
| REC38100-97E00-OED | 38100-97E00-OED | 462 |
| REC38100-99E01-OEP | 38100-99E01-00 | 462 |
| REC38100-99E01-OEP | 38100-99E01-OED | 462 |
| REC38100-99E01-OEP | 38100-99E01-OEP | 462 |
| REC38410-93J12 | 38410-93J12 | 463 |
| REC38410-93J12 | 38410-93J11 | 463 |
| REC38410-93J12 | 38410-93J10 | 463 |
| REC38410-93J12 | 38410-93J00 | 463 |
| REC38860-76F01 | 38860-76F01 | 460 |
| REC40135 | | 447 |
| REC40145 | | 447 |
| REC40155 | | 447 |
| REC40165 | | 447 |
| REC40970 | | 461 |
| REC40990 | | 461 |
| REC43211-87JL0 | 43211-87JL0 | 466 |
| REC43211-87JL0 | 43211-94401 | 466 |
| REC43211-94401 | 43211-94401 | 466 |
| REC43711-97E11 | 43711-97E00 | 466 |
| REC43711-97E11 | 43711-97E11 | 466 |
| REC48503-93J12 | 48503-93J10 | 462 |
| REC48503-93J12 | 48503-93J12 | 462 |
| REC48503-93J12 | 48503-94900-OED | 462 |
| REC48630-92J00 | 48630-92J00 | 463 |
| REC48630-93J00 | 48630-93J00 | 463 |
| REC48630-94900 | 48630-94900 | 463 |
| REC48630-96J00 | 48630-96J00 | 463 |
| REC48630-96J03 | 48630-96J01 | 463 |
| REC48630-96J03 | 48630-96J02 | 463 |
| REC48630-96J03 | 48630-96J03 | 463 |
| REC48630-98L01 | 48630-98L00 | 463 |
| REC48630-98L01 | 48630-98L01 | 463 |
| REC51123-87L00 | 51123-87L00 | 482-486 |
| REC51123-93J00 | 51123-93J00 | 485 |
| REC51142-93J00 | 51142-93J00 | 485 |
| REC51211-87J00 | 51211-87J00 | 481-484 |
| REC51211-87L10 | 51211-87L00 | 482-484 |
| REC51211-87L10 | 51211-87L10 | 482-484 |
| REC51211-90J10 | 51211-90J00 | 484 |
| REC51211-90J10 | 51211-90J01 | 484 |
| REC51211-90J10 | 51211-90J02 | 484 |
| REC51211-90J10 | 51211-90J10 | 484 |
| REC51211-90J2 | 51211-90J21 | 484 |
| REC51211-90J2 | 51211-90J22 | 484 |
| REC51211-93J00 | 51211-93J00 | 484 |
| REC52113-93910 | 52113-93910 | 495 |
| REC52113-96330 | 52113-96304 | 495 |
| REC52331-87L00 | 52331-87L00 | 482-494 |
| REC55122-94400 | 55122-88L00 | 473-511 |

| REF | R.O. / OEM | |
|--------------------|------------------|-----------------|
| REC55128-93J10 | 55128-93J00 | 521 |
| REC55128-93J10 | 55128-93J10 | 517-521 |
| REC55321-87J01AL | | 441 |
| REC56120-93900 | 56120-90L00-OEP | 521 |
| REC56120-93900 | 56120-90L01-OEP | 521 |
| REC56120-93900 | 56120-90L02-OEP | 521 |
| REC56120-93900 | 56120-93900-002M | 521 |
| REC56120-93900 | 56120-93900-OEP | 521 |
| REC56120-93900 | 56120-93901-OED | 521 |
| REC56120-93900 | 56120-93901-OEP | 501 |
| REC56120-93900 | 56120-93901-OEP | 531 |
| REC56120-94321-OEP | 56120-94321-OEP | 509-511-521 |
| REC56120-96332-OEP | 56120-96332-OEP | 505-507-521 |
| REC56130-94413-OEP | 56130-94411-OEP | 472 |
| REC56130-94413-OEP | 56130-94413-OEP | 472 |
| REC56130-96331-OEP | 56130-96320-OEP | 472 |
| REC56130-96331-OEP | 56130-96331-OEP | 472 |
| REC57100-93902 | 57100-93902 | 501 |
| REC57100-93902 | 57100-93902 | 531 |
| REC57110-93912 | 57110-93912 | 531 |
| REC57110-94411 | 57110-92L10 | 531 |
| REC57110-94411 | 57110-94441 | 531 |
| REC57311-93901 | 57311-93901 | 525 |
| REC57311-93901 | 57311-93901 | 531 |
| REC57311-93910 | 57311-90L00 | 525 |
| REC57311-93910 | 57311-93910 | 501-525 |
| REC57311-93910 | 57311-93910 | 531 |
| REC57311-94402 | 57311-94401 | 525 |
| REC57311-94402 | 57311-94402 | 525 |
| REC57311-94402 | 57311-94402 | 531 |
| REC57311-96311 | 57311-91L00 | 525 |
| REC57311-96311 | 57311-96310 | 525 |
| REC57311-96311 | 57311-96320 | 525 |
| REC57311-96311 | 57311-91L00 | 531 |
| REC57311-96320 | 57311-96320 | 505-507-531 |
| REC57311-98400 | 57311-98400 | 531 |
| REC57311-98600 | 57311-91J00 | 497 |
| REC57311-98600 | 57311-98600 | 525 |
| REC57311-98600 | 57311-98601 | 525 |
| REC57311-99J10 | 57311-97J10 | 503 |
| REC57311-99J10 | 57311-99J10 | 499-525 |
| REC57510-89J00 | 57510-89J00 | 505-507-525 |
| REC57510-89J00 | 57510-91L00 | 525-531 |
| REC57510-91J00 | 57510-91J00 | 497-525 |
| REC57510-91J00 | 57510-98600 | 525 |
| REC57510-91J00 | 57510-98610 | 525 |
| REC57510-91J00 | 57510-93902 | 525 |
| REC57510-93902 | 57510-93902 | 531 |
| REC57510-93910 | 57510-90L00 | 525 |
| REC57510-93910 | 57510-93910 | 501-525 |
| REC57510-93910 | 57510-93910 | 531-532 |
| REC57510-94402 | 57510-94400 | 525 |
| REC57510-94402 | 57510-94401 | 525 |
| REC57510-94402 | 57510-94402 | 531 |
| REC57510-99J10 | 57510-99J10 | 503 |
| REC57521-89J00 | 57521-89J00 | 505-507-526-531 |
| REC57521-91J00 | 57521-91J00 | 497-526 |
| REC57521-93902 | 57310-93850 | 526 |
| REC57521-93902 | 57521-93902 | 526 |
| REC57521-93902 | 57521-93902 | 531 |
| REC57521-93910 | 57521-90L00 | 526 |
| REC57521-93910 | 57521-93910 | 501-526-531 |
| REC57521-94400 | 57310-94401 | 526 |
| REC57521-94400 | 57521-94400 | 526 |
| REC57521-94400 | 57521-94400 | 531 |
| REC57521-96312 | 57521-96311 | 526 |
| REC57521-96312 | 57521-96312 | 526 |
| REC57521-96312 | 57521-96312 | 531 |
| REC57521-99J10 | 57521-99J10 | 503 |
| REC57610-93901 | 57610-93901 | 501-531 |
| REC57610-94402 | 57610-94402 | 509-511 |
| REC57610-96311 | 57610-96311 | 505-507 |
| REC57621-91L10 | 57621-91L10 | 522 |
| REC57621-91L10 | 57621-96300 | 522 |
| REC57621-91L10 | 57621-96310 | 522 |
| REC57621-94403 | 57621-87J01 | 522 |
| REC57621-94403 | 57621-87J02 | 522 |
| REC57621-94403 | 57621-87J03 | 509-511-522 |
| REC57621-94403 | 57621-94400 | 522 |
| REC57621-94403 | 57621-94403 | 522 |
| REC57621-94403 | 57621-94403 | 522-531 |
| REC57630-92E00 | 57630-92E00 | 517-518-531 |
| REC57630-94300 | 57630-94300 | 511-531 |
| REC57630-94300 | 57630-94301 | 509-531 |
| REC57630-94500 | 57630-94500 | 512-531 |
| REC57630-96300 | 57630-96300 | 505-507-531 |
| REC57631-93901 | 57631-93901 | 499-501-503-523 |
| REC57631-95303 | 57631-94700 | 523 |
| REC57631-95303 | 57631-95301 | 523 |
| REC57631-95303 | 57631-95302 | 523 |
| REC57631-95303 | 57631-95303 | 509-511-523 |
| REC57631-96301 | 57631-96301 | 507-523 |
| REC57632-94J00 | 57632-93902 | 501 |
| REC57632-94J00 | 57632-94J00 | 499-503-532 |
| REC57632-97L00 | 57632-97L00 | 503-522 |
| REC57632-97L00 | 57632-98500 | 522 |
| REC57632-97L00 | 57632-98501 | 497-522 |
| REC57633-93901 | 57633-93900 | 532 |

| REF | R.O. / OEM | |
|--------------------|-----------------|---------------------|
| REC57633-93901 | 57633-93901 | 499-501-503-532 |
| REC57634-88L00 | 57634-88L00 | 509-511-522 |
| REC59178-97J00 | 59178-97J00 | 439-440-499-503-521 |
| REC5W40U3 | | 450 |
| REC5W40U6 | | 450 |
| REC63610-89E01 | 63610-89E01-000 | 467 |
| REC63610-91J20 | 63610-91J00 | 467 |
| REC63610-91J20 | 63610-91J01 | 467 |
| REC63610-91J20 | 63610-91J03 | 467 |
| REC63610-91J20 | 63610-91J04 | 467 |
| REC63610-91J20 | 63610-91J20 | 467 |
| REC63610-93501 | 63610-93501-000 | 467 |
| REC63610-94402 | 63610-94402-000 | 467 |
| REC63610-96302 | 63610-96302-000 | 467 |
| REC63610-96321-000 | 63610-96321-000 | 467 |
| REC63P-13907-03 | 15200-90J00 | 450 |
| REC63P-13907-03 | 15200-92J00 | 450 |
| REC63P-13907-03 | 15200-93J01 | 450 |
| REC63P-14984-00 | 15200-92J00 | 450 |
| REC650-24351-51 | | 443 |
| REC65720-98520 | 65720-98500 | 443 |
| REC65720-98520 | 65720-98501 | 443 |
| REC65720-98520 | 65720-98502 | 443 |
| REC65720-98520 | 65720-98520 | 443 |
| REC65720-98520 | 65720-98521 | 443 |
| REC65720-986L0 | 65720-986A0 | 443 |
| REC65720-986L0 | 65720-986B0 | 443 |
| REC65720-986L0 | 65720-986L0 | 443 |
| REC65750-94404 | 65750-94401 | 443 |
| REC65750-94404 | 65750-94402 | 443 |
| REC65750-94404 | 65750-94403 | 443 |
| REC65750-94404 | 65750-94404 | 443 |
| REC65L-24563-00 | 15412-93J00 | 447 |
| REC67200-88L00 | 67200-88L00 | 465 |
| REC67200-88L00 | 67200-93J12 | 465 |
| REC67200-88L00 | 67200-93J13 | 465 |
| REC67200-88L10 | 67200-88L10 | 465 |
| REC67200-88L10 | 67200-93J15 | 464 |
| REC67200-93J51 | 67200-93J01 | 464 |
| REC67200-93J51 | 67200-93J02 | 464 |
| REC67200-93J51 | 67200-93J03 | 464 |
| REC67200-93J51 | 67200-93J04 | 464 |
| REC67200-93J51 | 67200-93J06 | 464 |
| REC67200-93J51 | 67200-93J15 | 464 |
| REC67200-94J20 | 67200-91J00 | 464 |
| REC67200-94J20 | 67200-91J01 | 464 |
| REC67200-94J20 | 67200-91J04 | 464 |
| REC67200-94J20 | 67200-94J20 | 464 |
| REC67200-99E56 | 67200-99E10-OEP | 464 |
| REC67200-99E56 | 67200-99E30-OEP | 464 |
| REC67200-99E56 | 67200-99E50 | 464 |
| REC67200-99E56 | 67200-99E51 | 464 |
| REC67200-99E56 | 67200-99E56 | 464 |
| REC67F-12411-01 | 17670-93J00 | 468 |
| REC692-24410-00 | 15100-94301 | 450 |
| REC692-24410-00 | 15100-94303 | 450 |
| REC692-24410-00 | 15100-94310 | 450 |
| REC692-24410-00 | 15100-94311 | |

| REF | R.O./OEM | |
|------------------|----------|-----|
| RECTOOLTRIMKIT | | 463 |
| RECYS-225-15 | | 446 |
| RM35-802893Q | | 445 |
| RM92-858026QB1U6 | | 450 |
| RM92-858027QB1U3 | | 450 |
| RM92-8M0086220U6 | | 450 |
| RM92-8M0086221U3 | | 450 |

S

| | | |
|-----------------|-----------------|---------|
| SIE18-8013 | | 442 |
| SIE18-8015 | | 442 |
| SOL2431-130-19 | 58100-95530-019 | 528 |
| SOL2431-133-17 | 58100-95521-019 | 528 |
| SOL2431-135-15 | 58100-95511-019 | 528 |
| SOL3411-139-17 | 58100-90J00-019 | 528 |
| SOL3411-139-19 | 58100-90J10-019 | 528 |
| SOL3411-139-21 | 58100-90J20-019 | 528 |
| SOL3413-138-15 | 58100-90J40-019 | 528 |
| SOL3413-138-17 | 58100-90J00-019 | 528 |
| SOL3413-138-19 | 58100-90J10-019 | 528 |
| SOL3413-138-21 | 58100-90J20-019 | 528 |
| SOL3451-139-17 | 58100-90J00-019 | 528 |
| SOL3451-139-17 | 99105-00700-18P | 528 |
| SOL3451-139-19 | 58100-90J10-019 | 528 |
| SOL3451-139-19 | 99105-00700-20P | 528 |
| SOL3451-139-21 | 58100-90J20-019 | 528 |
| SOL3451-139-21 | 99105-00700-22P | 528 |
| SOL3451-139-23 | 58100-90J22-019 | 528 |
| SOL3451-139-23 | 99105-00700-24P | 528 |
| SOL3452-139-17 | 99105-0070L-18P | 528 |
| SOL3452-139-19 | 99105-0070L-20P | 528 |
| SOL3452-139-21 | 99105-0070L-22P | 528 |
| SOL4011-079-07S | 58110-91JN0-019 | 497-528 |
| SOL4111-093-07A | 58100-89L00-019 | 528 |
| SOL4111-093-08A | 58100-90L41-019 | 528 |
| SOL4111-093-09A | 58100-89L20-019 | 528 |
| SOL4111-093-10A | 58100-89L60-019 | 528 |
| SOL4111-093-11A | 58100-89L70-019 | 528 |
| SOL4111-093-12A | 58100-89L50-019 | 528 |
| SOL4211-100-14 | 58100-95D00-019 | 528 |
| SOL4211-100-15 | 58100-96460-019 | 528 |
| SOL4211-101-13 | 58100-96440-019 | 528 |
| SOL4211-103-12 | 58100-96430-019 | 528 |
| SOL4211-105-11 | 58100-96420-019 | 528 |
| SOL4211-110-09 | 58100-96410-019 | 528 |
| SOL4311-110-15 | 58100-95363-019 | 528 |
| SOL4311-116-12 | 58100-95393-019 | 528 |
| SOL4311-116-13 | 58100-94313-019 | 528 |
| SOL4311-116-14 | 58100-95353-019 | 528 |
| SOL4311-118-11 | 58100-95222-019 | 528 |
| SOL4311-120-10 | 58100-95212-019 | 528 |
| SOL4311-121-09 | 58100-94302-019 | 528 |
| SOL4411-130-19 | 58100-94522-019 | 528 |
| SOL4411-130-21 | 58100-94532-019 | 528 |
| SOL4411-133-17 | 58100-94512-019 | 528 |
| SOL4411-135-15 | 58100-94500-019 | 528 |
| SOL4411-138-13 | | 528 |
| SOL4411-140-11 | | 528 |
| SOL4413-125-19 | 58100-94522-019 | 528 |
| SOL4413-125-21 | 58100-94532-019 | 528 |
| SOL4413-128-17 | 58100-94512-019 | 528 |
| SOL4413-130-15 | 58100-94500-019 | 528 |
| SOL4413-133-13 | | 528 |
| SOL4431-130-19 | 58100-94522-019 | 528 |
| SOL4431-130-19 | 58100-94561-019 | 528 |
| SOL4431-130-19 | 99105-00100-20P | 528 |
| SOL4431-130-21 | 58100-94532-019 | 528 |
| SOL4431-130-21 | 58100-94571-019 | 528 |
| SOL4431-130-21 | 99105-00100-22P | 528 |
| SOL4431-133-17 | 58100-94512-019 | 528 |
| SOL4431-133-17 | 58100-94581-019 | 528 |
| SOL4431-133-17 | 99105-00100-18P | 528 |
| SOL4431-135-15 | 58100-94500-019 | 528 |
| SOL4431-135-15 | 58100-94554-019 | 528 |
| SOL4431-135-15 | 99105-00100-16P | 528 |
| SOL4511-142-23 | 99105-00200-24P | 529 |
| SOL4511-143-21 | 99105-00200-22P | 529 |
| SOL4511-145-19 | 99105-00200-20P | 529 |
| SOL4511-148-17 | 99105-00200-18P | 529 |
| SOL4511-150-15 | 99105-00200-16P | 529 |
| SOL4511-150-15 | 58200-87D61-019 | 529 |
| SOL4511-153-19 | 99105-00200-20P | 529 |
| SOL4511-153-21 | 99105-00200-22P | 529 |
| SOL4511-155-17 | 99105-00200-18P | 529 |
| SOL4512-142-23 | 99105-0020L-24P | 529 |
| SOL4512-143-21 | 99105-0020L-22P | 529 |
| SOL4512-145-19 | 99105-0020L-20P | 529 |
| SOL4512-148-17 | 99105-0020L-18P | 529 |
| SOL4512-150-15 | 99105-0020L-16P | 529 |
| SOL4512-153-19 | | 529 |
| SOL4512-153-21 | | 529 |
| SOL4512-155-17 | | 529 |
| SOL4512-158-15 | | 529 |
| SOL4513-140-21 | 58200-87D21-019 | 529 |
| SOL4513-143-19 | 58200-87D11-019 | 529 |
| SOL4513-145-17 | 58200-87D01-019 | 529 |
| SOL4513-148-15 | 58200-87D61-019 | 529 |
| SOL4551-140-24 | 99105-00200-24P | 529 |
| SOL4551-143-22 | 58200-87D21-019 | 529 |
| SOL4551-143-22 | 99105-00200-22P | 529 |
| SOL4551-148-16 | 58200-87D61-019 | 529 |
| SOL4551-148-16 | 99105-00200-16P | 529 |
| SOL4551-148-18 | 58200-87D01-019 | 529 |
| SOL4551-148-18 | 99105-00200-18P | 529 |

| REF | R.O./OEM | |
|----------------|-----------------|-----|
| SOL4551-148-20 | 58200-87D11-019 | 529 |
| SOL4551-148-20 | 99105-00200-20P | 529 |
| SOL4552-140-24 | 99105-0020L-24P | 529 |
| SOL4552-143-22 | 58200-87D22-019 | 529 |
| SOL4552-143-22 | 99105-0020L-22P | 529 |
| SOL4552-148-16 | 58200-87D62-019 | 529 |
| SOL4552-148-16 | 99105-0020L-16P | 529 |
| SOL4552-148-18 | 58200-87D02-019 | 529 |
| SOL4552-148-18 | 99105-0020L-18P | 529 |
| SOL4552-148-20 | 58200-87D12-019 | 529 |
| SOL4552-148-20 | 99105-0020L-20P | 529 |
| SOL4571-148-23 | | 529 |
| SOL4571-149-22 | | 529 |
| SOL4571-151-20 | | 529 |
| SOL4571-154-18 | | 529 |
| SOL4572-148-23 | | 529 |
| SOL4572-149-22 | | 529 |
| SOL4572-151-20 | | 529 |
| SOL4572-154-18 | | 529 |
| SOL9311-110-15 | | 530 |
| SOL9311-111-13 | | 530 |
| SOL9311-111-14 | | 530 |
| SOL9311-114-12 | | 530 |
| SOL9311-116-11 | | 530 |
| SOL9311-120-10 | | 530 |
| SOL9311-121-09 | | 530 |
| SOL9331-110-15 | | 530 |
| SOL9331-111-13 | | 530 |
| SOL9331-111-14 | | 530 |
| SOL9331-114-12 | | 530 |
| SOL9331-116-11 | | 530 |
| SOL9331-120-10 | | 530 |
| SOL9331-121-09 | | 530 |
| SOL9331-110-15 | | 530 |
| SOL9331-111-13 | | 530 |
| SOL9331-111-14 | | 530 |
| SOL9331-114-12 | | 530 |
| SOL9331-116-11 | | 530 |
| SOL9411-132-19 | | 530 |
| SOL9411-132-21 | | 530 |
| SOL9411-133-17 | | 530 |
| SOL9411-135-15 | | 530 |
| SOL9411-138-13 | | 530 |
| SOL9411-140-09 | | 530 |
| SOL9411-140-11 | | 530 |
| SOL9431-130-19 | | 530 |
| SOL9431-130-21 | | 530 |
| SOL9431-133-17 | | 530 |
| SOL9431-135-15 | | 530 |
| SOL9431-138-13 | | 530 |
| SOL9432-130-19 | | 530 |
| SOL9432-133-17 | | 530 |
| SOL9432-135-15 | | 530 |
| SOL9432-138-13 | | 530 |
| SOL9511-143-21 | | 530 |
| SOL9511-145-19 | | 530 |
| SOL9511-148-17 | | 530 |
| SOL9511-150-15 | | 530 |
| SOL9511-153-13 | | 530 |
| SOL9511-155-11 | | 530 |
| SOL9511-160-13 | | 530 |
| SOL9531-140-19 | | 530 |
| SOL9531-140-21 | | 530 |
| SOL9531-140-23 | | 530 |
| SOL9531-143-17 | | 530 |
| SOL9531-145-15 | | 530 |
| SOL9532-140-19 | | 530 |
| SOL9532-140-21 | | 530 |
| SOL9532-140-23 | | 530 |
| SOL9532-143-17 | | 530 |
| SOL9532-145-15 | | 530 |
| SOL9571-145-25 | | 530 |
| SOL9571-148-23 | | 530 |
| SOL9571-150-21 | | 530 |
| SOL9571-153-19 | | 530 |
| SOL9571-155-17 | | 530 |
| SOL9571-158-15 | | 530 |
| SOL9572-145-25 | | 530 |
| SOL9572-148-23 | | 530 |
| SOL9572-150-21 | | 530 |
| SOL9572-153-19 | | 530 |
| SOL9572-155-17 | | 530 |
| SOL9572-158-15 | | 530 |
| SOLRBX-104 | | 529 |
| SOLRBX-110 | | 529 |
| SOLRBX-115 | | 529 |
| SOLRBX-125 | | 529 |
| SOLRBX-126 | | 529 |
| SOLRBX-150 | | 529 |

T

| | | |
|------------|-------------|-----|
| TEN01166 | 11281-94400 | 479 |
| TEN01200 | 55125-96310 | 478 |
| TEN01201 | 55125-95301 | 478 |
| TEN01202 | 55320-98600 | 478 |
| TEN01203 | 41810-87D00 | 479 |
| TEN01204 | 55320-95310 | 478 |
| TEN01204 | 55320-98311 | 478 |
| TEN01204AL | 55320-95310 | 478 |
| TEN01204AL | 55320-98311 | 478 |
| TEN01205 | 11130-94600 | 479 |
| TEN01206 | 55321-93900 | 478 |
| TEN01207 | 55320-98600 | 478 |
| TEN01207 | 55321-95500 | 478 |
| TEN01208 | 55300-95500 | 478 |
| TEN01209 | 55125-94502 | 479 |
| TEN01209 | 55321-94502 | 479 |
| TEN01210 | 55320-98400 | 478 |
| TEN01210/1 | 41811-98500 | 478 |
| TEN01211 | 55120-87801 | 478 |
| TEN01211 | 55125-87D00 | 478 |

| REF | R.O./OEM | |
|-------------|-------------|---------------------|
| TEN01212 | 55321-90J01 | 478 |
| TEN01213 | 55321-87J00 | 478 |
| TEN01213 | 55321-87J01 | 478 |
| TEN01213 | 55321-87J00 | 479 |
| TEN01214 | 55320-94900 | 478 |
| TEN01214AL | 55320-94900 | 478 |
| TEN01215 | 55125-90J01 | 478-512-513-515-516 |
| TEN01215 | 55125-98J00 | 517 |
| TR1305-0386 | | 442 |
| TR1305-0566 | | 442 |
| TX4200K | | 467 |
| TX6400K | | 467 |

| R.O. / OEM | REF | | R.O. / OEM | REF | | R.O. / OEM | REF | |
|-----------------|--------------------|-----------------|--------------|----------------|-----------------|-------------|----------------|---------------------|
| 13650-52G00 | REC13650-52G00 | 454 | 16510-87J00 | REC16510-87J00 | 439-440-449 | 17400-99J01 | REC17400-99J01 | 439-475-476-499-503 |
| 13650-56B00 | REC13650-56B00 | 454 | 16510-87JL0 | REC16510-87J00 | 449 | 17410-93910 | REC17411-93901 | 471 |
| 13910-87D00 | REC13910-87D00 | 453 | 16510-90J00 | REC16510-90J00 | 449 | 17410-94431 | REC17411-94421 | 471 |
| 13910-89J01 | REC13910-89J01 | 453 | 16510-90J00 | REC16510-90J00 | 440-441-449 | 17411-93901 | REC17411-93901 | 471-501 |
| 13910-94400 | REC13910-94400 | 453 | 16510-92J00 | REC16510-82703 | 449 | 17411-94421 | REC17411-94421 | 471-507-509 |
| 13910-94701 | REC13910-94701 | 453 | 16510-96J00 | REC16510-93J00 | 449 | 17413-92J00 | REC17413-92J01 | 473 |
| 14141-93952-0EP | REC14141-93952-0EP | 495 | 16510-96J00 | REC16510-96J00 | 449 | 17413-92J01 | REC17413-92J01 | 473-515-516 |
| 14151-87L00 | REC14151-87L00 | 494 | 16510-96J10 | REC16510-93J00 | 449 | 17413-95J00 | REC17413-95J00 | 439-473-505-511 |
| 14151-93901 | REC14151-93912 | 495 | 16510-96J10 | REC16510-96J00 | 441 | 17413-96J00 | REC17413-96J01 | 473 |
| 14151-93J00 | REC14151-93J00 | 494 | 16510-96J10 | REC16510-96J00 | 449 | 17413-96J01 | REC17413-96J01 | 441-473-517 |
| 14151-94412 | REC14151-94411 | 495 | 16539-87L00 | REC16539-87L00 | 482-485 | 17413-99E10 | REC17413-99E11 | 512-513 |
| 14151-96310 | REC14151-96311 | 495 | 17400-87811 | REC17400-87810 | 440 | 17413-99E11 | REC17413-99E11 | 473 |
| 14152-93J00 | REC14152-93J00 | 494 | 17400-87820 | REC17400-87820 | 440 | 17416-92J00 | REC17416-92J00 | 515 |
| 14212-91L00 | REC14212-91L00 | 495 | 17400-87D00 | REC17400-87D11 | 474 | 17416-92J10 | REC17416-92J10 | 472-515-516 |
| 14212-93J00 | REC14212-93J00 | 494 | 17400-87D10 | REC17400-87D11 | 474 | 17416-93J00 | REC17416-93J00 | 472-518 |
| 14212-94412 | REC14212-94413 | 495 | 17400-87D11 | REC17400-87D11 | 474-476 | 17416-95J00 | REC17416-95J00 | 472-505-511 |
| 14212-96310 | REC14212-91L00 | 495 | 17400-87E03 | REC17400-87E04 | 440-474-476-512 | 17416-96J00 | REC17416-96J00 | 472-517 |
| 15100-91J00 | PAF4-04090000 | 450 | 17400-87L00 | REC17400-87L01 | 475 | 17416-99E10 | REC17416-99E10 | 472-513 |
| 15100-91J01 | PAF4-04090000 | 450 | 17400-87L01 | REC17400-87L01 | 440-475-476-513 | 17417-92J00 | REC17417-92J00 | 472-515 |
| 15100-91J02 | PAF4-04090000 | 450 | 17400-88810 | REC17400-88810 | 440 | 17431-92L20 | REC17431-92L20 | 521 |
| 15100-94301 | REC692-24410-00 | 450 | 17400-88L00 | REC17400-88L00 | 440-475-476-511 | 17431-94440 | REC17431-92L20 | 521 |
| 15100-94303 | REC692-24410-00 | 450 | 17400-89810 | REC17400-89810 | 439 | 17431-94441 | REC17431-92L20 | 521 |
| 15100-94310 | REC692-24410-00 | 450 | 17400-89820 | REC17400-89820 | 440 | 17450-93440 | REC17450-93921 | 471 |
| 15100-94311 | REC692-24410-00 | 450 | 17400-90J11 | REC17400-90J20 | 475 | 17450-93920 | REC17450-93921 | 471 |
| 15170-91J00 | REC15170-91J00 | 451 | 17400-90J20 | REC17400-90J20 | 475 | 17450-93921 | REC17450-93921 | 471-501 |
| 15170-93920 | REC15170-93911 | 451 | 17400-90J20 | REC17400-90J20 | 476-515 | 17450-93930 | REC17450-93921 | 471 |
| 15170-94320 | REC15170-94320 | 451 | 17400-91830 | REC17400-91830 | 439 | 17451-96301 | CEF500362G | 469 |
| 15170-94J00 | REC15170-94J00 | 451 | 17400-91860 | REC17400-91860 | 439 | 17451-96301 | REC17461-96312 | 469 |
| 15170-98110 | REC15170-98110 | 451 | 17400-91860 | REC17400-91860 | 439 | 17452-93910 | REC17452-93910 | 473-501 |
| 15170-99E00 | REC15170-99E00 | 451 | 17400-92821 | REC17400-92821 | 441 | 17453-93900 | REC17453-93901 | 501-521 |
| 15200-90J00 | REC63P-13907-03 | 450 | 17400-92840 | REC17400-92840 | 440 | 17453-93901 | REC17453-93901 | 521 |
| 15200-92J00 | REC63P-13907-03 | 450 | 17400-92850 | REC17400-92850 | 441 | 17461-87E10 | CEF500365 | 470 |
| 15200-92J00 | REC63P-14984-00 | 450 | 17400-92D01 | REC17400-92D01 | 474-476 | 17461-87E10 | REC17461-87E12 | 470 |
| 15200-92J00 | REC15200-82J20 | 451 | 17400-92D11 | REC17400-92D01 | 474 | 17461-87E11 | CEF500365 | 470 |
| 15200-92J20 | REC15200-82J20 | 451 | 17400-92J20 | REC17400-92J00 | 475-476 | 17461-87E11 | REC17461-87E12 | 470 |
| 15200-93J01 | REC63P-13907-03 | 450 | 17400-92J21 | REC17400-92J21 | 475-476-515-516 | 17461-87E12 | CEF500365 | 469-470 |
| 15200-96J00 | REC15200-96J00 | 450 | 17400-93851 | REC17400-93851 | 441 | 17461-87E12 | REC17461-87E12 | 469-470-512-513 |
| 15410-87J10 | REC15410-87J00 | 448 | 17400-93911 | REC17400-93912 | 475 | 17461-90J00 | CEF500367 | 469 |
| 15410-87J10 | REC15410-87J10 | 440-447 | 17400-93912 | REC17400-93912 | 475 | 17461-90J00 | REC17461-90J01 | 469 |
| 15410-87J30 | REC15410-87J30 | 439-440-441-447 | 17400-93950 | REC17400-93951 | 474-501 | 17461-90J01 | CEF500367 | 469-470 |
| 15410-87L00 | REC15410-87L00 | 439-440-447 | 17400-93951 | REC17400-93951 | 476-501 | 17461-90J01 | REC17461-90J01 | 469-470-515-516-517 |
| 15410-88L00 | REC15410-88L00 | 440-448 | 17400-93J00 | REC17400-93J01 | 474 | 17461-92D02 | CEF500319 | 469 |
| 15410-93J00 | REC15410-93J00 | 448 | 17400-93J01 | REC17400-93J01 | 441-474-476 | 17461-92D02 | REC17461-92D02 | 469 |
| 15410-94350 | REC16910-GB2-005 | 448 | 17400-93J02 | REC17400-93J01 | 474 | 17461-93001 | CEF500398 | 469 |
| 15410-94400 | PAF15-07080000 | 447 | 17400-93J03 | REC17400-93J01 | 474 | 17461-93001 | REC17461-93004 | 469 |
| 15410-96J00 | REC15410-96J00 | 441-447 | 17400-94611 | REC17400-94611 | 475-476 | 17461-93002 | CEF500398 | 469 |
| 15410-98500 | REC15410-98500 | 439-448 | 17400-94700 | REC17400-94701 | 474 | 17461-93002 | REC17461-93004 | 469 |
| 15410-98500 | REC90794-46868 | 448 | 17400-94701 | REC17400-94701 | 474-476 | 17461-93002 | REC17461-93004 | 469 |
| 15412-92J00 | REC15412-92J00 | 441-448 | 17400-94810 | REC17400-94810 | 439 | 17461-93003 | CEF500398 | 469 |
| 15412-93J00 | REC65L-24563-00 | 447 | 17400-94810 | REC17400-94810 | 440 | 17461-93003 | REC17461-93004 | 469 |
| 15412-93J10 | REC15412-93J10 | 441-448 | 17400-94821 | REC17400-94821 | 439-476 | 17461-93004 | CEF500398 | 469 |
| 15440-87L10 | REC15440-87L10 | 448 | 17400-94J200 | REC17400-94J00 | 440-475-476 | 17461-93004 | REC17461-93004 | 469 |
| 15440-90J00 | REC15440-90J00 | 448 | 17400-94L00 | REC17400-94L00 | 474 | 17461-93901 | CEF500329 | 469 |
| 15440-93J00 | REC15440-93J00 | 448 | 17400-95350 | REC17400-95351 | 474 | 17461-93901 | REC17461-93903 | 469 |
| 15440-96J00 | REC15440-96J00 | 448 | 17400-95351 | REC17400-95351 | 474-476 | 17461-93902 | CEF500329 | 469 |
| 15440-96J01 | REC15440-96J01 | 448 | 17400-95550 | REC17400-95351 | 474 | 17461-93902 | REC17461-93903 | 469 |
| 15440-99E00 | REC15440-99E01 | 449 | 17400-95870 | REC17400-95870 | 439 | 17461-93902 | CEF500329 | 469-470 |
| 15440-99E01 | REC15440-99E01 | 449 | 17400-95J01 | REC17400-95J02 | 476 | 17461-93903 | REC17461-93903 | 470 |
| 15626-90J00 | REC15626-90J00 | 451 | 17400-95J02 | REC17400-95J02 | 439-476-505 | 17461-93903 | REC17461-93903 | 469-470-501-503 |
| 15626-99E00 | REC15626-99E00 | 451 | 17400-96350 | REC17400-96403 | 474 | 17461-93903 | REC17461-93903 | 499 |
| 15643-93J00 | REC69J-24501-10 | 448 | 17400-96351 | REC17400-96403 | 474 | 17461-93J00 | CEF500393 | 470 |
| 15643-99E00 | REC15626-99E00 | 451 | 17400-96352 | REC17400-96403 | 474-507 | 17461-93J00 | REC17461-93J00 | 470-518 |
| 15710-50M00 | REC15710-89L00 | 451 | 17400-96353 | REC17400-96403 | 509 | 17461-94510 | CEF500367 | 469 |
| 15710-65D00 | REC15710-65D00 | 452 | 17400-96403 | REC17400-96403 | 440-474-476-509 | 17461-94510 | REC17461-90J01 | 469 |
| 15710-66D00 | REC15710-66D00 | 452 | 17400-96821 | REC17400-96821 | 441 | 17461-94700 | CEF500361 | 469 |
| 15710-82K50 | REC15710-82K50 | 453 | 17400-96J00 | REC17400-96J03 | 475 | 17461-94700 | REC17461-94700 | 469 |
| 15710-82M00 | REC15710-82M00 | 452 | 17400-96J01 | REC17400-96J03 | 475 | 17461-94701 | CEF500361 | 469 |
| 15710-85K00 | REC15710-85K00 | 452 | 17400-96J02 | REC17400-96J03 | 475 | 17461-94701 | REC17461-94700 | 469 |
| 15710-87J00 | REC15710-87J00 | 452 | 17400-96J03 | REC17400-96J03 | 441-475-476-517 | 17461-94701 | CEF500361 | 469 |
| 15710-87L00 | REC15710-87L00 | 452 | 17400-97810 | REC17400-97810 | 439 | 17461-94701 | REC17461-94700 | 469 |
| 15710-89L00 | REC15710-89L00 | 452 | 17400-97810 | REC17400-97810 | 439 | 17461-94L00 | REC17461-96312 | 470 |
| 15710-93J00 | REC15710-93J00 | 453 | 17400-97821 | REC17400-97820 | 439 | 17461-95200 | CEF500361 | 469 |
| 15710-96J00 | REC15710-96J00 | 453 | 17400-98551 | REC17400-98551 | 474-476 | 17461-95200 | REC17461-94700 | 469 |
| 15710-99E00 | REC15710-99E00 | 452 | 17400-98652 | REC17400-98652 | 474-476 | 17461-95201 | CEF500312 | 469 |
| 16433-93J00 | REC16433-93J00 | 485 | 17400-98661 | REC17400-98652 | 474 | 17461-95201 | REC17461-94700 | 469 |
| 16510-05240 | REC16510-05240 | 449 | 17400-98661 | REC17400-98661 | 439-474-476-497 | 17461-95300 | CEF500360 | 469 |
| 16510-05240 | REC16510-05240 | 439-449 | 17400-98661 | REC17400-98661 | 474 | 17461-95300 | REC17461-95300 | 469 |
| 16510-45H10 | REC16510-05240 | 449 | 17400-986L0 | REC17400-98661 | 474 | 17461-95301 | CEF500360 | 469 |
| 16510-61A01 | REC16510-90J00 | 449 | 17400-986L1 | REC17400-98661 | 474 | 17461-95301 | REC17461-95300 | 469 |
| 16510-61A20-MHL | REC16510-90J00 | 449 | 17400-98861 | REC17400-98861 | 441 | 17461-95302 | CEF500360 | 469 |
| 16510-61A21-MHL | REC16510-90J00 | 449 | 17400-98861 | REC17400-98861 | 441 | 17461-95303 | REC17461-95300 | 469 |
| 16510-61A30 | REC16510-90J00 | 449 | 17400-98J00 | REC17400-98J01 | 474 | 17461-95501 | CEF500360 | 469 |
| 16510-61A31 | REC16510-90J00 | 449 | 17400-98J01 | REC17400-98J01 | 474-518 | 17461-95501 | REC17461-95300 | 469 |
| 16510-81A20 | REC16510-82703 | 449 | 17400-98J02 | REC17400-98J01 | 441-474-476 | 17461-95501 | CEF500362G | 469 |
| 16510-82703 | REC16510-82703 | 449 | 17400-99840 | REC17400-99840 | 439 | 17461-96301 | REC17461-96312 | 469 |
| 16510-87J00 | REC16510-87J00 | 449 | 17400-99870 | REC17400-99870 | 440 | 17461-96310 | CEF500362G | 469 |
| | | | 17400-99J00 | REC17400-99J01 | 475 | | | |

| R.O. / OEM | REF | | R.O. / OEM | REF | | R.O. / OEM | REF | |
|----------------|--------------------|---------------------|--------------|------------------|-------------------------|-----------------|--------------------|---------|
| 17461-96310 | REC17461-96312 | 469 | 25700-94400 | REC25700-88L00 | 519 | 32800-95D00 | REC32800-95D01 | 458 |
| 17461-96312 | CEF500362G | 470 | 25700-94500 | REC25700-94500 | 520 | 32800-95D01 | REC32800-95D01 | 458-459 |
| 17461-96312 | REC17461-96312 | 470-505-507-509-511 | 25700-94700 | REC25700-94700 | 519-520 | 32800-98J01 | REC32800-98J01 | 459 |
| 17461-96400 | CEF500399 | 469 | 25700-95500 | REC25700-95501 | 519-520 | 32800-99J00 | REC32800-99J00 | 459 |
| 17461-97110 | REC17461-97JMO | 439-470 | 25700-95D00 | REC25700-95D01 | 519 | 32900-93902 | REC32900-93903 | 455 |
| 17461-98501 | CEF500336 | 469 | 25700-95D01 | REC25700-95D01 | 507-519-520 | 32900-93903 | REC32900-93903 | 455 |
| 17461-98501 | REC17461-98503 | 469 | 25700-95J00 | REC25700-95J00 | 505-519-520 | 32900-93911 | REC32900-93910 | 460 |
| 17461-98502 | CEF500336 | 469 | 25700-98J00 | REC25700-98J00 | 519-520 | 32900-94401 | REC32900-94480 | 455 |
| 17461-98502 | REC17461-98503 | 469 | 25700-99E00 | REC25700-99E00 | 512-519-520 | 32900-94421 | REC32900-94480 | 455 |
| 17461-98503 | CEF500336 | 469-470 | 29116-93J00 | PAGB/T5787-M6X20 | 501 | 32900-94460 | REC32900-94460 | 460 |
| 17461-98503 | REC17461-98503 | 469-470 | 29116-93J10 | PAF8-00000003 | 513 | 32900-94470 | REC32900-94460 | 460 |
| 17461-985M0 | REC17461-98503 | 470-497 | 29141-93J00 | PAGB/T6170-M6 | 497-499-501-505-509-511 | 32900-94480 | REC32900-94480 | 455 |
| 17462-93990 | REC17462-93990 | 470-501 | 29141-93J00 | PAGB/T6184-2000 | 503 | 32900-96340 | REC32900-96340 | 455 |
| 17471-87E00 | REC17471-92J00 | 471 | 29162-93J00 | PAGB/T93-6 | 499-501-509-511 | 32900-96350 | REC32900-96371 | 460 |
| 17471-87E01 | REC17471-92J00 | 471-512 | 31100-87000 | PH130-0052 | 457 | 32900-96370 | REC32900-96371 | 460 |
| 17471-92J00 | REC17471-92J00 | 471-515-516 | 31100-87500 | PH130-0079 | 458 | 32900-96371 | REC32900-96371 | 460 |
| 17471-93902 | REC17471-93902 | 471-501 | 31100-87D00 | PH130-0052 | 457 | 33220-58J20 | REC33220-58J20 | 454 |
| 17471-93J00 | REC17471-92J02 | 471 | 31100-87D10 | PH130-0052 | 457 | 33220-76G00 | REC33220-76G02 | 454 |
| 17471-93J01 | REC17471-92J02 | 471 | 31100-87J00 | PH130-0079 | 458 | 33220-76G01 | REC33220-76G02 | 454 |
| 17471-93J02 | REC17471-92J02 | 471-517 | 31100-87J10 | PH130-0079 | 458 | 33220-76G02 | REC33220-76G02 | 454 |
| 17471-94401 | REC17471-94401 | 471-507-509 | 31100-87J11 | PH130-0079 | 458 | 33410-93E10 | REC33410-94400-000 | 455 |
| 17471-95J00 | REC17471-95J01 | 471 | 31100-89J00 | PH130-0006 | 457 | 33410-93J00 | REC33410-93J00 | 455 |
| 17471-95J01 | REC17471-95J01 | 471-505-511 | 31100-90J00 | PH130-0071 | 457 | 33410-94400-000 | REC33410-94400-000 | 455 |
| 17471-97J00-00 | REC17471-97J00 | 439-471 | 31100-90J01 | PH130-0071 | 457 | 33410-96L00 | REC33410-96L00 | 455 |
| 17471-97JL0 | REC17471-97JL0 | 439-471 | 31100-92E00 | PH130-0052 | 457 | 34801-93J00 | REC34801-93J03 | 463 |
| 17471-98600 | REC17471-98601 | 471 | 31100-93J00 | PH130-0078 | 458 | 34801-93J01 | REC34801-93J03 | 463 |
| 17471-98601 | REC17471-98601 | 471 | 31100-94400 | PH130-0006 | 457 | 34801-93J02 | REC34801-93J03 | 463 |
| 17472-87E00 | REC17472-87E10 | 472 | 31100-944002 | PH130-0006 | 457 | 34801-93J03 | REC34801-93J03 | 463 |
| 17472-87E10 | REC17472-87E10 | 472-512-515-516 | 31100-94401 | PH130-0006 | 457 | 34801-94700 | REC34801-94710 | 463 |
| 17472-87L00 | REC17472-87L00 | 472-482-513 | 31100-94500 | PH130-0053 | 457 | 34801-94710 | REC34801-94710 | 463 |
| 17472-91J00 | REC17472-91J00 | 473-497 | 31100-94510 | PH130-0053 | 457 | 34801-99E01 | REC34801-99E04 | 463 |
| 17472-92D10 | REC17472-92D10 | 473 | 31100-94511 | PH130-0053 | 457 | 34801-99E02 | REC34801-99E04 | 463 |
| 17472-93911 | REC17472-93911 | 473-501 | 31100-94512 | PH130-0053 | 457 | 34801-99E03 | REC34801-99E04 | 463 |
| 17472-93J00 | REC17472-93J00 | 473-517 | 31100-94600 | PH130-0053 | 457 | 34801-99E04 | REC34801-99E04 | 463 |
| 17472-95310 | REC17472-95310 | 473 | 31100-94601 | PH130-0053 | 457 | 36620-93J02 | REC36620-93J02 | 466 |
| 17472-96301 | REC17472-96303 | 472 | 31100-94610 | PH130-0053 | 457 | 36620-94J01 | REC36620-94J01 | 466 |
| 17472-96302 | REC17472-96303 | 472 | 31100-94610 | PH130-0053 | 457 | 37100-87J00-OEP | REC38100-87J00 | 462 |
| 17472-96303 | REC17472-96303 | 472 | 31100-94702 | PH130-0075 | 457 | 37100-96J14 | REC37100-96J15 | 465 |
| 17472-97J00 | REC17472-97J00 | 439-472 | 31100-94J10 | PH130-0077 | 457 | 37100-96J15 | REC37100-96J15 | 465 |
| 17472-97JL0 | REC17472-97JL0 | 439-472 | 31100-94J21 | PH130-0077 | 457 | 37100-96J20 | REC37100-96J25 | 465 |
| 17472-98503 | REC17472-98503 | 473 | 31100-94J22 | PH130-0077 | 457 | 37100-96J21 | REC37100-96J25 | 465 |
| 17472-98611 | REC17472-98611 | 473 | 31100-95240 | PH130-0007 | 457 | 37100-96J22 | REC37100-96J25 | 465 |
| 17472-98J00 | REC17472-98J00 | 472-518 | 31100-95242 | PH130-0007 | 457 | 37100-96J23 | REC37100-96J25 | 465 |
| 17560-91L00 | REC17560-91L00 | 521 | 31100-95243 | PH130-0007 | 457 | 37100-96J24 | REC37100-96J25 | 465 |
| 17560-96300 | REC17560-91L00 | 521 | 31100-95310 | PH130-0060 | 457 | 37100-96J25 | REC37100-96J25 | 465 |
| 17560-96301 | REC17560-91L00 | 521 | 31100-95312 | PH130-0060 | 457 | 37110-93J10 | REC37110-93J11 | 458 |
| 17560-96304 | REC17560-91L00 | 521 | 31100-95313 | PH130-0060 | 457 | 37110-93L10 | REC37110-93J11 | 458 |
| 17616-87J00 | REC17616-87J00 | 468-481-486 | 31100-95521 | PH130-0060 | 457 | 37110-99E00 | REC37110-99E00 | 458 |
| 17670-90J20 | REC17670-90J20 | 468 | 31100-95600 | PH130-0060 | 457 | 37220-92E00 | REC37220-92E00 | 465 |
| 17670-91J00 | REC17670-91J01 | 468 | 31100-95601 | PH130-0060 | 457 | 37800-93953 | REC37800-93954 | 460 |
| 17670-91J01 | REC17670-91J01 | 468 | 31100-95D00 | PH130-0006 | 457 | 37800-93954 | REC37800-93954 | 460 |
| 17670-93962 | REC17670-93962 | 468 | 31100-95J00 | PH130-0077 | 457 | 37820-92E00 | REC37820-92E03 | 460 |
| 17670-93J00 | REC67F-12411-01 | 468 | 31100-95J01 | PH130-0077 | 457 | 37830-89E02 | REC37830-89E03 | 460 |
| 17670-94402 | REC17670-94402 | 468 | 31100-96310 | PH130-0006 | 457 | 37830-95D00 | REC37830-89E03 | 460 |
| 17670-94J00 | REC17670-94J01 | 468 | 31100-96311 | PH130-0006 | 457 | 37830-95D01 | REC37830-95D04 | 460 |
| 17670-94J01 | REC17670-94J01 | 468 | 31100-96J00 | PH130-0078 | 458 | 37830-95D02 | REC37830-95D04 | 460 |
| 17685-87D00 | REC17685-87D10 | 486-488 | 31100-96J01 | PH130-0078 | 458 | 37830-95D03 | REC37830-95D04 | 460 |
| 17685-87D10 | REC17685-87D10 | 481-486-488 | 31100-98L00 | PH130-0078 | 458 | 37830-95D04 | REC37830-95D04 | 460 |
| 17693-95J00 | REC17693-95J00 | 485 | 31100-98L10 | REC31100-98L10 | 458 | 37850-90J00 | REC37850-90J06 | 464 |
| 1770-90J10 | REC17670-90J10 | 468 | 31800-94400 | REC89-825096T01 | 458 | 37850-90J01 | REC37850-90J06 | 464 |
| 17822-90J00 | REC09401-11425 | 443 | 31800-94401 | REC89-825096T01 | 458 | 37850-90J02 | REC37850-90J06 | 464 |
| 17822-90J00 | REC09401-11425BULK | 443 | 32140-93900 | REC32140-93900 | 455 | 37850-90J03 | REC37850-90J06 | 464 |
| 17913-93J00 | REC17913-93J00 | 469 | 32140-94400 | REC32140-94400 | 455 | 37850-90J04 | REC37850-90J06 | 464 |
| 17914-93J00 | REC17914-93J00 | 469 | 32140-96310 | REC32140-96310 | 455 | 37850-90J05 | REC37850-90J06 | 464 |
| 17914-93JL0 | REC17914-93J00 | 469 | 32800-38F10 | REC32800-38F10 | 459 | 37850-90J06 | REC37850-90J06 | 464 |
| 18137-52D00 | REC18137-52D00 | 452-454 | 32800-87J10 | REC32800-87J10 | 459 | 37850-93J10 | REC37850-93J10 | 465 |
| 18137-87L01 | REC18137-87L01 | 452-454 | 32800-87L00 | REC32800-87L00 | 459 | 38100-87D00 | REC38100-87E10-OED | 461 |
| 18137-88L01 | REC18137-88L01 | 452-454 | 32800-88L00 | REC32800-88L00 | 459 | 38100-87D01-02M | REC38100-87E10-OED | 461 |
| 18137-93J00 | REC18137-93J00 | 452-454 | 32800-89J00 | REC32800-89J00 | 459 | 38100-87D01-OED | REC38100-87E10-OED | 461 |
| 18590-58M00 | REC18590-58M00 | 452-454 | 32800-89J10 | REC32800-89J10 | 459 | 38100-87D02H | REC38100-87E10-OED | 461 |
| 18590-68H00 | REC18590-68H00 | 452-454 | 32800-89J11 | REC32800-89J11 | 459 | 38100-87D0IT | REC38100-87E10-OED | 461 |
| 18590-72F21 | REC18590-72F21 | 452-454 | 32800-89J11 | REC32800-89J11 | 459 | 38100-87D10-0ED | PH200-T024 | 462 |
| 23211-94401 | REC23211-94401 | 523 | 32800-89L00 | REC32800-89L00 | 459 | 38100-87D10-0IT | PH200-T024 | 462 |
| 23311-95DL0 | REC23311-95DL0 | 520 | 32800-89L01 | REC32800-89L01 | 459 | 38100-87D10-35J | PH200-T024 | 462 |
| 25222-93901 | REC25222-93901 | 520 | 32800-89L01 | REC32800-89L01 | 459 | 38100-87E10-0ED | REC38100-87E10-OED | 461 |
| 25222-96300 | REC25222-96300 | 520 | 32800-92E20 | REC32800-92E20 | 459 | 38100-87E20-0ED | PH200-T024 | 462 |
| 25700-87D00 | REC25700-87D00 | 519-520 | 32800-93J01 | REC32800-93J03 | 459 | 38100-87J11 | PH200-T046 | 462 |
| 25700-87E00 | REC25700-87E00 | 519-520 | 32800-93J02 | REC32800-93J03 | 459 | 38100-87J20 | PH200-T046 | 462 |
| 25700-87L00 | REC25700-87L00 | 513-519-520 | 32800-93J03 | REC32800-93J03 | 459 | 38100-87JOEP | REC38100-87J00 | 462 |
| 25700-88400 | REC25700-88L00 | 509-511-520 | 32800-94620 | REC32800-94620 | 458 | 38100-87L00 | REC36120-ZY9-003 | 462 |
| 25700-88L00 | REC25700-88L00 | 509-511-520 | 32800-94620 | REC32800-94620 | 458 | 38100-87L01 | REC36120-ZY9-003 | 462 |
| 25700-90J01 | REC25700-90J01 | 515-520 | 32800-94J10 | REC32800-94J11 | 459 | 38100-87L02 | REC36120-ZY9-003 | 462 |
| 25700-92J00 | REC25700-92J00 | 515-516-519-520 | 32800-94J11 | REC32800-94J11 | 459 | 38100-87L03 | REC36120-ZY9-003 | 462 |
| 25700-93J00 | REC25700-93J00 | 517-519-520 | 32800-95720 | REC32800-95720 | 459 | 38100-88L00 | REC36120-ZW4-H12 | 462 |
| 25700-93L00 | REC25700-93L00 | 518-519-520 | | | 458 | 38100-88L11 | REC36120-ZW4-H12 | 462 |
| | | | | | | 38100-88L12 | REC36120-ZW4-H12 | 462 |

| R.O. / OEM | REF | | R.O. / OEM | REF | | R.O. / OEM | REF | |
|-----------------|--------------------|---------------------|------------------|--------------------|-------------------------|-----------------|-----------------|-----------------|
| 38100-90J30 | REC36120-ZY6-013 | 462 | 55300-95500 | CM55300-95500 | 476-499-501-507-509-511 | 57311-99J10 | REC57311-99J10 | 499-525 |
| 38100-90J40 | REC36120-ZY6-013 | 462 | 55300-95500 | CM55300-95500A | 476 | 57510-89J00 | REC57510-89J00 | 505-507-525 |
| 38100-92E00-OED | PH200-T024 | 462 | 55300-95500 | TEN01208 | 478 | 57510-90L00 | REC57510-93910 | 525 |
| 38100-92J01 | REC38100-96J00 | 461 | 55320-93900 | CM55125-87D00 | 477 | 57510-91J00 | REC57510-91J00 | 497-525 |
| 38100-92J02 | REC38100-96J00 | 461 | 55320-93900 | CM55125-87D00A | 477 | 57510-91L00 | REC57510-89J00 | 525-531 |
| 38100-92J10 | REC38100-96J00 | 461 | 55320-93900 | CM55321-93900 | 477 | 57510-93902 | REC57510-93902 | 525 |
| 38100-92J12 | REC38100-96J00 | 461 | 55320-93900 | CM55321-93900A | 477 | 57510-93902 | REC57510-93902 | 531 |
| 38100-93J02 | REC38100-96J00 | 461 | 55320-94900 | CM55321-94900 | 476 | 57510-93910 | REC57510-93910 | 501-525 |
| 38100-93J11 | REC36120-ZY6-013 | 462 | 55320-94900 | CM55321-94900A | 441 | 57510-93910 | REC57510-93910 | 531-532 |
| 38100-93J13 | REC36120-ZY6-013 | 462 | 55320-94900 | CM55321-94900A | 476 | 57510-94400 | REC57510-94402 | 525 |
| 38100-96J00 | REC38100-96J00 | 461 | 55320-94900 | CM55321-94900A | 476 | 57510-94401 | REC57510-94402 | 525 |
| 38100-96J01 | REC38100-96J00 | 461 | 55320-94900 | TEN01214 | 478 | 57510-94402 | REC57510-94402 | 525 |
| 38100-97E00-OED | REC38100-97E00-OED | 462 | 55320-94900 | TEN01214AL | 478 | 57510-94402 | REC57510-94402 | 531 |
| 38100-99E01-0EP | REC38100-99E01-0EP | 462 | 55320-95310 | CM55320-95310 | 476 | 57510-98600 | REC57510-91J00 | 525 |
| 38100-99E01-0ED | REC38100-99E01-0EP | 462 | 55320-95310 | CM55320-95310A | 476 | 57510-98610 | REC57510-91J00 | 525 |
| 38100-99E01-0EP | REC38100-99E01-0EP | 462 | 55320-95310 | TEN01204 | 478 | 57510-98611 | REC57510-91J00 | 525 |
| 38410-89J00 | REC89-825096T01 | 458 | 55320-95310 | TEN01204AL | 478 | 57510-99J10 | REC57510-99J11 | 503 |
| 38410-93J00 | REC38410-93J12 | 463 | 55320-95311 | CM55320-95310 | 517 | 57521-89J00 | REC57521-89J00 | 505-507-526-531 |
| 38410-93J10 | REC38410-93J12 | 463 | 55320-98311 | TEN01204 | 478 | 57521-90L00 | REC57521-93910 | 526 |
| 38410-93J11 | REC38410-93J12 | 463 | 55320-98311 | TEN01204AL | 478 | 57521-91J00 | REC57521-91J00 | 497-526 |
| 38410-93J12 | REC38410-93J12 | 463 | 55320-98400 | CM55320-98400 | 476 | 57521-93902 | REC57521-93902 | 526 |
| 38410-94550 | REC89-825096T01 | 458 | 55320-98400 | CM55320-98400A | 476 | 57521-93902 | REC57521-93902 | 531 |
| 38410-94551 | REC89-825096T01 | 458 | 55320-98400 | TEN01210 | 478 | 57521-93902 | REC57521-93902 | 531 |
| 38410-94552 | REC89-825096T01 | 458 | 55320-98600 | CM55320-98600 | 477 | 57521-93910 | REC57521-93910 | 501-526-531 |
| 38860-76F01 | REC38860-76F01 | 460 | 55320-98600 | CM55320-98600A | 477 | 57521-94400 | REC57521-94400 | 526 |
| 41810-87D00 | TEN01203 | 479 | 55320-98600 | TEN01202 | 478 | 57521-94400 | REC57521-94400 | 531 |
| 41810-98500 | CM5033167 | 439 | 55320-98600 | TEN01207 | 478 | 57521-96311 | REC57521-96312 | 526 |
| 41811-98500 | CM41811-98500 | 476-501 | 55321-87J00 | CM55321-87J00 | 476-497-501-511 | 57521-96312 | REC57521-96312 | 526 |
| 41811-98500 | TEN01210/1 | 478 | 55321-87J00 | CM55321-87J00A | 476 | 57521-96312 | REC57521-96312 | 531 |
| 43211-87JL0 | REC43211-87JL0 | 466 | 55321-87J00 | TEN01213 | 478 | 57521-99J10 | REC57521-99J10 | 503 |
| 43211-94401 | REC43211-87JL0 | 466 | 55321-87J00 | TEN01213 | 479 | 57610-93901 | REC57610-93901 | 501-531 |
| 43211-94401 | REC43211-94401 | 466 | 55321-87J00 | TEN01213 | 479 | 57610-94402 | REC57610-94402 | 509-511 |
| 43711-97E00 | REC43711-97E11 | 466 | 55321-87J01 | CM55321-87J00 | 476-479-499-503 | 57610-96311 | REC57610-96311 | 505-507 |
| 43711-97E11 | REC43711-97E11 | 466 | 55321-87J01 | CM55321-87J00A | 476 | 57621-87J00 | REC57621-87J00 | 522 |
| 48500-95550-OED | PH200-T027 | 461 | 55321-87J01 | CM55321-87J00A | 439-440-441 | 57621-87J01 | REC57621-94403 | 522 |
| 48500-95680-OED | PH200-T027 | 461 | 55321-87J01 | TEN01213 | 478 | 57621-87J02 | REC57621-94403 | 522 |
| 48503-93J10 | REC48503-93J12 | 462 | 55321-90J01 | CM55321-90J01 | 477-512-515-516 | 57621-87J03 | REC57621-94403 | 509-511-522 |
| 48503-93J12 | REC48503-93J12 | 462 | 55321-90J01 | CM55321-90J01A | 477 | 57621-91L10 | REC57621-91L10 | 522 |
| 48503-94900-OED | REC48503-93J12 | 462 | 55321-90J01 | TEN01212 | 478 | 57621-94400 | REC57621-94403 | 522 |
| 48600-94511-OED | REC18-6865 | 462 | 55321-93900 | CM55321-93900 | 501 | 57621-94403 | REC57621-94403 | 522-531 |
| 48630-92J00 | REC48630-92J00 | 463 | 55321-93900 | TEN01206 | 478 | 57621-96310 | REC57621-91L10 | 522 |
| 48630-93J00 | REC48630-93J00 | 463 | 55321-93900 | TEN01206 | 478 | 57621-96310 | REC57621-91L10 | 522 |
| 48630-94900 | REC48630-94900 | 463 | 55321-93J00 | REC09116-06094 | 479 | 57630-92E00 | REC57630-92E00 | 517-518-531 |
| 48630-96J00 | REC48630-96J00 | 463 | 55321-94502 | TEN01209 | 479 | 57630-94300 | REC57630-94300 | 511-531 |
| 48630-96J01 | REC48630-96J03 | 463 | 55321-94900 | REC09116-06121 | 479 | 57630-94301 | REC57630-94300 | 509-531 |
| 48630-96J02 | REC48630-96J03 | 463 | 55321-95500 | TEN01207 | 478 | 57630-94500 | REC57630-94500 | 512-531 |
| 48630-96J03 | REC48630-96J03 | 463 | 56120-90L00-OEP | REC56120-93900 | 521 | 57630-96300 | REC57630-96300 | 505-507-531 |
| 48630-98L00 | REC48630-98L01 | 463 | 56120-90L01-OEP | REC56120-93900 | 521 | 57631-93901 | REC57631-93901 | 499-501-503-523 |
| 48630-98L01 | REC48630-98L01 | 463 | 56120-90L02-OEP | REC56120-93900 | 521 | 57631-94700 | REC57631-95303 | 523 |
| 51123-87L00 | REC51123-87L00 | 482-486 | 56120-93900-002M | REC56120-93900 | 521 | 57631-95301 | REC57631-95303 | 523 |
| 51123-93J00 | REC51123-93J00 | 485 | 56120-93900-OEP | REC56120-93900 | 521 | 57631-95302 | REC57631-95303 | 523 |
| 51142-93J00 | REC51142-93J00 | 485 | 56120-93901-OED | REC56120-93900 | 521 | 57631-95303 | REC57631-95303 | 509-511-523 |
| 51211-87J00 | REC51211-87J00 | 481-484 | 56120-93901-OEP | REC56120-93900 | 501 | 57631-96301 | REC57631-96301 | 507-523 |
| 51211-87L00 | REC51211-87L10 | 482-484 | 56120-93901-OEP | REC56120-93900 | 531 | 57632-93902 | REC57632-94J00 | 501 |
| 51211-87L10 | REC51211-87L10 | 482-484 | 56120-94321-OEP | REC56120-94321-OEP | 509-511-521 | 57632-94J00 | REC57632-94J00 | 499-503-532 |
| 51211-90J00 | REC51211-90J10 | 484 | 56120-96332-OEP | REC56120-96332-OEP | 505-507-521 | 57632-97L00 | REC57632-97L00 | 503-522 |
| 51211-90J01 | REC51211-90J10 | 484 | 56130-94411-OEP | REC56130-94413-OEP | 472 | 57632-98500 | REC57632-97L00 | 522 |
| 51211-90J02 | REC51211-90J10 | 484 | 56130-94413-OEP | REC56130-94413-OEP | 472 | 57632-98501 | REC57632-97L00 | 497-522 |
| 51211-90J10 | REC51211-90J10 | 484 | 56130-96320-OEP | REC56130-96331-OEP | 472 | 57633-93900 | REC57633-93901 | 532 |
| 51211-90J21 | REC51211-90J2 | 484 | 56130-96331-OEP | REC56130-96331-OEP | 472 | 57633-93901 | REC57633-93901 | 499-501-503-532 |
| 51211-90J22 | REC51211-90J2 | 484 | 57100-93902 | REC57100-93902 | 501 | 57634-88L00 | REC57634-88L00 | 509-511-522 |
| 51211-93J00 | REC51211-93J00 | 484 | 57100-93902 | REC57100-93902 | 531 | 58100-89L00-019 | SOL4111-093-07A | 528 |
| 52113-93901 | REC52113-93910 | 495 | 57110-92L10 | REC57110-94411 | 531 | 58100-89L20-019 | SOL4111-093-09A | 528 |
| 52113-96304 | REC52113-96330 | 495 | 57110-93912 | REC57110-93912 | 531 | 58100-89L50-019 | SOL4111-093-12A | 528 |
| 52331-87L00 | REC52331-87L00 | 482-494 | 57110-94441 | REC57110-94441 | 531 | 58100-89L60-019 | SOL4111-093-10A | 528 |
| 55120-87801 | TEN01211 | 478 | 57292-94300 | PAGB/T896-6 | 466 | 58100-89L70-019 | SOL4111-093-11A | 528 |
| 55122-88L00 | REC55122-94400 | 473-511 | 57310-93850 | REC57310-93850 | 526 | 58100-90J00-019 | SOL3411-139-17 | 528 |
| 55125-87801 | CM55125-87D00 | 477 | 57310-94401 | REC57310-94401 | 526 | 58100-90J00-019 | SOL3411-139-17 | 528 |
| 55125-87801 | CM55125-87D00A | 477 | 57311-90L00 | REC57311-93910 | 525 | 58100-90J00-019 | SOL3411-139-17 | 528 |
| 55125-87D00 | TEN01211 | 478 | 57311-91J00 | REC57311-98600 | 497 | 58100-90J00-019 | SOL3411-139-17 | 528 |
| 55125-87E01 | CM55125-95500 | 477 | 57311-91L00 | REC57311-96311 | 525 | 58100-90J10-019 | SOL3411-139-19 | 528 |
| 55125-87E01 | CM55125-95500A | 477 | 57311-91L00 | REC57311-96311 | 531 | 58100-90J10-019 | SOL3411-139-19 | 528 |
| 55125-90J01 | TEN01215 | 478-512-513-515-516 | 57311-93901 | REC57311-93901 | 525 | 58100-90J10-019 | SOL3411-138-19 | 528 |
| 55125-94400 | CM55125-94400 | 511 | 57311-93901 | REC57311-93901 | 531 | 58100-90J10-019 | SOL3411-139-19 | 528 |
| 55125-94502 | CM55125-94502 | 477 | 57311-93910 | REC57311-93910 | 501-525 | 58100-90J20-019 | SOL3411-139-21 | 528 |
| 55125-94502 | TEN01209 | 479 | 57311-94401 | REC57311-94402 | 525 | 58100-90J20-019 | SOL3411-138-21 | 528 |
| 55125-95301 | CM55125-95301A | 477 | 57311-94402 | REC57311-94402 | 525 | 58100-90J20-019 | SOL3411-139-21 | 528 |
| 55125-95301 | TEN01201 | 478 | 57311-94402 | REC57311-94402 | 531 | 58100-90J20-019 | SOL3411-138-21 | 528 |
| 55125-95500 | CM55125-95500 | 509 | 57311-96310 | REC57311-96311 | 525 | 58100-90J20-019 | SOL3411-138-21 | 528 |
| 55125-96310 | CM55125-96310 | 477-505-507 | 57311-96311 | REC57311-96311 | 525 | 58100-90J20-019 | SOL3411-138-21 | 528 |
| 55125-96310 | CM55125-96310A | 477 | 57311-96320 | REC57311-96311 | 525 | 58100-90J20-019 | SOL3411-138-21 | 528 |
| 55125-96310 | TEN01200 | 478 | 57311-96320 | REC57311-96320 | 505-507-531 | 58100-94302-019 | SOL4311-121-09 | 528 |
| 55125-98J00 | TEN01215 | 517 | 57311-96320 | REC57311-96320 | 505-507-531 | 58100-94313-019 | SOL4311-116-13 | 528 |
| 55128-93J00 | REC55128-93J10 | 521 | 57311-97J10 | REC57311-99J10 | 503 | 58100-94500-019 | SOL4411-135-15 | 528 |
| 55128-93J10 | REC55128-93J10 | 517-521 | 57311-98400 | REC57311-98400 | 531 | 58100-94500-019 | SOL4411-130-15 | 528 |
| | | | 57311-98600 | REC57311-98600 | 525 | 58100-94500-019 | SOL4411-135-15 | 528 |
| | | | 57311-98601 | REC57311-98600 | 525 | 58100-94512-019 | SOL4411-133-17 | 528 |
| | | | | | | 58100-94512-019 | SOL4411-128-17 | 528 |
| | | | | | | 58100-94512-019 | SOL4411-133-17 | 528 |

| R.O. / OEM | REF | | R.O. / OEM | REF | | R.O. / OEM | REF | |
|-----------------|--------------------|---------------------|-----------------|-----------------|--------------------------------|-----------------|----------------|-----|
| 58100-94522-019 | SOL4411-130-19 | 528 | 67200-93J06 | REC67200-93J51 | 464 | 99105-11002-010 | PRE3300C10 | 467 |
| 58100-94522-019 | SOL4413-125-19 | 528 | 67200-93J12 | REC67200-88L00 | 465 | 99105-11002-011 | PRE3300C11 | 467 |
| 58100-94522-019 | SOL4431-130-19 | 528 | 67200-93J13 | REC67200-88L00 | 465 | 99105-11002-012 | PRE3300C12 | 467 |
| 58100-94532-019 | SOL4411-130-21 | 528 | 67200-93J15 | REC67200-88L10 | 465 | 99105-11002-013 | PRE3300C13 | 467 |
| 58100-94532-019 | SOL4413-125-21 | 528 | 67200-93J50 | REC67200-93J51 | 464 | 99105-11002-014 | PRE3300C14 | 467 |
| 58100-94532-019 | SOL4431-130-21 | 528 | 67200-93J51 | REC67200-93J51 | 464 | 99105-11002-015 | PRE3300C15 | 467 |
| 58100-94554-019 | SOL4431-135-15 | 528 | 67200-94J20 | REC67200-94J20 | 464 | 99105-11002-016 | PRE3300C16 | 467 |
| 58100-94561-019 | SOL4431-130-19 | 528 | 67200-99E10-0EP | REC67200-99E56 | 464 | 99105-11002-017 | PRE3300C17 | 467 |
| 58100-94571-019 | SOL4431-130-21 | 528 | 67200-99E30-0EP | REC67200-99E56 | 464 | 99105-11002-018 | PRE3300C18 | 467 |
| 58100-94581-019 | SOL4431-133-17 | 528 | 67200-99E50 | REC67200-99E56 | 464 | 99105-11002-019 | PRE3300C19 | 467 |
| 58100-95212-019 | SOL4311-120-10 | 528 | 67200-99E51 | REC67200-99E56 | 464 | 99105-11002-020 | PRE3300C20 | 467 |
| 58100-95222-019 | SOL4311-118-11 | 528 | 67200-99E56 | REC67200-99E56 | 464 | 99105-11002-021 | PRE3300C21 | 467 |
| 58100-95353-019 | SOL4311-116-14 | 528 | 67256-95600 | PAF15-13010010W | 466 | 99105-11002-022 | PRE3300C22 | 467 |
| 58100-95363-019 | SOL4311-110-15 | 528 | 67275-95600 | PAF25-07000007W | 466 | 99105-11002-023 | PRE3300C23 | 467 |
| 58100-95393-019 | SOL4311-116-12 | 528 | 90171-18M04 | REC90171-18M04 | 518 | 99105-11002-024 | PRE3300C24 | 467 |
| 58100-95511-019 | SOL2431-135-15 | 528 | 92800-94610 | REC32800-94620 | 458 | 99105-11002-025 | PRE3300C25 | 467 |
| 58100-95521-019 | SOL2431-133-17 | 528 | 94701-00282 | NGKCR6HS | 181 | 99105-11002-026 | PRE3300C26 | 467 |
| 58100-95530-019 | SOL2431-130-19 | 528 | 94701-00282-00 | NGKCR6HS | 108 | 99105-11002-027 | PRE3300C27 | 467 |
| 58100-95D00-019 | SOL4211-100-14 | 528 | 94701-00300-00 | NGKCR5HSB | 108 | 99105-11002-028 | PRE3300C28 | 467 |
| 58100-96410-019 | SOL4211-110-09 | 528 | 94701-00309-00 | NGKBR9HS-10 | 108 | 99105-11002-029 | PRE3300C29 | 467 |
| 58100-96420-019 | SOL4211-105-11 | 528 | 94701-00375 | NGKDP6EA-9 | 65-66-67-68-197-207 | 99105-11002-030 | PRE3300C30 | 467 |
| 58100-96430-019 | SOL4211-103-12 | 528 | 94701-00375 | NGKDP7EA-9 | 185-191 | 99105-20003 | RACRK22628 | 447 |
| 58100-96440-019 | SOL4211-101-13 | 528 | 94701-00375-00 | NGKDP6EA-9 | 108 | 99105-20005 | LENS3227 | 446 |
| 58100-96460-019 | SOL4211-100-15 | 528 | 94701-00406-00 | NGKDP5EA-9 | 69-108 | 99105-20005 | RACS3227 | 446 |
| 58110-91JN0-019 | SOL4011-079-07S | 497-528 | 94702-00247-00 | NGKBR8HS-10 | 108 | 99105-20005-ASY | RAC490R-RAC-01 | 446 |
| 58200-87D01-019 | SOL4513-145-17 | 529 | 94702-00271 | NGKBR8HS-10 | 247-456 | | | |
| 58200-87D01-019 | SOL4551-148-18 | 529 | 94702-00309 | NGKBR9HS-10 | 245 | | | |
| 58200-87D02-019 | SOL4552-148-18 | 529 | 94702-00372 | NGKCR6HSB | 64-173-179 | | | |
| 58200-87D11-019 | SOL4513-143-19 | 529 | 94702-00372-00 | NGKCR6HS | 108 | | | |
| 58200-87D11-019 | SOL4551-148-20 | 529 | 94702-00391 | NGKLF5A-11 | 69-70-71-72-209-211 | | | |
| 58200-87D12-019 | SOL4552-148-20 | 529 | 94702-00391-00 | NGKLF5A-11 | 108 | | | |
| 58200-87D21-019 | SOL4513-140-21 | 529 | 94702-00400 | NGKLF6A-11 | 70-72-73-213-214 | | | |
| 58200-87D21-019 | SOL4551-143-22 | 529 | 94702-00400-00 | NGKLF6A-11 | 108 | | | |
| 58200-87D22-019 | SOL4552-143-22 | 529 | 94702-00409 | NGKCR9EB | 108 | | | |
| 58200-87D61-019 | SOL4511-150-15 | 529 | 94702-00418 | NGKDP6EB-9 | 65-66-67-68-69-187-195-201-203 | | | |
| 58200-87D61-019 | SOL4513-148-15 | 529 | 94702-00418-00 | NGKDP6EB-9 | 108 | | | |
| 58200-87D61-019 | SOL4551-148-16 | 529 | 990A0-01E81-01Q | REC80W90U3 | 450 | | | |
| 58200-87D62-019 | SOL4552-148-16 | 529 | 990A0-01E81-05Q | REC80W90U6 | 450 | | | |
| 59178-97J00 | REC59178-97J00 | 439-440-499-503-521 | 990C0-01E30-GLN | REC10W40U3 | 450 | | | |
| 63610-89E01-000 | REC63610-89E01 | 467 | 990C0-01E30-GLN | REC10W40U6 | 450 | | | |
| 63610-91J00 | REC63610-91J20 | 467 | 990C0-10W40-1GL | REC10W40U3 | 450 | | | |
| 63610-91J01 | REC63610-91J20 | 467 | 990C0-10W40-1GL | REC10W40U6 | 450 | | | |
| 63610-91J03 | REC63610-91J20 | 467 | 990C0-10W40-GAL | REC10W40U3 | 450 | | | |
| 63610-91J04 | REC63610-91J20 | 467 | 990C0-10W40-GAL | REC10W40U6 | 450 | | | |
| 63610-91J20 | REC63610-91J20 | 467 | 990C0-10W40-GLN | REC10W40U3 | 450 | | | |
| 63610-93501-000 | REC63610-93501 | 467 | 990C0-10W40-GLN | REC10W40U6 | 450 | | | |
| 63610-94402-000 | REC63610-94402 | 467 | 99105-00100-16P | SOL4431-135-15 | 528 | | | |
| 63610-96302-000 | REC63610-96302 | 467 | 99105-00100-18P | SOL4431-133-17 | 528 | | | |
| 63610-96321-000 | REC63610-96321-000 | 467 | 99105-00100-20P | SOL4431-130-19 | 528 | | | |
| 65720-94403 | GS31039 | 444 | 99105-00100-22P | SOL4431-130-21 | 528 | | | |
| 65720-94411 | GS31038 | 444 | 99105-00200-16P | SOL4511-150-15 | 529 | | | |
| 65720-98500 | REC65720-98520 | 443 | 99105-00200-16P | SOL4551-148-16 | 529 | | | |
| 65720-98501 | REC65720-98520 | 443 | 99105-00200-18P | SOL4511-148-17 | 529 | | | |
| 65720-98502 | REC65720-98520 | 443 | 99105-00200-18P | SOL4511-155-17 | 529 | | | |
| 65720-98520 | REC65720-98520 | 443 | 99105-00200-18P | SOL4551-148-18 | 529 | | | |
| 65720-98521 | REC65720-98520 | 443 | 99105-00200-20P | SOL4511-145-19 | 529 | | | |
| 65720-985L1 | REC65720-98520 | 443 | 99105-00200-20P | SOL4511-153-19 | 529 | | | |
| 65720-986A0 | REC65720-986L0 | 443 | 99105-00200-20P | SOL4551-148-20 | 529 | | | |
| 65720-986B0 | REC65720-986L0 | 443 | 99105-00200-22P | SOL4511-143-21 | 529 | | | |
| 65720-986L0 | REC65720-986L0 | 443 | 99105-00200-22P | SOL4511-153-21 | 529 | | | |
| 65740-95D00 | GS31070 | 444 | 99105-00200-24P | SOL4551-142-23 | 529 | | | |
| 65740-99100 | GS31037 | 444 | 99105-00200-24P | SOL4551-140-24 | 529 | | | |
| 65750-89J11 | GS31089 | 444 | 99105-0020L-16P | SOL4512-150-15 | 529 | | | |
| 65750-94401 | REC65750-94404 | 443 | 99105-0020L-16P | SOL4552-148-16 | 529 | | | |
| 65750-94402 | REC65750-94404 | 443 | 99105-0020L-18P | SOL4512-148-17 | 529 | | | |
| 65750-94403 | REC65750-94404 | 443 | 99105-0020L-18P | SOL4552-148-18 | 529 | | | |
| 65750-94404 | REC65750-94404 | 443 | 99105-0020L-20P | SOL4512-145-19 | 529 | | | |
| 65750-95500 | GS31071 | 444 | 99105-0020L-20P | SOL4552-148-20 | 529 | | | |
| 65750-95500 | GS31072 | 444 | 99105-0020L-22P | SOL4512-143-21 | 529 | | | |
| 65750-98505 | GS31035 | 444 | 99105-0020L-22P | SOL4552-143-22 | 529 | | | |
| 65750-98505 | GS31036 | 444 | 99105-0020L-24P | SOL4512-142-23 | 529 | | | |
| 65770-93J12 | GS31095 | 442 | 99105-0020L-24P | SOL4552-140-24 | 529 | | | |
| 65770-95504 | GS31090 | 442 | 99105-00700-18P | SOL3451-139-17 | 528 | | | |
| 65900-98J00 | REC90794-46866 | 446 | 99105-00700-20P | SOL3451-139-19 | 528 | | | |
| 65910-98J00 | REC90794-46868 | 446 | 99105-00700-22P | SOL3451-139-21 | 528 | | | |
| 67200-88L00 | REC67200-88L00 | 465 | 99105-00700-24P | SOL3451-139-23 | 528 | | | |
| 67200-88L10 | REC67200-88L10 | 465 | 99105-0070L-18P | SOL3452-139-17 | 528 | | | |
| 67200-91J00 | REC67200-94J20 | 464 | 99105-0070L-20P | SOL3452-139-19 | 528 | | | |
| 67200-91J01 | REC67200-94J20 | 464 | 99105-0070L-22P | SOL3452-139-21 | 528 | | | |
| 67200-91J04 | REC67200-94J20 | 464 | 99105-11002-008 | PRE3300C08 | 467 | | | |
| 67200-93J00 | REC67200-93J51 | 464 | 99105-11002-009 | PRE3300C09 | 467 | | | |
| 67200-93J01 | REC67200-93J51 | 464 | | | | | | |
| 67200-93J02 | REC67200-93J51 | 464 | | | | | | |
| 67200-93J03 | REC67200-93J51 | 464 | | | | | | |
| 67200-93J04 | REC67200-93J51 | 464 | | | | | | |

HONDA

ES

| | | | | | |
|---|-----|------------------------------------|-----|---|-----|
| GUÍA MANTENIMIENTO COLAS Y Y KITS | 545 | DESCONECTORES DE SEGURIDAD | 561 | JUNTAS BASE DE MOTOR | 574 |
| SISTEMA DE ALIMENTACIÓN Y FILTRACIÓN | 547 | LLAVES DE ARRANQUE | 564 | JUNTAS BOMBA DE ACEITE | 574 |
| ACEITE | 553 | MOTORES DE ARRANQUE | 560 | JUNTAS CULATA | 574 |
| BOMBA DE COMBUSTIBLE EN LÍNEA | 547 | SENSORES | 557 | JUNTAS SILENCIOSO | 574 |
| ABRAZADERA PARA MANGUERA | 548 | SENSOR DETONACIÓN | 558 | JUNTAS TAPÓN DRENAJE | 575 |
| ADAPTADOR LÍNEA DE COMBUSTIBLE | 548 | SENSOR MAP | 557 | KIT JUNTAS DE CULATA | 575 |
| BOMBA DE COMBUSTIBLE | 547 | SENSOR MAT, TEMPERATURA DEL AIRE | 558 | SISTEMA DE ESCAPE Y ADMISIÓN | 576 |
| LÍNEA DE COMBUSTIBLE | 547 | SENSOR POSICIÓN CIGÜEÑAL | 557 | SISTEMA DE ADMISIÓN | 576 |
| MANGUERA DE COMBUSTIBLE | 547 | SENSOR POSICIÓN LEVAS | 557 | JUNTAS | 576 |
| MUELLE TUBO COMBUSTIBLE | 548 | SENSOR PRESIÓN DE ACEITE | 558 | RETÉN DE VÁLVULA | 576 |
| BOMBA DE COMBUSTIBLE ELÉCTRICA | 555 | SENSOR OXÍGENO | 558 | SISTEMA DE ESCAPE | 576 |
| CARBURADOR | 555 | TRIM, TILT & POWER TRIM | 562 | RETÉN DE VÁLVULA | 576 |
| AGUJA DE CARBURADOR | 555 | EXTRACTOR TAPONES DE TRIM | 563 | UNIDADES DE TRANSMISIÓN | 577 |
| GUÍA CARBURADORES | 556 | INSTALACIÓN ELÉCTRICA | 562 | DESPIECE COLAS | 577 |
| KITS CARBURADORES | 556 | POWER TRIM COMPLETO | 563 | BF75AT • BF90AT | 577 |
| COMPONENTES TANQUE Y CONECTORES | 548 | TRIM COMPLETO | 562 | COMPONENTES DE COLA | 578 |
| CONECTOR DE DEPÓSITO | 548 | SISTEMA DE GOBIERNO | 564 | ARANDELA DE CIERRE | 579 |
| PASAMAMPAROS | 549 | CABLES DE CONTROL | 565 | EJE HÉLICE | 579 |
| FILTRO DE ACEITE | 554 | LLAVES DE ARANQUE | 565 | JUNTA EJE SELECTOR | 578 |
| GUÍA FILTROS DE ACEITE | 554 | MANDOS DE CONTROL | 564 | KITS JUNTAS Y RETENES | 578 |
| FILTRO DE COMBUSTIBLE Y ELEMENTOS | 549 | SISTEMA DE REFRIGERACIÓN | 566 | RETENES EJE DE CAMBIO | 578 |
| BRACKET | 549 | ÁNODOS | 571 | RETENES EJE DE HELICE | 578 |
| FILTRO COMBUSTIBLE MONTAJE EN LÍNEA | 552 | ÁNODO CANADA METAL | 571 | RETENES EJE DE TRANSMISIÓN | 578 |
| FILTRO COMBUSTIBLE SEPARADOR AGUA | 549 | ÁNODO TECNÓSEAL | 573 | RODAMIENTO DIÁBOLO | 579 |
| FILTRO DECANTADOR DE COMBUSTIBLE COMPLETO CON VASO TRANSPARENTE | 550 | BOMBA DE AGUA | 569 | RODAMIENTO PIÑÓN AVANTE | 579 |
| FILTRO DECANTADOR DE GASOLINA | 550 | JUNTAS BOMBA | 569 | TUERCA DE DIÁBOLO | 579 |
| LLAVES PARA FILTRO | 552 | KITS DE REPARACIÓN BOMBA DE AGUA | 570 | SISTEMA DE PROPULSIÓN | 580 |
| RACOR DE LATÓN | 552 | RETÉN CUERPO DE BOMBA | 570 | HÉLICES ALUMINIO E INOXIDABLE DE 3 Y 4 PALAS | 580 |
| INYECTORES | 555 | IMPULSORES | 567 | GUÍA HÉLICES CON NÚCLEO INTEGRADO | 581 |
| SISTEMA ELÉCTRICO | 557 | CHAVETA | 569 | HÉLICES PARA NÚCLEO INTERCAMBIABLE | 582 |
| ALTERNADORES | 561 | GUÍA IMPULSORES | 568 | NÚCLEO INTERCAMBIABLE | 582 |
| CORREAS DE ALTERNADOR | 562 | TERMOSTATO | 566 | REF --> RO | 583 |
| BOBINAS | 559 | PARTES DEL MOTOR | 574 | RO --> REF | 585 |
| BUJÍAS | 559 | GUÍA CORREAS DE DISTRIBUCIÓN | 575 | | |
| | | JUNTAS DE MOTOR | 574 | | |

EN

| | | | | | |
|--|-----|------------------------------------|-----|--|-----|
| DRIVES MAINTENANCE GUIDE & KITS | 545 | SENSORS | 557 | ENGINE PARTS | 574 |
| FUEL & FILTRATION SYSTEM | 547 | SENSOR, CAMSHAFT | 557 | ENGINE GASKETS | 574 |
| CARBURETOR | 555 | SENSOR, CRANKSHAFT | 557 | GASKET, CYLINDER | 574 |
| CARBURETOR KITS | 556 | SENSOR, KNOCK | 558 | GASKET, CYLINDER HEAD | 574 |
| CARBURETOR NEEDLE VALVE | 555 | SENSOR, MAP | 557 | GASKET KIT | 575 |
| GUIDE CARBURETORS | 556 | SENSOR MAT, AIR TEMPERATURE | 558 | GASKET, MUFFLER | 574 |
| ELECTRIC FUEL PUMP | 555 | SENSOR, O2 | 558 | GASKET, OIL PUMP | 574 |
| FUEL FILTERS AND ELEMENTS | 549 | SENSOR, PRESSURE OIL | 558 | O-RING, DRAIN CAP | 575 |
| BRACKET | 549 | SPARK | 559 | TIMING BELT | 574 |
| COMPLETE FUEL FILTER | 550 | STARTERS | 560 | EXHAUST & INTAKE SYSTEM | 576 |
| COMPLETE FUEL FILTER WITH TRANSPARENT BOWL | 550 | TRIM, TILT & POWER TRIM | 562 | EXHAUST SYSTEM | 576 |
| FILTER KEY | 552 | COMPLETE POWER TRIM ASSEMBLY | 563 | VALVE SEALS | 576 |
| IN-LINE FUEL FILTER | 552 | COMPLETE TRIM ASSEMBLY | 562 | INTAKE SYSTEM | 576 |
| RACORS | 552 | TRIM PLUGS EXTRACTOR | 563 | GASKETS & VALVE SEALS | 576 |
| WATER SEPARATING FUEL FILTER | 549 | WIRING HARNESS | 561 | UNIT DRIVES & COMPONENTS | 577 |
| FUEL PUMP IN LINE | 547 | STEERING SYSTEM | 564 | DRIVE COMPONENTS | 577 |
| CLAMP SMALL | 548 | ENGINE CONTROLS | 564 | CARRIER BEARING | 579 |
| COUPLER | 548 | CONSOLE CONTROL | 564 | FORWARD GEAR BEARING | 579 |
| FUEL HOSE | 547 | CONTROL CABLES | 565 | NUT, GEARCASE END | 579 |
| FUEL LINE ASSEMBLY | 547 | SIDE CONTROL | 564 | O-RING DRIVE SHAFT | 578 |
| SPRING, FUEL PIPE | 548 | IGNITION STARTER SWITCH | 565 | PROPELLER SHAFT | 579 |
| FUEL TANK COMPONENTS & CONNECTORS | 548 | COOLING SYSTEM | 566 | SEAL DRIVE SHAFT | 578 |
| TANK CONNECTOR | 548 | ANODES | 571 | SEAL KITS | 578 |
| THRU HULL | 549 | ANODES CANADA METAL | 571 | SEAL PROPELLER SHAFT | 578 |
| INJEKTOR | 555 | ANODES TECNÓSEAL | 573 | TAB WASHER | 579 |
| OIL | 553 | IMPELLERS | 567 | PROPULSION SYSTEM | 580 |
| OIL FILTER | 554 | IMPELLERS GUIDE | 568 | 3 & 4 BLADE ALUMINIUM & SS PROPELLERS | 580 |
| OIL FILTER GUIDE | 554 | KEY | 569 | INTERCHANGEABLE HUB | 582 |
| ELECTRIC SYSTEM | 557 | THERMOSTAT | 566 | PROPELLERS APPLICATION WITH RUBBER HUB | 581 |
| ALTERNATOR | 561 | WATER PUMP | 569 | PROPELLERS FOR INTERCHANGEABLE HUB | 582 |
| ALTERNATOR BELT | 562 | SEAL WATER PUMP | 570 | REF --> OEM | 583 |
| COILS | 559 | SERVICE KIT | 570 | OEM --> REF | 585 |
| CUT OFF SWITCHES | 561 | WATER PUMP GASKET | 569 | | |

| | | | | | |
|---|-----|----------------------------------|-----|---|-----|
| GUIDA MANUTENZIONE E KIT | 545 | MOTORINI AVVIAMENTO | 560 | GUARNIZIONE TAPPO DRENAGIO | 575 |
| SISTEMA DI ALIMENTAZIONE E FILTRAZIONE | 547 | SENSORE | 557 | GUARNIZIONE OLIO | 574 |
| CARBURATORE | 555 | SENSORE ALBERO A CAME | 557 | GUARNIZIONE SILENZIATORE | 574 |
| KIT CARBURATORI | 556 | SENSORE ALBERO MOTORE | 557 | GUARNIZIONE TESTATA | 574 |
| SPILLO CONICO CARBURATORE | 555 | SENSORE ANTIDETONAZIONE | 558 | KIT GUARNIZIONE TESTATA | 575 |
| COMPONENTI SERBATOIO E CONETTORI | 548 | SENSORE MAP | 557 | GUIDA CINGHIE DISTRIBUZIONE | 575 |
| ATTACCO SERBATOIO | 548 | SENSORE MAT. TEMPERATURA ARIA | 558 | SISTEMA DI SCARICO E ASPIRAZIONE | 576 |
| PASSASCAFO | 549 | SENSORE OSSIGENO | 558 | SISTEMA ASPIRAZIONE | 576 |
| FILTRI BENZINA E RACCORDI | 549 | SENSORE PRESSIONE DELL'OLIO | 558 | GUARNIZIONE | 576 |
| CHIAVE DA FILTRO | 552 | TRIM, TILT & POWER TRIM | 562 | TENUTE | 576 |
| FILTRO BENZINA ALTA PRESSIONE | 552 | ESTRATTORE PER TAPPI DI TRIM | 563 | SISTEMA SCARICO | 576 |
| FILTRO BENZINA PER MONTARE IN LINEA | 552 | INSTALLAZIONE ELETTRICA | 562 | TENUTE | 576 |
| FILTRO DECATATORE BENZINA | 550 | MOTORINO POWER TRIM COMPLETO | 563 | | |
| FILTRO DI DECATAZIONE BENZINA COMPLETO CON VASCETTA TRASPARENTE | 550 | MOTORINO TRIM COMPLETO | 562 | UNITÀ DI TRASMISSIONE | 577 |
| FILTRO SEPARATORE ACQUA-BENZINA | 549 | SISTEMA DI GUIDA | 564 | COMPONENTI PIEDI | 578 |
| RACCORDI | 552 | CAVI COMANDI | 565 | ASSE ELICA | 579 |
| SUPPORTO | 549 | COMANDI DI CONTROLLO | 564 | CUSCINETTO DIAVOLO | 579 |
| FILTRO OLIO | 554 | CHIAVI DI ACCENSIONE | 565 | CUSCINETTO PIGNONE AVANTI | 579 |
| GUIDA FILTRO OLIO | 554 | SISTEMA DI RAFFREDDAMENTO | 566 | DADO DIAVOLO | 579 |
| INIETTORE | 555 | ANODI | 571 | KIT GUARNIZIONE E TENUTE | 578 |
| OLIO | 553 | ANODI CANADA METAL | 571 | TENUTE ASSE DI CAMBIO | 578 |
| POMPA BENZINA ELETTRICA | 555 | ANODI TECNOSEAL | 573 | TENUTE ASSE DI ELICA | 578 |
| POMPA BENZINA IN LINEA | 547 | GIRANTE | 567 | TENUTE ASSE DI TRASMISSIONE | 578 |
| ADATTATORE | 548 | CIAVETTA | 569 | RONDELLA CHIUSURA | 579 |
| FASCETTE | 548 | GUIDA GIRANTE | 568 | PARTI PIEDI | 577 |
| MOLLA TUBO COMBUSTIBILE | 548 | POMPA ACQUA | 569 | BF75AT • BF90AT | 577 |
| TUBO BENZINA | 547 | GUARNIZIONE POMPA | 569 | SISTEMA DI PROPULSIONE | 580 |
| TUBO CARBURANTE | 547 | KIT RICAMBI POMPA ACQUA | 570 | HELICHE ALLUMINIO E INOX DA 2 E 4 PALE | 580 |
| SISTEMA ELETTRICO | 557 | TENUTE CORPO POMPA | 570 | ELICHE PER MOZZO INTERCAMBIABILE | 582 |
| ALTERNATORE | 561 | TERMOSTATO | 566 | GUIDA ELICHE CON MOZZO | 581 |
| CURROIA ALTERNATORE | 562 | PARTI MOTORE | 574 | MOZZO INTERCAMBIABILE | 582 |
| BOBINE | 559 | GUARNIZIONI MOTORE | 574 | REF --> RO | 583 |
| CANDELE | 559 | GUARNIZIONE BASE MOTORE | 574 | RO --> REF | 585 |
| CHIAVETTA DI SICUREZZA | 561 | | | | |
| INTERRUTTORE DI STOP | 561 | | | | |
| KIT | 561 | | | | |

| | | | | | |
|--|-----|-------------------------------------|-----|---|-----|
| GUIDE KITS DE MAINTENANCE | 545 | CAPTEUR DE CLIQUETIS | 558 | JOINTS DE POMPE À HUILE | 574 |
| SYSTÈME D'ALIMENTATION ET DE FILTRATION | 547 | CAPTEUR DE POSITION D'ARBRE À CAMES | 557 | JOINTS DE SILENCIEUX | 574 |
| CARBURATEUR | 555 | CAPTEUR DE POSITION DU VILEBREQUIN | 557 | JOINTS DE VIDANGE | 575 |
| GUIDE DES CARBURATEURS | 556 | CAPTEUR MAP | 557 | KIT JOINTS DE MOTEUR | 575 |
| KIT CARBURATEUR | 556 | CAPTEUR MAT DE TEMPERATURE D'AIR | 558 | SYSTÈME D'ÉCHAPPEMENT ET SYSTÈME D'ADMISSION | 576 |
| POINTEAU CARBURATEUR | 555 | CAPTEUR PRESSION D'HUILE | 558 | SYSTÈME D'ADMISSION | 576 |
| COMPONENTS ET CONNECTEURS DU RÉSERVOIR | 548 | COUPE CIRCUIT DE SECURITE | 561 | JOINTS DE SOUPAPE | 576 |
| PASSE-CLOISON | 549 | KITS | 561 | SYSTÈME D'ÉCHAPPEMENT | 576 |
| RACCORDS DE RESERVOIR | 548 | DEMARREUR | 560 | JOINTS DE SOUPAPE | 576 |
| FILTRE À ESSENCE ET CARTOUCHE DE RECHANGE | 549 | TRIM, TILT & POWER TRIM | 562 | EMBASSES ET PIÈCES | 577 |
| CLÉ À FILTRE | 552 | INSTALLATION ELECTRIQUE | 562 | EMBASSES | 577 |
| FILTRE À ESSENCE EN LIGNE | 552 | KIT EXTRACTEUR | 563 | BF75AT • BF90AT | 577 |
| FILTRE DÉCANTEUR ESSENCE | 550 | MOTEUR DE TRIM | 562 | PIÈCES | 578 |
| FILTRE DÉCANTEUR ESSENCE AVEC BOL TRANSPARENT | 550 | POWER TRIM COMPLET | 563 | ARBRE D'HELICE | 579 |
| FILTRE SÉPARATEUR EAU-ESSENCE | 549 | SYSTÈME DE COMMANDE | 564 | ÉCROU DE DIABOLO | 579 |
| RACCORDS | 552 | BOITIER DE COMMANDE | 564 | JOINTS D'ARBRE DE SELECTEUR | 578 |
| TÊTE DE FILTRE À ESSENCE | 549 | CÂBLES DE COMMANDE | 565 | JOINTS SPI ARBRE DE CHANGEMENT | 578 |
| FILTRE À HUILE | 554 | CONTACTEUR À CLÉ | 565 | JOINTS SPI ARBRE DE TRASMISSION | 578 |
| GUIDE DES FILTRES À HUILE | 554 | SYSTÈME DE REFROIDISSEMENT | 566 | KITS JOINTS D'EMBASSES | 578 |
| HUILES | 553 | ANODES | 571 | RONDELE FREIN | 579 |
| INJECTEURS | 555 | ANODE CANADA METAL | 571 | ROULEMENT DE DIABOLO | 579 |
| POIRE À CARBURANT | 547 | ANODE TECNOSEAL | 573 | ROULEMENT DE PIGNON AVANT | 579 |
| COLLIER | 548 | TURBINES | 567 | SYSTEME DE PROPULSION | 580 |
| RACCORD COUPLEUR | 548 | CLAVETTE | 569 | HELICE ALUMINIUM ET INOX 3 ET 4 PALES | 580 |
| RESSORT, TUYAU DE CARBURANT | 548 | GUIDE DE TURBINES | 568 | GUIDE DES HÉLICES ET MOYEUX | 581 |
| TUYAU CARBURANT | 547 | POMPE D'EAU | 569 | HELICES AVEC MOYEU INTERCHANGEABLE | 582 |
| POMPE À ESSENCE ÉLECTRIQUE | 555 | JOINTS SPI DE POMPE À EAU | 570 | MOYEU INTERCHANGEABLE | 582 |
| SYSTÈME ÉLECTRIQUE | 557 | JOINTS POMPE | 569 | REF --> RO | 583 |
| ALTERNATEUR | 561 | KIT REPARATION DE POMPE À EAU | 570 | RO --> REF | 585 |
| COURROIE D'ALTERNATEUR | 562 | TERMOSTAT | 566 | | |
| BOBINES | 559 | PIÈCES MOTEUR | 574 | | |
| BOUGIES | 559 | COURROIES DE DISTRIBUTION | 575 | | |
| CAPTEURS | 557 | JOINTS DE MOTEUR | 574 | | |
| CAPTEUR À OXYGENE | 558 | JOINTS DE CULASSE | 574 | | |
| | | JOINTS DE TÊTE MOTRICE | 574 | | |



GUÍA KITS MANTENIMIENTO

MAINTENANCE GUIDE & KITS

GUIDA MANUTENZIONE E KIT

GUIDE KITS MAINTENANCE

| | KIT | REF | | | | | | |
|----------------------------------|--------------------|-------------------|---------------------|--------------------|-----------------------|---------------------------|------------------|---|
| BF4 BF4.5 BF5 | | REC06211-ZV1-505 | REC06192-ZV1-C00 | KIT TURBINA | IMPELLER KIT | KIT GIRANTE | KIT TURBINE | 1 |
| | | NGKBPR5ES | BUJÍA | SPARK PLUG | CANDELE | BOUGIE | 1 | |
| | | REC19300-881-761 | TERMOSTATO | THERMOSTAT | TERMOSTATO | TERMOSTAT | 1 | |
| | | REC16910-GB2-005 | FILTRO COMBUSTIBLE | FUEL FILTER | FILTRO COMBUSTIBILE | FILTRE À ESSENCE | 1 | |
| | | TEN01402 | ÁNODO | ANODE | ANODO | ANODE | 1 | |
| | | PAGB/T91-2.5X30 | PIN | PIN | PIN | GOUPILLE | 1 | |
| BF8 BF9.9D BF10 | | REC06211-ZW9-505 | REC19210-ZW9-013 | TURBINA | IMPELLER | GIRANTE | TURBINE | 1 |
| | | NGKCR5EH-9 | BUJÍA | SPARK PLUG | CANDELE | BOUGIE | 2 | |
| | | PAF15-07000031 | TERMOSTATO | THERMOSTAT | TERMOSTATO | TERMOSTAT | 1 | |
| | | REC16910-ZV4-015 | FILTRO COMBUSTIBLE | FUEL FILTER | FILTRO COMBUSTIBILE | FILTRE À ESSENCE | 1 | |
| | | REC35-822626Q03 | FILTRO DE ACEITE | OIL FILTER | FILTRO OLIO | FILTRE A HUILE | 1 | |
| | | CM41106-ZW9-09000 | ÁNODO | ANODE | ANODO | ANODE | 2 | |
| PAGB/T91-2.5X30 | PIN | PIN | PIN | GOUPILLE | 1 | | | |
| BF9.9A BF15A | | REC06211-ZV4-505 | REC06192-ZV4-000 | KIT TURBINA | IMPELLER KIT | KIT GIRANTE | KIT TURBINE | 1 |
| | | REC19300-881-761 | TERMOSTATO | THERMOSTAT | TERMOSTATO | TERMOSTAT | 1 | |
| | | NGKDR6HS | BUJÍA | SPARK PLUG | CANDELE | BOUGIE | 2 | |
| | | REC16910-ZV4-015 | FILTRO COMBUSTIBLE | FUEL FILTER | FILTRO COMBUSTIBILE | FILTRE À ESSENCE | 1 | |
| | | TEN01402 | ÁNODO | ANODE | ANODO | ANODE | 1 | |
| | | PAGB/T91-2.5X30 | PIN | PIN | PIN | GOUPILLE | 1 | |
| BF15D BF20D | | REC06211-ZY0-505 | REC06192-ZW9-A30 | KIT TURBINA | IMPELLER KIT | KIT GIRANTE | KIT TURBINE | 1 |
| | | PAGB/T91-2.5X30 | PIN | PIN | PIN | GOUPILLE | 1 | |
| | | PAF15-07000031 | TERMOSTATO | THERMOSTAT | TERMOSTATO | TERMOSTAT | 1 | |
| | | REC35-822626Q03 | FILTRO DE ACEITE | OIL FILTER | FILTRO OLIO | FILTRE A HUILE | 1 | |
| | | NGKCR5EH-9 | BUJÍA | SPARK PLUG | CANDELE | BOUGIE | 2 | |
| | | CM41106-ZW9-09000 | ÁNODO | ANODE | ANODO | ANODE | 2 | |
| REC16910-ZV4-015 | FILTRO COMBUSTIBLE | FUEL FILTER | FILTRO COMBUSTIBILE | FILTRE À ESSENCE | 1 | | | |
| BF25D BF30D | | REC06211-ZV7-505 | REC16910-ZV4-015 | FILTRO COMBUSTIBLE | FUEL FILTER | FILTRO COMBUSTIBILE | FILTRE À ESSENCE | 1 |
| | | REC35-822626Q03 | FILTRO DE ACEITE | OIL FILTER | FILTRO OLIO | FILTRE A HUILE | 1 | |
| | | PAGB/T91-2.5X30 | PIN | PIN | PIN | GOUPILLE | 1 | |
| | | PAF15-07000031 | TERMOSTATO | THERMOSTAT | TERMOSTATO | TERMOSTAT | 1 | |
| | | REC06192-ZV7-000 | KIT TURBINA | IMPELLER KIT | KIT GIRANTE | KIT TURBINE | 1 | |
| | | TEN01408/1 | ÁNODO | ANODE | ANODO | ANODE | 1 | |
| | | CM41107-ZV500A | ÁNODO | ANODE | ANODO | ANODE | 1 | |
| | | REC12-191833 | JUNTA DRENAJE COLA | DRAIN PLUG GASKET | GUARNIZIONE DRENAGGIO | JOINT DE VIDANGE D'EMBASE | 2 | |
| | | PAF15-04000003 | JUNTA DRENAJE COLA | DRAIN PLUG GASKET | GUARNIZIONE DRENAGGIO | JOINT DE VIDANGE D'EMBASE | 1 | |
| NGKDR7EA | BUJÍA | SPARK PLUG | CANDELE | BOUGIE | 3 | | | |
| BF35A BF40A BF45A BF50A | | REC06211-ZV5-505 | REC06192-ZV5-003 | KIT TURBINA | IMPELLER KIT | KIT GIRANTE | KIT TURBINE | 1 |
| | | PAGB/T91-2.5X30 | PIN | PIN | PIN | GOUPILLE | 1 | |
| | | NGKDR7EA | BUJÍA | SPARK PLUG | CANDELE | BOUGIE | 3 | |
| | | REC35-822626Q03 | FILTRO DE ACEITE | OIL FILTER | FILTRO OLIO | FILTRE A HUILE | 1 | |
| | | PAF15-07000031 | TERMOSTATO | THERMOSTAT | TERMOSTATO | TERMOSTAT | 1 | |
| | | CMHBF4050KITA | KIT ANODO | ANODE KIT | KIT ANODO | KIT ANODE | 1 | |
| | | REC12-191833 | JUNTA DRENAJE COLA | DRAIN PLUG GASKET | GUARNIZIONE DRENAGGIO | JOINT DE VIDANGE D'EMBASE | 2 | |
| | | PAF15-04000003 | JUNTA DRENAJE COLA | DRAIN PLUG GASKET | GUARNIZIONE DRENAGGIO | JOINT DE VIDANGE D'EMBASE | 1 | |
| REC16900-SA5-004 | FILTRO COMBUSTIBLE | FUEL FILTER | FILTRO COMBUSTIBILE | FILTRE À ESSENCE | 1 | | | |

| | KIT | REF | | | | | | | | |
|-----------------------------|-----|------------------|------------------|--------------------|-------------------|-----------------------|---------------------------|-------------|----------------|---|
| BF40D BF50D | | REC06211-ZZ5-505 | REC06192-ZV5-003 | KIT TURBINA | IMPELLER KIT | KIT GIRANTE | KIT TURBINE | 1 | | |
| | | PAGB/T91-2.5X30 | | PIN | PIN | PIN | GOUPILLE | 1 | | |
| | | NGKDR7EB | | BUJÍA | SPARK PLUG | CANDELE | BOUGIE | 3 | | |
| | | REC35-822626Q03 | | FILTRO DE ACEITE | OIL FILTER | FILTRO OLIO | FILTRE A HUILE | 1 | | |
| | | PAF15-07000031 | | TERMOSTATO | THERMOSTAT | TERMOSTATO | TERMOSTAT | 1 | | |
| | | CMHBF4050KITA | | KIT ANODO | ANODE KIT | KIT ANODO | KIT ANODE | 1 | | |
| | | REC12-191833 | | JUNTA DRENAJE COLA | DRAIN PLUG GASKET | GUARNIZIONE DRENAGGIO | JOINT DE VIDANGE D'EMBASE | 2 | | |
| | | PAF15-04000003 | | JUNTA DRENAJE COLA | DRAIN PLUG GASKET | GUARNIZIONE DRENAGGIO | JOINT DE VIDANGE D'EMBASE | 1 | | |
| | | REC16911-ZZ5-003 | | FILTRO COMBUSTIBLE | FUEL FILTER | FILTRO COMBUSTIBILE | FILTRE À ESSENCE | 1 | | |
| | | BF60A | | REC06211-ZZ3-506 | REC19210-ZV5-003 | TURBINA | IMPELLER | GIRANTE | TURBINE | 1 |
| REC90752-ZV5-003 | | | | CHAVETA TURBINA | IMPELLER KEY | CHIAVE GIRANTE | CLAVETTE TURBINE | 1 | | |
| NGKLMAR6C-9 | | | | BUJÍA | SPARK PLUG | CANDELE | BOUGIE | 3 | | |
| PAGB/T91-2.5X30 | | | | PIN | PIN | PIN | GOUPILLE | 1 | | |
| PAF15-07000031 | | | | TERMOSTATO | THERMOSTAT | TERMOSTATO | TERMOSTAT | 1 | | |
| CMHBF35225KITA | | | | KIT ANODO | ANODE KIT | KIT ANODO | KIT ANODE | 1 | | |
| REC12-191833 | | | | JUNTA DRENAJE COLA | DRAIN PLUG GASKET | GUARNIZIONE DRENAGGIO | JOINT DE VIDANGE D'EMBASE | 2 | | |
| PAF15-04000003 | | | | JUNTA DRENAJE COLA | DRAIN PLUG GASKET | GUARNIZIONE DRENAGGIO | JOINT DE VIDANGE D'EMBASE | 1 | | |
| REC35-822626Q03 | | | | FILTRO DE ACEITE | OIL FILTER | FILTRO OLIO | FILTRE A HUILE | 1 | | |
| REC16911-ZZ5-003 | | | | FILTRO COMBUSTIBLE | FUEL FILTER | FILTRO COMBUSTIBILE | FILTRE À ESSENCE | 1 | | |
| BF75A BF90A (1200002) | | REC06211-ZW0-505 | REC06192-ZV1-305 | KIT TURBINA | IMPELLER KIT | KIT GIRANTE | KIT TURBINE | 1 | | |
| | | REC19300-ZV5-043 | | TERMOSTATO | THERMOSTAT | TERMOSTATO | TERMOSTAT | 1 | | |
| | | REC15400-RBA-F01 | | FILTRO DE ACEITE | OIL FILTER | FILTRO OLIO | FILTRE A HUILE | 1 | | |
| | | NGKDR7EA | | BUJÍA | SPARK PLUG | CANDELE | BOUGIE | 4 | | |
| | | PAGB/T91-2.5X30 | | PIN | PIN | PIN | GOUPILLE | 1 | | |
| | | REC12-191833 | | JUNTA DRENAJE COLA | DRAIN PLUG GASKET | GUARNIZIONE DRENAGGIO | JOINT DE VIDANGE D'EMBASE | 2 | | |
| | | PAF15-04000003 | | JUNTA DRENAJE COLA | DRAIN PLUG GASKET | GUARNIZIONE DRENAGGIO | JOINT DE VIDANGE D'EMBASE | 1 | | |
| | | CMHBF75115KITA | | KIT ANODO | ANODE KIT | KIT ANODO | KIT ANODE | 1 | | |
| | | REC16900-SA5-004 | | FILTRO COMBUSTIBLE | FUEL FILTER | FILTRO COMBUSTIBILE | FILTRE À ESSENCE | 1 | | |
| | | BF75D BF90D | | REC06211-ZY9-505 | REC06192-ZV1-000 | KIT TURBINA | IMPELLER KIT | KIT GIRANTE | KIT TURBINE | 1 |
| PAGB/T91-2.5X30 | | | | PIN | PIN | PIN | GOUPILLE | 1 | | |
| NGKIZFR6K11 | | | | BUJÍA | SPARK PLUG | CANDELE | BOUGIE | 4 | | |
| REC15400-RBA-F01 | | | | FILTRO DE ACEITE | OIL FILTER | FILTRO OLIO | FILTRE A HUILE | 1 | | |
| CMHBF75115KITA | | | | KIT ANODO | ANODE KIT | KIT ANODO | KIT ANODE | 1 | | |
| REC19300-ZV5-043 | | | | TERMOSTATO | THERMOSTAT | TERMOSTATO | TERMOSTAT | 1 | | |
| REC12-191833 | | | | JUNTA DRENAJE COLA | DRAIN PLUG GASKET | GUARNIZIONE DRENAGGIO | JOINT DE VIDANGE D'EMBASE | 2 | | |
| PAF15-04000003 | | | | JUNTA DRENAJE COLA | DRAIN PLUG GASKET | GUARNIZIONE DRENAGGIO | JOINT DE VIDANGE D'EMBASE | 1 | | |
| REC16900-SR3-004 | | | | FILTRO COMBUSTIBLE | FUEL FILTER | FILTRO COMBUSTIBILE | FILTRE À ESSENCE | 1 | | |
| REC16911-ZY3-010 | | | | FILTRO COMBUSTIBLE | FUEL FILTER | FILTRO COMBUSTIBILE | FILTRE À ESSENCE | 1 | | |
| BF115A BF130A | | REC06211-ZW5-505 | REC06192-ZV1-000 | KIT TURBINA | IMPELLER KIT | KIT GIRANTE | KIT TURBINE | 1 | | |
| | | REC15400-RBA-F01 | | FILTRO DE ACEITE | OIL FILTER | FILTRO OLIO | FILTRE A HUILE | 1 | | |
| | | NGKZFR7F | | BUJÍA | SPARK PLUG | CANDELE | BOUGIE | 4 | | |
| | | REC12-191833 | | JUNTA DRENAJE COLA | DRAIN PLUG GASKET | GUARNIZIONE DRENAGGIO | JOINT DE VIDANGE D'EMBASE | 2 | | |
| | | PAF15-04000003 | | JUNTA DRENAJE COLA | DRAIN PLUG GASKET | GUARNIZIONE DRENAGGIO | JOINT DE VIDANGE D'EMBASE | 1 | | |
| | | CMHBF75115KITA | | KIT ANODO | ANODE KIT | KIT ANODO | KIT ANODE | 1 | | |
| | | REC16911-ZY3-010 | | FILTRO COMBUSTIBLE | FUEL FILTER | FILTRO COMBUSTIBILE | FILTRE À ESSENCE | 1 | | |
| | | REC16900-SR3-004 | | FILTRO COMBUSTIBLE | FUEL FILTER | FILTRO COMBUSTIBILE | FILTRE À ESSENCE | 1 | | |
| | | BF135A BF150A | | REC06211-ZY5-505 | REC06192-ZY6-000 | KIT TURBINA | IMPELLER KIT | KIT GIRANTE | KIT TURBINE | 1 |
| | | | | PAGB/T91-2.5X30 | | PIN | PIN | PIN | GOUPILLE | 1 |
| REC15400-RBA-F01 | | | | FILTRO DE ACEITE | OIL FILTER | FILTRO OLIO | FILTRE A HUILE | 1 | | |
| NGKIZFR6K11 | | | | BUJÍA | SPARK PLUG | CANDELE | BOUGIE | 4 | | |
| REC12-191833 | | | | JUNTA DRENAJE COLA | DRAIN PLUG GASKET | GUARNIZIONE DRENAGGIO | JOINT DE VIDANGE D'EMBASE | 2 | | |
| PAF15-04000003 | | | | JUNTA DRENAJE COLA | DRAIN PLUG GASKET | GUARNIZIONE DRENAGGIO | JOINT DE VIDANGE D'EMBASE | 1 | | |
| CMHBF35225KITA | | | | KIT ANODO | ANODE KIT | KIT ANODO | KIT ANODE | 1 | | |
| REC16911-ZY3-010 | | | | FILTRO COMBUSTIBLE | FUEL FILTER | FILTRO COMBUSTIBILE | FILTRE À ESSENCE | 1 | | |
| BF175A BF200A BF225A | | | | REC06211-ZY2-506 | REC06192-ZY3-000 | KIT TURBINA | IMPELLER KIT | KIT GIRANTE | KIT TURBINE | 1 |
| | | | | REC15400-PLM-A01PE | | FILTRO DE ACEITE | OIL FILTER | FILTRO OLIO | FILTRE A HUILE | 1 |
| | | NGKIZFR6K11 | | BUJÍA | SPARK PLUG | CANDELE | BOUGIE | 6 | | |
| | | PAF15-07000031 | | TERMOSTATO | THERMOSTAT | TERMOSTATO | TERMOSTAT | 1 | | |
| | | PAGB/T91-2.5X30 | | PIN | PIN | PIN | GOUPILLE | 1 | | |
| | | REC12-191833 | | JUNTA DRENAJE COLA | DRAIN PLUG GASKET | GUARNIZIONE DRENAGGIO | JOINT DE VIDANGE D'EMBASE | 2 | | |
| | | PAF15-04000003 | | JUNTA DRENAJE COLA | DRAIN PLUG GASKET | GUARNIZIONE DRENAGGIO | JOINT DE VIDANGE D'EMBASE | 1 | | |
| | | CMHBF35225KITA | | KIT ANODO | ANODE KIT | KIT ANODO | KIT ANODE | 1 | | |
| | | REC16911-ZY3-010 | | FILTRO COMBUSTIBLE | FUEL FILTER | FILTRO COMBUSTIBILE | FILTRE À ESSENCE | 1 | | |

SISTEMA DE ALIMENTACIÓN Y FILTRACIÓN FUEL & FILTRATION SYSTEM

SISTEMA DI ALIMENTAZIONE E FILTRAZIONE SYSTÈME D'ALIMENTATION ET DE FILTRATION

BOMBA DE COMBUSTIBLE FUEL PUMP POMPA BENZINA POIRE À CARBURANT



BOMBA DE COMBUSTIBLE FUEL PUMP POMPA BENZINA POIRE À CARBURANT

Fabricada con elastómeros termoplásticos inyectados, resistentes al alcohol y rayos UV.s

Premium quality bulb resistance to alcohol as well as UV and ozone.

Fabbricata con elastomero termoplastico, resistente ai solventi e raggi UV.

Fabriqué avec des élastomères thermoplastiques injectés, résistant aux carburants et aux rayons UV.

| REF |  |  |
|---------|---|---|
| GS31187 | 1/4" = 6 mm | 1 |
| GS31090 | 5/16" = 8 mm | 1 |
| GS31095 | 3/8" = 9.5 mm | 1 |
| GS31090 | 5/16" = 8 mm | 1 |

GOLDENSHIP





LÍNEA DE COMBUSTIBLE FUEL LINE ASSEMBLY TUBO CARBURANTE TUYAU CARBURANT

Universal. Manguera resistente al alcohol.

Universal. Alcohol resistant hose.



Universale. Tubo resistente ai solventi.

Universel. Tuyau résistant à l'alcohol.

| REF |  |  |
|------------|---|---|
| GS31096 | 5/16" x 2 m | 1 |
| GS31097 | 3/8" x 2 m | 1 |
| GS31099 | 8 mm x 2 m | 1 |
| SIE18-8013 | 5/16" x 2 m | 1 |
| SIE18-8015 | 3/8" x 2 m | 1 |



SIE18-8013
SIE18-8015

| REF |  |  |
|---------|---|---|
| GS31189 | 3/8" x 2 m | 1 |

MADE IN THE USA **GOLDENSHIP**



| REF |  |  |
|---------|--|---|
| GS31183 | 6 mm x 2 m | 1 |

GOLDENSHIP

new





MANGUERA DE COMBUSTIBLE FUEL HOSE TUBO BENZINA TUYAU CARBURANT

Manguera «Trident» para líneas de combustible. Con refuerzo termoplástico que le permite excelente flexibilidad y resistencia a los rayos UV. Color gris. Resistente al alcohol. Especialmente indicado para motores fueraborda. Garantía: 3 años

Marine fuel hose (distribution and vent) for outboards. Fuel resistant thermo-plastic formulation with 2 spiral reinforcement provides excellent bendability and resistance to UV, aging and permeation by all marine fuels (gasoline/petrol and diesel) including alcohol blends. Warranty: 3 years

Tubo «Trident» per linea combustibile. Con rinforzo termoplastico che gli permette un'eccellente flessibilità e resistenza ai raggi UV. Colore grigio. Resistente ai solventi. Indicato per i motori fuoribordo. Garanzia: 3 anni

Tuyau «Trident» pour carburant. Avec renfort thermoplastique qui permet une excellente flexibilité et résistance aux rayons UV. Gris. Résistant à l'alcohol. Convient particulièrement aux moteurs hors-bord. Garantie: 3 ans

| REF |  |  |  |  |
|-------------|---|---|---|---|
| TRI305-0566 | 5/16" = 7,92 mm | 15 m | 1 | SAEJ1527 |
| TRI305-0386 | 3/8" = 9,53 mm | 15 m | 1 | ISO-8469 B1 CE |



TRIDENT



De goma para diesel y gasolina sin plomo. Ideal para fueraborda. Refuerzos textiles internos. Muy flexible. Contenido aromático 50%

Rubber Hose suitable for loading mineral oils, diesel and unloaded fuel

In gomma per diesel e benzina senza piombo. Ideale per motori fuoribordo. Tessuto interno rinforzato. Molto flessibile.

Caoutchouc pour diesel et essence sans plomb. Idéal pour le hors-bord. Renforts textiles internes. Très flexible

CARBUPOMP/10NL

| REF |  |  |  |  |  |  |
|---------|---|---|---|---|---|---|
| GS35031 | 6x12 | 10 bar | 50 mm | -25°C → 80°C | 50 m | ISO R1307 |
| GS35032 | 8x15 | 10 bar | 65 mm | | 50 m | |

H.T. CARBUPOMP/10NL - WP 30 BAR - R<1M ØI=150 R1307

ht hoses technology

MUELLE TUBO COMBUSTIBLE

SPRING, FUEL PIPE

MOLLA TUBO COMBUSTIBLE

RESSORT, TUYAU DE CARBURANT

new

| REF |
|---------------|
| PAF4-04000030 |
| PAF4-05000010 |



ABRAZADERA

CLAMP SMALL

FASCETTE

COLLIER

new

| REF | |
|-----------------|------|
| REC650-24351-51 | 6 mm |
| REC6E5-24351-51 | 8 mm |



| REF | | |
|--------------------|--------|----|
| REC09401-11425 | 6-8 mm | 1 |
| REC09401-11425BULK | 6-8 mm | 25 |



ADPATADOR LÍNEA DE COMBUSTIBLE

COUPLER

ADATTATORE

RACCORD COUPLEUR

| REF | |
|-----------------|--------------------|
| REC22-8M0001721 | Ø 11 mm --> Ø 9 mm |



COMPONENTES TANQUE Y CONECTORES

FUEL TANK COMPONENTS & CONNECTORS

COMPONENTI SERBATOIO E CONETTORI

COMPOSANTS ET CONECTEURS DU RESERVOIR

CONECTOR DE DEPÓSITO

TANK CONNECTOR

ATTACCO SERBATOIO

RACCORDS DE RESERVOIR

Fabricado en latón.

Made in machined brass.

Fabbricato in ottone.

Coude MF 1/4" NPT en laiton.

| REF | | |
|---------|----------|---|
| GS31068 | 1/4" NPT | 1 |



Para conectar dos motores a un sólo depósito, o viceversa. Fabricado en latón.

To connect two motors to a single tank, or vice versa. Made in machined brass.

Per collegare due motori a un singolo serbatoio o viceversa. Fabbricato in ottone.

Té en laiton, pour connecter deux moteurs à un même réservoir, ou inversement.

| REF | | |
|---------|----------|---|
| GS31069 | 1/4" NPT | 1 |



| REF | OEM | |
|------------------|--------------------------------|--|
| REC17710-ZW9-033 | 17710-ZW9-023 17710-ZW9-033 | |
| BF4 --> BF130 HP | | |

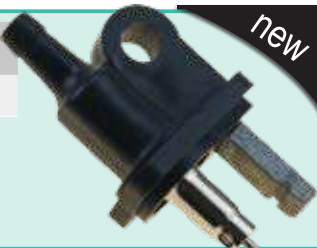

new

| REF | OEM | |
|---------|-----------------------------------|------|
| GS31030 | 17660-ZV5-902 | 3/8" |
| | antigüos old vecchio ancien | |



GOLDENSHIP MADE IN THE USA

| REF | OEM | |
|---------|---------------------------------|------------------|
| GS31031 | 17660-ZV5-A00 17660-ZW9-003 | 1/4" NPT 3/8" |
| | nuevos news nuovo nouveau | |



GOLDENSHIP MADE IN THE USA

| REF | OEM | |
|---------|-----------------------------------|------|
| GS31034 | 17650-921-003ZB | 3/8" |
| | antigüos old vecchio ancien | |



GOLDENSHIP MADE IN THE USA

| REF | OEM | |
|---------|----------------|----------|
| GS31033 | 116977-ZV5-A00 | 1/4" NPT |



nuevos | news | nuovo | nouveau





| REF | OEM | |
|---------|----------------|----------|
| GS31032 | 116977-ZV5-900 | 1/4" NPT |

antigüos | old | vecchio | ancien

| PASAMAMPAROS | THRU HULL | PASSASCAFO | PASSE-CLOISON |
|---|---|---|--|
| Para atravesar mamparos de hasta 12 mm. Fabricado en latón. | For bulkhead up to 12 mm. Made in machined brass. | Per attraversare paratie fino a 12 mm. Fabricato in ottone. | Pour traverser des cloisons jusqu'à 12 mm. Fait en laiton. |

| REF | | |
|---------|------|---|
| GS31064 | 3/8" | 1 |



| FILTRO DE COMBUSTIBLE Y ELEMENTOS | FUEL FILTERS AND ELEMENTS | FILTRI BENZINA E RACCORDI | FILTRE A ESSENCE ET CARTOUCHE DE RECHANGE |
|---|---|--|---|
| BRACKET | BRACKET | SUPPORTO | TÊTE DE FILTRE À ESSENCE |
| Con 2 tapones de bronce y 2 tubos de extensión. (2 entradas y 2 salidas). | With 2 brass plugs and 2 extension tubes. (2 inputs & 2 outputs). | Con 2 tappi di bronzo e 2 tubi di estensione. (2 ingressi entrata carburante e 2 uscite carburante). | Avec 2 bouchons en bronze et 2 tubes d'extension. (2 entrées et 2 sorties). |

| REF | | |
|--------------|------|--|
| REC25000 | 1/4" | AL |
| REC25010 | 1/4" | INOX /SS AISI316 |
| REC25020 | 3/8" | AL |
| REC25030 | 3/8" | INOX /SS AISI316 |
| RECOBBRACKET | 1/4" | Plástico Plastic Plastica Plastique |



REC25000 - REC25020 REC25010 - REC25030 RECOBBRACKET

| FILTRO COMBUSTIBLE SEPARADOR DE AGUA | WATER SEPARATING FUEL FILTER | FILTRO SEPARATORE ACQUA-BENZINA | FILTRE SEPARATEUR EAU-ESSENCE |
|--------------------------------------|------------------------------|---------------------------------|-------------------------------|
| REC24942 | 06177-ZX2-000HE | 10 | 4 ^{7/16"} 11 cm |
| REC35-802893Q01 | | 10 | 3 ^{3/4"} |
| REC855686 | | 28 | 4 ^{7/16"} |
| REC35-802893Q | | 25 | 3 ^{3/4"} |
| RACPF5510 | | 10 | 4 ^{7/16"} |



RACPF5510 REC24942 REC35-802893Q01 REC855686 REC35-802893Q



| Filtro original. | OEM filter. | Filtro benzina originale. | Filtre à essence d'origine |
|------------------|-------------|---------------------------|----------------------------|
| REC35-802893Q | 10 | 3 ^{3/4"} | |



| FILTRO CON BRACKET | OEM FILTER WITH BRACKET | FILTRO BENZINA CON SUPPORTO | FILTRE A ESSENCE AVEC SUPPORTO |
|--|--|---|---|
| Con 2 tapones de bronce y 1 tubo de extensión. | With 2 brass plugs & 1 extension tube. | Con 2 tappi di bronzo e 1 tubo di estensione. | Avec 2 bouchons en bronze et 1 tube d'extension |

| REF | RO OEM | MICRON | | | BRACKET |
|----------|-----------------|--------|------|--------|---------|
| REC24950 | | 25 | 1/4" | 50 GPH | AL |
| REC24952 | 06177-ZX2-000HE | 10 | 1/4" | 50 GPH | AL |





FILTRO DECANTADOR DE COMBUSTIBLE COMPLETO CON VASO TRASPARENTE

COMPLET FUEL FILTER WITH TRANSPARENT BOWL

FILTRO DI DECANTAZIONE BENZINA COMPLETO CON VASCHETTA TRASPARENTE

FILTRE DÉCANTEUR ESSENCE AVEC BOL TRANSPARENT

| REF |  |  |
|----------------|---|---|
| RAC320R-RAC-01 | | AL |
| RAC320R-RAC-03 | RACS3213 LENS3213 | Plástico Plastic Plastica Plastique |

RACOR



| REF |  |  |  |
|-------------|--|---|---|
| RECOBIFALU | | | AL |
| RECOBFILTER | RECOBELEMENT LENS3213 | 150 l/h | Plástico Plastic Plastica Plastique |

RECMAR



FILTRO CON BOMBA CEBADORA

FILTER WITH PRIMING PUMP

FILTRO CON PEMPETA PER RIEMPIRE

FILTRE A ESSENCE AVEC POMPE D'AMORCAGE

| REF |  | MICRON |  |  |  |
|----------------|---|--------|---|---|---|
| RAC490R-RAC-01 | RACS3227 LENS3227 | 10 | 340 l/h | 3/8" NPTF | 150 hp |

RACOR



FILTRO DECANTADOR GASOLINA

COMPLETE FUEL FILTER

FILTRO DECANTATORE BENZINA

FILTRE DÉCANTEUR ESSENCE

Filtro de combustible con braket.

Complete fuel filter with braket.

Filtro combustibile con supporto.

Filtre à carburant avec support.

| REF |  | MICRON |
|-------------|---|-----------------------|
| RAC23299-10 | RAC23289-10 | 130 HP (4 T/ Strokes) |

RACOR



| REF | MICRON |  |
|-----------------|--------|---|
| PAF40-0701000E1 | 10 | 70 hp |



new

| | | | | | | |
|----------------|-----|---|------------|--------|---|---|
| REF | OEM |  | R.O. / OEM | MICRON |  |  |
| REC90794-46866 | | REC90794-46868 | | 10 | 117 l/h | 175 hp |



LLAVE PARA FILTRO
 FILTER KEY
 CHIAVE DA FILTRO
 CLÉ A FILTRE

REF
 RECYS-225-15



RACOR



| REF | RAC120R-RAC-01 | RAC320R-RAC-01 | RAC320R-INOX-01 RAC320R-RAC-03 | RAC320R-RAC-02 RAC320R-INOX-02 |
|--|----------------------|----------------------|-----------------------------------|-----------------------------------|
| RO /OEM | 06178-ZW1-030GH | | 06177-ZW1-801AH | |
| FLUJO MÁXIMO MAX. FLOW FLUSSO MASSIMO FLUX MAXIMAL | 114 l/h 30 gph | 340 l/h 60 gph | 340 l/h 60 gph | 340 l/h 60 gph |
| ELEMENTO ELEMENT ELEMENTO ELEMENT | RACS3240 LENS3240 | RACS3213 LENS3213 | RACS3213 LENS3213 | RACS3220UL |
| CAZOLETA TRANSPARENTE (sólo se recomienda para fueraborda.) CLEAR BOWL (Just for outboards) VASCHETTA TRASPARENTE (Solo nei fuoribordo.) BOL TRANSPARENT (uniquement recommandé pour le hors-bord.) | 17670-ZW1-030GH | | 17670-ZW1-801AH | |
| ROSCAS CENTRALES CENTRAL THREADS FILETTO CENTRALE TAILLE DU FILETAGE POUR LA CARTOUCHE | M18 x 1.5 | 1 1/4" | 1 1/4" | 1 1/4" |
| TAMAÑO ROSCA CABEZA HEAD PORT SIZE DIMENSIONE VITE TESTA TAILLE DU FILETAGE POUR LES RACCORDS | 1/4-18 NPTF | 1/4-18 NPTF | 1/4-18 NPTF | 1/4-18 NPTF |
| ALTURA X Ø HEIGHT X Ø ALTEZZA X Ø HAUTEUR X Ø | 166 x 81 mm | 238 x 102 mm | 238 x 102 mm | 238 x 102 mm |
| PESO WEIGHT PESO POIDS | 0,5 kg | 0,9 kg | 0,9 kg | 0,9 kg |
| CAIDA DE PRESIÓN PRESSURE DROP CADUTA DI PRESSIONE CHUTE DE PRESSION | 0.15 PSI 0.01 bar | 0.61 PSI 0.04 bar | 0.61 PSI 0.04 bar | 0.61 PSI 0.04 bar |
| PRESIÓN MÁXIMA MAX. PRESSURE PRESSIONE MASSIMA PRESSION MAXIMALE | 7 PSI 0.05 bar | 7 PSI 0.05 bar | 7 PSI 0.05 bar | 7 PSI 0.05 bar |
| DESMONTAJE CARTUCHO-CAZOLETA ELEMENT REMOVAL UNDERBOWL RIMOZIONE DELLA CARTUCCIA DEMONTAGE DE LA CARTOUCHE | 25,4 mm 1" | 25,4 mm 1" | 25,4 mm 1" | 25,4 mm 1" |
| TEMPERATURA DE TRABAJO OPERATING TEMPERATURE TEMPERATURA DI LAVORO TEMPERATURE DE TRAVAIL | -40°C +124°C | | | |

| RÁCORES | | RACORS | | RACCORDI | | RACCORDS | |
|---------|----------|----------------|---|----------|----------|----------------|---|
| REF | | | | REF | | | |
| GS31065 | 1/4" NPT | 3/8" = 9.5 mm | 1 | GS31066 | 1/4" NPT | 5/16" = 7.9 mm | 2 |
| GS31166 | 1/4" NPT | 5/16" = 7.9 mm | 2 | GS31067 | 1/4" NPT | 3/8" = 9.5 mm | 2 |
| GS31155 | 3/8" NPT | 3/8" = 9.5 mm | 2 | | | | |
| GS31156 | 3/8" NPT | 5/16" = 7.9 mm | 2 | | | | |
| GS31157 | 3/8" NPT | 1/4" = 6.4 mm | 2 | | | | |





GOLDENSHIP

| LLAVES PARA FILTRO | | FILTER KEY | | CHIAVE DA FILTRO | | CLÉ À FILTRE | |
|--------------------|--|------------|--|------------------|-------------|--------------|--|
| REF | | | | REF | | | |
| RACRK22628 | | | | REC70720 | 65 - 110 mm | | |



RACOR **RECmar**

| FILTRO COMBUSTIBLE PARA MONTAJE EN LÍNEA | | IN-LINE FUEL FILTER | |
|--|---------|---------------------|-----------------------|
| REF | | | |
| GS31001 | 50 l/h | 6-8 mm | plástico plastic |
| GS31002 | 150 l/h | 8-10 mm | plástica plastique |

GOLDENSHIP

| FILTRO BENZINA PER MONTARE IN LINEA | | FILTRE A ESSENCE EN LIGNE | |
|-------------------------------------|---------------|---------------------------|--|
| REF | OEM | | |
| REC16910-ZV4-015 | 16910-ZV4-015 | | |

- BF15AM/B/D3/DK2
- BF8C/CX/B1/B2/D1/D2/
- P8B1/P8B2/DK2
- BF9.9AH/AK/AM/B/DK2/D1
- BF25D4/DK2/A/A1/AX
- BF30D4/DK2/A/A1/AX
- BF20A/AX/D3
- BF10B1/D1/P10B1/DH/DK2
- BF75DK0/DK2/DK3
- BF40D/DK2
- BF50D/DK2



| FILTRO COMBUSTIBLE PARA MONTAJE EN LÍNEA | | IN-LINE FUEL FILTER | |
|--|-------------|--|---|
| REF | | | |
| GS30435 | 6, 8, 10 mm | metal + cristal metal + crystal metal + cristal métal + verre | 1 |



GOLDENSHIP

| FILTRO BENZINA PER MONTARE IN LINEA | | FILTRE A ESSENCE EN LIGNE | |
|-------------------------------------|---------------|---------------------------|--|
| REF | OEM | | |
| REC16900-SA5-004 | 16900-SA5-004 | | |

- BF35AM
- BF40B/B2/BX/A4/A1/A2/AX/A3/AY
- BF45AM
- BF75A1/AT/AV/AX/A2/A3
- BF90A1/AF/AV/AX/A2/A3
- BF50A4/A1/A2/AX/A3/AY (14ZW00E1M)



| FILTRO COMBUSTIBLE PARA MONTAJE EN LÍNEA | | IN-LINE FUEL FILTER | |
|--|-----|---------------------|-------|
| REF | OEM | | |
| REC40145 | | 1/4" | 1/4" |
| REC40155 | | 5/16" | 5/16" |
| REC40165 | | 3/8" | 3/8" |
| REC40135 | | 5/16" | 3/8" |



GOLDENSHIP

| FILTRO BENZINA PER MONTARE IN LINEA | | FILTRE A ESSENCE EN LIGNE | |
|-------------------------------------|---------------|---------------------------|--|
| REF | OEM | | |
| REC16910-GB2-005 | 16900-GB2-005 | | |

- BF4.5B/BX/B2/B4/B6
- BF5A1/AH/AK/AM/AX/A2/A3/A4
- BF6B/BX/D6
- BF8AX/BX/AH/AK/AM
- BF50F
- BF75F
- BF100F



| FILTRO BENZINA PER MONTARE IN LINEA | | FILTRE A ESSENCE EN LIGNE | |
|-------------------------------------|---------------|---------------------------|--|
| REF | OEM | | |
| REC16900-SR3-004 | 16900-SR3-004 | | |

- BF115A1 / A2 / A3 / AX
- BF130A1 / A2 / A3 / AX

Series #14ZW50E1M



| REF | OEM |
|------------------|--------------------------------|
| REC16901-ZY3-003 | 16901-ZY3-003 16911-ZY3-003 |



new

- BF115
- BF135
- BF150
- BF175
- BF200
- BF225
- BF250

| REF | OEM |
|------------------|---------------|
| REC16911-ZZ5-003 | 16911-ZZ5-003 |



new

- BF40D, DK2, DK4, E
- DF50D, DK2, DK4
- BF60A, AK1
- BFF60A, AK1

| REF | OEM |
|------------------|---------------|
| REC16911-ZY3-010 | 16911-ZY3-010 |



- BF80A
- BF100A
- BF90D2 / D4 / DK0
- BF75DK2 / DK3 / DK0
- BF150AK2 / A4
- BF135AK2 / A4
- BF225AK2 / AK3 / AK1 / A6
- BF200AK2 / AK3 / AK1 / A6
- BF175AK2 / AK3 / AK1 / A6
- BF250A
- BF115D / DK1 / A2
- BF130 A2

| REF | OEM |
|------------------|---------------|
| REC16010-ST5-993 | 16900-ST5-993 |



- BF115
- BF130 / AX / AY / A1
- Series #14ZW50E1M

| REF | OEM |  |  |
|---------------|-----------------|---|---|
| RAC025-RAC-02 | 06176-ZW3-801AH | 1/4" 18 NPTF | 1/4" 18 NPTF |



| REF | OEM |
|----------|-----------------|
| RACS2502 | 17670-ZW3-801AH |



new

- BF5
- BF20

ACEITE OIL OLIO HUILES

| REF |  |  | |
|------------|---|---|-----------|
| REC2TU6 | 1 L | 6 | 2 STROKES |
| REC2TU3 | 5 L | 3 | TC-W3 |
| REC5W40U6 | 1 L | 6 | SAE 5W40 |
| REC5W40U3 | 5 L | 3 | |
| REC10W30U6 | 1 L | 6 | SAE 10W30 |
| REC10W30U3 | 5 L | 3 | |
| REC10W40U6 | 1 L | 6 | SAE 10W40 |
| REC10W40U3 | 5 L | 3 | |
| REC25W40U3 | 5 L | 3 | SAE 25W40 |
| REC80W90U3 | 5 L | 3 | |
| REC80W90U6 | 1 L | 6 | SAE 80W90 |



new



| REF |  |  | |
|------------------|---|---|-----------|
| RM92-858026QB1U6 | 1 L | 6 | 2 STROKES |
| RM92-858027QB1U3 | 3,8 L | 3 | |
| RM92-8M0086220U6 | 1 L | 6 | SAE 10W30 |
| RM92-8M0086221U3 | 4 L | 3 | |



RM92-858026QB1U6 RM92-858027QB1U3 RM92-8M0086220U6 RM92-8M0086221U3

FILTRO DE ACEITE

OIL FILTER

FILTRO OLIO

FILTRE A HUILE

FILTROS DE ACEITE

OIL FILTER

FILTRO OLIO

FILTRES A HUILE

| REF | OEM |
|-----------------|----------------|
| REC35-822626Q03 | 15400-PM3-004 |
| | 15400-PFB-014, |
| | 15400-PFRB-007 |
| | 15400-ZW4-003 |
| | 15400-PJ7-015 |
| | 15400-PM3-405 |
| | 15400-PFB-004 |



| | | |
|---|---------|---------|
|  BF25DE4 | BF15DK3 | BF50DK2 |
| BF30D4 | BF20D3 | BF50DK4 |
| BF8B2 | BF20DK2 | BF8D4 |
| BF8D2 | BF20DK3 | BFP10D2 |
| BF10B2 | BF25DK2 | |
| BF10D2 | BF30DK2 | |
| BF10D4 | BF40DK2 | |
| BF15D3 | BF40DK4 | |

| REF | OEM |
|--------------------|-----------------|
| REC15400-PLM-A01PE | 15400-PH1-F03 |
| | 15400-POH-305PE |
| | 15400-POH-305 |
| | 15400-ZJI-004 |
| | 15400-PLM-A01PE |
| | 15400-RTA-003 |
| | 15400-RTA-004 |



| | | | | |
|--|----------|----------|---------|-----------|
|  BF100A | BF150AK2 | BF200AK2 | BF250A | BF90DK0 |
| BF100AK1 | BF175A6 | BF200AK3 | BF250D | BF90DK2 |
| BF115A2 | BF175AK1 | BF200D | BF75DK0 | BF90DK4 |
| BF115D | BF175AK2 | BF225A6 | BF75DK2 | BF90DK5 |
| BF115DK1 | BF175AK3 | BF225AK1 | BF75DK3 | BFT100AK1 |
| BF135A4 | BF175D | BF225AK2 | BF75DK4 | BF80AK1 |
| BF135AK2 | BF200A6 | BF225AK3 | BF80A | |
| BF150A4 | BF200AK1 | BF225D | BF80AK1 | |

| REF | OEM |
|------------------|---------------|
| REC15400-RBA-F01 | 15400-RBA-F01 |



| | |
|--|--|
|  V-TEC150 | |
| V-TEC175 | |

| REF | OEM |
|-----------------|---------------|
| REC5GH-13440-00 | 15400-PFB-007 |



| | |
|--|--|
|  BF25 | |
| BF30 | |
| BF40 | |

GUÍA FILTROS DE ACEITE

OIL FILTER GUIDE

GUIDA FILTRO OLIO

GUIDE DES FILTRES A HUILE

|  | REF |
|---|-----------------|
| BF8B2 | |
| BF8D2 | REC35-822626Q03 |
| BF8D4 | |
| BF10B2 | |
| BF10D2 | REC35-822626Q03 |
| BF10D4 | |
| BFP10D2 | |
| BF15D3 | REC35-822626Q03 |
| BF15DK3 | |
| BF20D3 | |
| BF20DK2 | REC35-822626Q03 |
| BF20DK3 | |
| BF25 | REC5GH-13440-00 |
| BF25DE4 | REC35-822626Q03 |
| BF25DK2 | |
| BF30 | REC5GH-13440-00 |
| BF30D4 | REC35-822626Q03 |
| BF30DK2 | |
| BF40 | REC5GH-13440-00 |
| BF40DK2 | REC35-822626Q03 |
| BF40DK4 | |

|  | REF |
|---|------------------------------|
| BF50DK2 | REC35-822626Q03 |
| BF50DK4 | |
| BF75DK2 | |
| BF75DK3 | M20 x 1.5 REC15400-PLM-A01PE |
| BF75DK4 | |
| BF75DK0 | |
| BF80A | |
| BF80AK1 | M20 x 1.5 REC15400-PLM-A01PE |
| BFT80AK1 | |
| BF90DK2 | |
| BF90DK4 | M20 x 1.5 REC15400-PLM-A01PE |
| BF90DK5 | |
| BF90DK0 | |
| BF100A | |
| BF100AK1 | M20 x 1.5 REC15400-PLM-A01PE |
| BFT100AK1 | |
| BF115A2 | |
| BF115D | M20 x 1.5 REC15400-PLM-A01PE |
| BF115DK1 | |
| BF135A4 | |
| BF135AK2 | M20 x 1.5 REC15400-PLM-A01PE |

|  | REF |
|---|------------------------------|
| BF150A4 | M20 x 1.5 REC15400-PLM-A01PE |
| BF150AK2 | |
| BF175A6 | |
| BF175AK1 | M20 x 1.5 REC15400-PLM-A01PE |
| BF175AK2 | |
| BF175AK3 | |
| BF175D | |
| BF200A6 | |
| BF200AK1 | M20 x 1.5 REC15400-PLM-A01PE |
| BF200AK2 | |
| BF200AK3 | |
| BF200D | |
| BF225A6 | |
| BF225AK1 | M20 x 1.5 REC15400-PLM-A01PE |
| BF225AK2 | |
| BF225AK3 | |
| BF225D | |
| BF250A | M20 x 1.5 REC15400-PLM-A01PE |
| BF250D | |
| V-TEC150 | M20 x 1.5 REC15400-RBA-F01 |
| V-TEC175 | |

BOMBA DE COMBUSTIBLE ELECTRICA

ELECTRIC FUEL PUMP

POMPA BENZINA ELETTRICA

POMPE À ESSENCE ÉLECTRIQUE

| REF | OEM |
|------------------|--------------------------------|
| REC16735-ZW5-003 | 16735-ZW5-003 16735-ZY3-004 |

 BF100A, AK1
BTF100AK1
BF115A1, A2, A3, AX
BF130A1, A2, AX
BF135A4, AK2
BF150A4, AK2
BF75DK0, DK2, DK3, DK4
BF90DK0, DK2, DK4, DK5

BF80A, AK1
BFT80AK1
BF175D, A3, A6, AK1, AK2, AK3
BF200D, A2, A3, A6, AK1, AK2, AK3
DF225D, A2, A3, A6, AK1, AK2, AK3
BF250D, A



new

BOMBA DE COMBUSTIBLE MECANICA

MECHANICAL FUEL PUMP

POMPA BENZINA MECCANICA

POMPE À ESSENCE MECANIQUE

| REF | OEM |
|------------------|--------------------------------|
| REC16700-ZW1-004 | 16700-ZW1-004 16700-ZV5-003 |

 BF20A, AX, A2
BF25A, A1, AX
BIF35AM
BF40B, B2, BX, A, A1, A2, AX, AY
BF45AM
BF30A, A1, AX
BF75A1, AT, AV, AX, A2
BF90A1, AT, AV, AX, A2
BF50A, A1, A2, AX, AY



new

INYECTORES

INJEKTOR

INIETTORE

INJECTEURS

| REF | OEM |
|------------------|---------------|
| REC06164-PCA-000 | 06164-PCA-000 |

 BF115AX
BF130AX



new

CARBURADOR

CARBURETOR

CARBURATORE

CARBURATEUR

AGUJA CARBURADOR

CARBURETOR, NEEDLE VALVE

SPILLO CONICO CARBURATORE

POINTEAU CARBURATEUR

| REF | OEM |
|------------------|---------------|
| REC16011-881-741 | 16011-881-741 |

 BF5 (-2003)
BF8
BF75 (-1997)
BF100 (-1997)



| REF | OEM |
|------------------|---------------|
| REC16011-ZV4-005 | 16011-ZV4-005 |

 BF8 (2001+)
BF9.9
BF15
BF20 (2003+)
BF25
BF30

BF35 (1997)
BF40
BF45 (1997)
BF50
BF75 (1997+)
BF90 (1997+)



KITS CARBURADORES

CARBURETOR KITS

KIT CARBURATORI

KIT CARBURATEUR

| REF | OEM |
|------------------|---------------------------|
| REC06160-ZV4-U11 | 06160-ZV4-U11 Honda KIT 1 |

| REF | OEM |
|------------------|--------------------------|
| REC16010-ZW9-003 | 16010-ZW9-003 Honda KIT2 |

| REF | OEM |
|------------------|--------------------------|
| REC16010-ZV4-005 | 16010-ZV4-005 Honda KIT3 |

| REF | OEM |
|------------|------------|
| REC18-7053 | Honda KIT4 |

GUÍA CARBURADORES

GUIDE CARBURETORS

GUIDA CARBURATORI

GUIDE DES CARBURATEURS





















| Motor | KIT |
|--------------------------------|--------------------------------------|
| BF8C, CX | REC16010-ZV4-005 |
| BF8B1, B2, D1, D2, D3, D4, DK2 | REC16010-ZW9-003 |
| BF8 (2001+) | REC18-7053 |
| BFP8B1, B2, D1, D2, D3 | REC16010-ZW9-003 |
| BF9.9 | REC18-7053 |
| BF9.9AH, AK, AM, AX, AY, B, BX | REC16010-ZV4-005 |
| BF9.9D1, D2, D3, DK2 | REC16010-ZW9-003 |
| BFP9.9D, D1, D2 | REC16010-ZW9-003 |
| BF10B1, B2, D1, D2, D4, K2 | REC16010-ZW9-003 |
| BFP10B1, B2, D1, D2 | REC16010-ZW9-003 |
| BF15 | REC18-7053 |
| BF15A1, A2, A3 | REC06160-ZV4-U11 REC16010-ZV4-005 |
| BF15AH, AM, AX, AY | REC16010-ZV4-005 |
| BF15B, B2, BX | REC16010-ZV4-005 |
| BF15D3, DK2, DK3 | REC16010-ZW9-003 |
| BF20 (2003+) | REC18-7053 |
| BF20A, A2, AX | REC16010-ZV4-005 |

| Motor | KIT |
|--|------------------|
| BF20D3, DK2, DK3 | REC16010-ZW9-003 |
| BF25 | REC18-7053 |
| BF25A, A1, A2, A3, AX, D4, DK2 | REC16010-ZV4-005 |
| BF30 | REC18-7053 |
| BF30A, A1, A2, A3, AX, D4, DK2 | REC16010-ZV4-005 |
| BF35 (1997) | REC18-7053 |
| BF35AM | REC16010-ZV4-005 |
| BF40 | REC18-7053 |
| BF40A, A1, A2, A3, A4, AX, AY, B, B2, BX | REC16010-ZV4-005 |
| BF45 (1997) | REC18-7053 |
| BF45AM | REC16010-ZV4-005 |
| BF50 | REC18-7053 |
| BF50A, A1, A2, A3, A4, AX, AY | REC16010-ZV4-005 |
| BF75 (1997+) | REC18-7053 |
| BF75A1, A2, A3, AT, AV, AX | REC16010-ZV4-005 |
| BF90 (1997+) | REC18-7053 |
| BF90A1, A2, A3, AT, AV, AX | REC16010-ZV4-005 |



SISTEMA ELÉCTRICO ELECTRIC SYSTEM

SISTEMA ELETTRICO SYSTÈME ÉLECTRIQUE

| SENSORES | SENSORS | SENSORE | CAPTEURS | | | | | | | | | | | | | | | | | | | | | | | | | | | | | | | | | | | | | | |
|--|----------------------------|---------------------------------------|--|---------------|---|----------|--|---|--|---|---|---|---|--|--|--|--|--|--|---|--|---|--|---|--|-------|--|-------|--|--|--|--|--------------|--|-----------------------|--|-----------------------|--|-----------|--|--|
| SENSOR MAP | MAP SENSOR | SENSORE MAP | CAPTEUR MAP | | | | | | | | | | | | | | | | | | | | | | | | | | | | | | | | | | | | | | |
| <table border="1"> <thead> <tr> <th>REF</th> <th>OEM</th> </tr> </thead> <tbody> <tr> <td>REC37830-PGK-A01</td> <td>37830-PGK-A01</td> </tr> <tr> <td> BF135A4</td> <td></td> </tr> <tr> <td> BF150A4</td> <td></td> </tr> <tr> <td> BF175A3, A6</td> <td></td> </tr> <tr> <td> BF200A2, A3, A6</td> <td></td> </tr> <tr> <td> BF225A2, A3, A6</td> <td></td> </tr> </tbody> </table>  | REF | OEM | REC37830-PGK-A01 | 37830-PGK-A01 |  BF135A4 | |  BF150A4 | |  BF175A3, A6 | |  BF200A2, A3, A6 | |  BF225A2, A3, A6 | | | <table border="1"> <thead> <tr> <th>REF</th> <th>OEM</th> </tr> </thead> <tbody> <tr> <td>REC37830-PNC-003</td> <td>37830-PNC-003</td> </tr> <tr> <td> BF40DK2, D</td> <td></td> </tr> <tr> <td> BF50DK2, D</td> <td></td> </tr> <tr> <td> BF75, DK0, DK2</td> <td></td> </tr> <tr> <td> BF90DK0, DK2</td> <td></td> </tr> </tbody> </table>  | REF | OEM | REC37830-PNC-003 | 37830-PNC-003 |  BF40DK2, D | |  BF50DK2, D | |  BF75, DK0, DK2 | |  BF90DK0, DK2 | | | | | | | | | | | | | | |
| REF | OEM | | | | | | | | | | | | | | | | | | | | | | | | | | | | | | | | | | | | | | | | |
| REC37830-PGK-A01 | 37830-PGK-A01 | | | | | | | | | | | | | | | | | | | | | | | | | | | | | | | | | | | | | | | | |
|  BF135A4 | | | | | | | | | | | | | | | | | | | | | | | | | | | | | | | | | | | | | | | | | |
|  BF150A4 | | | | | | | | | | | | | | | | | | | | | | | | | | | | | | | | | | | | | | | | | |
|  BF175A3, A6 | | | | | | | | | | | | | | | | | | | | | | | | | | | | | | | | | | | | | | | | | |
|  BF200A2, A3, A6 | | | | | | | | | | | | | | | | | | | | | | | | | | | | | | | | | | | | | | | | | |
|  BF225A2, A3, A6 | | | | | | | | | | | | | | | | | | | | | | | | | | | | | | | | | | | | | | | | | |
| REF | OEM | | | | | | | | | | | | | | | | | | | | | | | | | | | | | | | | | | | | | | | | |
| REC37830-PNC-003 | 37830-PNC-003 | | | | | | | | | | | | | | | | | | | | | | | | | | | | | | | | | | | | | | | | |
|  BF40DK2, D | | | | | | | | | | | | | | | | | | | | | | | | | | | | | | | | | | | | | | | | | |
|  BF50DK2, D | | | | | | | | | | | | | | | | | | | | | | | | | | | | | | | | | | | | | | | | | |
|  BF75, DK0, DK2 | | | | | | | | | | | | | | | | | | | | | | | | | | | | | | | | | | | | | | | | | |
|  BF90DK0, DK2 | | | | | | | | | | | | | | | | | | | | | | | | | | | | | | | | | | | | | | | | | |
| <table border="1"> <thead> <tr> <th>REF</th> <th>OEM</th> </tr> </thead> <tbody> <tr> <td>REC37830-RNA-A01</td> <td>37830-RNA-A01</td> </tr> </tbody> </table>  | REF | OEM | REC37830-RNA-A01 | 37830-RNA-A01 | <table border="1"> <thead> <tr> <th>REF</th> <th>OEM</th> </tr> </thead> <tbody> <tr> <td> BF100A, AK1</td> <td></td> </tr> <tr> <td> BFT100AK1</td> <td></td> </tr> <tr> <td> BF40E</td> <td></td> </tr> <tr> <td> BF80A, AK1</td> <td></td> </tr> <tr> <td> BF75DK3, DK4</td> <td></td> </tr> <tr> <td> BF90DK4, DK5</td> <td></td> </tr> <tr> <td> BF60A</td> <td></td> </tr> <tr> <td> BF115D, DK1</td> <td></td> </tr> </tbody> </table> | REF | OEM |  BF100A, AK1 | |  BFT100AK1 | |  BF40E | |  BF80A, AK1 | |  BF75DK3, DK4 | |  BF90DK4, DK5 | |  BF60A | |  BF115D, DK1 | | <table border="1"> <thead> <tr> <th>REF</th> <th>OEM</th> </tr> </thead> <tbody> <tr> <td>BF40D</td> <td></td> </tr> <tr> <td>BF135A4, AK2</td> <td></td> </tr> <tr> <td>BF50D</td> <td></td> </tr> <tr> <td>BF150A4, AK2</td> <td></td> </tr> <tr> <td>BF175D, AK1, AK2, AK3</td> <td></td> </tr> <tr> <td>BF200D, AK1, AK2, AK3</td> <td></td> </tr> <tr> <td>BF250D, A</td> <td></td> </tr> </tbody> </table>  | REF | OEM | BF40D | | BF135A4, AK2 | | BF50D | | BF150A4, AK2 | | BF175D, AK1, AK2, AK3 | | BF200D, AK1, AK2, AK3 | | BF250D, A | | |
| REF | OEM | | | | | | | | | | | | | | | | | | | | | | | | | | | | | | | | | | | | | | | | |
| REC37830-RNA-A01 | 37830-RNA-A01 | | | | | | | | | | | | | | | | | | | | | | | | | | | | | | | | | | | | | | | | |
| REF | OEM | | | | | | | | | | | | | | | | | | | | | | | | | | | | | | | | | | | | | | | | |
|  BF100A, AK1 | | | | | | | | | | | | | | | | | | | | | | | | | | | | | | | | | | | | | | | | | |
|  BFT100AK1 | | | | | | | | | | | | | | | | | | | | | | | | | | | | | | | | | | | | | | | | | |
|  BF40E | | | | | | | | | | | | | | | | | | | | | | | | | | | | | | | | | | | | | | | | | |
|  BF80A, AK1 | | | | | | | | | | | | | | | | | | | | | | | | | | | | | | | | | | | | | | | | | |
|  BF75DK3, DK4 | | | | | | | | | | | | | | | | | | | | | | | | | | | | | | | | | | | | | | | | | |
|  BF90DK4, DK5 | | | | | | | | | | | | | | | | | | | | | | | | | | | | | | | | | | | | | | | | | |
|  BF60A | | | | | | | | | | | | | | | | | | | | | | | | | | | | | | | | | | | | | | | | | |
|  BF115D, DK1 | | | | | | | | | | | | | | | | | | | | | | | | | | | | | | | | | | | | | | | | | |
| REF | OEM | | | | | | | | | | | | | | | | | | | | | | | | | | | | | | | | | | | | | | | | |
| BF40D | | | | | | | | | | | | | | | | | | | | | | | | | | | | | | | | | | | | | | | | | |
| BF135A4, AK2 | | | | | | | | | | | | | | | | | | | | | | | | | | | | | | | | | | | | | | | | | |
| BF50D | | | | | | | | | | | | | | | | | | | | | | | | | | | | | | | | | | | | | | | | | |
| BF150A4, AK2 | | | | | | | | | | | | | | | | | | | | | | | | | | | | | | | | | | | | | | | | | |
| BF175D, AK1, AK2, AK3 | | | | | | | | | | | | | | | | | | | | | | | | | | | | | | | | | | | | | | | | | |
| BF200D, AK1, AK2, AK3 | | | | | | | | | | | | | | | | | | | | | | | | | | | | | | | | | | | | | | | | | |
| BF250D, A | | | | | | | | | | | | | | | | | | | | | | | | | | | | | | | | | | | | | | | | | |
| SENSOR POSICIÓN ÁRBOL DE LEVAS | CAMSHAFT SENSOR | SENSORE ALBERO A CAME | CAPTEUR DE POSITION D'ARBRE A CAMES | | | | | | | | | | | | | | | | | | | | | | | | | | | | | | | | | | | | | | |
| <table border="1"> <thead> <tr> <th>REF</th> <th>OEM</th> </tr> </thead> <tbody> <tr> <td>REC37510-PNB-003</td> <td>37510-PNB-003</td> </tr> <tr> <td> BF115D, DK1</td> <td></td> </tr> <tr> <td> BF135A4, AK2</td> <td></td> </tr> <tr> <td> BF150A4, AK2</td> <td></td> </tr> </tbody> </table>  | REF | OEM | REC37510-PNB-003 | 37510-PNB-003 |  BF115D, DK1 | |  BF135A4, AK2 | |  BF150A4, AK2 | | | <table border="1"> <thead> <tr> <th>REF</th> <th>OEM</th> </tr> </thead> <tbody> <tr> <td>REC37500-PNB-003</td> <td>37500-PNB-003</td> </tr> <tr> <td> BF175D</td> <td>BF90DK0, DK2, DK5</td> </tr> <tr> <td> BF200D</td> <td>BF75DK3, DK4</td> </tr> <tr> <td> BF225D</td> <td>BF100A, AK1</td> </tr> <tr> <td> BF250D</td> <td>BF80A, AK1</td> </tr> <tr> <td> BF115D, DK1</td> <td>BF60A</td> </tr> <tr> <td> BF135A4, AK2</td> <td>BF40E</td> </tr> <tr> <td> BF150A4, AK2</td> <td></td> </tr> <tr> <td> BF75DK0, DK2</td> <td></td> </tr> </tbody> </table>  | REF | OEM | REC37500-PNB-003 | 37500-PNB-003 |  BF175D | BF90DK0, DK2, DK5 |  BF200D | BF75DK3, DK4 |  BF225D | BF100A, AK1 |  BF250D | BF80A, AK1 |  BF115D, DK1 | BF60A |  BF135A4, AK2 | BF40E |  BF150A4, AK2 | |  BF75DK0, DK2 | | | | | | | | | | |
| REF | OEM | | | | | | | | | | | | | | | | | | | | | | | | | | | | | | | | | | | | | | | | |
| REC37510-PNB-003 | 37510-PNB-003 | | | | | | | | | | | | | | | | | | | | | | | | | | | | | | | | | | | | | | | | |
|  BF115D, DK1 | | | | | | | | | | | | | | | | | | | | | | | | | | | | | | | | | | | | | | | | | |
|  BF135A4, AK2 | | | | | | | | | | | | | | | | | | | | | | | | | | | | | | | | | | | | | | | | | |
|  BF150A4, AK2 | | | | | | | | | | | | | | | | | | | | | | | | | | | | | | | | | | | | | | | | | |
| REF | OEM | | | | | | | | | | | | | | | | | | | | | | | | | | | | | | | | | | | | | | | | |
| REC37500-PNB-003 | 37500-PNB-003 | | | | | | | | | | | | | | | | | | | | | | | | | | | | | | | | | | | | | | | | |
|  BF175D | BF90DK0, DK2, DK5 | | | | | | | | | | | | | | | | | | | | | | | | | | | | | | | | | | | | | | | | |
|  BF200D | BF75DK3, DK4 | | | | | | | | | | | | | | | | | | | | | | | | | | | | | | | | | | | | | | | | |
|  BF225D | BF100A, AK1 | | | | | | | | | | | | | | | | | | | | | | | | | | | | | | | | | | | | | | | | |
|  BF250D | BF80A, AK1 | | | | | | | | | | | | | | | | | | | | | | | | | | | | | | | | | | | | | | | | |
|  BF115D, DK1 | BF60A | | | | | | | | | | | | | | | | | | | | | | | | | | | | | | | | | | | | | | | | |
|  BF135A4, AK2 | BF40E | | | | | | | | | | | | | | | | | | | | | | | | | | | | | | | | | | | | | | | | |
|  BF150A4, AK2 | | | | | | | | | | | | | | | | | | | | | | | | | | | | | | | | | | | | | | | | | |
|  BF75DK0, DK2 | | | | | | | | | | | | | | | | | | | | | | | | | | | | | | | | | | | | | | | | | |
| SENSOR POSICIÓN CIGUENAL | CRANKSHAFT SENSOR | SENSORE ALBERO MOTORE | CAPTEUR DE POSITION DU VILEBREQUIN | | | | | | | | | | | | | | | | | | | | | | | | | | | | | | | | | | | | | | |
| <table border="1"> <thead> <tr> <th>REF</th> <th>OEM</th> </tr> </thead> <tbody> <tr> <td>REC37840-R70-A01</td> <td>37840-R70-A01</td> </tr> <tr> <td> BF175D</td> <td></td> </tr> <tr> <td> BF200D</td> <td></td> </tr> <tr> <td> BF225D</td> <td></td> </tr> <tr> <td> BF250D</td> <td></td> </tr> </tbody> </table>  | REF | OEM | REC37840-R70-A01 | 37840-R70-A01 |  BF175D | |  BF200D | |  BF225D | |  BF250D | | | | | | | | | | | | | | | | | | | | | | | | | | | | | | |
| REF | OEM | | | | | | | | | | | | | | | | | | | | | | | | | | | | | | | | | | | | | | | | |
| REC37840-R70-A01 | 37840-R70-A01 | | | | | | | | | | | | | | | | | | | | | | | | | | | | | | | | | | | | | | | | |
|  BF175D | | | | | | | | | | | | | | | | | | | | | | | | | | | | | | | | | | | | | | | | | |
|  BF200D | | | | | | | | | | | | | | | | | | | | | | | | | | | | | | | | | | | | | | | | | |
|  BF225D | | | | | | | | | | | | | | | | | | | | | | | | | | | | | | | | | | | | | | | | | |
|  BF250D | | | | | | | | | | | | | | | | | | | | | | | | | | | | | | | | | | | | | | | | | |
| SENSOR PRESIÓN DE ACEITE | OIL PRESSURE SENSOR | SENSORE PRESIONE DELL'OLIO | CAPTEUR DE PRESSION D'HUILE | | | | | | | | | | | | | | | | | | | | | | | | | | | | | | | | | | | | | | |
| <table border="1"> <thead> <tr> <th>REF</th> <th>OEM</th> </tr> </thead> <tbody> <tr> <td>REC37260-RNA-A01</td> <td>37260-RNA-A01</td> </tr> <tr> <td> BF175D</td> <td>BF150AK2</td> </tr> <tr> <td> BF200D</td> <td>BF75DK3, DK4</td> </tr> <tr> <td> BF225D</td> <td>BF90DK4, DK5</td> </tr> <tr> <td> BF250D</td> <td>BF100A, AK1</td> </tr> <tr> <td> BF115D, DK1,</td> <td>BF80A, AK1</td> </tr> <tr> <td> BF135A4, AK2</td> <td>BFT100AK1</td> </tr> </tbody> </table>  | REF | OEM | REC37260-RNA-A01 | 37260-RNA-A01 |  BF175D | BF150AK2 |  BF200D | BF75DK3, DK4 |  BF225D | BF90DK4, DK5 |  BF250D | BF100A, AK1 |  BF115D, DK1, | BF80A, AK1 |  BF135A4, AK2 | BFT100AK1 | | | | | | | | | | | | | | | | | | | | | | | | | |
| REF | OEM | | | | | | | | | | | | | | | | | | | | | | | | | | | | | | | | | | | | | | | | |
| REC37260-RNA-A01 | 37260-RNA-A01 | | | | | | | | | | | | | | | | | | | | | | | | | | | | | | | | | | | | | | | | |
|  BF175D | BF150AK2 | | | | | | | | | | | | | | | | | | | | | | | | | | | | | | | | | | | | | | | | |
|  BF200D | BF75DK3, DK4 | | | | | | | | | | | | | | | | | | | | | | | | | | | | | | | | | | | | | | | | |
|  BF225D | BF90DK4, DK5 | | | | | | | | | | | | | | | | | | | | | | | | | | | | | | | | | | | | | | | | |
|  BF250D | BF100A, AK1 | | | | | | | | | | | | | | | | | | | | | | | | | | | | | | | | | | | | | | | | |
|  BF115D, DK1, | BF80A, AK1 | | | | | | | | | | | | | | | | | | | | | | | | | | | | | | | | | | | | | | | | |
|  BF135A4, AK2 | BFT100AK1 | | | | | | | | | | | | | | | | | | | | | | | | | | | | | | | | | | | | | | | | |

SENSOR DETONACIÓN

KNOCK SENSOR

SENSORE ANTIDETONAZIONE

CAPTEUR DE CLIQUETIS

| REF | OEM |
|------------------|---------------|
| REC30530-P8F-A01 | 30530-P8F-A01 |



new

- BF175A3, A6
- BF200A2, A3, A6
- BF225A2, A3, A6

| REF | OEM |
|------------------|---------------|
| REC30530-PNA-003 | 30530-PNA-003 |



new

- BF135A4
- BF150A4

| REF | OEM |
|------------------|---------------|
| REC30530-RNA-A01 | 30530-RNA-A01 |



new

- BF175AK1, AK2, AK3
- BF200AK1, AK2, AK3
- BF225AK1, AK2, AK3
- BF250A

SENSOR MAT TEMPERATURA DEL AIRE

SENSOR MAT, AIR TEMPERATURE

SENSORE MAT, TEMPERATURA ARIA

CAPTEUR MAT DE TEMPERATURE D'AIR

| REF | OEM |
|------------------|---------------|
| REC37880-PLC-004 | 37880-PLC-004 |



new

- BF115D, DK1
- BF135A4, AK2
- BF150A4, AK2
- BF75DK0, DK2, DK3, DK4
- BF90DK2
- BF80A, AK1
- BFT80AK1
- BF60A, AK1
- BFP60A,
- BF40D, E
- BF50D,
- BF40DK2
- BF50DK2

SENSOR OXÍGENO

O2 SENSOR

SENSORE OSSIGENO

CAPTEUR À OXYGENE

| REF | OEM |
|------------------|---------------|
| REC35668-ZY6-003 | 35668-ZY6-003 |



- BF115D, DK1
- BF135A4, AK2
- BF150A4, AK2,

| REF | OEM |
|------------------|---------------|
| REC35655-ZY3-013 | 35655-ZY3-013 |



- BF175A3, A6,
- BF200A2, A3, A6
- BF225A2, A3, A6,

| REF | OEM |
|------------------|---------------|
| REC35655-ZY9-003 | 35655-ZY9-003 |



- BF75DK0, DK2
- BF90DK0, DK2
- BF75DK0, DK2
- BF90DK0, DK2

| REF | OEM |
|------------------|---------------|
| REC35655-ZY3-C01 | 35655-ZY3-C01 |



new

- BF250A,
- BF175AK1, AK2, AK3
- BF200AK1, AK2, AK3
- BF225AK1, AK2, AK3,
- BF40D, DK2, DK4
- BF50D, DK2, DK4,

RELÉ

RELAY

RELE

RELAIS

| REF | OEM |
|------------------|------------------|
| REC38580-ZY6-013 | 38580-ZY6-013/03 |



new

- BF135A4
- BF150A4

| REF | OEM |
|-----------------|--|
| REC8580-ZY9-023 | 38580-ZY9-003/013/023 HZY-38580-003 |



new

- BF75DK0, FK2, DK3, DK4
- BF90DK0, DK2, DK4, DK5
- BF100A, AK1
- BF80A, AK1

BOBINAS

COILS

BOBINE

BOBINES

| REF | OEM |
|------------------|---------------|
| REC30520-PWC-003 | 30520-PWC-S01 |



 BF75DK0, DK2, DK3
 BF90DK0, DK2, DK4
 BF100A
 BF80A

| REF | OEM |
|------------------|---------------|
| REC30520-PNA-007 | 30520-PNA-007 |





 VTEC
 BF135A4
 BF150A4
 BF115D, DK1
 BF135A4, BF150A4,
 BF135AK2, BF150AK2

| REF | OEM |
|------------------|---------------|
| REC30580-ZV4-013 | 30580-ZV4-023 |



 BF15AH, AK, AM, B, A1, A2, AX, AY,
 B2, BX, A3
 BF9.9AH, AK, AM, B, AX, AY
 BF8C, CX

| REF | OEM |
|------------------|---------------|
| REC30520-ZVL-003 | 30520-ZYL-003 |





 B175D
 BF200D
 BF225D
 BF250D

new

| REF | OEM |
|------------------|---------------------------------|
| REC30520-ZX2-003 | 30520-ZX2-003 HZX2-30520-003 |





 B175AK3
 BF200AK3
 BF225AK3
 BF250A

new

| REF | OEM |
|------------------|--------------|
| REC30520-ZY3-003 | 30520-Z3-003 |



 B175A3, A6, AK1, AK2
 BF200A2, A3, A6, AK1, AK2
 BF225A2, A3, A6, AK1

new

BUJÍAS

SPARK

CANDELE

BOUGIES

| | | REF NGK | | | REF NGK |
|-----------|---------|------------|-----------|---------|---------------|
| BF2D | 1999 | NGKCR5HSB | BF25D4 | 2004 | NGKDR7EA |
| BF2/A | 1984 | NGKBMR4A | BF28 | | NGKCR5HSB |
| BF2B | | NGKCR5HSB | BF28D | | NGKCR5HSB |
| BF2.3 | | NGKCR5HSB | BF30/A | 1994 | NGKDR7EA |
| BF4.5B | | NGKBPR5ES | BF30D4 | 2004 | NGKDR7EA |
| BF5AK | | NGKBPR5ES | BF35/A | 1990 | NGKDR7EA |
| BF5 | 1984 | NGKBPR5ES | BF40B | | NGKDR7EA |
| BF5A | | NGKBPR5ES | BF40/A | 1994 | NGKDR7EA |
| BF6B | 2003 | NGKDR4HS | BF45/A | 1990 | NGKDR7EA |
| BF6 | | NGKDR4HS | BF50/F | 1985-94 | NGKBPR5ES |
| BF6CH | 2004 | NGKCR5EH-9 | BF50 | 1986-94 | NGKBPR5ES |
| BF7,5 | 1977 | NGKDR5HS | BF50/A | 1994 | NGKDR7EA |
| BF8 | 2001 | NGKCR5EH-9 | BF60A | | NGKLMAR6C-9 |
| BF8D | | NGKCR5EH-9 | BF70A | | NGKDR7EA |
| BF8D1 | 2001 | NGKCR5EH-9 | BF75 | 2003 | NGKDR7EA |
| BF8 | 1987-00 | NGKDR5HS | BF75B | | NGKDR7EA |
| BF8 A/B/C | 1990-00 | NGKDR5HS | BF75D | | NGKIZFR6K-11E |
| BF8B1 | | NGKCR5EH-9 | BF75E | | NGKDR5HS |
| BF9/A | | NGKDR5HS | BF75A | 1995 | NGKDR7EA |
| BF9.9 | 1987-01 | NGKDR5HS | BF75 | | NGKDR5HS |
| BF9.9 A/B | | NGKDR5HS | BF90/A | 1995 | NGKDR7EA |
| BF9.9D1 | 2001 | NGKCR5EH-9 | BF90D | | NGKIZFR6K-11E |
| BF10D | 2001 | NGKCR5EH-9 | BF100E | | NGKDR5HS |
| BF10/B1 | 2001 | NGKCR5EH-9 | BF100 | | NGKDR5HS |
| BF15D | 2003 | NGKCR5EH-9 | BF115/A | 1998 | NGKZFR7F |
| BF15B | | NGKDR5HS | BF130A | 1998 | NGKZFR7F |
| BF15 | 1987-90 | NGKDR6HS | BF135A | | NGKIZFR6K11 |
| BF15A | 1996-02 | NGKDR5HS | BF150A | | NGKIZFR6K11 |
| BF20 | 1993 | NGKDR7EA | BF175A | | NGKIZFR6K11 |
| BF20/F | 1985 | NGKBMR4A | BF200A V6 | 2002 | NGKIZFR6K11 |
| BF20D | 2003 | NGKCR5EH-9 | BF225A V6 | 2002 | NGKIZFR6K11 |
| BF25/A | 1993 | NGKDR7EA | BF250A | 2010 | NGKIZFR6K11 |
| BF25B | | NGKDR7EA | | | |



| | | REF CHAMPION |
|-------|----------------------|-----------------|
| 2HP | BF2A,D | CHACJ14 |
| 5HP | OHC - BF5A | CHARN11YC4 |
| 7.5HP | B75 | CHAP10Y |
| 8.0HP | OHC - BF8A | CHAP10Y |
| 9.9HP | BF9.9A | CHAP10Y |
| 15HP | OHC - BF15A | CHAP8Y |
| 20HP | BF20A | CHARA6HC |
| 25HP | OHC - BF25A | CHARA8HC |
| 30HP | OHC - BF30A | CHARA8HC |
| 35HP | BF35A | CHARA8HC |
| 40HP | OHC - BF40A | CHARA8HC |
| 45HP | BF45A | CHARA8HC |
| 50HP | OHC - BF50A | CHARA8HC |
| 70HP | OHC - BF70A | CHARA8HC |
| 75HP | BF75A | CHARA8HC |
| 90HP | OHC - BF90A | CHARA8HC |
| 115HP | OHC | CHARC9MC4 |
| 130HP | OHC | CHARC9MC4 |
| 150HP | BF150, BF200, 225 | CHARC9MC4 |



MOTORES DE ARRANQUE



STARTERS

MOTORINI AVVIAMENTO

DEMARREURS



MOTORES DE ARRANQUE

STARTERS

| REF | OEM |  |  |
|------------------|--------------------------------|---|---|
| REC31200-ZW9-802 | 31200-ZW9-802 31200-ZW9-801 | 12V | 11 CCW |



- BF8B2, D2, D3, D4
- BFP8B2, D2, D3, DK2
- BF9,9DK2, D3
- BF10D4, DK2, OB2,
- BFP10B2, D2,
- BFP9,9D3,



| REF | OEM |  |  |
|------------------|---|---|---|
| REC31200-ZY6-003 | 31200-ZY6-003 31200-ZY9-003 31200-ZY9A-0031 | 12V 1.00 KW | 9 CW |

- BF115D, DK1
- BF135A4, AK2
- BF150A4, AK2
- BF75DK0, DK2
- BF90DK2, DK0



| REF | OEM |  |  |
|------------|---------------|---|---|
| PH130-0064 | 31200-ZW1-004 | 12V 1.4 KW | 13 CW |



- BF75A1, A2, A3, AT, AV, AX,
- BF90A1, A2, A3, AT, 90AV, AX



| REF | OEM |  |  |
|------------|---------------|---|---|
| PH130-0065 | 31200-ZW5-003 | 12V 1.4 KW | 13 CW |



- BF115A1, A2, A3, AX,
- BF130A1, A2, A3, AX,



| REF | OEM |  |  |
|------------|--------------------------------|---|---|
| PH130-0054 | 31200-ZV5-013 31200-ZV5-003 | 12V 0.9 KW | 9 CW |

- BF35AM,
- BF40B, BX, AX, A1, A2, A3, A4, A'
- BF45AM, A, A1,
- BF50A, A1, A2, A3, A4, AX, AY,



| REF | OEM |  |  |
|------------|----------------------------------|---|---|
| PH130-0070 | 31200-ZY3-003 31200-ZY3A-0034 | 12V 1.7 KW | 9 CW |

- BF175D, A3, A6, AK1, AK2, AK3
- BF200D, A2, A3, A6, AK1, AK2, AK3
- BF225D, A2, A3, A6
- BF250D, A, AK1, AK2, AK3



GUÍA DE ARRANQUE

STARTER GUIDE

GUIDE AVVIAMENTO

GUIDE DE DÉMARREURS



| | | |
|-------|-----------|------------------|
| BF8 | 2001 | REC31200-ZW9-802 |
| BF10 | 2001 | REC31200-ZW9-802 |
| BF9,9 | 2001 | REC31200-ZW9-802 |
| BF35 | 1995-1997 | PH130-0054 |
| BF40 | 1995 | PH130-0054 |
| BF45 | 1995-1997 | PH130-0054 |
| BF50 | 1995 | PH130-0054 |
| BF75 | 2007 | REC31200-ZY6-003 |
| BF75 | 1997-2006 | PH130-0064 |
| BF90 | 1997-2006 | PH130-0064 |



| | | | |
|-------|-----------|------------------|------------------|
| BF90 | 2007 | REC31200-ZY6-003 | |
| BF115 | 1999-2006 | PH130-0065 | REC31630-ZW5-003 |
| BF115 | 2007 | REC31200-ZY6-003 | REC31630-ZY6-003 |
| BF130 | 1999-04 | PH130-0065 | REC31630-ZW5-003 |
| BF135 | 2004 | REC31200-ZY6-003 | REC31630-ZY6-003 |
| BF150 | 2004 | REC31200-ZY6-003 | REC31630-ZY6-003 |
| BF175 | 2002 | PH130-0070 | REC31630-ZY3-003 |
| BF200 | 2002 | PH130-0070 | REC31630-ZY3-003 |
| BF225 | 2002 | PH130-0070 | REC31630-ZY3-003 |
| BF250 | 2012 | PH130-0070 | REC31630-ZY3-003 |

DESCONECTORES DE SEGURIDAD

CUT OFF SWITCHES

CHIAVETTA DI SICUREZZA

COUPE CIRCUIT DE SECURITE

DESCONECTOR DE SEGURIDAD

Interruptor de encendido para motores. Aísla los circuitos en unidades dobles para prevenir el retorno al alternador.

IGNITION KILL SWITCHES

Emergency and stop switch. Isolates circuits on dual units to prevent feedback.

INTERRUTTORE DI STOP

Interruttore di accensione per motori. Isola i circuiti in doppie unità per prevenire il ritorno all'alternatore.

COUPE CIRCUIT DE SECURITE

Interrupteur d'arrêt d'urgence. Il isole les circuits en double pour éviter le retour à l'alternateur.

| REF | | | | | |
|---------|-----------------|-----------------|-----------------|--------------------|---|
| THKS-1 | Un fueraborda | Single outboard | Un fuoribordo | Un hors-bord | 1 |
| THKS-2 | Un intraborda | Single I/O | Un entrobordeo | Un inboard | 1 |
| THKS-12 | Dos fuerabordos | Dual outboard | Due fuoribordo | Deux hors-bord | 1 |
| THKS-22 | Dos intrabordos | Dual I/O | Due entrobordeo | Deux inboard | 1 |
| THL-4 | Cuerda recambio | Spare lanyard | Corde ricambio | Cordon de rechange | 1 |



KITS

Interruptor de encendido para todo tipo de motores fueraborda o intraborda

KITS

Emergency and stop switch for inboard or outboards.

KIT

Interruttore di accensione per tutti i tipi di motori fuoribordo o entrobordeo.

KITS

Coupe circuit de sécurité pour moteur inboard ou hors-bord

| REF KIT | CUERDA WIRE CORDA CORDON | |
|----------|--------------------------------|---|
| REC40970 | REC40990 | 1 |



| REF KIT | CUERDA WIRE CORDA CORDON | |
|---------|--------------------------------|---|
| GS11290 | GS11291 | 1 |



| REF KIT | |
|---------|---|
| GS11292 | 1 |



| REF | |
|---------|---|
| GS11294 | 1 |



| REF | OEM |
|------------------|--|
| REC36180-ZV5-033 | 36180-ZV5-033 36180-ZV5-023 36180-ZV5-013 36180-ZV5-003 |

BF8-->BF250

ALTERNADOR

ALTERNATOR

ALTERNATORE

ALTERNATEUR

ALTERNADOR

ALTERNATOR

ALTERNATORE

ALTERNATEUR

| REF | OEM | | |
|------------------|--------------------------------|------------|--------------------|
| REC31630-ZY6-003 | 31630-ZY6-003 31630-ZY6-013 | 12V 55A | REC31638-ZY6-003 4 |

BF115D, DK1,
BF135A4, AK2
BF150A4, AK2

| REF | OEM | | |
|------------------|---------------|------------------|---|
| REC31630-ZY3-003 | 31630-ZY3-003 | REC31638-ZY3-003 | 6 |

BF250A,
BF175A3, A6, AK1, AK2, AK3, D
BF200A2, A3, A6, AK1, AK2, AK3, D
BF225A2, A3, A6, AK1, AK2, AK3, D
BF250D, A,

| REF | OEM | ⚡ | ⚙️ |
|------------------|---------------|---------------|----|
| REC31630-ZW5-003 | 31630-ZW5-003 | 12V 55A CW | 4 |

new



 BF115A1, A2, A3, AX
 BF130A1, A2, A3, A4, AX



CORREAS DE ALTERNADOR **ALTERNATOR BELT** **CURROIA ALTERNATORE** **COURROIE D'ALTERNATEUR**

| REF | OEM |
|------------------|---------------|
| REC31638-ZY3-003 | 31638-ZY3-003 |

new



 BF175A3, A6, AK1, AK2, AK3, D,
 BF200A2, A3, A6, AK1, AK2, AK3, D,
 BF225A2, A3, A6, AK1, AK2, AK3, D,
 BF250D



| REF | OEM |
|------------------|---------------|
| REC31638-ZY6-003 | 31638-ZY6-003 |

new

 F115D,
 BF115D, DK1,
 BF135A4, AK2
 BF150A4, AK2



TRIM, TILT & POWER TRIM

INSTALACIÓN ELÉCTRICA **WIRING HARNESS** **INSTALLAZIONE ELETTRICA** **INSTALLATION ELECTRIQUE**

KIT CONVERSIÓN **CONVERSION KIT** **KIT CONVERSIONE** **KIT DE CONVERSION.**
 Sustituye de 2 a 3 cables. Converte 3-wire Tilt and Trim motors to 2-Wire design Sostituisce da 2 a 3 cavi. Passe un faisceau de 2 à 3 fils

| REF |
|------------|
| PH200-WH01 |



TRIM COMPLETO **COMPLETE TRIM ASSEMBLY** **MOTORINO TRIM COMPLETO** **MOTEUR DE TRIM**

| REF | OEM | ⚡ | ⚙️ | ✂️ |
|------------|---------------|-----|----|----|
| PH200-T046 | 36120-ZV5-822 | 12V | 4 | 2 |

 BF40, BF50 (2002-03)



| REF | OEM | ⚡ | ⚙️ | ✂️ |
|------------|---------------|-----|----|----|
| PH200-T021 | 36120-ZV5-821 | 12V | 4 | 2 |

 BF35AM
 BF40B, B2, BX, A, A1, A2, AX, AY
 BF45AM
 BF50A, A1, A2, AX, AY



| REF | OEM | ⚡ | 🔩 | 🔧 |
|------------------|---------------|-----|---|---|
| REC36120-ZY3-013 | 36120-ZY3-013 | 12V | 4 | |

 BF175A3, A6, AK1, AK2
 BF200A2, A3, A6, AK2
 BF225A2, A3, A6, AK1, AK2,





| REF | OEM | ⚡ | 🔩 | 🔧 |
|------------------|---------------|-----|---|---|
| REC36120-ZW4-H12 | 36120-ZW4-H12 | 12V | 4 | |

 BF40A4,
 BF50A4,
 BF40D, DK2, DK4
 BF50D, DK2, DK4





| REF | OEM | ⚡ | 🔩 | 🔧 |
|------------------|--------------------------------|-----|---|---|
| REC36120-ZY6-013 | 36120-ZY6-013 36120-ZY6-023 | 12V | 4 | |

 BF115D, DK1
 BF135A4, AK2
 BF150A4, AK2



| REF | OEM | ⚡ | 🔩 | 🔧 |
|------------------|--------------------------------|-----|---|---|
| REC36120-ZY9-003 | 36120-ZY9-003 36120-ZY9-013 | 12V | 4 | |

 BF75DK0, DK2, DK3
 BF90DK0, DK2, DK4
 BF100A
 BF80A



POWER TRIM COMPLETO **COMPLETE POWER TRIM ASSEMBLY** **MOTORINO POWER TRIM COMPLETO** **POWER TRIM COMPLET**

| REF |
|------------|
| REC18-6865 |



 3 RAM
 115-225HP
 BF115+
 SHOWA SYSTEM





RELÉ DE POWER TRIM **POWER TRIM RELAY** **RELE POWER TRIM** **RELAIS POWER TRIM**

| REF | OEM |
|------------------|---------------------------------|
| REC38550-ZY6-003 | 38550-ZY6-003 HZY-638550-003 |

 BF115D, DK1
 BF135A4, AK2
 BF150A4, AK2



| REF | OEM |
|------------------|---------------|
| REC38550-ZV5-823 | 38550-ZV5-823 |

 BF40B2,A4,A2,A3
 BF50A4,A2

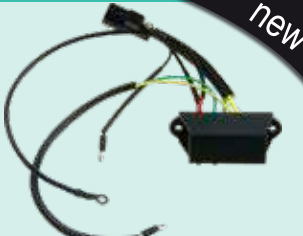

EXTRACTOR TAPONES TRIM **TRIM PLUGS EXTRACTOR** **ESTRATTORE PER TAPPI DI TRIM** **KIT EXTRACTEUR DE BOUCHONS TRIM**

| REF | RECTOOLTRIMKIT |
|-----|--|
| | RECTOOLTRIM1 + RECTOOLTRIM2 + RECTOOLTRIM3 |



| REF | 🔧 | A |
|--------------|----------------------------|-------|
| RECTOOLTRIM1 | 1/2" + RECPIN4 + RECPIN4.5 | 38 mm |
| RECTOOLTRIM2 | 1/2" + RECPIN4 + RECPIN4.5 | 32 mm |
| RECTOOLTRIM3 | 1/2" + RECPIN6 | 35 mm |



| TRIM PISTON | TILT PISTON | 🔧 |
|--------------|--------------|--------------------|
| RECTOOLTRIM2 | RECTOOLTRIM3 | 75 --> 225 (1997+) |

REF

| | |
|-----------|----------------|
| RECPIN4 | 3 PIN x 4 mm |
| RECPIN4.5 | 3 PIN x 4.5 mm |
| RECPIN6 | 3 PIN x 6 mm |



Los pines de repuesto no tienen garantía.
 Replacement pins are not guaranteed.
 I pèrni di ricambio non sono garantiti.
 Les pines de remplacement ne sont pas garanties

SISTEMA DE GOBIERNO STEERING SYSTEM

SISTEMA DI GUIDA SYSTÈME DE COMMANDE

MANDOS DE CONTROL

ENGINE CONTROLS

COMANDI DI CONTROLLO

BOITIER DE COMMANDE

MANDO LATERAL

SIDE CONTROL

COMANDO LATERALE

BOITIER LATERAL

| REF | OEM | POWER TRIM |
|------------------|---|------------|
| REC24800-ZZ5-A02 | 24800-ZZ5-A02 24800-ZZ5-A01 24800-ZZ5-A22 | ✓ |

RECMAR

(NHK MEC) BF40 --> BF250
EFI
4 LED



MANDO PARA CONSOLA

CONSOLE CONTROL

COMANDO PER CONSOLLA

BOITIER POUR CONSOLE

| REF | RO OEM | TRIM TILT |
|------------------|---------------------------------|-----------|
| REC06240-ZW5-U40 | 06240-ZW5-U40 06240-ZW5-U001 | ✓ |

| REF | RO OEM | TRIM TILT |
|------------------|---------------|-----------|
| REC06240-ZW5-U60 | 06240-ZW5-U60 | ✓ |

BF40 --> BF250

RECMAR



new

**INTERRUPTOR DE TRIM
MANDOS LATERALES**

**TRIM SWITCH
SIDE CONTROLS**

**INTERRUTTORE TRIM
COMANDO LATERALE**

**INTERRUPTEUR TRIM
BOITIER LATERAL**

| REF | OEM |
|------------------|---------------|
| REC35370-ZZ5-D02 | 35370-ZZ5-D02 |

DF8 --> DF250



new

| REF | OEM |
|------------------|---------------|
| REC35340-ZZ5-D21 | 35340-ZZ5-D21 |

DF40-->DF250
(2007+)



new

**INTERRUPTOR DE TRIM
MANDOS CONSOLA**

**TRIM SWITCH
CONTROLS**

**INTERRUTTORE TRIM
PANELLO**

**INTERRUPTEUR TRIM
CONSOLE**

| REF | OEM |
|------------------|---------------|
| REC35370-ZW5-U02 | 35370-ZW5-U02 |

A



new

| REF | OEM |
|------------------|---------------|
| REC35370-ZW5-U12 | 35370-ZW5-U12 |

B BF25 --> BF250



new

**LLAVES ARRANQUE
IGNITION STARTER
SWITCH**

**CHIAVI DI
ACCENSIONE**

CONTACTEUR A CLÉ

| REF | OEM |
|------------------|---------------|
| REC35100-ZV5-013 | 35100-ZV5-013 |

BF8 --> BF250



new

**CABLES DE
CONTROL**

CONTROL CABLES

CAVI COMANDO

**CÂBLES DE
COMMANDE**

Recorrido trabajo: 76 mm.
Rosca 10-32"

Travel 3"
Threaded 10-32"

Estensione 76 mm
Filetto 10-32"

Course: 76 mm.
Fil 10-32

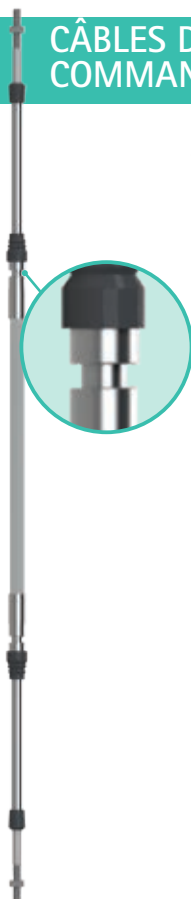
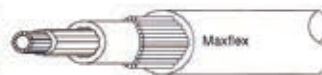

maxflex



| REF | RO |  |
|------------|---------------|---|
| PRE3300C05 | 24911-ZW7-U01 | 5' / 1,52 m |
| PRE3300C06 | 24912-ZW7-U01 | 6' / 1,83 m |
| PRE3300C07 | 24913-ZW7-U01 | 7' / 2,13 m |
| PRE3300C08 | 24914-ZW7-U01 | 8' / 2,45 m |
| PRE3300C09 | 24915-ZW7-U01 | 9' / 2,75 m |
| PRE3300C10 | 24916-ZW7-U01 | 10' / 3,05 m |
| PRE3300C11 | 24917-ZW7-U01 | 11' / 3,35 m |
| PRE3300C12 | 24918-ZW7-U01 | 12' / 3,65 m |
| PRE3300C13 | 24919-ZW7-U01 | 13' / 3,95 m |
| PRE3300C14 | 24920-ZW7-U01 | 14' / 4,25 m |
| PRE3300C15 | 24921-ZW7-U01 | 15' / 4,60 m |
| PRE3300C16 | 24922-ZW7-U01 | 16' / 4,90 m |
| PRE3300C17 | 24923-ZW7-U01 | 17' / 5,20 m |
| PRE3300C18 | 24924-ZW7-U01 | 18' / 5,50 m |

| REF | RO |  |
|------------|---------------|--|
| PRE3300C19 | 24925-ZW7-U01 | 19' / 5,80 m |
| PRE3300C20 | 24926-ZW7-U01 | 20' / 6,10 m |
| PRE3300C21 | 24927-ZW7-U01 | 21' / 6,40 m |
| PRE3300C22 | 24928-ZW7-U01 | 22' / 6,70 m |
| PRE3300C23 | 24929-ZW7-U01 | 23' / 7,00 m |
| PRE3300C24 | 24930-ZW7-U01 | 24' / 7,30 m |
| PRE3300C25 | 24931-ZW7-U01 | 25' / 7,60 m |
| PRE3300C26 | 24932-ZW7-U01 | 26' / 7,90 m |
| PRE3300C27 | 24933-ZW7-U01 | 27' / 8,25 m |
| PRE3300C28 | 24934-ZW7-U01 | 28' / 8,55 m |
| PRE3300C29 | 24935-ZW7-U01 | 29' / 8,85 m |
| PRE3300C30 | 24936-ZW7-U01 | 30' / 9,15 m |
| PRE3300C31 | 24937-ZW7-U01 | 31' / 9,45 m |
| PRE3300C32 | 24938-ZW7-U01 | 32' / 9,75 m |

HONDA

RECAMBIOS
MARINOS

SISTEMA DE REFRIGERACIÓN COOLING SYSTEM

SISTEMA DI RAFFREDDAMENTO SYSTEME DE REFROIDISSEMENT

TERMOSTATO

THERMOSTAT

TERMOSTATO

THERMOSTAT

TERMOSTATOS

THERMOSTATS

TERMOSTATO

THERMOSTATS

| REF | OEM | °C |
|------------------|---------------|------|
| REC19300-881-761 | 19300-881-761 | 52°C |

- BF4.5B, BX, BK2, B2, B4, B6, BKO
- BF5AH, AK, AM, AX, AK2, A2, A3, A4
- BF15AH, AK, AM, B, A1, A2, A3, AX, AY, B2, BX
- F6B, BX
- BF8AX, B, BX, C, CX, AH, AK, AM
- BF100F
- BF75F
- BF9.9AH, AK, AM, B, AX, BX, AY



| REF | OEM | °C |
|----------------|---|------|
| PAF15-07000031 | 19300-ZW9-003 19300-881-741 19300-921-003 | 60°C |

- BF25D4, DK2
- BF30D4, DK2
- BF40A, D, DK2, E
- BF50A, D, DK2
- BF8B1, B2, D1, D2, DK2, D3, D4
- BF9.9DK2, D1, D2, D3
- BF10B1, B1, D4, DK2, B2, D2
- BF15D3, DK2
- BF20D3
- BF200A
- BF225A
- BF75DK0, DK2, DK3
- BF90DK0, DK2, DK4
- BF100A
- BF80A
- BF60A, AK1



| REF | OEM | °C |
|-----------------|---------------|------|
| REC67F-12411-01 | 19300-ZX2-003 | 60°C |

- BF175D,
- BF200D,
- BF225D,
- BF250A, D



| REF | OEM | °C |
|------------------|---|------|
| REC19300-ZV5-043 | 19300-ZV5-003, 19300-ZV5-013, 19300-ZV5-023, 19300-ZV5-033, 19300-ZV5-043 | 72°C |

- BF35AM
- BF40B, B2, BX, AX, A1, A2,
- A3, AY
- BF45AM
- BF20AX, A
- BF25A, A1, AX
- BF30A, A1, AX, A2, A3
- BF75A1, AT, AV, AX, A2, A3
- BF90A1, AT, AV, AX, A2, A3
- BF115A1, A2, AX
- BF130A1, A2, AX
- BF50A2, AX, A1, A3, AY
- BF20A2, A3
- BF25A1, A2, A3



| REF | OEM | °C |
|-----------------|---------------|------|
| REC6E5-12411-30 | 19300-ZY6-003 | 50°C |

- BF75DK0, DK2, DK3, DK4
- BF80A, AK1
- BF90DK0, DK2, DK4, DK5
- BF100A, AK1
- BF115D, DK1
- BF135A4, AK2
- BF150A4, AK2
- BF780AK1
- BFT100AK1



| REF | OEM | °C |
|-----------------|---------------|------|
| REC6AH-12411-00 | 19300-ZY3-023 | 60°C |

- BF115A2, A3, D, DK1,
- BF130A2, A3,
- BF135A4, AK2,
- BF150A4, AK2,
- BF175A3, A6, AK1, AK2, AK3,
- BF200A2, A3, A6, AK1, AK2, AK3,
- BF225A2, A3, A6, AK1, AK2, K3,



GUÍA TERMOSTATO

THERMOSTAT GUIDE

GUIDA TERMOSTATO

GUIDE DES THERMOSTATS

| REF | REF |
|----------|------------------|
| B75K2 | PAF15-07000031 |
| B75K3 | PAF15-07000031 |
| BD115DK1 | REC6E5-12411-30 |
| BD130A2 | REC19300-ZV5-043 |
| BF100A | PAF15-07000031 |
| BF100A | PAF15-07000031 |
| BF100A | REC6E5-12411-30 |
| BF100AK1 | PAF15-07000031 |
| BF100AK1 | REC6E5-12411-30 |
| BF100B | PAF15-07000031 |
| BF100C | PAF15-07000031 |
| BF100D | PAF15-07000031 |
| BF100E | PAF15-07000031 |
| BF100F | PAF15-07000031 |
| BF100F | REC19300-881-761 |
| BF10B1 | PAF15-07000031 |
| BF10B2 | PAF15-07000031 |
| BF10D1 | PAF15-07000031 |

| REF | REF |
|----------|------------------|
| BF10D2 | PAF15-07000031 |
| BF10D4 | PAF15-07000031 |
| BF10DK2 | PAF15-07000031 |
| BF115A1 | REC19300-ZV5-043 |
| BF115A2 | REC19300-ZV5-043 |
| BF115A2 | REC6AH-12411-00 |
| BF115A3 | REC6AH-12411-00 |
| BF115D | REC6AH-12411-00 |
| BF115D | REC6E5-12411-30 |
| BF115DK1 | REC6AH-12411-00 |
| BF130A1 | REC19300-ZV5-043 |
| BF130A2 | REC6AH-12411-00 |
| BF130A3 | REC6AH-12411-00 |
| BF130AX | REC19300-ZV5-043 |
| BF135A4 | REC6AH-12411-00 |
| BF135A4 | REC6E5-12411-30 |
| BF135AK2 | REC6AH-12411-00 |
| BF135AK2 | REC6E5-12411-30 |

| REF | REF |
|----------|------------------|
| BF150A4 | REC6AH-12411-00 |
| BF150A4 | REC6E5-12411-30 |
| BF150AK2 | REC6AH-12411-00 |
| BF150AK2 | REC6E5-12411-30 |
| BF15A1 | REC19300-881-761 |
| BF15A2 | REC19300-881-761 |
| BF15A3 | REC19300-881-761 |
| BF15AH | REC19300-881-761 |
| BF15AK | REC19300-881-761 |
| BF15AM | REC19300-881-761 |
| BF15AX | REC19300-881-761 |
| BF15AY | REC19300-881-761 |
| BF15B2 | REC19300-881-761 |
| BF15BX | REC19300-881-761 |
| BF15D3 | PAF15-07000031 |
| BF15DK2 | PAF15-07000031 |
| BF15DK3 | PAF15-07000031 |
| BF175A3 | REC6AH-12411-00 |

| REF | REF |
|----------|------------------|
| BF175A6 | REC6AH-12411-00 |
| BF175AK1 | REC6AH-12411-00 |
| BF175AK2 | REC6AH-12411-00 |
| BF175AK3 | REC6AH-12411-00 |
| BF175D | REC67F-12411-01 |
| BF200A2 | PAF15-07000031 |
| BF200A2 | REC6AH-12411-00 |
| BF200A3 | REC6AH-12411-00 |
| BF200A6 | REC6AH-12411-00 |
| BF200AK1 | REC6AH-12411-00 |
| BF200AK2 | REC6AH-12411-00 |
| BF200AK3 | REC6AH-12411-00 |
| BF200D | REC67F-12411-01 |
| BF20A | REC19300-ZV5-043 |
| BF20A2 | REC19300-ZV5-043 |
| BF20AX | REC19300-ZV5-043 |
| BF20D3 | PAF15-07000031 |
| BF20DK2 | PAF15-07000031 |

| REF | REF |
|----------|------------------|
| BF20DK3 | PAF15-07000031 |
| BF225A2 | PAF15-07000031 |
| BF225A2 | REC6AH-12411-00 |
| BF225A3 | REC6AH-12411-00 |
| BF225A6 | REC6AH-12411-00 |
| BF225AK1 | REC6AH-12411-00 |
| BF225AK2 | REC6AH-12411-00 |
| BF225AK3 | REC6AH-12411-00 |
| BF225D | REC67F-12411-01 |
| BF250A | REC67F-12411-01 |
| BF250D | REC67F-12411-01 |
| BF25A | REC19300-ZV5-043 |
| BF25A1 | REC19300-ZV5-043 |
| BF25A2 | REC19300-ZV5-043 |
| BF25A3 | REC19300-ZV5-043 |
| BF25AX | REC19300-ZV5-043 |
| BF25D4 | PAF15-07000031 |
| BF25DK2 | PAF15-07000031 |
| BF30A | REC19300-ZV5-043 |
| BF30A1 | REC19300-ZV5-043 |
| BF30A2 | REC19300-ZV5-043 |
| BF30A3 | REC19300-ZV5-043 |
| BF30AX | REC19300-ZV5-043 |
| BF30D4 | PAF15-07000031 |
| BF30DK2 | PAF15-07000031 |
| BF35AM | REC19300-ZV5-043 |
| BF4,5B | REC19300-881-761 |
| BF4,5B2 | REC19300-881-761 |
| BF4,5B4 | REC19300-881-761 |
| BF4,5B6 | REC19300-881-761 |
| BF4,5BK0 | REC19300-881-761 |
| BF4,5BK2 | REC19300-881-761 |
| BF4,5BK | REC19300-881-761 |
| BF4,9DH | REC19300-881-761 |
| BF40A | REC19300-ZV5-043 |
| BF40A1 | REC19300-ZV5-043 |
| BF40A2 | REC19300-ZV5-043 |
| BF40A3 | REC19300-ZV5-043 |
| BF40A4 | PAF15-07000031 |
| BF40AX | REC19300-ZV5-043 |
| BF40AY | REC19300-ZV5-043 |

| REF | REF |
|---------|------------------|
| BF40B | REC19300-ZV5-043 |
| BF40B2 | REC19300-ZV5-043 |
| BF40BX | REC19300-ZV5-043 |
| BF40D | PAF15-07000031 |
| BF40DK2 | PAF15-07000031 |
| BF40DK4 | PAF15-07000031 |
| BF40E | PAF15-07000031 |
| BF45AM | REC19300-ZV5-043 |
| BF4AH | REC19300-881-761 |
| BF50A | REC19300-ZV5-043 |
| BF50A1 | REC19300-ZV5-043 |
| BF50A2 | REC19300-ZV5-043 |
| BF50A3 | REC19300-ZV5-043 |
| BF50A4 | PAF15-07000031 |
| BF50AX | REC19300-ZV5-043 |
| BF50AY | REC19300-ZV5-043 |
| BF50D | PAF15-07000031 |
| BF50DK2 | PAF15-07000031 |
| BF50DK4 | PAF15-07000031 |
| BF50F | REC19300-881-761 |
| BF5A1 | REC19300-881-761 |
| BF5A2 | REC19300-881-761 |
| BF5A3 | REC19300-881-761 |
| BF5A4 | REC19300-881-761 |
| BF5AH | REC19300-881-761 |
| BF5AK | REC19300-881-761 |
| BF5AK2 | REC19300-881-761 |
| BF5AM | REC19300-881-761 |
| BF5AX | REC19300-881-761 |
| BF5DH | REC19300-881-761 |
| BF60A | PAF15-07000031 |
| BF60AK1 | PAF15-07000031 |
| BF6AH | REC19300-881-761 |
| BF6B | REC19300-881-761 |
| BF6BX | REC19300-881-761 |
| BF6D6 | PAF15-07000031 |
| BF75A | PAF15-07000031 |
| BF75A1 | REC19300-ZV5-043 |
| BF75A2 | REC19300-ZV5-043 |
| BF75A3 | REC19300-ZV5-043 |
| BF75AT | REC19300-ZV5-043 |

| REF | REF |
|---------|------------------|
| BF75AV | REC19300-ZV5-043 |
| BF75AX | REC19300-ZV5-043 |
| BF75B | PAF15-07000031 |
| BF75C | PAF15-07000031 |
| BF75D | PAF15-07000031 |
| BF75D | PAF15-07000031 |
| BF75DK0 | REC6E5-12411-30 |
| BF75DK2 | PAF15-07000031 |
| BF75DK2 | REC6E5-12411-30 |
| BF75DK3 | PAF15-07000031 |
| BF75DK3 | REC6E5-12411-30 |
| BF75DK4 | PAF15-07000031 |
| BF75DK4 | REC6E5-12411-30 |
| BF75DK0 | PAF15-07000031 |
| BF75E | PAF15-07000031 |
| BF75F | PAF15-07000031 |
| BF75F | REC19300-881-761 |
| BF80A | PAF15-07000031 |
| BF80A | REC6E5-12411-30 |
| BF80AK1 | PAF15-07000031 |
| BF80AK1 | REC6E5-12411-30 |
| BF8AH | PAF15-07000031 |
| BF8AH | REC19300-881-761 |
| BF8AK | REC19300-881-761 |
| BF8AM | PAF15-07000031 |
| BF8AM | REC19300-881-761 |
| BF8AX | REC19300-881-761 |
| BF8B | REC19300-881-761 |
| BF8B1 | PAF15-07000031 |
| BF8B2 | PAF15-07000031 |
| BF8BX | REC19300-881-761 |
| BF8C | REC19300-881-761 |
| BF8CX | REC19300-881-761 |
| BF8D1 | PAF15-07000031 |
| BF8D2 | PAF15-07000031 |
| BF8D3 | PAF15-07000031 |
| BF8D4 | PAF15-07000031 |
| BF9,9AH | REC19300-881-761 |
| BF9,9AK | REC19300-881-761 |
| BF9,9AM | REC19300-881-761 |
| BF9,9AX | REC19300-881-761 |

| REF | REF |
|-----------|------------------|
| BF9,9AY | REC19300-881-761 |
| BF9,9B | REC19300-881-761 |
| BF9,9BX | REC19300-881-761 |
| BF9,9D1 | PAF15-07000031 |
| BF9,9D2 | PAF15-07000031 |
| BF9,9D3 | PAF15-07000031 |
| BF9,9DK2 | PAF15-07000031 |
| BF90A1 | REC19300-ZV5-043 |
| BF90A2 | REC19300-ZV5-043 |
| BF90A3 | REC19300-ZV5-043 |
| BF90AT | REC19300-ZV5-043 |
| BF90AV | REC19300-ZV5-043 |
| BF90AX | REC19300-ZV5-043 |
| BF90DK2 | PAF15-07000031 |
| BF90DK2 | REC6E5-12411-30 |
| BF90DK4 | PAF15-07000031 |
| BF90DK4 | REC6E5-12411-30 |
| BF90DK5 | PAF15-07000031 |
| BF90DK0 | PAF15-07000031 |
| BF90DK0 | REC6E5-12411-30 |
| BF990DK5 | REC6E5-12411-30 |
| BFDK2 | PAF15-07000031 |
| BFP10B1 | PAF15-07000031 |
| BFP10B2 | PAF15-07000031 |
| BFP10D1 | PAF15-07000031 |
| BFP10D2 | PAF15-07000031 |
| BFP60A | PAF15-07000031 |
| BFP60AK1 | PAF15-07000031 |
| BFP8B1 | PAF15-07000031 |
| BFP8B2 | PAF15-07000031 |
| BFP8D2 | PAF15-07000031 |
| BFP8D3 | PAF15-07000031 |
| BFP9,9D1 | PAF15-07000031 |
| BFP9,9D2 | PAF15-07000031 |
| BFP9,9D3 | PAF15-07000031 |
| BFPD1 | PAF15-07000031 |
| BFT100AK1 | PAF15-07000031 |
| BFT100AK1 | REC6E5-12411-30 |
| BFT80AK1 | PAF15-07000031 |
| BFT80AK1 | REC6E5-12411-30 |

IMPULSORES IMPELLERS GIRANTE TURBINES

IMPULSORES IMPELLER GIRANTE TURBINES







| REF | OEM |
|------------------|---------------|
| REC19210-ZV4-651 | 19210-ZV4-651 |



 BF8C, CX
 BF9,9AM, AX, B, BX
 BF15A1, A2, A3, AM, AX, AY, B, B2, BX



| REF | OEM |
|------------------|--------------------------------|
| REC19210-ZW9-013 | 19210-ZW9-013 19210-ZW9-003 |



 BF8B1, B2, D1, D2, D3, D4, DK2
 BF9,9D1, D2, D3, DK2
 BF10B1, B2, D1, D2, D4, DK2
 BFP8B1, B2, D1, D2, D3
 BFP9,9D1, D2, D3
 BFP10B1, B2, D1, D2

| REF | OEM |
|----------------|---------------|
| REC47-43026Q02 | 19210-ZW1-303 |



 BF75
 BF90AT

| REF | OEM |
|------------------|---------------|
| REC19210-ZV4-013 | 19210-ZV4-013 |



 BF9,9AH, AK, AM
 BF15AH, AK, AM

| REF | OEM |
|------------------|---------------|
| REC19210-ZY9-H01 | 19210-ZY9-H01 |



 F75DK3, DK4
 BF80A, AK1
 BF90DK4, DK5
 BF100A, AK1

| REF | OEM |
|------------------|---------------|
| REC19210-ZV7-003 | 19210-ZV7-003 |





 BF20A, A2, AX
 BF25A, A1, A2, A3, AX, D4, DK2
 BF30A, A1, A2, A3, AX, D4, DK2

HONDA

RECAMBIOS MARINOS

| REF | OEM |
|------------------|---|
| REC19210-881-003 | 19210-881-003 19210-881-A01 19210-881-A02 |



 BF4,5B, B2, B4, B6, BK0, BK2, BX
 BF5A1, A2, A3, A4, AH, AK, AK2, AX
 BF6B, BZ, D6
 BF8AH, AK, AM, AX, B, BX
 BF50F
 BF75A, B, C, D, E
 BF100A, B, C, D, E, F

| REF | OEM |
|------------------|---------------------------------|
| REC19210-ZW9-A32 | 19210-ZW9-A31, 19210-ZW9-A32 |



 BF8B1, B2, D1, D2, D3
 BF9,9DK2
 BF10D2, D4, DK2
 BF15D3, DK2, DK3
 BF20D3, DK2, DK3
 BFP8B1, B2, D1, D2, D3
 BFP9,9D, D1, D2
 BFP10B1, B2, D1, D2

| REF | OEM |
|------------------|---------------|
| REC19210-ZY3-003 | 19210-ZY3-003 |



 BF175A3, A6, AK1, AK2, AK3, D
 BF200A2, A3, A6, AK1, AK2, AK3, D
 BF225A, A2, A, A6, AK1, AK2, D
 BF250A, D

| REF | OEM |
|------------------|---------------|
| REC19210-ZV5-003 | 19210-ZV5-003 |



 BF35AM
 BF40A, A1, A2, A3, A4, AX, AY, B,
 B2, BX, D, DK2, DK4, E
 BF45AM
 BF50A, A1, A2, A3, AX, AY, D, DK2,
 DK4
 BF60A, AK1
 BFP60A, AK1

| REF | OEM |
|------------------|---|
| REC19210-ZW1-B02 | 19210-ZW1-B02 19210-ZW1-B03 19210-ZW1-B04 |









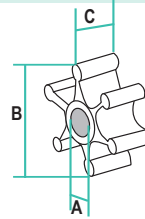



 BF75A1, A2, A3, AV, AX, DK0, DK2
 BF90A1, A2, A3, AV, AX, DK0, DK2
 BF115A1, A2, A3, AX, D, DK1
 BF130A1, A2, A3, AX
 BF135A4, AK2
 BF150A4





































GUÍA DE IMPULSORES IMPELLER GUIDE GUIDA GIRANTE GUIDE DES TURBINES

|  | REF | CEF | A (mm) | B (mm) | C (mm) |
|---|--|------------------|-----------|--------|------------|
| | BF100A, AK1 | REC19210-ZY9-H01 | | | |
| | BF100A, B, C, D, E, F | REC19210-881-003 | | | |
| | BF10B1, B2, D1, D2, D4, DK2 | REC19210-ZW9-013 | CEF500347 | 13 | 45,6 14,8 |
| | BF10D2, D4, DK2 | REC19210-ZW9-A32 | CEF500348 | 16,2 | 45,6 14,8 |
| | BF115A1, A2, A3, AX | REC19210-ZW1-B02 | CEF500337 | 23,35 | 87,8 31 |
| | BF115D, DK1 | REC19210-ZW1-B02 | CEF500337 | 23,35 | 87,8 31 |
| | BF130A1, A2, A3, AX | REC19210-ZW1-B02 | CEF500337 | 23,35 | 87,8 31 |
| | BF135A4, AK2 | REC19210-ZW1-B02 | CEF500337 | 23,35 | 87,8 31 |
| | BF150A4 | REC19210-ZW1-B02 | CEF500337 | 23,35 | 87,8 31 |
| | BF15A1, A2, A3, AM, AX, AY, B, B2, BX | REC19210-ZV4-651 | CEF500343 | 14,1 | 41 27,55 |
| | BF15AH, AK, AM | REC19210-ZV4-013 | CEF500328 | 14,2 | 41 27,55 |
| | BF15D3, DK2, DK3 | REC19210-ZW9-A32 | CEF500348 | 16,2 | 45,6 14,8 |
| | BF175A3, A6, AK1, AK2, AK3, D | REC19210-ZY3-003 | CEF500391 | 26 | 89,75 31,3 |
| | BF200A2, A3, A6, AK1, AK2, AK3, D | REC19210-ZY3-003 | CEF500391 | 26 | 89,75 31,3 |
| | BF20A, A2, AX | REC19210-ZV7-003 | CEF500339 | 17,2 | 55,75 20,2 |
| | BF20D3, DK2, DK3 | REC19210-ZW9-A32 | CEF500348 | 16,2 | 45,6 14,8 |
| | BF20F | RM19211-ZV0-003 | | 10,5 | 40 22,5 |
| | BF225A, A2, A3, A6, AK1, AK2, D | REC19210-ZY3-003 | CEF500391 | 26 | 89,75 31,3 |
| | BF250A, D | REC19210-ZY3-003 | CEF500391 | 26 | 89,75 31,3 |
| | BF25A, A1, A2, A3, AX, D4, DK2 | REC19210-ZV7-003 | CEF500339 | 17,2 | 55,75 20,2 |
| | BF2AH, AK, AM | RM19211-ZV0-003 | | 10,5 | 40 22,5 |
| | BF30A, A1, A2, A3, AX, D4, DK2 | REC19210-ZV7-003 | CEF500339 | 17,2 | 55,75 20,2 |
| | BF35AM | REC19210-ZV5-003 | CEF500338 | 17,2 | 55,9 20,2 |
| | BF4,5B, B2, B3, B6, BK0, BK2, BX | REC19210-881-003 | | | |
| | BF40A, A1, A2, A3, A4, AX, AY, B, B2, BX, D, DK2, DK4, E | REC19210-ZV5-003 | CEF500338 | 17,2 | 55,9 20,2 |
| | BF45AM | REC19210-ZV5-003 | CEF500338 | 17,2 | 55,9 20,2 |
| | BF50A, A1, A2, A3, AX, AY, D, DK4 | REC19210-ZV5-003 | CEF500338 | 17,2 | 55,9 20,2 |
| | BF50F, A1, A2, A3, A4, AH, AK, AK2, AX | REC19210-881-003 | | | |
| | BF60A, AK1 | REC19210-ZV5-003 | CEF500338 | 17,2 | 55,9 20,2 |
| | BF6B, BZ, D6 | REC19210-881-003 | | | |
| | BF75 | REC47-43026Q02 | CEF500301 | 22,4 | 89 32,5 |
| | BF75A | REC19210-881-003 | | | |



|  | REF | CEF | A (mm) | B (mm) | C (mm) |
|---|--|------------------|-----------|--------|-----------|
| | BF75A1, A2, A3, AV, AX, DK0, DK2, DK3, DK4 | REC19210-ZW1-B02 | CEF500337 | 23,35 | 87,8 31 |
| | BF75B, C, D, E | REC19210-881-003 | | | |
| | BF80A, AK1 | REC19210-ZY9-H01 | | | |
| | BF8AH, AK, AM, AX, B | REC19210-881-003 | | | |
| | BF8B1, B2 | REC19210-ZW9-013 | CEF500347 | 13 | 45,6 14,8 |
| | BF8B1, B2 | REC19210-ZW9-A32 | CEF500348 | 16,2 | 45,6 14,8 |
| | BF8BX | REC19210-881-003 | | | |
| | BF8C, CX | REC19210-ZV4-651 | CEF500343 | 14,1 | 41 27,55 |
| | BF8D1, D2, D3, D4, DK2 | REC19210-ZW9-013 | CEF500347 | 13 | 45,6 14,8 |
| | BF8D1, D2, D3 | REC19210-ZW9-A32 | CEF500348 | 16,2 | 45,6 14,8 |
| | BF9,9AH, AK, AM | REC19210-ZV4-013 | CEF500328 | 14,2 | 41 27,55 |
| | BF9,9AM, AX, B, BX | REC19210-ZV4-651 | CEF500343 | 14,1 | 41 27,55 |
| | BF9,9D1, D2, D3, DK2 | REC19210-ZW9-013 | CEF500347 | 13 | 45,6 14,8 |
| | BF9,9DK2 | REC19210-ZW9-A32 | CEF500348 | 16,2 | 45,6 14,8 |
| | BF90A1, A2, A3 | REC19210-ZW1-B02 | CEF500337 | 23,35 | 87,8 31 |
| | BF90AT | REC47-43026Q02 | CEF500301 | 22,4 | 89 32,5 |
| | BF90AV, AX, DK0, DK2 | REC19210-ZW1-B02 | CEF500337 | 23,35 | 87,8 31 |
| | BF90DK4, DK5 | REC19210-ZY9-H01 | | | |
| | BFP10B1, B2, D1, D2 | REC19210-ZW9-013 | CEF500347 | 13 | 45,6 14,8 |
| | BFP10B1, B2, D2 | REC19210-ZW9-A32 | CEF500348 | 16,2 | 45,6 14,8 |
| | BFP60A, AK1 | REC19210-ZV5-003 | CEF500338 | 17,2 | 55,9 20,2 |
| | BFP8B1, B2, D1, D2, D3 | REC19210-ZW9-013 | CEF500347 | 13 | 45,6 14,8 |
| | BFP8B1, B2, D1, D2, D3 | REC19210-ZW9-A32 | CEF500348 | 16,2 | 45,6 14,8 |
| | BFP9,9D, D1, D2 | REC19210-ZW9-A32 | CEF500348 | 16,2 | 45,6 14,8 |
| | BFP9,9D1, D2, D3 | REC19210-ZW9-013 | CEF500347 | 13 | 45,6 14,8 |
| | BFPD1 | REC19210-ZW9-A32 | CEF500348 | 16,2 | 45,6 14,8 |
| | BFT100AK1 | REC19210-ZY9-H01 | | | |
| | BFT80AK1 | REC19210-ZY9-H01 | | | |

| CHAVETA | KEY | CHAVETTA | CLAVETTE | | | | | | | | |
|--|-------------------------------|----------|------------------|---------------|---|---|-----|-----|------------------|-------------------------------|---|
| <table border="1"> <thead> <tr> <th>REF</th> <th>OEM</th> </tr> </thead> <tbody> <tr> <td>REC90752-ZV4-650</td> <td>90752-ZV4-650</td> </tr> </tbody> </table> <p>  BF8C, CX BF9.9AM, B, AX, BX, AY BF15AM, B, A1, A2, AX, B2, BX, A3, AY </p> | REF | OEM | REC90752-ZV4-650 | 90752-ZV4-650 |  | <table border="1"> <thead> <tr> <th>REF</th> <th>OEM</th> </tr> </thead> <tbody> <tr> <td>REC90752-ZW1-B02</td> <td>90752-ZW1-B02 9075-ZW1-003</td> </tr> </tbody> </table> <p>  BF80A, BF100A BF150A4, AK2 BF75A1, AV, AX, DK2, DK3, A2, A3 BF90A1, AV, AX, DK0, DK2, DK4, A2, A3 BF115A1, A2, A3, AX, D, DK1 BF130A1, A2, A3, AX BF135A4, AK2 </p> | REF | OEM | REC90752-ZW1-B02 | 90752-ZW1-B02 9075-ZW1-003 |  |
| REF | OEM | | | | | | | | | | |
| REC90752-ZV4-650 | 90752-ZV4-650 | | | | | | | | | | |
| REF | OEM | | | | | | | | | | |
| REC90752-ZW1-B02 | 90752-ZW1-B02 9075-ZW1-003 | | | | | | | | | | |
| <table border="1"> <thead> <tr> <th>REF</th> <th>OEM</th> </tr> </thead> <tbody> <tr> <td>REC90752-ZV7-000</td> <td>90752-ZV7-000</td> </tr> </tbody> </table> <p>  BF25D4, DK2, A, A1, AX, A2, A3 BF30D4, DK2, A, A1, AX, A2, A3 BF20A, AX, A2 </p> | REF | OEM | REC90752-ZV7-000 | 90752-ZV7-000 |  | <table border="1"> <thead> <tr> <th>REF</th> <th>OEM</th> </tr> </thead> <tbody> <tr> <td>REC90752-ZV5-003</td> <td>90752-ZV5-003</td> </tr> </tbody> </table> <p>  BF60A, AK1 BF50A4, D, DK2, A, A1, A2, AX, A3, AY BF35AM BF40B, B2, BX, D, DK2, A, A1, A2, AX, E, A3, AY, A4 BF45AM </p> | REF | OEM | REC90752-ZV5-003 | 90752-ZV5-003 |  |
| REF | OEM | | | | | | | | | | |
| REC90752-ZV7-000 | 90752-ZV7-000 | | | | | | | | | | |
| REF | OEM | | | | | | | | | | |
| REC90752-ZV5-003 | 90752-ZV5-003 | | | | | | | | | | |
| <table border="1"> <thead> <tr> <th>REF</th> <th>OEM</th> </tr> </thead> <tbody> <tr> <td>REC90752-ZY3-003</td> <td>90752-ZY3-003</td> </tr> </tbody> </table> <p>  BF225A2, A3, A6, AK2, AK3 BF175A3, A6, AK1, AK2, AK3 BF200A2, A3, A6, AK1, AK2, AK3 BF250A, AK1 </p> | REF | OEM | REC90752-ZY3-003 | 90752-ZY3-003 |  | | | | | | |
| REF | OEM | | | | | | | | | | |
| REC90752-ZY3-003 | 90752-ZY3-003 | | | | | | | | | | |

| BOMBA DE AGUA | WATER PUMP | POMPA ACQUA | POMPE À EAU | | | | | | | | | | | | | | | | | | | | | | | | | | | | | | | | | | | | | | | | | | | | | | | | | | | | | | | | | | | | | | | | | | | | | |
|--|-------------------|-------------------|-----------------------|-----------------------|--|--|-----|------------|------------------|---|--|-----|-----|------------------|---------------|---|--|-----|-----|------------------|---------------|---|--|-----|-----|------------------|---------------|---|--|-----|-----|------------------|---------------|---|--|-----|-----|--------------|---------------|---|--|-----|-----|--------------|---------------|---|--|-----|-----|------------------|---------------|---|---|-----|-----|------------------|---------------|---|--|-----|-----|------------------|---------------|---|---|-----|-----|---------------|---------------|---|--|--|
| <table border="1"> <thead> <tr> <th>JUNTAS BOMBA</th> <th>WATER PUMP GASKET</th> <th>GUARNIZIONE POMPA</th> <th>JOINTS DE POMPE A EAU</th> </tr> </thead> <tbody> <tr> <td> <table border="1"> <thead> <tr> <th>REF</th> <th>OEM</th> </tr> </thead> <tbody> <tr> <td>REC8172761</td> <td>19231-ZW1-003</td> </tr> </tbody> </table> <p>  BF75A BF90A </p> </td> <td></td> <td> <table border="1"> <thead> <tr> <th>REF</th> <th>OEM</th> </tr> </thead> <tbody> <tr> <td>REC19232-ZV1-A10</td> <td>19232-ZV1-A10</td> </tr> </tbody> </table> <p>  BF4.5B, BX, BK2, B2, B4, B6, BK0 BF5A1, AM, AX, AK2, A2, A3, A4 </p> </td> <td></td> </tr> <tr> <td> <table border="1"> <thead> <tr> <th>REF</th> <th>OEM</th> </tr> </thead> <tbody> <tr> <td>REC19232-881-850</td> <td>19232-881-850</td> </tr> </tbody> </table> <p>  BF6B, BX, D6 BF8AX, B, BX, AK, AM </p> </td> <td></td> <td> <table border="1"> <thead> <tr> <th>REF</th> <th>OEM</th> </tr> </thead> <tbody> <tr> <td>REC19242-ZV5-000</td> <td>19242-ZV5-000</td> </tr> </tbody> </table> <p>  BF20A, AX, A2 BF35AM BF40B, B2, BX, A4, D, DK2, A, A1, A2, AX, A3, AY BF45AM BF25D4, DK2, A, A1, AX, A2, A3 BF50A4, D, DK2, A, A1, A2, A3, AY BF30D4, DK2, A, A1, AX, A2, A3 </p> </td> <td></td> </tr> <tr> <td> <table border="1"> <thead> <tr> <th>REF</th> <th>OEM</th> </tr> </thead> <tbody> <tr> <td>REC19234-881-850</td> <td>19234-881-850</td> </tr> </tbody> </table> <p>  BF6B, BX, D6 BF8AX, B, BX, AK, AM </p> </td> <td></td> <td> <table border="1"> <thead> <tr> <th>REF</th> <th>OEM</th> </tr> </thead> <tbody> <tr> <td>REC27-430331</td> <td>19234-ZW1-003</td> </tr> </tbody> </table> <p>  BF75A BF90A </p> </td> <td></td> </tr> <tr> <td> <table border="1"> <thead> <tr> <th>REF</th> <th>OEM</th> </tr> </thead> <tbody> <tr> <td>REC27-430472</td> <td>19242-ZW1-003</td> </tr> </tbody> </table> <p>  BF75A BF90A </p> </td> <td></td> <td> <table border="1"> <thead> <tr> <th>REF</th> <th>OEM</th> </tr> </thead> <tbody> <tr> <td>REC19234-ZY3-000</td> <td>19234-ZY3-000</td> </tr> </tbody> </table> <p>  BF175A3, A6, AK1, AK2, AK3 BF200A2, A3, A6, AK1, AK2, AK3 BF225A2, A3, A6, AK1, AK2, AK3 </p> </td> <td></td> </tr> <tr> <td> <table border="1"> <thead> <tr> <th>REF</th> <th>OEM</th> </tr> </thead> <tbody> <tr> <td>REC19232-ZV4-610</td> <td>19232-ZV4-610</td> </tr> </tbody> </table> <p>  BF15AK, AM, B, A1, A2, AX, B2, BX, A1, A2, A3, AY BF9.9AK, AM, B, AX, BX, AY BF8C, CX </p> </td> <td></td> <td> <table border="1"> <thead> <tr> <th>REF</th> <th>OEM</th> </tr> </thead> <tbody> <tr> <td>REC19233-ZV5-000</td> <td>19233-ZV5-000</td> </tr> </tbody> </table> <p>  BF35AM BF40B, B2, BX, A4, D, DK2, A, A1, A2, AX, AY BF45AM BF25D4, DK2, A, A1, AX, A2, A3 BF30D4, K2, A, A1, AX, AZ, A3 BF50A4, D, DK2, A, A1, A2, AX </p> </td> <td></td> </tr> <tr> <td> <table border="1"> <thead> <tr> <th>REF</th> <th>OEM</th> </tr> </thead> <tbody> <tr> <td>REC27-8172771</td> <td>19232-ZW1-003</td> </tr> </tbody> </table> <p>  BF75A BF90A </p> </td> <td></td> <td></td> <td></td> </tr> </tbody> </table> | JUNTAS BOMBA | WATER PUMP GASKET | GUARNIZIONE POMPA | JOINTS DE POMPE A EAU | <table border="1"> <thead> <tr> <th>REF</th> <th>OEM</th> </tr> </thead> <tbody> <tr> <td>REC8172761</td> <td>19231-ZW1-003</td> </tr> </tbody> </table> <p>  BF75A BF90A </p> | REF | OEM | REC8172761 | 19231-ZW1-003 |  | <table border="1"> <thead> <tr> <th>REF</th> <th>OEM</th> </tr> </thead> <tbody> <tr> <td>REC19232-ZV1-A10</td> <td>19232-ZV1-A10</td> </tr> </tbody> </table> <p>  BF4.5B, BX, BK2, B2, B4, B6, BK0 BF5A1, AM, AX, AK2, A2, A3, A4 </p> | REF | OEM | REC19232-ZV1-A10 | 19232-ZV1-A10 |  | <table border="1"> <thead> <tr> <th>REF</th> <th>OEM</th> </tr> </thead> <tbody> <tr> <td>REC19232-881-850</td> <td>19232-881-850</td> </tr> </tbody> </table> <p>  BF6B, BX, D6 BF8AX, B, BX, AK, AM </p> | REF | OEM | REC19232-881-850 | 19232-881-850 |  | <table border="1"> <thead> <tr> <th>REF</th> <th>OEM</th> </tr> </thead> <tbody> <tr> <td>REC19242-ZV5-000</td> <td>19242-ZV5-000</td> </tr> </tbody> </table> <p>  BF20A, AX, A2 BF35AM BF40B, B2, BX, A4, D, DK2, A, A1, A2, AX, A3, AY BF45AM BF25D4, DK2, A, A1, AX, A2, A3 BF50A4, D, DK2, A, A1, A2, A3, AY BF30D4, DK2, A, A1, AX, A2, A3 </p> | REF | OEM | REC19242-ZV5-000 | 19242-ZV5-000 |  | <table border="1"> <thead> <tr> <th>REF</th> <th>OEM</th> </tr> </thead> <tbody> <tr> <td>REC19234-881-850</td> <td>19234-881-850</td> </tr> </tbody> </table> <p>  BF6B, BX, D6 BF8AX, B, BX, AK, AM </p> | REF | OEM | REC19234-881-850 | 19234-881-850 |  | <table border="1"> <thead> <tr> <th>REF</th> <th>OEM</th> </tr> </thead> <tbody> <tr> <td>REC27-430331</td> <td>19234-ZW1-003</td> </tr> </tbody> </table> <p>  BF75A BF90A </p> | REF | OEM | REC27-430331 | 19234-ZW1-003 |  | <table border="1"> <thead> <tr> <th>REF</th> <th>OEM</th> </tr> </thead> <tbody> <tr> <td>REC27-430472</td> <td>19242-ZW1-003</td> </tr> </tbody> </table> <p>  BF75A BF90A </p> | REF | OEM | REC27-430472 | 19242-ZW1-003 |  | <table border="1"> <thead> <tr> <th>REF</th> <th>OEM</th> </tr> </thead> <tbody> <tr> <td>REC19234-ZY3-000</td> <td>19234-ZY3-000</td> </tr> </tbody> </table> <p>  BF175A3, A6, AK1, AK2, AK3 BF200A2, A3, A6, AK1, AK2, AK3 BF225A2, A3, A6, AK1, AK2, AK3 </p> | REF | OEM | REC19234-ZY3-000 | 19234-ZY3-000 |  | <table border="1"> <thead> <tr> <th>REF</th> <th>OEM</th> </tr> </thead> <tbody> <tr> <td>REC19232-ZV4-610</td> <td>19232-ZV4-610</td> </tr> </tbody> </table> <p>  BF15AK, AM, B, A1, A2, AX, B2, BX, A1, A2, A3, AY BF9.9AK, AM, B, AX, BX, AY BF8C, CX </p> | REF | OEM | REC19232-ZV4-610 | 19232-ZV4-610 |  | <table border="1"> <thead> <tr> <th>REF</th> <th>OEM</th> </tr> </thead> <tbody> <tr> <td>REC19233-ZV5-000</td> <td>19233-ZV5-000</td> </tr> </tbody> </table> <p>  BF35AM BF40B, B2, BX, A4, D, DK2, A, A1, A2, AX, AY BF45AM BF25D4, DK2, A, A1, AX, A2, A3 BF30D4, K2, A, A1, AX, AZ, A3 BF50A4, D, DK2, A, A1, A2, AX </p> | REF | OEM | REC19233-ZV5-000 | 19233-ZV5-000 |  | <table border="1"> <thead> <tr> <th>REF</th> <th>OEM</th> </tr> </thead> <tbody> <tr> <td>REC27-8172771</td> <td>19232-ZW1-003</td> </tr> </tbody> </table> <p>  BF75A BF90A </p> | REF | OEM | REC27-8172771 | 19232-ZW1-003 |  | | |
| JUNTAS BOMBA | WATER PUMP GASKET | GUARNIZIONE POMPA | JOINTS DE POMPE A EAU | | | | | | | | | | | | | | | | | | | | | | | | | | | | | | | | | | | | | | | | | | | | | | | | | | | | | | | | | | | | | | | | | | | | | |
| <table border="1"> <thead> <tr> <th>REF</th> <th>OEM</th> </tr> </thead> <tbody> <tr> <td>REC8172761</td> <td>19231-ZW1-003</td> </tr> </tbody> </table> <p>  BF75A BF90A </p> | REF | OEM | REC8172761 | 19231-ZW1-003 |  | <table border="1"> <thead> <tr> <th>REF</th> <th>OEM</th> </tr> </thead> <tbody> <tr> <td>REC19232-ZV1-A10</td> <td>19232-ZV1-A10</td> </tr> </tbody> </table> <p>  BF4.5B, BX, BK2, B2, B4, B6, BK0 BF5A1, AM, AX, AK2, A2, A3, A4 </p> | REF | OEM | REC19232-ZV1-A10 | 19232-ZV1-A10 |  | | | | | | | | | | | | | | | | | | | | | | | | | | | | | | | | | | | | | | | | | | | | | | | | | | | | | | | | | | | | | |
| REF | OEM | | | | | | | | | | | | | | | | | | | | | | | | | | | | | | | | | | | | | | | | | | | | | | | | | | | | | | | | | | | | | | | | | | | | | | | |
| REC8172761 | 19231-ZW1-003 | | | | | | | | | | | | | | | | | | | | | | | | | | | | | | | | | | | | | | | | | | | | | | | | | | | | | | | | | | | | | | | | | | | | | | | |
| REF | OEM | | | | | | | | | | | | | | | | | | | | | | | | | | | | | | | | | | | | | | | | | | | | | | | | | | | | | | | | | | | | | | | | | | | | | | | |
| REC19232-ZV1-A10 | 19232-ZV1-A10 | | | | | | | | | | | | | | | | | | | | | | | | | | | | | | | | | | | | | | | | | | | | | | | | | | | | | | | | | | | | | | | | | | | | | | | |
| <table border="1"> <thead> <tr> <th>REF</th> <th>OEM</th> </tr> </thead> <tbody> <tr> <td>REC19232-881-850</td> <td>19232-881-850</td> </tr> </tbody> </table> <p>  BF6B, BX, D6 BF8AX, B, BX, AK, AM </p> | REF | OEM | REC19232-881-850 | 19232-881-850 |  | <table border="1"> <thead> <tr> <th>REF</th> <th>OEM</th> </tr> </thead> <tbody> <tr> <td>REC19242-ZV5-000</td> <td>19242-ZV5-000</td> </tr> </tbody> </table> <p>  BF20A, AX, A2 BF35AM BF40B, B2, BX, A4, D, DK2, A, A1, A2, AX, A3, AY BF45AM BF25D4, DK2, A, A1, AX, A2, A3 BF50A4, D, DK2, A, A1, A2, A3, AY BF30D4, DK2, A, A1, AX, A2, A3 </p> | REF | OEM | REC19242-ZV5-000 | 19242-ZV5-000 |  | | | | | | | | | | | | | | | | | | | | | | | | | | | | | | | | | | | | | | | | | | | | | | | | | | | | | | | | | | | | | |
| REF | OEM | | | | | | | | | | | | | | | | | | | | | | | | | | | | | | | | | | | | | | | | | | | | | | | | | | | | | | | | | | | | | | | | | | | | | | | |
| REC19232-881-850 | 19232-881-850 | | | | | | | | | | | | | | | | | | | | | | | | | | | | | | | | | | | | | | | | | | | | | | | | | | | | | | | | | | | | | | | | | | | | | | | |
| REF | OEM | | | | | | | | | | | | | | | | | | | | | | | | | | | | | | | | | | | | | | | | | | | | | | | | | | | | | | | | | | | | | | | | | | | | | | | |
| REC19242-ZV5-000 | 19242-ZV5-000 | | | | | | | | | | | | | | | | | | | | | | | | | | | | | | | | | | | | | | | | | | | | | | | | | | | | | | | | | | | | | | | | | | | | | | | |
| <table border="1"> <thead> <tr> <th>REF</th> <th>OEM</th> </tr> </thead> <tbody> <tr> <td>REC19234-881-850</td> <td>19234-881-850</td> </tr> </tbody> </table> <p>  BF6B, BX, D6 BF8AX, B, BX, AK, AM </p> | REF | OEM | REC19234-881-850 | 19234-881-850 |  | <table border="1"> <thead> <tr> <th>REF</th> <th>OEM</th> </tr> </thead> <tbody> <tr> <td>REC27-430331</td> <td>19234-ZW1-003</td> </tr> </tbody> </table> <p>  BF75A BF90A </p> | REF | OEM | REC27-430331 | 19234-ZW1-003 |  | | | | | | | | | | | | | | | | | | | | | | | | | | | | | | | | | | | | | | | | | | | | | | | | | | | | | | | | | | | | | |
| REF | OEM | | | | | | | | | | | | | | | | | | | | | | | | | | | | | | | | | | | | | | | | | | | | | | | | | | | | | | | | | | | | | | | | | | | | | | | |
| REC19234-881-850 | 19234-881-850 | | | | | | | | | | | | | | | | | | | | | | | | | | | | | | | | | | | | | | | | | | | | | | | | | | | | | | | | | | | | | | | | | | | | | | | |
| REF | OEM | | | | | | | | | | | | | | | | | | | | | | | | | | | | | | | | | | | | | | | | | | | | | | | | | | | | | | | | | | | | | | | | | | | | | | | |
| REC27-430331 | 19234-ZW1-003 | | | | | | | | | | | | | | | | | | | | | | | | | | | | | | | | | | | | | | | | | | | | | | | | | | | | | | | | | | | | | | | | | | | | | | | |
| <table border="1"> <thead> <tr> <th>REF</th> <th>OEM</th> </tr> </thead> <tbody> <tr> <td>REC27-430472</td> <td>19242-ZW1-003</td> </tr> </tbody> </table> <p>  BF75A BF90A </p> | REF | OEM | REC27-430472 | 19242-ZW1-003 |  | <table border="1"> <thead> <tr> <th>REF</th> <th>OEM</th> </tr> </thead> <tbody> <tr> <td>REC19234-ZY3-000</td> <td>19234-ZY3-000</td> </tr> </tbody> </table> <p>  BF175A3, A6, AK1, AK2, AK3 BF200A2, A3, A6, AK1, AK2, AK3 BF225A2, A3, A6, AK1, AK2, AK3 </p> | REF | OEM | REC19234-ZY3-000 | 19234-ZY3-000 |  | | | | | | | | | | | | | | | | | | | | | | | | | | | | | | | | | | | | | | | | | | | | | | | | | | | | | | | | | | | | | |
| REF | OEM | | | | | | | | | | | | | | | | | | | | | | | | | | | | | | | | | | | | | | | | | | | | | | | | | | | | | | | | | | | | | | | | | | | | | | | |
| REC27-430472 | 19242-ZW1-003 | | | | | | | | | | | | | | | | | | | | | | | | | | | | | | | | | | | | | | | | | | | | | | | | | | | | | | | | | | | | | | | | | | | | | | | |
| REF | OEM | | | | | | | | | | | | | | | | | | | | | | | | | | | | | | | | | | | | | | | | | | | | | | | | | | | | | | | | | | | | | | | | | | | | | | | |
| REC19234-ZY3-000 | 19234-ZY3-000 | | | | | | | | | | | | | | | | | | | | | | | | | | | | | | | | | | | | | | | | | | | | | | | | | | | | | | | | | | | | | | | | | | | | | | | |
| <table border="1"> <thead> <tr> <th>REF</th> <th>OEM</th> </tr> </thead> <tbody> <tr> <td>REC19232-ZV4-610</td> <td>19232-ZV4-610</td> </tr> </tbody> </table> <p>  BF15AK, AM, B, A1, A2, AX, B2, BX, A1, A2, A3, AY BF9.9AK, AM, B, AX, BX, AY BF8C, CX </p> | REF | OEM | REC19232-ZV4-610 | 19232-ZV4-610 |  | <table border="1"> <thead> <tr> <th>REF</th> <th>OEM</th> </tr> </thead> <tbody> <tr> <td>REC19233-ZV5-000</td> <td>19233-ZV5-000</td> </tr> </tbody> </table> <p>  BF35AM BF40B, B2, BX, A4, D, DK2, A, A1, A2, AX, AY BF45AM BF25D4, DK2, A, A1, AX, A2, A3 BF30D4, K2, A, A1, AX, AZ, A3 BF50A4, D, DK2, A, A1, A2, AX </p> | REF | OEM | REC19233-ZV5-000 | 19233-ZV5-000 |  | | | | | | | | | | | | | | | | | | | | | | | | | | | | | | | | | | | | | | | | | | | | | | | | | | | | | | | | | | | | | |
| REF | OEM | | | | | | | | | | | | | | | | | | | | | | | | | | | | | | | | | | | | | | | | | | | | | | | | | | | | | | | | | | | | | | | | | | | | | | | |
| REC19232-ZV4-610 | 19232-ZV4-610 | | | | | | | | | | | | | | | | | | | | | | | | | | | | | | | | | | | | | | | | | | | | | | | | | | | | | | | | | | | | | | | | | | | | | | | |
| REF | OEM | | | | | | | | | | | | | | | | | | | | | | | | | | | | | | | | | | | | | | | | | | | | | | | | | | | | | | | | | | | | | | | | | | | | | | | |
| REC19233-ZV5-000 | 19233-ZV5-000 | | | | | | | | | | | | | | | | | | | | | | | | | | | | | | | | | | | | | | | | | | | | | | | | | | | | | | | | | | | | | | | | | | | | | | | |
| <table border="1"> <thead> <tr> <th>REF</th> <th>OEM</th> </tr> </thead> <tbody> <tr> <td>REC27-8172771</td> <td>19232-ZW1-003</td> </tr> </tbody> </table> <p>  BF75A BF90A </p> | REF | OEM | REC27-8172771 | 19232-ZW1-003 |  | | | | | | | | | | | | | | | | | | | | | | | | | | | | | | | | | | | | | | | | | | | | | | | | | | | | | | | | | | | | | | | | | | | |
| REF | OEM | | | | | | | | | | | | | | | | | | | | | | | | | | | | | | | | | | | | | | | | | | | | | | | | | | | | | | | | | | | | | | | | | | | | | | | |
| REC27-8172771 | 19232-ZW1-003 | | | | | | | | | | | | | | | | | | | | | | | | | | | | | | | | | | | | | | | | | | | | | | | | | | | | | | | | | | | | | | | | | | | | | | | |

RETÉN CUERPO DE BOMBA

SEAL WATER PUMP

TENUTE CORPO POMPA

JOINTS SPI DE POMPE À EAU

| REF | OEM |
|------------------|---------------|
| REC91252-ZV1-003 | 91252-ZV1-003 |

 B4.5B, BX, BK2, B4, B6
 BF5A1, H, AK, AM, AX, AK2, A2, A3, A4
 BF8B1, D1, D2, B2, DK2, D3, D4
 BF9.9DK2, D1, D2, D3
 BF10B1, D1, D4, DK2, B2, D2
 BF50F



| REF | OEM |
|------------------|---------------|
| REC91252-935-004 | 91252-935-004 |

 BF9.9A
 BF15A
 BF100A, B, C, D, E, F
 BF75A, B, C, D, K2, K3, E, F
 BF15AH, AK, AM, B, A1, A2, AX, B2, BX, A3, AY
 BF9.9AH, AK, AM, B, AX, BX, AY
 BF6BX, D6
 BF8AX, B, BX, C, CX, AH, AK, AM



KITS DE REPARACIÓN BOMBA DE AGUA

WATER PUMP SERVICE KITS

KIT RICAMBI POMPA ACQUA

KIT POMPE À EAU

| REF | OEM |
|------------------|--------------------------------|
| REC06192-ZV1-C00 | 06192-ZV1-C00 06192-ZV1-000 |

 BF4.5B, BK2, BK0
 BF5A1, AM, AX, AK2, A2, A3, A4



| REF | OEM |
|------------------|---|
| REC06193-ZV5-020 | 06193-ZV5-020 06193-ZV5-000 06193-ZV5-010 |

 BF40A4, D, DK2, DK4
 BF50A4, D, DK2, DK4



new

| REF | OEM |
|------------------|---------------|
| REC06192-881-C00 | 06192-881-C00 |

 BF6B, BX, D6
 BF8AX, B, BX, AM



| REF | OEM |
|------------------|---------------|
| REC06192-ZW9-A30 | 06192-ZW9-A30 |

 BFP8D, BF8B2, BF8D2
 BFP9.9D (XL)
 BF15D
 BF20D
 BF10D
 BFP10D



new

| REF | OEM |
|------------------|--------------------------------|
| REC06192-ZV4-000 | 06192-ZV4-000 19210-ZV4-651 |

 BF8C, CX
 BF9.9A
 BF15A2, A3, B2



| REF | OEM |
|------------------|--------------------------------|
| REC06192-ZV1-305 | 06192-ZV1-305 06192-ZW1-305 |

 BF75AT
 BF90AT



| REF | OEM |
|------------------|--------------------------------|
| REC06192-ZV7-000 | 06192-ZV7-000 06192-ZW2-000 |

 BF25D4, DK2, A2, A3
 BF30D4, DK2, A2, A3
 BF20A2



| REF | OEM |
|------------------|--------------------------------|
| REC06192-ZV1-000 | 06192-ZW1-000 06192-ZV1-000 |

 BF115A2, A3
 BF130A2, A3
 BF75DK0, DK1, A2, A3, DK2
 BF90 DK0, DK1, A2, A3, DK2

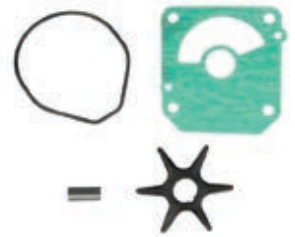

| REF | OEM |
|------------------|---------------|
| REC06192-ZV5-003 | 06192-ZV5-003 |

 BF35AM
 BF40B, B2, BX, A4, D, DK2, AA1, A2, AX, A3
 BF45AM
 BF50A4, D, DK2, A, A21, A2, AX, A3



| REF | OEM |
|------------------|---------------|
| REC06192-ZY6-000 | 06192-ZY6-000 |

 BF115D, DK1
 BF135A4, AK2
 BF150A4, AK2

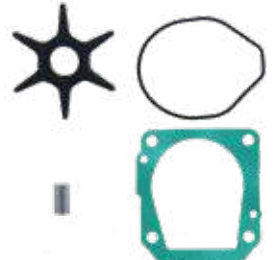

| REF | OEM |
|----------------|---------------|
| REC47-43026Q06 | 19021-ZW1-003 |

 BF75AT
 BF90AT



| REF | OEM |
|------------------|--------------------------------|
| REC06192-ZY3-000 | 06192-ZY3-000 06192-ZX2-000 |

 BF175A3, A6, AK1, AK2, AK3
 BF200A2, A3, A6, AK1, AK2, AK3
 BF225A2, A3, A6, AK1, AK2, AK3
 BF250A

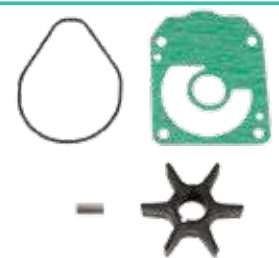



ÁNODO

ANODE

ANODI

ANODE

| ZN | KG (KG) | AL | KG (KG) | OEM |
|-----------------|---------|------------------|---------|--------------------------------|
| CM06411-ZV5-000 | 0,36 | CM06411-ZV5-000A | 0,14 | 06411-ZV5-000 06411-ZV5-020 |

BF35, 40, 45, 50
150 x 35 mm

| ZN | KG (KG) | AL | KG (KG) | OEM |
|----------|---------|-----------|---------|--------------------------------|
| CM826134 | 0,25 | CM826134A | 0,10 | 41109-ZW1-003 12155-ZV5-000 |

BF20-->BF250 HP

| ZN | KG (KG) | AL | KG (KG) | OEM |
|-----------------|---------|------------------|---------|--------------------------------|
| CM06411-ZW1-000 | 0,83 | CM06411-ZW1-000A | 0,33 | 06411-ZW1-000 06411-ZW1-020 |

BF75 --> BF225 HP
220 x 50 mm

| ZN | KG (KG) | AL | KG (KG) | OEM |
|-----------------|---------|------------------|---------|---------------|
| CM41109-ZW1-B00 | 0,22 | CM41109-ZW1-B00A | 0,11 | 41109-ZW1-B00 |

BF40-->BF250 HP

| ZN | KG (KG) | AL | KG (KG) | OEM |
|----------------|---------|-----------------|---------|--------------|
| CM6E0-45251-11 | 0,10 | CM6E0-45251-11A | 0,04 | 2155-ZV5-000 |

BF2-->BF250 HP

| ZN | KG (KG) | AL | KG (KG) | OEM |
|-----------------|---------|------------------|---------|--------------|
| CM41107-ZW1-B01 | 0,44 | CM41107-ZW1-B01A | 0,20 | 41107ZW1-B01 |

BF75-->BF130 HP

| ZN | KG (KG) | AL | KG (KG) | OEM |
|-------------------|---------|------------------|---------|--------------------------------|
| CM41106-ZW9-09000 | 0,99 | CM41106-ZW9-000A | | 41106ZW909000 41106-ZW9-000 |

BF8-->BF50HP

| ZN | KG (KG) | AL | KG (KG) | OEM |
|---------|---------|----------|---------|-------------------------------|
| CM31640 | 0,45 | CM31640A | 0,21 | 06412-ZV1-000 411072ZW1003 |

BF75, 90, 115, 130

| ZN | KG (KG) | AL | KG (KG) | OEM |
|---------------|---------|----------------|---------|-----------------------------|
| CM41107-ZV500 | 0,29 | CM41107-ZV500A | 0,11 | 41107ZV500 06412-ZV5-000 |

BF20--> BF50HP

| ZN | KG (KG) | AL | KG (KG) | OEM |
|----------------|---------|-----------------|---------|--------------|
| CM664-45371-01 | 0,27 | CM664-45371-01A | 0,10 | 064-45371-01 |

BF20--> BF50HP

KITS DE ÁNODOS

ANODES KIT

KIT ANODI

KIT ANODES

| AL | MG | |
|----------------|----------------|----------------|
| CMHBF4050KITA | CMHBF4050KITM | BF40 --> BF50 |
| CMHBF35225KITA | CMHBF35225KITM | BF35 --> BF225 |
| CMHBF75115KITA | CMHBF75115KITM | BF90 --> BF115 |



new

HONDA

RECAMBIOS MARINOS

ÁNODO

ANODE

ANODI

ANODE

| ZN | OEM | KG (KG) |
|----------|--------------------------------|---------|
| TEN01404 | 06411-ZV5-000 06411-ZV5-020 | 0,380 |



BF35-->BF50 HP

| ZN | OEM | KG (KG) |
|----------|---------------|---------|
| TEN01401 | 41106-935-812 | 0,080 |



Serie 8 /25HP

| ZN | OEM | KG (KG) |
|----------|---------------|---------|
| TEN01406 | 06411-ZV1-000 | 0,860 |



BF75-->BF225 HP

| ZN | OEM | KG (KG) |
|----------|---------------|---------|
| TEN01402 | 41106-ZV4-650 | 0,090 |



BF2-->BF15 HP

| ZN | OEM | KG (KG) |
|----------|---------------|---------|
| TEN01405 | 06411-ZV1-000 | 0,250 |



Serie 75 - 130 HP

| ZN | OEM | KG (KG) |
|----------|--------------|---------|
| TEN01400 | 41106-ZW-000 | 0,020 |



Serie 8 /25HP

| ZN | OEM | KG (KG) |
|----------|---------------|---------|
| TEN01407 | 41109-ZW1-B00 | 0,230 |



BF40-->BF250 HP

| ZN | OEM | KG (KG) |
|----------|---------------|---------|
| TEN01412 | 06412-ZV5-000 | 0,210 |



| ZN | OEM | KG (KG) |
|----------|---------------|---------|
| TEN01408 | 12155-ZV4-A00 | 0,040 |



BF8->BF250 HP

| ZN | OEM | KG (KG) |
|----------|---------------|---------|
| TEN01403 | 41107-ZV5-000 | 0,280 |



BF20-->BF50 HP

| ZN | OEM | KG (KG) |
|------------|---------------|---------|
| TEN01408/1 | 12155-ZV5-000 | 0,030 |



BF20-->BF250 HP

| ZN | OEM | KG (KG) |
|----------|-----------------|---------|
| TEN01410 | 41107-ZW1-B01ZA | 0,550 |



Serie 75 - 90 - 115 - 130 HP

| ZN | OEM | KG (KG) |
|----------|---------------|---------|
| TEN01409 | 41106-ZW9-000 | 0,050 |



BF8-->BF50 HP

| ZN | OEM | KG (KG) |
|----------|------------------|---------|
| TEN01411 | 41107-ZV1-003-ZA | 0,480 |



BF75-->BF130 HP

KITS DE ÁNODOS

ANODES KIT

KIT ANODI

KIT ANODES

| ZN | OEM |
|---------------|--|
| TENKITHONDABF | TEN01410 x 1 TEN01406 x 1 TEN01407 x 2 |



BF75+

new

PARTES DEL MOTOR ENGINE PARTS

PARTI MOTORE PIECES MOTEUR

JUNTAS DE MOTOR ENGINE GASKET GUARNIZIONI DE MOTORE JOINTS DE MOTEUR

JUNTAS DE CULATA CYLINDER HEAD GASKET GUARNIZIONE DE TESTATA JOINTS DE CULASSE

| REF | OEM |
|------------------|---------------|
| REC12251-ZV7-004 | 12251-ZV7-004 |

 BF20A, A2, AX
 BF25A, A1, 2, A3, AX
 BF30A, A1, A2, A3, AX
 VF25A2

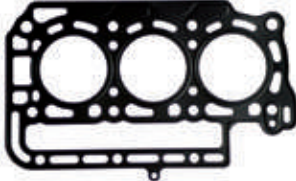

| REF | OEM |
|------------------|--------------------------------|
| REC12251-ZW1-014 | 12251-ZW1-014 12251-ZW1-004 |

 BF40A4, D, K2, DK4
 BF50A4, BF50D, DK2, DK4

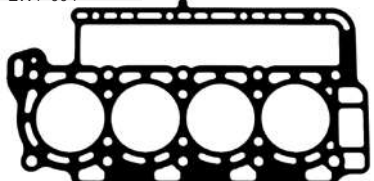

| REF | OEM |
|------------------|-----------------------------------|
| REC12251-ZV5-003 | 12251-ZW4-H01 12251-ZV5-000/03 |

 BF35AM
 BF40B, BX, A, A1, AX, AY, A4, D,
 DK2, DK4
 BF45AM
 BF50A, A1, A4, AX, AY, D, DK2, DK4

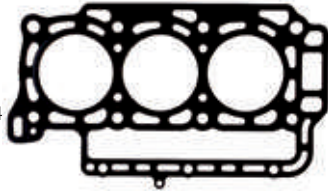

| REF | OEM |
|------------------|------------------------------------|
| REC12251-ZW5-023 | 12251-ZW5-023 12251-ZW5-000/013 |

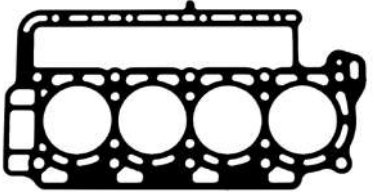

 BF115A1, A2, A3, AX
 BF130A1, A2, A3, AX



JUNTAS BASE DE MOTOR CYLINDER GASKET GUARNIZIONE BASE MOTORE JOINTS DE TÊTE MOTRICE

| REF | OEM |
|------------------|---------------|
| REC23172-ZW1-013 | 23172-ZW1-013 |

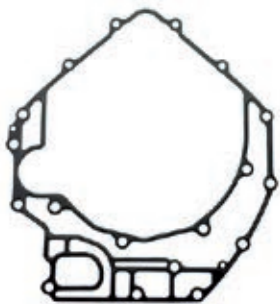
 BF75A1, A2, A3
 BF90A1, A2, A3



| REF | OEM |
|------------------|--------------------------------|
| REC23172-ZW5-013 | 23172-ZW5-013 23172-ZW5-000 |

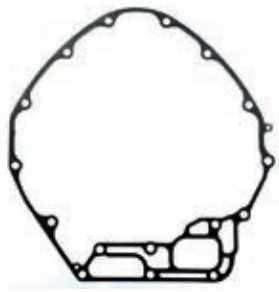

 BF115A1, A2, A3, AX
 BF130A1, A2, A3, AX



JUNTAS BOMBA ACEITE GASKET, OIL PUMP GUARNIZIONE POMPA OLIO JOINTS DE POMPE A HUILE

| REF | OEM |
|------------------|---------------|
| REC15112-ZW5-003 | 15112-ZW5-003 |

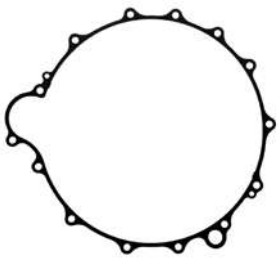
 BF115A1, A2, A3, AX
 BF130A1, A2, A3, AX



 BF115A1, A2, A3, AX
 BF130A1, A2, A3, AX





JUNTAS SILENCIOSO GASKET, MUFFLER GUARNIZIONE SILENZIATORE JOINTS DE SILENCIEU

| REF | OEM |
|------------------|---------------|
| REC17384-ZW4-000 | 17384-ZW4-000 |

 BF25D4, DK2, A4
 BF30D4, DK2, A4



 BF25D4, DK2, A4
 BF30D4, DK2, A4



HONDA

RECAMBIO
MARINOS

KIT DE JUNTAS

GASKET KIT

KIT GUARNIZIONE

KIT JOINTS

| REF | OEM |
|-----------------|---------------|
| RM061A1-ZV0-000 | 061A1-ZV0-000 |

 BF20F



| REF | OEM |
|-----------------|--------------------------------|
| RM06111-ZW1-020 | 06111-ZW1-000 06111-ZW1-020 |

 BF75A1, AT, AV, AX
BF90, A1, AT, AV, AX



JUNTA TAPÓN DE DRENAJE

O-RING DRAIN CAP

GUARNIZIONE TAPPO DRENAGIO

JOINT DE VIDANGE

| REF | OEM |
|--------------|-----------|
| REC12-191833 | 12-191833 |



CORREAS DE DISTRIBUCIÓN

TIMING BELT

CINGHIE DISTRIBUZIONE

COURROIES DE DISTRIBUTION

| REF | OEM |
|-----------------|--------------------------------|
| RM14400-921-024 | 14400-921-024 14400-921-010 |

 F8AX, B, BX, AH, AK, AM
BF6BX, D6
BF75A, B, C, D, K2, K3, E, F
BF100A, B, C, D, E, F



| REF | OEM |
|-----------------|---------------|
| RM14400-ZV4-004 | 14400-ZV4-004 |

 BF8C, CX
BF9.9AH, AK, AM, B, AX, BX, AY
BF15AH, AK, AM, B, A1, A2, AX, B2, A3, AY



| REF | OEM |
|------------------|--------------------------------|
| REC14400-ZV5-014 | 14400-ZV5-004 14400-ZV5-014 |

 BF35AM
BF40B, B2, BX, A, A1, A2, AX, AY
BF45AM
BF50A, A1, A2, AX, AY

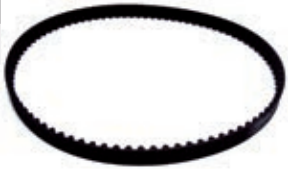

| REF | OEM |
|------------------|---------------|
| REC14400-ZZ3-004 | 14400-ZZ3-004 |

 BF60A, AK1
BFP60AK1
BF40E



new

| REF | OEM |
|-----------------|---------------|
| RM14400-ZW1-004 | 14400-ZW1-004 |

 BF75A1, AT, AV, AX, A2, A3
BF90A1, AT, AV, AX, A2, A3





SISTEMA DE ESCAPE Y ADMISIÓN EXHAUST & INTAKE SYSTEM

SISTEMA DI SCARICO E ASPIRAZIONE SYSTÈME D'ÉCHAPPEMENT ET D'ADMISSION



SISTEMA DE ESCAPE EXHAUST SYSTEM SISTEMA SCARICO SYSTÈME D'ÉCHAPPEMENT

RETÉN VÁLVULA VALVE SEALS TENUTE JOINT DE SOUPEPE

















| REF | OEM | |
|---|---|---|
| REC12209-6B4-681 | 12209-GB4-681 |  |
|  | BF8B1, B2, D1, D2, DK2, D3, D4 BF9.9DK2, D1, D2, D3 BF10B1, D1, D4, DK2, D2 | |

SISTEMA DE ADMISIÓN INTAKE SYSTEM SISTEMA ASPIRAZIONE SYSTÈME D'ADMISSION

RETÉN VÁLVULA VALVE SEALS TENUTE JOINT DE SOUPEPE

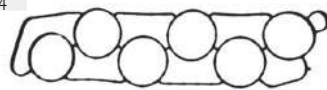
| REF | OEM | |
|---|---|--|
| REC12209-6B4-681 | 12209-GB4-681 |  |
|  | BF8B1, B2, D1, D2, DK2, D3, D4 BF9.9DK2, D1, D2, D3 BF10B1, D1, D4, DK2, D2 | |

JUNTAS GASKET, GUARNIZIONE JOINT

| REF | OEM | | |
|---|--|---|---|
| REC16221-ZW9-000 | 16221-ZW9-000 |  | REC17109-ZY6-000 17109-ZY6-000 |
|  | BF8B1, B2, D1, D2, DK2, D3, D4 BF9.9DK2, D1, D2, D3 BF10B1, D1, D4, DK2, B2, D2 | |  |
| REC16201-881-850 | 16201-881-850 |  | REC17105-ZY6-000 17105-ZY6-000 |
|  | BF6B, BX, D6 BF8AX, B, BX, AK, AM | |  |
| REC16221-ZV4-610 | 16221-ZV4-610 |  | REC17109-ZY3-004 17109-ZY3-004 |
|  | BF15AK, AM, B, A1, A2, AX, B2, BX, A3, A4 BF9.9AK, AM, B, AX, BX, AY BF8C, CX | |  |
| REC16221-ZW1-000 | 16221-ZW1-000 |  | REC17151-ZW5-000 17151-ZW5-000 |
|  | BF75A1, AT, AV, AX, A2, A3 BF90A1, AT, AV, AX, A2, A3 | |  |
| REC17105-ZY3-004 | 17105-ZY3-004 |  |  |
|  | BF250A BF175A3, A6, AK1, AK2, AK3 BF200A2, A3, A6, AK1, AK2, AK3 BF225A2, A3, A6, AK1, AK2, AK3 | |  |
| | | | BF115A1, A2, A3, AX BF130A1, A2, A3, AX |

HONDA

RECAMBIOS MARINOS

UNIDADES DE TRANSMISIÓN UNIT DRIVES & COMPONENTS

UNITÀ DI TRASMISSIONE EMBASES ET PIÈCES

DESPIECE COLAS

GEAR CASE PARTS

PARTI PIEDI

PIECES D'EMBASES

BF25 --> BF50

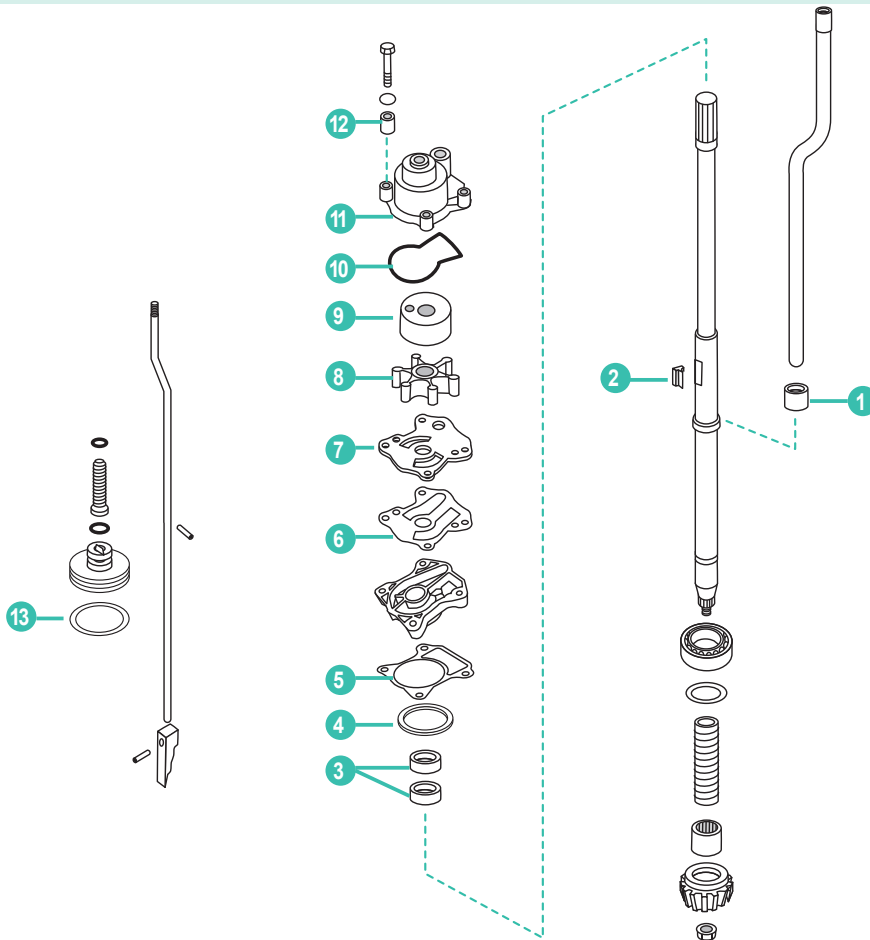

| | REF | OEM | | | | |
|----|------------------|---------------|--------------------|-------------------------|----------------------|-----------------------|
| 1 | REC19253-ZV5-000 | 19253-ZV5-000 | RETEN | SEAL | TENUTA | JOINT SPI |
| 2 | REC90752-ZV5-003 | 90752-ZV5-003 | CHAVETA | KEY | CHIUSURA | CLAVETTE |
| 3 | REC91251-ZV5-003 | 91251-ZV5-003 | RETEN | SEAL | TENUTA | JOINT SPI |
| 4 | REC91351-740-003 | 91351-740-003 | TORICA | O-RING | O-RING | JOINT TORIQUE |
| 5 | REC19242-ZV5-000 | 19242-ZV5-000 | JUNTA DE LA BOMBA | GASKET PUMPCASE | GUARNIZIONE POMPA | JOINT DE POMPE |
| 6 | REC19233-ZV5-000 | 19233-ZV5-000 | JUNTA | GASKET | GUARNIZIONE | JOINT |
| 7 | REC19231-ZV5-000 | 19231-ZV5-000 | PLACA | PLATE | PIASTRA | PLAQUE |
| 8 | REC19210-ZV5-003 | 19210-ZV5-003 | IMPULSOR | IMPELLER | GIRANTE | TURBINE |
| 9 | REC19223-ZV5-000 | 19223-ZV5-000 | TAPA DE LA BOMBA | COVER, INNER WATER PUMP | COPERCHIO POMPA ACQA | INSERT DE POMPE À EAU |
| 10 | REC91356-ZV5-000 | 91356-ZV5-000 | TORICA | O-RING | O-RING | JOINT TORIQUE |
| 11 | REC19221-ZV5-000 | 19221-ZV5-000 | CUERPO DE LA BOMBA | HOUSING, WATER PUMP | CORPO POMPA | CORS DE POMPE À EAU |
| 12 | REC91555-ZV5-000 | 91555-ZV5-00 | PASADOR | PIN | SPINOTTO | PIN |
| 13 | REC91353-ZV5-003 | 91353-ZV5-003 | TORICA | O-RING | O-RING | JOINT TORIQUE |

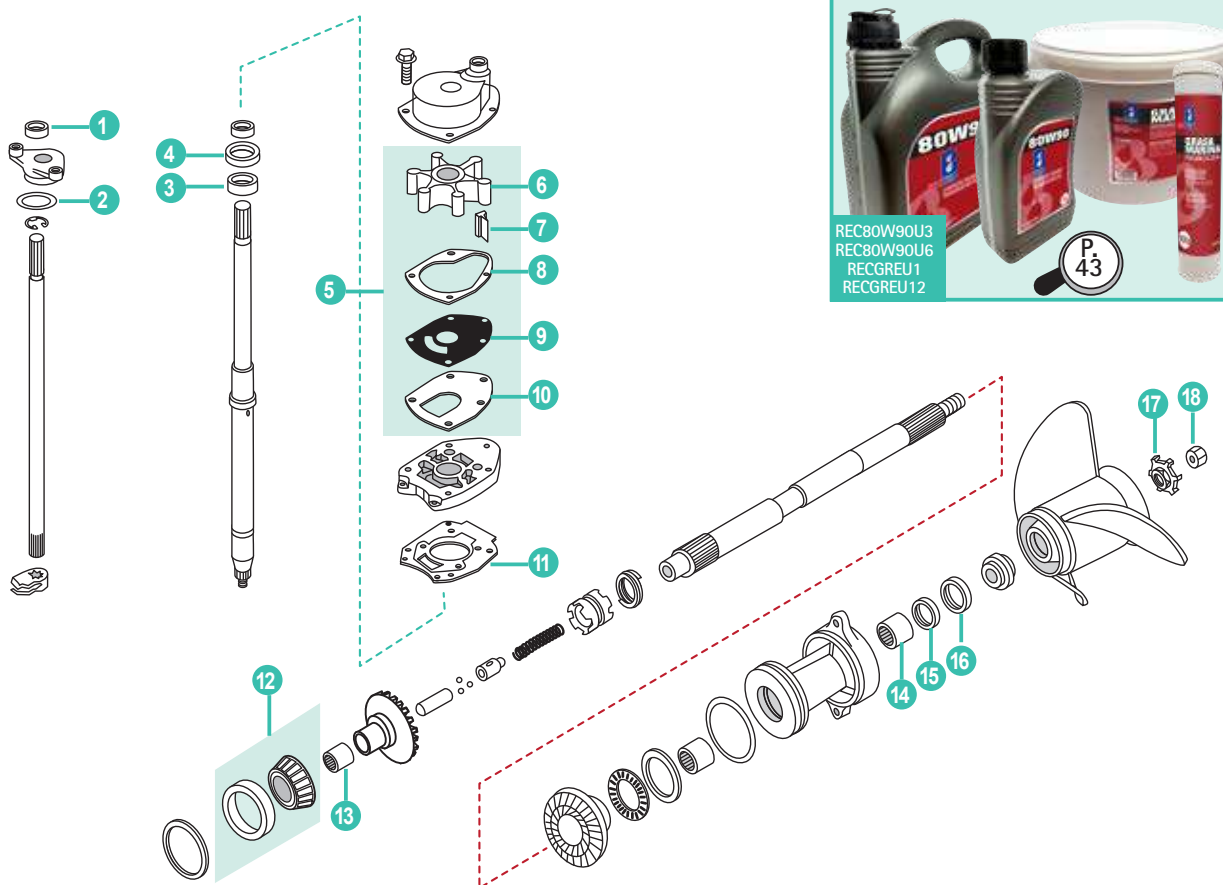

| | REF | OEM | | | | |
|----|------------------|---------------|--------------------|-----------------|-------------------|-------------------------|
| 1 | REC26-8164641 | 91253-ZW1-003 | RETÉN ACEITE | OIL SEAL | PARAOLIO | JOINT SPI |
| 2 | REC25-457101 | 91353-ZW1-003 | TORICA | O-RING | O-RING | JOINT TORIQUE |
| 3 | REC26-43036 | 91254-ZW1-003 | RETÉN ACEITE | OIL SEAL | PARAOLIO | JOINT SPI |
| 4 | REC26-43035 | 91251-ZW1-003 | RETÉN ACEITE | OIL SEAL | PARAOLIO | JOINT SPI |
| 5 | REC47-43026Q06 | 19021-ZW1-003 | KIT BOMBA AGUA | WATER PUMP KIT | KIT POMPA ACQUA | KIT POMPE À EAU |
| 6 | REC47-43026Q02 | 19120-ZW1-303 | IMPULSOR | IMPELLER | GIRANTE | TURBINE |
| 7 | REC90752-ZW1-B02 | 90752-ZW1-003 | CHAVETA IMPELLER | KEY | CHIUSSURA | CLAVETTE TURBINE |
| 8 | REC27-8172771 | 19232-ZW1-003 | JUNTA DE LA BOMBA | GASKET PUMPCASE | GUARNIZIONE POMPA | JOINT DE POMPE |
| 9 | REC8172761 | 19231-ZW1-003 | BASE INOX | OUTER PLATE | PIASTRA INOX | BASE INOX |
| 10 | REC27-430331 | 19234-ZW1-003 | JUNTA DE LA BOMBA | GASKET PUMPCASE | GUARNIZIONE POMPA | JOINT DE POMPE |
| 11 | REC27-430472 | 19242-ZW1-003 | JUNTA | GASKET | GUARNIZIONE | JOINT |
| 12 | REC31-30894A1 | 91051-ZW1-003 | RODAMIENTO AVAN. | BEARING FORWARD | CUSCINETTO AVANTI | ROULEMENT MARCHE AVANTE |
| 13 | REC31-30895T | 91057-ZW1-003 | RODAMIENTO | BEARING | CUSCINETTO | ROULEMENT |
| 14 | REC387247 | 91053-ZW1-003 | RODAMIENTO AGUJAS | NEEDLE BEARING | CUSCINETTO ASSE | ROULEMENT A AIGUILLE |
| 15 | REC26-76868 | 91252-ZW1-003 | RETEN | SEAL | TENUTA | JOINT SPI |
| 16 | REC26-70081 | 91351-ZW1-003 | RETEN | SEAL | TENUTA | JOINT SPI |
| 17 | REC90508-ZW1-003 | 90508-ZW1-003 | ARANDELA SEGURIDAD | WASHER TAB | RONDELLA | RONDELLE FREIN |
| 18 | REC90301-ZW1-003 | 90301-ZW1-003 | TUERCA HELICE | NUT PROPELLER | DADO ELICHE | ÉCROU |

COMPONENTES DE COLA

DRIVE COMPONENTS

COMPONENTI PIEDI

PIECES D' EMBASES

KITS JUNTAS Y RETENES

SEALS KITS

KIT GUARNIZIONE E TENUTE

KITS JOINTS D'EMBASE

| REF | OEM |
|--------------|-----|
| REC18-8362-1 | |

Series 14ZV50M
 BF35/45 AM BF40/50 A, AW, AX

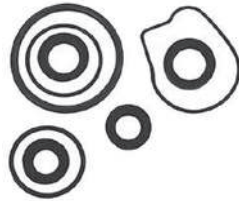

| REF | OEM |
|------------|-----|
| REC18-8363 | |

 BF9.9
BF15



| REF | OEM |
|------------|-----|
| REC18-8365 | |

 BF115
BF130



| REF | OEM |
|------------|-----|
| REC18-8366 | |

 BF75
BF90

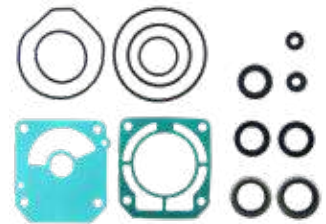

RETENES EJE DE TRASMISION

SEALS DRIVE SHAFT

TENUTE ASSE DI TRASMISSIONE

JOINTS SPI ARBRE DE TRANSMISSION

| REF | OEM |
|-------------|---------------|
| REC26-43036 | 91254-ZW1-003 |

 BF75AT
BF90AT



| REF | OEM |
|-------------|---------------|
| REC26-43035 | 91251-ZW1-003 |

 BF75AT
BF90AT



RETENES EJE DE HÉLICE

SEALS PROPELLER SHAFT

TENUTE ASSE ELICA

JOINTS SPI ARBRE D'HÉLICE

| REF | OEM |
|-------------|---------------|
| REC26-76868 | 91252-ZW1-003 |

 BF75AT
BF90AT



| REF | OEM |
|-------------|--------------------------------|
| REC26-70081 | 91255-ZW1-003 91351-ZW1-003 |

 BF75AT
BF90AT



RETENES EJE DE CAMBIO

SEALS SHIFT SHAFT

TENUTE ASSE DI CAMBIO

JOINTS SPI ARBRE DE CHANGEMENT

| REF | OEM |
|---------------|---------------|
| REC26-8164641 | 91253-ZW1-003 |

 BF75AT
BF90AT



JUNTA EJE SELECTOR

O-RING DRIVE SHAFT

GUARNIZIONE ASSE TRASMISSIONE

JOINTS D'ARBRE DE SELECTEUR

| REF | OEM |
|--------------|---------------|
| REC25-457101 | 91353-ZW1-003 |

 DF75AT
DF90AT



TUERCA DIÁBOLO

NUT, GEARCASE END

DADO DIAVOLO

ECROU DE DIABOLO

| REF | OEM |
|------------------|---------------|
| REC41109-ZV5-000 | 41109-ZV5-000 |

 BF35AM
 BF40B, B2, BX, A4, A/ A1, A2, AX, A3, AY
 BF45AM
 BF50A4, A/ A1, A2,AX, A3, AY



EJE HÉLICE

PROPELLER SHAFT

ASSE ELICA

ARBRE D'HELICE

| REF | OEM |
|------------------|---------------|
| REC41161-ZV5-000 | 41161-ZV5-000 |

 BF35AM
 BF40B, B2, BX, A4, A/ A1, A2, AX, A3, AY
 BF45AM
 BF50A4, A/ A1, A2,AX, A3, AY



RODAMIENTO PIÑÓN AVANTE

FORWARD GEAR BEARING

CUSCINETTO PIGNONE AVANTI

ROULEMENT DE PIGNON AVANT

| REF | OEM |
|---------------|---------------|
| REC31-30894A1 | 91051-ZW1-003 |

 BF75AT
 BT90AT



| REF | OEM |
|--------------|---------------|
| REC31-30895T | 91057-ZW1-003 |

 BF75AT
 BT90AT



RODAMIENTO DIÁBOLO

CARRIER BEARING

CUSCINETTO DIAVOLO

ROULEMENT DE DIABOLO

| REF | OEM |
|-----------|---------------|
| REC387247 | 91053-ZW1-003 |

 BF75AT
 BF90AT



ARANDELA DE CIERRE

TAB WASHER

RONDELLA CHIUSURA

RONDELLE FREIN

| REF | OEM |
|------------------|---------------|
| REC90508-ZW1-003 | 90508-ZW1-003 |

 BF75AT
 BF90AT



SISTEMA DE PROPULSIÓN PROPULSION SYSTEM

SISTEMA DI PROPULSIONE SYSTEME DE PROPULSION

HÉLICES ALUMINIO
E INOXIDABLE
DE 3 Y 4 PALAS

3 & 4 BLADE
ALUMINIUM & SS
PROPELLERS

ELICHE ALLUMINIO
E INOX DA 3 E 4
PALE

HELICE ALUMINIUM
ET INOX 3 ET 4
PALES

CÓDIGO DE REFERENCIAS

PART NO. CODING SYSTEM

SISTEMA DI CODICE

CODAGE DES REFERENCES

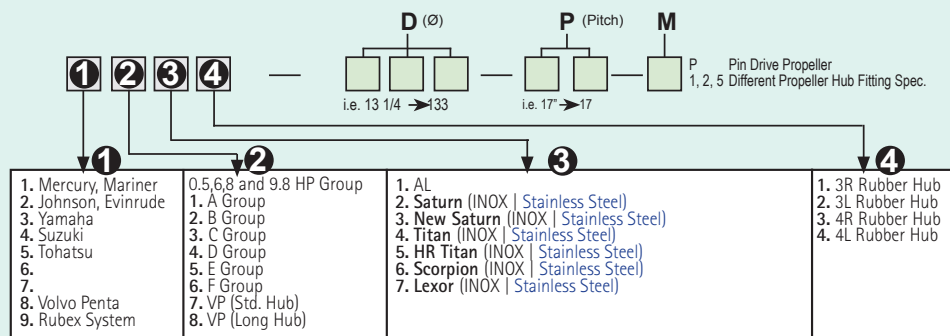

SOLAS

AMITA 3

SOLAS

Hélice de aluminio con núcleo de goma de gran resistencia.

Aluminum propeller with heavy duty rubber hub.

Eliche di alluminio con mozzi in gomma ad alta resistenza.

Hélice en aluminium avec moyeu en caoutchouc



AMITA 4

SOLAS

Hélices de aluminio con núcleo de goma de gran resistencia. Van muy suaves a poca velocidad y hace el barco muy manejable con la mar picada.

Aluminum propeller with heavy duty rubber hub. Smoother low speed makes the offshore boating activity much easier.

Eliche di alluminio con mozzo in gomma ad alta resistenza. Molto morbido a bassa velocità e rende la barca molto maneggevole con mare cattivo.

Hélice en aluminium avec moyeu en caoutchouc. Permet d'aller doucement à basse vitesse et rende le bateau très maniable lorsque la mer est agitée



TITAN

SOLAS

Hélices de acero inox. Diseño de pala grande para un área más grande. Gran capacidad de transporte de carga. Excelente economía de combustible.

Stainless steel propeller. High camber blade and large blade area design. Great load carrying capability. Excellent fuel economy.

Eliche in acciaio inossidabile. Ampia capacità di carico. Eccellente riduzione consumo del carburante.

Hélice en acier inoxydable. Lame à carrossage élevé et conception à grande surface de lame. Grande capacité de charge. Excellente économie de carburant.



NEW SATURN

SOLAS

Hélices de acero inoxidable. Ofrece buena aceleración y rendimiento. Tamaño más pequeño que ofrece un diámetro extragrande.

Stainless steel propeller. Offers good acceleration Et all-round performance. Smaller pitch sizes offered in extra large diameter with increased blade area.

Eliche di acciaio inox. Buona accelerazione. Piccole dimensioni che offre un più grande diametro.

Hélice inox, offrant de bonnes accélérations et performances. Taille de pas réduite pour les modèles de grands diamètres avec une surface de pale plus importante.

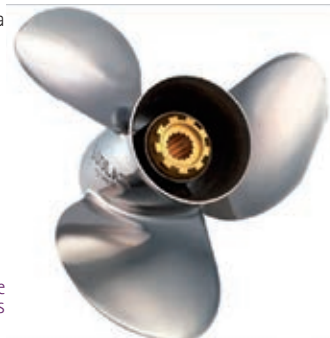

HR TITAN 3 PROP

SOLAS

Hélice de acero inoxidable. Alto rendimiento para cascos de alta velocidad. La inclinación de la hoja proporciona un excelente elevación de proa y aceleración. El diseño de copa grande aumenta la mordida y reduce el deslizamiento.

Stainless steel propeller. Performance prop for high speed planning hulls. High rake blade design provides excellent bow lift and acceleration. Heavy cup design increases bite and reduces slip.

Eliche in acciaio inox. Alte prestazioni per scafi ad alta velocità. Il passo della pala fornisce un'eccellente spinta e accelerazione. Il disegno aumenta le prestazioni.

Hélice en acier inoxydable. Hélice de performance pour les coques de planification à grande vitesse. La conception de la lame à haut râteau offre une excellente portance et accélération de l'arc. La conception lourde de la tasse augmente la morsure et réduit le glissement.



**GUÍA DE HÉLICES
CON NÚCLEO INTEGRADO**

**PROPELLERS APPLICATION
WITH RUBBER HUB**

**GUIDA ELICHE
CON MOZZO**

**GUIDE DES HELICES ET
MOYEURS**

| | R.O. OEM | AL | | | | INOX STAINLESS STEEL | | | | | | |
|---------------|-----------------|---|---|--------------------------------------|------------------|-------------------------|---------|-----------------|----------------|-------|----------------|----------------|
| | | A | B | D | P | R | AMITA 3 | AMITA 4 | NEW SATURN | TITAN | HR TITAN 3 | |
| | |  | | | | | | | | | | |
| BF2 Series | 58130-ZV0-841ZB | 3 | | 7 ^{1/4} | 6 | R | Plastic | SOL6001-073-06P | | | | |
| BF4 | | 3 | | 7 ^{7/8} | 6 ^{3/4} | R | | SOL6011-079-06P | | | | |
| BF5 | | | | | 7 ^{1/2} | | | SOL6011-079-07P | | | | |
| | | | | 9 ^{1/4} | 7 | | | SOL3111-093-07 | | | | |
| 8 (2001+) | 58130-ZV4-703ZB | | | 9 ^{1/2} | 8 ^{5/8} | | | SOL3111-093-08 | | | | |
| 9.9 (1988+) | 58130-ZV4-030ZB | 8 | 3 | 9 ^{1/2} | 9 ^{1/2} | R | | SOL3111-093-09 | | | | |
| 15 (1988+) | | | | 9 ^{1/4} | 10 | | | SOL3111-093-10 | | | | |
| 20 (2003+) | | | | 9 ^{1/4} | 11 | | | SOL3111-093-11 | | | | |
| | 58130-ZV7-850ZA | | | 9 ^{3/4} | 9 ^{7/8} | | | SOL5211-099-09 | | | | |
| | | | | | | | | SOL5211-099-10 | | | | |
| 25 | 58130-ZV7-000ZA | 10 | 3 | 9 ^{1/4} | 12 | R | | SOL5211-099-11 | | | | |
| 30 | | | | | | | | SOL5211-099-12 | | | | |
| | | | | | | | | SOL5211-099-13 | | | | |
| | 58130-ZV5-860ZA | | | 11 ^{3/4} | 10 | | | SOL3311-121-09 | | | | |
| | | | | | | | | SOL3311-116-11 | | | | |
| 35 (1991+) | 58130-ZV5-850ZA | | | 11 ^{1/2} | 12 | | | SOL3311-114-12 | | | | |
| 40 (1995+) | 58130-ZV5-000ZA | | | 11 ^{1/4} | 13 | | | SOL3311-111-13 | | | | |
| 45 (1991-94) | 58130-ZV5-870ZA | 13 | 3 | 11 ^{1/2} | 14 | R | | SOL3311-111-14 | | | | |
| BF40EFI | | | | | | | | SOL3311-110-15 | | | | |
| BF50EFI | | | | | | | | SOL3311-110-16 | | | | |
| BF60EFI | | | | | | | | SOL3311-110-17 | | | | |
| 50 (1995+) | | | | 11 | 16 | | | | | | | |
| | | | | 11 | 17 | | | | | | | |
| | 58130-ZW1-W01ZA | | | 14 | 11 | R | | SOL6411-140-11 | | | SOL6431-140-11 | |
| | 58130-ZW1-W11ZA | | | 13.75-13.25 | 13 | R | | SOL6411-138-13 | SOL6413-133-13 | | SOL6431-138-13 | |
| | | | | 13.5 | 14 | R | | SOL6411-135-14 | | | | |
| | | | | 13.5-13 | 15 | R | | SOL6411-135-15 | SOL6413-130-15 | | SOL6431-135-15 | |
| | 58130-ZW1-W31ZA | | | 13.5 | 15 | L | | SOL6412-135-15 | | | | |
| | | | | 13.25-12.75 | 17 | R | | SOL6411-133-17 | SOL6413-128-17 | | SOL6431-133-17 | |
| 75 (1995+) | 58130-ZW1-W61ZA | | | 13.25 | 17 | L | | SOL6412-133-17 | | | | |
| 90 (1995+) | 58130-ZW1-W41ZA | 15 | 3 | 13-12.5 | 19 | R | | SOL6411-130-19 | SOL6413-125-19 | | SOL6431-130-19 | |
| 115 (1998-09) | | | | 13-12.5 | 21 | R | | SOL6411-130-21 | SOL6413-125-21 | | SOL6431-130-21 | |
| 130 (1998-09) | | | | | | | | | | | | |
| BFP60A | 08M60-ZW7-A40 | | | 14 ^{1/2} | 15 | R | | | | | SOL1531-145-15 | |
| | | | | 14 ^{1/4} | 17 | R | | | | | SOL1531-143-17 | |
| | 08M60-ZW7-A00 | | | 14 | 19 | R | | | | | SOL1531-140-19 | |
| | 08M60-ZW7-A10 | | | 14 | 21 | R | | | | | SOL1531-140-21 | |
| | 08M60-ZW7-A20 | | | 14 | 23 | R | | | | | SOL1531-140-23 | |
| | 08M60-ZW7-A30 | | | 14 | 25 | R | | | | | SOL1531-140-25 | |
| | | | | 15-14.75 | 15 | R | | SOL1511-150-15 | SOL1513-148-15 | | | |
| | | | | 15 | 15 | L | | SOL1512-150-15 | | | SOL1532-145-15 | |
| | | | | 14.8-14.5 | 17 | R | | SOL1511-148-17 | SOL1513-145-17 | | | |
| | | | | 14.8 | 17 | L | | SOL1512-148-17 | | | SOL1532-143-17 | |
| | | | | 14.5-14.25 | 19 | R | | SOL1511-145-19 | SOL1513-143-19 | | | |
| | | | | 14.5 | 19 | L | | SOL1512-145-19 | | | SOL1532-140-19 | |
| | | | | 14 | 21 | R | | | SOL1513-140-21 | | | |
| | | | | 14 | 23 | R | | | SOL1513-140-23 | | | |
| | | | | 14.3 | 21 | R | | SOL1511-143-21 | | | | |
| | | | | 14.3 | 21 | L | | SOL1512-143-21 | | | SOL1532-140-21 | |
| | | | | 14.2 | 23 | R | | SOL1511-142-23 | | | | |
| | | | | 14.2 | 23 | L | | SOL1512-142-23 | | | SOL1532-140-23 | |
| | | 15 | 3 | 15 ^{1/2} -15 ^{3/4} | 15 | R | | | | | | SOL1571-158-15 |
| | | | | 15 ^{1/2} -15 ^{3/4} | 15 | L | | | | | SOL1542-155-15 | SOL1572-158-15 |
| | | | | 15 ^{1/4} -15 ^{1/2} | 17 | R | | | | | | SOL1571-155-17 |
| | | | | 15 ^{1/4} -15 ^{1/2} | 17 | L | | | | | | SOL1572-155-17 |
| | | | | 15-15 ^{1/4} | 19 | R | | | | | | SOL1571-153-19 |
| | | | | 15-15 ^{1/4} | 19 | L | | | | | SOL1542-150-19 | SOL1572-153-19 |
| | | | | 14 ^{3/4} -15 | 21 | R | | | | | | SOL1571-150-21 |
| | | | | 14 ^{3/4} -15 | 21 | L | | | | | | SOL1572-150-21 |
| | | | | 14 ^{1/2} -14 ^{3/4} | 23 | R | | | | | | SOL1571-148-23 |
| | | | | 14 ^{1/2} -14 ^{3/4} | 23 | L | | | | | | SOL1572-148-23 |
| | | | | 14 ^{1/2} | 25 | R | | | | | | SOL1571-145-25 |

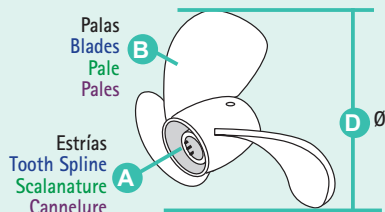



- P** Paso
Pitch
Passo
Pas
- R** Rotación L (izquierda) R (derecha)
Rotation L (left) R (Right)
Rotazione L (SX) R (DX)
Rotation L (gauche) R (droit)

HONDA

**RECAMBIOS
MARINOS**

NÚCLEO INTERCAMBIABLE INTERCHANGEABLE HUB

MOZZO INTERCAMBIABILE MOYEU INTERCHANGEABLE

|  | A | REF |  |
|---|----|------------|---|
| BF 35/45 (1991-94) | 13 | SOLRBX-113 | C |
| BF 40/50/50A (1995+) | 13 | SOLRBX-102 | D |
| 75-90 HP (1995-98) | 13 | SOLRBX-107 | D |
| 75-90 HP (1999+) | 13 | SOLRBX-107 | D |
| 115-130HP (1998+) | 15 | SOLRBX-107 | D |
| 115-130HP (1998+) | 15 | SOLRBX-107 | E |
| BF135, 150, 200, 225HP (2003+) | 15 | SOLRBX-107 | E |
| BF250 | | | |



RUBEX

HÉLICES PARA NÚCLEO INTERCAMBIABLE

PROPELLERS FOR INTERCHANGEABLE HUB

ELICHE PER MOZZO INTERCAMBIABILE

HELICES AVEC MOYEU INTERCHANGEABLE

|  | B | D | P | R | AL |
|---|----|-------|----------------|---|----------------|
| C 30-75 HP | 3 | 12.1 | 9 | R | SOL9311-121-09 |
| | | 12 | 10 | R | SOL9311-120-10 |
| | | 11.6 | 11 | R | SOL9311-116-11 |
| | | 11.4 | 12 | R | SOL9311-114-12 |
| | | 11.1 | 13 | R | SOL9311-111-13 |
| | | 11.1 | 14 | R | SOL9311-111-14 |
| D 40-140 HP | 3 | 11 | 15 | R | SOL9311-110-15 |
| | | 14 | 9 | R | SOL9411-140-09 |
| | | 14 | 11 | R | SOL9411-140-11 |
| | | 13.75 | 13 | R | SOL9411-138-13 |
| | | 13.50 | 15 | R | SOL9411-135-15 |
| | | 13.25 | 17 | R | SOL9411-133-17 |
| E 135-350 HP | 3 | 13.2 | 19 | R | SOL9411-132-19 |
| | | 13.2 | 21 | R | SOL9411-132-21 |
| | | 15.5 | 11 | R | SOL9511-155-11 |
| | | 15.3 | 13 | R | SOL9511-153-13 |
| | | 16 | 13 | R | SOL9511-160-13 |
| | | 15 | 15 | R | SOL9511-150-15 |
| | | 15 | 15 | L | SOL9512-150-15 |
| | | 14.8 | 17 | R | SOL9511-148-17 |
| | | 14.8 | 17 | L | SOL9512-148-17 |
| | | 14.5 | 19 | R | SOL9511-145-19 |
| 14.5 | 19 | L | SOL9512-145-19 | | |
| 14.3 | 21 | R | SOL9511-143-21 | | |
| 14.3 | 21 | L | SOL9512-143-21 | | |

|  | B | D | P | R | INOX STAINLESS STEEL |
|---|----|-----------------------|----------------|--------|-------------------------|
| C 30-75 HP | 3 | 11 5/8 | 11 | R | SOL9331-116-11 |
| | | 11 3/8 | 12 | R | SOL9331-114-12 |
| | | 11 1/8 | 13 | R | SOL9331-111-13 |
| | | 11 1/8 | 14 | R | SOL9331-111-14 |
| | | 11 | 15 | R | SOL9331-110-15 |
| | | D 40-140 HP | 3 | 13 3/4 | 13 |
| 13 3/4 | 13 | | | L | SOL9432-138-13 |
| 13 1/2 | 15 | | | R | SOL9431-135-15 |
| 13 1/2 | 15 | | | L | SOL9432-135-15 |
| 13 1/4 | 17 | | | R | SOL9431-133-17 |
| 13 1/4 | 17 | | | L | SOL9432-133-17 |
| E 90-140 HP | 3 | 13 | 19 | R | SOL9431-130-19 |
| | | 13 | 19 | L | SOL9432-130-19 |
| | | 13 | 21 | R | SOL9431-130-21 |
| | | 14 1/2 | 15 | R | SOL9531-145-15 |
| | | 14 1/2 | 15 | L | SOL9532-145-15 |
| | | 14 1/4 | 17 | R | SOL9531-143-17 |
| | | 14 1/4 | 17 | L | SOL9532-143-17 |
| | | 14 | 19 | R | SOL9531-140-19 |
| | | 14 | 19 | L | SOL9532-140-19 |
| | | 14 | 21 | R | SOL9531-140-21 |
| E 135-350 HP | 3 | 14 | 21 | L | SOL9532-140-21 |
| | | 14 | 23 | R | SOL9531-140-23 |
| | | 14 | 23 | L | SOL9532-140-23 |
| | | 15 3/4 | 15 | R | SOL9571-158-15 |
| | | 15 3/4 | 15 | L | SOL9572-158-15 |
| | | 15 1/2 | 17 | R | SOL9571-155-17 |
| | | 15 1/2 | 17 | L | SOL9572-155-17 |
| | | 15 1/4 | 19 | R | SOL9571-153-19 |
| | | 15 1/4 | 19 | L | SOL9572-153-19 |
| | | 15 | 21 | R | SOL9571-150-21 |
| 15 | 21 | L | SOL9572-150-21 | | |
| 14 3/4 | 23 | R | SOL9571-148-23 | | |
| 14 3/4 | 23 | L | SOL9572-148-23 | | |
| 14 1/2 | 25 | R | SOL9571-145-25 | | |
| 14 1/2 | 25 | L | SOL9572-145-25 | | |

RUBEX



Núcleo intercambiable (no incluido).
Interchangeable hub (not included).
Mozzo intercambiabile (non incluso).
Moyeu interchangeable (non inclus)



REF --> RO / OEM

| REF | R.O. / OEM | |
|-------------------|-----------------|-------------|
| C | | |
| CEF500301 | 19210-ZW1-303 | 568 |
| CEF500328 | 19210-ZV4-013 | 568 |
| CEF500337 | 19210-ZW1-B04 | 568 |
| CEF500338 | 19210-ZV5-003 | 568 |
| CEF500339 | 19210-ZV7-003 | 568 |
| CEF500343 | 19210-ZV4-651 | 568 |
| CEF500347 | 19210-ZW9-013 | 568 |
| CEF500348 | 19210-ZW9-A32 | 568 |
| CEF500391 | 19210-ZY3-003 | 568 |
| CM06411-ZV5-000 | 06411-ZV5-000 | 571 |
| CM06411-ZV5-000 | 06411-ZV5-020 | 571 |
| CM06411-ZV5-000A | 06411-ZV5-000 | 571 |
| CM06411-ZV5-000A | 06411-ZV5-020 | 571 |
| CM06411-ZW1-000 | 06411-ZW1-000 | 571 |
| CM06411-ZW1-000 | 06411-ZW1-020 | 571 |
| CM06411-ZW1-000A | 06411-ZW1-000 | 571 |
| CM06411-ZW1-000A | 06411-ZW1-020 | 571 |
| CM31640 | 06412-ZV1-000 | 571 |
| CM31640 | 41107ZV1003 | 571 |
| CM31640A | 06412-ZV1-000 | 571 |
| CM31640A | 41107ZV1003 | 571 |
| CM41106-ZW9-000A | 41106-ZW9-000 | 572 |
| CM41106-ZW9-000A | 41106ZV909000 | 572 |
| CM41106-ZW9-09000 | 41106-ZW9-000 | 571 |
| CM41106-ZW9-09000 | 41106ZV909000 | 571 |
| CM41106-ZW9-09000 | 41106-ZW9-090 | 545 |
| CM41107-ZV500 | 06412-ZV5-000 | 571 |
| CM41107-ZV500 | 41107ZV500 | 571 |
| CM41107-ZV500A | 06412-ZV5-000 | 572 |
| CM41107-ZV500A | 41107ZV500 | 572 |
| CM41107-ZV500A | 41107-ZV5-000 | 545 |
| CM41107-ZW1-B01 | 41107ZV1-B01 | 571 |
| CM41107-ZW1-B01A | 41107ZV1-B01 | 571 |
| CM41109-ZW1-B00 | 41109-ZW1-B00 | 571 |
| CM41109-ZW1-B00A | 41109-ZW1-B00 | 571 |
| CM664-45371-01 | 06412-ZV5-000 | 571 |
| CM664-45371-01A | 06412-ZV5-000 | 571 |
| CM6E0-45251-11 | 2155-ZV5-000 | 571 |
| CM6E0-45251-11A | 2155-ZV5-000 | 571 |
| CM826134 | 12155-ZV5-000 | 571 |
| CM826134 | 41109-ZW1-003 | 571 |
| CM826134A | 12155-ZV5-000 | 571 |
| CM826134A | 41109-ZW1-003 | 571 |
| CMHBF35225KITA | | 546-571 |
| CMHBF35225KITM | | 571 |
| CMHBF4050KITA | | 545-546-571 |
| CMHBF4050KITM | | 571 |
| CMHBF75115KITA | | 546-571 |
| CMHBF75115KITM | | 571 |
| CHACJ14 | | 559 |
| CHAP10Y | | 559 |
| CHAP8Y | | 559 |
| CHAPROSU | | 559 |
| CHARA6HC | | 559 |
| CHARA8HC | | 559 |
| CHARC9MC4 | | 559 |
| CHARN11YC4 | | 559 |
| G | | |
| GS11290 | | 561 |
| GS11291 | | 561 |
| GS11292 | | 561 |
| GS11294 | | 561 |
| GS30435 | | 552 |
| GS31001 | | 552 |
| GS31002 | | 552 |
| GS31030 | 17660-ZV5-902 | 548 |
| GS31031 | 17660-ZV5-A00 | 548 |
| GS31031 | 17660-ZW9-003 | 548 |
| GS31032 | 116977-ZV5-900 | 549 |
| GS31033 | 116977-ZV5-A00 | 549 |
| GS31034 | 17650-921-003ZB | 548 |
| GS31064 | | 549 |
| GS31065 | | 552 |
| GS31066 | | 552 |
| GS31067 | | 552 |
| GS31068 | | 548 |
| GS31069 | | 548 |
| GS31090 | | 547 |
| GS31095 | | 547 |
| GS31096 | | 547 |
| GS31097 | | 547 |
| GS31099 | | 547 |
| GS31155 | | 552 |
| GS31156 | | 552 |
| GS31157 | | 552 |
| GS31166 | | 552 |
| GS31183 | | 547 |
| GS31187 | | 547 |
| GS31189 | | 547 |
| GS35031 | | 547 |
| GS35032 | | 547 |
| L | | |
| LENS3213 | 17670-ZW1-801AH | 550-551 |
| LENS3227 | | 550 |
| LENS3240 | 17670-ZW1-030GH | 551 |
| N | | |
| NGKBMR4A | | 559 |
| NGKBPRES5 | 98079-55846 | 545-559 |
| NGKCR5EH-9 | 98059-55916 | 545-559 |
| NGKCR5HSB | | 559 |
| NGKDR4HS | | 559 |

| REF | R.O. / OEM | |
|------------------|-----------------|-----------------|
| NGKDR5HS | 98066-55716 | 559 |
| NGKDR6HS | | 545-559 |
| NGKDR7EA | 98069-5771P | 545-546-559 |
| NGKDR7E | 98069-5777P | 546 |
| NGKIZFR6K-11E | 31916-ZX2-003 | 559 |
| NGKIZFR6K11 | 31916-ZY3-003 | 546-559 |
| NGKLMAR6C-9 | 31908-ZZ3-003 | 546-559 |
| NGKZFR7F | | 546-559 |
| P | | |
| PAF15-04000003 | 90507-921-000 | 545-546 |
| PAF15-07000031 | 19300-881-741 | 566 |
| PAF15-07000031 | 19300-921-003 | 566 |
| PAF15-07000031 | 19300-ZW9-003 | 566 |
| PAF15-07000031 | 19300-ZW9-003 | 545-546-566-567 |
| PAF4-04000030 | | 548 |
| PAF4-05000010 | | 548 |
| PAF40-0701000E1 | | 550 |
| PAGB/T91-2.5X30 | 90758-ZV1-000 | 545-546 |
| PH130-0054 | 31200-ZV5-003 | 560 |
| PH130-0054 | 31200-ZV5-013 | 560 |
| PH130-0064 | 31200-ZW1-004 | 560 |
| PH130-0065 | 31200-ZW5-003 | 560 |
| PH130-0070 | 31200-ZY3-003 | 560 |
| PH130-0070 | 31200-ZY3A-0034 | 560 |
| PH200-T021 | 36120-ZV5-821 | 562 |
| PH200-T046 | 36120-ZV5-822 | 562 |
| PH200-WH01 | | 562 |
| PRE3300C05 | 24911-ZW7-U01 | 565 |
| PRE3300C06 | 24912-ZW7-U01 | 565 |
| PRE3300C07 | 24913-ZW7-U01 | 565 |
| PRE3300C08 | 24914-ZW7-U01 | 565 |
| PRE3300C09 | 24915-ZW7-U01 | 565 |
| PRE3300C10 | 24916-ZW7-U01 | 565 |
| PRE3300C11 | 24917-ZW7-U01 | 565 |
| PRE3300C12 | 24918-ZW7-U01 | 565 |
| PRE3300C13 | 24919-ZW7-U01 | 565 |
| PRE3300C14 | 24920-ZW7-U01 | 565 |
| PRE3300C15 | 24921-ZW7-U01 | 565 |
| PRE3300C16 | 24922-ZW7-U01 | 565 |
| PRE3300C17 | 24923-ZW7-U01 | 565 |
| PRE3300C18 | 24924-ZW7-U01 | 565 |
| PRE3300C19 | 24925-ZW7-U01 | 565 |
| PRE3300C20 | 24926-ZW7-U01 | 565 |
| PRE3300C21 | 24927-ZW7-U01 | 565 |
| PRE3300C22 | 24928-ZW7-U01 | 565 |
| PRE3300C23 | 24929-ZW7-U01 | 565 |
| PRE3300C24 | 24930-ZW7-U01 | 565 |
| PRE3300C25 | 24931-ZW7-U01 | 565 |
| PRE3300C26 | 24932-ZW7-U01 | 565 |
| PRE3300C27 | 24933-ZW7-U01 | 565 |
| PRE3300C28 | 24934-ZW7-U01 | 565 |
| PRE3300C29 | 24935-ZW7-U01 | 565 |
| PRE3300C30 | 24936-ZW7-U01 | 565 |
| PRE3300C31 | 24937-ZW7-U01 | 565 |
| PRE3300C32 | 24938-ZW7-U01 | 565 |
| R | | |
| RAC025-RAC-02 | 06176-ZW3-801AH | 553 |
| RAC120R-RAC-01 | 06178-ZW1-030GH | 551 |
| RAC23289-10 | | 550 |
| RAC23299-10 | | 550 |
| RAC320R-INOX-01 | 06177-ZW1-801AH | 551 |
| RAC320R-INOX-02 | | 551 |
| RAC320R-RAC-01 | | 550-551 |
| RAC320R-RAC-02 | | 551 |
| RAC320R-RAC-03 | 06177-ZW1-801AH | 550-551 |
| RAC490R-RAC-01 | | 550 |
| RACPF5510 | | 549 |
| RACRK22628 | | 552 |
| RACS2502 | 17670-ZW3-801AH | 553 |
| RACS3213 | 17670-ZW1-801AH | 550-551 |
| RACS3220UL | | 551 |
| RACS3227 | | 550 |
| RACS3240 | 17670-ZW1-030GH | 551 |
| REC004 | | 559 |
| REC06160-ZV4-U11 | 06160-ZV4-U11 | 556 |
| REC06164-PCA-000 | 06164-PCA-000 | 555 |
| REC06192-881-C00 | 06192-881-C00 | 570 |
| REC06192-ZV1-000 | 06192-ZW1-000 | 546-570 |
| REC06192-ZV1-000 | 06192-ZV1-000 | 570 |
| REC06192-ZV1-305 | 06192-ZV1-305 | 546-570 |
| REC06192-ZV1-305 | 06192-ZW1-305 | 570 |
| REC06192-ZV1-C00 | 06192-ZV1-C00 | 545-570 |
| REC06192-ZV4-000 | 06192-ZV4-000 | 545-570 |
| REC06192-ZV4-000 | 19210-ZV4-651 | 570 |
| REC06192-ZV5-003 | 06192-ZV5-003 | 545-546-570 |
| REC06192-ZV7-000 | 06192-ZV7-000 | 545-570 |
| REC06192-ZV7-000 | 06192-ZW2-000 | 570 |
| REC06192-ZW9-A30 | 06192-ZW9-A30 | 545-570 |
| REC06192-ZY3-000 | 06192-ZX2-000 | 570 |
| REC06192-ZY3-000 | 06192-ZY3-000 | 570 |
| REC06192-ZY3-000 | 06192-ZY3-000 | 546 |
| REC06192-ZY6-000 | 06192-ZY6-000 | 546-570 |
| REC06193-ZV5-020 | 06193-ZV5-000 | 570 |
| REC06193-ZV5-020 | 06193-ZV5-010 | 570 |

| REF | R.O. / OEM | |
|--------------------|-------------------|-------------|
| REC06193-ZV5-020 | 06193-ZV5-020 | 570 |
| REC06211-ZV1-505 | 06211-ZV1-505 | 545 |
| REC06211-ZV4-505 | 06211-ZV4-505 | 545 |
| REC06211-ZV5-505 | 06211-ZV5-505 | 545 |
| REC06211-ZV7-505 | 06211-ZV7-505 | 545 |
| REC06211-ZW0-505 | 06211-ZW0-505 | 546 |
| REC06211-ZW5-505 | 06211-ZW5-505 | 546 |
| REC06211-ZW9-505 | 06211-ZW9-505 | 545 |
| REC06211-ZY0-505 | 06211-ZY0-505 | 545 |
| REC06211-ZY2-506 | 06211-ZY2-506 | 546 |
| REC06211-ZY5-505 | 06211-ZY5-505 | 546 |
| REC06211-ZY9-505 | 06211-ZY9-505 | 546 |
| REC06211-ZZ3-506 | 06211-ZZ3-506 | 546 |
| REC06211-ZZ5-505 | 06211-ZZ5-505 | 546 |
| REC06240-ZW5-U40 | 06240-ZW5-U40 | 564 |
| REC06240-ZW5-U40 | 06240-ZW5-U001 | 564 |
| REC06240-ZW5-U60 | 06240-ZW5-U60 | 564 |
| REC09401-11425 | | 548 |
| REC09401-11425BULK | | 548 |
| REC09401-11425BULK | | 548 |
| REC10W30U3 | 08207-10W30M-FC-W | 553 |
| REC10W30U6 | 08209-10W30M-FC-W | 553 |
| REC10W40U3 | | 553 |
| REC10W40U6 | | 553 |
| REC12-191833 | 12-191833 | 545-546-574 |
| REC12209-6B4-681 | 12209-GB4-681 | 575 |
| REC12251-ZV5-003 | 12251-ZW4-H01 | 574 |
| REC12251-ZV5-003 | 12251-ZV5-000 | 573 |
| REC12251-ZV5-003 | 12251-ZV5-003 | 573 |
| REC12251-ZV7-004 | 12251-ZV7-004 | 573 |
| REC12251-ZW1-014 | 12251-ZW1-004 | 573 |
| REC12251-ZW1-014 | 12251-ZW1-014 | 573 |
| REC12251-ZW5-023 | 12251-ZW5-003 | 573 |
| REC12251-ZW5-023 | 12251-ZW5-023 | 573 |
| REC14400-ZV5-014 | 14400-ZV5-004 | 574 |
| REC14400-ZV5-014 | 14400-ZV5-014 | 574 |
| REC14400-ZZ3-004 | 14400-ZZ3-004 | 574 |
| REC15112-ZW5-003 | 15112-ZW5-003 | 573 |
| REC15400-PLM-A01PE | 15400-PH1-F03 | 554 |
| REC15400-PLM-A01PE | 15400-PLM-A01PE | 554 |
| REC15400-PLM-A01PE | 15400-POH-305 | 554 |
| REC15400-PLM-A01PE | 15400-POH-305PE | 554 |
| REC15400-PLM-A01PE | 15400-RTA-003 | 554 |
| REC15400-PLM-A01PE | 15400-RTA-004 | 554 |
| REC15400-PLM-A01PE | 15400-ZJI-004 | 546-554 |
| REC15400-RBA-F01 | 15400-RBA-F01 | 546-554 |
| REC16010-ST5-993 | 16900-ST5-993 | 553 |
| REC16010-ZV4-005 | 06160-ZV4-U11 | 556 |
| REC16010-ZV4-005 | 16010-ZV4-005 | 556 |
| REC16010-ZV4-005 | 16010-ZV4-005 | 556 |
| REC16010-ZW9-003 | 16010-ZW9-003 | 556 |
| REC16011-881-741 | 16011-881-741 | 555 |
| REC16011-ZV4-005 | 16011-ZV4-005 | 555 |
| REC16201-881-850 | 16201-881-850 | 575 |
| REC16221-ZV4-610 | 16221-ZV4-610 | 575 |
| REC16221-ZW1-000 | 16221-ZW1-000 | 575 |
| REC16221-ZW9-000 | 16221-ZW9-000 | 576 |
| REC16700-ZW1-004 | 16700-ZW1-004 | 555 |
| REC16700-ZW1-004 | 16700-ZV5-003 | 555 |
| REC16735-ZW5-003 | 16735-ZW5-003 | 555 |
| REC16735-ZW5-003 | 16735-ZY3-004 | 555 |
| REC16900-SA5-004 | 16900-SA5-004 | 545-546-552 |
| REC16900-SR3-004 | 16900-SR3-004 | 546-552 |
| REC16901-ZY3-003 | 16901-ZY3-003 | 553 |
| REC16901-ZY3-003 | 16911-ZY3-003 | 553 |
| REC16910-GB2-005 | 16900-GB2-005 | 545-552 |
| REC16910-ZV4-015 | 16910-ZV4-015 | 545-552 |
| REC16911-ZY3-010 | 16911-ZY3-010 | 546-553 |
| REC16911-ZZ5-003 | 16911-ZZ5-003 | 546-553 |
| REC17105-ZY3-004 | 17105-ZY3-004 | 575 |
| REC17105-ZY6-000 | 17105-ZY6-000 | 575 |
| REC17109-ZY3-004 | 17109-ZY3-004 | 575 |
| REC17109-ZY6-000 | 17109-ZY6-000 | 575 |
| REC17151-ZY5-000 | 17151-ZY5-000 | 575 |
| REC17384-ZW4-000 | 17384-ZW4-000 | 574 |
| REC17710-ZW9-033 | 17710-ZW9-023 | 548 |
| REC17710-ZW9-033 | 17710-ZW9-033 | 548 |
| REC18-6865 | | 563 |
| REC18-7053 | | 556 |
| REC18-8362-1 | | 578 |
| REC18-8363 | | 578 |
| REC18-8365 | | 578 |
| REC18-8366 | | 578 |
| REC19210-881-003 | 19210-881-003 | 568 |
| REC19210-881-003 | 19210-881-A01 | 568 |
| REC19210-881-003 | 19210-881-A02 | 568 |
| REC19210-881-003 | 19210-881-A02 | 568 |
| REC19210-ZV4-013 | 19210-ZV4-013 | 567-568 |
| REC19210-ZV4-651 | 19210-ZV4-651 | 567-568 |
| REC19210-ZV5-003 | 19210-ZV5-003 | 546-568-576 |
| REC19210-ZV7-003 | 19210-ZV7-003 | 567-568 |
| REC19210-ZW1-B02 | 19210-ZW1-B02 | 568 |
| REC19210-ZW1-B02 | 19210-ZW1-B03 | 568 |
| REC19210-ZW1-B02 | 19210-ZW1-B04 | 568 |

| REF | R.O. / OEM | | REF | R.O. / OEM | | REF | R.O. / OEM | |
|------------------|-----------------|-------------|------------------|---------------------|-------------|-----------------|-----------------|-----|
| REC19210-ZW9-013 | 19210-ZW9-013 | 545-568 | REC37260-RNA-A01 | 37260-RNA-A01 | 557 | SOL1531-140-23 | 08M60-ZW7-A20 | 581 |
| REC19210-ZW9-A32 | 19210-ZW9-A31 | 568 | REC37500-PNB-003 | 37500-PNB-003 | 557 | SOL1531-140-25 | 08M60-ZW7-A30 | 581 |
| REC19210-ZW9-A32 | 19210-ZW9-A32 | 568 | REC37510-PNB-003 | 37510-PNB-003 | 557 | SOL1531-143-17 | 58233-ZY3-A17H | 581 |
| REC19210-ZW9-A32 | 19210-ZW9-A32 | 568 | REC37830-PGK-A01 | 37830-PGK-A01 | 557 | SOL1531-145-15 | 08M60-ZW7-A40 | 581 |
| REC19210-ZY3-003 | 19210-ZY3-003 | 568 | REC37830-PNC-003 | 37830-PNC-003 | 557 | SOL1532-140-19 | 58233-ZY3-B19H | 581 |
| REC19210-ZY9-H01 | 19210-ZY9-H01 | 567-568 | REC37830-RNA-A01 | 37830-RNA-A01 | 557 | SOL1532-140-21 | | 581 |
| REC19221-ZV5-000 | 19221-ZV5-000 | 576 | REC37840-R70-A01 | 37840-R70-A01 | 557 | SOL1532-140-23 | | 581 |
| REC19223-ZV5-000 | 19223-ZV5-000 | 576 | REC37880-PLC-004 | 37880-PLC-004 | 558 | SOL1532-143-17 | 58233-ZY3-B17H | 581 |
| REC19231-ZV5-000 | 19231-ZV5-000 | 576 | REC38550-ZV5-823 | 38550-ZV5-823 | 563 | SOL1532-145-15 | 58233-ZY3-B15H | 581 |
| REC19232-881-850 | 19232-881-850 | 569 | REC38550-ZY6-003 | 38550-ZY6-003 | 563 | SOL1542-150-19 | | 581 |
| REC19232-ZV1-A10 | 19232-ZV1-A10 | 569 | REC38550-ZY6-003 | HZY-638550-003 | 563 | SOL1542-155-15 | | 581 |
| REC19232-ZV4-610 | 19232-ZV4-610 | 569 | REC38580-ZY6-013 | 38580-ZY6-003/13 | 558 | SOL1571-145-25 | | 581 |
| REC19233-ZV5-000 | 19233-ZV5-000 | 569-576 | | 38580-ZY9-023/13/03 | 558 | SOL1571-148-23 | | 581 |
| REC19234-881-850 | 19234-881-850 | 569 | REC38580-ZY9-023 | | | SOL1571-150-21 | | 581 |
| REC19234-ZY3-000 | 19234-ZY3-000 | 569 | REC38580-ZY9-023 | HZY-38580-003 | 558 | SOL1571-153-19 | | 581 |
| REC19242-ZV5-000 | 19242-ZV5-000 | 569-476 | REC387247 | 91053-ZW1-003 | 577-579 | SOL1571-155-17 | | 581 |
| REC19253-ZV5-000 | 19253-ZV5-000 | 576 | REC40135 | | 552 | SOL1571-158-15 | | 581 |
| REC19300-881-761 | 19300-881-761 | 545-566-567 | REC40145 | | 552 | SOL1572-148-23 | | 581 |
| REC19300-ZV5-043 | 19300-ZV5-003 | 566 | REC40155 | | 552 | SOL1572-150-21 | | 581 |
| REC19300-ZV5-043 | 19300-ZV5-013 | 566 | REC40165 | | 552 | SOL1572-153-19 | | 581 |
| REC19300-ZV5-043 | 19300-ZV5-023 | 566 | REC40970 | | 561 | SOL1572-155-17 | | 581 |
| REC19300-ZV5-043 | 19300-ZV5-033 | 566 | REC40990 | | 561 | SOL1572-158-15 | | 581 |
| REC19300-ZV5-043 | 19300-ZV5-043 | 566 | REC41109-ZV5-000 | 41109-ZV5-000 | 579 | SOL3111-093-07 | | 581 |
| REC19300-ZV5-043 | 19300-ZV5-043 | 546-566-567 | REC41161-ZV5-000 | 41161-ZV5-000 | 579 | SOL3111-093-08 | 58130-ZV4-703ZB | 581 |
| REC22-8M0001721 | | 548 | REC47-43026Q02 | 19120-ZW1-303 | 577 | SOL3111-093-09 | 58130-ZV4-030ZB | 581 |
| REC23172-ZW1-013 | 23172-ZW1-013 | 573 | REC47-43026Q02 | 19210-ZW1-303 | 567-568 | SOL3111-093-10 | | 581 |
| REC23172-ZW5-013 | 23172-ZW5-000 | 573 | REC47-43026Q06 | 19021-ZW1-003 | 570-577 | SOL3111-093-11 | | 581 |
| REC23172-ZW5-013 | 23172-ZW5-013 | 573 | REC5GH-13440-00 | 15400-PFB-007 | 554 | SOL3311-110-15 | | 581 |
| REC24800-ZZ5-A02 | 24800-ZZ5-A01 | 564 | REC5W40U3 | 08207-5W30M2 | 553 | SOL3311-110-16 | | 581 |
| REC24800-ZZ5-A02 | 24800-ZZ5-A02 | 564 | REC5W40U6 | | 553 | SOL3311-110-17 | | 581 |
| REC24800-ZZ5-A02 | 24800-ZZ5-A22 | 549 | REC650-24351-51 | | 548 | SOL3311-111-13 | 58130-ZV5-000ZA | 581 |
| REC24942 | 06177-ZX2-000HE | 549 | REC67F-12411-01 | 19300-ZX2-003 | 566-567 | SOL3311-111-14 | 58130-ZV5-870ZA | 581 |
| REC24950 | | 549 | REC6AH-12411-00 | 19300-ZY3-023 | 566-567 | SOL3311-114-12 | 58130-ZV5-850ZA | 581 |
| REC24952 | | 549 | REC6E5-12411-30 | 19300-ZY6-003 | 566-567 | SOL3311-116-11 | | 581 |
| REC24952 | 06177-ZX2-000HE | 549 | REC6E5-24351-51 | | 548 | SOL3311-121-09 | 58130-ZV5-860ZA | 581 |
| REC25-457101 | 91353-ZW1-003 | 577 | REC70720 | | 552 | SOL5211-099-09 | 58130-ZV7-850ZA | 581 |
| REC25-457101 | 91353-ZW1-003 | 578 | REC80W90U3 | 08739-90W | 553 | SOL5211-099-10 | | 581 |
| REC25000 | | 549 | REC80W90U6 | | 553 | SOL5211-099-11 | 58130-ZV7-000ZA | 581 |
| REC25010 | | 549 | REC8172761 | 19231-ZW1-003 | 569-577 | SOL5211-099-12 | | 581 |
| REC25020 | | 549 | REC855686 | | 549 | SOL5211-099-13 | | 581 |
| REC25030 | | 549 | REC90301-ZW1-003 | 90301-ZW1-003 | 577 | SOL6001-073-06P | 58130-ZV0-841ZB | 581 |
| REC25W40U3 | | 553 | REC90508-ZW1-003 | 90508-ZW1-003 | 577-579 | SOL6011-079-06P | | 581 |
| REC26-43035 | 91251-ZW1-003 | 577-578 | REC90752-ZV4-650 | 90752-ZV4-650 | 569 | SOL6011-079-07P | | 581 |
| REC26-43036 | 91254-ZW1-003 | 577-578 | REC90752-ZV5-003 | 90752-ZV5-003 | 546-569-576 | SOL6411-130-19 | 58130-ZW1-W41ZA | 581 |
| REC26-70081 | 91255-ZW1-003 | 578 | REC90752-ZV7-000 | 90752-ZV7-000 | 569 | SOL6411-130-21 | 58130-ZW1-W41ZA | 581 |
| REC26-70081 | 91351-ZW1-003 | 577-578 | REC90752-ZW1-B02 | 90752-ZW1-003 | 577 | SOL6411-133-17 | 58130-ZW1-W31ZA | 581 |
| REC26-76868 | 91252-ZW1-003 | 577-578 | REC90752-ZW1-B02 | 90752-ZW1-B02 | 569 | SOL6411-135-14 | | 581 |
| REC26-8164641 | 91253-ZW1-003 | 577-578 | REC90752-ZY3-003 | 90752-ZY3-003 | 569 | SOL6411-135-15 | 58130-ZW1-W21ZA | 581 |
| REC27-430331 | 19234-ZW1-003 | 569-577 | REC90794-46866 | | 551 | SOL6411-138-13 | 58130-ZW1-W11ZA | 581 |
| REC27-430472 | 19242-ZW1-003 | 569-577 | REC90794-46866 | | 551 | SOL6411-140-11 | 58130-ZW1-W01ZA | 581 |
| REC27-8172771 | 19232-ZW1-003 | 569-577 | REC91251-ZV5-003 | 91251-ZV5-003 | 576 | SOL6412-133-17 | 58130-ZW1-W61ZA | 581 |
| REC2TU3 | | 553 | REC91252-935-004 | 91252-935-004 | 570 | SOL6412-135-15 | 58130-ZW1-W31ZA | 581 |
| REC2TU6 | | 553 | REC91252-ZV1-003 | 91252-ZV1-003 | 570 | SOL6413-125-19 | 58130-ZW1-W41ZA | 581 |
| REC30520-PNA-007 | 30520-PNA-007 | 559 | REC91351-740-003 | 91351-740-003 | 576 | SOL6413-125-21 | 58130-ZW1-W41ZA | 581 |
| REC30520-PWC-003 | 30520-PWC-S01 | 559 | REC91353-ZV5-003 | 91353-ZV5-003 | 576 | SOL6413-128-17 | 58130-ZW1-W31ZA | 581 |
| REC30520-ZVL-003 | 30520-ZVL-003 | 559 | REC91356-ZV5-000 | 91356-ZV5-000 | 576 | SOL6413-130-15 | 58130-ZW1-W21ZA | 581 |
| REC30520-ZX2-003 | 30520-ZX2-003 | 559 | REC91555-ZV5-000 | 91555-ZV5-000 | 576 | SOL6413-133-13 | 58130-ZW1-W11ZA | 581 |
| REC30520-ZY3-003 | 30520-ZY3-003 | 559 | RECOBRACKET | | 549 | SOL6431-130-19 | 58130-ZW1-W41ZA | 581 |
| REC30530-P8F-A01 | 30530-P8F-A01 | 558 | RECOBELEMENT | | 550 | SOL6431-130-21 | 58130-ZW1-W41ZA | 581 |
| REC30530-PNA-003 | 30530-PNA-003 | 558 | RECOBFILALU | | 550 | SOL6431-133-17 | 58130-ZW1-W31ZA | 581 |
| REC30530-RNA-A01 | 30530-RNA-A01 | 558 | RECOBFILTER | | 550 | SOL6431-135-15 | 58130-ZW1-W21ZA | 581 |
| REC30580-ZV4-013 | 30580-ZV4-023 | 559 | RECPIN4 | | 563 | SOL6431-138-13 | 58130-ZW1-W11ZA | 581 |
| REC31-30894A1 | 91051-ZW1-003 | 577-579 | RECPIN4.5 | | 563 | SOL6431-140-11 | 58130-ZW1-W01ZA | 581 |
| REC31-30895T | 91057-ZW1-003 | 577-579 | RECPIN6 | | 563 | SOL9311-110-15 | | 582 |
| REC31200-ZW9-802 | 31200-ZW9-801 | 560 | RECTOOLTRIM1 | | 563 | SOL9311-111-13 | | 582 |
| REC31200-ZW9-802 | 31200-ZW9-802 | 560 | RECTOOLTRIM2 | | 563 | SOL9311-111-14 | | 582 |
| REC31200-ZY6-003 | 31200-ZY6-003 | 560 | RECTOOLTRIM3 | | 563 | SOL9311-114-12 | | 582 |
| REC31200-ZY6-003 | 31200-ZY9-003 | 560 | RECTOOLTRIM3 | | 563 | SOL9311-116-11 | | 582 |
| REC31200-ZY6-003 | 31200-ZY9A-0031 | 560 | RECTOOLTRIMKIT | | 563 | SOL9311-120-10 | | 582 |
| REC31630-ZW5-003 | 31630-ZW5-003 | 562 | RECY5-225-15 | | 551 | SOL9311-121-09 | | 582 |
| REC31630-ZY3-003 | 31630-ZY3-003 | 561 | RM06111-ZW1-020 | 06111-ZW1-000 | 574 | SOL9331-110-15 | | 582 |
| REC31630-ZY6-003 | 31630-ZY6-003 | 561 | RM06111-ZW1-020 | 06111-ZW1-020 | 574 | SOL9331-111-13 | | 582 |
| REC31630-ZY6-003 | 31630-ZY6-013 | 561 | RM061A1-ZV0-000 | 061A1-ZV0-000 | 574 | SOL9331-111-14 | | 582 |
| REC31638-ZY3-003 | 31638-ZY3-003 | 561-562 | RM14400-921-024 | 14400-921-010 | 574 | SOL9331-111-14 | | 582 |
| REC31638-ZY6-003 | 31638-ZY6-003 | 561-562 | RM14400-921-024 | 14400-921-024 | 574 | SOL9331-116-11 | | 582 |
| REC35-802893Q | | 549 | RM14400-ZV4-004 | 14400-ZV4-004 | 574 | SOL9411-132-19 | | 582 |
| REC35-802893Q01 | | 549 | RM14400-ZW1-004 | 14400-ZW1-004 | 574 | SOL9411-132-21 | | 582 |
| REC35-822626Q03 | 15400-PFB-004 | 554 | RM19211-ZV0-003 | 19211-ZV0-003 | 568 | SOL9411-133-17 | | 582 |
| REC35-822626Q03 | 15400-PFRB-007 | 554 | RM35-802893Q | | 549 | SOL9411-135-15 | | 582 |
| REC35-822626Q03 | 15400-PJ7-015 | 554 | RM92-858026QB1U6 | | 553 | SOL9411-138-13 | | 582 |
| REC35-822626Q03 | 15400-PM3-004 | 554 | RM92-858027QB1U3 | | 553 | SOL9411-140-09 | | 582 |
| REC35-822626Q03 | 15400-PM3-405 | 554 | RM92-8M0086220U6 | | 553 | SOL9411-140-11 | | 582 |
| REC35-822626Q03 | 15400-ZW4-003 | 545-546-554 | RM92-8M0086221U3 | | 553 | SOL9431-130-19 | | 582 |
| REC35100-ZV5-013 | 35100-ZV5-013 | 565 | SIE18-8013 | | 547 | SOL9431-133-17 | | 582 |
| REC35340-ZZ5-D21 | 35340-ZZ5-D21 | 565 | SIE18-8015 | | 547 | SOL9431-135-15 | | 582 |
| REC35370-ZZ5-D02 | 35370-ZZ5-D02 | 565 | SOL1511-142-23 | 58233-ZY3-A23H | 581 | SOL9431-138-13 | | 582 |
| REC35370-ZW5-U02 | 35370-ZW5-U02 | 565 | SOL1511-143-21 | 58233-ZY3-A21H | 581 | SOL9432-130-19 | | 582 |
| REC35370-ZW5-U12 | 35370-ZW5-U12 | 565 | SOL1511-145-19 | 58233-ZY3-A19H | 581 | SOL9432-133-17 | | 582 |
| REC35655-ZY3-013 | 35655-ZY3-013 | 558 | SOL1511-148-17 | 58233-ZY3-A17H | 581 | SOL9432-135-15 | | 582 |
| REC35655-ZY9-003 | 35655-ZY9-003 | 558 | SOL1511-150-15 | 58233-ZY3-A15H | 581 | SOL9432-138-13 | | 582 |
| REC35668-ZY6-003 | 35668-ZY6-003 | 558 | SOL1512-142-23 | | 581 | SOL9511-143-21 | | 582 |
| REC36120-ZW4-H12 | 36120-ZW4-H12 | 563 | SOL1512-143-21 | | 581 | SOL9511-145-19 | | 582 |
| REC36120-ZY3-013 | 36120-ZY3-013 | 563 | SOL1512-145-19 | | 581 | SOL9511-148-17 | | 582 |
| REC36120-ZY6-013 | 36120-ZY6-013 | 563 | SOL1512-148-17 | | 581 | SOL9511-150-15 | | 582 |
| REC36120-ZY6-013 | 36120-ZY6-023 | 563 | SOL1512-150-15 | | 581 | SOL9511-153-13 | | 582 |
| REC36120-ZY9-003 | 36120-ZY9-003 | 563 | SOL1513-140-21 | 58233-ZY3-A21H | 581 | SOL9511-155-11 | | 582 |
| REC36120-ZY9-003 | 36120-ZY9-013 | 563 | SOL1513-140-23 | 58233-ZY3-A23H | 581 | SOL9511-160-13 | | 582 |
| REC36180-ZV5-033 | 36180-ZV5-003 | 561 | SOL1513-143-19 | 58233-ZY3-A19H | 581 | SOL9531-140-19 | | 582 |
| REC36180-ZV5-033 | 36180-ZV5-013 | 561 | SOL1513-145-17 | 58233-ZY3-A17H | 581 | SOL9531-140-21 | | 582 |
| REC36180-ZV5-033 | 36180-ZV5-023 | 561 | SOL1513-148-15 | 58233-ZY3-A15H | 581 | SOL9531-140-23 | | 582 |
| REC36180-ZV5-033 | 36180-ZV5-033 | 561 | SOL1531-140-19 | 08M60-ZW7-A00 | 581 | SOL9531-143-17 | | 582 |
| REC36180-ZV5-033 | 36180-ZV5-033 | 561 | SOL1531-140-21 | 08M60-ZW7-A10 | 581 | SOL9531-145-15 | | 582 |
| REC36180-ZV5-033 | 36180-ZV5-033 | 561 | | | | SOL9532-140-19 | | 582 |

| REF | R.O. / OEM | 582 | REF | R.O. / OEM | 582 | REF | R.O. / OEM | 572 |
|----------------|------------|-----|----------------|---------------|---------|---------------|------------------|---------|
| SOL9532-140-21 | | 582 | SOL9572-158-15 | | 582 | TEN01408 | 12155-ZV4-A00 | 572 |
| SOL9532-140-23 | | 582 | SOLRBX-102 | | 582 | TEN01408/1 | 12155-ZV5-000 | 545-572 |
| SOL9532-143-17 | | 582 | SOLRBX-107 | | 582 | TEN01409 | 41106-ZW9-000 | 572 |
| SOL9532-145-15 | | 582 | SOLRBX-113 | | 582 | TEN01410 | 41107-ZW1-B01ZA | 572 |
| SOL9571-145-25 | | 582 | | | | TEN01411 | 41107-ZV1-003-ZA | 572 |
| SOL9571-148-23 | | 582 | | | | TEN01412 | 06412-ZV5-000 | 572 |
| SOL9571-150-21 | | 582 | TEN01400 | 41106-ZW-000 | 572 | TENKITHONDABF | | 572 |
| SOL9571-153-19 | | 582 | TEN01401 | 41106-935-812 | 572 | THKS-1 | | 561 |
| SOL9571-155-17 | | 582 | TEN01402 | 41106-ZV4-650 | 545-572 | THKS-12 | | 561 |
| SOL9571-158-15 | | 582 | TEN01403 | 41107-ZV5-000 | 572 | THKS-2 | | 561 |
| SOL9572-145-25 | | 582 | TEN01404 | 06411-ZV5-000 | 572 | THKS-22 | | 561 |
| SOL9572-148-23 | | 582 | TEN01404 | 06411-ZV5-020 | 572 | THL-4 | | 561 |
| SOL9572-150-21 | | 582 | TEN01405 | 06411-ZV1-000 | 572 | TRI305-0386 | | 547 |
| SOL9572-153-19 | | 582 | TEN01406 | 06411-ZV1-000 | 572 | TRI305-0566 | | 547 |
| SOL9572-155-17 | | 582 | TEN01407 | 41109-ZW1-B00 | 572 | | | |

RO / OEM --> REF

| R.O. / OEM | REF | 574 | R.O. / OEM | REF | 553 | R.O. / OEM | REF | 546-552 |
|-----------------|------------------|-------------|-------------------|--------------------|-------------|-----------------|--------------------|-------------|
| 06111-ZW1-000 | RM06111-ZW1-020 | 574 | 08207-10W30M-FC-W | REC10W30U3 | 553 | 16900-SR3-004 | REC16900-SR3-004 | 546-552 |
| 06111-ZW1-020 | RM06111-ZW1-020 | 574 | 08207-5W30M2 | REC5W40U3 | 553 | 16900-ST5-993 | REC16010-ST5-993 | 553 |
| 06160-ZV4-U11 | REC06160-ZV4-U11 | 556 | 08209-10W30M-FC-W | REC10W30U6 | 553 | 16901-ZY3-003 | REC16901-ZY3-003 | 553 |
| 06160-ZV4-U11 | REC16010-ZV4-005 | 556 | 08739-90W | REC80W90U3 | 553 | 16910-ZV4-015 | REC16910-ZV4-015 | 545-552 |
| 06164-PCA-000 | REC06164-PCA-000 | 555 | 08M60-ZW7-A00 | SOL1531-140-19 | 581 | 16911-ZY3-003 | REC16901-ZY3-003 | 553 |
| 06176-ZW3-801AH | RAC025-RAC-02 | 553 | 08M60-ZW7-A10 | SOL1531-140-21 | 581 | 16911-ZY3-010 | REC16911-ZY3-010 | 546-553 |
| 06177-ZW1-801AH | RAC320R-INOX-01 | 551 | 08M60-ZW7-A20 | SOL1531-140-23 | 581 | 16911-ZZ5-003 | REC16911-ZZ5-003 | 546-553 |
| 06177-ZW1-801AH | RAC320R-RAC-03 | 550-551 | 08M60-ZW7-A30 | SOL1531-140-25 | 581 | 17105-ZY3-004 | REC17105-ZY3-004 | 575 |
| 06177-ZX2-000HE | REC24942 | 549 | 08M60-ZW7-A40 | SOL1531-145-15 | 581 | 17105-ZY6-000 | REC17105-ZY6-000 | 575 |
| 06177-ZX2-000HE | REC24952 | 549 | 116977-ZV5-900 | GS31032 | 549 | 17109-ZY3-004 | REC17109-ZY3-004 | 575 |
| 06178-ZW1-030GH | RAC120R-RAC-01 | 551 | 116977-ZV5-A00 | GS31033 | 549 | 17109-ZY6-000 | REC17109-ZY6-000 | 575 |
| 06192-881-C00 | REC06192-881-C00 | 570 | 12-191833 | REC12-191833 | 545-546-574 | 17151-ZW5-000 | REC17151-ZW5-000 | 575 |
| 06192-ZV1-305 | REC06192-ZV1-305 | 546-570 | 12155-ZV4-A00 | TEN01408 | 572 | 17384-ZW4-000 | REC17384-ZW4-000 | 574 |
| 06192-ZV1-000 | REC06192-ZV1-C00 | 570 | 12155-ZV5-000 | CM826134 | 571 | 17650-921-003ZB | GS31034 | 548 |
| 06192-ZV1-000 | REC06192-ZV1-000 | 570 | 12155-ZV5-000 | CM826134A | 571 | 17660-ZV5-902 | GS31030 | 548 |
| 06192-ZV1-C00 | REC06192-ZV1-C00 | 545-570 | 12155-ZV5-000 | TEN01408/1 | 545-572 | 17660-ZV5-A00 | GS31031 | 548 |
| 06192-ZV4-000 | REC06192-ZV4-000 | 545-570 | 12209-GB4-681 | REC12209-GB4-681 | 575 | 17660-ZW9-003 | GS31031 | 548 |
| 06192-ZV5-003 | REC06192-ZV5-003 | 545-546-570 | 12251-ZV5-000 | REC12251-ZV5-003 | 573 | 17670-ZW1-030GH | LENS3240 | 551 |
| 06192-ZV7-000 | REC06192-ZV7-000 | 545-570 | 12251-ZV5-003 | REC12251-ZV5-003 | 573 | 17670-ZW1-801AH | RACS3213 | 550-551 |
| 06192-ZW1-000 | REC06192-ZV1-000 | 546-570 | 12251-ZV7-004 | REC12251-ZV7-004 | 573 | 17670-ZW1-801AH | RACS3213 | 550-551 |
| 06192-ZW1-305 | REC06192-ZV1-305 | 570 | 12251-ZW1-004 | REC12251-ZW1-014 | 573 | 17670-ZW3-801AH | RACS2502 | 553 |
| 06192-ZW2-000 | REC06192-ZV7-000 | 570 | 12251-ZW1-014 | REC12251-ZW1-014 | 573 | 17710-ZW9-023 | REC17710-ZW9-033 | 548 |
| 06192-ZW9-A30 | REC06192-ZW9-A30 | 545-570 | 12251-ZW1-014 | REC12251-ZW1-014 | 573 | 17710-ZW9-033 | REC17710-ZW9-033 | 548 |
| 06192-ZX2-000 | REC06192-ZY3-000 | 570 | 12251-ZW4-H01 | REC12251-ZV5-003 | 573 | 17822-90J00 | REC09401-11425 | 548 |
| 06192-ZY3-000 | REC06192-ZY3-000 | 546-570 | 12251-ZW5-003 | REC12251-ZW5-023 | 573 | 17822-90J00 | REC09401-11425BULK | 548 |
| 06192-ZY6-000 | REC06192-ZY6-000 | 546-570 | 12251-ZW5-013 | REC12251-ZW5-023 | 573 | 19021-ZW1-003 | REC47-43026Q06 | 570-577 |
| 06193-ZV5-000 | REC06193-ZV5-020 | 570 | 12251-ZW5-023 | REC12251-ZW5-023 | 573 | 19120-ZW1-303 | REC47-43026Q02 | 577 |
| 06193-ZV5-010 | REC06193-ZV5-020 | 570 | 14400-921-010 | RM14400-921-024 | 574 | 19210-881-003 | REC19210-881-003 | 568 |
| 06193-ZV5-020 | REC06193-ZV5-020 | 570 | 14400-921-024 | RM14400-921-024 | 574 | 19210-881-A01 | REC19210-881-003 | 568 |
| 061A1-ZV0-000 | RM061A1-ZV0-000 | 574 | 14400-ZV4-004 | RM14400-ZV4-004 | 574 | 19210-881-A02 | REC19210-881-003 | 568 |
| 06211-ZV1-505 | REC06211-ZV1-505 | 545 | 14400-ZV5-004 | REC14400-ZV5-014 | 574 | 19210-ZV4-013 | CEF500328 | 568 |
| 06211-ZV4-505 | REC06211-ZV4-505 | 545 | 14400-ZV5-014 | REC14400-ZV5-014 | 574 | 19210-ZV4-013 | REC19210-ZV4-013 | 567-568 |
| 06211-ZV5-505 | REC06211-ZV5-505 | 545 | 14400-ZW1-004 | RM14400-ZW1-004 | 574 | 19210-ZV4-651 | CEF500343 | 568 |
| 06211-ZV7-505 | REC06211-ZV7-505 | 545 | 14400-ZZ3-004 | REC14400-ZZ3-004 | 574 | 19210-ZV4-651 | REC06192-ZV4-000 | 570 |
| 06211-ZW0-505 | REC06211-ZW0-505 | 546 | 15112-ZW5-003 | REC15112-ZW5-003 | 573 | 19210-ZV4-651 | REC19210-ZV4-651 | 567-568 |
| 06211-ZW5-505 | REC06211-ZW5-505 | 546 | 15400-PFB-004 | REC35-822626Q03 | 554 | 19210-ZV5-003 | CEF500338 | 568 |
| 06211-ZW9-505 | REC06211-ZW9-505 | 545 | 15400-PFB-007 | REC35-822626Q03 | 554 | 19210-ZV5-003 | REC19210-ZV5-003 | 546-568-576 |
| 06211-ZY0-505 | REC06211-ZY0-505 | 545 | 15400-PFB-014 | REC35-822626Q03 | 554 | 19210-ZV7-003 | CEF500339 | 568 |
| 06211-ZY2-506 | REC06211-ZY2-506 | 546 | 15400-PFRB-007 | REC35-822626Q03 | 554 | 19210-ZV7-003 | REC19210-ZV7-003 | 567-568 |
| 06211-ZY5-505 | REC06211-ZY5-505 | 546 | 15400-PH1-F03 | REC15400-PLM-A01PE | 554 | 19210-ZW1-303 | CEF500301 | 568 |
| 06211-ZY9-505 | REC06211-ZY9-505 | 546 | 15400-PJ7-015 | REC35-822626Q03 | 554 | 19210-ZW1-303 | REC47-43026Q02 | 567-568 |
| 06211-ZZ3-506 | REC06211-ZZ3-506 | 546 | 15400-PLM-A01PE | REC15400-PLM-A01PE | 554 | 19210-ZW1-B02 | REC19210-ZW1-B02 | 568 |
| 06211-ZZ5-505 | REC06211-ZZ5-505 | 546 | 15400-PM3-004 | REC35-822626Q03 | 554 | 19210-ZW1-B04 | CEF500337 | 568 |
| 06240-ZW5-U40 | REC06240-ZW5-U40 | 564 | 15400-PM3-405 | REC35-822626Q03 | 554 | 19210-ZW1-B04 | REC19210-ZW1-B02 | 568 |
| 06240-ZW5-U001 | REC06240-ZW5-U40 | 564 | 15400-POH-305 | REC15400-PLM-A01PE | 554 | 19210-ZW1-B04 | REC19210-ZW1-B02 | 568 |
| 06240-ZW5-U60 | REC06240-ZW5-U60 | 564 | 15400-POH-305PE | REC15400-PLM-A01PE | 554 | 19210-ZW9-003 | REC19210-ZW9-013 | 567 |
| 06411-ZV1-000 | TEN01405 | 572 | 15400-RBA-F01 | REC15400-RBA-F01 | 546-554 | 19210-ZW9-013 | CEF500347 | 568 |
| 06411-ZV1-000 | TEN01406 | 572 | 15400-RBA-F01 | REC15400-RBA-F01 | 546-554 | 19210-ZW9-013 | REC19210-ZW9-013 | 545-567-568 |
| 06411-ZV5-000 | CM06411-ZV5-000 | 571 | 15400-RTA-003 | REC15400-PLM-A01PE | 554 | 19210-ZW9-A31 | REC19210-ZW9-A32 | 568 |
| 06411-ZV5-000 | CM06411-ZV5-000A | 571 | 15400-RTA-004 | REC15400-PLM-A01PE | 554 | 19210-ZW9-A32 | CEF500348 | 568 |
| 06411-ZV5-000 | TEN01404 | 572 | 15400-ZJ1-004 | REC15400-PLM-A01PE | 546-554 | 19210-ZW9-A32 | REC19210-ZW9-A32 | 568 |
| 06411-ZV5-020 | CM06411-ZV5-000 | 571 | 15400-ZW4-003 | REC35-822626Q03 | 545-546-554 | 19210-ZY3-003 | CEF500391 | 568 |
| 06411-ZV5-020 | CM06411-ZV5-000A | 571 | 16010-ZV4-005 | REC16010-ZV4-005 | 556 | 19210-ZY3-003 | REC19210-ZY3-003 | 568 |
| 06411-ZV5-020 | TEN01404 | 572 | 16010-ZW9-003 | REC16010-ZW9-003 | 556 | 19210-ZY9-H01 | REC19210-ZY9-H01 | 567-568 |
| 06411-ZW1-000 | CM06411-ZW1-000 | 571 | 16011-881-741 | REC16011-881-741 | 555 | 19211-ZV0-003 | RM19211-ZV0-003 | 568 |
| 06411-ZW1-000 | CM06411-ZW1-000A | 571 | 16011-ZV4-005 | REC16011-ZV4-005 | 555 | 19221-ZV5-000 | REC19221-ZV5-000 | 576 |
| 06411-ZW1-020 | CM06411-ZW1-000 | 571 | 16201-881-850 | REC16201-881-850 | 575 | 19223-ZV5-000 | REC19223-ZV5-000 | 576 |
| 06411-ZW1-020 | CM06411-ZW1-000A | 571 | 16221-ZV4-610 | REC16221-ZV4-610 | 575 | 19231-ZV5-000 | REC19231-ZV5-000 | 576 |
| 06412-ZV1-000 | CM31640 | 572 | 16221-ZW1-000 | REC16221-ZW1-000 | 575 | 19231-ZW1-003 | REC8172761 | 569-577 |
| 06412-ZV1-000 | CM31640A | 572 | 16221-ZW9-000 | REC16221-ZW9-000 | 575 | 19232-881-850 | REC19232-881-850 | 569 |
| 06412-ZV5-000 | CM41107-ZV500 | 572 | 16700-ZV5-003 | REC16700-ZV5-003 | 555 | 19232-ZV1-A10 | REC19232-ZV1-A10 | 569 |
| 06412-ZV5-000 | CM41107-ZV500A | 572 | 16700-ZW1-004 | REC16700-ZW1-004 | 555 | 19232-ZV4-610 | REC19232-ZV4-610 | 569 |
| 06412-ZV5-000 | TEN01412 | 572 | 16735-ZW5-003 | REC16735-ZW5-003 | 555 | 19232-ZW1-003 | REC27-8172771 | 569-577 |
| 06412-ZV5-000 | CM664-45371-01 | 572 | 16735-ZY3-004 | REC16735-ZY3-004 | 555 | 19233-ZV5-000 | REC19233-ZV5-000 | 569-576 |
| 06412-ZV5-000 | CM664-45371-01A | 572 | 16900-GB2-005 | REC16900-GB2-005 | 545-552 | 19234-881-850 | REC19234-881-850 | 569 |
| 06412-ZV5-000 | | 582 | 16900-SA5-004 | REC16900-SA5-004 | 545-546-552 | 19234-ZW1-003 | REC27-430331 | 569-577 |

| R.O. / OEM | REF | R.O. / OEM | REF | R.O. / OEM | REF | | | |
|---------------------|------------------|-----------------|------------------|-------------------|----------------|----------------|------------------|-------------|
| 19234-ZY3-000 | REC19234-ZY3-000 | 569 | 35100-ZV5-013 | REC35100-ZV5-013 | 565 | 58233-ZY3-A19H | SOL1511-145-19 | 581 |
| 19242-ZV5-000 | REC19242-ZV5-000 | 569-576 | 35340-ZZ5-D21 | REC35340-ZZ5-D21 | 565 | 58233-ZY3-A19H | SOL1513-143-19 | 581 |
| 19242-ZW1-003 | REC27-430472 | 569-577 | 35370-ZW5-U02 | REC35370-ZW5-U02 | 565 | 58233-ZY3-A21H | SOL1511-143-21 | 581 |
| 19253-ZV5-000 | REC19253-ZV5-000 | 576 | 35370-ZW5-U12 | REC35370-ZW5-U12 | 565 | 58233-ZY3-A21H | SOL1513-140-21 | 581 |
| 19300-881-741 | PAF15-07000031 | 566 | 35370-ZZ5-D02 | REC35370-ZZ5-D02 | 565 | 58233-ZY3-A23H | SOL1511-142-23 | 581 |
| 19300-881-761 | REC19300-881-761 | 545-566-567 | 35655-ZY3-013 | REC35655-ZY3-013 | 558 | 58233-ZY3-A23H | SOL1513-140-23 | 581 |
| 19300-921-003 | PAF15-07000031 | 566 | 35655-ZY9-003 | REC35655-ZY9-003 | 558 | 58233-ZY3-B15H | SOL1532-145-15 | 581 |
| 19300-ZV5-003 | REC19300-ZV5-043 | 566 | 35668-ZY6-003 | REC35668-ZY6-003 | 558 | 58233-ZY3-B17H | SOL1532-143-17 | 581 |
| 19300-ZV5-013 | REC19300-ZV5-043 | 566 | 36120-ZV5-821 | PH200-T021 | 562 | 58233-ZY3-B19H | SOL1532-140-19 | 581 |
| 19300-ZV5-023 | REC19300-ZV5-043 | 566 | 36120-ZV5-822 | PH200-T046 | 562 | 90301-ZW1-003 | REC90301-ZW1-003 | 577 |
| 19300-ZV5-033 | REC19300-ZV5-043 | 566 | 36120-ZW4-H12 | REC36120-ZW4-H12 | 563 | 90507-921-000 | PAF15-04000003 | 545-546 |
| 19300-ZV5-043 | REC19300-ZV5-043 | 546-566-567 | 36120-ZY3-013 | REC36120-ZY3-013 | 563 | 90508-ZW1-003 | REC90508-ZW1-003 | 577-579 |
| 19300-ZW9-003 | PAF15-07000031 | 545-546-566-567 | 36120-ZY6-013 | REC36120-ZY6-013 | 563 | 90752-ZV4-650 | REC90752-ZV4-650 | 569 |
| 19300-ZX2-003 | REC67F-12411-01 | 566-567 | 36120-ZY6-023 | REC36120-ZY6-013 | 563 | 90752-ZV5-003 | REC90752-ZV5-003 | 546-569-576 |
| 19300-ZY3-023 | REC6AH-12411-00 | 566-567 | 36120-ZY9-003 | REC36120-ZY9-003 | 563 | 90752-ZV7-000 | REC90752-ZV7-000 | 569 |
| 19300-ZY6-003 | REC6E5-12411-30 | 566-567 | 36180-ZV5-003 | REC36180-ZV5-033 | 561 | 90752-ZW1-003 | REC90752-ZW1-B02 | 577 |
| 2155-ZV5-000 | CME0-45251-11 | 572 | 36180-ZV5-013 | REC36180-ZV5-033 | 561 | 90752-ZW1-B02 | REC90752-ZW1-B02 | 569 |
| 2155-ZV5-000 | CME0-45251-11A | 572 | 36180-ZV5-023 | REC36180-ZV5-033 | 561 | 90752-ZY3-003 | REC90752-ZY3-003 | 569 |
| 23172-ZW1-013 | REC23172-ZW1-013 | 573 | 36180-ZV5-033 | REC36180-ZV5-033 | 561 | 90758-ZV1-000 | PAGB/T91-2.5X30 | 545-546 |
| 23172-ZW5-000 | REC23172-ZW5-013 | 573 | 37260-RNA-A01 | REC37260-RNA-A01 | 557 | 91051-ZW1-003 | REC31-3089A41 | 577-579 |
| 23172-ZW5-013 | REC23172-ZW5-013 | 573 | 37500-PNB-003 | REC37500-PNB-003 | 557 | 91053-ZW1-003 | REC387247 | 577-579 |
| 24800-ZZ5-A01 | REC24800-ZZ5-A02 | 564 | 37510-PNB-003 | REC37510-PNB-003 | 557 | 91057-ZW1-003 | REC31-30895T | 577-579 |
| 24800-ZZ5-A02 | REC24800-ZZ5-A02 | 564 | 37830-PGK-A01 | REC37830-PGK-A01 | 557 | 91251-ZV5-003 | REC91251-ZV5-003 | 576 |
| 24800-ZZ5-A22 | REC24800-ZZ5-A02 | 564 | 37830-PNC-003 | REC37830-PNC-003 | 557 | 91251-ZW1-003 | REC26-43035 | 577-578 |
| 24911-ZW7-U01 | PRE3300C05 | 565 | 37830-RNA-A01 | REC37830-RNA-A01 | 557 | 91252-935-004 | REC91252-935-004 | 570 |
| 24912-ZW7-U01 | PRE3300C06 | 565 | 37840-R70-A01 | REC37840-R70-A01 | 557 | 91252-ZV1-003 | REC91252-ZV1-003 | 570 |
| 24913-ZW7-U01 | PRE3300C07 | 565 | 37880-PLC-004 | REC37880-PLC-004 | 558 | 91252-ZW1-003 | REC26-76868 | 577-578 |
| 24914-ZW7-U01 | PRE3300C08 | 565 | 41106-935-812 | TENO1401 | 572 | 91253-ZW1-003 | REC26-6164641 | 577-578 |
| 24915-ZW7-U01 | PRE3300C09 | 565 | 41106-ZV4-650 | TENO1402 | 545-572 | 91254-ZW1-003 | REC26-43036 | 577-578 |
| 24916-ZW7-U01 | PRE3300C10 | 565 | 41106-ZW-000 | TENO1400 | 572 | 91255-ZW1-003 | REC26-70081 | 578 |
| 24917-ZW7-U01 | PRE3300C11 | 565 | 41106-ZW9-000 | CM41106-ZW9-000A | 572 | 91351-740-003 | REC91351-740-003 | 576 |
| 24918-ZW7-U01 | PRE3300C12 | 565 | 41106-ZW9-000 | CM41106-ZW9-09000 | 572 | 91351-ZW1-003 | REC26-70081 | 577-578 |
| 24919-ZW7-U01 | PRE3300C13 | 565 | 41106-ZW9-000 | TENO1409 | 572 | 91353-ZV5-003 | REC91353-ZV5-00 | 576 |
| 24920-ZW7-U01 | PRE3300C14 | 565 | 41106-ZW9-090 | CM41106-ZW9-09000 | 545 | 91353-ZW1-003 | REC25-457101 | 577-578 |
| 24921-ZW7-U01 | PRE3300C15 | 565 | 41106Z909000 | CM41106-ZW9-000A | 572 | 91355-ZV5-000 | REC91555-ZV5-000 | 576 |
| 24922-ZW7-U01 | PRE3300C16 | 565 | 41106Z909000 | CM41106-ZW9-09000 | 572 | 91356-ZV5-000 | REC91356-ZV5-000 | 576 |
| 24923-ZW7-U01 | PRE3300C17 | 565 | 41107-ZV1-003-ZA | TENO1411 | 572 | 98059-55916 | NGKCR5EH-9 | 545-559 |
| 24924-ZW7-U01 | PRE3300C18 | 565 | 41107-ZV5-000 | CM41107-ZV500A | 545 | 98066-55716 | NGKDR5H5 | 559 |
| 24925-ZW7-U01 | PRE3300C19 | 565 | 41107-ZV5-000 | TENO1403 | 572 | 98069-5771P | NGKDR7EA | 545-546-559 |
| 24926-ZW7-U01 | PRE3300C20 | 565 | 41107-ZW1-B01ZA | TENO1410 | 572 | 98069-5777P | NGKDR7EB | 546 |
| 24927-ZW7-U01 | PRE3300C21 | 565 | 41107Z2W1003 | CM31640 | 572 | 98079-55846 | NGKBPR5ES | 545-559 |
| 24928-ZW7-U01 | PRE3300C22 | 565 | 41107Z2W1003 | CM31640A | 572 | HXZ2-30520-003 | REC30520-ZX2-003 | 559 |
| 24929-ZW7-U01 | PRE3300C23 | 565 | 41107ZV500 | CM41107-ZV500 | 572 | HZY-38580-003 | REC38580-ZY9-023 | 558 |
| 24930-ZW7-U01 | PRE3300C24 | 565 | 41107ZV500 | CM41107-ZV500A | 572 | HZY-638550-003 | REC38550-ZY6-003 | 563 |
| 24931-ZW7-U01 | PRE3300C25 | 565 | 41107ZW1-B01 | CM41107-ZW1-B01 | 572 | | | |
| 24932-ZW7-U01 | PRE3300C26 | 565 | 41107ZW1-B01 | CM41107-ZW1-B01A | 572 | | | |
| 24933-ZW7-U01 | PRE3300C27 | 565 | 41109-ZV5-000 | REC41109-ZV5-000 | 579 | | | |
| 24934-ZW7-U01 | PRE3300C28 | 565 | 41109-ZW1-003 | CM826134 | 571 | | | |
| 24935-ZW7-U01 | PRE3300C29 | 565 | 41109-ZW1-003 | CM826134A | 571 | | | |
| 24936-ZW7-U01 | PRE3300C30 | 565 | 41109-ZW1-B00 | CM41109-ZW1-B00 | 571 | | | |
| 24937-ZW7-U01 | PRE3300C31 | 565 | 41109-ZW1-B00 | CM41109-ZW1-B00A | 571 | | | |
| 24938-ZW7-U01 | PRE3300C32 | 565 | 41109-ZW1-B00 | TENO1407 | 572 | | | |
| 30520-PNA-007 | REC30520-PNA-007 | 559 | 41161-ZV5-000 | REC41161-ZV5-000 | 579 | | | |
| 30520-PWC-S01 | REC30520-PWC-003 | 559 | 58130-ZV0-841ZB | SOL6001-073-06P | 581 | | | |
| 30520-ZX2-003 | REC30520-ZX2-002 | 559 | 58130-ZV4-030ZB | SOL3111-093-09 | 581 | | | |
| 30520-ZYL-003 | REC30520-ZYL-002 | 559 | 58130-ZV4-703ZB | SOL3111-093-08 | 581 | | | |
| 30520-ZY3-003 | REC30520-ZY3-002 | 559 | 58130-ZV5-000ZA | SOL3311-111-13 | 581 | | | |
| 30530-P8F-A01 | REC30530-P8F-A01 | 558 | 58130-ZV5-850ZA | SOL3311-114-12 | 581 | | | |
| 30530-PNA-003 | REC30530-PNA-003 | 558 | 58130-ZV5-860ZA | SOL3311-121-09 | 581 | | | |
| 30530-RNA-A01 | REC30530-RNA-A01 | 558 | 58130-ZV5-870ZA | SOL3311-111-14 | 581 | | | |
| 30580-ZV4-023 | REC30580-ZV4-013 | 559 | 58130-ZV7-000ZA | SOL5211-099-11 | 581 | | | |
| 38550-ZV5-023 | REC38550-ZV5-023 | 563 | 58130-ZV7-850ZA | SOL5211-099-09 | 581 | | | |
| 38550-ZY6-003 | REC38550-ZY6-006 | 563 | 58130-ZW1-W01ZA | SOL6411-140-11 | 581 | | | |
| 38580-ZY6-003/13 | REC38580-ZY6-013 | 558 | 58130-ZW1-W01ZA | SOL6431-140-11 | 581 | | | |
| 38580-ZY9-003/13/23 | REC38580-ZY9-023 | 558 | 58130-ZW1-W11ZA | SOL6411-138-13 | 581 | | | |
| 31200-ZV5-003 | PH130-0054 | 560 | 58130-ZW1-W11ZA | SOL6413-133-13 | 581 | | | |
| 31200-ZV5-013 | PH130-0054 | 560 | 58130-ZW1-W11ZA | SOL6431-138-13 | 581 | | | |
| 31200-ZW1-004 | PH130-0064 | 560 | 58130-ZW1-W21ZA | SOL6411-135-15 | 581 | | | |
| 31200-ZW5-003 | PH130-0065 | 560 | 58130-ZW1-W21ZA | SOL6413-130-15 | 581 | | | |
| 31200-ZW9-801 | REC31200-ZW9-802 | 560 | 58130-ZW1-W21ZA | SOL6431-135-15 | 581 | | | |
| 31200-ZW9-802 | REC31200-ZW9-802 | 560 | 58130-ZW1-W31ZA | SOL6411-133-17 | 581 | | | |
| 31200-ZY3-003 | PH130-0070 | 560 | 58130-ZW1-W31ZA | SOL6412-135-15 | 581 | | | |
| 31200-ZY3A-0034 | PH130-0070 | 560 | 58130-ZW1-W31ZA | SOL6413-128-17 | 581 | | | |
| 31200-ZY6-003 | REC31200-ZY6-003 | 560 | 58130-ZW1-W31ZA | SOL6431-133-17 | 581 | | | |
| 31200-ZY9-003 | REC31200-ZY6-003 | 560 | 58130-ZW1-W41ZA | SOL6411-130-19 | 581 | | | |
| 31200-ZY9A-0031 | REC31200-ZY6-003 | 560 | 58130-ZW1-W41ZA | SOL6411-130-21 | 581 | | | |
| 31630-ZW5-003 | REC31630-ZW5-003 | 562 | 58130-ZW1-W41ZA | SOL6413-125-19 | 581 | | | |
| 31630-ZY3-003 | REC31630-ZY3-003 | 561 | 58130-ZW1-W41ZA | SOL6413-125-21 | 581 | | | |
| 31630-ZY6-003 | REC31630-ZY6-003 | 561 | 58130-ZW1-W41ZA | SOL6431-130-19 | 581 | | | |
| 31630-ZY6-013 | REC31630-ZY6-003 | 561 | 58130-ZW1-W41ZA | SOL6431-130-21 | 581 | | | |
| 31638-ZY3-003 | REC31638-ZY3-003 | 561-562 | 58130-ZW1-W61ZA | SOL6412-133-17 | 581 | | | |
| 31638-ZY6-003 | REC31638-ZY6-003 | 561-562 | 58233-ZY3-A15H | SOL1511-150-15 | 581 | | | |
| 31908-ZZ3-003 | NGKLMAR6C-9 | 546-559 | 58233-ZY3-A15H | SOL1513-148-15 | 581 | | | |
| 31916-ZX2-003 | NGKIZFR6K-11E | 559 | 58233-ZY3-A17H | SOL1511-148-17 | 581 | | | |
| 31916-ZY3-003 | NGKIZFR6K11 | 546-559 | 58233-ZY3-A17H | SOL1513-145-17 | 581 | | | |
| | | | | 58233-ZY3-A17H | SOL1531-143-17 | | | 581 |

TOHATSU

ES

| | | | | | |
|--|-----|----------------------------------|-----|--|-----|
| GUÍA MANTENIMIENTO | 589 | IGNICIÓN | 599 | DESPIECE MOTOR DE 4 TIEMPOS | 613 |
| SISTEMA DE ALIMENTACIÓN Y FILTRACIÓN | 590 | CARGA | 599 | MFS8 • MFS9.9 | 613 |
| ACEITE | 595 | BUJÍAS | 600 | DESPIECE MOTOR DE 2 TIEMPOS | 608 |
| BOMBA DE COMBUSTIBLE EN LÍNEA | 590 | CDI Y CAJAS NEGRAS | 601 | M4C • M5B • M5BS | 608 |
| ABRAZADERA PARA MANGUERA | 591 | MOTORES DE ARRANQUE | 600 | M6B • M8B • M9.8B | 609 |
| ADAPTADOR LÍNEA DE COMBUSTIBLE | 591 | SENSORES | 598 | M9.9D • M15D2 • M18E2 | 610 |
| BOMBA DE COMBUSTIBLE | 590 | SENSOR PRESIÓN ACEITE | 598 | M25C3 • M30A4 | 611 |
| LÍNEA DE COMBUSTIBLE | 590 | SENSOR DE OXÍGENO | 598 | M40D2 • M50D2 | 612 |
| MANGUERA DE COMBUSTIBLE | 590 | SENSOR ÁRBOL DE LEVAS | 598 | JUNTAS DE MOTOR 4 TIEMPOS | 617 |
| MUELLE TUBO COMBUSTIBLE | 591 | TRIM, TILT & POWER TRIM | 602 | JUNTAS BASE DE MOTOR | 618 |
| BOMBA DE COMBUSTIBLE | 596 | INSTALACIÓN ELÉCTRICA | 602 | JUNTAS CULATÍN | 617 |
| KITS MEMBRANAS Y JUNTAS | 596 | POWER TRIM COMPLETO | 602 | JUNTAS DE CULATA | 617 |
| CARBURADOR | 596 | TRIM COMPLETO | 602 | KIT JUNTAS DE CULATA | 617 |
| BOYAS | 597 | SISTEMA DE GOBIERNO | 603 | PISTONES | 619 |
| CARBURADOR COMPLETO | 596 | COMPONENTES | 603 | KIT DE PISTONES | 619 |
| KITS CARBURADORES | 597 | CABLES DE ACELERADOR | 603 | RETENES DE ACEITE | 618 |
| COMPONENTES TANQUE Y CONECTORES | 591 | SISTEMA DE REFRIGERACIÓN | 603 | SISTEMA DE ESCAPE Y ADMISIÓN | 621 |
| CONECTOR DE DEPÓSITO | 591 | ÁNODOS | 606 | SISTEMA DE ADMISIÓN | 621 |
| PASAMAMPAROS | 592 | ÁNODO CANADA METAL | 606 | JUNTAS DE ADMISIÓN | 621 |
| FILTRO DE ACEITE | 596 | ÁNODO TECNOSEAL | 607 | SISTEMA DE ESCAPE | 621 |
| FILTRO DE COMBUSTIBLE Y ELEMENTOS | 592 | BOMBA DE AGUA | 605 | JUNTAS DE ESCAPE | 621 |
| BRACKET | 592 | CASQUILLO INOX | 605 | UNIDADES DE TRANSMISIÓN | 622 |
| FILTRO DECANTADOR DE COMBUSTIBLE COMPLETO CON VASO TRASPARENTE | 593 | JUNTAS BOMBA | 605 | DESPIECE COLAS 4 TIEMPOS | 622 |
| FILTRO DECANTADOR DE GASOLINA | 593 | JUNTAS BASE DE BOMBA | 605 | MFS8 • MFS9.8 | 622 |
| FILTRO COMBUSTIBLE MONTAJE EN LÍNEA | 594 | KITS DE REPARACIÓN BOMBA DE AGUA | 605 | GUÍA PIEZA DE COLA | 626 |
| FILTRO COMBUSTIBLE SEPARADOR AGUA | 592 | IMPULSORES | 604 | SISTEMA DE PROPULSIÓN | 627 |
| LLAVES PARA FILTRO | 594 | TERMOSTATO | 603 | HÉLICES ALUMINIO E INOXIDABLE DE 3 Y 4 PALAS | 627 |
| RACOR DE LATÓN | 594 | JUNTAS TAPA DE REFRIGERACIÓN | 604 | GUÍA HÉLICES CON NÚCLEO INTEGRADO | 628 |
| SISTEMA ELÉCTRICO | 598 | JUNTA TERMOSTATO | 604 | HÉLICES PARA NÚCLEO INTERCAMBIABLE | 629 |
| BOBINAS | 598 | PARTES DEL MOTOR | 608 | NÚCLEO INTERCAMBIABLE | 629 |
| ALTA PRESIÓN | 599 | CIGÜEÑAL | 619 | REF --> RO | 630 |
| PULSACIÓN | 599 | RODAMIENTOS | 619 | RO --> REF | |

EN

| | | | | | |
|--|-----|------------------------------|-----|--|-----|
| DRIVES MAINTENANCE GUIDE & KITS | 589 | IGNITION COIL | 599 | ENGINE GASKETS 4 STROKES | 617 |
| FUEL & FILTRATION SYSTEM | 590 | CHARGER COIL | 599 | GASKET, CYLINDER COVER | 617 |
| CARBURATOR | 596 | SENSORS | 598 | GASKET, CYLINDER HEAD | 617 |
| CARBURETOR KITS | 597 | SENSOR, OIL PRESURE | 598 | GASKET KIT, CYLINDER HEAD | 617 |
| FLOATS | 597 | SENSOR, OXYGEN | 598 | ENGINE PARTS 2 STROKES | 608 |
| FULL CARBURATOR | 596 | SENSOR, CAMSHAFT | 598 | M4C • M5B • M5BS | 608 |
| FUEL FILTERS AND ELEMENTS | 592 | SPARK | 600 | M6B • M8B • M9.8B | 609 |
| BRACKET | 592 | STARTERS | 600 | M9.9D • M15D2 • M18E2 | 610 |
| COMPLET FUEL FILTER | 594 | TRIM, TILT & POWER TRIM | 602 | M25C3 • M30A4 | 611 |
| COMPLET FUEL FILTER WITH TRANSPARENT BOWL | 593 | COMPLETE POWER TRIM ASSEMBLY | 602 | M40D2 • M50D2 | 612 |
| FILTER KEY | 594 | COMPLETE TRIM ASSEMBLY | 602 | ENGINE PARTS 4 STROKES | 613 |
| IN-LINE FUEL FILTER | 594 | WIRING HARNESS | 602 | MFS8 • MFS9.9 | 613 |
| RACORS | 594 | STEERING SYSTEM | 603 | PISTONS | 619 |
| WATER SEPARATING FUEL FILTER | 592 | COMPONENTS | 603 | PISTON KITS | 619 |
| FUEL PUMP | 596 | CONTROL CABLES | 603 | OIL SEALS | 618 |
| DIAPHRAGMS & GASKETS | 596 | COOLING SYSTEM | 603 | EXHAUST & INTAKE SYSTEM | 621 |
| FUEL PUMP IN LINE | 590 | ANODES | 606 | EXHAUST SYSTEM | 621 |
| CLAMP SMALL | 591 | ANODES CANADA METAL | 606 | GASKETS | 621 |
| COUPLER | 591 | ANODES TECNOSEAL | 607 | INTAKE SYSTEM | 621 |
| FUEL HOSE | 590 | IMPELLERS | 604 | GASKETS | 621 |
| FUEL LINE ASSEMBLY | 590 | THERMOSTAT | 603 | UNIT DRIVES & COMPONENTS | 622 |
| SPRING, FUEL PIPE | 591 | GASKET BASE | 603 | DRIVE COMPONENTS GUIDE | 626 |
| FUEL TANK COMPONENTS & CONNECTORS | 591 | EXHAUST INNER COVER | 604 | GEAR CASE PARTS 4 STROKES | 622 |
| TANK CONNECTOR | 591 | WATER PUMP | 605 | MFS8 • MFS9.8 | 622 |
| THRU HULL | 592 | GASKET | 605 | PROPULSION SYSTEM | 627 |
| OIL | 595 | GASKET BASE | 605 | 3 & 4 BLADE ALUMINIUM & SS PROPELLERS | 627 |
| OIL FILTER | 596 | INSERT CUP | 605 | INTERCHANGEABLE HUB | 629 |
| ELECTRIC SYSTEM | 598 | SERVICE KIT | 605 | PROPELLERS APPLICATION WITH RUBBER HUB | 629 |
| CDI & POWER PACK | 601 | ENGINE PARTS | 608 | PROPELLERS FOR INTERCHANGEABLE HUB | 629 |
| COILS | 598 | CRANKSHAFT | 619 | REF --> OEM | 630 |
| COIL HIGH PRESSURE | 599 | CRANKSHAFT BEARINGS | 619 | OEM --> REF | 632 |
| PULSER COIL | 599 | | | | |

TOHATSU

RECAMBIOS MARINOS

IT

| | | | | | |
|--|-----|--------------------------------------|-----|--|-----|
| GUIDA MANUTENZIONE E KIT | 589 | CDI E CENTRALINA | 601 | GUARNIZIONE BASE MOTORE | 618 |
| SISTEMA DI ALIMENTAZIONE E FILTRAZIONE | 590 | MOTORINI AVVIAMENTO | 600 | GUARNIZIONE TESTATA | 617 |
| CARBURATORE | 596 | SENSORE | 598 | GUARNIZIONE COPERCHIO TESTA | 617 |
| CARBURATORE COMPLETO | 596 | SENSORE PRESIONE OLIO | 598 | KIT GUARNIZIONE TESTATA | 617 |
| GALLEGGIANTE | 597 | SENSORE OSSIGENO | 598 | PARAOILIO | 618 |
| KIT CARBURATORI | 597 | SENSORE ALBERO A CAMME | 598 | PARTI MOTORE 4 TEMPI | 613 |
| COMPONENTI SERBATOIO E CONNETTORI | 591 | TRIM, TILT & POWER TRIM | 602 | MFS8 • MFS9.9 | 613 |
| ATTACCO SERBATOIO | 591 | INSTALLAZIONE ELETTRICA | 602 | PARTI MOTORE 2 TEMPI | 608 |
| PASSASCAFO | 592 | MOTORINO POWER TRIM COMPLETO | 602 | M4C • M5B • M5BS | 608 |
| FILTRI BENZINA E RACCORDI | 592 | MOTORINO TRIM COMPLETO | 602 | M6B • M8B • M9.8B | 609 |
| CHIAVE DA FILTRO | 594 | SISTEMA DI GUIDA | 603 | M9.9D • M15D2 • M18E2 | 610 |
| FILTRO BENZINA PER MONTARE IN LINEA | 594 | COMPONENTI | 603 | M25C3 • M30A4 | 611 |
| FILTRO DECATATORE BENZINA | 593 | CAVO ACCELERATORE | 603 | M40D2 • M50D2 | 612 |
| FILTRO DI DECATAZIONE BENZINA COMPLETO CON VASCHETTA TRASPARENTE | 593 | SISTEMA DI RAFFREDDAMENTO | 603 | PISTONE | 619 |
| FILTRO SEPARATORE ACQUA-BENZINA | 592 | ANODI | 606 | KIT PISTONE | 619 |
| RACCORDI | 594 | ANODI CANADA METAL | 606 | SISTEMA DI SCARICO E ASPIRAZIONE | 621 |
| SUPPORTO | 592 | ANODI TECNOSEAL | 607 | SISTEMA ASPIRAZIONE | 621 |
| FILTRO OLIO | 596 | GIRANTE | 604 | GUARNIZIONE | 621 |
| OLIO | 595 | GUIDA GIRANTE | 604 | SISTEMA SCARICO | 621 |
| POMPA BENZINA | 596 | POMPA ACQUA | 605 | GUARNIZIONE | 621 |
| MEMBRANA E GUARNIZIONI | 596 | GHIERA INOX | 605 | UNITÀ DI TRASMISSIONE | 622 |
| POMPA BENZINA IN LINEA | 590 | GUARNIZIONE BASE POMPA | 605 | GUIDA COMPONENTI PIEDI | 626 |
| ADATTATORE | 591 | GUARNIZIONE POMPA | 605 | PARTI PIEDI 4 TEMPI | 622 |
| FASCETTE | 591 | KIT RICAMBI POMPA ACQUA | 605 | MDF8 • MSF9.8 | 622 |
| MOLLA TUBO COMBUSTIBILE | 591 | TERMOSTATO | 603 | SISTEMA DI PROPULSIONE | 627 |
| POMPA BENZINA | 590 | GUARNIZIONE TERMOSTATO | 604 | ELICHE ALLUMINIO E INOX DA 2 E 4 PALE | 627 |
| TUBO BENZINA | 590 | GUARNIZIONE COPERCHIO REFRIGERAZIONE | 604 | ELICHE PER MOZZO INTERCAMBIABILE | 629 |
| SISTEMA ELETTRICO | 598 | PARTI MOTORE | 608 | GUIDA ELICHE CON MOZZO | 628 |
| BOBINE | 598 | ALBERO MOTORE | 619 | MOZZO INTERCAMBIABILE | 629 |
| BOBINA ALTA PRESSIONE | 599 | CUSCINETTI ALBERO MOTORE | 619 | REF --> RO | 630 |
| BOBINA ACCENSIONE | 599 | GUARNIZIONI MOTORE 4 TEMPI | 617 | RO --> REF | 632 |
| BOBINA AVVIAMENTO | 599 | | | | |
| BOBINA DI CARICA | 599 | | | | |
| CANDELE | 600 | | | | |

FR

| | | | | | |
|--|-----|-------------------------------------|-----|---|-----|
| GUIDE MAINTENANCE KITS | 589 | BOBINE D'ALLUMAGE | 599 | JOINTS DE TÊTE MOTRICE | 618 |
| SYSTÈME D'ALIMENTATION ET DE FILTRATION | 590 | BOBINE DE CHARGE | 599 | KIT JOINTS DE MOTEUR | 617 |
| CARBURATEUR | 596 | BOUGIES | 600 | PIÈCES MOTEURS DE 4 TEMPS | 613 |
| CARBURATEUR COMPLET | 596 | CAPTEURS | 598 | MFS8 • MFS9.9 | 613 |
| FLOTTEUR DE CARBURATEUR | 597 | CAPTEUR PRESION HUILE | 598 | PIÈCES MOTEUR 2 TEMPS | 608 |
| KIT CARBURATEUR | 597 | CAPTEUR À OXYGENE | 598 | M4C • M5B • M5BS | 608 |
| COMPOSANTS ET CONNECTEURS DU RÉSERVOIR | 591 | CAPTEUR DE POSITION D'ARBRE À CAMES | 598 | M6B • M8B • M9.8B | 609 |
| PASSE-CLOISON | 592 | CDI ET BOITIER ELECTRONIQUE | 601 | M9.9D • M15D2 • M18E2 | 610 |
| RACCORDS DE RESERVOIR | 551 | DEMARREUR | 600 | M25C3 • M30A4 | 611 |
| FILTRE À ESSENCE ET CARTOUCHE DE RECHANGE | 592 | TRIM, TILT & POWER TRIM | 602 | M40D2 • M50D2 | 612 |
| CLÉ À FILTRE | 594 | INSTALLATION ELECTRIQUE | 602 | PISTONS | 619 |
| FILTRE DÉCANTEUR ESSENCE | 593 | MOTEUR DE TRIM | 602 | KIT PISTON | 619 |
| FILTRE DÉCANTEUR ESSENCE AVEC BOL TRANSPARENT | 593 | POWER TRIM COMPLET | 602 | VILEBREQUIN | 619 |
| FILTRE À ESSENCE EN LIGNE | 594 | SYSTÈME DE COMMANDE | 603 | ROULEMENTS VILEBREQUIN | 619 |
| FILTRE SÉPARATEUR EAU-ESSENCE | 592 | COMPOSANT | 603 | SYSTÈME D'ÉCHAPPEMENT ET SYSTÈME D'ADMISSION | 621 |
| RACCORDS | 594 | CÂBLE D'ACCELERATEUR | 603 | SYSTÈME D'ADMISSION | 621 |
| TÊTE DE FILTRE À ESSENCE | 592 | SYSTÈME DE REFROIDISSEMENT | 603 | JOINTS | 621 |
| FILTRE À HUILE | 596 | ANODES | 606 | SYSTÈME D'ÉCHAPPEMENT | 621 |
| HUILES | 595 | ANODE CANADA METAL | 606 | JOINTS | 621 |
| POIRE À CARBURANT | 590 | ANODE TECNOSEAL | 606 | EMBASES ET PIÈCES | 622 |
| COLLIER | 591 | TURBINES | 604 | PIÈCES D'EMBASES DE 4 TEMPS | 622 |
| POIRE À CARBURANT | 591 | POMPE D'EAU | 605 | MFS8 • MFS9.9 | 622 |
| RACCORD COUPLEUR | 591 | INSERT INOX | 605 | GUIDE PIÈCES D'EMBASES | 626 |
| RESSORT, TUYAU DE CARBURANT | 591 | JOINTS, BASE DE POMPE À EAU | 605 | SYSTEME DE PROPULSION | 627 |
| TUYAU CARBURANT | 590 | JOINTS POMPE | 605 | HÉLICE ALUMINIUM ET INOX 3 ET 4 PALES | 627 |
| POMPE À ESSENCE | 596 | KIT REPARATION DE POMPE À EAU | 605 | GUIDE DES HÉLICES ET MOYEUR | 628 |
| MEMBRANES ET JOINTS | 596 | THERMOSTAT | 603 | HELICES AVEC MOYEU INTERCHANGEABLE | 628 |
| SYSTÈME ÉLECTRIQUE | 598 | JOINT THERMOSTAT | 604 | MOYEU INTERCHANGEABLE | 629 |
| BOBINES | 598 | JOINT COUVERCLE THERMOSTAT | 604 | REF --> RO | 630 |
| BOBINE HAUTE PRESION | 599 | PIÈCES MOTEUR | 608 | RO --> REF | 632 |
| BOBINE PULSEUR | 599 | JOINTS DE MOTEUR 4 TEMPS | 617 | | |
| | | JOINTS COUVRE CULASSE | 617 | | |
| | | JOINTS DE CULASSE | 617 | | |

MAINTENANCE
GUIDE

GUIDA
MANUTENZIONE

GUIDE
MAINTENANCE

| | REF | | | | | |
|--------------------------|-----------------|------------------------|---------------|-----------------------|--------------------------|---|
| MFS4 MFS5 MFS6 | NGKDCPR6E | BUJÍA | SPARK PLUG | CANDELE | BOUGIE | 1 |
| | TEN01259 | ÁNODO | ANODE DRIVE | ANODO | ANODE | 1 |
| | CEF500377 | IMPULSOR | IMPELLER | GIRANTE | TURBINE | 1 |
| | PAF4-05000300 | FILTRO COMBUSTIBLE | FUEL FILTER | FILTRO BENZINA | FILTRE À ESSENCE | 1 |
| MFS8 MFS9.8 | NGKDCPR6E | BUJÍA | SPARK PLUG | CANDELE | BOUGIE | 2 |
| | TEN01258 | ÁNODO BLOQUE | ANODE ENGINE | ANODO MOTORE | ANODE MOTEUR | 1 |
| | CEF500344 | IMPULSOR | IMPELLER | GIRANTE | TURBINE | 1 |
| | PAF4-05000300 | FILTRO COMBUSTIBLE | FUEL FILTER | FILTRO BENZINA | FILTRE À ESSENCE | 1 |
| | REC855676002 | TERMOSTATO | THERMOSTAT | TERMOSTATO | TERMOSTAT | 1 |
| | PAF8-05000004 | CORREA DISTRIBUCIÓN | TIMING BELT | CINGHIE DISTRIBUZIONE | COURROIE DE DISTRIBUTION | 1 |
| | TEN01260 | ÁNODO COLA | ANODE DRIVE | ANODO PIEDE | ANODE EMBASSE | 1 |
| MFS9.9 MFS15 MFS18 | NGKDCPR6E | BUJÍA | SPARK PLUG | CANDELE | BOUGIE | 2 |
| | TEN01258 | ÁNODO BLOQUE | ANODE ENGINE | ANODO MOTORE | ANODE MOTEUR | 1 |
| | CEF500383 | IMPULSOR | IMPELLER | GIRANTE | TURBINE | 1 |
| | PAF4-05000300 | FILTRO COMBUSTIBLE | FUEL FILTER | FILTRO BENZINA | FILTRE À ESSENCE | 1 |
| | REC5GH-13440-00 | FILTRO ACEITE | OIL FILTER | FILTRO OLIO | FILTRE À HUILE | 1 |
| | REC855676002 | TERMOSTATO | THERMOSTAT | TERMOSTATO | TERMOSTAT | 1 |
| | TEN01250 | ÁNODO TRANSOM | TRANSOM ANODE | ANODO TRANSOM | ANODE TRANSOM | 1 |
| MFS25 MFS30 | NGKDCPR6E | BUJÍA | SPARK PLUG | CANDELE | BOUGIE | 2 |
| | TEN01258 | ÁNODO BLOQUE | ANODE ENGINE | ANODO MOTORE | ANODE MOTEUR | 1 |
| | CEF500382 | IMPULSOR | IMPELLER | GIRANTE | TURBINE | 1 |
| | PAF4-05000300 | FILTRO COMBUSTIBLE | FUEL FILTER | FILTRO BENZINA | FILTRE À ESSENCE | 1 |
| | REC855676002 | TERMOSTATO | THERMOSTAT | TERMOSTATO | TERMOSTAT | 1 |
| | REC5GH-13440-00 | FILTRO ACEITE | OIL FILTER | FILTRO OLIO | FILTRE À HUILE | 1 |
| | TEN01256 | ÁNODO TRANSOM | TRANSOM ANODE | ANODO TRANSOM | ANODE TRANSOM | 1 |
| | TEN01253 | ÁNODO COLA | ANODE DRIVE | ANODO PIEDE | ANODE EMBASE | 1 |

SISTEMA DE ALIMENTACIÓN Y FILTRACIÓN FUEL & FILTRATION SYSTEM

SISTEMA DI ALIMENTAZIONE E FILTRAZIONE SYSTÈME D'ALIMENTATION ET DE FILTRATION

BOMBA DE COMBUSTIBLE

FUEL PUMP

POMPA BENZINA

POIRE À CARBURANT

BOMBA DE COMBUSTIBLE

FUEL PUMP

POMPA BENZINA



POIRE À CARBURANT

Fabricada con elastómeros termoplásticos inyectados, resistentes al alcohol y rayos UV.s

Premium quality bulb resistance to alcohol as well as UV and ozone.

Fabbricata con elastomero termoplastico, resistente ai solventi e raggi UV.

Fabriqué avec des élastomères thermoplastiques injectés, résistant à l'alcool et aux rayons UV.

| REF |  |  |
|---------|---|---|
| GS31187 | 1/4" = 6 mm | 1 |
| GS31090 | 5/16" = 8 mm | 1 |
| GS31095 | 3/8" = 9.5 mm | 1 |
| GS31090 | 5/16" = 8 mm | 1 |

 GOLDENSHIP



LÍNEA DE COMBUSTIBLE

FUEL LINE ASSEMBLY

TUBO CARBURANTE



TUYAU CARBURANT

Universal. Manguera resistente al alcohol.



Universal. Alcohol resistant hose.

Universale. Tubo resistente ai solventi.

Universel. Tuyau résistant à l'alcool.



| REF |  |  |
|------------|---|---|
| GS31096 | 5/16" x 2 m | 1 |
| GS31097 | 3/8" x 2 m | 1 |
| GS31099 | 8 mm x 2 m | 1 |
| SIE18-8013 | 5/16" x 2 m | 1 |
| SIE18-8015 | 3/8" x 2 m | 1 |



| REF |  |  |
|---------|---|---|
| GS31189 | 3/8" x 2 m | 1 |

  GOLDENSHIP



| REF |  |  |
|---------|--|---|
| GS31183 | 6 mm x 2 m | 1 |

 GOLDENSHIP

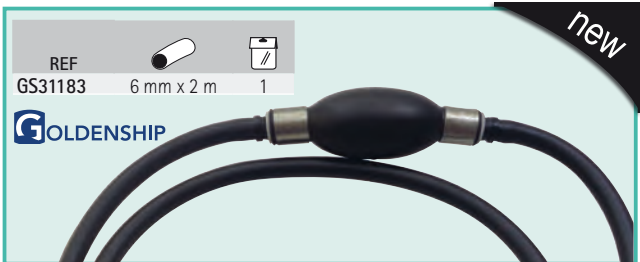

MANGUERA DE COMBUSTIBLE

FUEL HOSE

TUBO BENZINA





TUYAU CARBURANT

Manguera «Trident» para líneas de combustible. Con refuerzo termoplástico que le permite excelente flexibilidad y resistencia a los rayos UV. Color gris. Resistente al alcohol. Especialmente indicado para motores fueraborda. Garantía: 3 años



Marine fuel hose (distribution and vent) for outboards. Fuel resistant thermo-plastic formulation with 2 spiral reinforcement provides excellent bendability and resistance to UV, aging and permeation by all marine fuels (gasoline/petrol and diesel) including alcohol blends. Warranty: 3 years

Tubo «Trident» per linea combustibile. Con rinforzo termoplastico che gli permette un'eccellente flessibilità e resistenza ai raggi UV. Colore grigio. Resistente ai solventi. Indicato per i motori fuoribordo. Garanzia: 3 anni

Tuyau «Trident» pour carburant. Avec renfort thermoplastique qui permet une excellente flexibilité et résistance aux rayons UV. Gris. Résistant à l'alcool. Convient particulièrement aux moteurs hors-bord. Garantie: 3 ans

| REF |  |  |  |  |
|-------------|---|---|---|---|
| TRI305-0566 | 5/16" = 7,92 mm | 15 m | 1 | SAEJ1527 |
| TRI305-0386 | 3/8" = 9,53 mm | 15 m | 1 | ISO-8469 B1 CE |



De goma para diesel y gasolina sin plomo. Ideal para fueraborda. Refuerzos textiles internos. Muy flexible. Contenido aromático 50%

Rubber Hose suitable for loading mineral oils, diesel and unloaded fuel

In gomma per diesel e benzina senza piombo. Ideale per motori fuoribordo. Tessuto interno rinforzato. Molto flessibile.

Caoutchouc pour diesel et essence sans plomb. Idéal pour le hors-bord. Renforts textiles internes. Très flexible



CARBUPOMP/10NL

| REF |  |  |  |  |  |  |
|---------|---|---|---|---|---|---|
| GS35031 | 6x12 | 10 bar | 50 mm | -25°C → 80°C | 50 m | ISO R1307 |
| GS35032 | 8x15 | 10 bar | 65 mm | | 50 m | |

H.T. - CARBUPOMP/10NL - WP 10 BAR - R-1M Q/m - ISO R1307



| | | | | |
|---------------------------------------|---|-------------------------------|------------------------------------|------------|
| MUELLE TUBO COMBUSTIBLE | SPRING, FUEL PIPE | MOLLA TUBO COMBUSTIBLE | RESSORT, TUYAU DE CARBURANT | new |
| REF PAF4-04000030 PAF4-05000010 |  | | | |

| | | | | |
|---|---|--|---|------------|
| ABRAZADERA | CLAMP SMALL | FASCETTE | COLLIER | new |
| REF REC650-24351-51 6 mm REC6E5-24351-51 8 mm |  | REF REC09401-11425 6-8 mm 1 REC09401-11425BULK 6-8 mm 25 |  | |





| | | | |
|---|---|-------------------|-------------------------|
| ADPATADOR LÍNEA DE COMBUSTIBLE | COUPLER | ADATTATORE | RACCORD COUPLEUR |
| REF REC22-8M0001721 Ø 11 mm --> Ø 9 mm |  | | |

| | | | |
|--|--|---|---|
| COMPONENTES TANQUE Y CONECTORES | FUEL TANK COMPONENTS & CONNECTORS | COMPONENTI SERBATOIO E CONETTORI | COMPOSANTS ET CONNECTEURS DU RESERVOIR |
|--|--|---|---|

| | | | | |
|-----------------------------------|---|---------------------------------|-------------------------------------|---|
| CONECTOR DE DEPÓSITO LATÓN | TANK CONNECTOR BRASS | ATTACCO SERBATOIO OTTONE | RACCORDS DE RESERVOIR LAITON |  |
| REF GS31068 1/4" NPT 1 |  | | | |

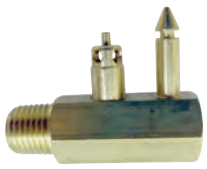
Para conectar dos motores a un sólo depósito, o viceversa. To connect two motors to a single tank, or vice versa. Per collegare due motori a un singolo serbatoio o viceversa. Pour connecter deux moteurs à un même réservoir, ou inversement.

| | | |
|---------------------------|---|---|
| REF GS31069 1/4" NPT 1 |  |  |
|---------------------------|---|---|

| | | | | | |
|-------------------------|---|---|-------------------------|---|---|
| REF GS31073 1/4" NPT |  |  | REF GS31020 1/4" NPT |  |  |
|-------------------------|---|---|-------------------------|---|---|

| | | | |
|-----------------------------|-----------------------|--------------------------|------------------------------|
| CONECTOR DE DEPÓSITO | TANK CONNECTOR | ATTACCO SERBATOIO | RACCORDS DE RESERVOIR |
|-----------------------------|-----------------------|--------------------------|------------------------------|

| | | | | | | | | | |
|---------------------------------|---|--|--|--|---|-----|--|--|--|
| REF GS31088 3B2-702501M 3/8" | OEM |  2T STROKES |  4T STROKES | COMPATIBLE CON CONECTOR COMPATIBLE WITH CONNECTOR COMPATIBLE CON CONNETTORE COMPATIBLE AVEC CONECTEUR | REF GS31019 99998-OMA2 1/4" NPT | OEM |  2T STROKES |  4T STROKES | COMPATIBLE CON CONECTOR COMPATIBLE WITH CONNECTOR COMPATIBLE CON CONNETTORE COMPATIBLE AVEC CONECTEUR |
| 5 ---> 90 HP |  |  | | |  | |  | | |

| REF | OEM | 2T STROKES | 4T STROKES | COMPATIBLE CON CONECTOR COMPATIBLE WITH CONNECTOR COMPATIBILE CON CONNETTORE COMPATIBLE AVEC CONECTEUR |
|---------|-------------|------------|------------|---|
| GS31016 | 3B2-702801M | 3/8" | ✓ | GS31017 |

5 --> 90 HP

| REF | OEM | 2T STROKES | 4T STROKES | COMPATIBLE CON CONECTOR COMPATIBLE WITH CONNECTOR COMPATIBILE CON CONNETTORE COMPATIBLE AVEC CONECTEUR |
|---------|-----|------------|------------|---|
| GS31017 | | 1/4" NPT | ✓ | GS31016 |

5 --> 90 HP

| REF | OEM | 2T STROKES | 4T STROKES | GOLDENSHIP |
|---------|-------------|------------|------------|-----------------|
| GS31018 | 3B2-702601M | Metrica | ✓ | MADE IN THE USA |

5 --> 90 HP

| REF | OEM | 2T STROKES | 4T STROKES | GOLDENSHIP |
|---------|-------------|------------|------------|-----------------|
| GS31015 | 394-702500M | 3/8" | ✓ | MADE IN THE USA |

| PASAMAMPAROS | THRU HULL | PASSASCAFO | PASSE-CLOISON |
|---|---|---|--|
| Para atravesar mamparos de hasta 12 mm. Fabricado en latón. | For bulkhead up to 12 mm. Made in machined brass. | Per attraversare paratie fino a 12 mm. Fabricato in ottone. | Pour traverser des cloisons jusqu'à 12 mm. Fait en laiton. |

| REF | 2T | 4T |
|---------|------|----|
| GS31064 | 3/8" | 1 |

| FILTRO DE COMBUSTIBLE Y ELEMENTOS | FUEL FILTERS AND ELEMENTS | FILTRI BENZINA E RACCORDI | FILTRE A ESSENCE ET CARTOUCHE DE RECHANGE |
|---|---|--|---|
| BRACKET | BRACKET | SUPPORTO | TÊTE DE FILTRE À ESSENCE |
| Con 2 tapones de bronce y 2 tubos de extensión. (2 entradas y 2 salidas). | With 2 brass plugs and 2 extension tubes. (2 inputs & 2 outputs). | Con 2 tappi di bronzo e 2 tubi di estensione. (2 ingressi entrata carburante e 2 uscite carburante). | Avec 2 bouchons en bronze et 2 tubes d'extension. (2 entrées et 2 sorties). |

| REF | 2T | 4T |
|--------------|------|--|
| REC25000 | 1/4" | AL |
| REC25010 | 1/4" | INOX /SS AISI316 |
| REC25020 | 3/8" | AL |
| REC25030 | 3/8" | INOX /SS AISI316 |
| RECOBBRACKET | 1/4" | Plástico Plastic Plastica Plastique |

REC25000 - REC25020 REC25010 - REC25030 RECOBBRACKET

| FILTRO COMBUSTIBLE SEPARADOR DE AGUA | WATER SEPARATING FUEL FILTER | FILTRO SEPARATORE ACQUA-BENZINA | FILTRE SEPARATEUR EAU-ESSENCE |
|--------------------------------------|------------------------------|---------------------------------|-------------------------------|
| REF | MICRON | | |
| REC24942 | 10 | | |
| REC35-802893Q01 | 3Y7-02234-0 | | |
| REC855686 | 28 | | |
| REC35-802893Q | 25 | | |
| RACPF5510 | 10 | | |

RACPF5510 REC24942 REC35-802893Q01 REC855686 REC35-802893Q



| Filtro original. | OEM filter. | Filtro benzina originale. | Filtre à essence d'origine |
|------------------|-------------|---------------------------|----------------------------|
| REF | MICRON | | |
| RM35-802893Q | 10 | | |

FILTRO CON BRACKET
Con 2 tapones de bronce y 1 tubo de extensión.

OEM FILTER WITH BRACKET
With 2 brass plugs & 1 extension tube.

FILTRO BENZINA CON SUPPORTO
Con 2 tappi di bronzo e 1 tubo di estensione.

FILTRE A ESSENCE AVEC SUPPORT
avec 2 bouchons en bronze et 1 tube d'extension

| REF | MICRON |  |  |  |
|----------|--------|---|---|---|
| REC24950 | 25 | 1/4" | 50 GPH | AL |
| REC24952 | 10 | 1/4" | 50 GPH | AL |





FILTRO DECANTADOR DE COMBUSTIBLE COMPLETO CON VASO TRASPARENTE



COMPLET FUEL FILTER WITH TRANSPARENT BOWL

FILTRO DI DECANTAZIONE BENZINA COMPLETO CON VASCHETTA TRASPARENTE

FILTRE DÉCANTEUR ESSENCE AVEC BOL TRANSPARENT

| REF |  |  |
|----------------|---|---|
| RAC320R-RAC-01 | | AL |
| RAC320R-RAC-03 | RACS3213 LENS3213 | Plástico Plastic Plastica Plastique |

RACOR

| REF |  |  |  |
|------------|---|---|---|
| RECOFILALU | | | AL |
| RECOFILTER | RECOBELEMENT LENS3213 | 150 l/h | Plástico Plastic Plastica Plastique |



TOHATSU

FILTRO CON BOMBA CEBADORA

FILTER WITH PRIMMING PUMP

FILTRO CON POMPETA PER RIEMPIRE

FILTRE A ESSENCE AVEC POMPE D'AMORCAGE

| REF |  | MICRON |  |  |  |
|----------------|---|--------|---|---|---|
| RAC490R-RAC-01 | RACS3227 LENS3227 | 10 | 340 l/h | 3/8" NPTF | 150 hp |

RACOR



FILTRO DECANTADOR GASOLINA

COMPLETE FUEL FILTER

FILTRO DECANTATORE BENZINA

FILTRE DÉCANTEUR ESSENCE

Filtro de combustible con braket.

Complete fuel filter with braket.

Filtro combustibile con supporto.

Filtre à carburant avec support.



| REF |  |
|-------------|---|
| RAC23299-10 | RAC23289-10 |

130 HP (4 T/ Strokes)

RACOR



RECAMBIOS MARINOS

| REF |  | MICRON |  |  |
|----------------|---|--------|---|---|
| REC90794-46866 | REC90794-46868 | 10 | 117 l/h | 175 hp |



LLAVE PARA FILTRO
FILTER KEY
CHIAVE DA FILTRO
CLÉ A FILTRE

| REF |
|--------------|
| RECYS-225-15 |





| REF | MICRON |  |
|-----------------|--------|---|
| PAF40-0701000EI | 10 | 70 hp |





new

RÁCORES **RACORS** **RACCORDI** **RACCORDS**

| REF |  |  |  |
|---------|---|---|---|
| GS31065 | 1/4" NPT | 3/8" = 9.5 mm | 1 |
| GS31166 | 1/4" NPT | 5/16" = 7.9 mm | 2 |
| GS31155 | 3/8" NPT | 3/8" = 9.5 mm | 2 |
| GS31156 | 3/8" NPT | 5/16" = 7.9 mm | 2 |
| GS31157 | 3/8" NPT | 1/4" = 6.4 mm | 2 |



| REF |  |  |  |
|---------|---|---|---|
| GS31066 | 1/4" NPT | 5/16" = 7.9 mm | 2 |
| GS31067 | 1/4" NPT | 3/8" = 9.5 mm | 2 |



GOLDENSHIP

LLAVES PARA FILTRO **FILTER KEY** **CHIAVE DA FILTRO** **CLÉ À FILTRE**

| REF |
|------------|
| RACRK22628 |

RACOR







| REF | 65 - 110 mm |
|----------|-------------|
| REC70720 | |

RECMAR



FILTRO COMBUSTIBLE PARA MONTAJE EN LINEA **IN-LINE FUEL FILTER** **FILTRO BENZINA PER MONTARE IN LINEA** **FILTRE A ESSENCE EN LIGNE**

| REF |  |  |  |  |
|---------|---|---|---|---|
| GS31001 | 50 l/h | 6-8 mm | plástico plastic plastica plastique | 1 |
| GS31002 | 150 l/h | 8-10 mm | | 1 |



GS31001



GS31002

GOLDENSHIP

| REF | OEM |
|----------------|---|
| PAF15-07080000 | 3AC-02230-0 3AD-02230-0 3B7-02230-0 |

 MFS25
MFS25B
MFS30





new



| REF |  |  |  |
|---------|---|---|---|
| GS30435 | 6, 8, 10 mm | metal + cristal metal + crystal metallo + cristallo métal + verre | 1 |





GOLDENSHIP

| REF | OEM |
|---|-----------------------------|
| REC35-80365M | |
|  6 | (1989, 1992-99) |
| 8 | (1989-99, 2001-02) |
| F4 | (1999-02) |
| F9.9 | (1989-95, 1997-99, 2001-02) |
| FT 9.9 | (1988-90) |



| REF | OEM |  |  |  |
|----------|-------|---|---|---|
| REC40145 | 40145 | 1/4" | 1/4" | plástico |
| REC40155 | 40155 | 5/16" | 5/16" | plastic |
| REC40165 | 40165 | 3/8" | 3/8" | plastica |
| REC40135 | 40135 | 5/16" | 3/8" | plastique |



| REF | OEM |
|--|----------------------------|
| PAF4-05000300 | 346-02230-0 366-02230-0 |
|  M5 | MFS4 |
| M9.8 | MFS5 |
| M9.9 | MFS6 |
| M15 | MFS8 |
| M18 | MFS9.9 |
| M40 | MFS15 |
| | MFS20 |
| | MFS30 |



| REF | OEM |
|---|----------------|
| REC16911-ZZ5-003 | HZZ5-16911-003 |
|  BFTW60A | |
| BFT60A | |



new

| REF | OEM |
|--|----------------|
| REC16911-ZY3-010 | HZY3-16911-010 |
|  BFT75AK1 | |
| BFT90AK1 | |
| BFT115A | |
| BFT250A | |
| BFT225A | |
| BFT200A | |
| BFT150A | |





new

ACEITE



OIL

OLIO

HUILES

| REF |  |  | |
|------------|---|---|-----------|
| REC2TU6 | 1 L | 6 | 2 STROKES |
| REC2TU3 | 5 L | 3 | TC-W3 |
| REC5W40U6 | 1 L | 6 | SAE 5W40 |
| REC5W40U3 | 5 L | 3 | |
| REC10W30U6 | 1 L | 6 | SAE 10W30 |
| REC10W30U3 | 5 L | 3 | |
| REC10W40U6 | 1 L | 6 | SAE 10W40 |
| REC10W40U3 | 5 L | 3 | |
| REC25W40U3 | 5 L | 3 | SAE 25W40 |
| REC80W90U3 | 5 L | 3 | SAE 80W90 |
| REC80W90U6 | 1 L | 6 | |



| REF |  |  | |
|------------------|---|---|-----------|
| RM92-858026QB1U6 | 1 L | 6 | 2 STROKES |
| RM92-858027QB1U3 | 3,8 L | 3 | |
| RM92-8M0086220U6 | 1 L | 6 | SAE 10W30 |
| RM92-8M0086221U3 | 4 L | 3 | |



RM92-858026QB1U6

RM92-858027QB1U3

RM92-8M0086220U6

RM92-8M0086221U3

FILTRO DE ACEITE

OIL FILTER

FILTRO OLIO

FILTRE À HUILE

| REF | OEM | 4T STROKES |
|-----------------|---|---------------|
| REC5GH-13440-00 | 3R3R76150M 3RO-07615-0 5GH-13440-00 | ✓ |

 MFS15
 MFS20
 MFS20
 MFS30
 MFS40
 MFS50
 MFS60



| REF | OEM |
|--------------------|--------------------------------|
| REC15400-PLM-A01PE | HPLM-15400-A0 HPLM-15400-PE |

 BFT75AK1
 BFT90AK1
 BFT225A
 BFT250A
 BFT200A
 BFT150A
 BFT115A



BOMBA DE COMBUSTIBLE

FUEL PUMP

POMPA BENZINA

POMPE À ESSENCE

MEMBRANAS Y JUNTAS

DIAPHRAGMS & GASKETS

MEMBRANA E GUARNIZIONI

MEMBRANES ET JOINTS

| REF | OEM |
|------------|-------------|
| REC8537312 | 350-04005-0 |

 M9.9D2
 M15D2
 M18E2
 M40D2
 M50D2

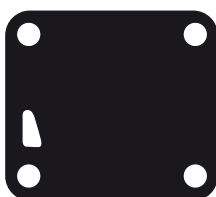

| REF | OEM |
|---------------|-------------|
| REC27-8555691 | 3C8-04028-0 |

 M9.9D2
 M15D2
 M18E2
 M40D2
 M50D2

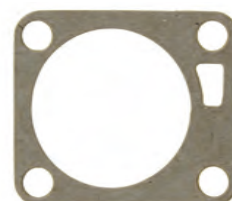

| REF A | OEM |
|----------|-------------|
| REC16275 | 369-03303-0 |

 M4C
 M5B
 M5BS
 M6B
 M8B
 M9.8B

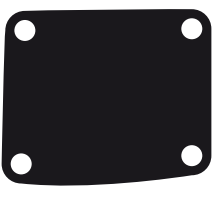

| REF | OEM |
|-------------|-------------|
| REC27-16274 | 369-03302-0 |

 M4C
 M5B
 M5BS
 M6B
 M8B
 M9.8B

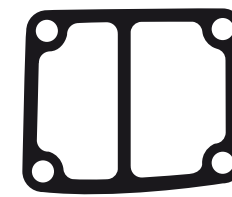

| REF B | OEM |
|----------|-------------|
| REC16325 | 369-03306-0 |

 M4C
 M5B
 M5BS
 M6B
 M8B
 M9.8B



| REF | OEM |
|-------------|-------------|
| REC27-16326 | 369-03307-0 |

 M4C
 M5B
 M5BS
 M6B
 M8B
 M9.8B

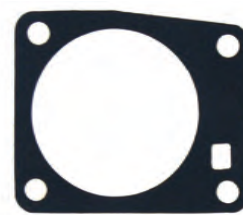

CARBURADOR

CARBURATOR

CARBURATORE

CARBURATEUR

CARBURADOR COMPLETO

FULL CARBURATOR

CARBURATORE COMPLETO

CARBURATEUR COMPLET

| REF | OEM | 4T STROKES |
|---------------|----------------------------|---------------|
| PAF8-05040000 | 3F5-03100-0 3V2-03100-2 | ✓ |

 MFS8
 MFS9.8HP



KITS CARBURADORES

CARBURETOR KITS

KIT CARBURATORI

KIT CARBURATEUR

| REF | OEM |
|-----------------|-------------|
| REC6H3-W0093-02 | 346-87122-0 |



 45A2
 50C
 60C
 70A2
 M25C3
 M30A4

| REF | OEM |
|-----------------|----------------------------|
| REC6G1-W0093-00 | 369-87122-1 3B2-87122-0 |



 5B
 8B
 9.8
 M4

M5
 M6
 M8
 M9.8

| REF | OEM |
|-----------------|-------------|
| REC6H4-W0093-03 | 3F3-87122-1 |

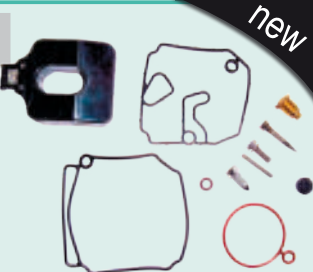

 M70

new

| REF | OEM |
|-----------------|-------------|
| REC66M-W0093-01 | 3V1-87122-0 |



 MFS8
 MFS9

new

| REF | OEM |
|--------------------|-------------|
| REC6H1-W0093-01-00 | 346-87122-0 |



 M25
 M30

new

| REF | OEM |
|-----------------|-------------|
| REC696-W0093-00 | 345-87122-4 |



 C2
 M40

new

| REF | OEM |
|-----------------|-------------|
| REC6A1-W0093-01 | 3F0-87122-2 |



 M2.5
 M3.5

new

KITS 2 CARBURADORES

KITS FOR 2 CARBURETORS

KIT 2 CARBURATORI

KIT 2 CARBURATEURS

| REF | OEM |
|-----------|-------------|
| REC84419M | 345-87122-0 |



 M35C
 M40C

| REF | OEM |
|-----------------|----------------------------|
| REC6L2-W0093-00 | 3C8-87122-2 3G2-87122-2 |



 M50
 M15
 M18

new

BOYAS

FLOATS

GALLEGGIANTE

FLOTTEUR DE CARBURATEUR

| REF | OEM |
|-----------|-------------|
| REC162532 | 3C8-03125-0 |



 M9.9D2
 M15D2
 M18W2
 M40D2

M50D2
 MF8, 9.8A-A2-A3
 MFS15C
 MFS20C

| REF | OEM |
|----------|-------------|
| REC16253 | 369-03231-0 |



 M4B
 M5B
 M5BS
 M6B

M8B
 M9.8B

TOHATSU

RECAMBIOS MARINOS

SISTEMA ELÉCTRICO ELECTRIC SYSTEM

SISTEMA ELETTRICO SYSTEME ÉLECTRIQUE

SENSORES

SENSORS

SENSORE

CAPTEURS

SENSOR PRESIÓN DE ACEITE

OIL PRESURE SENSOR

SENSORE PRESIONE OLIO

CAPTEUR PRESION HUILE

| REF | OEM |
|---|-------------|
| PAF15-07010100 | 3H6-07611-0 |
|  MFS4 --> MFS40 HP | |





SENSOR DE OXÍGENO

OXYGEN SENSOR

SENSORE OSSIGENO

SONDE À OXYGENE

| REF | OEM |
|--|----------------|
| REC35668-ZY6-003 | HZY6-35668-003 |
|  BFT150A BFT115A | |



SENSOR POSICIÓN ÁRBOL DE LEVAS

CAMSHAFT SENSOR

SENSORE ALBERO A CAME

CAPTEUR DE POSITION D'ARBRE A CAMES

| REF | OEM |
|--|----------------|
| REC37510-PNB-003 | HPNB-37510-003 |
|  BFT150A BFT115A | |



BOBINAS

COILS

BOBINE

BOBINES

BOBINA

COIL

BOBINA

BOBINE

| REF | OEM |
|--|-------------|
| PAF8-05000300 | 3AA-06021-0 |
|  MFS8 MFS9.8 | |



| REF | OEM |
|--|-------------|
| REC3G3-06021-1 | 3G3-06021-1 |
|  M9.9D2 M15D2 M18E2 M25C3 M30A4 | |



| REF | OEM |
|---|-------------|
| REC369-06021-0 | 369-06021-0 |
|  M4C M5B-BS | |



TOHATSU

RECAMBIOS MARINOS

BOBINA ENCENDIDO**STARTER COIL****BOBINA AVVIAMENTO****BOBINE DEMARREUR**

| REF | OEM |
|---------------|--|
| PAF8-05000500 | 3V1-06040-0 3V1060400 3V1060400M |

**BOBINA DE PULSACIÓN****PULSER COIL****BOBINA ACCENSIONE****BOBINE PULSEUR**

| REF | OEM |
|---------------|-------------|
| PAF8-05000200 | 3V1-06071-0 |

**BOBINA DE IGNICIÓN****COIL IGNITION****BOBINA AVVIAMENTO****BOBINE D'ALLUMAGE**

| REF | OEM |
|----------------|-------------|
| REC3A0-06040-1 | 3A0-06040-1 |



| REF | OEM |
|----------------|-------------|
| REC3G2-06040-2 | 3G2-06040-2 |



| REF | OEM |
|------------------|----------------|
| REC30580-ZV4-013 | HZV4-30580-013 |

BFT75AKI
BFT90AKI

BOBINA DE CARGA**CHARGER COIL****BOBINA DI CARICA****BOBINE DE CHARGE**

| REF | OEM |
|----------------|-------------|
| PAF8-05090000W | 3V1-06023-0 |

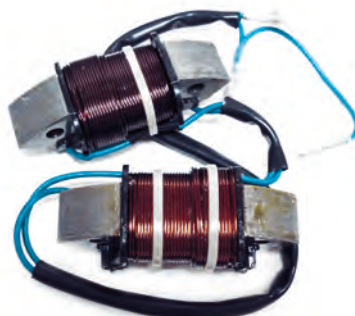

BUJÍAS

SPARK

CANDELE

BOUGIES

| 2T STROKES | REF NGK | RO / OEM |
|------------------------------|--------------|-------------|
| M2.5/ M3.5/ 3/ 5B2 | NGKBPR6HS-10 | 9701-1-1013 |
| M4/ M5/ M6/ M8/ M9.8 | NGKBPR7HS-10 | 9701-1-1014 |
| M9.9/ M25/ M30/ 40D2 | NGKBR7HS-10 | 9701-1-1015 |
| MX40/ 50D3 | NGKB8HS-10 | 9701-1-1006 |
| MC4 through 9.8B, MX15/ 18E2 | NGKBP7HS-10 | 9701-1-1010 |
| M25/ 30H/ MX25 | NGKB7HS-10 | 9701-1-1005 |
| M50D2 Through 140A2 | NGKBR8HS-10 | 9701-1-1110 |

| 4T STROKES | REF NGK | RO / OEM |
|--------------------------------|-------------|----------------|
| MFS2.5 Through 30C | NGKDCPR6E | 9701-1-1103 |
| MD30/ MD40/ MD50/ MD75/ MD90 | NGKIZFR6 | 9701-1-1111 |
| MFS40/ 50A (Serial 046502AE +) | NGKIKR6G8 | 9701-1-1121 |
| MD115A2 (TLDI) | NGKIZFR5J | 9791-1-1109 |
| BFT60A | NGKLMAR6C-9 | HZZ3-31909-003 |



| 2T STROKES | REF CHAMPION |
|------------------|--------------|
| M3.5A / B | CHAL87YCC |
| M5B / BS | CHAL82YC |
| M6B | CHAL82YC |
| M8A / B 2Cil. | CHAL82YC |
| M9.9B2 / C 2Cil. | CHAL82C |
| B18C / D | CHAL86C |
| M12B | CHAL82C |
| M15A / B2 2Cil. | CHAL82C |
| M15C / D | CHAL82C |
| M16 | CHAL82C |
| M18A / C2 2Cil. | CHAL82C |
| M18D / E | CHAL82C |
| M20 | CHAL82C |

| 2T STROKES | REF CHAMPION |
|-----------------|--------------|
| B40A | CHAL86C |
| B30C | CHAL86C |
| M25C / C2 2Cil. | CHAL82C |
| M30A / A3 2Cil. | CHAL82C |
| M35A | CHAL82YC |
| M40C 2Cil. | CHAL82YC |
| M40D 3Cil. | CHAL82YC |
| M50C / D 3Cil. | CHAL78C |
| M70A / A2 3Cil. | CHAL78C |
| M70B | CHAL78C |
| M90A 3Cil. | CHAL78C |
| M115A 4Cil. | CHAL78C |
| M140A 4Cil. | CHAL78C |

| 4T STROKES | REF CHAMPION |
|------------|--------------|
| MFS4 | OHV CHARA8HC |
| MFS5A | OHV CHARA8HC |
| MFS5C | OHV CHARA8HC |
| MFS9.9A | OHV CHARA8HC |
| MFS15A | OHV CHARA8HC |



MOTORES DE ARRANQUE

STARTERS

MOTORINI AVVIAMENTO

DÉMARREURS

MOTORES DE ARRANQUE STARTERS

| REF | OEM | ⚡ | ☀️ | 2T STROKES | 4T STROKES |
|------------|--|-----|--------|------------|------------|
| PH130-0006 | 3C8-76010-1 3C8760101 3C8760101M | 12V | 0.6 kw | 9 CCW | ✓ ✓ |

- M40D2/B2
- M50D2/B2
- M70C
- MFS9.9B2-C
- MFS15B2-C
- MFS18B2
- MFS20C
- MFS25A-B
- MFS30B



MOTORINI AVVIAMENTO DÉMARREURS

| REF | OEM | ⚡ | ☀️ | 2T STROKES | 4T STROKES |
|------------|--------------------------|---|----|------------|------------|
| PH130-0061 | 350-76010-0 3AA760100 | | | ✓ | ✓ |

- M15D2
- M18E2
- M8B
- M9.8B
- M9.9D2
- MFS8A2
- MFS9.8A2



| REF | OEM | ⚡ | ☀️ | 2T STROKES | 4T STROKES |
|------------|-------------|---|----|------------|------------|
| PH130-0048 | 353-76010-4 | | 9 | ✓ | |

- MD70B
- MD90B
- MD115A-A2
- MD120A2
- MD140A2



| REF | OEM | ⚡ | ☀️ | 2T STROKES | 4T STROKES |
|------------|---|---|----|------------|------------|
| PH130-0080 | 346-76010-0, 346-76010-0A0 346-76010-0M | | | ✓ | |

- M25C3
- M30A4
- M40C



TOHATSU

RECAMBIOS MARINOS

new



| REF | OEM | ⚡ | ☀️ | 2T STROKES | 4T STROKES |
|------------------|----------------|---|----|---------------|---------------|
| REC31200-ZY6-003 | HZY6-31200-003 | | | | ✓ |

 BFT150A
 BFT115A



new

| REF | OEM | ⚡ | ☀️ | 2T STROKES | 4T STROKES |
|------------|----------------|---|----|---------------|---------------|
| PH130-0070 | HZY3-31200-003 | | | | ✓ |

 BFT250A
 BFT225A
 BFT200A



CDI Y CAJAS NEGRAS

CDI & POWER PACK

CDI E CENTRALINA

CDI ET BOITIER ELECTRONIQUE

| REF | OEM |
|----------------|-------------|
| REC3F0-06060-0 | 3F0-06060-0 |

 M2.5A2
 B3.5A2-B2







| REF | OEM |
|----------------|----------------------------|
| REC353-06260-0 | 353-06260-2 353-06260-0 |

 45A2
 55B
 60A
 75A2







| REF | OEM |
|----------------|-------------|
| REC3G2-06060-2 | 3G2-06060-2 |

 M9.9D2
 B15D2
 M18E2





| REF | OEM |
|----------------|---|
| REC3A106-2602M | 3A106-2402M 3A106-2601M 3A106-2602M |

 25C2
 30A3
 40C



| REF | OEM |
|---------------|----------------------------|
| PAF8-05000400 | 3AA-06060-00 3AA060600M |

 MFS8
 BFS9.8



TRIM, TILT & POWER TRIM

INSTALACIÓN ELÉCTRICA

WIRING HARNESS

INSTALLAZIONE ELETTRICA

INSTALLATION ELECTRIQUE

KIT CONVERSIÓN

Sustituye de 2 a 3 cables.

CONVERSION KIT

Converts 3-wire Tilt and Trim motors to 2-Wire design

KIT CONVERSIONE

Sustituisce da 2 a 3 cavi.

KIT DE CONVERSION.

Passes un faisceau de 2 à 3 fils



REF

PH200-WH01

TRIM COMPLETO

COMPLETE TRIM ASSEMBLY

MOTORINO TRIM COMPLETO

MOTEUR DE TRIM

| REF | OEM | ⚡ | 🔩 | ✂️ | 2T STROKES | 4T STROKES |
|------------|-----|-----|---|----|------------|------------|
| PH200-T024 | | 12V | 3 | 2 | ✓ | |

V4, V6 (1990-03)



POWER TRIM COMPLETO

COMPLETE POWER TRIM ASSEMBLY

MOTORINO POWER TRIM COMPLETO

POWER TRIM COMPLET

| REF | 2T STROKES | 4T STROKES |
|------------|------------|------------|
| REC18-6865 | ✓ | ✓ |

3 RAM
115-225HP
SHOWA SYSTEM





SISTEMA DE GOBIERNO STEERING SYSTEM

SISTEMA DI GUIDA SYSTÈME DE COMMANDE

| COMPONENTES | COMPONENTS | COMPONENTI | COMPOSANT | | | | |
|---|----------------|-------------------|----------------------|-------------|--|--|--|
| CABLE DE ACELERADOR | THROTTLE CABLE | CAVO ACCELERATORE | CÂBLE D'ACCELERATEUR | | | | |
| <table border="1"> <thead> <tr> <th>REF</th> <th>OEM</th> </tr> </thead> <tbody> <tr> <td>REC804898</td> <td>3B2-63600-1</td> </tr> </tbody> </table>  <p>M6B M8B M9.8B</p> | REF | OEM | REC804898 | 3B2-63600-1 | | | |
| REF | OEM | | | | | | |
| REC804898 | 3B2-63600-1 | | | | | | |

SISTEMA DE REFRIGERACIÓN COOLING SYSTEM

SISTEMA DI RAFFREDDAMENTO SYSTÈME DE REFROIDISSEMENT

| TERMOSTATO | THERMOSTAT | TERMOSTATO | THERMOSTAT | | | | | | | | | | | | |
|---|----------------|------------|------------|----------------|----------------|-----|--|--|-----|-----|----|------------------|----------------|--|--|
| TERMOSTATO | THERMOSTAT | TERMOSTATO | THERMOSTAT | | | | | | | | | | | | |
| <table border="1"> <thead> <tr> <th>REF</th> <th>OEM</th> <th>°C</th> </tr> </thead> <tbody> <tr> <td>REC855676002</td> <td>3R3-01030-0</td> <td>60°</td> </tr> </tbody> </table>  <p>MFS8 MFS30</p> | REF | OEM | °C | REC855676002 | 3R3-01030-0 | 60° | | <table border="1"> <thead> <tr> <th>REF</th> <th>OEM</th> <th>°C</th> </tr> </thead> <tbody> <tr> <td>REC19300-ZV5-043</td> <td>HZV5-19300-043</td> <td></td> </tr> </tbody> </table>  <p>BFT115A BFT130A BFT150A</p> | REF | OEM | °C | REC19300-ZV5-043 | HZV5-19300-043 | | |
| REF | OEM | °C | | | | | | | | | | | | | |
| REC855676002 | 3R3-01030-0 | 60° | | | | | | | | | | | | | |
| REF | OEM | °C | | | | | | | | | | | | | |
| REC19300-ZV5-043 | HZV5-19300-043 | | | | | | | | | | | | | | |
| <table border="1"> <thead> <tr> <th>REF</th> <th>OEM</th> <th>°C</th> </tr> </thead> <tbody> <tr> <td>PAF15-07000031</td> <td>HZW9-19300-003</td> <td></td> </tr> </tbody> </table>  <p>BFT90AK1 BFT75AK1 BFT60A BFTW60A</p> | REF | OEM | °C | PAF15-07000031 | HZW9-19300-003 | | | | | | | | | | |
| REF | OEM | °C | | | | | | | | | | | | | |
| PAF15-07000031 | HZW9-19300-003 | | | | | | | | | | | | | | |

JUNTA TERMOSTATO

THERMOSTAT, GASKET BASE

GUARNIZIONE TERMOSTATO

JOINT DE THERMOSTAT

| REF | OEM |
|----------------|-------------|
| REC3T9-01032-0 | 3T9-01032-0 |

MD75C2
MD70B / C2
MD90D / C2



JUNTAS TAPA, DE REFRIGERACIÓN

GASKETS EXHAUST INNER COVER

GUARNIZIONE COPERCHIO REFRIGERAZIONE

JOINT DE COUVERCLE DE REFRIGERANT

| REF | OEM |
|----------------|-------------|
| REC3F3-02305-1 | 3F3-02305-1 |

M60C
M70C

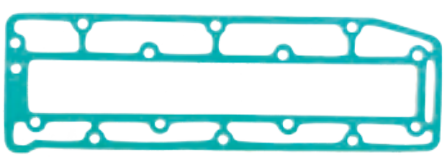

| REF | OEM |
|----------------|-------------|
| REC3B7-02305-1 | 3B7-02305-1 |

MD70B
MD90D

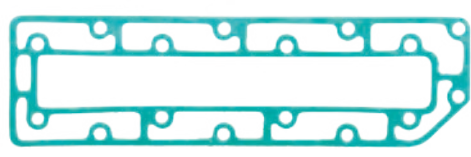

IMPULSORES

IMPELLERS

GIRANTE

TURBINES

GUÍA DE IMPULSORES

IMPELLER GUIDE

GUIDA GIRANTE

GUIDE DES TURBINES

| 2T STROKES | REF | OEM | CEF | A (mm) | B (mm) | C (mm) |
|--------------------|----------------|-------------|-----------|--------|--------|--------|
| 2 / 2.5HP | | 369-65021-1 | CEF500377 | 10,25 | 33,6 | 14,3 |
| 2.5A/3.5A/3.5B | | 309-65021-1 | CEF500396 | 12 | 41 | 14 |
| 3.5 / 4 / 5 HP | | 369-65021-1 | CEF500377 | 10,25 | 33,6 | 14,3 |
| 6 / 8 / 9.8 HP | REC3B2-65021-1 | 3B2-65021-1 | CEF500344 | 12,1 | 40 | 18 |
| 9.9 / 15 / 18 HP | | 334-65021-0 | CEF500383 | 13,96 | 40,7 | 23,35 |
| 25 / 30 / 35 HP | REC345-65021-0 | 345-65021-0 | CEF500382 | 17,12 | 44,1 | 20,25 |
| 40 / 50 HP | | 345-65021-1 | CEF500379 | 17,2 | 50,4 | 20,15 |
| 60 / 70 / 90 HP | REC3B7-65021-2 | 3B7-65021-2 | CEF500388 | 20,15 | 67,4 | 35,1 |
| 115 / 120 / 140 HP | | 3C7-65021-1 | CEF500388 | 20,15 | -67,4 | 35,1 |

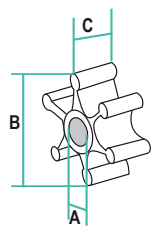

| 4T STROKES | REF | OEM | CEF | A (mm) | B (mm) | C (mm) |
|---------------------------|------------------|----------------|-----------|--------|--------|--------|
| MFS4, 5, 6HP | | 369-65021-1 | CEF500377 | 10,25 | 33,6 | 14,3 |
| MFS8, 9.8 HP | REC3B2-65021-1 | 3B2-65021-1 | CEF500344 | 12,1 | 40 | 18 |
| MFS9.9, 15, 18HP | | 334-65021-0 | CEF500383 | 13,96 | 40,7 | 23,35 |
| 20HP | | 334-65021-0 | CEF500383 | 13,96 | 40,7 | 23,35 |
| MFS25, 30HP | REC345-65021-0 | 345-65021-0 | CEF500382 | 17,12 | 44,1 | 20,25 |
| BFTW60A BT60A | REC19210-ZV5-003 | HZV5-19210-003 | CEF500338 | 17,20 | 55,90 | 20,20 |
| BFT115A / 150A | REC19210-ZW1-B02 | HZW1-19210-B04 | CEF500337 | 23,35 | 87,80 | 31,00 |
| BFT200A / 225A BFT250A | REC19210-ZY3-003 | HZY3-19210-003 | CEF500391 | 26 | 89,75 | 31,30 |



REC345-65021-0



REC3B2-65021-1

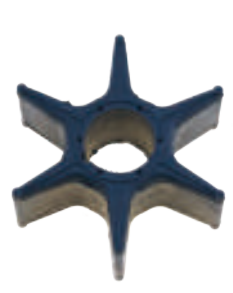

REC19210-ZY3-003



REC19210-ZV5-003



REC19210-ZW1-B02



REC3B7-65021-2

BOMBA DE AGUA

WATER PUMP

POMPA ACQUA

POMPE À EAU

JUNTA BASE DE BOMBA

WATER PUMP, GASKET BASE

GUARNIZIONE BASE POMPA

JOINT, BASE DE POMPE À EAU

| REF | OEM |
|---|-------------|
| PAF8-04000007 | 3B2-65025-0 |
|  MD9.9D2 | MFS9.9B2-C |
| MD15D2 | MFS15C |
| MD18E2 | MFS18B2 |
| | MFS20C |



| REF | OEM |
|--|-------------|
| REC16159 | 369-65025-0 |
|  MFS4A2-B-C | |
| | MFS5A2-B-C |
| | MFS4A2-B-C |



JUNTAS BOMBA

WATER PUMP GASKET

GUARNIZIONE POMPA

JOINTS DE POMPE

| REF | OEM |
|--|-------------|
| REC3F0-65029-0 | 3F0-65029-6 |
|  M3.2B2 | |
| | MFS2.5B |
| | MFS3.5B |
| | MFS2A |



CASQUILLO INOX

INSERT CUP

GHIERA INOX

INSERT INOX

| REF | OEM |
|--|-------------|
| REC803751 | 350-65011-1 |
|  M9.9D2 | |
| | M15D2 |
| | M18E2 |
| | MFS9.9C, B2 |
| | MSF15C, B2 |
| | MSF20C |
| | MSF18B2 |



| REF | OEM |
|--|------------------|
| PAF8-04000010 | 3B2-65011-0 |
|  M6 | |
| | M8 |
| | M9.8B |
| | MFS8, A - A2 -A3 |
| | MFS9.8A - A2 -A3 |



| REF | OEM |
|---|----------------|
| REC16157 | 369-65011-0 |
|  M4B | |
| | M5B |
| | M5B5 |
| | MFS4, 5, 6 -A2 |



KITS DE REPARACIÓN BOMBA DE AGUA

WATER PUMP SERVICE KITS

KIT RICAMBI POMPA ACQUA

KIT POMPE À EAU

new

| REF | OEM |
|--|----------------|
| REC06192-ZY6-000 | HZY6-06192-000 |
|  BFT150 | |
| | BFT115A |

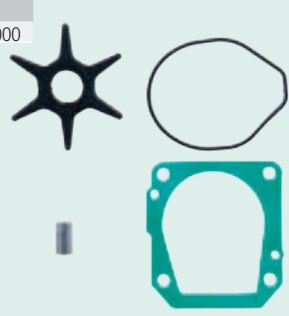

new

| REF | OEM |
|---|----------------|
| REC06192-ZY3-000 | HZY3-06192-000 |
|  BFT200A | |
| | BFT225A |

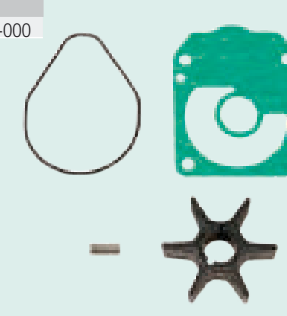



ÁNODO

ANODE

ANODI

ANODE

| ZN | KG (KG) | AL | KG (KG) | OEM |
|--------------|---------|---------------|---------|-------------|
| CM3C760-2181 | 0,51 | CM3C760-2181A | 0,21 | 3C7760-2181 |

60, 70, 90, 120, 140 HP

| ZN | KG (KG) | OEM |
|---------------|---------|-------------|
| CM3B7-60218-0 | 0,51 | 3B7-60218-1 |

Serie MEGA

| ZN | KG (KG) | AL | KG (KG) | OEM |
|----------------|---------|-----------------|---------|--------------|
| CM5338602182A0 | 0,21 | CM5338602182A0A | 0,08 | 5338602182A0 |

| ZN | KG (KG) | AL | KG (KG) | OEM |
|-----------------|---------|------------------|---------|-------------|
| CM3H6-60218-000 | 0,03 | CM3H6-60218-000A | 0,01 | 3H6-60218-0 |

| ZN | KG (KG) | OEM |
|---------------|---------|-------------|
| CM3M2-60218-1 | 0,05 | 3M2-60218-0 |

40, 140 HP

| ZN | KG (KG) | OEM |
|--------------|---------|-------------|
| CM33860-2181 | 0,10 | 338-60218-2 |

2,5, 3,5, 5, 6, 8 HP
15, 18, -S MAXI 25, 40
CORSA

| ZN | KG (KG) | AL | KG (KG) | OEM |
|---------------|---------|----------------|---------|-----------|
| CM3V1-60217-0 | 0,10 | CM3V1-60217-0A | 0,04 | 3V1602170 |

| ZN | KG (KG) | OEM |
|----------------|---------|-------------|
| CM348-60217-0M | 0,12 | 348-60217-0 |

Serie MAXI CORSA
25-40 HP

| ZN | KG (KG) | OEM |
|---------------|---------|-------------|
| CM3C8-60217-0 | 0,15 | 3C8-60217-1 |

Serie MEGA
25-50 HP

| ZN | KG (KG) | OEM |
|--------------|---------|-------------|
| CM3B7-602170 | 0,15 | 3B7-60217-0 |

60, 70, 90, 120, 140 HP

ÁNODO

ANODE

ANODI

ANODE

| ZN | KG (KG) | OEM |
|----------|------------|-------------|
| TEN01254 | 0,51 | 3C7-60218-2 |

☛ Serie 60 - 70 - 90 - 120 - 140 - 150 HP



| ZN | KG (KG) | OEM |
|----------|------------|-------------|
| TEN01253 | 0,150 | 3C8-60217-1 |

☛ Serie MEGA 25 - 50 HP



| ZN | KG (KG) | OEM |
|----------|------------|-------------|
| TEN01256 | 0,040 | 3B7-60218-1 |

☛ Serie MEGA



| ZN | KG (KG) | OEM |
|----------|------------|-------------|
| TEN01252 | 0,120 | 348-60217-0 |

☛ Serie MAXI CORSA 25 - 40 HP



| ZN | KG (KG) | OEM | Ø |
|----------|------------|-------------|-------|
| TEN01250 | 0,010 | 338-60218-2 | 20 mm |
| TEN01251 | 0,020 | 369-60218-1 | 24 mm |

☛ Serie 2.5, 3.5, 5, 6, 8 HP
15 - 18-S MAXI-25 - 40 CORSA



| ZN | KG (KG) | OEM |
|----------|------------|-------------|
| TEN01255 | 0,320 | 3B7-60217-0 |

☛ Serie 60 - 70 - 90 - 120 - 140 HP



| ZN | KG (KG) | OEM |
|----------|------------|-------------|
| TEN01257 | 0,050 | 3M2-60218-0 |

☛ Serie 40 - 140 HP



| ZN | KG (KG) | OEM |
|----------|------------|--------------|
| TEN01258 | 0,020 | 5338602182A0 |

☛ Serie 40 - 140 HP



| ZN | KG (KG) | OEM |
|----------|------------|----------------|
| TEN01408 | 0,320 | HZV4-12155-A00 |

☛ BFTW60A
BFT60A
BFT200A
BFT250A
BFT225A



| ZN | KG (KG) | OEM |
|----------|------------|-------------|
| TEN01259 | 0,030 | 3H6-60218-0 |



| ZN | KG (KG) | OEM |
|------------|------------|----------------|
| TEN01408/1 | 0,320 | HZV5-12155-000 |

☛ BFT60A
BFT75AK1
BFT90AK1
BFT150A
BFT200A
BFT250A
BFT225A
BFT115A



| ZN | KG (KG) | OEM |
|----------|------------|-------------|
| TEN01260 | 0,150 | 3B7-60217-0 |

☛ Serie 140 HP



PARTES DEL MOTOR ENGINE PARTS

PARTI MOTORE PIECES MOTEUR

DESPIECE MOTOR
DE 2 TIEMPOS

ENGINE PARTS
2 STROKES

PARTI MOTORI
2 TEMPI

PIECES DE MOTEURS
2 TEMPS

2T
STROKES M4C • M5B • M5BS

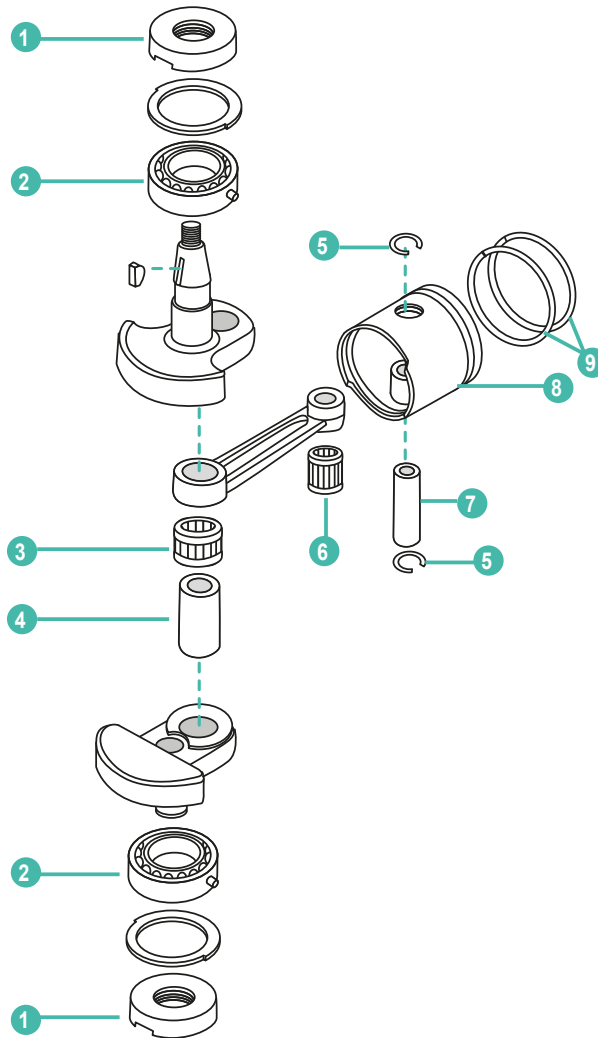

| | REF | OEM | | | | | UN. |
|---|--------------|-------------|-------------------|-----------------|-------------|-----------------|-----|
| 1 | REC26-16051 | 369-00122-0 | RETÉN ACEITE | OIL SEAL | PARALIO | JOINT SPI | 2 |
| 2 | REC30-16049 | 9603-3-6204 | RODAMIENTO | BALL BEARING | CUSCINETTO | ROULEMENT | 2 |
| 3 | REC31-813048 | 369-00043-0 | COJINETE DE AGUJA | NEEDLE BEARING | CUSCINETTO | ROULEMENT | 1 |
| 4 | REC813046002 | 369-00061-0 | PIN | CRANK PIN | SPINOTTO | PIN | 1 |
| 5 | REC53-16057 | 350-00024-1 | CLIP | CLIP | CLIP | CLIP | 2 |
| 6 | REC31-16052 | 350-00042-0 | COJINETE DE AGUJA | NEEDLE BEARING | CUSCINETTO | ROULEMENT | 1 |
| 7 | REC41-16056 | 369-00021-0 | PIN | PISTON PIN | SPINOTTO | AXE DE PISTON | 1 |
| 8 | REC779-9615T | 369-00001-0 | PISTÓN STD | PISTON STD | PISTONE STD | PISTON STD | 1 |
| 9 | REC8M0080357 | 351-00011-0 | KIT SEGMENTOS | PISTON RING KIT | KIT FASCIA | KIT DE SEGMENTS | 2 |

TOHATSU

RECAMBIOS
MARINOS

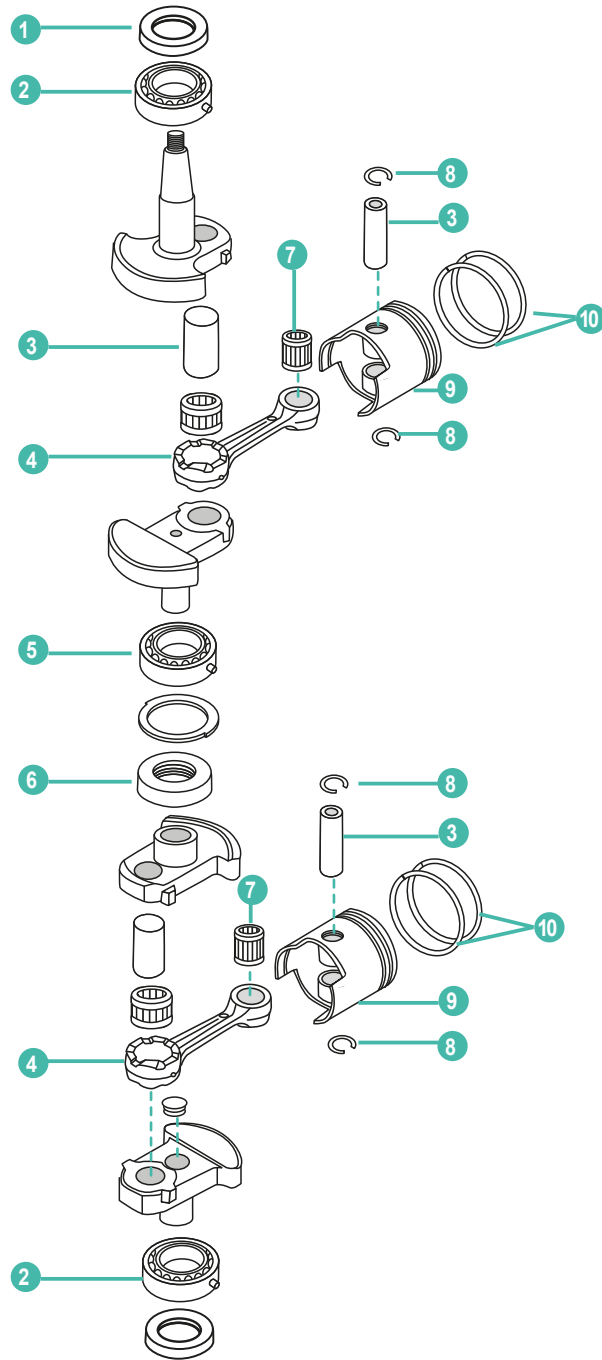

| | REF | OEM | | | | | UN. |
|----|----------------|-------------|-------------------|-----------------|-------------|-----------------|-----|
| 1 | REC26-803514 | 101-00121-0 | RETÉN ACEITE | OIL SEAL | PARALIO | JOINT SPI | 1 |
| 2 | REC30-16049 | 9603-3-6204 | RODAMIENTO | BALL BEARING | CUSCINETTO | ROULEMENT | 2 |
| 3 | REC41-8036801 | 3B2-00021-0 | PIN | PISTON PIN | SPINOTTO | AXE DE PISTON | 2 |
| 4 | REC629-8036741 | 3B2-00040-0 | BIELA | CONNECTING ROD | BIELLA | BIELLE | 2 |
| 5 | REC30-16049 | 9603-3-6204 | RODAMIENTO | BALL BEARING | CUSCINETTO | ROULEMENT | 1 |
| 6 | REC26-85370711 | 3B2-00051-0 | RETÉN ACEITE | OIL SEAL | PARALIO | JOINT SPI | 1 |
| 7 | REC31-8036752 | 338-00042-0 | COJINETE DE AGUJA | NEEDLE BEARING | CUSCINETTO | ROULEMENT | 2 |
| 8 | REC53-16057 | 350-00024-1 | CLIP | CLIP | CLIP | CLIP | 2 |
| 9 | REC779-804886 | 3B2-00001-0 | PISTÓN STD | PISTON STD | PISTONE STD | PISTON STD | 2 |
| 10 | REC39-803678A3 | 3B2-00011-0 | KIT SEGMENTOS | PISTON RING KIT | KIT FASCIA | KIT DE SEGMENTS | 4 |

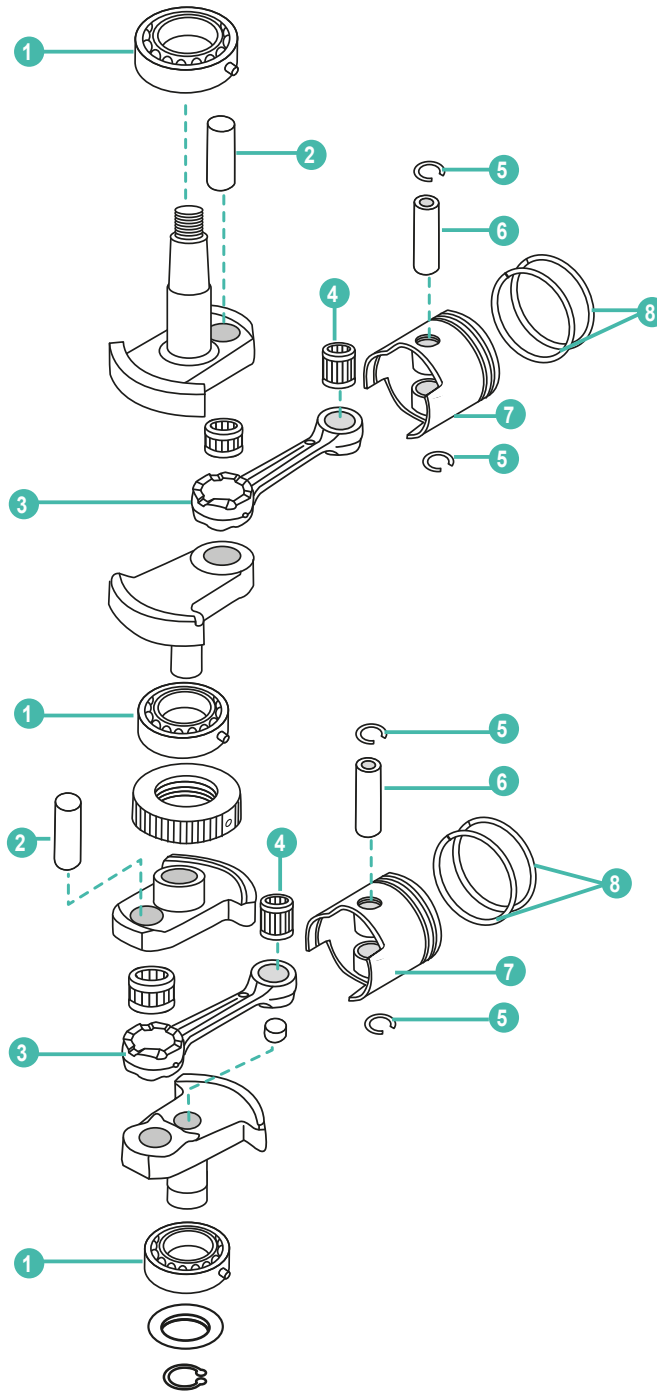

| | REF | OEM | | | | UN. | |
|---|------------------|--------------|---------------------------|-----------------------------|-------------------------|-----------------------------|---|
| 1 | REC30-160494 | 96603-3-6305 | RODAMIENTO | BALL BEARING | CUSCINETTO | ROULEMENT | 3 |
| 2 | REC803673 | 350-00061-0 | PIN | CRANK PIN | SPINOTTO | PIN | 2 |
| 3 | REC629-803674 | 350-00040-0 | BIELA | CONNECTING ROD | BIELLA | BIELLE | 2 |
| 4 | REC31-16052 | 350-00042-0 | COJINETE DE AGUJA | NEEDLE BEARING | CUSCINETTO | ROULEMENT | 2 |
| 5 | REC53-16057 | 350-00024-1 | CLIP | CLIP | CLIP | CLIP | 4 |
| 6 | REC41-803680002 | 350-00021-0 | PIN 18 HP | PISTON PIN 18 HP | SPINOTTO 18 HP | AXE DE PISTON 18 HP | 2 |
| | REC41-825713002 | 332-00021-0 | PIN 9.9 / 15 HP | PISTON PIN 9.9 / 15 HP | SPINOTTO 9.9 / 15 HP | AXE DE PISTON 9.9 / 15 HP | 2 |
| 7 | REC779-803677T02 | 351-00001-1 | PISTÓN STD, 9.9 / 15 HP | PISTON STD 9.9 / 15 HP | PISTONE STD 9.9 / 15 HP | PISTON STD 9.9 / 15 HP | 1 |
| | REC779-803677 | 350-00001-1 | PISTÓN STD 18 HPP | PISTON STD HP | PISTONE STD 18 HP | PISTON STD 18 HP | 1 |
| 8 | REC39-803678A1 | 350-00011-0 | KIT SEGMENTOS 18 HP | PISTON RING KIT 18 HP | KIT FASCIA 18 HP | KIT DE SEGMENTS 18 HP | 2 |
| | REC8M0080357 | 351-00011-0 | KIT SEGMENTOS 9.9 / 15 HP | PISTON RING KIT 9.9 / 15 HP | KIT FASCIA 9.9 / 15 HP | KIT DE SEGMENTS 9.9 / 15 HP | 2 |

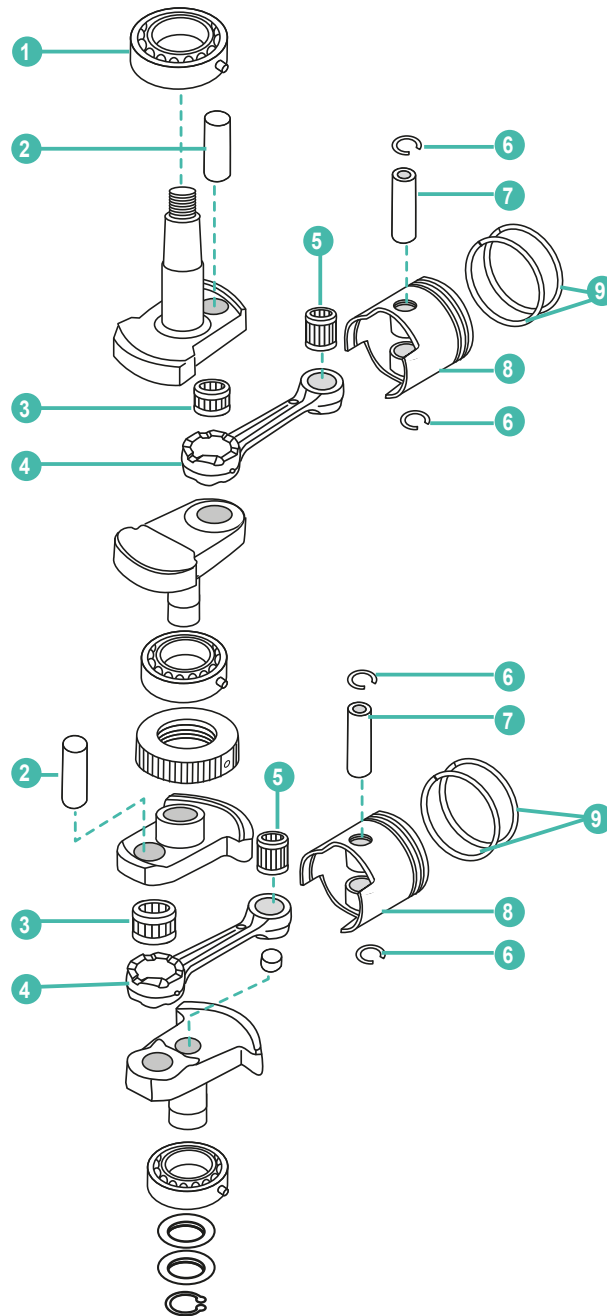

| | REF | OEM | | | | | UN. |
|---|------------------|-------------|-------------------|-----------------|-------------|-----------------|-----|
| 1 | REC30-16049T01 | 345-00113-0 | RODAMIENTO | BALL BEARING | CUSCINETTO | ROULEMENT | 1 |
| 2 | REC8130461 | 334-00061-0 | PIN | CRANK PIN | SPINOTTO | PIN | 2 |
| 3 | REC31-8130482 | 356-00043-0 | COJINETE DE AGUJA | NEEDLE BEARING | CUSCINETTO | ROULEMENT | 2 |
| 4 | REC629-813047T01 | 336-00040-1 | BIELA | CONNECTING ROD | BIELLA | BIELLE | 2 |
| 5 | REC345-00042-0 | 345-00042-0 | COJINETE DE AGUJA | NEEDLE BEARING | CUSCINETTO | ROULEMENT | 1 |
| 6 | REC53-16057 | 334-00024-1 | CLIP | CLIP | CLIP | CLIP | 4 |
| 7 | REC41-803680003 | 3C8-00021-0 | PIN | PISTON PIN | SPINOTTO | AXE DE PISTON | 2 |
| 8 | REC779-879194T01 | 346-00001-1 | PISTÓN STD | PISTON STD | PISTONE STD | PISTON STD | 2 |
| 9 | REC39-16054A5 | 346-00011-0 | KIT SEGMENTOS | PISTON RING KIT | KIT FASCIA | KIT DE SEGMENTS | 4 |

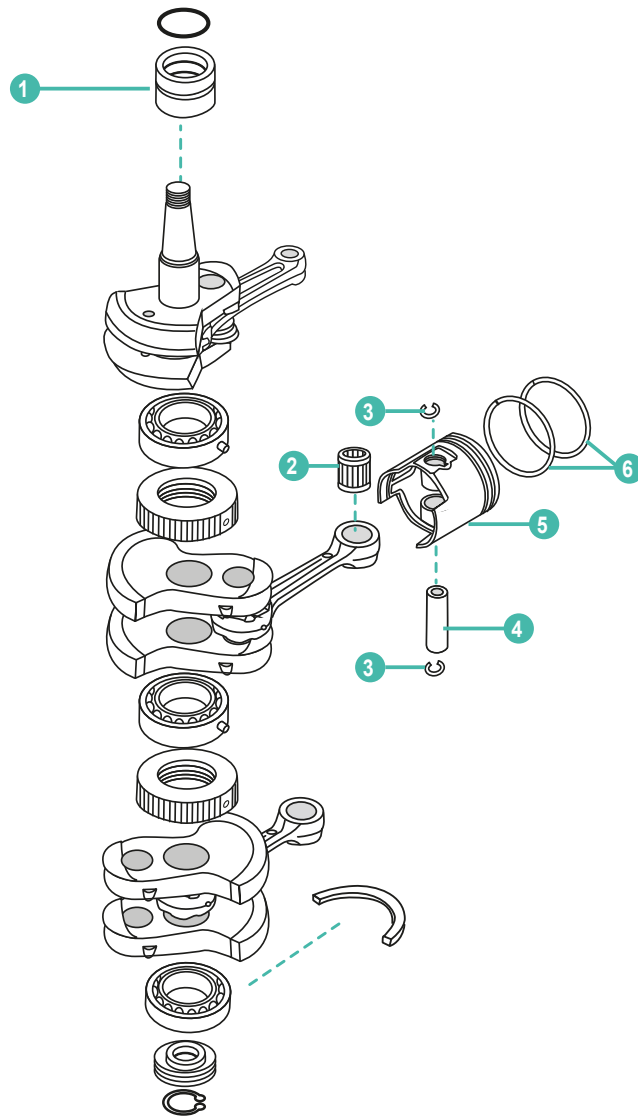

| | REF | OEM | | | | | UN. |
|---|----------------|-------------|-------------------|--------------------|----------------------|---------------------|-----|
| 1 | REC31-855553 | 3C8-00113-0 | RODAMIENTO SUP. | MAIN BEARING UPPER | CUSCINETTO SUPERIORE | ROULEMENT SUPERIEUR | 1 |
| 2 | REC345-00042-0 | 345-00042-0 | COJINETE DE AGUJA | NEEDLE BEARING | CUSCINETTO | ROULEMENT | 3 |
| 3 | REC53-16057 | 334-00024-1 | CLIP | CLIP | CLIP | CLIP | 6 |
| 4 | REC41-16056 | 3C8-00021-0 | PIN | PISTON PIN | SPINOTTO | AXE DE PISTON | 3 |
| 5 | REC779-9615T | 3C8-00001-3 | PISTÓN STD | PISTON STD | PISTONE STD | PISTON STD | 3 |
| 6 | REC8M0080349 | 346-00011-0 | KIT SEGMENTOS | PISTON RING KIT | KIT FASCIA | KIT DE SEGMENTS | 6 |

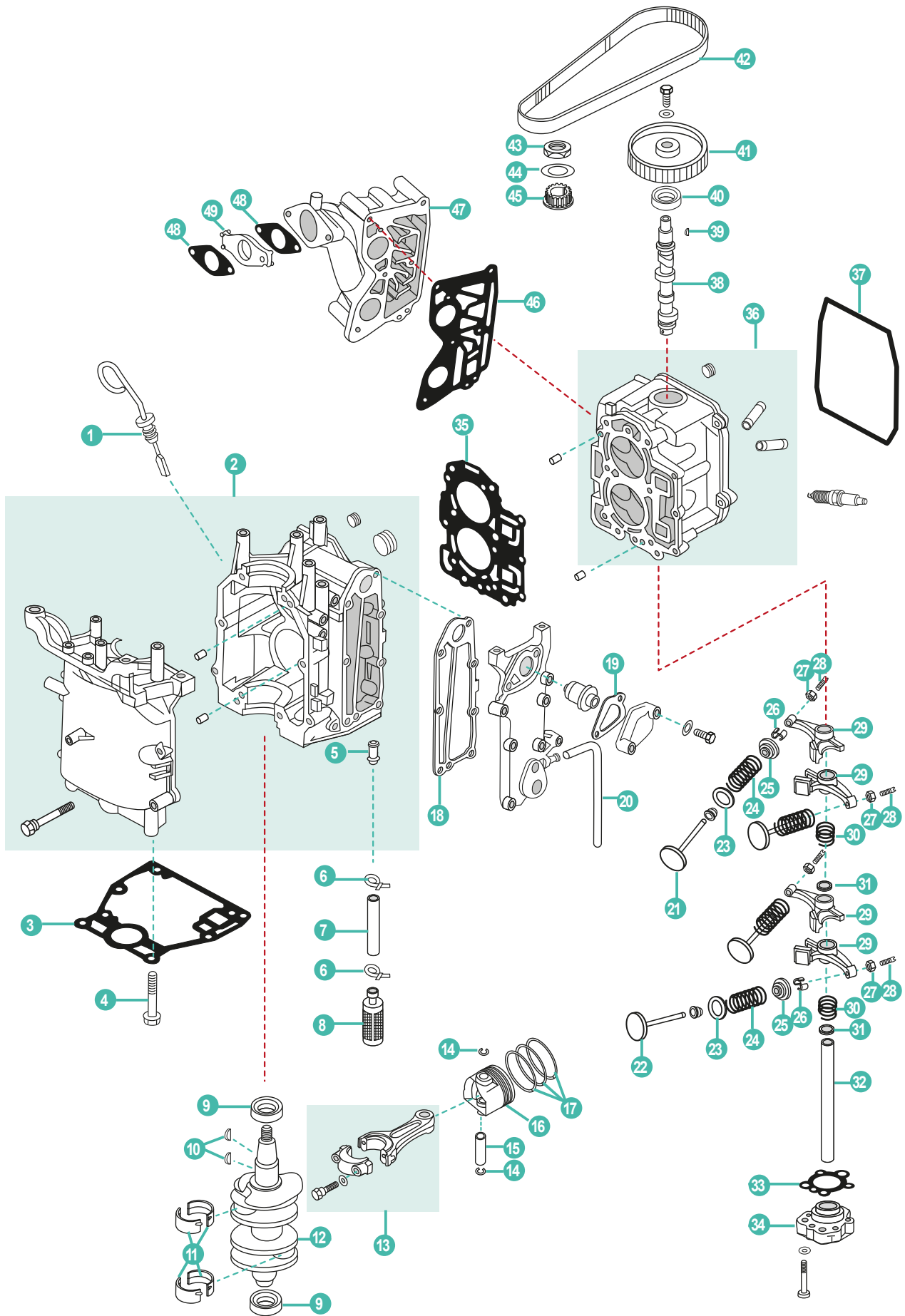

| | REF | OEM | | | | |
|----|-----------------|-------------|-----------------------|----------------------------|-------------------------------|--------------------------|
| 1 | PAF8-0000200 | 3V1-07421-0 | MEDIDOR NIVEL ACEITE | OIL LEVEL GAUGE | MISURATORE LIVELLO OLIO | JAUGE D'HUILE |
| 2 | PAF8-05010000 | 3V1B01100-0 | BLOQUE COMPLETO | CRANKCASSE ASSY | BLOCCO MOTORE | MOTEUR COMPLET |
| 3 | PAF8-00000004 | 3V1-01303-0 | JUNTA BASE MOTOR | GASKET, ENGINE BASEMENT | GUARNIZIONE BASE MOTORE | JOINT, BASE DE MOTEUR |
| 4 | PAF8-00000003 | 3R3-61017-0 | TORNILLO M8x35 | BOLT M8x35 | VITE M8x35 | VIS M8x35 |
| 5 | PAF8-05010002 | 3H8-02093-0 | RACORD | NIPPLE | RACCORDO | RACORD |
| 6 | PAF8-05000025 | 369-84398-0 | CLIP | HOOP | CLIP | CLIP |
| 7 | PAF8-05000017 | 98AH10-0120 | MANGUERA | HOSE | TUBO | DURITE |
| 8 | PAF8-05000800 | 3V1-07410-0 | FILTRO ACEITE | OIL STRAINER | FILTRO OLIO | FILTRE A HUILE |
| 9 | PAF8-05010012 | 3V1-00121-0 | RETÉN ACEITE | OIL SEAL | PARAOLIO | JOINT SPI |
| 10 | PAF4-04000019 | 3T5-10131-0 | CHAVETA | KEY | CHIAVETTA | CLAVETTE |
| 11 | PAF8-05010009 | 3V1-07407-0 | COJINETE | BUSH | BRONZINA | ROULEMENT |
| 12 | PAF8-05020001 | 3V1-00030-1 | CIGÜEÑAL | CRANK | ALBERO MOTORE | VILEBREQUIN |
| 13 | PAF8-05020200 | 3V1-00040-0 | BIELA | CONNENCTING ROD | BIELLA | BIELLE |
| 14 | PAF15-07020005 | 350-00024-1 | CLIP | CIRCLIP | CLIP | CLIP |
| 15 | PAF8-05020105 | 332-00021-0 | PIN | PIN, PISTON | SPINNOTO | AXE DE PISTON |
| 16 | PAF8-05020101 | 3V1-00001-0 | PISTON | PISTON | PISTONE | PISTON |
| 17 | REC39-8M0055809 | 3V1-00011-0 | KIT SEGMENTOS | PISTON RING KIT | KIT FASCIA | KIT DE SEGMENTS |
| 18 | PAF8-05010004 | 3V1-02305-0 | JUNTA ESCAPE | GASKET, EXHAUST COVER | GUARNIZIONE SCARICCO | JOINT D'ECHAPPEMENT |
| 19 | PAF8-05010005 | 346-01032-0 | JUNTA TERMOSTATO | GASKET, THERMOSTAT COVER | GUARNIZIONE TERMOSTATO | JOINT DE THERMOSTAT |
| 20 | PAF8-05000024 | 98AB-5-0330 | TUBO | WATER PIPE | TUBO | DURITE |
| 21 | PAF8-05030001 | 3V1-07201-0 | VÁLVULA ADMISIÓN | VALVE INTAKE | VALVOLA ASPIRAZIONE | SOUPAPE D'ADMISSION |
| 22 | PAF8-05030002 | 3V1-07202-0 | VÁLVULA ESCAPE | VALVE EXHAUST | VALVOLA SCARICO | SOUPAPE D'ECHAPPEMENT |
| 23 | PAF8-05030004 | 3V1-07205-0 | ASIENTO MUELLE | SEAL, VALVE SPRING | SIGILLO MOLLA | SIEGE RESSORT DE SOUPAPE |
| 24 | PAF8-05030005 | 3AA-07203-0 | MUELLE VÁLVULA | SPRING VALVE | VALVOLA MOLLA | RESSORT DE SOUPAPE |
| 25 | PAF8-05030006 | 3V1-07221-0 | RETEN RESORTE | RETAINER, VALVE SPRINGER | VALVOLA DI RITEGNO | JOINT DE RESSORT |
| 26 | PAF8-05030007 | 3H6-07223-0 | SEGURO DE VÁLVULA | CLAMP, VALVE | BLOCCAGGIO DI VALVOLA | CLAVETTE DE SOUPAPE |
| 27 | PAF15-07040304 | 3H8-07237-0 | TUERCA | LOCK NUT | GHIERA | ÉCROU |
| 28 | PAF15-07040303 | 3R0-07238-0 | TORNILLO AJUSTE | SCREW, VALVE ADJUSTING | VITE | VIS |
| 29 | PAF8-05030200 | 3V1-07235-0 | BALANCÍN | ROCKER | BILANCERE | CULBUTEUR |
| 30 | PAF8-05030009 | 3AA-07225-0 | MUELLE | SPRING ROCKER | MOLLA | RESSORT |
| 31 | PAF8-05030015 | 3R3-07227-0 | ARANDELA | BUSHER, ROCKER SPRING | RONDELLA | RONDELLE |
| 32 | PAF8-005030010 | 3H8-07226-0 | EJE | SHAFT ROCKER | ASSE | AXE DE CULBUTEUR |
| 33 | PAF8-05030012 | 3V1-07653-0 | JUNTA BOMBA ACEITE | OIL PUMP GASKET | GUARNIZIONE POMPA OLIO | JOINT POMPE |
| 34 | PAF8-05030300 | 3V1-07600-0 | BOMBA ACEITE | OIL PUMP | POMPA OLIO | POMPE À HUILE |
| 35 | PAF8-05000100 | 3V1-02305-0 | JUNTA CULATA | CYLINDER HEAD GASKET | GUARNIZIONE TESTATA | JOINT DE CULASSE |
| 36 | PAF8-05030100 | 3V1B01001-0 | CULATA | CYLINDER HEAD ASSY | TESTATA | CULASSE |
| 37 | PAF8-05000002 | 3V1-01024-0 | JUNTA TAPA CULATA | CYLINDER HEAD COVER GASKET | GUARNIZIONE COPERCHIO TESTATA | JOINT COUVERCLE |
| 38 | PAF8-05030008 | 3V1-07010-0 | ÁRBOL DE LEVAS | CRAMSHAFT | ALBERO MOTORE | ARBRE À CAMES |
| 39 | PAT3.6-04000006 | 309-00131-0 | CHAVETA | KEY | CHIAVETTA | CLAVETTE |
| 40 | PAF8-05030011 | 3H8-07025-0 | RETÉN ACEITE | OIL SEAL 18x35x7.8 mm | PARAOLIO | JOINT SPI |
| 41 | PAF8-05030400 | 3H8-10062-2 | POLEA | DRIVER PULLEY | PULEGGIA | POULIE |
| 42 | PAF8-05000004 | 3V1-10045-0 | CORREA | TIMING BELT | CINGHIA DI DISTRIBUZIONE | COURROIR DISTRIBUTION |
| 43 | PAF8-05010016 | 3V1-10068-0 | TUERCA | NUT | DADO | ÉCROU |
| 44 | PAF8-05010015 | 3V1-10063-0 | ARANDELA | BELT GUIDER | RONDELLA | RONDELLE |
| 45 | PAF8-05010014 | 3V1-10060-0 | POLEA | DRIVER PULLEY | PULEGGIA | POULIE |
| 46 | PAF8-05000009 | 3V1-02104-0 | JUNTA COLECTOR | GASKET MANIFOLD | GUARNIZIONE COLLETTORE | JOINT DE COLLECTEUR |
| 47 | PAF8-05000008 | 3V1-02010-1 | COLECTOR ADMISIÓN | INTAKE MANIFOLD | COLLETTORE ASPIRAZIONE | COLLECTEUR D'ADMISSION |
| 48 | PAF15-07000017 | 3V1-02011-0 | JUNTA CARBURADOR | GASKET CARBURETOR | GUARNIZIONE CARBURATORE | JOINT CARBURATEUR |
| 49 | PAF15-07000018 | 3V1-03952-0 | SEPARADOR, CARBURADOR | INSULATOR, CARBURETOR | ISOLANTE, CARBURATORE | ISOLANT CARBURATEUR |

4T MFS8 • MFS9.9
STROKES

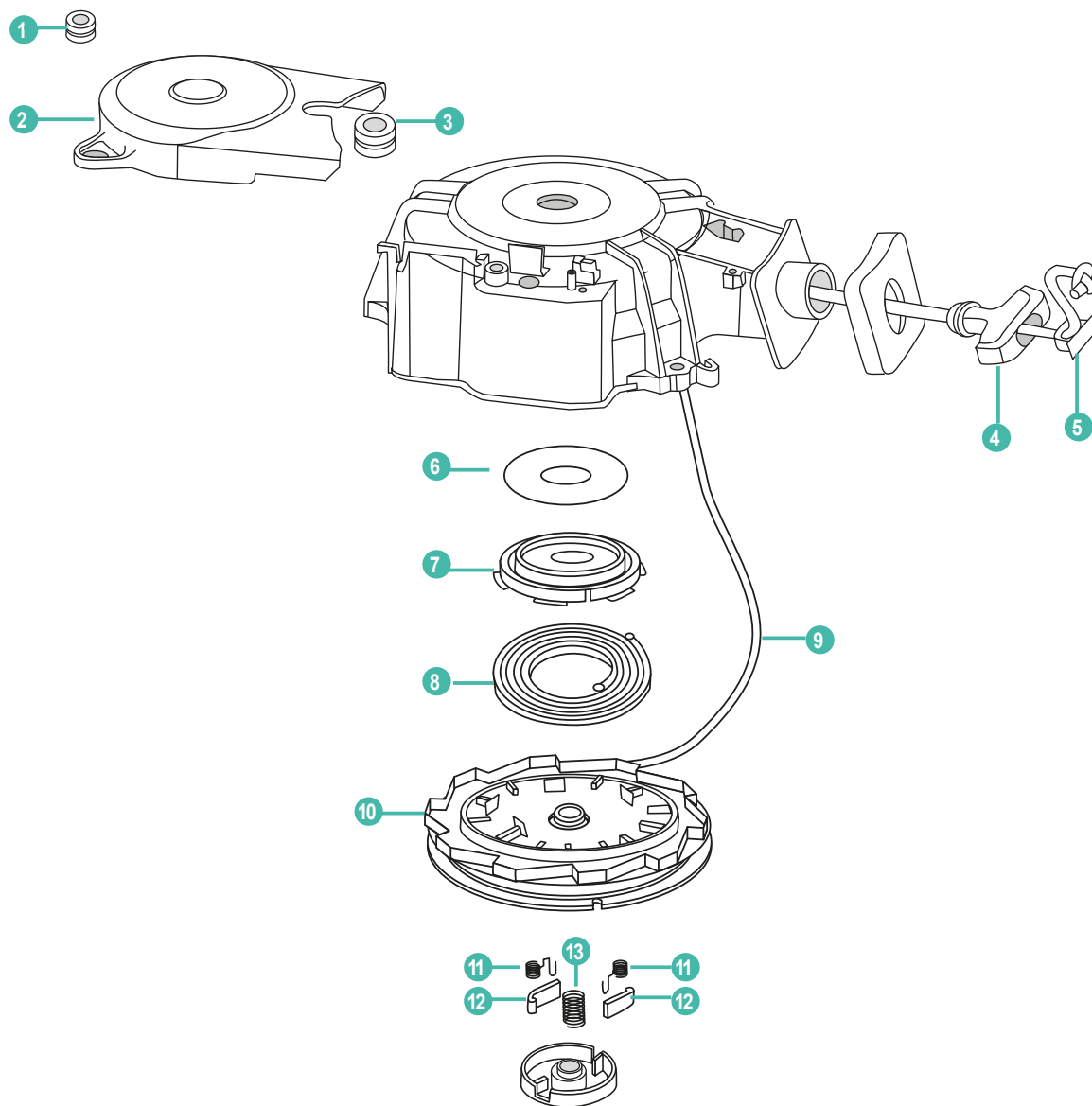

| | REF | OEM | | | |
|----|---------------|-------------|--------------|------------------|---------------------|
| 1 | PAF8-05000003 | 172-36008-0 | RETÉN | RUBBER GROMMET A | TENUTA |
| 2 | PAF8-05000012 | 3V1-06308-0 | TAPA | COVER, STRAP | COPERCHIO |
| 3 | PAF8-05000013 | 3V1-06302-0 | RETÉN | RUBBER GROMMET B | TENUTA |
| 4 | PAF4-04130101 | 3AA-05019-0 | TIRADOR | HANDLE, STARTER | MANIGLIA AVVIAMENTO |
| 5 | PAF4-04130102 | 3R1-05131-0 | TAPA | COVER, HANDLE | COPERCHIO |
| 6 | PAF8-05050002 | 3V1-05259-0 | ARANDELA | WASHER, THRUST | RONDELLA |
| 7 | PAF8-05050003 | 3R1-05125-0 | MUELLE | SPRING CASE | MOLLA |
| 8 | PAF8-05050004 | 3AA-05004-0 | MUELLE | VOLUTE SPRING | MOLLA |
| 9 | PAF8-05050018 | 3AA-05013-0 | CUERDA | START LINE | CORDA DI AVVIAMENTO |
| 10 | PAF8-05050005 | 3V1-05104-1 | VOLANTE | WHELL, START-UP | VOLANTE |
| 11 | PAF8-05050007 | 3R1-05012-0 | MUELLE | SPRING, TENSIÓN | MOLLA |
| 12 | PAF8-05050006 | 3R1-05003-1 | UÑA PLÁSTICA | PAWL, DRIVE | NOTTOLINO |
| 13 | PAF8-05050009 | 3R1-05007-0 | MUELLE | SPRING PLATE | MOLLA |
| | | | | | JOINT |
| | | | | | COUVERCLE |
| | | | | | JOINT |
| | | | | | POIGNEE DE LANCEUR |
| | | | | | COUVERCLE |
| | | | | | RONDELLE |
| | | | | | RESSORT |
| | | | | | RESSORT |
| | | | | | CORDA DE LANCEUR |
| | | | | | VOLANT |
| | | | | | RESSORT |
| | | | | | RESSORT |
| | | | | | CLIQUET |
| | | | | | RESSORT |

**JUNTAS DE MOTOR
4 TIEMPOS**

**ENGINE GASKET
4 STROKES**

**GUARNIZIONI
MOTORE 4 TEMPI**

**JOINTS DE MOTEUR
4 TEMPS**

JUNTAS DE CULATA

CYLINDER HEAD GASKET

GUARNIZIONE DE TESTATA

JOINT DE CULASSE

| REF | OEM |
|----------------|-------------|
| REC309-01005-2 | 309-01005-2 |

 M2.5
 M2.5A
 M2.5A2
 M3.5A
 M3.5A2



| REF | OEM |
|----------------|-------------|
| REC346-01005-0 | 346-01005-0 |

 M25C3
 M30A4

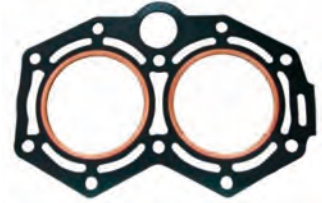

| REF | OEM |
|----------------|-------------|
| REC3B2-01005-0 | 3B2-01005-0 |

 M6B
 M8B
 M9.8B



| REF | OEM |
|----------------|-------------|
| REC3C8-01005-4 | 3C8-01005-4 |

 M40D2
 M50D2



| REF | OEM |
|----------------|-------------|
| REC351-01005-0 | 351-01005-0 |

 M9.9D
 M15D
 M9.9D2
 M15D2



| REF | OEM |
|----------------|-------------|
| REC3F3-01005-0 | 3F3-01005-0 |

 M60C
 M70C



| REF | OEM |
|----------------|-------------|
| REC350-01005-0 | 350-01005-0 |

 M18E2



| REF | OEM |
|----------------|-------------|
| REC3T9-01005-0 | 3T9-01005-0 |

 MD70
 MD90

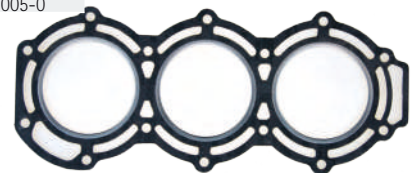

**KITS
JUNTAS DE CULATA**

**CYLINDER HEAD GASKET
KIT**

**KIT
GUARNIZIONE TESTATA**

**KITS
JOINTS MOTEUR**

| REF | OEM |
|----------------|-------------|
| REC3T5-87121-6 | 3T5-87121-6 |

 MD40B2
 MD50B2

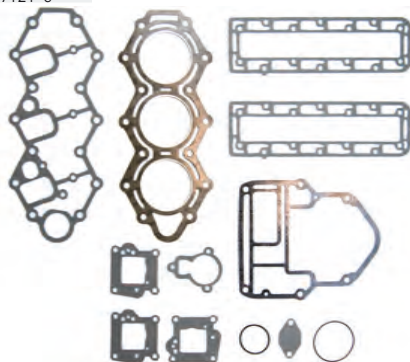

| REF | OEM |
|----------------|-------------|
| REC3B7-87121-1 | 3B7-87121-7 |

 M80A
 M90A

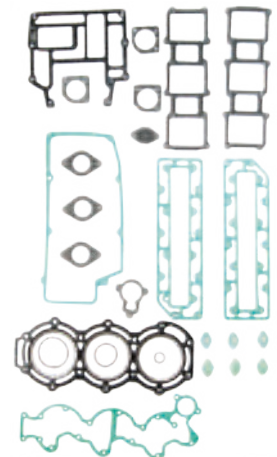

JUNTAS DE CULATÍN

GASKET, HEAD COVER

**GUARNIZIONE COPERCHIO
TESTA**

**JOINTS DE COUVRE
CULASSE**

| REF | OEM |
|----------------|-------------|
| REC3C8-01024-0 | 3C8-01024-0 |

 M40D2
 M50D2

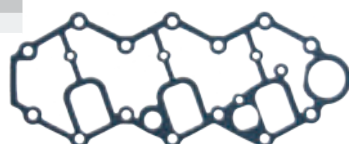

| REF | OEM |
|----------------|-------------|
| REC3F3-01024-0 | 3F3-01024-0 |

 M60C
 M70C



JUNTAS BASE DE MOTOR

CYLINDER GASKET

**GUARNIZIONE
BASE MOTORE**

JOINTS DE TÊTE MOTRICE

| REF | OEM |
|----------------|-------------|
| REC350-01303-0 | 350-01303-0 |

- M9.9D2
- M15D2
- M18E2

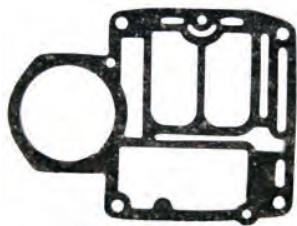

| REF | OEM |
|----------------|-------------|
| REC3C8-01303-4 | 3C8-01303-4 |

- MD40B
- MD50B

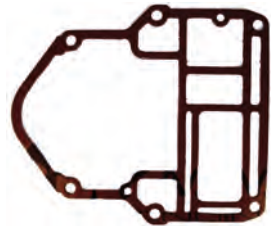

| REF | OEM |
|----------------|-------------|
| REC350-61012-1 | 350-61012-1 |

- M9.9D2
- M15D2
- M18E2

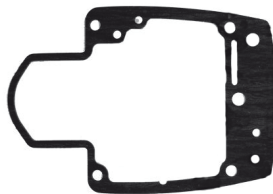

| REF | OEM |
|----------------|-------------|
| REC3F3-01303-1 | 3F3-01303-1 |

- M60C
- M70C



| REF | OEM |
|----------------|-------------|
| REC346-01303-0 | 350-01303-0 |

- M25C3
- M30A4

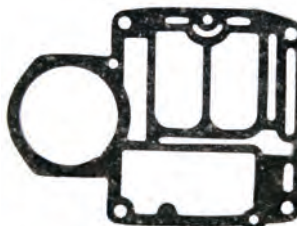

| REF | OEM |
|----------------|-------------|
| REC3B2-01303-0 | 3B2-01303-0 |

- M6B
- M8B
- M9.8B

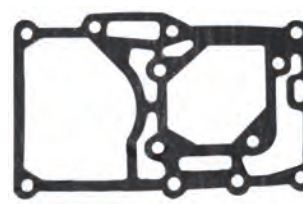

RETENES DE ACEITE OIL SEALS

PARAOLIO

JOINT SPI

RETÉN DE ACEITE

OIL SEAL

PARAOLIO

JOINT SPI

| REF | OEM | 18 x 28 x 6 mm |
|---------------|-------------|----------------|
| REC26-8537072 | 346-01215-0 | 18 x 28 x 6 mm |

- M25C3
- M30A4
- MFS25A-B
- MFS30A-B
- MFS40A
- MFS50A



| REF | OEM | 18 x 28 x 8 mm |
|--------------|-------------|----------------|
| REC26-161301 | 346-60111-0 | 18 x 28 x 8 mm |

- M25C3
- M30A4
- MFS30A - B
- MFS25A - B



| REF | OEM | 17 x 30 x 9 mm |
|--------------|-------------|----------------|
| REC26-161622 | 346-65013-0 | 17 x 30 x 9 mm |

- M15D2
- M18E2
- M25C3
- M30A4
- M9.9D2
- MFS20C
- MFS18B2
- MFS15C-B2
- MFS30B-A
- MFS25A-B
- MFS20C
- MFS9.9B2-C



| REF | OEM | 25 x 45 x 8 mm |
|--------------|-------------|----------------|
| REC26-803667 | 350-00121-0 | 25 x 45 x 8 mm |

- M9.9D2
- M15D2
- M18E2



| REF | OEM | 25 x 69 x 9,5 mm |
|--------------|-------------|------------------|
| REC8M0065585 | 350-01215-5 | 25 x 69 x 9,5 mm |

- M9.9D2
- M15D2
- M18E2



| REF | OEM | 10 x 62 x 7 mm |
|-------------|-------------|----------------|
| REC26-16703 | 369-01215-0 | 10 x 62 x 7 mm |

- M4C
- M5B
- M5BS
- MFS4A-B / 5A-B-C / 6A-B-C



| REF | OEM | 10 x 24 x 8 mm |
|-------------|-------------|----------------|
| REC26-16162 | 369-60223-0 | 10 x 24 x 8 mm |

- M4C
- M5B
- M5BS
- MFS4A-B / 5A-B-C / 6A-B-C



CIGÜEÑAL

CRANKSHAFT

ALBERO MOTORE

VILEBREQUIN

RODAMIENTOS DE CIGÜEÑAL

CRANKSHAFT BEARINGS

CUSCINETTI ALBERO MOTORE ROULEMENTS VILEBREQUIN

SUPERIOR | UPPER | SUPERIORE | SUPERIEUR

| REF | OEM |
|-----------------|-------------|
| REC30-898101936 | 9643-3-6004 |

M2.5A
M3.5A-B



INFERIOR | UNDER | INFERIORE | INFERIEUR

| REF | OEM |
|-------------|-------------|
| REC30-95307 | 9643-3-6202 |

M2.5A
M3.5A-B



PISTONES

PISTONS

PISTONI

PISTONS

KITS DE PISTONES

PISTON KITS

KIT PISTONE

KIT PISTON

| | STD | OEM |
|-----------------|-------------|-----|
| REF | | |
| REC779-803677 | 350-00001-0 | |
| REC8M0080357 | 351-00011-0 | |
| REC629-803674 | 350-00040-0 | |
| REC41-825713002 | 332-00021-0 | |
| REC53-16057 | 350-00024-1 | |
| REC31-16052 | 350-00042-0 | |

M9.9D2
M15D2 (2 Cyl)



| | STD | OEM |
|--------------|-------------|-----|
| REF | | |
| REC779-9615T | 369-00001-0 | |
| REC8M0080357 | 351-00011-0 | |
| REC41-16056 | 369-00021-0 | |
| REC53-16057 | 350-00024-1 | |
| REC31-16052 | 350-00042-0 | |

M4C
M5B
M5BS (1 Cyl)



| | STD | OEM |
|------------------|-------------|-----|
| REF | | |
| REC779-803677T02 | 351-00001-1 | |
| REC629-803674 | 350-00040-0 | |
| REC41-803680002 | 350-00021-0 | |
| REC53-16057 | 350-00024-1 | |
| REC31-16052 | 350-00042-0 | |

M18E2 (2 Cyl)



| | STD | OEM |
|----------------|-------------|-----|
| REF | | |
| REC779-804886 | 3B2-00001-0 | |
| REC39-803678A3 | 3B2-00011-0 | |
| REC629-8036741 | 3B2-00040-0 | |
| REC41-8036801 | 3B2-00021-0 | |
| REC53-16057 | 350-00024-1 | |
| REC31-8036752 | 338-00042-0 | |

M6B
M8B
M9.8B (2 Cyl)



| | STD | |
|---|------------------|-------------|
| | REF | OEM |
|  | REC779-879194T01 | 346-00001-1 |
|  | REC39-16054A5 | 346-00011-0 |
|  | REC629-813047T01 | 336-00040-1 |
|  | REC41-803680003 | 3C8-00021-0 |
|  | REC53-16057 | 350-00024-1 |
|  | REC345-00042-0 | 345-00042-0 |

 M25C3
M30A4 (2 Cyl)



| | STD | |
|---|-----------------|----------------------------|
| | REF | OEM |
|  | REC779-96152 | 3C8-00001-3 |
|  | REC8M0080349 | 356-00011-0 346-00011-0 |
|  | REC629-8036741 | 3B2-00040-0 |
|  | REC41-803680003 | 3C8-00021-0 |
|  | REC53-16057 | 334-00024-1 |
|  | REC345-00042-0 | 345-00042-0 |

 M40D2
M50D2 (3 Cyl)



| | STD | |
|---|----------------|-------------|
| | REF | OEM |
|  | PAF8-05020101 | 3V1-00001-0 |
|  | PAF8-05020200 | 3V1-00040-0 |
|  | PAF8-05020105 | 332-00024-0 |
|  | PAF15-07020005 | 350-00024-1 |

 MFS8
MFS9.8A-A2-A3 (2 Cyl)



 P
51

REF
CRA904633
CRA946331



REF
SSP4213

 P
51



SISTEMA DE ESCAPE Y ADMISIÓN EXHAUST & INTAKE SYSTEM

SISTEMA DI SCARICO E ASPIRAZIONE SYSTÈME D'ÉCHAPPEMENT ET D'ADMISSION

| SISTEMA DE ESCAPE | EXHAUST SYSTEM | SISTEMA SCARICO | SYSTÈME D'ÉCHAPPEMENT |
|-------------------|----------------|-----------------|-----------------------|
|-------------------|----------------|-----------------|-----------------------|

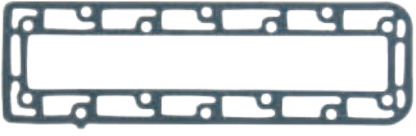

| JUNTAS DE ESCAPE | GASKET, EXHAUST | GUARNIZIONE SCARICO | JOINTS D'ÉCHAPPEMENT |
|------------------|-----------------|---------------------|----------------------|
|------------------|-----------------|---------------------|----------------------|

| <table border="1"> <tr> <th>REF</th> <th>OEM</th> </tr> <tr> <td>REC3C8-02305-0</td> <td>3C8-02305-0</td> </tr> </table> <p>M40D2 / B M50D2 / B</p> | REF | OEM | REC3C8-02305-0 | 3C8-02305-0 |  |
|---|-------------|-----|----------------|-------------|---|
| REF | OEM | | | | |
| REC3C8-02305-0 | 3C8-02305-0 | | | | |

| SISTEMA DE ADMISIÓN | INTAKE SYSTEM | SISTEMA ASPIRAZIONE | SYSTÈME D'ADMISSION |
|---------------------|---------------|---------------------|---------------------|
|---------------------|---------------|---------------------|---------------------|

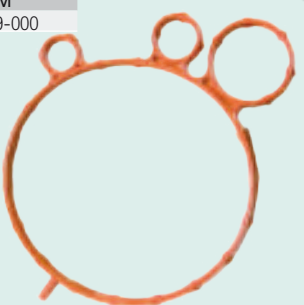
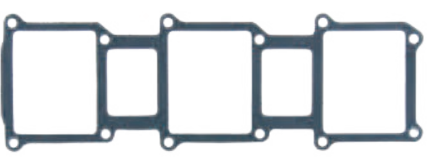
| JUNTAS DE ADMISIÓN | GASKET, INTAKE | GUARNIZIONE ASPIRAZIONE | JOINTS D'ADMISSION |
|--------------------|----------------|-------------------------|--------------------|
|--------------------|----------------|-------------------------|--------------------|

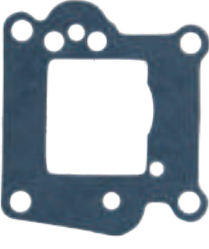
| <table border="1"> <tr> <th>REF</th> <th>OEM</th> </tr> <tr> <td>REC17109-ZY6-000</td> <td>HZY6-17109-000</td> </tr> </table> <p>BFT90AK1 BFT75AK1 BFT115A BFT150A</p> | REF | OEM | REC17109-ZY6-000 | HZY6-17109-000 |  | <table border="1"> <tr> <th>REF</th> <th>OEM</th> </tr> <tr> <td>REC3T9-02104-0</td> <td>3T9-02104-0</td> </tr> </table> <p>MD70B MD90B</p> | REF | OEM | REC3T9-02104-0 | 3T9-02104-0 |  |
|--|----------------|-----|------------------|----------------|---|---|-----|-----|----------------|-------------|---|
| REF | OEM | | | | | | | | | | |
| REC17109-ZY6-000 | HZY6-17109-000 | | | | | | | | | | |
| REF | OEM | | | | | | | | | | |
| REC3T9-02104-0 | 3T9-02104-0 | | | | | | | | | | |

| <table border="1"> <tr> <th>REF</th> <th>OEM</th> </tr> <tr> <td>REC3C8-02104-0</td> <td>3C8-02104-0</td> </tr> </table> <p>M40D2 M50D2</p> | REF | OEM | REC3C8-02104-0 | 3C8-02104-0 |  | <table border="1"> <tr> <th>REF</th> <th>OEM</th> </tr> <tr> <td>REC3F3-02104-0</td> <td>3F3-02104-0</td> </tr> </table> <p>M60C M70C</p> | REF | OEM | REC3F3-02104-0 | 3F3-02104-0 |  |
|---|-------------|-----|----------------|-------------|---|---|-----|-----|----------------|-------------|---|
| REF | OEM | | | | | | | | | | |
| REC3C8-02104-0 | 3C8-02104-0 | | | | | | | | | | |
| REF | OEM | | | | | | | | | | |
| REC3F3-02104-0 | 3F3-02104-0 | | | | | | | | | | |

TOHATSU

RECAMBIOS MARINOS

UNIDADES DE TRANSMISIÓN UNIT DRIVES & COMPONENTS

UNITÀ DI TRASMISSIONE EMBASES ET PIÈCES

DESPIECE COLAS

GEAR CASE PARTS

PARTI PIEDI

PIÈCES D'EMBASES

4T MFS8 • MFS9.8
STROKES

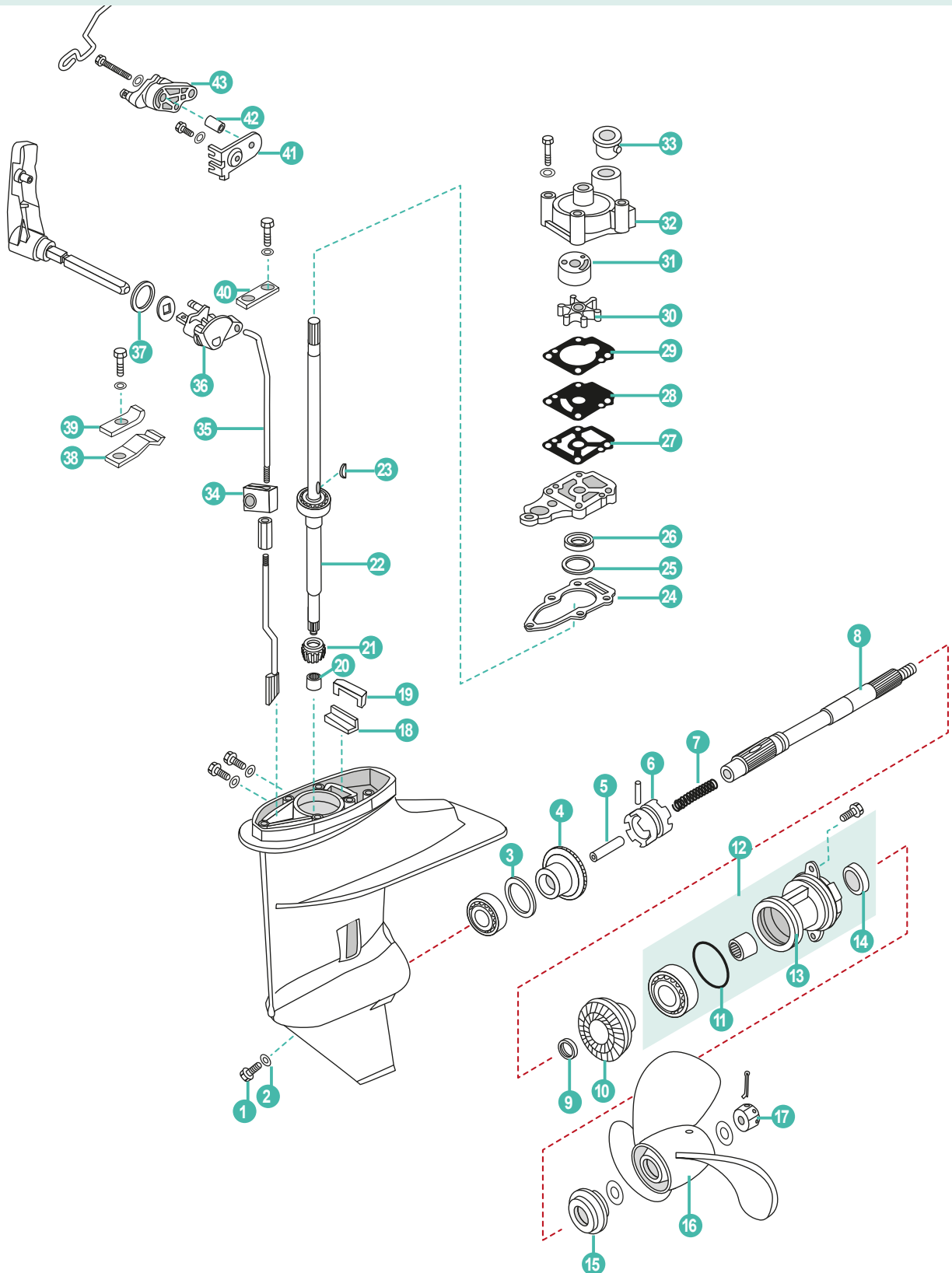

TOHATSU

RECAMBIOS
MARINOS

| | REF | OEM | | | | |
|----|-----------------|-------------|--------------------|-----------------------------|-------------------------|---|
| 1 | REC90340-08002 | 332-60005-2 | TAPÓN DRENAJE | PLUG, OIL HOSE | CONNETTORE | BOUCHON DE VIDANGE |
| 2 | REC90430-08020 | 332-60006-0 | JUNTA | GASKET | GUARNIZIONE | JOINT |
| 3 | PAF8-04000012-1 | 369-64014-0 | GRUESO 0.10mm | SHIM 0.10mm | SPESSORE 0.10mm | CALE 0.10 mm |
| | PAF8-04000012-2 | 369-64015-0 | GRUESO 0.15mm | SHIM 0.15mm | SPESSORE 0.15mm | CALE 0.15mm |
| 4 | PAF8-04010000 | 3B2-64010-0 | PIÑÓN ADELANTE | GEARM FORWARD | PIGNONE AVANTI | PIGNON DE MARCHE AVANT |
| 5 | PAF8-04000305 | 369-64223-0 | PIN | PIN CLUTCH | SPINOTTO | PIN |
| 6 | PAF8-04000303 | 3B2-64215-0 | SELECTOR | CLUTCH, DOG | SELETTORE | CRABOT |
| 7 | PAF8-04000302 | 3V1-64221-0 | MUELLE | SPRING, CLUTCH | MOLLA | RESSORT |
| 8 | PAF8-04000301 | 3V1-64211-0 | EJE HÉLICE | SHAFT, PROPELLER | ASSE ELICHE | ARBRE D'HELICE |
| 9 | PAF8-04000012 | 369-64032-0 | ARANDELA | WASHER | RONDELLA | RONDELLE |
| 10 | PAF8-04000014 | 3B2-64030-0 | PIÑÓN ATRÁS | GEAR REVERSE | PIGNONE MARCIA INDIETRO | PIGNON DE MARCHE ARRIÈRE |
| 11 | PAF8-04040002 | 345-65015-0 | TÓRICA | O-RING | ANELLO | JOINT TORIQUE |
| 12 | PAF8-04040000 | 3B2S60100-0 | DIÁBOLO | COVER ASSY | DIABOLO | DIABOLO COMPLET |
| 13 | PAF8-04040001 | 3B2S60101-0 | DIÁBOLO | COVER, LOWE CASING | DIABOLO | DIABOLO |
| 14 | PAF8-04040004 | 369-60111-0 | RETÉN | OIL SEAL | PARAOLIO | JOINT SPI |
| 15 | PAF8-04000019 | 3B2-64230-1 | GRUESO | CUSHION, PROPELLER | SPESSORE | CALE |
| 16 | PAF8-04050000 | 3B2W64517-0 | HÉLICE | PROPELLER ASSY | ELICHE | HELICE |
| 17 | PAF15-06000016 | 369-64121-0 | TUERCA | NUT, HEXAGON | DADO | ÉCROU |
| 18 | PAF8-04000015 | 3V1-60042-0 | GUÍA SELLO DE GOMA | GUIDE RUBBER SEAL | GUIDA PARAOLIO | GUIDE EN CAOUTCHOUC |
| 19 | PAF8-04000016 | 3V1-60041-0 | SELLO DE GOMA | WATER ENVELOP | PARAOLIO | SUPPORT EN CAOUTCHOUC |
| 20 | PANSKFJ-1516 | 3V1-60211-0 | RODAMIENTO | BEARING | CUSCINETTO | ROULEMENT |
| 21 | PAF8-04000003 | 3B2-64020-0 | PIÑÓN DE ATAQUE | INITIATIVE GEAR | PIGNONE ATTACCO | PIGNON D'ATTAQUE |
| 22 | PAF8-04020001L | 3V1-64307-1 | EJE VERTICAL L | DRIVE SHAFT L | ASSE VERTICALE L | ARBRE DE COMMANDE L |
| | PAF8-04020001S | 3V1-64306-1 | EJE VERTICAL S | DRIVE SHAFT S | ASSE VERTICALE S | ARBRE DE COMMANDE S |
| 23 | PAF8-04000021 | 3B2-65022-0 | PIN | PIN, DOWER | SPINOTTO | PIN |
| 24 | PAF8-04000005 | 3B2-65020-0 | JUNTA | GASKET, WATER PUMP SEAT | GUARNIZIONE | JOINT |
| 25 | PAF8-04000004-1 | 3B2-64023-0 | GRUESO 0.10 mm | SHIM 0.10mm | SPESSORE 0.10 mm | CALE 0.10 mm |
| 26 | PAF8-04000101 | 309-60111-0 | RETÉN | OIL SEAL | PARAOLIO | JOINT SPI |
| 27 | PAF8-04000006 | 3B2-65029-0 | JUNTA | GASKET, OUTER PLATE | GUARNIZIONE | JOINT |
| 28 | PAF8-04000007 | 3B2-65025-0 | PLACA | OUTER PLATE | PIASTRA | PLAQUE |
| 29 | PAF8-04000008 | 3B2-65018-0 | JUNTA | GASKET, OUTER PLATE | GUARNIZIONE | JOINT |
| 30 | PAF8-04000200 | 3B2-65021-1 | IMPULSOR | IMPELLER | GIRANTE | TURBINE |
| 31 | PAF8-04000010 | 3B2-65011-0 | CASQUILLO | INNER SHELL, WATER PUMP | BOCCOLA | COUVERCLE, POMPA À EAU |
| 32 | PAF8-04000009 | 3B2-65016-0 | BOMBA DE AGUA | WATER PUMP | POMPA D'ACQUA | POMPA À EAU |
| 33 | PAF8-04000013 | 3B2-65016-0 | RETÉN | SEAL | TENUTA | JOINT DE TUBE D'EAU |
| 34 | PAF8-03000011 | 3V1-66302-0 | SEGURO | LOCK BLOCK | BLOCCAGGIO | SUPPORT TIGE DE CHANGEMENT DE VITESSE |
| 35 | PAF8-03000010 | 3V1-66211-0 | EJE DEL CAMBIO | SHIFT ROD | ASSE CAMBIO | TIGE CHANGEMENT DE VITESSE |
| 36 | PAF8-03010003 | 3V1-66225-0 | SEGURO DEL EJE | BLOCK SHIFT ROD | BLOCCAGGIO ASSE | TIGE DE BLOCAGE |
| 37 | PAF8-03010001 | 3V1-66187-0 | ARANDELA | WASHER, HANDLE | RONDELLA | RONDELLE |
| 38 | PAF8-03010005 | 3B2-66113-0 | TOPE | STOPPER, SHIFT LEVER | TAPPO | LEVIER |
| 39 | PAF8-03010006 | 3C8-66116-0 | PLACA | PLATE, SHIFTLIVER STOPPER | PIASTRA | CONTRE PLAQUE LEVIER CAHNGEMENT VITESSE |
| 40 | PAF8-03010007 | 3B1-66145-0 | PLACA | PLATE | PIASTRA | PLAQUE |
| 41 | PAF8-05000020 | 3V1-63508-0 | PLACA | PALTE | PIASTRA | PLAQUE |
| 42 | PAF8-05000018 | 346-67114-0 | CASQUILLO | PLATE ACCELEROGRAPH ENFOPCE | BOCCOLA | PLAQUE SUPPORT LEVIER PRINCIPAL |
| 43 | PAF8-05000019 | 3V1-63622-0 | POLEA | MAIN PULLEY | PULEGGIA | POULIE |

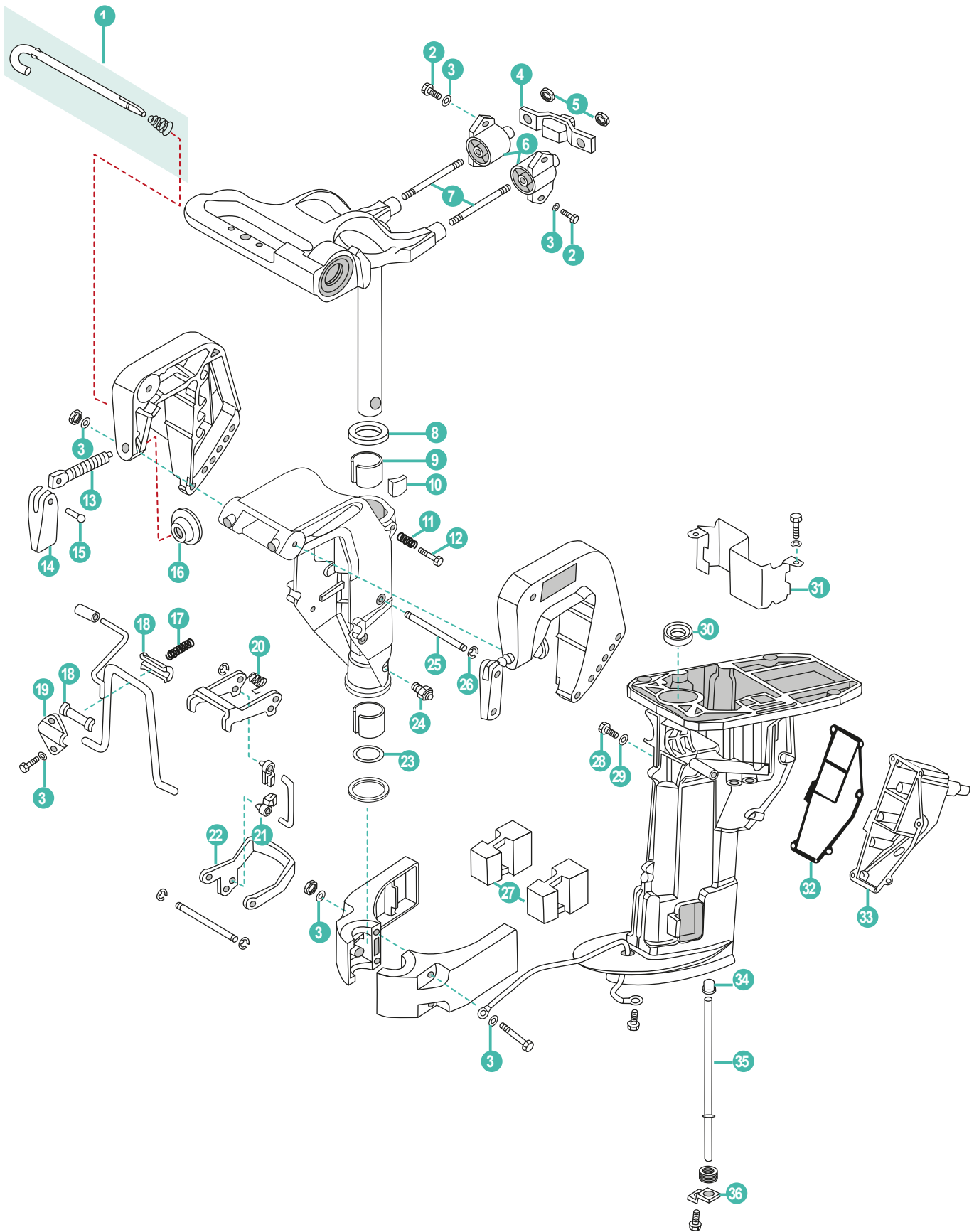

| | REF | OEM | | | | |
|----|------------------|----------------------------|----------------------|-----------------------------|-------------------------------|--------------------------------------|
| 1 | PAF8-01010200 | 350-62121-1 369-62122-2 | GANCHO DE CIERRE | THRUST ROD ASSY | ASSE DE CHIUSSURA | CROCHET DE FERMETURE |
| 2 | PAGB/T5783-M6X20 | 910184-5620 | TORNILLO | BOLT M6x20 | VITE | VIS |
| 3 | PAGB/T97.1-6 | 910184-5620 | ARANDELA | WASHER | RONDELLA | RANDELLE |
| 4 | PAF8-00000100 | 3V1-61333-1 | SILENBLOCK | ABSORBER (FRONT) | SILENBLOCK | SILENBLOCK |
| 5 | PAGB/T889.1-M8 | 3V1-61324-0 | TUERCA M8 | NUT M8 | DADO M8 | ÉCROU M8 |
| 6 | PAF8-02000100 | 3V1-61301-1 940113-0800 | SILENBLOCK | ABSORBER ASSY | SILENBLOCK | SILENBLOCK |
| 7 | PAF8-01000003 | 3V1-61313-0 | TORNILLO M8x65 | DICEPHALOUS BOLT M8x65 | VITE M8x65 | VIS M8x65 |
| 8 | PAF8-01000001 | 350-62423-0 | ARANDELA | WASHER, ROTARY BRACKET | RONDELLA | RONDELLE |
| 9 | PAF8-01000002 | 350-62417-0 | CASQUILLO | BUSHING | BOCCOLA | ENTRETOISE |
| 10 | PAF8-01000100 | 345-62441-0 | SEGURO DE CIERRE | LOCKING BLOCK ASSY | CHIUSURA SICUREZA | BLOC DE VERROUILLAGE |
| 11 | PAF8-01010102 | 346-62421-1 | MUELLE | SPRING, LOCKING | MOLLA | RESSORT |
| 12 | PAGB/T5783-M8X30 | 910113-0830 | TORNILLO M8X30 | BOLT M8x30 | VITE M8X30 | VIS M8X30 |
| 13 | PAF4-01010002 | 398-62103-0 | TORNILLO | CLAMP SCREW | VITE | VIS |
| 14 | REC6L8-G3118-01 | 332S62102-1 | MANETA | CLAMP HANDLE, STERN | MANIGLIA | POIGNEE DE BLOCAGE |
| 15 | PAF4-01010005 | 3C8-62104-1 | RIBETE | RIVET, CLAMP HANDLE | RIVETTO | RIVET |
| 16 | PAF4-01010003 | 332-62101-0 | ARANDELA | CLAMP PAD | RONDELLA | RONDELLE |
| 17 | PAF8-01010104 | 369-66112-1 | MUELLE | SPRING, SUPPORT | MOLLA | RESSORT |
| 18 | PAF8-01010103 | 393-62437-0 | PASADOR | PIN | PIN | PIN |
| 19 | PAF8-01010105 | 369-62439-1 | PLACA | PRESS PLATE | PIASTRA | PLAQUE |
| 20 | PAF8-01010109 | 3B2-66315-0 | MUELLE | SPRING, WREST | MOLLA | RESSORT |
| 21 | PAF8-01010112 | 3K9-05223-0 | ADAPTADOR | TIE-IN, CONNECTING ROD | ADATTATORE | EMBOUT DE CABLE |
| 22 | PAF8-01010106 | 3V1-66313-0 | UÑA | OUTER FRAME, ROTARY BRACKET | CORNICE ESTERNA | CADRE EXTERIEUR POUR SUPPORT ROTATIF |
| 23 | PAJASOF40435-022 | 350-62415-0 | RETÉN | O-RING Ø22.4xØ3.5 | TENUTA ANELLO | JOINT |
| 24 | PAGB/T7940.1-M6 | 344-67177-0 | ENGRASADOR M6 | OILER M6 | INGRASSATORE M6 | GRAISSEUR M6 |
| 25 | PAF8-01010108 | 3B2-66321-1 | EJE | SHAFT, ROTARY BRACKET | ASSE | AXE |
| 26 | PAGB/T896-5 | 945303-0500 | CLIP | CIRCLIP | CLIP | CLIP |
| 27 | PAF8-00000002 | 3V1-61302-0 | AMORTIGUADOR | ABSORBER | AMMORTIZZATORE | SILENT BLOC |
| 28 | PAF15-04000002 | 3R3-07405-1 | TAPÓN | BOLT, OIL DRAIN | TAPPO | BOUCHON |
| 29 | PAF15-04000003 | 3R3-07406-0 | JUNTA | GASKET | GUARNIZIONE | JOINT |
| 30 | PAF8-02000002 | 3B2-01215-0 | RETÉN | OIL SEAL | PARAOILIO | JOINT SPI |
| 31 | PAF8-02000003 | 3V1-07440-0 | SEPARADOR CARTER | CLAPBOARD, OIL SUMP | ASSICELLA, COPPA OLIO | PLAQUE GUIDE |
| 32 | PAF8-02000004 | 3V1-61220-0 | JUNTA TAPA DE ESCAPE | GASKET, EXHAUST OUTER COVER | GUARNIZIONE COPERCHIO SCARICO | JOINT DE COUVERCLE EXT ECHAPPEMENT |
| 33 | PAF8-02000005 | 3V1-61208-0 | TAPA ESCAPE | EXHAUST OUTER COVER | COPERCHIO SCARICO | COUVERCLE EXT ECHAPPEMENT |
| 34 | PAF8-02000007 | 3V1-65206-0 | RETÉN TUBO DE AGUA | UPPER SEAL, WATER PIPE | TENUTA, TUBO ACQUA | JOINT SUPERIEUR TUBE D'EAU |
| 35 | PAF8-02000006(L) | 3V1-65110-0 | TUBO L | WATER PIPE L | TUBO L | TUYAU D'EAU L |
| | PAF8-02000006(S) | 3V1-65100-0 | TUBO S | WATER PIPE S | TUBO S | TUYAU D'EAU S |
| 36 | PAF8-02000009 | 3V1-65203-0 | PLACA TUBO DE AGUA | PLATE, WATER PIPE | PIASTRA, TUBO ACQUA | PLAQUE PIPE D'EAU |

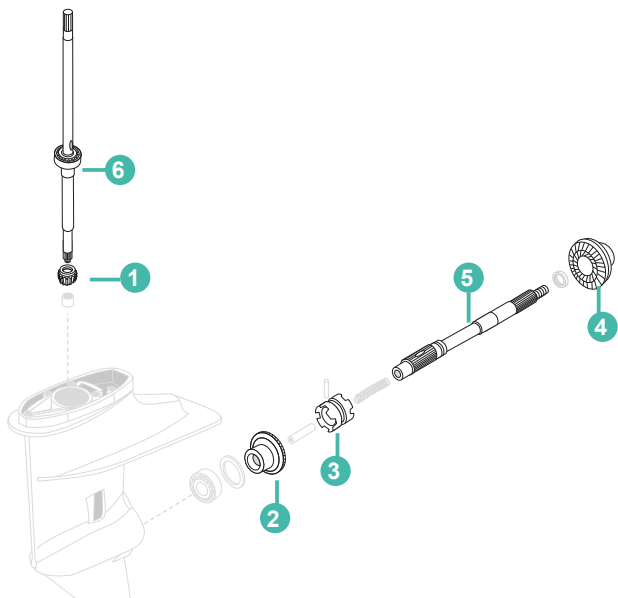

GUÍA PIEZAS COLA

STERN DRIVE COMPONENTS GUIDE

GUIDA RICAMBI PIEDI

GUIDE PIÈCES D'EMBASE

| | 1 | 2 | 3 | 4 | 5 | 6 S | 6 L |
|--------------------------------|-----------------|-----------------|---------------|-----------------|---------------|----------------|----------------|
| M2.5A, B, A2 | REC43-16138 | REC43-812944 | | | | | |
| M3.5A, B, A2, B2 | REC43-16138 | REC43-812944 | | | | | |
| M4C M5B, BS | REC43-16138 | REC43-812944 | | REC43-8129451 | REC44-195133 | REC45-161351 | REC8M0076368 |
| MFS4, 5, 6A2, B, C | REC43-16138 | REC43-812944 | | REC43-8129451 | REC44-195133 | REC45-161351 | REC8M0076368 |
| MFS8, 9.8B | PAF8-04000003 | PAF8-04010000 | | PAF8-04000014 | PAF8-04000301 | | |
| MFS8A2-3 MFS9.8A2-3 M9.9 | PAF8-04000003 | PAF8-04010000 | PAF8-04000303 | PAF8-04000014 | PAF8-04000301 | PAF8-04020001S | PAF8-04020001L |
| M15D2 M18E2 MFS9.9B2 | REC43-803740 | REC43-803739 | | REC43-803741 | REC879147T96 | REC45-803738 | REC45-8037381 |
| MFS15B2 MFS18B2 | REC43-803740T02 | REC43-803739T03 | | REC43-803741T03 | REC879147T96 | | |

SISTEMA DE PROPULSIÓN PROPULSION SYSTEM

SISTEMA DI PROPULSIONE SYSTEME DE PROPULSION

| HÉLICES ALUMINIO E INOXIDABLE DE 3 Y 4 PALAS | 3 & 4 BLADE ALUMINIUM & SS PROPELLERS | ELICHE ALLUMINIO E INOX DA 3 E 4 PALE | HELICE ALUMINIUM ET INOX 3 ET 4 PALES |
|---|---|--|--|
| CÓDIGO DE REFERENCIAS | PART NO. CODING SYSTEM | SISTEMA DI CODICE | CODAGE DES REFERENCES |
| | | | |
| <p>1. Mercury, Mariner 2. Johnson, Evinrude 3. Yamaha 4. Suzuki 5. Tohatsu 6. 7. 8. Volvo Penta 9. Rubex System</p> | <p>0.5, 6, 8 and 9.8 HP Group 1. A Group 2. B Group 3. C Group 4. D Group 5. E Group 6. F Group 7. VP (Std. Hub) 8. VP (Long Hub)</p> | <p>1. AL 2. Saturn (INOX Stainless Steel) 3. New Saturn (INOX Stainless Steel) 4. Titan (INOX Stainless Steel) 5. HR Titan (INOX Stainless Steel) 6. Scorpion (INOX Stainless Steel) 7. Lexor (INOX Stainless Steel)</p> | <p>1. 3R Rubber Hub 2. 3L Rubber Hub 3. 4R Rubber Hub 4. 4L Rubber Hub</p> |

SOLAS

AMITA 3

SOLAS

Hélice de aluminio con núcleo de goma de gran resistencia.

Aluminum propeller with heavy duty rubber hub.

Eliche di alluminio con mozzi in gomma ad alta resistenza.

Hélice en aluminium avec moyeu en caoutchouc



AMITA 4

SOLAS

Hélices de aluminio con núcleo de goma de gran resistencia. Van muy suaves a poca velocidad y hace el barco muy manejable con la mar picada.

Aluminum propeller with heavy duty rubber hub. Smoother low speed makes the offshore boating activity much easier.

Eliche di alluminio con mozzo in gomma ad alta resistenza. Molto morbido a bassa velocità e rende la barca molto maneggevole con mare cattivo.

Hélice en aluminium avec moyeu en caoutchouc. Permet d'aller doucement à basse vitesse et rende le bateau très maniable lorsque la mer est agitée



NEW SATURN

SOLAS

Hélices de acero inoxidable. Ofrece buena aceleración y rendimiento. Tamaño más pequeño que ofrece un diámetro extragrande.

Stainless steel propeller. Offers good acceleration & all-round performance. Smaller pitch sizes offered in extra large diameter with increased blade area.

Eliche di acciaio inox. Buona accelerazione. Piccole dimensioni che offre un più grande diametro.

Hélice inox, offrant de bonnes accélérations et performances. Taille de pas réduite pour les modèles de grands diamètres avec une surface de pale plus importante.

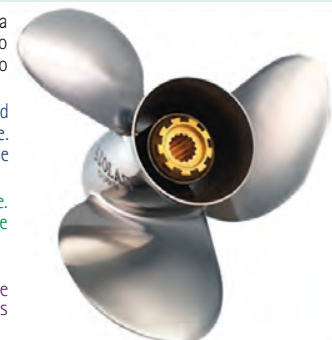

**GUÍA DE HÉLICES
CON NÚCLEO INTEGRADO**

**PROPELLERS APPLICATION
WITH RUBBER HUB**

**GUIDA ELICHE
CON MOZZO**

**GUIDE DES HÉLICES
ET MOYEUX**

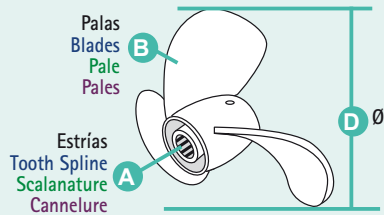

| | 2T STROKES | 4T STROKES | R.O. OEM | A B D P R | | | | | AL | | INOX STAINLESS STEEL | |
|------------------------------|---------------|---------------|-------------|-----------|---|-------|---|------|---------|----------------|-------------------------|----------------|
| | | | | | | | | | AMITA 3 | AMITA 4 | | NEW SATURN |
| 5 | ✓ | | | | | | 7 | | R | SOL5011-078-07 | | |
| 4, 5, 6 | | ✓ | | 3 | | 7,8 | | 8 | | SOL5011-078-08 | | |
| | | | 3B2-64513-0 | | | | | 6,5 | | SOL5011-085-07 | | |
| 8, 9'8 | ✓ | ✓ | 3B2-64515-0 | 12 | 3 | 8,5 | | 7,5 | R | SOL5011-085-08 | | |
| | | | 3B2-64517-0 | | | | | 8,5 | | SOL5011-085-09 | | |
| | | | 362-64105-0 | | | | | 6,9 | | SOL5111-093-07 | | |
| 9'9, 12, 15, 18 | ✓ | | 362-64103-0 | | | | | 7,8 | | SOL5111-093-08 | | |
| | | | 362-64101-0 | | | | | 8,8 | | SOL5111-093-09 | | |
| | | | | 14 | 3 | 9,2 | | 9,1 | R | SOL5111-093-09 | | |
| 9'9, 15, 18, 20 | | ✓ | 362-64108-0 | | | | | 9,8 | | SOL5111-093-10 | | |
| | | | | | | | | 11 | | SOL5111-093-11 | | |
| | | | 346-64101-5 | | | 9,8 | | 9,3 | | SOL5211-099-09 | | |
| | | | 346-64102-5 | | | 9,8 | | 10,2 | | SOL5211-099-10 | | |
| 25, 30 | ✓ | ✓ | 346-64103-5 | | | 9,8 | | 11,3 | R | SOL5211-099-11 | | |
| | | | | | | 9,9 | | 12 | | SOL5211-099-12 | | |
| | | | 346-64104-5 | | | 9,8 | | 13,1 | | SOL5211-099-13 | | |
| | | | | | | 12,2 | | 7 | | SOL5311-122-07 | | |
| | | | 361-64113-0 | | | 12,2 | | 8 | | SOL5311-122-08 | | |
| | | | 361-64114-0 | | | 12,1 | | 9 | | SOL5311-121-09 | SOL5313-118-09 | |
| | | | 348-64102-0 | | | 11,6 | | 11 | | SOL5311-116-11 | SOL5313-111-11 | |
| 35, 40, 50, 55 | ✓ | | 348-64103-0 | | | 11,4 | | 12 | | SOL5311-114-12 | SOL5313-108-12 | |
| | | | 3E3-64528-0 | 13 | 3 | 11,1 | | 13 | R | SOL5311-111-13 | SOL5313-105-13 | |
| | | | 3E3-64536-0 | | | 11,1 | | 14 | | SOL5311-111-14 | SOL5313-105-14 | |
| | | | | | | 11 | | 15 | | SOL5311-110-15 | | |
| | | | | | | 11 | | 16 | | SOL5311-110-16 | | |
| | | | | | | 11 | | 17 | | SOL5311-110-17 | | |
| | | | 3B7-64523-1 | | | 14 | | 11 | | SOL3411-140-11 | | |
| | | | 3B7-64527-1 | | | 13,75 | | 13 | | SOL3411-138-13 | SOL3413-133-13 | |
| 60, 70, 90, 115, 120, 140 | ✓ | | 3C7-64536-0 | | | 13,5 | | 15 | | SOL3411-135-15 | SOL3413-130-15 | SOL3431-135-15 |
| | | | 3C7-64541-0 | 15 | 3 | 13,25 | | 17 | R | SOL3411-133-17 | SOL3413-128-17 | SOL3431-133-17 |
| | | | 3C7-64554-0 | | | 13 | | 19 | | SOL3411-130-19 | SOL3413-125-19 | SOL3431-130-19 |
| | | | | | | 13 | | 21 | | SOL3411-130-21 | SOL3413-125-21 | SOL3431-130-21 |



- P** Paso
Pitch
Passo
Pas
- R** Rotación L (izquierda) R (derecha)
Rotation L (left) R (Right)
Rotazione L (SX) R (DX)
Rotation L (gauche) R (droit)

NÚCLEO INTERCAMBIABLE INTERCHANGEABLE HUB

MOZZO INTERCAMBIABILE MOYEU INTERCHANGEABLE

|  | A | REF |  |
|--|----|------------|---|
| 35HP (35B only) (1984+) 40HP (1984+), 50HP (All except 50C) (1992+) 50HP (50C only) (1987-91) | 13 | SOLRBX-116 | C |
| 55HP (1981-88) 60A (1986+) 70A/70B (1981+) | 13 | SOLRBX-112 | C |
| 90-140HP, (1987+) | 13 | SOLRBX-109 | D |



RUBEX

HÉLICES PARA NÚCLEO INTERCAMBIABLE

PROPELLERS FOR INTERCHANGEABLE HUB

ELICHE PER MOZZO INTERCAMBIABILE

HELICES AVEC MOYEU INTERCHANGEABLE

|  | B | D | P | R | AL |
|---|---|-------|----|---|----------------|
| C 30-75 HP | 3 | 11.4 | 12 | R | SOL9311-114-12 |
| | | 11.1 | 13 | R | SOL9311-111-13 |
| | | 14 | 9 | R | SOL9411-140-09 |
| | | 14 | 11 | R | SOL9411-140-11 |
| D 40-140 HP | 3 | 13.75 | 13 | R | SOL9411-138-13 |
| | | 13.50 | 15 | R | SOL9411-135-15 |
| | | 13.25 | 17 | R | SOL9411-133-17 |
| | | 13.2 | 19 | R | SOL9411-132-19 |
| | | 13.2 | 21 | R | SOL9411-132-21 |
| | | 15.5 | 11 | R | SOL9511-155-11 |
| E 135-350 HP | 3 | 15.3 | 13 | R | SOL9511-153-13 |
| | | 16 | 13 | R | SOL9511-160-13 |
| | | 15 | 15 | R | SOL9511-150-15 |
| | | 15 | 15 | L | SOL9512-150-15 |
| | | 14.8 | 17 | R | SOL9511-148-17 |
| | | 14.8 | 17 | L | SOL9512-148-17 |
| | | 14.5 | 19 | R | SOL9511-145-19 |
| | | 14.5 | 19 | L | SOL9512-145-19 |
| | | 14.3 | 21 | R | SOL9511-143-21 |
| | | 14.3 | 21 | L | SOL9512-143-21 |

|  | B | D | P | R | INOX STAINLESS STEEL |
|---|---|-------------------|----|---|----------------------|
| D 40-140 HP | 3 | 13 ^{3/4} | 13 | R | SOL9431-138-13 |
| | | 13 ^{3/4} | 13 | L | SOL9432-138-13 |
| | | 13 ^{1/2} | 15 | R | SOL9431-135-15 |
| | | 13 ^{1/2} | 15 | L | SOL9432-135-15 |
| | | 13 ^{1/4} | 17 | R | SOL9431-133-17 |
| | | 13 ^{1/4} | 17 | L | SOL9432-133-17 |
| | | 13 | 19 | R | SOL9431-130-19 |
| | | 13 | 19 | L | SOL9432-130-19 |
| | | 13 | 21 | R | SOL9431-130-21 |
| | | 13 | 21 | L | SOL9432-130-21 |
| E 90-140 HP | 3 | 14 ^{1/2} | 15 | R | SOL9531-145-15 |
| | | 14 ^{1/2} | 15 | L | SOL9532-145-15 |
| | | 14 ^{1/4} | 17 | R | SOL9531-143-17 |
| | | 14 ^{1/4} | 17 | L | SOL9532-143-17 |
| | | 14 | 19 | R | SOL9531-140-19 |
| | | 14 | 19 | L | SOL9532-140-19 |
| | | 14 | 21 | R | SOL9531-140-21 |
| | | 14 | 21 | L | SOL9532-140-21 |
| | | 14 | 23 | R | SOL9531-140-23 |
| | | 14 | 23 | L | SOL9532-140-23 |
| E 135-350 HP | 3 | 15 ^{3/4} | 15 | R | SOL9571-158-15 |
| | | 15 ^{3/4} | 15 | L | SOL9572-158-15 |
| | | 15 ^{1/2} | 17 | R | SOL9571-155-17 |
| | | 15 ^{1/2} | 17 | L | SOL9572-155-17 |
| | | 15 ^{1/4} | 19 | R | SOL9571-153-19 |
| | | 15 ^{1/4} | 19 | L | SOL9572-153-19 |
| | | 15 | 21 | R | SOL9571-150-21 |
| | | 15 | 21 | L | SOL9572-150-21 |
| | | 14 ^{3/4} | 23 | R | SOL9571-148-23 |
| | | 14 ^{3/4} | 23 | L | SOL9572-148-23 |

RUBEX



Núcleo intercambiable (no incluido).
Interchangeable hub (not included).
Mozzo intercambiabile (non incluso).
Moyeu interchangeable (non inclus)

REF--> RO / OEM

| REF | R.O. / OEM | |
|------------------|----------------|---------|
| C | | |
| CEF500337 | HZW1-19210-B04 | 604 |
| CEF500338 | HZV5-19210-003 | 604 |
| CEF500344 | 3B2-65021-1 | 589-604 |
| CEF500377 | 369-65021-1 | 589-604 |
| CEF500379 | 345-65021-1 | 604 |
| CEF500382 | 345-65021-0 | 589-604 |
| CEF500383 | 334-65021-0 | 589-604 |
| CEF500388 | 3B7-65021-2 | 604 |
| CEF500388 | 3C7-65021-1 | 604 |
| CEF500391 | HZY3-19210-003 | 604 |
| CEF500396 | 309-65021-1 | 604 |
| CM33860-2181 | 338-60218-2 | 606 |
| CM348-60217-0M | 348-60217-0 | 606 |
| CM3B7-602170 | 3B7-60217-0 | 606 |
| CM3B7-60218-0 | 3B7-60218-1 | 606 |
| CM3C760-2181 | 3C7760-2181 | 606 |
| CM3C760-2181A | 3C7760-2181 | 606 |
| CM3C8-60217-0 | 3C8-60217-1 | 606 |
| CM3H6-60218-000 | 3H6-60218-0 | 606 |
| CM3H6-60218-000A | 3H6-60218-0 | 606 |
| CM3M2-60218-1 | 3M2-60218-0 | 606 |
| CM3V1-60217-0 | 3V1602170 | 606 |
| CM3V1-60217-0A | 3V1602170 | 606 |
| CM5338602182A0 | 5338602182A0 | 606 |
| CM5338602182A0A | 5338602182A0 | 606 |
| CHAL78C | | 600 |
| CHAL82C | | 600 |
| CHAL82YC | | 600 |
| CHAL86C | | 600 |
| CHAL87YCC | | 600 |
| CHARA8HC | | 600 |
| G | | |
| GS30435 | | 595 |
| GS31001 | | 594 |
| GS31002 | | 594 |
| GS31015 | 394-702500M | 592 |
| GS31016 | 3B2-702801M | 592 |
| GS31017 | | 592 |
| GS31018 | 3B2-702601M | 592 |
| GS31019 | 99998-0MA2 | 591 |
| GS31020 | | 591 |
| GS31064 | | 592 |
| GS31065 | | 594 |
| GS31066 | | 594 |
| GS31067 | | 594 |
| GS31068 | | 591 |
| GS31069 | | 591 |
| GS31073 | | 591 |
| GS31088 | | 591 |
| GS31090 | | 590 |
| GS31090 | | 590 |
| GS31095 | | 590 |
| GS31096 | | 590 |
| GS31097 | | 590 |
| GS31099 | | 590 |
| GS31155 | | 594 |
| GS31156 | | 594 |
| GS31157 | | 594 |
| GS31166 | | 594 |
| GS31183 | | 590 |
| GS31187 | 65770-95541 | 590 |
| GS31189 | | 590 |
| GS35031 | | 590 |
| GS35032 | | 590 |
| GS31183 | | 442 |
| GS31187 | | 442 |
| GS31189 | | 442 |
| GS35031 | | 442 |
| GS35032 | | 442 |
| L | | |
| LENS3213 | | 593 |
| LENS3227 | 99105-20005 | 593 |
| N | | |
| NGKB7HS-10 | 9701-1-1005 | 600 |
| NGKB8HS-10 | 9701-1-1006 | 600 |
| NGKBP7HS-10 | 9701-1-1010 | 600 |
| NGKBP7HS-10 | 9701-1-1013 | 600 |
| NGKBP7HS-10 | 9701-1-1014 | 600 |
| NGKBR7HS-10 | 9701-1-1015 | 600 |
| NGKBR8HS-10 | 9701-1-1110 | 600 |
| NGKDCPR6E | 9701-1-1103 | 589-600 |
| NGKIKR6G8 | 9701-1-1121 | 600 |
| NGKIZFR5J | 9791-1-1109 | 600 |
| NGKIZFR6 | 9701-1-1111 | 600 |
| NGKLMAR6C-9 | HZZ3-31909-003 | 600 |

| REF | R.O. / OEM | |
|------------------|----------------|---------|
| P | | |
| PAF15-04000002 | 3R3-07405-1 | 625 |
| PAF15-04000003 | 3R3-07406-0 | 625 |
| PAF15-06000016 | 369-64121-0 | 623 |
| PAF15-07000017 | 3V1-02011-0 | 615 |
| PAF15-07000018 | 3V1-03952-0 | 615 |
| PAF15-07000031 | HZW9-19300-003 | 603 |
| PAF15-07010100 | 3H6-07611-0 | 598-613 |
| PAF15-07010101 | 3H6-07612-0 | 613 |
| PAF15-07020005 | 350-00024-1 | 615-620 |
| PAF15-07040303 | 3R0-07238-0 | 615 |
| PAF15-07040304 | 3H8-07237-0 | 615 |
| PAF15-07080000 | 3AC-02230-0 | 594 |
| PAF15-07080000 | 3AD-02230-0 | 594 |
| PAF15-07080000 | 3B7-02230-0 | 594 |
| PAF4-01010002 | 398-62103-0 | 625 |
| PAF4-01010003 | 332-62101-0 | 625 |
| PAF4-01010005 | 3C8-62104-1 | 625 |
| PAF4-04000019 | 3T5-10131-0 | 615 |
| PAF4-04000030 | | 591 |
| PAF4-04130101 | 3AA-05019-0 | 616 |
| PAF4-04130102 | 3R1-05131-0 | 616 |
| PAF4-05000010 | | 591 |
| PAF4-05000300 | 369-02230-0 | 595 |
| PAF4-05000300 | 396-02230-0 | 595 |
| PAF4-05000300 | | 589 |
| PAF40-0701000E1 | | 594 |
| PAF8-00000002 | 3V1-61302-0 | 625 |
| PAF8-00000003 | 3R3-61017-0 | 615 |
| PAF8-00000004 | 3V1-01303-0 | 615 |
| PAF8-00000100 | 3V1-61333-1 | 625 |
| PAF8-00000200 | 3V1-07421-0 | 615 |
| PAF8-005030010 | 3H8-07226-0 | 615 |
| PAF8-01000001 | 350-62423-0 | 625 |
| PAF8-01000002 | 350-62417-0 | 625 |
| PAF8-01000003 | 3V1-61313-0 | 625 |
| PAF8-01000100 | 345-62441-0 | 625 |
| PAF8-01010102 | 346-62421-1 | 625 |
| PAF8-01010103 | 393-62437-0 | 625 |
| PAF8-01010104 | 369-66112-1 | 625 |
| PAF8-01010105 | 369-62439-1 | 625 |
| PAF8-01010106 | 3V1-66313-0 | 625 |
| PAF8-01010108 | 3B2-66321-1 | 625 |
| PAF8-01010109 | 3B2-66315-0 | 625 |
| PAF8-01010112 | 3K9-05223-0 | 625 |
| PAF8-01010200 | 350-62121-1 | 625 |
| PAF8-01010200 | 369-62122-2 | 625 |
| PAF8-02000002 | 3B2-01215-0 | 625 |
| PAF8-02000003 | 3V1-07440-0 | 625 |
| PAF8-02000004 | 3V1-61220-0 | 625 |
| PAF8-02000005 | 3V1-61208-0 | 625 |
| PAF8-02000006(L) | 3V1-65110-0 | 625 |
| PAF8-02000006(S) | 3V1-65100-0 | 625 |
| PAF8-02000007 | 3V1-65206-0 | 625 |
| PAF8-02000009 | 3V1-65203-0 | 625 |
| PAF8-02000100 | 3V1-61301-1 | 625 |
| PAF8-02000100 | 940113-0800 | 625 |
| PAF8-03000010 | 3V1-66211-0 | 623 |
| PAF8-03000011 | 3V1-66302-0 | 623 |
| PAF8-03010001 | 3V1-66187-0 | 623 |
| PAF8-03010003 | 3V1-66225-0 | 623 |
| PAF8-03010005 | 3B2-66113-0 | 623 |
| PAF8-03010006 | 3C8-66116-0 | 623 |
| PAF8-03010007 | 3B1-66145-0 | 623 |
| PAF8-04000003 | 3B2-64020-0 | 623-626 |
| PAF8-04000004-1 | 3B2-64023-0 | 623 |
| PAF8-04000005 | 3B2-65020-0 | 623 |
| PAF8-04000006 | 3B2-65029-0 | 623 |
| PAF8-04000007 | 3B2-65025-0 | 605-623 |
| PAF8-04000008 | 3B2-65018-0 | 623 |
| PAF8-04000009 | 3B2-65016-0 | 623 |
| PAF8-04000010 | 3B2-65011-0 | 605-623 |
| PAF8-04000012 | 369-64032-0 | 623 |
| PAF8-04000012-1 | 369-64014-0 | 623 |
| PAF8-04000012-2 | 369-64015-0 | 623 |
| PAF8-04000013 | 3B2-65016-0 | 623 |
| PAF8-04000014 | 3B2-64030-0 | 623-626 |
| PAF8-04000015 | 3V1-60042-0 | 623 |
| PAF8-04000016 | 3V1-60041-0 | 623 |
| PAF8-04000019 | 3B2-64230-1 | 623 |
| PAF8-04000021 | 3B2-65022-0 | 623 |
| PAF8-04000101 | 309-60111-0 | 623 |
| PAF8-04000200 | 3B2-65021-1 | 623 |
| PAF8-04000301 | 3V1-64211-0 | 623-626 |
| PAF8-04000302 | 3V1-64221-0 | 623 |
| PAF8-04000303 | 3B2-64215-0 | 623-626 |
| PAF8-04000305 | 369-64223-0 | 623 |
| PAF8-04010000 | 3B2-64010-0 | 623-626 |
| PAF8-04020001L | 3V1-64307-1 | 623-626 |
| PAF8-04020001S | 3V1-64306-1 | 623-626 |
| PAF8-04040000 | 3B2S60100-0 | 623 |
| PAF8-04040001 | 3B2S60101-0 | 623 |

| REF | R.O. / OEM | |
|------------------|----------------|---------|
| PAF8-04040002 | 345-65015-0 | 623 |
| PAF8-04040004 | 369-60111-0 | 623 |
| PAF8-04050000 | 3B2W64517-0 | 623 |
| PAF8-05000002 | 3V1-01024-0 | 615 |
| PAF8-05000003 | 172-36008-0 | 616 |
| PAF8-05000004 | 3V1-10045-0 | 589-615 |
| PAF8-05000006 | 3A0-76079-0 | 613 |
| PAF8-05000007 | 3B7-06305-0 | 613 |
| PAF8-05000008 | 3V1-02010-1 | 615 |
| PAF8-05000009 | 3V1-02104-0 | 615 |
| PAF8-05000011 | 3T5-06920-0 | 613 |
| PAF8-05000012 | 3V1-06308-0 | 616 |
| PAF8-05000013 | 3V1-06302-0 | 616 |
| PAF8-05000017 | 98AH10-0120 | 615 |
| PAF8-05000018 | 346-67114-0 | 623 |
| PAF8-05000019 | 3V1-63622-0 | 623 |
| PAF8-05000020 | 3V1-63508-0 | 623 |
| PAF8-05000021 | 3R0-66308-0 | 613 |
| PAF8-05000024 | 369-00132-0 | 613 |
| PAF8-05000024 | 98AB-5-0330 | 615 |
| PAF8-05000025 | 369-84398-0 | 615 |
| PAF8-05000100 | 3V1-02305-0 | 615 |
| PAF8-05000200 | 3V1-06071-0 | 599-613 |
| PAF8-05000300 | 3AA-06021-0 | 598-613 |
| PAF8-05000400 | 3AA-06060-0 | 613 |
| PAF8-05000400 | 3AA-06060-00 | 601 |
| PAF8-05000400 | 3AA060600M | 601 |
| PAF8-05000500 | 3V1-06040-0 | 599-613 |
| PAF8-05000500 | 3V1060400 | 599 |
| PAF8-05000500 | 3V1060400M | 599 |
| PAF8-05000600 | 3AA-06091-0 | 613 |
| PAF8-05000800 | 3V1-07410-0 | 615 |
| PAF8-05010000 | 3V1B01100-0 | 615 |
| PAF8-05010002 | 3H8-02093-0 | 615 |
| PAF8-05010004 | 3V1-02305-0 | 615 |
| PAF8-05010005 | 346-01032-0 | 615 |
| PAF8-05010009 | 3V1-07407-0 | 615 |
| PAF8-05010012 | 3V1-00121-0 | 615 |
| PAF8-05010014 | 3V1-10060-0 | 615 |
| PAF8-05010015 | 3V1-10063-0 | 615 |
| PAF8-05010016 | 3V1-10068-0 | 615 |
| PAF8-05020001 | 3V1-00030-1 | 615 |
| PAF8-05020101 | 3V1-00001-0 | 615-620 |
| PAF8-05020105 | 332-00021-0 | 615 |
| PAF8-05020105 | 332-00024-0 | 620 |
| PAF8-05020200 | 3V1-00040-0 | 615-620 |
| PAF8-05030001 | 3V1-07201-0 | 615 |
| PAF8-05030002 | 3V1-07202-0 | 615 |
| PAF8-05030004 | 3V1-07205-0 | 615 |
| PAF8-05030005 | 3AA-07203-0 | 615 |
| PAF8-05030006 | 3V1-07221-0 | 615 |
| PAF8-05030007 | 3H6-07223-0 | 615 |
| PAF8-05030008 | 3V1-07010-0 | 615 |
| PAF8-05030009 | 3AA-07225-0 | 615 |
| PAF8-05030011 | 3H8-07025-0 | 615 |
| PAF8-05030012 | 3V1-07653-0 | 615 |
| PAF8-05030015 | 3R3-07227-0 | 615 |
| PAF8-05030100 | 3V1B01001-0 | 615 |
| PAF8-05030200 | 3V1-07235-0 | 615 |
| PAF8-05030300 | 3V1-07600-0 | 615 |
| PAF8-05030400 | 3H8-10062-2 | 615 |
| PAF8-05040000 | 3V2-03100-2 | 596 |
| PAF8-05050002 | 3V1-05259-0 | 616 |
| PAF8-05050003 | 3R1-05125-0 | 616 |
| PAF8-05050004 | 3AA-05004-0 | 616 |
| PAF8-05050005 | 3V1-05104-1 | 616 |
| PAF8-05050006 | 3R1-05003-1 | 616 |
| PAF8-05050007 | 3R1-05012-0 | 616 |
| PAF8-05050009 | 3R1-05007-0 | 616 |
| PAF8-05050018 | 3AA-05013-0 | 616 |
| PAF8-05090000W | 3V1-06023-0 | 599 |
| PAGB/T5783-M6X20 | 910184-5620 | 625 |
| PAGB/T5783-M8X30 | 910113-0830 | 625 |
| PAGB/T940.1-M6 | 344-67177-0 | 625 |
| PAGB/T889.1-M8 | 3V1-61324-0 | 625 |
| PAGB/T896-5 | 945303-0500 | 625 |
| PAGB/T97.1-6 | 910184-5620 | 625 |
| PAJASOF40435-022 | 350-62415-0 | 625 |
| PANSKFJ-1516 | 3V1-60211-0 | 623 |
| PAT15-04000011 | 940121-1200 | 613 |
| PAT3.6-04000006 | 309-00131-0 | 615 |
| PH130-0006 | 3C8-76010-1 | 600 |
| PH130-0006 | 3C8760101 | 600 |
| PH130-0006 | 3C8760101M | 600 |
| PH130-0048 | 353-76010-4 | 600 |
| PH130-0061 | 350-76010-0 | 600 |
| PH130-0061 | 3AA760100 | 600 |
| PH130-0070 | HZY3-31200-003 | 601 |
| PH130-0080 | 346-76010-0M | 600 |
| PH200-T024 | | 602 |
| PH200-WH01 | | 602 |

TOHATSU

RECAMBIOS MARINOS

| REF | R.O. / OEM | |
|---------------------------|-----------------|-------------|
| RAC23289-10 | | 593 |
| RAC23299-10 | | 593 |
| RAC320R-RAC-01 | | 593 |
| RAC320R-RAC-03 | | 593 |
| RAC490R-RAC-01 | 99105-20005-ASY | 593 |
| RACPF5510 | | 592 |
| RACRK22628 | | 594 |
| RACS3213 | | 593 |
| RACS3227 | 99105-20005 | 593 |
| REC06192-ZY3-000 | HZY3-06192-000 | 605 |
| REC06192-ZY6-000 | HZY6-06192-000 | 605 |
| REC09401-11425 | | 591 |
| REC09401-11425BULK | | 591 |
| REC10W30U3 | | 595 |
| REC10W30U6 | | 595 |
| REC10W40U3 | 990C0-10W40-GLN | 595 |
| REC10W40U6 | 990C0-10W40-GLN | 595 |
| REC15400-PLM-A01PE | HPLM-15400-PE | 596 |
| REC16157 | 369-65011-0 | 605 |
| REC16159 | 369-65025-0 | 605 |
| REC16253 | 369-03231-0 | 597 |
| REC162532 | 3C8-03125-0 | 597 |
| REC16275 | 369-03303-0 | 596 |
| REC16325 | 369-03306-0 | 596 |
| REC16911-ZY3-010 | HZY3-16911-010 | 595 |
| REC16911-ZZ5-003 | HZZ5-16911-003 | 595 |
| REC17109-ZY6-000 | HZY6-17109-000 | 621 |
| REC18-6865 | | 602 |
| REC19210-ZV5-003 | HZV5-19210-003 | 604 |
| REC19210-ZW1-B02 | HZW1-19210-B04 | 604 |
| REC19210-ZY3-003 | HZY3-19210-003 | 604 |
| REC19300-ZV5-043 | HZV5-19300-043 | 603 |
| REC22-8M0001721 | | 591 |
| REC24942 | | 592 |
| REC24950 | | 593 |
| REC24952 | | 593 |
| REC25000 | | 592 |
| REC25010 | | 592 |
| REC25020 | | 592 |
| REC25030 | | 592 |
| REC25W40U3 | | 595 |
| REC26-16051 | 369-00122-0 | 608 |
| REC26-161301 | 346-60111-0 | 618 |
| REC26-16162 | 369-60223-0 | 618 |
| REC26-161622 | 346-65013-0 | 618 |
| REC26-16703 | 369-01215-0 | 618 |
| REC26-803514 | 101-00121-0 | 609 |
| REC26-803667 | 350-00121-0 | 618 |
| REC26-85370711 | 3B2-00051-0 | 609 |
| REC26-8537072 | 346-01215-0 | 618 |
| REC27-16274 | 369-03302-0 | 596 |
| REC27-16326 | 369-03307-0 | 596 |
| REC27-8555691 | 3C8-04028-0 | 596 |
| REC27U3 | | 595 |
| REC27U6 | | 595 |
| REC30-16049 | 9603-3-6204 | 608-609 |
| REC30-160494 | 96603-3-6305 | 610 |
| REC30-16049T01 | 345-00113-0 | 611 |
| REC30-898101936 | 9643-3-6004 | 619 |
| REC30580-ZV4-013 | HZV4-30580-013 | 599 |
| REC309-01005-2 | 309-01005-2 | 617 |
| REC31-16052 | 350-00042-0 | 608-610-619 |
| REC31-8036752 | 338-00042-0 | 609-619 |
| REC31-813048 | 369-00043-0 | 608 |
| REC31-8130482 | 356-00043-0 | 611 |
| REC31-855553 | 3C8-00113-0 | 612 |
| REC31200-ZY6-003 | HZY6-31200-003 | 601 |
| REC345-00042-0 | 345-00042-0 | 611-612-620 |
| REC345-65021-0 | 345-65021-0 | 604 |
| REC346-01005-0 | 346-01005-0 | 617 |
| REC346-01303-0 | 350-01303-0 | 618 |
| REC35-802893Q | | 592 |
| REC35-802893Q01 | 3Y7-02234-0 | 592 |
| REC35-80365M | 646-24251-02 | 595 |
| REC350-01005-0 | 350-01005-0 | 617 |
| REC350-01303-0 | 350-01303-0 | 618 |
| REC350-61012-1 | 350-61012-1 | 618 |
| REC351-01005-0 | 351-01005-0 | 617 |
| REC353-06260-0 | 353-06260-0 | 601 |
| REC353-06260-0 | 353-06260-2 | 601 |
| REC35668-ZY6-003 | HZY6-35668-003 | 598 |
| REC369-06021-0 | 369-06021-0 | 598 |
| REC37510-PNB-003 | HPNB-37510-003 | 598 |
| REC39-16054A5 | 346-00011-0 | 611-620 |
| REC39-803678A1 | 350-00011-0 | 610 |

| REF | R.O. / OEM | |
|---------------------------|--------------|---------------------|
| REC39-803678A3 | 3B2-00011-0 | 609-619 |
| REC39-8M0055809 | 3V1-00011-0 | 615 |
| REC3A0-06040-1 | 3A0-06040-1 | 599 |
| REC3A106-2602M | 3A106-2402M | 601 |
| REC3A106-2602M | 3A106-2601M | 601 |
| REC3A106-2602M | 3A106-2602M | 601 |
| REC3B2-01005-0 | 3B2-01005-0 | 617 |
| REC3B2-01303-0 | 3B2-01303-0 | 618 |
| REC3B2-65021-1 | 3B2-65021-1 | 604 |
| REC3B7-65021-2 | 3B7-65021-2 | 604 |
| REC3B7-87121-1 | 3B7-87121-7 | 617 |
| REC3C8-01005-4 | 3C8-01005-4 | 617 |
| REC3C8-01024-0 | 3C8-01024-0 | 617 |
| REC3C8-01303-4 | 3C8-01303-4 | 618 |
| REC3C8-02104-0 | 3C8-02104-0 | 621 |
| REC3C8-02305-0 | 3C8-02305-0 | 621 |
| REC3F0-06060-0 | 3F0-06060-0 | 601 |
| REC3F0-65029-6 | 3F0-65029-6 | 605 |
| REC3F3-01005-0 | 3F3-01005-0 | 617 |
| REC3F3-01024-0 | 3F3-01024-0 | 617 |
| REC3F3-01303-1 | 3F3-01303-1 | 618 |
| REC3F3-02104-0 | 3F3-02104-0 | 621 |
| REC3F3-02305-1 | 3F3-02305-1 | 604 |
| REC3G2-06040-2 | 3G2-06040-2 | 599 |
| REC3G2-06060-2 | 3G2-06060-2 | 601 |
| REC3G3-06021-1 | 3G3-06021-1 | 598 |
| REC3T5-87121-6 | 3T5-87121-6 | 617 |
| REC3T9-01005-0 | 3T9-01005-0 | 617 |
| REC3T9-01032-0 | 3T9-01032-0 | 604 |
| REC3T9-02104-0 | 3T9-02104-0 | 621 |
| REC40135 | | 595 |
| REC40145 | | 595 |
| REC40155 | | 595 |
| REC40165 | | 595 |
| REC41-16056 | 369-00021-0 | 608-619 |
| REC41-16056 | 3C8-00021-0 | 612 |
| REC41-803680002 | 350-00021-0 | 610-619 |
| REC41-803680003 | 3C8-00021-0 | 611-620 |
| REC41-8036801 | 3B2-00021-0 | 609-619 |
| REC41-825713002 | 332-00021-0 | 610-619 |
| REC43-16138 | 309-64020-0 | 626 |
| REC43-803739 | 350-06401-0 | 626 |
| REC43-803739T03 | 3H8-640100 | 626 |
| REC43-803740 | 350-06401-0 | 626 |
| REC43-803740T02 | 3H8-64020-0 | 626 |
| REC43-803741 | 362-64215-0 | 626 |
| REC43-803741T03 | 3H8-64030-0 | 626 |
| REC43-812944 | 369-64010-2 | 626 |
| REC43-8129451 | 369-64030-2 | 626 |
| REC44-195133 | 369-64211-1 | 626 |
| REC45-161351 | 369-64301-0 | 626 |
| REC45-803738 | 350-64301-0 | 626 |
| REC45-8037381 | 350-64302-0 | 626 |
| REC53-16057 | 334-00024-1 | 611-612-620 |
| REC53-16057 | 350-00024-1 | 608-609-610-619-620 |
| REC5GH-13440-00 | 3R3R76150M | 589-596 |
| REC5GH-13440-00 | 3R0-07615-0 | 596 |
| REC5GH-13440-00 | 5GH-13440-00 | 596 |
| REC5W40U3 | | 595 |
| REC5W40U6 | | 595 |
| REC629-803674 | 350-00040-0 | 610-619 |
| REC629-8036741 | 3B2-00040-0 | 609-619 |
| REC629-813047T01 | 336-00040-1 | 611-620 |
| REC650-24351-51 | | 591 |
| REC66M-W0093-01 | 3V1-87122-0 | 597 |
| REC696-W0093-00 | 345-87122-4 | 597 |
| REC6A1-W0093-01 | 3F0-87122-2 | 597 |
| REC6E5-24351-51 | | 591 |
| REC6G1-W0093-00 | 369-87122-1 | 597 |
| REC6G1-W0093-00 | 3B2-87122-0 | 597 |
| REC6H1-W0093-01-00 | 346-87122-0 | 597 |
| REC6H3-W0093-02 | 346-87122-0 | 597 |
| REC6H4-W0093-03 | 3F3-87122-1 | 597 |
| REC6L2-W0093-00 | 3G2-87122-2 | 597 |
| REC6L8-G3118-01 | 332S62102-1 | 625 |
| REC70720 | | 594 |
| REC779-803677 | 350-00001-0 | 619 |
| REC779-803677 | 350-00001-1 | 610 |
| REC779-803677T02 | 351-00001-1 | 610-619 |
| REC779-804886 | 3B2-00001-0 | 609-619 |
| REC779-879194T01 | 346-00001-1 | 611-620 |
| REC779-96152 | 3C8-00001-3 | 620 |
| REC779-9615T | 369-00001-0 | 608-619 |
| REC779-9615T | 3C8-00001-3 | 612 |
| REC803673 | 350-00061-0 | 610 |

| REF | R.O. / OEM | |
|-------------------------|-----------------|-------------|
| REC803751 | 350-65011-1 | 605 |
| REC804898 | 3B2-63600-1 | 603 |
| REC80W90U3 | 990A0-01E81-01Q | 595 |
| REC80W90U6 | 990A0-01E81-01Q | 595 |
| REC813046002 | 369-00061-0 | 608 |
| REC8130461 | 334-00061-0 | 611 |
| REC84419M | 345-87122-0 | 597 |
| REC8537312 | 350-04005-0 | 596 |
| REC855676002 | 3R3-01030-0 | 589-603 |
| REC855686 | | 592 |
| REC879147796 | 362-64211-0 | 626 |
| REC8M0065585 | 350-01215-5 | 618 |
| REC8M0076368 | 369-64301-0 | 626 |
| REC8M0080349 | 346-00011-0 | 612-620 |
| REC8M0080357 | 351-00011-0 | 608-610-619 |
| REC90340-08002 | 332-60005-2 | 623 |
| REC90340-08020 | 332-60006-0 | 623 |
| REC90794-46866 | | 594 |
| REC90794-46868 | | 594 |
| RECOBBRACKET | | 592 |
| RECOBELEMENT | | 593 |
| RECOBFILALU | | 593 |
| RECOBFILTER | | 593 |
| RECYS-225-15 | | 594 |
| RM35-802893Q | | 592 |
| RM92-858026QB1U6 | | 595 |
| RM92-858027QB1U3 | | 595 |
| RM92-8M0086220U6 | | 595 |
| RM92-8M0086221U3 | | 595 |
| S | | |
| SIE18-8013 | | 590 |
| SIE18-8015 | | 590 |
| SOL3411-130-19 | 3C7-64554-0 | 628 |
| SOL3411-130-21 | | 628 |
| SOL3411-133-17 | 3C7-64541-0 | 628 |
| SOL3411-135-15 | 3C7-64536-0 | 628 |
| SOL3411-138-13 | 3B7-64527-1 | 628 |
| SOL3411-140-11 | 3B7-64523-1 | 628 |
| SOL3413-125-19 | 3C7-64554-0 | 628 |
| SOL3413-125-21 | | 628 |
| SOL3413-128-17 | 3C7-64541-0 | 628 |
| SOL3413-130-15 | 3C7-64536-0 | 628 |
| SOL3413-133-13 | 3B7-64527-1 | 628 |
| SOL3431-130-19 | 3C7-64554-0 | 628 |
| SOL3431-130-21 | | 628 |
| SOL3431-133-17 | 3C7-64541-0 | 628 |
| SOL3431-135-15 | 3C7-64536-0 | 628 |
| SOL5011-078-07 | | 628 |
| SOL5011-078-08 | | 628 |
| SOL5011-085-07 | 3B2-64513-0 | 628 |
| SOL5011-085-08 | 3B2-64515-0 | 628 |
| SOL5011-085-09 | 3B2-64517-0 | 628 |
| SOL5111-093-07 | 362-64105-0 | 628 |
| SOL5111-093-08 | 362-64103-0 | 628 |
| SOL5111-093-09 | 362-64101-0 | 628 |
| SOL5111-093-10 | 362-64108-0 | 628 |
| SOL5111-093-11 | | 628 |
| SOL5211-099-09 | 346-64101-5 | 628 |
| SOL5211-099-10 | 346-64102-5 | 628 |
| SOL5211-099-11 | 346-64103-5 | 628 |
| SOL5211-099-12 | | 628 |
| SOL5211-099-13 | 346-64104-5 | 628 |
| SOL5311-110-15 | 3E3-64536-0 | 628 |
| SOL5311-110-16 | | 628 |
| SOL5311-110-17 | | 628 |
| SOL5311-111-13 | 3E3-64528-0 | 628 |
| SOL5311-111-14 | 3E3-64536-0 | 628 |
| SOL5311-114-12 | 348-64103-0 | 628 |
| SOL5311-116-11 | 348-64102-0 | 628 |
| SOL5311-121-09 | 361-64114-0 | 628 |
| SOL5311-122-07 | | 628 |
| SOL5313-105-13 | 361-64113-0 | 628 |
| SOL5313-105-14 | 3E3-64528-0 | 628 |
| SOL5313-108-12 | 348-64103-0 | 628 |
| SOL5313-111-11 | 348-64102-0 | 628 |
| SOL5313-118-09 | 361-64114-0 | 628 |
| SOL9311-111-13 | | 629 |
| SOL9311-114-12 | | 629 |
| SOL9411-132-19 | | 629 |
| SOL9411-132-21 | | 629 |
| SOL9411-133-17 | | 629 |
| SOL9411-135-15 | | 629 |
| SOL9411-138-13 | | 629 |
| SOL9411-140-09 | | 629 |
| SOL9411-140-11 | | 629 |

| REF | R.O. / OEM | REF | R.O. / OEM |
|----------------|------------|----------------|----------------------|
| SOL9431-130-19 | 629 | SOL9571-148-23 | 629 |
| SOL9431-130-21 | 629 | SOL9571-150-21 | 629 |
| SOL9431-133-17 | 629 | SOL9571-153-19 | 629 |
| SOL9431-135-15 | 629 | SOL9571-155-17 | 629 |
| SOL9431-138-13 | 629 | SOL9571-158-15 | 629 |
| SOL9432-130-19 | 629 | SOL9572-148-23 | 629 |
| SOL9432-133-17 | 629 | SOL9572-150-21 | 629 |
| SOL9432-135-15 | 629 | SOL9572-153-19 | 629 |
| SOL9432-138-13 | 629 | SOL9572-155-17 | 629 |
| SOL9511-143-21 | 629 | SOL9572-158-15 | 629 |
| SOL9511-145-19 | 629 | SOLRBX-109 | 629 |
| SOL9511-148-17 | 629 | SOLRBX-112 | 629 |
| SOL9511-150-15 | 629 | SOLRBX-116 | 629 |
| SOL9511-153-13 | 629 | | |
| SOL9511-155-11 | 629 | TEN01250 | 338-60218-2 589-607 |
| SOL9511-160-13 | 629 | TEN01251 | 369-60218-1 607 |
| SOL9531-140-19 | 629 | TEN01252 | 348-60217-0 607 |
| SOL9512-143-21 | 629 | TEN01253 | 3C8-60217-1 589-607 |
| SOL9512-145-19 | 629 | TEN01254 | 3C7-60218-2 607 |
| SOL9512-148-17 | 629 | TEN01255 | 3B7-60217-0 607 |
| SOL9512-150-15 | 629 | TEN01256 | 3B7-60218-1 589-607 |
| SOL9531-140-21 | 629 | TEN01257 | 3M2-60218-0 607 |
| SOL9531-140-23 | 629 | TEN01258 | 5338602182A0 589-607 |
| SOL9531-143-17 | 629 | TEN01259 | 3H6-60218-0 589-607 |
| SOL9531-145-15 | 629 | TEN01260 | 3B7-60217-0 589-607 |
| SOL9532-140-19 | 629 | TEN01408 | HZV4-12155-A00 607 |
| SOL9532-140-21 | 629 | TEN01408/1 | HZV5-12155-000 607 |
| SOL9532-140-23 | 629 | TRI305-0386 | 590 |
| SOL9532-143-17 | 629 | TRI305-0566 | 590 |
| SOL9532-145-15 | 629 | | |

RO / OEM --> REF

| R.O. / OEM | REF | R.O. / OEM | REF | R.O. / OEM | REF |
|-------------|------------------|--------------|--------------------|---------------------|--------------------------|
| 101-00121-0 | REC26-803514 | 346-64102-5 | SOL5211-099-10 | 351-00011-0 | REC8M0080357 608-610-619 |
| 172-36008-0 | PAF8-05000003 | 346-64103-5 | SOL5211-099-11 | 351-01005-0 | REC351-01005-0 617 |
| 309-00131-0 | PAT3.6-04000006 | 346-64104-5 | SOL5211-099-13 | 353-06260-0 | REC353-06260-0 601 |
| 309-01005-2 | REC309-01005-2 | 346-65013-0 | REC26-161622 | 353-06260-2 | REC353-06260-0 601 |
| 309-60111-0 | PAF8-04000101 | 346-67114-0 | PAF8-05000018 | 353-76010-4 | PH130-0048 600 |
| 309-64020-0 | REC43-16138 | 346-76010-0M | PH130-0080 | 356-00043-0 | REC31-8130482 611 |
| 309-65021-1 | CEF500396 | 346-87122-0 | REC6H1-W0093-01-00 | 361-64113-0 | SOL5311-122-08 628 |
| 332-00021-0 | PAF8-05020105 | 346-87122-0 | REC6H3-W0093-02 | 361-64114-0 | SOL5311-121-09 628 |
| 332-00021-0 | REC41-825713002 | 348-60217-0 | CM348-60217-0M | 361-64114-0 | SOL5313-118-09 628 |
| 332-00024-0 | PAF8-05020105 | 348-60217-0 | TEN01252 | 362-64101-0 | SOL5111-093-09 628 |
| 332-60005-2 | REC90340-08002 | 348-64102-0 | SOL5311-116-11 | 362-64103-0 | SOL5111-093-08 628 |
| 332-60006-0 | REC90430-08020 | 348-64102-0 | SOL5313-111-11 | 362-64105-0 | SOL5111-093-07 628 |
| 332-62101-0 | PAF4-01010003 | 348-64103-0 | SOL5311-114-12 | 362-64108-0 | SOL5111-093-10 628 |
| 332S62102-1 | REC6L8-G3118-01 | 348-64103-0 | SOL5313-108-12 | 362-64211-0 | REC879147T96 626 |
| 334-00024-1 | REC53-16057 | 350-00001-0 | REC779-803677 | 362-64215-0 | REC43-803741 626 |
| 334-00061-0 | REC8130461 | 350-00001-1 | REC779-803677 | 369-00001-0 | REC779-9615T 608-619 |
| 334-65021-0 | CEF500383 | 350-00011-0 | REC39-803678A1 | 369-00021-0 | REC41-16056 608-619 |
| 336-00040-1 | REC629-813047T01 | 350-00021-0 | REC41-803680002 | 369-00043-0 | REC31-813048 608 |
| 338-00042-0 | REC31-8036752 | 350-00024-1 | PAF15-07020005 | 369-00061-0 | REC813046002 608 |
| 338-60218-2 | CM33860-2181 | 350-00024-1 | REC53-16057 | 608-609-610-619-620 | REC26-16051 608 |
| 338-60218-2 | TEN01250 | 350-00040-0 | REC629-803674 | 369-00132-0 | PAF8-05000024 613 |
| 344-67177-0 | PAGB/T7940.1-M6 | 350-00042-0 | REC31-16052 | 369-01215-0 | REC26-16703 618 |
| 345-00042-0 | REC345-00042-0 | 350-00061-0 | REC803673 | 369-02230-0 | PAF4-05000300 595 |
| 345-00113-0 | REC30-16049T01 | 350-00121-0 | REC26-803667 | 369-03231-0 | REC16253 597 |
| 345-62441-0 | PAF8-01000100 | 350-01005-0 | REC350-01005-0 | 369-03302-0 | REC27-16274 596 |
| 345-65015-0 | PAF8-04040002 | 350-01215-5 | REC8M0065585 | 369-03303-0 | REC16275 596 |
| 345-65021-0 | CEF500382 | 350-01303-0 | REC346-01303-0 | 369-03306-0 | REC16325 596 |
| 345-65021-0 | REC345-65021-0 | 350-01303-0 | REC350-01303-0 | 369-03307-0 | REC27-16326 596 |
| 345-65021-1 | CEF500379 | 350-04005-0 | REC8537312 | 369-06021-0 | REC369-06021-0 598 |
| 345-87122-0 | REC84419M | 350-06401-0 | REC43-803739 | 369-60111-0 | PAF8-04040004 623 |
| 345-87122-4 | REC696-W0093-00 | 350-06401-0 | REC43-803740 | 369-60218-1 | TEN01251 607 |
| 346-00001-1 | REC779-879194T01 | 350-61012-1 | REC350-61012-1 | 369-60223-0 | REC26-16162 618 |
| 346-00011-0 | REC39-16054A5 | 350-62121-1 | PAF8-01010200 | 369-62122-2 | PAF8-01010200 625 |
| 346-00011-0 | REC8M0080349 | 350-62415-0 | PAJASOF40435-022 | 369-62439-1 | PAF8-01010105 625 |
| 346-01005-0 | REC346-01005-0 | 350-62417-0 | PAF8-01000002 | 369-64010-2 | REC43-812944 626 |
| 346-01032-0 | PAF8-05010005 | 350-62423-0 | PAF8-01000001 | 369-64014-0 | PAF8-04000012-1 623 |
| 346-01215-0 | REC26-8537072 | 350-64301-0 | REC45-803738 | 369-64015-0 | PAF8-04000012-2 623 |
| 346-02230-0 | PAF4-05000300 | 350-64302-0 | REC45-8037381 | 369-64030-2 | REC43-8129451 626 |
| 346-60111-0 | REC26-161301 | 350-65011-1 | REC803751 | 369-64032-0 | PAF8-04000012 623 |
| 346-62421-1 | PAF8-01010102 | 350-76010-0 | PH130-0061 | 369-64121-0 | PAF15-06000016 623 |
| 346-64101-5 | SOL5211-099-09 | 351-00001-1 | REC779-803677T02 | 369-64211-1 | REC44-195133 626 |

| R.O. / OEM | REF | | R.O. / OEM | REF | | R.O. / OEM | REF | |
|--------------|-----------------|---------|-------------|------------------|---------|--------------|------------------|---------|
| 369-64223-0 | PAF8-04000305 | 623 | 3B7-65021-2 | REC3B7-65021-2 | 604 | 3R3R76150M | REC5GH-13440-00 | 589-596 |
| 369-64301-0 | REC45-161351 | 626 | 3B7-87121-7 | REC3B7-87121-1 | 617 | 3T5-06920-0 | PAF8-05000011 | 613 |
| 369-64301-0 | REC8M0076368 | 626 | 3C7-60218-2 | TEN01254 | 607 | 3T5-10131-0 | PAF4-04000019 | 615 |
| 369-65011-0 | REC16157 | 605 | 3C7-64536-0 | SOL3411-135-15 | 628 | 3T5-87121-6 | REC3T5-87121-6 | 617 |
| 369-65021-0 | CEF500377 | 589-604 | 3C7-64536-0 | SOL3413-130-15 | 628 | 3T9-01005-0 | REC3T9-01005-0 | 617 |
| 369-65025-0 | REC16159 | 605 | 3C7-64536-0 | SOL3431-135-15 | 628 | 3T9-01032-0 | REC3T9-01032-0 | 604 |
| 369-66112-1 | PAF8-01010104 | 625 | 3C7-64541-0 | SOL3411-133-17 | 628 | 3T9-02104-0 | REC3T9-02104-0 | 621 |
| 369-84398-0 | PAF8-05000025 | 615 | 3C7-64541-0 | SOL3413-128-17 | 628 | 3V1-00001-0 | PAF8-05020101 | 615-620 |
| 369-87122-1 | REC6G1-W0093-00 | 597 | 3C7-64541-0 | SOL3431-133-17 | 628 | 3V1-00011-0 | REC39-8M0055809 | 615 |
| 393-62437-0 | PAF8-01010103 | 625 | 3C7-64554-0 | SOL3411-130-19 | 628 | 3V1-00030-1 | PAF8-05020001 | 615 |
| 394-702500M | GS31015 | 592 | 3C7-64554-0 | SOL3413-125-19 | 628 | 3V1-00040-0 | PAF8-05020200 | 615-620 |
| 398-62103-0 | PAF4-01010002 | 625 | 3C7-64554-0 | SOL3431-130-19 | 628 | 3V1-00121-0 | PAF8-05010012 | 615 |
| 3A0-06040-1 | REC3A0-06040-1 | 599 | 3C7-65021-1 | CEF500388 | 604 | 3V1-01024-0 | PAF8-05000002 | 615 |
| 3A0-76079-0 | PAF8-05000006 | 613 | 3C7760-2181 | CM3C760-2181 | 606 | 3V1-01303-0 | PAF8-00000004 | 615 |
| 3A106-2402M | REC3A106-2602M | 601 | 3C7760-2181 | CM3C760-2181A | 606 | 3V1-02010-1 | PAF8-05000008 | 615 |
| 3A106-2601M | REC3A106-2602M | 601 | 3C8-00001-3 | REC779-96152 | 620 | 3V1-02011-0 | PAF15-07000017 | 615 |
| 3A106-2602M | REC3A106-2602M | 601 | 3C8-00001-3 | REC779-9615T | 612 | 3V1-02104-0 | PAF8-05000009 | 615 |
| 3AA-05004-0 | PAF8-05050004 | 616 | 3C8-00021-0 | REC41-16056 | 612 | 3V1-02305-0 | PAF8-05000100 | 615 |
| 3AA-05013-0 | PAF8-05050018 | 616 | 3C8-00021-0 | REC41-803680003 | 611-620 | 3V1-02305-0 | PAF8-05010004 | 615 |
| 3AA-05019-0 | PAF4-04130101 | 616 | 3C8-00113-0 | REC31-855553 | 612 | 3V1-03952-0 | PAF15-07000018 | 615 |
| 3AA-06021-0 | PAF8-05000300 | 598-613 | 3C8-01005-4 | REC3C8-01005-4 | 617 | 3V1-05104-1 | PAF8-05050005 | 616 |
| 3AA-06060-0 | PAF8-05000400 | 613 | 3C8-01024-0 | REC3C8-01024-0 | 617 | 3V1-05259-0 | PAF8-05050002 | 616 |
| 3AA-06060-00 | PAF8-05000400 | 601 | 3C8-01303-4 | REC3C8-01303-4 | 618 | 3V1-06023-0 | PAF8-05090000W | 599 |
| 3AA060600M | PAF8-05000400 | 601 | 3C8-02104-0 | REC3C8-02104-0 | 621 | 3V1-06040-0 | PAF8-05000500 | 599-613 |
| 3AA-06091-0 | PAF8-05000600 | 613 | 3C8-02305-0 | REC3C8-02305-0 | 621 | 3V1060400 | PAF8-05000500 | 599 |
| 3AA-07203-0 | PAF8-05030005 | 615 | 3C8-03125-0 | REC162532 | 597 | 3V1060400M | PAF8-05000500 | 599 |
| 3AA-07225-0 | PAF8-05030009 | 615 | 3C8-04028-0 | REC27-8555691 | 596 | 3V1-06071-0 | PAF8-05000200 | 599-613 |
| 3AA760100 | PH130-0061 | 600 | 3C8-60217-1 | CM3C8-60217-0 | 606 | 3V1-06302-0 | PAF8-05000013 | 616 |
| 3AC-02230-0 | PAF15-07080000 | 594 | 3C8-60217-1 | TEN01253 | 589-607 | 3V1-06308-0 | PAF8-05000012 | 616 |
| 3AD-02230-0 | PAF15-07080000 | 594 | 3C8-62104-1 | PAF4-01010005 | 625 | 3V1-07010-0 | PAF8-05030008 | 615 |
| 3B1-66145-0 | PAF8-03010007 | 623 | 3C8-66116-0 | PAF8-03010006 | 623 | 3V1-07201-0 | PAF8-05030001 | 615 |
| 3B2-00001-0 | REC779-804886 | 609-619 | 3C8-76010-1 | PH130-0006 | 600 | 3V1-07202-0 | PAF8-05030002 | 615 |
| 3B2-00011-0 | REC39-803678A3 | 609-619 | 3C8-76010-1 | PH130-0006 | 600 | 3V1-07205-0 | PAF8-05030004 | 615 |
| 3B2-00021-0 | REC41-8036801 | 609-619 | 3C8760101M | PH130-0006 | 600 | 3V1-07221-0 | PAF8-05030006 | 615 |
| 3B2-00040-0 | REC629-8036741 | 609-619 | 3E3-64528-0 | SOL5311-111-13 | 628 | 3V1-07235-0 | PAF8-05030200 | 615 |
| 3B2-00051-0 | REC26-85370711 | 609 | 3E3-64528-0 | SOL5313-105-13 | 628 | 3V1-07407-0 | PAF8-05010009 | 615 |
| 3B2-01005-0 | REC3B2-01005-0 | 617 | 3E3-64536-0 | SOL5311-110-15 | 628 | 3V1-07410-0 | PAF8-05000800 | 615 |
| 3B2-01215-0 | PAF8-02000002 | 625 | 3E3-64536-0 | SOL5311-111-14 | 628 | 3V1-07421-0 | PAF8-00000200 | 615 |
| 3B2-01303-0 | REC3B2-01303-0 | 618 | 3E3-64536-0 | SOL5313-105-14 | 628 | 3V1-07440-0 | PAF8-02000003 | 625 |
| 3B2-63600-1 | REC804898 | 603 | 3F0-06060-0 | REC3F0-06060-0 | 601 | 3V1-07600-0 | PAF8-05030300 | 615 |
| 3B2-64010-0 | PAF8-04010000 | 623-626 | 3F0-65029-6 | REC3F0-65029-6 | 605 | 3V1-07653-0 | PAF8-05030012 | 615 |
| 3B2-64020-0 | PAF8-04000003 | 623-626 | 3F0-87122-2 | REC6A1-W0093-01 | 597 | 3V1-10045-0 | PAF8-05000004 | 589-615 |
| 3B2-64023-0 | PAF8-04000004-1 | 623 | 3F3-01005-0 | REC3F3-01005-0 | 617 | 3V1-10060-0 | PAF8-05010014 | 615 |
| 3B2-64030-0 | PAF8-04000014 | 623-626 | 3F3-01024-0 | REC3F3-01024-0 | 617 | 3V1-10063-0 | PAF8-05010015 | 615 |
| 3B2-64215-0 | PAF8-04000303 | 623-626 | 3F3-01303-1 | REC3F3-01303-1 | 618 | 3V1-10068-0 | PAF8-05010016 | 615 |
| 3B2-64230-1 | PAF8-04000019 | 623 | 3F3-02104-0 | REC3F3-02104-0 | 621 | 3V1-60041-0 | PAF8-04000016 | 623 |
| 3B2-64513-0 | SOL5011-085-07 | 628 | 3F3-02305-1 | REC3F3-02305-1 | 604 | 3V1-60042-0 | PAF8-04000015 | 623 |
| 3B2-64515-0 | SOL5011-085-08 | 628 | 3F3-87122-1 | REC6H4-W0093-03 | 597 | 3V1-60211-0 | PANSKFJ-1516 | 623 |
| 3B2-64517-0 | SOL5011-085-09 | 628 | 3G2-06040-2 | REC3G2-06040-2 | 599 | 3V1-61208-0 | PAF8-02000005 | 625 |
| 3B2-65011-0 | PAF8-04000010 | 605-623 | 3G2-06060-2 | REC3G2-06060-2 | 601 | 3V1-61220-0 | PAF8-02000004 | 625 |
| 3B2-65016-0 | PAF8-04000009 | 623 | 3G2-87122-2 | REC6L2-W0093-00 | 597 | 3V1-61301-1 | PAF8-02000100 | 625 |
| 3B2-65016-0 | PAF8-04000013 | 623 | 3G3-06021-1 | REC3G3-06021-1 | 598 | 3V1-61302-0 | PAF8-00000002 | 625 |
| 3B2-65018-0 | PAF8-04000008 | 623 | 3H6-07223-0 | PAF8-05030007 | 615 | 3V1-61313-0 | PAF8-01000003 | 625 |
| 3B2-65020-0 | PAF8-04000005 | 623 | 3H6-07611-0 | PAF15-07010100 | 598-613 | 3V1-61324-0 | PAGB/T889.1-M8 | 625 |
| 3B2-65021-1 | CEF500344 | 589-604 | 3H6-07612-0 | PAF15-07010101 | 613 | 3V1-61333-1 | PAF8-00000100 | 625 |
| 3B2-65021-1 | PAF8-04000200 | 623 | 3H6-60218-0 | CM3H6-60218-000 | 606 | 3V1-63508-0 | PAF8-05000020 | 623 |
| 3B2-65021-1 | REC3B2-65021-1 | 604 | 3H6-60218-0 | CM3H6-60218-000A | 606 | 3V1-63622-0 | PAF8-05000019 | 623 |
| 3B2-65022-0 | PAF8-04000021 | 623 | 3H6-60218-0 | TEN01259 | 589-607 | 3V1-64211-0 | PAF8-04000301 | 623-626 |
| 3B2-65025-0 | PAF8-04000007 | 605-623 | 3H8-02093-0 | PAF8-05010002 | 615 | 3V1-64221-0 | PAF8-04000302 | 623 |
| 3B2-65029-0 | PAF8-04000006 | 623 | 3H8-07025-0 | PAF8-05030011 | 615 | 3V1-64306-1 | PAF8-04020001S | 623-626 |
| 3B2-66113-0 | PAF8-03010005 | 623 | 3H8-07226-0 | PAF8-005030010 | 615 | 3V1-64307-1 | PAF8-04020001L | 623-626 |
| 3B2-66315-0 | PAF8-01010109 | 625 | 3H8-07237-0 | PAF15-07040304 | 615 | 3V1-65100-0 | PAF8-02000006(S) | 625 |
| 3B2-66321-1 | PAF8-01010108 | 625 | 3H8-10062-2 | PAF8-05030400 | 615 | 3V1-65110-0 | PAF8-02000006(L) | 625 |
| 3B2-702501M | GS31088 | 591 | 3H8-640100 | REC43-803739T03 | 626 | 3V1-65203-0 | PAF8-02000009 | 625 |
| 3B2-702601M | GS31018 | 592 | 3H8-64020-0 | REC43-803740T02 | 626 | 3V1-65206-0 | PAF8-02000007 | 625 |
| 3B2-702801M | GS31016 | 592 | 3H8-64030-0 | REC43-803741T03 | 626 | 3V1-66187-0 | PAF8-03001001 | 623 |
| 3B2-87122-0 | REC6G1-W0093-00 | 597 | 3K9-05223-0 | PAF8-01010112 | 625 | 3V1-66211-0 | PAF8-03000010 | 623 |
| 3B2S60100-0 | PAF8-04040000 | 623 | 3M2-60218-0 | CM3M2-60218-1 | 606 | 3V1-66225-0 | PAF8-03010003 | 623 |
| 3B2S60101-0 | PAF8-04040001 | 623 | 3M2-60218-0 | TEN01257 | 607 | 3V1-66302-0 | PAF8-03000011 | 623 |
| 3B2W64517-0 | PAF8-04050000 | 623 | 3R0-07238-0 | PAF15-07040303 | 615 | 3V1-66313-0 | PAF8-01010106 | 625 |
| 3B7-02230-0 | PAF15-07080000 | 594 | 3R0-66308-0 | PAF8-05000021 | 613 | 3V1-87122-0 | REC66M-W0093-01 | 597 |
| 3B7-06305-0 | PAF8-05000007 | 613 | 3R1-05003-1 | PAF8-05050006 | 616 | 3V1602170 | CM3V1-60217-0A | 606 |
| 3B7-60217-0 | CM3B7-602170 | 606 | 3R1-05007-0 | PAF8-05050009 | 616 | 3V1602170 | CM3V1-60217-0A | 606 |
| 3B7-60217-0 | TEN01255 | 607 | 3R1-05012-0 | PAF8-05050007 | 616 | 3V1B01001-0 | PAF8-05030100 | 615 |
| 3B7-60217-0 | TEN01260 | 589-607 | 3R1-05125-0 | PAF8-05050003 | 616 | 3V1B01100-0 | PAF8-05010000 | 615 |
| 3B7-60218-1 | CM3B7-60218-0 | 606 | 3R1-05131-0 | PAF4-04130102 | 616 | 3V2-03100-2 | PAF8-05040000 | 596 |
| 3B7-60218-1 | TEN01256 | 589-607 | 3R3-01030-0 | REC855676002 | 589-603 | 3Y7-02234-0 | REC35-802893Q01 | 592 |
| 3B7-64523-1 | SOL3411-140-11 | 628 | 3R3-07227-0 | PAF8-05030015 | 615 | 5GH-13440-00 | REC5GH-13440-00 | 596 |
| 3B7-64527-1 | SOL3411-138-13 | 628 | 3R3-07405-1 | PAF15-04000002 | 625 | 5338602182A0 | CM5338602182A0 | 606 |
| 3B7-64527-1 | SOL3413-133-13 | 628 | 3R3-07406-0 | PAF15-04000003 | 625 | 5338602182A0 | CM5338602182A0A | 606 |
| 3B7-65021-2 | CEF500388 | 604 | 3R3-61017-0 | PAF8-00000003 | 615 | 5338602182A0 | TEN01258 | 589-607 |

| R.O. / OEM | REF | |
|-----------------|--------------------|---------|
| 646-24251-02 | REC35-80365M | 595 |
| 910113-0830 | PAGB/T5783-M8X30 | 625 |
| 910184-5620 | PAGB/T5783-M6X20 | 625 |
| 910184-5620 | PAGB/T97.1-6 | 625 |
| 940113-0800 | PAF8-02000100 | 625 |
| 940121-1200 | PAT15-04000011 | 613 |
| 945303-0500 | PAGB/T896-5 | 625 |
| 9603-3-6204 | REC30-16049 | 608-609 |
| 9643-3-6004 | REC30-898101936 | 619 |
| 96603-3-6305 | REC30-160494 | 610 |
| 9701-1-1005 | NGKB7HS-10 | 600 |
| 9701-1-1006 | NGKB8HS-10 | 600 |
| 9701-1-1010 | NGKBP7HS-10 | 600 |
| 9701-1-1013 | NGKBPR6HS-10 | 600 |
| 9701-1-1014 | NGKBPR7HS-10 | 600 |
| 9701-1-1015 | NGKBR7HS-10 | 600 |
| 9701-1-1103 | NGKDCPR6E | 589-600 |
| 9701-1-1110 | NGKBR8HS-10 | 600 |
| 9701-1-1111 | NGKIZFR6 | 600 |
| 9701-1-1121 | NGKIKR6G8 | 600 |
| 9791-1-1109 | NGKIZFR5J | 600 |
| 98AB-5-0330 | PAF8-05000024 | 615 |
| 98AH10-0120 | PAF8-05000017 | 615 |
| 990A0-01E81-01Q | REC80W90U3 | 595 |
| 990A0-01E81-01Q | REC80W90U6 | 595 |
| 990C0-10W40-GLN | REC10W40U3 | 595 |
| 990C0-10W40-GLN | REC10W40U6 | 595 |
| 99998-OMA2 | GS31019 | 591 |
| HPLM-15400-PE | REC15400-PLM-A01PE | 596 |
| HPNB-37510-003 | REC37510-PNB-003 | 598 |
| HZV4-12155-A00 | TEN01408 | 607 |
| HZV4-30580-013 | REC30580-ZV4-013 | 599 |
| HZV5-12155-000 | TEN01408/1 | 607 |
| HZV5-19210-003 | CEF500338 | 604 |
| HZV5-19210-003 | REC19210-ZV5-003 | 604 |
| HZV5-19300-043 | REC19300-ZV5-043 | 603 |
| HZW1-19210-B04 | CEF500337 | 604 |
| HZW1-19210-B04 | REC19210-ZW1-B02 | 604 |
| HZW9-19300-003 | PAF15-07000031 | 603 |
| HZY3-06192-000 | REC06192-ZY3-000 | 605 |
| HZY3-16911-010 | REC16911-ZY3-010 | 595 |
| HZY3-19210-003 | CEF500391 | 604 |
| HZY3-19210-003 | REC19210-ZY3-003 | 604 |
| HZY3-31200-003 | PH130-0070 | 601 |
| HZY6-06192-000 | REC06192-ZY6-000 | 605 |
| HZY6-17109-000 | REC17109-ZY6-000 | 621 |
| HZY6-31200-003 | REC31200-ZY6-003 | 601 |
| HZY6-35668-003 | REC35668-ZY6-003 | 598 |
| HZZ3-31909-003 | NGKLMAR6C-9 | 600 |
| HZZ5-16911-003 | REC16911-ZZ5-003 | 595 |

SELVA

ES

| | |
|---|-----|
| GUÍA MANTENIMIENTO | 636 |
| SISTEMA DE REFRIGERACIÓN | 638 |
| ÁNODOS | 638 |
| ÁNODO CANADA METAL | 638 |
| ÁNODO TECNOSEAL | 639 |
| IMPULSORES | 640 |
| GUÍA IMPULSORES | 640 |
| SISTEMA DE PROPULSIÓN | 641 |
| HÉLICES ALUMINIO E INOXIDABLE DE 3 Y 4 PALAS | 641 |
| GUÍA HÉLICES CON NÚCLEO INTEGRADO | 642 |
| REF --> RO | 643 |
| RO --> REF | 643 |

IT

| | |
|--|-----|
| GUIDA MANUTENZIONE | 636 |
| SISTEMA DI RAFFREDDAMENTO | 638 |
| ANODI | 638 |
| ANODI CANADA METAL | 638 |
| ANODI TECNOSEAL | 639 |
| GIRANTE | 640 |
| GUIDA GIRANTE | 640 |
| SISTEMA DI PROPULSIONE | 641 |
| ELICHE ALLUMINIO E INOX DA 2 E 4 PALE | 641 |
| GUIDA ELICHE CON MOZZO | 642 |
| REF --> RO | 643 |
| RO --> REF | 643 |

EN

| | |
|--|-----|
| MAINTENANCE GUIDE | 636 |
| COOLING SYSTEM | 638 |
| ANODES | 638 |
| ANODES CANADA METAL | 638 |
| ANODES TECNOSEAL | 639 |
| IMPELLERS | 640 |
| IMPELLERS GUIDE | 640 |
| PROPULSION SYSTEM | 641 |
| 3 & 4 BLADE ALUMINIUM & SS PROPELLERS | 641 |
| PROPELLERS APPLICATION WITH RUBBER HUB | 642 |
| REF --> OEM | 643 |
| OEM --> REF | 643 |

FR

| | |
|--|-----|
| GUIDE MAINTENANCE KITS | 636 |
| SYSTÈME DE REFROIDISSEMENT | 638 |
| ANODES | 638 |
| ANODE CANADA METAL | 638 |
| ANODE TECNOSEAL | 639 |
| TURBINES | 640 |
| GUIDE DE TURBINES | 640 |
| SYSTEME DE PROPULSION | 641 |
| HÉLICE ALUMINIUM ET INOX 3 ET 4 PALES | 641 |
| GUIDE DES HÉLICES ET MOYEURS | 642 |
| REF --> RO | 643 |
| RO --> REF | 643 |

GUÍA
MANTENIMIENTO

MAINTENANCE
GUIDE

GUIDA
MANUTENZIONE

GUIDE
MAINTENANCE



REF

| | | | | | | |
|--|-----------------|-----------------------|------------------|-----------------------|--------------------------|--------|
| RAY8 | NGKBR6HS-10 | BUJÍA | SPARK PLUG | CANDELE | BOUGIE | 2 |
| | CM6G8-11325-00 | ÁNODO | ANODE | ANODO | ANODE | 1 |
| | CM68T-45251-00 | ÁNODO | ANODE | ANODO | ANODE | 1 |
| | REC68T-44352-00 | TURBINA | IMPELLER | GIRANTE | TURBINE | 1 |
| | REC68T-24251-00 | FILTRO COMBUSTIBLE | FUEL FILTER | FILTRO COMBUSTIBILE | FILTRE À ESSENCE | 1 |
| | PAF15-07000031 | TERMOSTATO | THERMOSTAT | TERMOSTATO | TERMOSTAT | 1 |
| | REC68T-46241-00 | CORREA DISTRIBIBUCIÓN | TIMING BELT | CINGHIE DISTRIBUZIONE | COURROIE DE DISTRIBUTION | 1 |
| PIKE 9.9 | NGKBR6HS-10 | BUJÍA | SPARK PLUG | CANDELE | BOUGIE | 2 |
| | CM6G8-11325-00 | ÁNODO | ANODE | ANODO | ANODE | 1 |
| | CM68T-45251-00 | ÁNODO | ANODE | ANODO | ANODE | 1 |
| | REC68T-44352-00 | TURBINA | IMPELLER | GIRANTE | TURBINE | 1 |
| | REC68T-24251-00 | FILTRO COMBUSTIBLE | FUEL FILTER | FILTRO COMBUSTIBILE | FILTRE À ESSENCE | 1 |
| | PAF15-07000031 | TERMOSTATO | THERMOSTAT | TERMOSTATO | TERMOSTAT | 1 |
| | REC68T-46241-00 | CORREA DISTRIBIBUCIÓN | TIMING BELT | CINGHIE DISTRIBUZIONE | COURROIE DE DISTRIBUTION | 1 |
| WAHOO 15/20 | NGKDPR6EB-9 | BUJÍA | SPARK PLUG | CANDELE | BOUGIE | 2 |
| | CM6G8-11325-00 | ÁNODO | ANODE | ANODO | ANODE | 4 |
| | CM15026 | ÁNODO | ANODE | ANODO | ANODE | 1 |
| | TEN01123 | ÁNODO | ANODE | ANODO | ANODE | 1 |
| | TEN01154AL | ÁNODO | ANODE | ANODO | ANODE | 1 |
| | REC63V-44352-01 | TURBINA | IMPELLER | GIRANTE | TURBINE | 1 |
| | REC61N-24563-10 | FILTRO COMBUSTIBLE | FUEL FILTER | FILTRO COMBUSTIBILE | FILTRE À ESSENCE | 1 |
| | REC5GH-13440-60 | FILTRO DE ACEITE | OIL FILTER | FILTRO OLIO | FILTRE A HUILE | 1 |
| | REC6AH-12411-00 | TERMOSTATO | THERMOSTAT | TERMOSTATO | TERMOSTAT | 1 |
| | PAF20-05000003 | CORREA DISTRIBIBUCIÓN | TIMING BELT | CINGHIE DISTRIBUZIONE | COURROIE DE DISTRIBUTION | 1 |
| KINGFISH 25 | NGKDPR6EB-9 | BUJÍA | SPARK PLUG | CANDELE | BOUGIE | 2 |
| | CM6G8-11325-00 | ÁNODO | ANODE | ANODO | ANODE | 1 |
| | CM6BL-11325-00 | ÁNODO | ANODE | ANODO | ANODE | 2 |
| | CM6E0-45251-11A | ÁNODO | ANODE | ANODO | ANODE | 1 |
| | CM62Y-11325-00 | ÁNODO | ANODE | ANODO | ANODE | 1 |
| | CM61N-45251-01 | ÁNODO | ANODE | ANODO | ANODE | 1 |
| | PAF25-04000021 | ANODO TAB,TRIM | ANODE TAB,TRIM | ANODO TAB,TRIM | ANODE TAB,TRIM | 1 |
| | REC6H4-44352-02 | TURBINA | IMPELLER | GIRANTE | TURBINE | 1 |
| | REC61N-24563-10 | FILTRO COMBUSTIBLE | FUEL FILTER | FILTRO COMBUSTIBILE | FILTRE À ESSENCE | 1 |
| | REC5GH-13440-60 | FILTRO DE ACEITE | OIL FILTER | FILTRO OLIO | FILTRE A HUILE | 1 |
| | PAF15-07000031 | TERMOSTATO | THERMOSTAT | TERMOSTATO | TERMOSTAT | 1 |
| | REC6C5-46241-00 | CORREA DISTRIBIBUCIÓN | TIMING BELT | CINGHIE DISTRIBUZIONE | COURROIE DE DISTRIBUTION | 1 |
| | ARUANA EFI 40 | NGKDPR6EB-9 | BUJÍA | SPARK PLUG | CANDELE | BOUGIE |
| CM6G8-11325-00 | | ÁNODO | ANODE | ANODO | ANODE | 4 |
| CM688-45251-01 | | ANODO (Modelos S) | ANODE (S Models) | ANODO (Modelli S) | ANODE (Modèles S) | 1 |
| CM6E0-45251-11A | | ÁNODO | ANODE | ANODO | ANODE | 1 |
| CM67C-45371-00 | | ÁNODO | ANODE | ANODO | ANODE | 1 |
| CM67C-45251-00 | | ÁNODO | ANODE | ANODO | ANODE | 1 |
| CM62Y-11325-00 | | ÁNODO | ANODE | ANODO | ANODE | 1 |
| REC6H4-44352-02 | | TURBINA | IMPELLER | GIRANTE | TURBINE | 1 |
| REC6D8-WS24A-00 | | FILTRO COMBUSTIBLE | FUEL FILTER | FILTRO COMBUSTIBILE | FILTRE À ESSENCE | 1 |
| REC5GH-13440-60 | | FILTRO DE ACEITE | OIL FILTER | FILTRO OLIO | FILTRE A HUILE | 1 |
| PAF15-07000031 | | TERMOSTATO | THERMOSTAT | TERMOSTATO | TERMOSTAT | 1 |
| REC6C5-46241-00 | | CORREA DISTRIBIBUCIÓN | TIMING BELT | CINGHIE DISTRIBUZIONE | COURROIE DE DISTRIBUTION | 1 |
| DORADO EFI 40XS-XRS, 50 /60 XS&XSR | NGKDPR6EB-9 | BUJÍA | SPARK PLUG | CANDELE | BOUGIE | 4 |
| | PAF15-07000031 | ÁNODO | ANODE | ANODO | ANODE | 1 |
| | CM62Y-11325-00 | ÁNODO | ANODE | ANODO | ANODE | 1 |
| | CM6G8-11325-00 | ÁNODO | ANODE | ANODO | ANODE | 4 |
| | CM6E0-45251-11A | ÁNODO | ANODE | ANODO | ANODE | 3 |
| | CM67C-45371-00 | ÁNODO | ANODE | ANODO | ANODE | 1 |
| | CM67C-45251-00 | ÁNODO | ANODE | ANODO | ANODE | 1 |
| | REC6H3-44352-00 | TURBINA | IMPELLER | GIRANTE | TURBINE | 1 |
| | REC6D8-WS24A-00 | FILTRO COMBUSTIBLE | FUEL FILTER | FILTRO COMBUSTIBILE | FILTRE À ESSENCE | 1 |
| | REC5GH-13440-60 | FILTRO DE ACEITE | OIL FILTER | FILTRO OLIO | FILTRE A HUILE | 1 |
| | PAF15-07000031 | TERMOSTATO | THERMOSTAT | TERMOSTATO | TERMOSTAT | 1 |
| | REC6C5-46241-00 | CORREA DISTRIBIBUCIÓN | TIMING BELT | CINGHIE DISTRIBUZIONE | COURROIE DE DISTRIBUTION | 1 |



REF

| | | | | | | |
|---------------------------------|-----------------------|--------------------|-----------------------|--------------------------|-------------------|---|
| MURENA EFI 40XSR/ 70 | NGKLR7E | BUJÍA | SPARK PLUG | CANDELE | BOUGIE | 4 |
| | CM62Y-11325-00 | ÁNODO | ANODE | ANODO | ANODE | 1 |
| | CM6G8-11325-00 | ÁNODO | ANODE | ANODO | ANODE | 3 |
| | CM6E0-45251-11A | ÁNODO | ANODE | ANODO | ANODE | 3 |
| | CM67F-45371-00 | ANODO TAB,TRIM | ANODE TAB,TRIM | ANODO TAB,TRIM | ANODE TAB,TRIM | 1 |
| | REC6H3-44352-00 | TURBINA | IMPELLER | GIRANTE | TURBINE | 1 |
| | REC6D8-WS24A-00 | FILTRO COMBUSTIBLE | FUEL FILTER | FILTRO COMBUSTIBILE | FILTRE À ESSENCE | 1 |
| | REC5GH-13440-60 | FILTRO DE ACEITE | OIL FILTER | FILTRO OLIO | FILTRE A HUILE | 1 |
| | PAF15-07000031 | TERMOSTATO | THERMOSTAT | TERMOSTATO | TERMOSTAT | 1 |
| REC6C5-46241-00 | CORREA DISTRIBIBUCIÓN | TIMING BELT | CINGHIE DISTRIBUZIONE | COURROIE DE DISTRIBUTION | 1 | |
| MARLIN EFI 100/ 100XSR | NGKLR5A-11 | BUJÍA | SPARK PLUG | CANDELE | BOUGIE | 4 |
| | CM15026 | ÁNODO | ANODE | ANODO | ANODE | 3 |
| | CM67F-11325-01 | ÁNODO | ANODE | ANODO | ANODE | 2 |
| | CM6H1-45251-02 | ÁNODO | ANODE | ANODO | ANODE | 1 |
| | CM67F-45371-00 | ANODO TAB,TRIM | ANODE TAB,TRIM | ANODO TAB,TRIM | ANODE TAB,TRIM | 1 |
| | REC67F-44352-00 | TURBINA | IMPELLER | GIRANTE | TURBINE | 1 |
| | REC6D8-WS24A-00 | FILTRO COMBUSTIBLE | FUEL FILTER | FILTRO COMBUSTIBILE | FILTRE À ESSENCE | 1 |
| | REC5GH-13440-00 | FILTRO DE ACEITE | OIL FILTER | FILTRO OLIO | FILTRE A HUILE | 1 |
| | REC6D9-12411-00 | TERMOSTATO | THERMOSTAT | TERMOSTATO | TERMOSTAT | 1 |
| REC67F-46241-00 | CORREA DISTRIBIBUCIÓN | TIMING BELT | CINGHIE DISTRIBUZIONE | COURROIE DE DISTRIBUTION | 1 | |
| TARPON EFI 115/ 115XSR | NGKLR6A-11 | BUJÍA | SPARK PLUG | CANDELE | BOUGIE | 4 |
| | CM15026 | ÁNODO | ANODE | ANODO | ANODE | 3 |
| | CM67F-11325-01 | ÁNODO | ANODE | ANODO | ANODE | 2 |
| | CM6G5-45251-01A | ÁNODO | ANODE | ANODO | ANODE | 1 |
| | CM6E5-45371-01A | ANODO TAB,TRIM | ANODE TAB,TRIM | ANODO TAB,TRIM | ANODE TAB,TRIM | 1 |
| | REC6E5-44352-01 | TURBINA | IMPELLER | GIRANTE | TURBINE | 1 |
| | REC6D8-WS24A-00 | FILTRO COMBUSTIBLE | FUEL FILTER | FILTRO COMBUSTIBILE | FILTRE À ESSENCE | 1 |
| | REC5GH-13440-00 | FILTRO DE ACEITE | OIL FILTER | FILTRO OLIO | FILTRE A HUILE | 1 |
| | REC60V-12411-00 | TERMOSTATO | THERMOSTAT | TERMOSTATO | TERMOSTAT | 1 |
| REC67F-46241-00 | CORREA DISTRIBIBUCIÓN | TIMING BELT | CINGHIE DISTRIBUZIONE | COURROIE DE DISTRIBUTION | 1 | |
| KILLER WHALE EFI 150/ 150XSR | NGKLR5A-11 | BUJÍA | SPARK PLUG | CANDELE | BOUGIE | 4 |
| | TEN01165 | ÁNODO | ANODE | ANODO | ANODE | 1 |
| | CM63P-11325-01 | ÁNODO | ANODE | ANODO | ANODE | 1 |
| | CM68T-11325-00 | ÁNODO | ANODE | ANODO | ANODE | 8 |
| | CM63P-11325-11 | ÁNODO | ANODE | ANODO | ANODE | 4 |
| | CM6G5-45251-01A | ÁNODO | ANODE | ANODO | ANODE | 1 |
| | CM67F-11325-01 | ÁNODO | ANODE | ANODO | ANODE | 2 |
| | CM6J9-45371-01 | ANODO TAB,TRIM R | ANODE TAB,TRIM R | ANODO TAB,TRIM R | ANODE TAB, TRIM R | 1 |
| | CM6K1-45371-02 | ANODO TAB,TRIM L | ANODE TAB,TRIM L | ANODO TAB,TRIM L | ANODE TAB, TRIM L | 1 |
| | REC6E5-44352-01 | TURBINA | IMPELLER | GIRANTE | TURBINE | 1 |
| | REC6P3-WS24A-00 | FILTRO COMBUSTIBLE | FUEL FILTER | FILTRO COMBUSTIBILE | FILTRE À ESSENCE | 1 |
| | REC35-822626Q15 | FILTRO DE ACEITE | OIL FILTER | FILTRO OLIO | FILTRE A HUILE | 1 |
| | REC67F-12411-01 | TERMOSTATO | THERMOSTAT | TERMOSTATO | TERMOSTAT | 1 |
| REC63P-46241-00 | CORREA DISTRIBIBUCIÓN | TIMING BELT | CINGHIE DISTRIBUZIONE | COURROIE DE DISTRIBUTION | 1 | |

SISTEMA DE REFRIGERACIÓN COOLING SYSTEM

SISTEMA DI RAFFREDDAMENTO SYSTÈME DE REFROIDISSEMENT



ÁNODO

ANODE

ANODI

ANODE

| ZN | (KG) | AL | (KG) | OEM |
|---------------|------|----------------|------|-------------|
| CM55321-94900 | 0,51 | CM55321-94900A | 0,11 | 55320-94900 |

70, 90, 115, 140, 150 HP

| ZN | (KG) | OEM |
|---------------|------|-------------|
| CM55320-98400 | 0,05 | 41811-98400 |

9.9 - 15 HP

| ZN | (KG) | OEM |
|-----------|------|---------|
| CM2504015 | 0,39 | 2504015 |

40 - 100 HP

| ZN | (KG) | OEM |
|---------------|------|-------------|
| CM41811-98500 | 0,05 | 41811-98500 |

2.2 - 4 HP

| ZN | (KG) | OEM |
|-----------|------|---------|
| CM9005665 | 0,11 | 9005665 |

40 - 100 HP

| ZN | (KG) | OEM |
|----------------|------|---------------|
| CM67C-45251-00 | 0,12 | 58.67C4525100 |

| ZN | (KG) | OEM |
|-----------|------|---------|
| CM2500010 | 0,10 | 2500010 |

6 - 8 - 9.9 - 15 HP

| ZN | (KG) | OEM |
|-----------|------|---------|
| CM2500065 | 0,10 | 2500065 |

25 - 40 HP

| ZN | (KG) | OEM |
|-----------|------|---------|
| CM9005655 | 0,03 | 9005655 |

| ZN | (KG) | OEM |
|-----------|------|---------|
| CM2500050 | 0,17 | 2500050 |

BEST 800 - S1000

| ZN | (KG) | OEM |
|-----------|------|---------|
| CM9005660 | 0,03 | 9005660 |

| ZN | (KG) | OEM |
|---------------|------|-------------|
| CM55300-95500 | 0,08 | 55300-95500 |

2 - 8 HP

SELVA

RECAMBIOS
MARINOS

| ZN | KG (kg) | OEM |
|----------|------------|----------|
| CM82795M | 0,20 | 25040151 |

25 - 30 HP



| ZN | KG (kg) | OEM |
|-----------|------------|----------------------------|
| CM2504020 | 0,21 | 405 - 700 |
| CM2504025 | 0,31 | 100 hp |
| CM2504035 | 0,10 | 80 HP IZMIR 15 HP NAXOS |



ÁNODO ANODE ANODI ANODE

| ZN | KG (kg) | OEM |
|----------|------------|-----|
| TEN01914 | 0,07 | |

80 - 100 HP



| ZN | KG (kg) | OEM |
|----------|------------|---------|
| TEN01902 | 0,10 | 2500010 |

Serie 6 8 - 9.9 - 15 HP



| ZN | KG (kg) | OEM |
|----------|------------|-----|
| TEN01915 | 0,10 | |



| ZN | KG (kg) | OEM |
|----------|------------|---------|
| TEN01903 | 0,20 | 2500050 |

Serie BEST 800 - S1000



| ZN | KG (kg) | OEM |
|----------|------------|-------------|
| TEN01916 | 0,12 | 3C8-60217-1 |



| ZN | KG (kg) | OEM |
|----------|------------|---------|
| TEN01904 | 0,10 | 2504030 |

Serie 6 HP



| ZN | KG (kg) | OEM |
|----------|------------|---------|
| TEN01900 | 0,03 | 9005655 |

Serie PIATTA FB



| ZN | KG (kg) | OEM |
|----------|------------|---------|
| TEN01905 | 0,14 | 9005665 |



| ZN | KG (kg) | OEM |
|----------|------------|---------|
| TEN01901 | 0,03 | 9005660 |

Serie CURVA FB



| ZN | KG (kg) | OEM |
|----------|------------|---------|
| TEN01909 | 0,40 | 2504015 |



| ZN | KG (kg) | OEM |
|----------|------------|---------|
| TEN01906 | 0,07 | 2500065 |

Serie 25 - 40 HP



| ZN | (KG) | OEM |
|----------|------|---------|
| TEN01907 | 0,14 | 2504025 |

Serie 100 HP



| ZN | (KG) | OEM |
|----------|------|---------|
| TEN01912 | 0,10 | 2504035 |

Serie IZMIR 8 CV - NAXOS 15 CV



| ZN | (KG) | OEM |
|----------|------|---------|
| TEN01908 | 0,21 | 2504020 |

Serie S405 - S700



| ZN | (KG) |
|----------|------|
| TEN01913 | 0,22 |

Serie MANTA BARRACUDA



IMPULSORES IMPELLERS GIRANTE TURBINES

GUÍA DE IMPULSORES IMPELLER GUIDE GUIDA GIRANTE GUIDE DES TURBINES

| | 2T STROKES | 4T STROKES | REF | CEF | A (mm) | B (mm) | C (mm) |
|-----------------------------|---------------|---------------|-----------------|------------|-----------|-----------|-----------|
| 2.5 | | ✓ | | CEF500376 | 12,2 | 48,5 | 15 |
| 3.5, 4 | ✓ | | | CEF500376 | 12,2 | 48,5 | 15 |
| 5/6 OYSTER | | ✓ | | CEF500375 | 12 | 43 | 12 |
| 7.5 BLACK BASS | | ✓ | | CEF500375 | 12,2 | 43 | 12 |
| 8 RAY | | ✓ | REC68T-44352-00 | CEF500368 | 11,6 | 53 | 14 |
| 6, 8/9.9 | | ✓ | | CEF500387 | 13,2 | 48 | 15 |
| 9.9 PIKE | | ✓ | REC63V-44352-01 | CEF500363 | 12,85 | 53 | 14 |
| 9.9, 15 | ✓ | | | CEF500387 | 13,2 | 48 | 15 |
| 15, 20 WAHOO | | ✓ | REC63V-44352-01 | CEF500363 | 12,85 | 53 | 14 |
| 25 KINGFISH | | ✓ | REC6H4-44352-02 | CEF500385G | 16,1 | 51,2 | 19,05 |
| 25, 30, 35 | ✓ | | | CEF500386 | 15,2 | 53 | 20,5 |
| 40 ARUANA EFI | | ✓ | REC6H4-44352-02 | CEF500385G | 16,1 | 51,2 | 19,05 |
| 40, 500 60 DORADO XS-R-EFI | | ✓ | REC6H3-44352-00 | CEF500316 | 18,05 | 51,8 | 19 |
| 40, 50, 60, 70, 80 | ✓ | | | CEF500304 | 18,2 | 58,62 | 22,5 |
| 80, 100 MARLIN EFI | | ✓ | REC67F-44352-00 | CEF500364 | 20 | 58,2 | 34,7 |
| 115, 150, 200, 225, 250 EFI | | ✓ | REC6E5-44352-01 | CEF500371 | 22,4 | 89,3 | 31 |

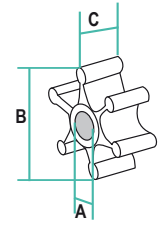

REC6E5-44352-01



REC68T-44352-00



REC63V-44352-01



REC6H4-44352-02



REC6H3-44352-00



REC67F-44352-00

SISTEMA DE PROPULSIÓN PROPULSION SYSTEM

SISTEMA DI PROPULSIONE SYSTEME DE PROPULSION

| HÉLICES ALUMINIO E INOXIDABLE DE 3 Y 4 PALAS | 3 & 4 BLADE ALUMINIUM & SS PROPELLERS | ELICHE ALLUMINIO E INOX DA 3 E 4 PALE | HELICE ALUMINIUM ET INOX 3 ET 4 PALES |
|--|--|---|--|
| CÓDIGO DE REFERENCIAS | PART NO. CODING SYSTEM | SISTEMA DI CODICE | CODAGE DES REFERENCES |
| | | | |
| 1 1. Mercury, Mariner 2. Johnson, Evinrude 3. Yamaha 4. Suzuki 5. Tohatsu 6. 7. 8. Volvo Penta 9. Rubex System | 2 0.5, 6, 8 and 9.8 HP Group 1. A Group 2. B Group 3. C Group 4. D Group 5. E Group 6. F Group 7. VP (Std. Hub) 8. VP (Long Hub) | 3 1. AL 2. Saturn (INOX Stainless Steel) 3. New Saturn (INOX Stainless Steel) 4. Titan (INOX Stainless Steel) 5. HR Titan (INOX Stainless Steel) 6. Scorpion (INOX Stainless Steel) 7. Lexor (INOX Stainless Steel) | 4 1. 3R Rubber Hub 2. 3L Rubber Hub 3. 4R Rubber Hub 4. 4L Rubber Hub |

SOLAS

AMITA 3

SOLAS

Hélice de aluminio con núcleo de goma de gran resistencia.

Aluminum propeller with heavy duty rubber hub.

Eliche di alluminio con mozzi in gomma ad alta resistenza.

Hélice en aluminium avec moyeu en caoutchouc



AMITA 4

SOLAS

Hélices de aluminio con núcleo de goma de gran resistencia. Van muy suaves a poca velocidad y hace el barco muy manejable con la mar picada.

Aluminum propeller with heavy duty rubber hub. Smoother low speed makes the offshore boating activity much easier.

Eliche di alluminio con mozzo in gomma ad alta resistenza. Molto morbido a bassa velocità e rende la barca molto maneggevole con mare cattivo.

Hélice en aluminium avec moyeu en caoutchouc. Permet d'aller doucement à basse vitesse et rende le bateau très maniable lorsque la mer est agitée



NEW SATURN

SOLAS

Hélices de acero inoxidable. Ofrece buena aceleración y rendimiento. Tamaño más pequeño que ofrece un diámetro extragrande.

Stainless steel propeller. Offers good acceleration & all-round performance. Smaller pitch sizes offered in extra large diameter with increased blade area.

Eliche di acciaio inox. Buona accelerazione. Piccole dimensioni che offre un più grande diametro.

Hélice inox, offrant de bonnes accélérations et performances. Taille de pas réduite pour les modèles de grands diamètres avec une surface de pale plus importante.

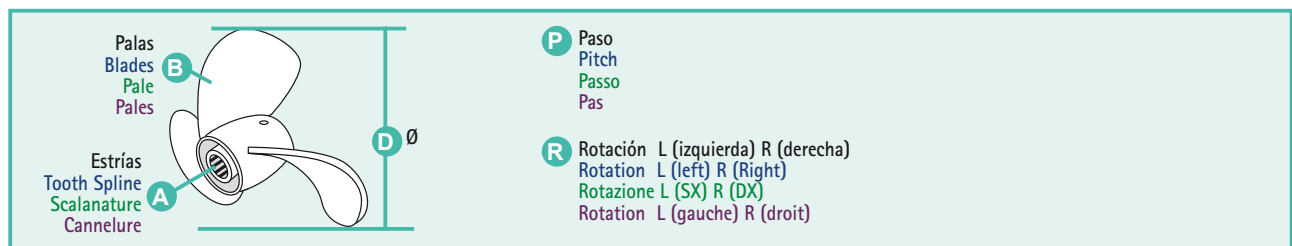
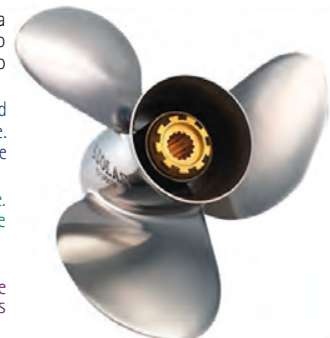

**GUÍA DE HÉLICES
CON NÚCLEO INTEGRADO**

**PROPELLERS APPLICATION
WITH RUBBER HUB**

**GUIDA ELICHE
CON MOZZO**

**GUIDE DES HELICES ET
MOYEURS**

| | 2T STROKES | 4T STROKES | R.O. OEM | A | B | D | P | R | AL | | INOX STAINLESS STEEL |
|---|---------------|---------------|--|---|---|---|---|--|--|--|--|
| | | | | | | | | | AMITA 3 | AMITA 4 | NEW SATURN |
| RAY 8 | ✓ | | 6G1-45947-00-EL 6G1-45943-00-EL 6G1-45941-00-EL | 3 | | 8 ^{1/2} | 6 ^{1/2} 7 ^{1/2} 8 ^{1/2} | R | SOL3011-085-07 SOL3011-085-08 SOL3011-085-09 | | |
| SELVA 9.9 / 15 HP | ✓ | | 2501300 | 3 | | 10 9 ^{1/4} | 7 8 9 | R | SOL2111-093-07 SOL2111-093-08 SOL2111-093-09 SOL2111-093-10 SOL2111-093-11 | | |
| DOLPHIN 9.9 (S) DOLPHIN 9.9 (L) DOLPHIN 15 | ✓ | | 683-45947-00-EL 683-45945-00-EL 683-45952-00-EL | 3 | | 9 ^{1/4} | 8 9 9 ^{3/4} | R | SOL3111-093-08 SOL3111-093-09 SOL3111-093-10 | | |
| ANTIBES 20xs ANTIBES 25 ANTIBES 30 MAIORCA 35 | ✓ | | 2505500 2505520 2505570 | | | 10 ^{1/2} | 11 12 12.5 | R | SOL2211-105-11 SOL2211-103-12 SOL2211-101-13 | | |
| MORAY 25 | ✓ | | 664-45945-00-EL | 3 | | 9 ^{7/8} | 10 ^{1/2} 11 ^{1/4} 12 13 11 12 13 | R | SOL3211-099-10 SOL3211-099-11 SOL3211-099-12 SOL3211-099-13 | | SOL3231-105-11 SOL3231-103-12 SOL3231-101-13 |
| MADEIRA 40 MADEIRA 40/50 ST. TROPEZ 40 ST. TROPEZ 40/60 | ✓ | | 2505895 2506050 2506060 | 3 | | 12 ^{1/2} 12 ^{1/4} 11 ^{3/4} | 14 15 17 | R | SOL2311-125-14 SOL2311-123-15 SOL2311-120-17 | | |
| MANTA 40 BARRACUDA 50/40 DORADO 60/40 | ✓ | | 663-45956-01-EL 663-45947-02-EL 663-45952-02-EL 663-45945-02-EL 663-45958-01-EL 663-45943-02-EL 663-45949-01-EL 663-45941-01-EL | 3 | | 12 ^{1/4} 11 ^{5/8} 11 ^{3/4} 11 ^{1/8} 11 ^{1/4} 11 10 ^{3/4} 11 11 ^{7/8} 11 ^{5/8} 11 ^{3/8} 11 ^{1/8} 11 ^{1/8} | 9 11 12 13 14 15 16 17 10 11 12 13 14 | R | SOL3311-121-09 SOL3311-116-11 SOL3311-114-12 SOL3311-111-13 SOL3311-111-14 SOL3311-110-15 SOL3311-110-16 SOL3311-110-17 | | SOL3331-119-10 SOL3331-116-11 SOL3331-114-12 SOL3331-111-13 SOL3331-111-14 |
| TENERIFE 70 BEST 800 PORTOFIN 70 PORTOFINO 75xs PORTOFINO 80 SUPERBEST 1000 MONTECARLO 90 MONTECARLO 100 | ✓ | | 2505860 2505860 2506020 2506020 2506020 2505840 2506030 2506030 | 3 | | 14 14 13 ^{3/4} 14 14 14 13 ^{3/4} 13 ^{3/8} 13 12 ^{3/4} | 11 13 15 17 19 21 15 17 19 21 | R | SOL2411-140-11 SOL2411-138-13 SOL2411-135-15 SOL2411-133-17 SOL2411-130-19 SOL2411-130-21 | SOL2413-133-13 SOL2413-130-15 SOL2413-128-17 SOL2413-125-19 SOL2413-125-21 | SOL2431-135-15 SOL2431-133-17 SOL2431-130-19 SOL2431-130-21 SOL2431-135-15 SOL2431-133-17 SOL2431-130-19 SOL2431-130-21 |
| MARLIN 100 NARWHAL 115 | ✓ | | 6E5-45954-00-EL 6E5-45949-00-EL 6E5-45947-00-EL 6E5-45945-00-EL 6E5-45941-00-EL 6E5-45943-00-EL 688-45978-90-98 688-45930-02-98 688-45970-03-98 688-45972-02-98 | 3 | | 14 13 ^{5/8} 13 ^{1/8} 13 ^{1/2} 13 ^{1/2} 13 ^{1/4} 13 12 ^{5/8} 13 13 13 | 11 13 13 15 15 17 19 21 15 17 19 21 | R R L R R L R R R R | SOL3411-140-11 SOL3411-138-13 SOL3412-138-13 SOL3411-135-15 SOL3412-135-15 SOL3411-133-17 SOL3412-133-17 SOL3413-125-19 SOL3413-125-21 | SOL3413-133-13 SOL3413-130-15 SOL3413-128-17 | SOL3431-135-15 SOL3431-133-17 SOL3431-130-19 SOL3431-130-21 |
| WHITE SHARK 150 HPDFI | ✓ | | 6G5-45941-00-98 6G5-45952-00-98 6G5-45947-01-98 6K1-45947-00-98 6G5-45945-01-98 6K1-45945-01-98 6G5-45949-00-98 6G5-45949-00-98 | 3 | | 15 15 14,8 14,8 14,5 14,5 14,3 14,3 14,2 | 15 15 17 17 19 19 21 21 23 23 | R L R L R L R L R L | SOL3511-150-15 SOL3512-150-15 SOL3511-148-17 SOL3512-148-17 SOL3511-145-19 SOL3512-145-19 SOL3511-143-21 SOL3512-143-21 SOL3511-142-23 SOL3512-142-23 | SOL3513-148-15 SOL3514-148-15 SOL3513-145-17 SOL3514-145-17 SOL3513-143-19 SOL3514-143-19 SOL3513-140-21 SOL3514-140-21 | |

REF--> RO / OEM

| REF | R.O. / OEM | REF | R.O. / OEM | |
|-----------------|---------------|----------------|-----------------|-----|
| C | | SOL2413-125-21 | 2505840 | 642 |
| CEF500304 | | SOL2413-128-17 | 2506020 | 642 |
| CEF500316 | | SOL2413-130-15 | 2506020 | 642 |
| CEF500363 | | SOL2413-133-13 | 2505860 | 642 |
| CEF500364 | | SOL2431-130-19 | 2506020 | 642 |
| CEF500368 | | SOL2431-130-21 | 2505840 | 642 |
| CEF500371 | | SOL2431-133-17 | 2506020 | 642 |
| CEF500375 | | SOL2431-133-17 | 2506030 | 642 |
| CEF500376 | | SOL2431-135-15 | 2506020 | 642 |
| CEF500385G | | SOL2431-135-15 | 2506030 | 642 |
| CEF500386 | | SOL3011-085-07 | 6G1-45947-00-EL | 642 |
| CEF500387 | | SOL3011-085-08 | 6G1-45943-00-EL | 642 |
| CM15026 | | SOL3011-085-09 | 6G1-45941-00-EL | 642 |
| CM2500010 | 2500010 | SOL3111-093-08 | 683-45947-00-EL | 642 |
| CM2500050 | 2500050 | SOL3111-093-09 | 683-45945-00-EL | 642 |
| CM2500065 | 2500065 | SOL3111-093-10 | 683-45952-00-EL | 642 |
| CM2504015 | 2504015 | SOL3211-099-10 | 664-45945-00-EL | 642 |
| CM2504020 | | SOL3211-099-11 | | 642 |
| CM2504025 | | SOL3211-099-12 | | 642 |
| CM2504035 | | SOL3211-099-13 | | 642 |
| CM41811-98500 | 41811-98500 | SOL3231-101-13 | | 642 |
| CM55300-95500 | 55300-95500 | SOL3231-103-12 | | 642 |
| CM55320-98400 | 41811-98400 | SOL3231-105-11 | | 642 |
| CM55321-94900 | 55320-94900 | SOL3311-110-15 | 663-45943-02-EL | 642 |
| CM55321-94900A | 55320-94900 | SOL3311-110-16 | 663-45949-01-EL | 642 |
| CM61N-45251-01 | | SOL3311-110-17 | 663-45941-01-EL | 642 |
| CM62Y-11325-00 | | SOL3311-111-13 | 663-45945-02-EL | 642 |
| CM63P-11325-01 | | SOL3311-111-14 | 663-45958-01-EL | 642 |
| CM63P-11325-11 | | SOL3311-114-12 | 663-45952-02-EL | 642 |
| CM67C-45251-00 | 58.67C4525100 | SOL3311-116-11 | 663-45947-02-EL | 642 |
| CM67C-45371-00 | | SOL3311-121-09 | 663-45956-01-EL | 642 |
| CM67F-11325-01 | | SOL3331-111-13 | | 642 |
| CM67F-45371-00 | | SOL3331-111-14 | | 642 |
| CM688-45251-01 | | SOL3331-114-12 | | 642 |
| CM68T-11325-00 | | SOL3331-116-11 | | 642 |
| CM68T-45251-00 | | SOL3331-119-10 | | 642 |
| CM6BL-11325-00 | | SOL3411-130-19 | 6E5-45941-00-EL | 642 |
| CM6E0-45251-11A | | SOL3411-130-21 | 6E5-45943-00-EL | 642 |
| CM6E5-45371-01A | | SOL3411-133-17 | 6E5-45945-00-EL | 642 |
| CM6G5-45251-01A | | SOL3411-135-15 | 6E5-45947-00-EL | 642 |
| CM6G8-11325-00 | | SOL3411-138-13 | 6E5-45949-00-EL | 642 |
| CM6H1-45251-02 | | SOL3411-140-11 | 6E5-45954-00-EL | 642 |
| CM6J9-45371-01 | | SOL3412-133-17 | | 642 |
| CM6K1-45371-02 | | SOL3412-135-15 | | 642 |
| CM82795M | 25040151 | SOL3412-138-13 | | 642 |
| CM9005655 | 9005655 | SOL3413-125-19 | 6E5-45941-00-EL | 642 |
| CM9005660 | 9005660 | SOL3413-125-21 | 6E5-45943-00-EL | 642 |
| CM9005665 | 9005665 | SOL3413-128-17 | 6E5-45945-00-EL | 642 |
| N | | SOL3413-130-15 | 6E5-45947-00-EL | 642 |
| NGKBR6HS-10 | 636 | SOL3413-133-13 | 6E5-45949-00-EL | 642 |
| NGKDR6EB-9 | 636 | SOL3431-130-19 | 688-45970-03-98 | 642 |
| NGKLF6A-11 | 637 | SOL3431-130-21 | 688-45972-02-98 | 642 |
| NGKLF6A-11 | 637 | SOL3431-133-17 | 688-45930-02-98 | 642 |
| NGKLF6A-11 | 637 | SOL3431-135-15 | 688-45978-90-98 | 642 |
| NGKLF6A-11 | 637 | SOL3511-142-23 | 6G5-45949-00-98 | 642 |
| P | | SOL3511-143-21 | 6G5-45949-00-98 | 642 |
| PAF15-07000031 | 636-637 | SOL3511-145-19 | 6G5-45945-01-98 | 642 |
| PAF20-05000003 | 636 | SOL3511-148-17 | 6G5-45947-01-98 | 642 |
| PAF25-04000021 | 636 | SOL3511-150-15 | 6G5-45941-00-98 | 642 |
| R | | SOL3512-142-23 | | 642 |
| REC35-822626Q15 | 637 | SOL3512-143-21 | | 642 |
| REC5GH-13440-00 | 637 | SOL3512-145-19 | 6K1-45945-01-98 | 642 |
| REC5GH-13440-60 | 636-637 | SOL3512-148-17 | 6K1-45947-00-98 | 642 |
| REC60V-12411-00 | 637 | SOL3512-150-15 | 6G5-45952-00-98 | 642 |
| REC61N-24563-10 | 636 | SOL3513-140-21 | 6G5-45949-00-98 | 642 |
| REC63P-46241-00 | 637 | SOL3513-143-19 | 6G5-45945-01-98 | 642 |
| REC63V-44352-01 | 636-640 | SOL3513-145-17 | 6G5-45947-01-98 | 642 |
| REC67F-12411-01 | 637 | SOL3513-148-15 | 6G5-45941-00-98 | 642 |
| REC67F-44352-00 | 637-640 | SOL3514-140-21 | | 642 |
| REC67F-46241-00 | 637 | SOL3514-143-19 | 6K1-45945-01-98 | 642 |
| REC68T-24251-00 | 636 | SOL3514-145-17 | 6K1-45947-00-98 | 642 |
| REC68T-44352-00 | 636-640 | SOL3514-148-15 | 6G5-45952-00-98 | 642 |
| REC68T-46241-00 | 636 | I | | |
| REC6AH-12411-00 | 636 | TEN01123 | | 636 |
| REC6C5-46241-00 | 636-637 | TEN01154AL | | 636 |
| REC6D8-WS24A-00 | 636-637 | TEN01165 | | 637 |
| REC6D9-12411-00 | 637 | TEN01900 | 9005655 | 639 |
| REC6E5-44352-01 | 637-640 | TEN01901 | 9005660 | 639 |
| REC6H3-44352-00 | 636-637-640 | TEN01902 | 2500010 | 639 |
| REC6H4-44352-02 | 636-640 | TEN01903 | 2500050 | 639 |
| REC6P3-WS24A-00 | 637 | TEN01904 | 2504030 | 639 |
| S | | TEN01905 | 9005665 | 639 |
| SOL2111-093-07 | 2501300 | TEN01906 | 2500065 | 639 |
| SOL2111-093-08 | | TEN01907 | 2504025 | 640 |
| SOL2111-093-09 | | TEN01908 | 2504020 | 640 |
| SOL2111-093-10 | | TEN01909 | 2504015 | 639 |
| SOL2111-093-11 | | TEN01912 | 2504035 | 640 |
| SOL2211-101-13 | 2505570 | TEN01913 | | 640 |
| SOL2211-103-12 | 2505520 | TEN01914 | | 639 |
| SOL2211-105-11 | 2505500 | TEN01915 | | 639 |
| SOL2311-120-17 | 2506060 | TEN01916 | 3C8-60217-1 | 639 |
| SOL2311-123-15 | 2506050 | TX6400K | | 467 |
| SOL2311-125-14 | 2505895 | | | |
| SOL2411-130-19 | 2506020 | | | |
| SOL2411-130-21 | 2505840 | | | |
| SOL2411-133-17 | 2506020 | | | |
| SOL2411-135-15 | 2506020 | | | |
| SOL2411-138-13 | 2505860 | | | |
| SOL2411-140-11 | 2505860 | | | |
| SOL2413-125-19 | 2506020 | | | |

RO / OEM --> REF

| R.O. / OEM | REF | | R.O. / OEM | REF | | R.O. / OEM | REF | |
|------------|----------------|---------|-----------------|----------------|-----|-----------------|----------------|-----|
| 2500010 | CM2500010 | 638 | 2506020 | SOL2431-135-15 | 642 | 688-45970-03-98 | SOL3431-130-19 | 642 |
| 2500010 | TEN01902 | 639 | 2506030 | SOL2431-133-17 | 642 | 688-45972-02-98 | SOL3431-130-21 | 642 |
| 2500050 | CM2500050 | 638 | 2506030 | SOL2431-135-15 | 642 | 688-45978-90-98 | SOL3431-135-15 | 642 |
| 2500050 | TEN01903 | 639 | 2506050 | SOL2311-123-15 | 642 | 6E5-45941-00-EL | SOL3411-130-19 | 642 |
| 2500065 | CM2500065 | 638 | 2506060 | SOL2311-120-17 | 642 | 6E5-45941-00-EL | SOL3413-125-19 | 642 |
| 2500065 | CM67C-45251-00 | 636-638 | 9005655 | CM9005655 | 638 | 6E5-45943-00-EL | SOL3411-130-21 | 642 |
| 2500065 | TEN01906 | 639 | 9005655 | TEN01900 | 639 | 6E5-45943-00-EL | SOL3413-125-21 | 642 |
| 2501300 | SOL2111-093-07 | 642 | 9005660 | TEN01901 | 639 | 6E5-45945-00-EL | SOL3411-133-17 | 642 |
| 2504015 | CM2504015 | 638 | 9005665 | CM9005665 | 638 | 6E5-45945-00-EL | SOL3413-128-17 | 642 |
| 2504015 | TEN01909 | 639 | 9005665 | TEN01905 | 639 | 6E5-45947-00-EL | SOL3411-135-15 | 642 |
| 2504020 | TEN01908 | 640 | 25040151 | CM82795M | 639 | 6E5-45947-00-EL | SOL3413-130-15 | 642 |
| 2504025 | TEN01907 | 640 | 90056660 | CM9005660 | 638 | 6E5-45949-00-EL | SOL3411-138-13 | 642 |
| 2504030 | TEN01904 | 639 | 3C8-60217-1 | TEN01916 | 639 | 6E5-45949-00-EL | SOL3413-133-13 | 642 |
| 2504035 | TEN01912 | 640 | 41811-98400 | CM55320-98400 | 638 | 6E5-45954-00-EL | SOL3411-140-11 | 642 |
| 2505500 | SOL2211-105-11 | 642 | 41811-98500 | CM41811-98500 | 638 | 6G1-45941-00-EL | SOL3011-085-09 | 642 |
| 2505520 | SOL2211-103-12 | 642 | 55300-95500 | CM55300-95500 | 638 | 6G1-45943-00-EL | SOL3011-085-08 | 642 |
| 2505570 | SOL2211-101-13 | 642 | 55320-94900 | CM55321-94900 | 638 | 6G1-45947-00-EL | SOL3011-085-07 | 642 |
| 2505840 | SOL2411-130-21 | 642 | 55320-94900 | CM55321-94900A | 638 | 6G5-45941-00-98 | SOL3511-150-15 | 642 |
| 2505840 | SOL2413-125-21 | 642 | 58.67V4525100 | CM67C-45251-00 | 638 | 6G5-45941-00-98 | SOL3513-148-15 | 642 |
| 2505840 | SOL2431-130-21 | 642 | 663-45941-01-EL | SOL3311-110-17 | 642 | 6G5-45945-01-98 | SOL3511-145-19 | 642 |
| 2505860 | SOL2411-138-13 | 642 | 663-45943-02-EL | SOL3311-110-15 | 642 | 6G5-45945-01-98 | SOL3513-143-19 | 642 |
| 2505860 | SOL2411-140-11 | 642 | 663-45945-02-EL | SOL3311-111-13 | 642 | 6G5-45947-01-98 | SOL3511-148-17 | 642 |
| 2505860 | SOL2413-133-13 | 642 | 663-45947-02-EL | SOL3311-116-11 | 642 | 6G5-45947-01-98 | SOL3513-145-17 | 642 |
| 2505895 | SOL2311-125-14 | 642 | 663-45949-01-EL | SOL3311-110-16 | 642 | 6G5-45949-00-98 | SOL3511-142-23 | 642 |
| 2506020 | SOL2411-130-19 | 642 | 663-45952-02-EL | SOL3311-114-12 | 642 | 6G5-45949-00-98 | SOL3511-143-21 | 642 |
| 2506020 | SOL2411-133-17 | 642 | 663-45956-01-EL | SOL3311-121-09 | 642 | 6G5-45949-00-98 | SOL3513-140-21 | 642 |
| 2506020 | SOL2411-135-15 | 642 | 663-45958-01-EL | SOL3311-111-14 | 642 | 6G5-45952-00-98 | SOL3512-150-15 | 642 |
| 2506020 | SOL2413-125-19 | 642 | 664-45945-00-EL | SOL3211-099-10 | 642 | 6G5-45952-00-98 | SOL3514-148-15 | 642 |
| 2506020 | SOL2413-128-17 | 642 | 683-45945-00-EL | SOL3111-093-09 | 642 | 6K1-45945-01-98 | SOL3512-145-19 | 642 |
| 2506020 | SOL2413-130-15 | 642 | 683-45947-00-EL | SOL3111-093-08 | 642 | 6K1-45945-01-98 | SOL3514-143-19 | 642 |
| 2506020 | SOL2431-130-19 | 642 | 683-45952-00-EL | SOL3111-093-10 | 642 | 6K1-45947-00-98 | SOL3512-148-17 | 642 |
| 2506020 | SOL2431-133-17 | 642 | 688-45930-02-98 | SOL3431-133-17 | 642 | 6K1-45947-00-98 | SOL3514-145-17 | 642 |

POLÍTICA DE GARANTÍAS RECMAR

Todos los productos comercializados por **Recambios Marinos S.L.U.** deben ser instalados y utilizados por personal competente bajo su exclusiva responsabilidad. **Recambios Marinos S.L.U.** no se responsabiliza de las consecuencias producidas por una instalación defectuosa o inapropiada de ningún artículo que no incluya soluciones de instalación.

El instalador será el responsable de verificar la correcta aplicación de las recomendaciones del fabricante en cuanto a compatibilidades de uso.

Los artículos comercializados por **Recambios Marinos S.L.U.** están amparados por la garantía legal de conformidad, conforme a las condiciones expuestas en el real decreto legislativo 1/2007 de 16 de Noviembre, aprobación del texto refundido de la ley general para la defensa de los consumidores y usuarios.

Recambios Marinos S.L.U. distribuye los artículos presentes en sus catálogos únicamente a profesionales, nunca a particulares o cliente final, el importe de la instalación jamás estará incluido en el precio por lo que no será responsable de ésta.

Los artículos comercializados por **Recambios Marinos S.L.U.** disponen de una garantía limitada por defectos de fabricación, los periodos pueden variar entre los 2 años y los 3 meses

SOLICITUD DE GARANTÍA

La garantía siempre estará sujeta a la valoración final del departamento técnico de **Recambios Marinos S.L.U.** Esta valoración se llevará a cabo en nuestras instalaciones o en caso necesario por el fabricante del artículo, en ambas opciones el artículo tiene que estar físicamente en nuestras instalaciones centrales de Viladecans. El tiempo para la resolución será un máximo de 30 días naturales desde su recepción.

EXCLUSIONES DE GARANTÍA

Recambios Marinos S.L.U. no podrá ser acusado como responsable del defecto ante:

- Desgaste normal del producto.
- Defectos de instalación o uso inadecuado.
- Instalación de un artículo no destinado a ese modelo.
- Daños por causa externa (accidente, rayo, fluctuación de corriente...)
- Defectos y consecuencias relacionadas con el transporte.
- Alteraciones en instalaciones o barcos destinados a la competición.

GARANTÍA LIMITADA EMBARCACIONES Y PADDLE SURF GOLDENSHIP

Recambios Marinos S.L.U. garantiza toda su gama de embarcaciones neumáticas y paddle surf ante cualquier defecto de fabricación durante un periodo de 24 meses (sólo en Europa) únicamente uso particular. Para uso profesional 6 meses.

La garantía limitada será aplicable a defectos en el tejido y sellado, no se aplicará en los siguientes casos:

- Modificación de piezas y partes.
- Falta de mantenimiento, negligencia, accidentes o instalación incorrecta.
- Desgaste y rasgaduras de uso.

Esta garantía limitada no cubrirá costos incidentales originados por: gastos de remolque, almacenaje, botaduras, alquileres de cualquier tipo, pérdidas de tiempo o ingreso, ni otros daños emergentes.

COMO PROCEDER ANTE UN DEFECTO EN NUESTRA NEUMÁTICA O PADDLE

El primer paso a realizar es la identificación del motivo de la avería. En casos de pérdida de presión es importante localizar el punto o puntos de la pérdida de aire.

El trámite se realizará a través de la página web www.recambiosmarinos.es dentro del Área privada, seleccionando

dependiendo del producto, aplicación y tipo de embarcación (lista 7º/ 6º/ 5º), descartando los artículos considerados como consumibles: bombillas, productos eléctricos, baterías y otros que carecen de periodo alguno, si necesita conocer el plazo exacto del producto contacte con el departamento comercial.

Por daños ocasionados en el transporte, se aplicará lo indicado en el artículo 366 de Código de Comercio, que dice : "Dentro de las veinticuatro horas siguientes al recibo de las mercancías, podrá hacerse reclamación contra la empresa de transporte asignada. Transcurridos los términos expresados o pagados los portes, no se admitirá reclamación alguna contra el transportista sobre el estado en que se entregó la mercancía." El material que enviamos diariamente desde **Recambios Marinos S.L.U.** a nuestros clientes es examinado antes de empaquetarse para su perfecta integridad y evitar daños en el transporte. Recuerde que es muy importante inspeccionar las cargas en presencia del transportista. Cuando se observen daños en la caja, deberá incluirse en el albarán de entrega del transportista una mención del tipo (CONFORME MERCANCÍA, SALVO INSPECCIÓN), y deberá ser firmada por usted y el transportista. En caso de recibir material defectuoso por estas causas debe hacerlo constar tanto al transportista como a **Recambios Marinos S.L.U.** para poder reclamar a la empresa de transporte correspondiente.

Para enviar el artículo defectuoso, debe ir a la pagina web www.recambiosmarinos.es, ir a su cuenta y seleccionar TRAMITAR GARANTÍA dentro del área privada, desde aquí podrá descargar el archivo para la solicitud de garantías de motores y piezas, y seguir las instrucciones.

Recambios Marinos S.L.U. no asumirá ningún préstamo de reemplazo durante el proceso de garantía.

En caso de rechazo de la garantía, el cliente tiene la posibilidad de recuperar su artículo defectuoso poniéndose en contacto con nosotros vía e-mail solicitando la devolución del mismo dentro de los 7 días naturales siguientes a la fecha en que se le informó del rechazo de garantía.

Recambios Marinos S.L.U. no forma parte de las garantías comerciales anunciadas en ocasiones por los fabricantes.

"**expediente garantía neumáticas GoldenShip**". Es obligatorio adjuntar imágenes del defecto en cuestión y placa del número de serie, copia del albarán de compra y descripción detallada de la avería para iniciar el trámite.

Revisaremos la información y valoraremos el defecto para determinar la aceptación de garantía, en caso de iniciación de trámite les facilitaremos un número de seguimiento o autorización de devolución así como el método de envío. **Recambios Marinos S.L.U.** no aceptará devoluciones de artículos que no hayan sido previamente autorizados.

Nuestras obligaciones quedan limitadas a la reparación o reemplazo de las partes defectuosas resultantes de un defecto de fabricación. Nos reservamos el derecho de modificación de partes fabricadas con anterioridad.

Únicamente el servicio de postventa de Recambios Marinos está autorizado para gestionar las incidencias, no se podrán enviar a reparar artículos sin autorización, en caso de realizarse, el cliente asumirá el 100% los gastos y no podrán ser reclamados.

RECMAR WARRANTY POLICY

All products sold by **Recambios Marinos S.L.U.** must be installed and used by competent personnel under their exclusive responsibility. **Recambios Marinos S.L.U.** shall not be responsible for the consequences of the faulty or improper installation of any item that does not include installation solutions.

The fitter will be responsible for checking that the manufacturer recommendations have been followed correctly in terms of compatible uses.

Articles sold by **Recambios Marinos S.L.U.** are covered by legal warranty of conformity, in accordance with Royal Legislative Decree 1/2007, of 16 November, approving the recast text of the general law on consumer and user protection.

Recambios Marinos S.L.U. distribute the products only to professionals and never to privates of final clients. The cost of installing the part would never be included in the price for which reason, **Recambios Marinos S.L.U.** would never be responsible for its installation.

Articles sold by **Recambios Marinos S.L.U.** are covered by warranty for manufacturing defects for a limited period of time that may vary between 2 years and 3 months, depending on the

product, application and type of boat it is installed on (7th/6th/5th list), except for the articles considered consumable, light bulbs, electrical products, batteries and others that are not covered at all. For information on the exact warranty period of an article, please contact the Sales Department.

In the case of damage caused during shipping, article 366 of the Code of Commerce will apply. The article says: "Claims to the delivery company may be made within 24 hours from receiving the goods. Once this term has elapsed, or the freight costs have been paid, claims to the delivery company with regard to the condition of the goods can no longer be made." The goods that **Recambios Marinos S.L.U.** sends every day to its customers are examined before being packed to ensure their perfect integrity and avoid damage during shipping. Remember that it is essential to check the goods in the presence of the dispatcher. If the package is damaged, the dispatcher's delivery note must mention what type (CONFORMING GOODS, UNLESS INSPECTED), and must be signed by you and by the dispatcher. If you receive damaged goods for these reasons you must notify both the dispatcher and **Recambios Marinos S.L.U.** to be able to make the claim to the relevant delivery company.

WARRANTY CLAIMS

Warranties are always subject to **Recambios Marinos S.L.U.** Technical Department's assessment. The assessment will be carried out on **Recambios Marinos S.L.U.**'s premises or, if necessary, by the article's manufacturer. In both cases, the article must be physically on **Recambios Marinos S.L.U.**'s premises in Viladecans. Assessment time will not exceed 30 calendar days from receiving the article.

To return the faulty item, visit www.recambiosmarinos.es, go to your account and select PROCESS WARRANTY in the private section. From there you will be able to download the file to claim the warranty of engines and parts and follow the instructions.

Recambios Marinos S.L.U. will not charge for the loan of the replacement during the warranty process.

WARRANTY EXCLUSIONS

Recambios Marinos S.L.U. shall not be responsible for product faults in the following cases:

- Normal wear and tear of a product. Installation faults or improper use.
- Installation of an article not designed for the model in question.
- Damage due to external causes (accidents, lightning, power surges...)
- Defects and consequences of transport.
- Alterations to installations or to boats intended for competitions.

If the warranty is refused, the customer may retrieve the faulty article by contacting **Recambios Marinos S.L.U.** via email and requesting that the article is returned to them within 7 calendar days from the day the warranty was refused.

Recambios Marinos S.L.U. does not apply the warranties offered from time to time by manufacturers.

GOLDENSHIP BOATS AND PADDLE SURF LIMITED WARRANTY

Recambios Marinos S.L.U. guarantees its full range of inflatable/rib boats and paddle surf of any manufacturing defect for a period of 24 months (only in Europe) for private use only. Commercial use 6 months.

The limited warranty will be applicable to defects in the fabric and sealing, but will not apply in the following situations:

- Modification of parts and components.
- Lack of maintenance, negligence, accidents or improper installation.
- Wear and tear of use.

This limited warranty will not cover incidental costs arising from: towing expenses, storage, launching, rents of any kind, loss of time or income, or other damages emerging.

HOW TO PROCEED IF YOU FIND A DEFECT IN ONE OF OUR BOATS / PADDLE SURF

Identify the reason for the breakdown, in cases of pressure loss. It is important to locate the point or points of air loss.

The claim must be done through the private area of the the **Recambios Marinos** website, www.recambiosmarinos.es by selecting the file "**Goldenship boats warranty**".

It is mandatory to attach images when you send the claim to **Recambios Marinos S.L.U.** by e-mail, and a detailed explanation of the problem as well as copy of the plate with the model and serial number and copy of the purchase invoice.

Our obligations are limited to the repair or replacement of defective parts resulting from a manufacturing defect. We reserve the right to modify parts previously manufactured.

Only the **Recambios Marinos S.L.U.** service department is authorized to handle the warranty claims and authorize any repair. Items cannot be sent to repair without authorization of **Recambios Marinos S.L.U.**, Otherwise the client would have to assume 100% of the expenses and would be automatically out of warranty.

POLITICA DI GARANZIE RECMAR

Tutti i prodotti commercializzati da **Recmar S.R.L.** devono essere installati e utilizzati da personale competente sotto la sua esclusiva responsabilità. **Recmar S.R.L.** non è responsabile per le conseguenze di un'installazione difettosa o inadeguata di qualsiasi articolo che non includa soluzioni di installazione.

L'installatore è responsabile della verifica della corretta applicazione delle raccomandazioni del fabbricante in materia di compatibilità d'uso.

Gli articoli commercializzati dalla **Recmar S.R.L.** sono coperti dalla garanzia legale di conformità, conforme alle condizioni enunciate nel regio decreto legislativo 1/2007 del 16 novembre, approvazione del testo consolidato della legge generale per la difesa dei consumatori e degli utenti.

Recmar S.R.L. distribuisce gli articoli presenti nei suoi cataloghi solo a professionisti, mai a privati o cliente finale, l'importo dell'impianto non sarà mai incluso nel prezzo e quindi non sarà responsabile di quest'ultimo.

Gli articoli commercializzati dalla **Recmar S.R.L.** dispongono di una garanzia limitata per difetti di fabbricazione, i periodi possono variare da 2 anni a 3 mesi a seconda del prodotto applicazione

e tipo di imbarcazione (elenco 7^a/ 6^a/ 5^a), scartando gli articoli considerati come consumabili lampadine, prodotti elettrici, batterie e altri che non hanno alcun periodo di tempo, se avete bisogno di conoscere il tempo esatto del prodotto contattare il reparto commerciale.

Per i danni causati al trasporto si applica l'articolo 366 del codice di commercio che recita: "Entro 24 ore dal ricevimento delle merci, può essere presentato un reclamo nei confronti della società di trasporto designata. Alla scadenza dei termini espressi o pagati, non sono ricevibili reclami contro il trasportatore in merito allo stato in cui la merce è stata consegnata." Il materiale che inviamo quotidianamente da **Recmar S.R.L.** ai nostri clienti viene esaminato prima di essere confezionato per la sua perfetta integrità ed evitare danni al trasporto. Si ricorda che è molto importante ispezionare i colli alla presenza del vettore. In caso di danneggiamento della cassa, sul bollettino di consegna del trasportatore deve figurare un'indicazione del tipo (CONFORME MERCE, SALVO ISPEZIONE) e deve essere firmato dall'utente e dal trasportatore, in caso di ricezione di materiale difettoso per questi motivi deve essere messo a verbale sia al trasportatore che alla **Recmar S.R.L.** per poter reclamare all'impresa di trasporto interessata.

RICHIESTA DI GARANZIA

La garanzia sarà sempre soggetta alla valutazione finale del Dipartimento Tecnico della **Recmar S.R.L.** Questa valutazione sarà effettuata presso la nostra sede o, se necessario, dal fabbricante dell'articolo, in entrambe le opzioni l'articolo deve essere fisicamente nella nostra sede centrale di Viladecans, il tempo per la risoluzione è un massimo di 30 giorni di calendario dalla ricezione.

Per inviare l'articolo difettoso, è necessario andare al sito www.recmar.it, andare al tuo account e selezionare la GARANZIA all'interno del settore privato, da qui è possibile scaricare il file per la richiesta di garanzie di motori e parti e seguire le istruzioni.

Recmar S.R.L. non assumerà alcun prestito di sostituzione durante il processo di garanzia.

ESCLUSIONI DI GARANTÍA

Recmar S.R.L. non può essere accusato come responsabile del difetto di fronte a:

- Normale usura di un prodotto.
- Difetti di installazione o uso improprio.
- Installazione di un articolo non destinato a quel modello.
- Danni dovuti a cause esterne (incidente, fulmine, fluttuazione di corrente...)
- Difetti e conseguenze connesse al trasporto.
- Modifiche in impianti o barche destinati alla competizione.

In caso di rifiuto della garanzia, il cliente ha la possibilità di recuperare il suo articolo difettoso contattandoci via e-mail e richiesta di rimborso entro 7 giorni di calendario dalla data in cui viene informato del rifiuto della garanzia.

Recmar S.R.L. non fa parte delle garanzie commerciali annunciate a volte dai produttori.

GARANZIA LIMITATA BARCHE E PADDLE SURF GOLDENSHIP

Recmar S.R.L. garantisce l'intera gamma di imbarcazioni pneumatiche e paddle surf contro qualsiasi difetto di fabbricazione per un periodo di 24 mesi (solo in Europa) esclusivamente per uso privato. Per uso professionale 6 mesi.

La garanzia limitata si applica ai difetti di tessuto e di tenuta, non si applica nei seguenti casi:

- Modifica di parti e pezzi.
- Mancanza di manutenzione, negligenza, incidenti o installazione errata.
- Usura e strappi di utilizzo

Questa garanzia limitata non copre i costi incidentali derivanti da: costi di rimorchio, deposito, varo, noleggio di qualsiasi tipo, perdite di tempo o entrate, o altri danni emergenti.

COME PROCEDERE A UN DIFETTO NELLA NOSTRA PNEUMATICA/ PADDLE

Il primo passo da fare è identificare il motivo dell'avaria, in caso di perdita di pressione è importante individuare il punto o i punti della perdita d'aria.

Il tramite sarà effettuato attraverso il sito Web di Recambios Marinos www.recmar.it all'interno dell'area privata, selezionando il "dossier garanzia pneumatiche GoldenShip". È obbligatorio allegare immagini del difetto in questione e targhetta del numero di serie, copia della bolla di acquisto e descrizione dettagliata del guasto per avviare la procedura, se necessario.

Recmar S.R.L. non accetterà restituzioni di articoli che non sono stati precedentemente autorizzati.

I nostri obblighi sono limitati alla riparazione o sostituzione delle parti difettose derivanti da un difetto di fabbricazione. Ci riserviamo il diritto di modificare parti prodotte in precedenza.

Solo il servizio di post-vendita della **Recmar S.R.L.** è autorizzato a gestire gli eventi, non possono essere inviati a riparare articoli senza autorizzazione, in caso di realizzazione il cliente assumerà il 100% delle spese e non potranno essere reclamati.

POLITIQUE DE GARANTIE RECMAR

Tous les produits vendus par **Recambios Marinos S.L.U.** doivent être installés et utilisés par du personnel compétent sous sa seule responsabilité.

Recambios Marinos S.L.U. n'est pas responsable des conséquences d'une installation défectueuse ou inappropriée de tout élément n'incluant pas les solutions d'installation.

L'installateur sera responsable de la vérification de l'application correcte des recommandations du fabricant concernant la compatibilité d'utilisation.

Les articles vendus par **Recambios Marinos S.L.U.** bénéficient de la garantie légale de conformité, conformément aux conditions énoncées dans le décret législatif royal 1/2007 du 16 novembre, portant approbation du texte consolidé de la loi générale de la défense des consommateurs et des utilisateurs.

Les articles vendus par **Recambios Marinos S.L.U.** ont une garantie limitée pour les défauts de fabrication, les périodes peuvent varier de 2 ans à 3 mois en fonction de l'application du produit et du type de navire où ils ont été installés (7ème / 6ème / 5ème liste), excluant les articles considérés comme des consommables, ampoules, produits électriques, batteries et autres.

Si vous ne connaissez pas la durée de garantie exacte du produit, contactez le service commercial.

Pour les dommages causés au cours du transport, les dispositions de l'article 366 du code de commerce seront appliquées, ce qui stipule:

Vingt-quatre heures maximum après la réception de la marchandise, une réclamation doit être adressée à la société de transport.

Après que les conditions aient été exprimées ou que le fret eu été payé, aucune réclamation ne sera acceptée contre le transporteur auprès de l'État.

Lorsque la marchandise a été livrée. Le matériel que nous envoyons quotidiennement de **Recambios Marinos S.L.U.** à nos clients est examiné avant l'emballage pour une intégrité parfaite et éviter les dommages de transport. N'oubliez pas qu'il est très important d'inspecter le chargement en présence du transporteur.

Lorsque des dommages sont constatés sur le colis, ils doivent figurer sur le bon de livraison du transporteur.

Une mention du type (EN FONCTION DE LA MARCHANDISE, SAUF INSPECTION), et doit être signé par vous et le transporteur, s'il est reçu défectueux le matériel doit être enregistré pour ces raisons à la fois par le transporteur et par **Recambios Marinos S.L.U.** pour qu'une réclamation soit faite la compagnie de transport correspondante.

DEMANDE DE GARANTIE

La garantie sera toujours soumise à l'évaluation finale du service technique de **Recambios Marinos S.L.U.** Cette évaluation sera effectuée dans nos installations ou, si nécessaire, par le fabricant de l'article, dans les deux cas, l'article doit être physiquement dans nos locaux de Viladecans, le délai de résolution sera de 30 jours maximum à partir de sa réception.

Pour envoyer l'article défectueux, vous devez vous rendre sur le site www.recambiosmarinos.es, accéder à votre compte et sélectionner

PIECES DE RETOUR.

Dans l'espace privé, vous pouvez télécharger le fichier pour demander des garanties de moteurs et de pièces et suivre les instructions.

Si tel est votre souhait, **Recambios Marinos S.L.U.** n'assumera aucun prêt de remplacement pendant le processus de garantie.

EXCLUSIONS DE GARANTIE

Recambios Marinos S.L.U. ne sera pas responsable des défauts suivants:

- Usure normale d'un produit.
- Défauts d'installation ou d'utilisation inadéquate.
- Installation d'un article non destiné à ce modèle.
- Dommages dus à une cause externe (accident, foudre, fluctuation de courant...)
- Défauts et conséquences liés au transport.
- Modifications d'installations ou de bateaux destinés à la compétition.

En cas de refus de la garantie, le client a la possibilité de récupérer son article défectueux en nous contactant par courrier électronique pour demander le retour à ses frais de celui-ci dans les 7 jours calendaires suivant la date à laquelle vous avez été informé du rejet de la garantie.

Recambios Marinos S.L.U. ne participe pas à des garanties commerciales parfois annoncées par les fabricants.

LIMITE DE GARANTIE EMBARCATIONS ET PADDLE GOLDENSHIP

Recambios Marinos S.L.U. garantie sa gamme complète de bateaux gonflables et de paddle surf contre tout défaut de fabrication pendant une durée de 24 mois (uniquement en Europe) exclusivement pour usage particulière. Pour usage professionnel 6 mois.

La limite de garantie sera applicable aux défauts du tissu et de l'étanchéité, et elle ne s'appliquera pas dans les cas suivants :

- Modification de pièces ou partie.
- Manque d'entretien, négligence, accidents ou mauvaise installation.
- Usure d'usage.

Cette garantie limitée ne couvrira pas les frais accessoires résultant : Frais de stockage, remplacement, loyer de toute nature perte de temps ou de revenu, ou d'autre dommage émergent.

La procédure se fera via notre site internet www.recambiosmarinos.es, dans votre espace privé en sélectionnant le dossier "**garantie pneumatique Goldenship**". Il est obligatoire de joindre des photos du défaut en question et de la plaque du numéro de série. Il faut joindre également la copie du bon de livraison ou de la facture d'achat et faire une description détaillée de la panne pour démarrer le processus si nécessaire.

Recambios Marinos S.L.U. n'acceptera pas les retours des articles qui n'ont pas été préalablement autorisés. Notre obligation se limite à la réparation ou le remplacement des pièces défectueuses résultant d'un défaut de fabrication. Nous nous réservons le droit de modifier les pièces fabriquées précédemment.

Seul le service après-vente de **Recambios Marinos S.L.U.** est autorisé à gérer les incidents. Les articles ne peuvent pas être envoyés en réparation sans autorisation. Dans le cas contraire, le client assumera 100% des dépenses et ne pourra rien réclamer.

COMMENT PROCEDER AVEC UN DEFAUT SUR NOS PNEUMATIQUES ET PADDLE

La première étape consiste à identifier le motif de la panne. En cas de perte de pression, il est important de localiser le ou les points par lesquels l'air s'échappe.

BARCELONA

Jocelyn Bell, 26
Pol. Ca n'Alemanya
08840 Viladecans (Barcelona)
Tel. 902 10 85 85 - 93 633 34 80
Fax 93 662 66 59

International
phone: (+34) 93 662 66 55
Fax (+34) 93 662 66 59

info@recambiosmarinos.es
www.recambiosmarinos.es

GIRONA

C/ Gironés, 5
Pol. Ind. El Plà
17486 Castelló d'Empúries (Girona)
Tel. (+34) 972 158 809

girona@recmar.es

CANARIAS

Laura Grote de la Puerta, 3, Nave 5
Pol. Industrial El Mayorazgo
38110 Santa Cruz de Tenerife
Tel. (+34) 922 621 499

canarias@recmar.es

ITALIA

RECMAR SRL
Via Israele 10 H
Zona Industriale Settore 7
07026 Olbia (OT)

Tel. (+39) 0789 51962
Fax (+39) 0789 600177
sales@recmar.it