

**RECAMBIOS
MARINOS**

MERCURY MARINER JOHNSON EVINRUDE

FUERABORDA • OUTBOARD • FUORIBORDO • HORS-BORD

2021
2022

www.recambiosmarinos.es





















MERCURY MARINER JOHNSON EVINRUDE

FUERABORDA • OUTBOARD • FUORIBORDO • HORS-BORD

2021
2022



ICONOS ICONS ICONE ICONES

	Medida	Measures	Dimensione	Dimension
	Ancho	Width	Larghezza	Largeur
	Alto	High	Alto	Hauteur
	Largo Fondo	Length Depth	Lungo Sfondo	Longueur Profondeur
	Unidades x bolsa	Units x bag	Unità x borsa	Unité x sachet
	Unidades x skinpack	Units x skinpack	Unità x skinpack	Unité x blister
	Caja	Box	Scatola	Carton
	Peso	Weighth	Peso	Poids
	Trabajo seguro	Safe work	Lavoro sicuro	Travailler en sécurité
	Tubo Manguera	Tube	Tubo	Tuyau
	Distancia entre tornillos	Screw space	Distanza tra le viti	Entraxe
	Tornillo	Screw	Vite	Vis
	Rosca	Thread	Filo	Filetage
	Rosca Macho	Male Thread	Filetto maschio	Filetage mâle
	Rosca Hembra	Female thread	Filetto femmina	Filetage femelle
	Electricidad	Power	Elettricità	Electricité
	Eslora	Boat length	Lunghezza imbarcazione	Longueur embarcation
	Flujo Velocidad	Flow Speed	Flow	Vitesse du débit
	Presión	Pressure	Presione	Pression
	Entrada	IN	Ingresso	Entrée
	Salida	OUT	Uscita	Sortie
	Capacidad	Capacity	Capacità	Capacité

	Temperatura	Temperature	Temperatura	Température
	Hélice	Propeller	Elica	Hélice
	Cono eje	Hub	Asse conico	Asse conique
	Motor	Motor	Motore	Moteur
	Ánodo	Anode	Anodo	Anode
	Elemento filtro	Filter Element	Elemento filtro	Cartouche de filtre
	Llave	Key	Chiave	Clé
	Material	Material	Materiale	Matériel
	Pins	Pins	Pin	Pines
	Cables Terminales	Terminals	Terminali	Bornes
	Junta	Gasket	Guarnizione	Joint
	Aguja de cojinetete	Needle bearing	Aghi cuscinetto	Aiguille de palier
	Camisa de cojinete	Bearing sleeve	Manicotto del cuscinetto	Manchon de roulement
	Piston	Piston	Pistone	Piston
	Aros de piston	Piston ring	Fasce pistone	Segments de piston
	Cojinete	Bearing	Cuscinetto	Roulement
	Impulsor	Impeller	Girante	Turbine
	Tuerca	Nut	Dado	Écrou
	Dientes	Tooth	Denti	Dents
	Mando	Control	Comando	Boitier
	Estrías	Spline	Denti	Dents
	Polea	Pulley	Pulleggia	Poulie

IMPORTANTE

LOS PRODUCTOS QUE APARECEN EN NUESTROS CATALOGOS SON VÁLIDOS Y COMPATIBLES CON LOS MOTORES Y TRANSMISIONES DE LAS MARCAS ORIGINALES QUE APARECEN EN CADA SECCIÓN. EN ALGUNOS CASOS TAMBIÉN SUMINISTRAMOS RECAMBIOS ORIGINALES. ESTA INFORMACIÓN APARECE CON LA REFERENCIA EN EL MOMENTO DE CONFIRMAR EL PEDIDO POR NUESTRA WEB. LA IMÁGENES AQUÍ CONTENIDAS PUEDEN NO CORRESPONDER CON TOTAL PRECISIÓN AL PRODUCTO SUMINISTRADO. RECAMBIOS MARINOS, S.L.U. SE RESERVA EL DERECHO DE ANULAR O CAMBIAR PRODUCTOS SIN PREVIO AVISO.

IMPORTANT

THE PRODUCTS THAT APPEAR IN OUR CATALOGS ARE VALID AND COMPATIBLE WITH THE MOTORS AND TRANSMISSIONS OF THE ORIGINAL BRANDS THAT APPEAR IN EACH SECTION. IN SOME CASES WE ALSO SUPPLIED ORIGINAL SPARE PARTS. THIS INFORMATION APPEARS WITH THE REFERENCE AT THE TIME OF CONFIRMING THE ORDER BY OUR WEB. IMAGES CONTAINED HERE MAY NOT CORRESPOND WITH TOTAL ACCURACY TO THE PRODUCT SUPPLIED. RECAMBIOS MARINOS, S.L.U. RESERVES THE RIGHT TO CANCEL OR CHANGE PRODUCTS WITHOUT PRIOR NOTICE.

IMPORTANTE

I PRODOTTI CHE COMPAIONO NEI NOSTRI CATALOGHI SONO VALIDI E COMPATIBILI CON I MOTORI E LE TRASMISSIONI DEI MARCHI ORIGINALI CHE APPAIONO IN OGNI SEZIONE. IN ALCUNI CASI ABBIAMO FORNITO ANCHE RICAMBI ORIGINALI. QUESTA INFORMAZIONE RISULTA CON IL RIFERIMENTO AL MOMENTO DELLA CONFERMA DELL'ORDINE DA PARTE DEL NOSTRO WEB. LE IMMAGINI QUI CONTENUTE POTREBBERO NON CORRISPONDERE ESATTAMENTE AL PRODOTTO FORNITO. RECAMBIO MARINOS, S.L.U., SI RESERVA IL DIRITTO DI CANCELLARE O MODIFICARE I PRODOTTI SENZA PREAVVISO.

IMPORTANT

LES PRODUITS QUI FIGURENT DANS NOS CATALOGUES SONT VALIDES ET COMPATIBLES AVEC LES MOTEURS ET LES TRANSMISSIONS DES MARQUES ORIGINALES QUI SONT PRESENTES DANS CHAQUE SECTION. DANS CERTAINS CAS NOUS FOURNISSONS EGALEMENT DES PIECES DE RECHANGE ORIGINALES. CETTE INFORMATION EST MENTIONNEE AVEC LA REFERENCE SUR NOTRE SITE WEB. LES IMAGES CONTENUES DANS CE DOCUMENT PEUVENT NE PAS CORRESPONDER AVEC UNE PRECISION TOTALE AU PRODUIT FOURNI. RECAMBIO MARINOS SLU SE RESERVE LE DROIT D'ANNULER OU DE MODIFIER DES PRODUITS SANS PREAVIS.

• **MERCURY MARINER** **62**
 REF --> R.O. / OEM 355
 R.O./OEM --> REF 368

• **JOHNSON EVINRUDE** **380**
 REF --> R.O. / OEM 553
 R.O./OEM --> REF 560

Política de garantía y devolución **568**
 Warranty and return policy **570**
 Política di garanzie e regole per i rest merce **572**
 Politique de garantie et retour de pièces **574**

ÍNDICE accesorios	Accessories Table of contents	INDICE accessori	INDEX accessoires	
TX MARINE	TX MARINE	TX MARINE	TX MARINE	4
SOPORTES	STANDS	SUPPORTI	SUPPORTS	8
DIRECCIÓN MECÁNICA	STEERING SYSTEM	TIMONERIA MECCANICA	DIRECTION MÉCANIQUE	12
DIRECCIÓN HIDRÁULICA	HYDRAULICS STEERING SYSTEM	TIMONERIA IDRAULICA	DIRECTION HYDRAULIQUE	14
MANDOS UNIVERSALES Y ACCESORIOS	UNIVERSAL CONTROLS AND ACCESSORIES	CONTROLLI UNIVERSALI E ACCESSORI	COMMANDES UNIVERSELLES ET ACCESSORIES	18
SISTEMA DE GOBIERNO Y ACCESORIOS DE INSTALACIÓN	STEERING SYSTEM ET INSTALLATION ACCESSORIES	SISTEMA DI GUIDA E ACCESSORI STERZO	SYSTÈME DE DIRECTION ET ACCESSORIES D'INSTALLATION	21
CABLES MANDOS	CONTROL CABLES	CAVI COMANDO	CÂBLES DE COMMANDE	26
SISTEMA DE COMBUSTIBLE	FUEL SYSTEM	SISTEMA DI COMBUSTIBILE	SYSTÈME DE CARBURANT	28
FILTROS DE COMBUSTIBLE	FUEL FILTERS	FILTRO COMBUSTIBILE	FILTRES À CARBURAT	30
SISTEMA ELÉCTRICO	ELECTRIC SYSTEM	SISTEMA ELETTRICO	SYSTÈME ÉLECTRIQUE	33
LUBRICANTES Y PINTURAS	LUBRICANTS ET PAINTS	LUBRIFICANTI E PITTURE	LUBRIFIANTS ET PEINTURES	36
ACCESORIOS Y HERRAMIENTAS DE INSTALACIÓN	ACCESSORIES AND INSTALLATION TOOLS	ACCESSORI E ATTREZZI INSTALLAZIONE	ACCESSOIRES ET OUTILS D'INSTALLATION	48
ESTABILIZADORES, ELEVADORES Y SEGURIDAD	HYDROFOIL STABILIZER AND SECURITY	STABILIZZATORI, ASCENSORI E SICUREZZA	STABILISATEURS, POWER TRIM-LIFT ET SÉCURITÉ	57



AXONE NEMO

La primera diagnosis Smart en el mundo

Axone Nemo es un potente tablet diseñado para asegurar al mecánico un óptimo uso, tanto en el entorno de taller, como en las intervenciones en el exterior. Permite efectuar operaciones de diagnosis a gran velocidad. El chasis de magnesio le proporciona una mayor robustez y rigidez ante los golpes, muy ligero con gran capacidad de disipación de la temperatura interna. El software operativo IDC5 destaca todas sus características, además del "touch gesture" para alcanzar en poco tiempo las funciones deseadas.

The first Smart diagnosis in the world

Axone Nemo is a powerful tablet designed to ensure the mechanic optimal use, both in the workshop environment, as interventions abroad. It allows to carry out diagnosis operations at high speed. The magnesium chassis provides greater robustness and rigidity against shock, very light with great capacity to dissipate the internal temperature. The IDC5 operating software highlights all its features, in addition to the "touch gesture" to reach the desired functions in a short time.

La prima diagnosi Smart nel mondo

Axone Nemo è un potente tablet creato per assicurare al meccanico un ottimo uso, sia nelle officine sia negli interventi all'esterno. Permette di effettuare operazioni di diagnosi a gran velocità. La scocca in magnesio gli dona una maggior robustezza contro i colpi, molto leggero. Il software operativo IDC5 evidenzia tutte le sue caratteristiche, come il "touch gesture" per eseguire in poco tempo le funzioni desiderate.

Le premier outil de diagnostic intelligent au monde

Axone Nemo est une tablette puissante conçue pour assurer une utilisation mécanique optimale, aussi bien dans un atelier que lors des interventions à l'extérieur. Il permet d'effectuer des opérations de diagnostic à grande vitesse. Le châssis en magnésium offre une plus grande robustesse contre les chocs, très léger avec une grande capacité à dissiper la température interne. Le logiciel IDC5 met en évidence toutes ses fonctionnalités.

12" (2160 x 1440)
Intel Quad Core N3160
8 GB RAM
250 GB
WIFI double channel
Bluetooth 4.0 Low Energy
2 camera x 5 Megapixels

SOFTWARE IDC5

IDC5 es la última evolución de TEXA, gracias a la reescritura del código se incrementa la velocidad de trabajo, lo que garantiza una entrada de comunicación con la centralita casi inmediata. La nueva función "Esquemas eléctricos interactivos" permite consultar los esquemas eléctricos aprovechando las animaciones de los dispositivos implicados y generando un mapa interactivo con flujos de señales entrada o salida de centralitas.

IDC5 is the latest evolution of TEXA, thanks to the rewriting of the code the working speed is increased, which guarantees a communication input with the control unit almost immediately. The new function "Interactive electrical diagrams" allows consulting the electrical diagrams taking advantage of the animations of the devices involved and generating an interactive map with flows of signals input or output of control units.

IDC5 è l'ultima evoluzione di TEXA, grazie ai nuovi aggiornamenti, si incrementa la velocità di lavoro, che garantisce la comunicazione quasi immediata con l'unità di controllo. La nuova funzione "Diagrammi interattivi elettronici" permettono di consultare i diagrammi elettronici con l'animazione dei led generando una mappa interattiva con un flusso di segnali in entrata e in uscita della centralina.

IDC5 est la dernière évolution du célèbre logiciel TEXA, grâce à une importante réécriture du programme, la rapidité est encore augmentée, garantissant une entrée en communication presque immédiate avec les calculateurs. La nouvelle fonctionnalité appelée "Schémas Electriques Interactif" est très intéressante car elle permet de consulter les schémas électriques en exploitant les animations des dispositifs concernés et en générant une cartographie interactive avec les flux de signaux d'entrée ou de sortie des calculateurs.



Ref.				
RECAxONEMEMO	Axone Nemo	Axone Nemo	Axone Nemo	Axone Nemo
RECD06591	Navigator TXB Evolution	Navigator TXB Evolution	Navigator TXB Evolution	Navigator TXB Evolution
RECD127X0	Axone Nemo + Navigator TXB Marine	Axone Nemo + Navigator TXB	Axone Nemo + Navigator TXB	Axone Nemo + Navigator TXB
RECZ06590PC	Navigator TXB + PC	Navigator TXB + Laptop	Navigator TXB + PC	Navigator TXB + Pc portable
REC3901775	Kit maleta para guardar cables de interface	Hand case for harnesses	Kit per cavi intergaccia	Valise pour ranger les câbles d'interface
RECAGA00M1	Contrato de actualización software (y renovación anual).	Software contract and annual renovation	Contratto software (e rinnovo annuale).	Contrat de mise à jour logicielle (et renouvellement annuel).

TEXA

NAVIGATOR TXB EVOLUTION & AXONE NEMO / PC



SRAM 16Mb
MEMORY NAND Flash 8 GB
BLUETOOTH

NAVIGATOR TXB EVOLUTION

La evolución de la diagnosis, diseñado y desarrollado específicamente para el ambiente Marino.

Las características del hardware lo compatibilizan con todos los protocolos actualmente existentes, su conector CPC de 16 polos integrados, permite el uso de todos los cables de diagnosis. Es compatible con AXONE NEMO y PC. Gracias a la tecnología Bluetooth el técnico podrá realizar una cómoda diagnosis sin cables de por medio, incluso desde el pantalán.

Extremadamente potente, permite al mecánico una gestión fácil de los archivos de mapa. Los estándares CAN soportados incluyen la posibilidad de gestión CAN single wire y un CAN controller más para la diagnosis sobre más redes.

Permite la grabación de la sesión de diagnosis en modalidad "pruebas dinámicas", es decir con la embarcación en movimiento, para localizar averías específicas que no se podrían verificar en el amarre. La interfaz reconstruye una panorámica completa de la situación en la que la anomalía se ha verificado, proporcionando importantes elementos de análisis para identificar las causas de la avería.

The evolution of the diagnosis, designed and developed specifically for the marine environment.

The characteristics of the hardware make it compatible with all currently existing protocols, its integrated 16-pole CPC connector, allows the use of all diagnostic cables. It is compatible with AXONE NEMO and PC. Thanks to Bluetooth technology, the technician can make a comfortable diagnosis without wires, even from the jetty.

Extremely powerful, they allow the mechanic to easily manage the map files. The CAN standards supported include the possibility of CAN single wire management and a further CAN controller for the diagnosis of more networks.

It allows the recording of the diagnosis session in "dynamic tests" mode, that is to say with the boat in motion, to locate specific faults that could not be verified in the mooring. The interface reconstructs a complete panorama of the situation in which the anomaly has been verified, providing important elements of analysis to identify the causes of the failure.

L'evoluzione della diagnosi, disegnata e sviluppata specificamente per l'ambiente marino.

Le caratteristiche hardware lo rendono compatibile con tutti i protocolli attualmente esistenti, il suo connettore CPC 16 poli integrato consente l'utilizzo di tutti i cavi diagnostici. È compatibile con AXONE NEMO e PC. Grazie alla tecnologia Bluetooth il tecnico potrà realizzare una diagnosi senza cavi in mezzo, anche dal molo.

Estremamente potente, permette al meccanico una gestione facile degli archivi della mappa. Gli standard CAN supportati offrono la possibilità di gestire: CAN single wire e un altro CAN controller per eseguire le diagnosi su più reti.

Permette la registrazione di una sessione di diagnosi in modalità "prova dinamica", ovvero con l'imbarcazione in movimento, per constatare avarie specifiche che non si possono verificare in officina. La sua interfaccia permette di ricostruire una panorámica completa della situazione in cui l'anomalia si è verificata, fornendo gli elementi per identificare le eventuali avarie.

L'évolution du diagnostic, dessiné et développé spécialement pour l'environnement marin.

Les caractéristiques du matériel le rendent compatible avec tous les protocoles existants, son connecteur CPC 16 pôles intégré permet l'utilisation de tous les câbles de diagnostic. Il est compatible avec Axone Nemo et Pc. Grâce à la technologie Bluetooth, le technicien peut effectuer un diagnostic sans fil, même depuis le quai. Extrêmement puissant, il permet au mécanicien de gérer facilement les fichiers des cartes. Les normes CAN prises en charge incluent la possibilité d'une gestion CAN à fil unique et un autre contrôleur CAN pour le diagnostic en réseaux. Il permet l'enregistrement de la séance de diagnostic en mode «test dynamique» c'est à dire avec le bateau en mouvement pour localiser des défauts spécifiques non vérifiables en atelier. L'interface reconstruit un panorama complet de la situation dans laquelle l'anomalie a été constatée, fournissant des éléments d'analyse importants pour identifier les causes de la panne.

Consulte la lista actualizada de aplicaciones en:

See the updated list of applications in:

Vedi l'elenco aggiornato delle applicazioni in:

Consultez la liste mise à jour des applications sur:

www.texaiberica.com/cobertura-diagnosis

MOTORES INTRABORDA INBOARD ENGINES MOTORI ENTROBORDO MOTEURS IN-BORD	
CATERPILLAR	3196, 3176, 3126B, 3508B, 3508C, C12, C12 Acert, C18 Acert Tier 2, C32 Acert IMO II, C32 Acert Tier 2, C32 Acert Tier 2 HP, 3512 B HD, C3512B, 3512C HD, 3512C, 3516B HD, 32 Acert Tier 2 H.P. Recreational, C32 Acert Tier 3, C7, C7 Acert, C9 Acert., 3516B, 3516C HD, 3516C, C15 Acert, C6.6 Acert
CRUSADER	5.0. 5.7. 6.0. 8.1 MPI & HO MPI
CUMMINS / MW	QSD2.0-115 / 130 / 150 / 170, QSD2.8-220, QSD4.2-270 / 320 / 350, QSB5.9 / 6.7, QSC8.3, QSK19, QSL9, QSM11 (Sistema Inyección Bosch System injection Bosch Sistema Iniezione Bosch Système d'injection Bosch) Comon Rail
FIAT	C13, C78, C87, GE CURSOR 250E, 350E, 400E, N40, N60, N67, S30
FNM	HPEP, HPE 80-300 HP
HYUNDAI SEASALL	D150P/S, D170J/P/S, S220P/S, S250J/P/S, U125J/P/S
ILMOR	5.7L. 6.0L. 6.2L. MV-8
INDMAR	5.7, 6.0, 8.1, Steyr 256 Diesel
KOHLER	
LOMBARDINI Marine	LDW 194 JMT, LDW 240 JMT
MAN	D2868, V8-1000, V8-1200
MERCURISER	350, 377, 454, 496, 496MAG, 3.0L, 4.3L, 5.0L, 5.7L, 6.2L, 7.4L, 8.1L, 8.2L, TBI, MPI, Black Scorpion, Vazer, Mandos SmartCraft, D2.8D-Tronic
MERCURISER Diesel	VM D-Tronic, VM (no D-Tronic), MD2.0-115/130/150/170, MD2.8-270/320/350, TDI3.0-230/260, TDI4.2
MERCURY Racing Inbord	SCI, EFI, QC4V, 500EFI, 520, 525EFI, 540, 565, 575, 600, 850, Scorpion 377
MTU	MDEC C2
PCM MARINE Engines	5.0L, 5.7L, 6.0L, 8.1L
PERKINS	1106C-E60TA 6.0L
SEA-DOO	Speedster, Challenger, Utopia, Islandia, Wake, Wake Speedster, Sportster
SISU AGCO	44 CTIM-2V, 49/66/74/84 CTIM-4V
STEYR MOTORS	MO306H43WJ, MO54NA33, MO84K32, MO94K33, MO114K33, MO126M28, MO144M38, MO156K25, MO164M40, MO166M28, MO174V40, MO196K35, MO236K42, MO256H45, MO256H43, MO286H43 SE126E25, SE156E26, SE196E35, SE236E40, SE236S36 SE266, SE286, SE306J38
VM MOTORI	2.8L, 4.2L D-Tronic, MD704, MD706, MR504LB
VOLKSWAGEN Marine	SDI, TDI
VOLVO PENTA	KAD, EDG, EGC, EVC, GXI, OSI, GI, GSI, OSXI, IPS, TAMD 4BY2-150 / 180, 6BY2-220 / 260 (Sistema Inyección Bosch System injection Bosch Sistema Iniezione Bosch Système d'injection Bosch)
YANMAR	4BY3-150/180, 4JH, 6BY3-220/260, 6LY3, 8LV-320/350/370

MOTORES FUERABORDA OUTBOARD ENGINES MOTORI FUORIBORDO MOTEURS HORS-BORD	
EVINRUDE	(90 - 250 Ficht Ram) E-Tec 25 - 300 HP, DFI
HONDA Marine	BF 40-250 HP
JOHNSON	4 Stroke
MARINER	4 Stroke, OptiMax, Verado, DFI, EFI
MERCURY	4 Stroke, OptiMax, Verado, DFI, EFI
MERCURY Racing	OPTIMAX, DSI, VERADO 400R
PARSUN	40 EFI
SELVA Marine	4 S troke EFI
SUZUKI Marine	DF 40 -300 HP
TOHATSU	MFS, BFW, BFT
YAMAHA Marine	F, T, Z 30 - 350 HP

MOTOS DE AGUA PWC MOTO D'ACQUA SCOOTER DES MERS	
HONDA Marine	Aquatrax
KAWASAKI Marine	STX, Ultra
SEA-DOO	GTI, GTX, RXP, RXT, GTR, GTS, GTX-S, Spark, Wake Pro, Wake
YAMAHA Marine	Waverunner FX, FZR, FZS, GP, VX

**SIN CABLES DE INTERFACE
WITHOUT INTERFACE CABLE
SENZA CAVI INTERFACE
SANS CABLES D'INTERFACE**

	REC3902417 OBD, FNM Marine, VOLKSWAGEN, HYUNDAI	AM08
	REC3902659 Marine FPT	AM11
	REC3904277 Marine CUMMINS, MERCURISER Diesel, VM (not D-Tronic), KOHLER	AM24A
	REC3905159 Marine VOLVO EGC 05/05>05/07	AM26
	REC3905286 Marine MTU-MDEC	AM28
	REC3905397 Marine CATERPILLAR, PERKINS	AM29
	REC3906219 Marine TOHATSU	AM30
	REC3906891 Marine MAN	AM31
	REC3905015 Personal Water Craft KAWASAKI cable kit	

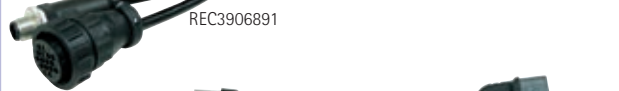

INTERFACE AM01

Ref. AM01

REC3902358



REC3902407	Marine HONDA / TOHATSU, PGM (FI)	AM02
REC3902247	Marine 2 pin MERCURY, MERCURISER	AM04
REC3902250	Marine 4 vie MERCURY, MERCURISER	AM05
REC3902413	Marine YAMAHA / SELVA	AM06
REC3909234	Marine 6 pin VOLVO PENTA	AM07
REC3902467	Marine VOLVO KAD - TAMD	AM09
REC3902864	Marine STEYR	AM12
REC3902865	Marine EVINRUDE	AM13
REC3902907	Marine VOLVO, MERCURISER (gasolina fuel benzina essence), MEFI-4, 4B,3,2,1, CRUSADER	AM14
REC3902931	Marine YANMAR	AM15
REC3903560	Marine SUZUKI	AM22
REC3905265	Marine MERCURISER / VM D-Tronic	AM27
REC3908405	PARSUNS	3151/ AP54



INTERFACE AM01CAN

Ref. AM01CAN

REC3903008



REC3902960	Marine VOLVO, MERCURISER (gasolina fuel benzina essence), MEFI-5 / EGC, ILMOR, CRUSADER, ILMOR, INDMAR, PCM (MEFI-5/EGC UBD-Msocket)	AM16
REC3903502	Marine VOLVO, EGC-EV	AM18
REC3904778	Marine MERCURY, MARINER, CUMMINS 2010+, MANDOS MCM, SMARTCRAFT	AM25
REC3907103	Marine STEYR with CAN Line protocol	AM32
REC3907642	YANMAR MARINE CAN CABLE	AM33



KIT DIAGNOSIS Y REPROGRAMACIÓN DE LLAVE CABLE KIT FOR DIAGNOSIS AND KEY REPROGRAMMING KIT PER LA DIAGNOSI E RIPROGRAMMAZIONE DI CHIAVE KIT DE DIAGNOSTIC ET REPROGRAMATION DE CLÉ

REC3906015 BRP Group

3151/AP43



PUNTAS DE DERIVACIÓN REFERRAL POINTS PUNTA DI DERIVAZIONE PONTS DE DÉRIVATION

REC3904048

AM10



Puede utilizarse con interface AM01 o AM01CAN dependiendo de la marca.

It can be used with AM01 or AM01CAN interface depending on the brand.
Può essere utilizzato con l'interfaccia AM01 o AM01CAN in base alla marca.
Peut être utilisé avec l'interface AM01 ou AM01CAN selon la marque.

SOPORTES

STANDS

SUPPORTI

SUPPORTS

SOPORTES DESCARGA DE EMBARCACIONES

RECH10
Para cargar o descargar embarcaciones de los remolques o cuna. Los remolques pueden entrar y salir de entre los gatos hidráulicos libremente, facilitando su tarea. Levantan embarcaciones de hasta 18 toneladas. Su recorrido de elevación es de 51 cm. Equipado con válvula de bloqueo que permite mantener el barco indefinidamente en la posición deseada. Puede actuar sobre tierra, grava, asfalto o cemento, tanto en la tienda, como en el varadero o exposición.

BOAT HANDLING JACKS & STANDS

RECH10
Work station for bottom repair & cleaning. Trailer rolls in out past jacks, allowing you to take boats on or off trailers easily. Jacks have an auto lock allowing boats to be left on indefinitely. Can be used on dirt, gravel, black top or cement. Can be used anywhere! Shop, yard, showroom. Lifts boats up to 40,000 lbs.

SUPPORTI SCARICO IMBARCAZIONI

RECH10
Per caricare o scaricare imbarcazioni da rimorchi o sostegni. I rimorchi possono entrare e uscire tra i crik idraulici liberamente, facilitando il compito. Solleva imbarcazioni fino a 18 tonnellate. Escursione max di 51 cm. Fornito di valvola di blocco che permette di mantenere la barca nella posizione desiderata per diversi tempi. Può essere usato su terra, ghiaia, asfalto o cemento, come in negozio o in esposizione.

SUPPORTS DE DÉCHARGE DE BATEAU

RECH10
Pour charger ou décharger des bateaux de remorques ou de berceaux. Les remorques peuvent entrer et sortir librement entre les vérins hydrauliques, ce qui facilite leur tâche. Ils lèvent des navires jusqu'à 18 tonnes. Sa course d'élevation est de 51 cm. Equipé d'une valve de blocage qui permet au navire d'être maintenu indéfiniment dans la position souhaitée. Il peut agir sur terre, gravier, asphalte ou ciment, aussi bien en magasin qu'en hangar à bateaux ou en exposition.

REF	INCLUYE	INCLUDED	INCLOSO	COMPREND
RECH10	Soportes hidráulicos	Jacks	Supporti idraulici	Supports hydrauliques x 4
	REC12 Soportes	Straight arms	Supporti	Supports x 4
	REC15 Soportes inclinados 25 cm	10" drop arms	Supporti inclinati 25 cm	Supports inclinés de 25 cm x 4
	REC20 Soportes asiento barco	4" x 18" contact pads	Supporti appoggi barche	Supports de siège de bateau x 4
RECH10-1/4	Soporte hidráulico	Jack	Supporto idraulico	Support hydraulique 1
	REC12 Soporte	Straight arm	Supporto	Support 1
	REC15 Soporte inclinados 25 cm	10" drop arms	Supporto inclinato 25 cm	Support incliné de 25 cm 1
	REC20 Soporte asiento barco	4" x 18" contact pad	Supporto appoggio barche	Support de siège de bateau 1



REF						
REC12	Soporte plano std.	Straight support standard	Braccia piatto standard	Support plat standard	83,8 - 132 cm	
	1ª posición	1st pin hole	1ª posizione	1ère position		900 kg
	2ª posición	2nd pin hole	2ª posizione	2ème position		1.800 kg
	3ª posición	3rd pin hole	3ª posizione	3ème position		3.600 kg
	4ª posición	4th pin hole	4ª posizione	4ème position	4.500 kg	
REC15	Soporte inclinado	Drop arm	Braccia	Support incliné	28 cm = 10"	
REC16	Soporte inclinado	Drop arm	Braccia	Support incliné	51 cm = 20"	
REC17	Suplemento	Single riser extension	Suplementi	Supplement	12,5 cm = 5"	
REC18	Suplemento	Single riser extension	Suplementi	Supplement	25 cm = 10"	
REC19	Soporte con goma	Large pad	Braccia contatto	Support	6.800 kg + 76 cm = 30"	
REC20	Soporte con goma	Large pad	Braccia contatto	Support	- 6.800 kg 45.7 cm = 18"	

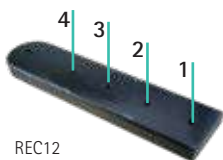

REF				
RECNSCYL	Pistón	Piston	Pistone	Vérin
RECKFW	Rueda hidráulica	Hydraulic jack FT-Wheel	Ruota idraulica	Roue



SOPORTES PARA EMBARCACIONES

BOAT STANDS

SUPPORTI PER IMBARCAZIONI

BERS ROULANT POUR BATEAU



REF	
RECE36	1.500 kg



REF
RECE36C



SOPORTES PARA COLAS

STANDS FOR STERN DRIVES

SUPPORTI PER PIEDI

SUPPORTS D'EMBASES

RECJO6HD
 Carro con gato hidráulico para la instalación de todo tipo de colas. Permite desmontar o montar colas, una sola persona. Especialmente útil en embarcaciones con plataforma integrada. Construido con brazos extra largos de sujeción y base con 4 ruedas neumáticas. Gran capacidad de elevación para colas de peso extra. También en colas de doble hélice. Varias regulaciones.

RECJO6HD
 Stern drive installer. Works in all makes and models. Allows one man to remove and install stern drives. Especially helpful on boats with integrated swim platforms. Built with extra long clamping arms and wheel base, plus heavyduty lifting capacity for those extra heavy drives. Also works great on dual prop drives. Unique low cost shop tool. 4 air tires allow for rugged yard use.

RECJO6HD
 Carro con crik idraulico per l'installazione di tutti i tipi di piedi. Permette ad una persona di smontare o montare i piedi da solo. Specialmente utile nelle imbarcazioni con piattaforma integrata. Costruito con larghi bracci di fissaggio e una base con 4 ruote pneumatiche. Grande capacità di sollevamento per piedi con peso extra. Anche per piedi con doppia elica. Varie regolazioni.

RECJO6HD
 Chariot avec vérin hydraulique pour l'installation de tous types d'embase. Il permet à une seule personne de démonter ou de monter des pieds. Particulièrement utile dans les bateaux avec plate-forme intégrée. Construit avec des bras de support extra longs et une base avec 4 roues pneumatiques. Grande capacité de levage pour des embases de poids important. Egalement en arbre double hélice.

REF
RECJO6HD



REF				
RECKOCYL	Pistón	Piston	Pistone	Vérin
RECKRW	Rueda completa	Hydraulic jack RE-Wheel	Ruota completa	Roue complète
RECKFW	Rueda hidráulica	Hydraulic jack FT-Wheel	Ruota idraulica	Roue
RECJO10	Suplemento 25 cm	Suplement 10"	Supplemento 25 cm	Supplément de 25 cm
RECHANDLEJO6HD	Maneta	Handle	Maniglia	Poignée
RECSRINGJO6HD	Muelle	Spring	Molla	Ressort



RECKOCYL



RECJO10



RECKRW



RECKFW



RECHANDLEJO6HD

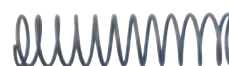

RECSRINGJO6HD

new

RECSR9
Soporte para 5 colas.
Mantiene el taller limpio y organizado.
Protege las colas de golpes y daños.

RECSR9
Holds 5 stern drives.
Keeps shop looking neat and clean.
Protects drives from being cratched and damaged.

RECSR9
Supporto per 5 piedi.
Mantiene l'officina pulita e organizzata.
Protegge i piedi dai colpi e dai danni.

RECSR9
Prise en charge de 5 embases.
Maintient l'atelier propre et organisé.
Protège les pieds d'embase des chocs et des dommages.

REF

RECSR9

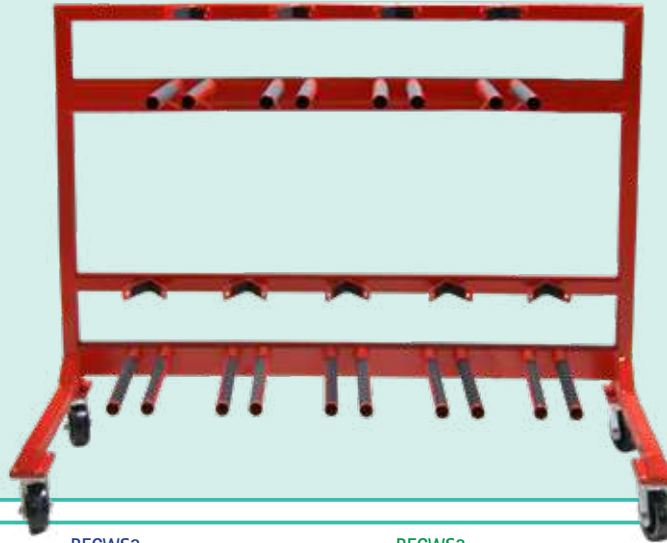

REF

RECSR9WHEEL



RECWS3
Soporte trabajo reparación todo tipo de colas y motores fueraborda.

RECWS3
Work station.
Holds all kind of drives and outboard engines.

RECWS3
Supporto lavoro per riparare tutti i tipi di piedi e motori fuoribordo.

RECWS3
Support pour les travaux de réparation de tous types d'embase et moteurs hors-bord.

REF

RECWS3



SOPORTES PARA MOTORES

STANDS FOR ENGINES

SUPPORTI PER MOTORI

SUPPORTS MOTEUR

Soporte de trabajo giratorio 360° con ruedas. Para todo tipo de motores; GM, FORD, VOLVO.
Ideal para reparaciones completas.

Allow engine to be rotated 360°. Adjustable mounting plate will accommodate all engine types.

Carrello supporto motore, permette il movimento per 360° utile per lavorazioni in coppa.
Fornito di ruote piene, può montare tutti i blocchi GM, FORD, VOLVO.

Support de travail rotatif à 360° avec roues. Pour tous types de moteurs; GM, FORD, VOLVO.

REF

RECTOOL1



YARES2
Soporte trabajo giratorio 360° con ruedas. Para todo tipo de motores: GM, FORD, VOLVO.
Ideal para reparaciones completas. Se le pueden adaptar los soportes referencias YARCHA para GM y YARFHA para FORD y probar motores en funcionamiento.

YARES2
360° rotating work support with wheels. For all types of engines: GM, FORD, VOLVO.
Ideal for complete repairs. You can adapt the YARCHA reference supports for GM and YARFHA for FORD and test running engines.

YARES2
Supporto lavoro girevole 360° con ruote. Per tutti i tipi di motori: GM, FORD, VOLVO.
Ideale per riparazioni complete. Si possono adattare i supporti di riferimento YARCHA per GM e YARFHA per FORD e provare i motori in funzione.

YARES2
Support de travail rotatif à 360° avec roues. Pour tous types de moteurs : GM, FORD, VOLVO.
Idéal pour des réparations complètes. Vous pouvez adapter les supports de référence YARCHA pour GM et YARFHA pour FORD et tester les moteurs en cours d'exécution.

REF	
YARES2	GM, FORD, VOLVO
YARFHA	Kit FORD
YARCHA	Kit GM

YARDARM



CARROS PORTAMOTOR

OUTBOARD MOTOR CARRIER

CARRELLO PORTA MOTORE

CHARIOT MOTEUR

Soporte portamotor con ruedas, para fueraborda. Con soporte para depósito de combustible y sandow de fijación.
Fabricado en acero zincado y tablero marino de 43 cm.
Diámetro ruedas: 15 cm

Manufactured in galvanized steel pipe and wooden board 43 cm. With tank holder and fixing strap.
Diameter wheels: 15 cm.

Supporto porta motore con ruote, per fuoribordo. Con supporto per serbatoio carburante. In acciaio zincato e bordo marino da 43 cm.
Diametro ruote: 15 cm

Chariot-moteur avec roues, pour hors-bord. Avec support pour réservoir de carburant et fixation sandow.
Fabriqué en acier galvanisé et planche marine de 43 cm.
Diamètre de roue: 15 cm

Ref			
GS73122	12 kg	50 kg	90 cm

GOLDENSHIP



Soporte portamotor con ruedas, para fueraborda. Con soporte para depósito de combustible y sandow de fijación.
Fabricado en acero zincado y tablero marino de 45 cm.
Diámetro ruedas: 36 cm

Manufactured in galvanized steel pipe and wooden board 45 cm. With tank holder and fixing strap.
Diameter wheels: 36 cm.

Supporto porta motore con ruote, per fuoribordo. Con supporto per serbatoio carburante. In acciaio zincato e bordo marino da 45 cm.
Diametro ruote: 36 cm

Chariot-moteur avec roues, pour hors-bord. Avec support pour réservoir de carburant et fixation sandow.
Fabriqué en acier galvanisé et panneau marin de 45 cm.
Diamètre de roue: 36 cm

Ref			
GS73119	12 kg	80 kg	95 cm

GOLDENSHIP



SOPORTE EXPOSITOR

OUTBOARD STAND

SUPPORTO ESPOSITORE

PRÉSENTOIR

Soporte portamotor con ruedas, para fueraborda. Plegable. Fabricado en acero zincado y tablero marino de 43 cm.

Folding display for outboards. Manufactured in galvanized steel pipe and wooden board of 43 cm.

Supporto per motori fuoribordo. Pieghevole. In acciaio zincato e bordo marino da 43 cm.

Chariot-moteur sans roues, pour hors-bord. Pliable. Fabriqué en acier galvanisé et planche marine de 43 cm.

Ref			
GS73120	6 kg	40 kg	90 cm

GOLDENSHIP



DIRECCIÓN MECÁNICA

STEERING SYSTEM

TIMONERIA MECCANICA

DIRECTION MÉCANIQUE

CAJA DE DIRECCIÓN AJUSTABLE ZTS

Con mecanismo antiretorno. Elimina el «feedback» de la hélice. Nº vueltas babor-estribor: 3.8. Para utilizar con cables 3000 SS. Reemplaza Teleflex-Morse® NFB Safe-T II, NFB 4.2, T73BRFC

ZTS ROTARY SINGLE HELM

Zero torque steering rotary helm. Eliminates prop feedback load. Precise response of 3.8 turns lock-to-lock. For use with the steering cables 3000 SS. Replaces Teleflex-Morse® NFB Safe-T II, NFB 4.2, T73BRFC

TIMONERIA ZTS

Timoneria con mecanismo anti-retorno. Elimina il feedback delle eliche. Nº giri destra e sinistra: 3,8. Da utilizzare con cavi: 3000 SS. Rimpiazza TeleflexMorse®NFB Safe-T II, NFB 4.2, T73BRFC

BOÎTIER DE DIRECTION ZTS

Avec mécanisme anti-retour. Élimine le "retour" de l'hélice. Nombre de tours bâbord-tribord: 3.8. Utilisation avec les câbles 3000 SS. Remplace Teleflex-Morse® NFB Safe-T II, NFB 4.2, T73BRFC

REF		Helm	Timoneria	Boitier de direction
PRE500010	Caja de dirección	Helm	Timoneria	Boitier de direction
PRE500012	Ménsula de montaje 90°	Bezel kit 90°	Coprizzo 90°	Support incliné 90°
PRE500014	Ménsula de montaje 20°	Bezel kit 20°	Coprizzo 20°	Support incliné 20°



Caja de dirección con sistema de ángulo ajustable hasta 40°. Se acomoda la postura de conducción más idónea para el piloto.

Tilt rotary steering system to use with the steering cables 3000 SS. With full 40 degree range of motion.

Timoneria con sistema di angolo fino a 40°. Si può impostare la posizione più idonea di guida per il pilota.

Boîtier de direction avec système d'angle réglable jusqu'à 40°. Permet d'obtenir la position de conduite la plus appropriée pour le pilote.

REF	
PRE500007	ZTS
PRE370987	3000



PRE500007



PRE370987

KIT LT

KIT LT

KIT LT

KIT LT

Compuesto por 1 caja operadora, 1 cable de dirección según las medidas indicadas y un bisel de montaje de 90°. Radio mínimo curvatura del cable 360°. Carrera del cable 230 mm con 2,5 vueltas de volante

Rotary steering system: Helm, Steering cable and 90° bezel. Travel 230 mm. 2,5 turns lock to lock.

Composto da una timoneria, 1 cavo timoneria secondo le dimensioni indicate e una piastra da 90°. Raggio minimo curvatura del cavo 360°. Corsa cavo 230mm con 2,5 giri del volante.

Composé d'un boîtier de commande, d'un câble de direction selon les mesures indiquées et d'un support incliné à 90°. Course du câble 230 mm avec 2,5 tours de volant

REF	5,5 m	55 hp
PRE208005	5' / 1,50 m	
PRE208006	6' / 1,80 m	
PRE208007	7' / 2,10 m	
PRE208008	8' / 2,45 m	
PRE208009	9' / 2,75 m	
PRE208010	10' / 3,05 m	

REF	5,5 m	55 hp
PRE208011	11' / 3,35 m	
PRE208012	12' / 3,65 m	
PRE208013	13' / 3,95 m	
PRE208014	14' / 4,25 m	
PRE208015	15' / 4,60 m	
PRE208016	16' / 4,90 m	



KIT 3000 SS		KIT 3000 SS		KIT 3000 SS		KIT 3000 SS	
<p>Compuesto por 1 caja operadora, 1 cable de dirección fabricado en acero inox según medidas indicadas y un bisel de montaje de 90°. Para embarcaciones con un esfuerzo máximo de 140 kg en el punto de unión. Puede montarse en cualquier posición con movimientos de 90°. Radio mínimo curvatura del cable 200 mm. Carrera del cable 230 mm con 3,6 vueltas de volante. Reemplaza Teleflex-Morse® Safe-T QC, Safe-T, Uflex T71FC</p>		<p>Rotary steering system: Helm, Stainless Steel Cable and 90° Bezel. Stainless steel inner cable with spring stainless steel enclosure coil. Maximum working load: 300 lb at the tiller arm. Three turns lock to lock. Travel 230 mm. Replaces Teleflex-Morse® Safe-T QC, Safe-T, Uflex T71FC</p>		<p>Composto da una timoneria, 1 cavo timoneria in acciaio inox, secondo le misure richieste e una piastra di montaggio di 90°. Per imbarcazioni con uno sforzo massimo di 140kg nel punto di unione. Si può montare in qualunque posizione con un movimento di 90°. Raggio minimo curvatura 200mm. Corsa del cavo 230mm con 3,6 giri del volante. Rimpiazza Teleflex-Morse® Safe-T QC, Safe-T, Uflex T71FC</p>		<p>Composé de 1 boîtier de commande, 1 câble de direction en acier inoxydable selon les mesures indiquées et un support incliné à 90°. Pour les bateaux avec un effort maximum de 140 kg au point de jonction. Course du câbles 230 mm avec 3,6 tours de volant Remplace Teleflex-Morse® Safe-T QC, Safe-T, Uflex T71FC</p>	
REF		REF		REF		REF	
PRE315008	8' / 2,45 m	PRE315015	15' / 4,60 m	PRE315016	16' / 4,90 m	PRE315017	17' / 5,20 m
PRE315009	9' / 2,75 m	PRE315018	18' / 5,50 m	PRE315019	19' / 5,80 m	PRE315020	20' / 6,10 m
PRE315010	10' / 3,05 m						
PRE315011	11' / 3,35 m						
PRE315012	12' / 3,65 m						
PRE315013	13' / 3,95 m						
PRE315014	14' / 4,25 m						

CABLES DE DIRECCIÓN LT		LT STEERING CABLE		CAVO DI TIMONERIA LT		CÂBLES DE DIRECTION LT	
REF		REF					
PRE250005	5' / 1,50 m	PRE250011	11' / 3,35 m				
PRE250006	6' / 1,80 m	PRE250012	12' / 3,65 m				
PRE250007	7' / 2,10 m	PRE250013	13' / 3,95 m				
PRE250008	8' / 2,45 m	PRE250014	14' / 4,25 m				
PRE250009	9' / 2,75 m	PRE250015	15' / 4,60 m				
PRE250010	10' / 3,05 m	PRE250016	16' / 4,90 m				

CABLES DE DIRECCIÓN 3000 SS DE ACERO INOX		STEERING CABLE 3000 SS STAINLESS STEEL		CAVO TIMONERIA 3000 SS ACCIAIO INOX		CÂBLES DE DIRECTION 3000 SS ACIER INOXYDABLE	
REF		REF					
PRE550008	8' / 2,45 m	PRE550018	18' / 5,50 m				
PRE550009	9' / 2,75 m	PRE550019	19' / 5,80 m				
PRE550010	10' / 3,05 m	PRE550020	20' / 6,10 m				
PRE550011	11' / 3,35 m	PRE550021	21' / 6,40 m				
PRE550012	12' / 3,65 m	PRE550022	22' / 6,70 m				
PRE550013	13' / 3,95 m	PRE550023	23' / 7,00 m				
PRE550014	14' / 4,25 m	PRE550024	24' / 7,30 m				
PRE550015	15' / 4,60 m	PRE550025	25' / 7,60 m				
PRE550016	16' / 4,90 m	PRE550026	26' / 7,90 m				
PRE550017	17' / 5,20 m						

CABLES DE DIRECCIÓN MEGA-UR		MEGA-UR STEERING CABLE		CAVO TIMONERIA MEGA-UR		CÂBLES DE DIRECTION MEGA-UR	
REF		REF					
PRE509007	7' / 2,14 m	PRE509014	14' / 4,25 m				
PRE509008	8' / 2,45 m	PRE509015	15' / 4,60 m				
PRE509009	9' / 2,75 m	PRE509016	16' / 4,90 m				
PRE509010	10' / 3,05 m	PRE509017	17' / 5,20 m				
PRE509011	11' / 3,35 m	PRE509018	18' / 5,50 m				
PRE509012	12' / 3,65 m	PRE509019	19' / 5,80 m				
PRE509013	13' / 3,95 m	PRE509020	20' / 6,10 m				

Reemplaza | Replace | Rimpiazzano | Remplace:
Ultraflex T71FC, T72FC, T73NR FC, T81FC, T82FC, T83NR FC.
Teleflex Safe-T QC, NFB 4.2, NFB Safe-T II

ACCESORIOS DIRECCIÓN MECÁNICA	ACCESSORIES FOR STEERING SYSTEM	ACCESSORI PER TIMONERIA MECCANICA	ACCESSOIRES POUR DIRECTION MÉCANIQUE
REF			
PRE370618	Cardan de unión del cable de dirección al motor. Swivel joint for steering cables.	Per unire cavi timoneria al motore.	Union cardan du câble de direction au moteur.
PRE370046	Soporte para cable de dirección. Para montaje en el espejo de popa Bracket kit for inboard transom steering mount.	Supporto per cavi timoneria. Per il montaggio nello specchio di poppa.	Support pour câble de direction. Pour montage sur le tableau AR
PRE370613	Soporte para cable de dirección. Para montaje estanco en los laterales de la embarcación. Regulable. Bracket kit for inboard side splashwell steering mount.	Supporto per cavi timoneria. Montaggio della flangia ai lati dell'imbarcazione. Regolabile.	Support pour câble de direction. Pour un montage étanche sur les côtés du bateau. Réglable.
PRE370619	Rótula para unión rápida del cable de dirección al motor. Ball joint for steering cables.	Giunto per unire i cavi timoneria al motore.	Rotule pour une connexion rapide du câble de direction au moteur.
PRE370621	Barra de reenvío para conexión de los cables de dirección. Fabricada en acero inox. Reforzada. Link arm for outboards steering.	Barra di direzione per collegare i cavi. In acciaio inox. Rinforzata.	Barre de renvoi pour connecter les câbles de direction. Fabriqué en acier inoxydable. Renforcé



PRE370618



PRE370046



PRE370613



PRE370619



PRE370621

DIRECCIÓN HIDRÁULICA

HYDRAULICS STEERING SYSTEM

TIMONERIA IDRAULICA

DIRECTION HYDRAULIQUE

FUERABORDAS 150 HP

OUTBOARDS 150 HP

FUORIBORDO 150 HP

HORS-BORD 150 HP

Bomba de aluminio, con válvula anti-retorno incorporada. Cilindro de aluminio y acero inox. con purgadores. Se suministra completa con racors, tubo flexible de rilsan y 2L de aceite hidráulico

Helm pump made in aluminum, with non-return valve incorporated. Cylinder in aluminum and stainless steel, with breather valves. Completed with racors, rilsan tubing and 2L hydraulic oil.

Corpo pompa in alluminio, con valvola anti-ritorno incorporata. Cilindro in alluminio e acciaio inox, con spurgo. Si vende completa di raccordi, tubo flessibile e 2 l di olio idraulico.

Pompe en aluminium, avec clapet anti-retour intégré. Vérin en aluminium et acier inoxydable. Livré complet avec raccords, tube flexible et 2L d'huile hydraulique

				TX4200K 150 HP	TX6400K 300 HP
Modelo bomba	Pump model	Modello pompa	Modèle de pompe	BayStar	SeaStar
Capacidad bomba	helm volume	Cap. Pompa	Capacité de la pompe	23 cm ³	27,8 cm ³
Modelo cilindro	Cylinder model	Mod. Cilindro	Modèle de vérin	HC4645H	HC5345H
Capacidad cilindro	Cylinder volume	Cap. Cilindro	Cylindrée	105 cm ³	139 cm ³
Carrera del pistón	Cylinder travel	Corsa pistone	Course du vérin	206 mm	206 mm
Nº vueltas babor-estribor	Turns lock to lock	Nº giri a destra e sinistra	No. tourne bâbord-tribord	5	5
Manguera con racors	Hose with racors	Tubo con raccordo	Tuyau avec raccords	2 x 6 m	2 x 7 m
Velocidad máxima	Max. speed	Velocità max	Vitesse maximale	50 kn	65 kn

BayStar
TX4200K

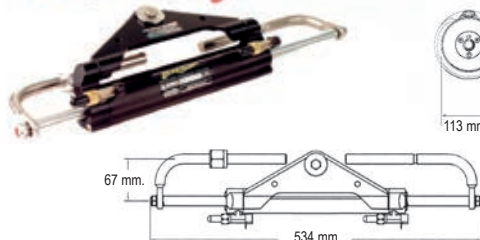

SeaStar
TX6400K



new

REF				
TXHC6845	Cilindro montaje frontal	O/b cylinder, front mount	Cilindro di montaggio frontale	Cylindre montage frontal
TXHH5271	Bomba dirección 1.7	Seastar front mount helm 1.7	Pompa sterzo 1.7	Pompe direction 1.7
TXHH5272	Bomba dirección 2.4	Seastar front mount helm 2.4	Pompa sterzo 2.4	Pompe direction 2.4
TXHH5273	Bomba dirección 2.0	Seastar front mount helm 2.0	Pompa sterzo 2.7	Pompe direction 2.0
TXHA6802	Kit 1 cilindro x 2 motores	Hardware kit, 2 engine x 1 cylinder	Kit 1 cilindro x 2 motori	Kit 1 cylindre x 2 moteurs
TXHA6804	Kit 2 cilindros x 2 motores	Hardware kit, 2 engine x 2 cylinder	Kit 2 cilindri x 2 motori	Kit 2 cylindres x 2 moteurs
TXHA6806	Kit 2 cilindros x 3 motores	Hardware kit, 3 engine x 2 cylinder	Kit 2 cilindri x 3 motori	Kit 2 cylindres x 3 moteurs
TXH06820	Barra 635-673 mm	Tiebar 635-673 mm	Barra 635-673 mm	Barre 635-673 mm
TXH06821	Barra 676-744 mm	Tiebar 676-744 mm	Barra 676-744 mm	Barre 676-744 mm
TXH06822	Barra 747-869 mm	Tiebar 747-869 mm	Barra 747-869 mm	Barre 747-869 mm
TXH06823	Barra 871-1092 mm	Tiebar 871-1092 mm	Barra 871-1092 mm	Barre 871-1092 mm







TXHC6845



TXHH5271
TXHH5272
TXHH5273



TXHC6820
TXHC6821
TXHC6822
TXHC6823



TXHC6802



TXHC6804



TXHC6806

ACCESORIOS SEASTAR SEASTAR ACCESSORIES ACCESSORI SEASTAR ACCESSOIRES SEASTAR

REF						
TXMP5126	26' / 8 m	2	Tubos hidráulicos para TX6400K	Hydraulic hoses for TX6400K	Tubi idraulici per TX6400K	Tuyaux hydrauliques pour TX6400K
TXHS5157			Kit reparación cilindro	Seal kit repair cylinder	Kit di riparazione cilindro	Kit réparation verin
TXHP6032			Kit reparacion juntas bomba	Service kit for seastar helms	Kit riparazione pompa	Kit pour pompe
TXHP6011			Racor codo 45°	Orb fitting 45° elbow	Racordo gomito 45°	Raccord coude 45°
TXHP6010			Racor de conexión tubos TX6400K	Fitting for TX6400K	Racordo per TX6400K	Raccord pour direction TX6400K
TXHP4600			Kit reparación cilindro	Seal kit repair baystar cylinder	Kit riparazione cilindro	Kit réparation verin
TXHF6004	2		Racor codo 90°	Fitting 90°	Gomito 90°	Coude 90°
TXHF5530	3		Racor T 3 vías	Kit union T	Kit unione T	Kit T union



TXMP5126



TXHS5157



TXHP6032



TXHP6011



TXHP6010



TXHP4600



TXHF6004



TXHF5530



KITS		KIT		KITS		KITS	
Bomba de aluminio, con válvula antirretorno y sobrepresión. Cilindro de aluminio y acero inoxidable, con purgadores. Se suministra completa con racors de latón cromado, tubo flexible de rilsan y aceite hidráulico.		Helm pump made in aluminum, with a non-return and pressure relief valves. Cylinder in aluminum and stainless steel, with breather valves. Completed with racors, rilsan tubing and hydraulic oil.		Corpo pompa in alluminio con valvola anti-ritorno e sovrappresione. Cilindro in alluminio e acciaio inox, con spurgo. Si vende completa di raccordi in ottone cromato, tubo flessibile e olio idraulico.		Pompe en aluminium, avec soupape de refoulement et de surpression. Vérin en aluminium et acier inoxydable. Livré complet avec raccords en laiton chromé, tuyau flexible et huile hydraulique.	
				GS41062	GS41065	GS41066	GS41059
				80 hp	150 hp	300 hp	350 hp
Modelo bomba	Pump model	Modello pompa	Modèle de pompe	GM3-MRA	GMO-MRA	GM2-MRA01	GM2-MRA01
Capacidad bomba	helm volume	Cap. Pompa	Capacité de la pompe	14 cm ³	17 cm ³	27 cm ³	27 cm ³
Modelo cilindro	Cylinder model	Mod. Cilindro	Modèle de vérin	MC90B	MC150BR	MC300A	MC350A
Capacidad cilindro	Cylinder volume	Cap. Cilindro	Cylindrée	75 cm ³	83 cm ³	130 cm ³	140 cm ³
Carrera del pistón	Cylinder travel	Corsa pistone	Course du vérin	206 mm	200 mm	198 mm	198 mm
Nº vueltas babor-estribor	Turns lock to lock	Nº giri destra e sinistra	No. tours bâbord-tribord	5,2	4,9	4,9	5,2
Manguera con racors	Hose with racors	Tubo con raccordo	Tuyau avec raccords	2 x 5 m	2 x 6 m	2 x 7 m	2 x 7,5 m
Ø Tubo	Tube Ø	Ø Tubo	Ø Tuyau	6,3 mm = 1/4"	6,3 mm = 1/4"	7,94 mm = 5/16"	7,94 mm = 5/16"



KITS DIRECCIÓN HIDRAULICA PARA COLAS

Bomba de aluminio estampado en caliente.
Eje de acero inox AISI 316.
Rotor a 7 pistones fabricado en acero.
Cilindro de aluminio y acero inox.
Se suministra completa con racors, 2 x 7,5 m tubo flexible de rilsan y 2 L de aceite hidráulico.

HYDRAULIC STEERING FOR STERN-DRIVE KITS

Helm pump made in aluminum with hot pressing processing (not casting).
Shaft made of stainless steel AISI 316.
7 pistons rotor made in steel.
Cylinder in aluminum and stainless steel, with breather valves.
Completed with racors, rilsan tubing and 2 L hydraulic oil.

KIT TIMONERIA IDRAULICA PER PIEDI

Corpo pompa in alluminio con stampaggio a fusione.
Asse in acciaio inox AISI316.
Cilindro a 7 pistoni fabbricato in acciaio.
Cilindro in alluminio e acciaio inox.
Si vende completo di raccordi, 2x7,5 m di tubo flessibile e 2 l di olio idraulico.

DIRECTION HYDRAULIQUE POUR EMBASE

Pompe en aluminium estampé à chaud.
Arbre en acier inoxydable AISI 316.
Rotor à 7 pistons en acier.
Vérin en aluminium et acier inoxydable.
Livré complet avec raccords, 2 tuyaux flexibles de 7,5 m et 2 litres d'huile hydraulique.

SERVO-ASISTIDA	POWER ASSISTED	SERVOASSISTITO	ASSISTÉE	GS41053
Denominación	Model	Modello	Dénomination	GF150ET
Modelo bomba	Pump model	Modello pompa	Modèle de pompe	GM2-MRA01
Capacidad bomba	helm volume	Cap. pompa	Capacité de la pompe	27 cm ³
Modelo cilindro	Cylinder model	Mod. cilindro	Modèle de vérin	MC150
Capacidad cilindro	Cylinder volume	Cap. pompa	Cylindrée	88cm ³
Carrera del pistón	Cylinder travel	Corsa pistone	Course du vérin	200 mm
Peso bomba	Helm weight	Peso pompa	Poids de la pompe	3 kg
Nº vueltas babor-estribor	Turns lock to lock	Nº giri destra e sinistra	No. tours bâbord-tribord	3,4
Ø Tubo	Tube Ø	Ø Tubo	Ø Tuyau	7,94 mm / 5/16"
Longitud tubo	Tube length	Lungh. tubo	Longueur tuyau	2 x 7,5 m



SIN SERVO	NON POWER ASSISTED	SERVOASSISTITO	ASSISTÉE	GS41054
Denominación	Model	Modello	Dénomination	GF300BET
Modelo bomba	Pump model	Modello pompa	Modèle de pompe	GM2-MRA03
Capacidad bomba	helm volume	Cap. pompa	Capacité de la pompe	32 cm ³
Modelo cilindro	Cylinder model	Mod. cilindro	Modèle de vérin	MC300BET
Capacidad cilindro	Cylinder volume	Cap. cilindro	Cylindrée	146 cm ³
Carrera del pistón	Cylinder travel	Corsa pistone	Course du vérin	200 mm
Peso bomba	Helm weight	Peso pompa	Poids de la pompe	3,7 kg
Nº vueltas babor-estribor	Turns lock to lock	Nº giri destra e sinistra	No. tours bâbord-tribord	4,6
Ø Tubo	Tube Ø	Ø Tubo	Ø Tuyau	7,94 mm / 5/16"
Longitud tubo	Tube length	Lungh. tubo	Longueur tuyau	2 x 7,5 m



ACCESORIOS DIRECCIÓN HIDRAULICA

ACCESSORIES FOR HYDRAULIC STEERING SYSTEM

ACCESSORI PER TIMONERIA IDRAULICA

ACCESSOIRES POUR DIRECTION HYDRAULIQUE

REF	R.O. OEM				(mm)	
GS41080		Barra de dirección para conexión de los cables de dirección. Acero inox.	Link arm for outboards steerings. Stainless steel.	Barra di rinvio per la connessione dei cavi timoneria. Fabbricata in acciaio inox.	Barre de renvoi pour connecter les câbles de direction. Acier inoxydable.	320 - 340
GS41082		Barra de dirección con conexión rápida para conexión de los cables de dirección. Acero inox.	Link arm quick connection for outboards steerings. Stainless steel.	Barra di rinvio con connessione rapida per la connessione dei cavi timoneria. Fabbricata in acciaio inox.	Barre de renvoi avec connexion rapide pour connecter les câbles de direction. Acier inoxydable.	330 - 370
GS41083		Barra de unión para el acople de dos motores	Universal tie bar for two engines	Barra di unione per accoppiamento di due motori.	Barre d'accouplement pour deux moteurs	850
GS41084	6E5-61301-01 6E5-61301-00	Barra de unión con conexión a rótula para el acople de dos motores fueraborda hasta 300 hp. Acero inox. Aisi 316.	Universal tie bar with spherical joint for two engines up to 300 hp. Made in stainless steel.	Barra di unione con snfo sferico per due motori fuoribordo fino a 300hp. In acciaio inox aisi316	Kit barre d'accouplement à rotule pour deux moteurs hors-bord jusqu'à 300 HP. Acier inoxydable. Aisi 316.	640 - 780



GS41080
GOLDENSHIP



MAVI MARE
GS41083



GS41082



GOLDENSHIP

GS41084

BOMBA

PUMP

POMPA

POMPE

REF	R.O. OEM
GS41070	GM3-MRA
GS41071	GM0-MRA
GS41072	GM2-MRA01
GS41073	GM2-MRA03



CILINDRO

CYLINDER

CILINDRO

VERIN

REF	R.O. OEM
GS41077	MC350HD
GS41060	MC90B
GS41063	MC150BR
GS41089	MC300A

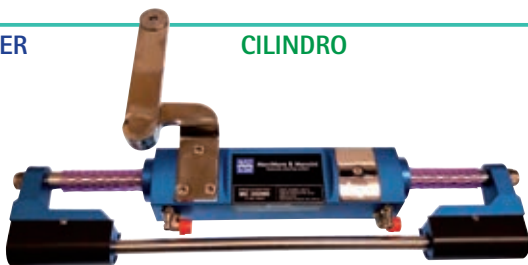

CONECTORES

CONNECTORS

PIASTRA CONNESSIONE

CONNECTEURS

REF		
GS41067	Honda 115-130	1
GS41068	Yamaha 40-50-60-70 HP Honda 115-130 HP	1
GS41069	Mercury Optimax 115 Mercury 150 EFI	1



GS41069

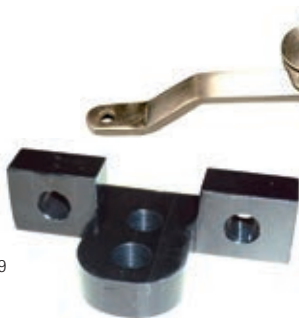

GS41067



GS41068

ACEITE PARA DIRECCIÓN HIDRÁULICA

OIL FOR HYDRAULIC STEERING SYSTEM

OLIO PER TIMONERIA IDRAULICA

HUILE POUR DIRECTION HYDRAULIQUE

REF	
GS41074	1 L



MANDOS UNIVERSALES Y ACCESORIOS

UNIVERSAL CONTROLS AND ACCESSORIES

CONTROLLI UNIVERSALI E ACCESSORI

COMMANDES UNIVERSELLES ET ACCESSOIRES

MANDO ELECTRÓNICO

ELECTRONIC CONTROL

SCATOLA DI COMANDO

COMMANDE ÉLECTRONIQUE

Reemplaza y mejora el funcionamiento de los mandos mecánicos tradicionales, permitiendo un control más preciso y suave de las maniobras. Se suministran en kits completos con todos los componentes para sustituir de modo sencillo los mandos tradicionales, listos para instalar y operar. Sistema de conexión CANbus. Alimentación estandar 12V (24V Bajo demanda).

- Hasta 6 puestos de control.
- Sincronización de r.p.m. en ambos motores.
- Posibilidad de aumentar y reducir las revoluciones del motor mediante ligeras pulsaciones de los botones de control.
- Puede incorporar mandos de control remoto mediante conexión «CANbus».
- Memoria de diagnósticos de avisos y alarmas.

Easily upgrade the traditional boat mechanical controls. Gives finger tip, precise control of your engines shift and throttle functions. Supplied in complete kits with all components required and ready to install. Latest CANbus technology for easy installation and set up. 12V Standard power (24V on demand).

- Can be connected up to 6 control heads.
- Auto synchronization r.p.m.
- Possibility of throttle in «BUMP» mode.
- Can incorporate Handheld Remote Controls.
- Memory of diagnostics checks of warning and alarms.

Sostituisce e migliora la scatola di comando tradizionale, permettendo un controllo più preciso delle manovre. Si vende in kit completo con tutti i componenti richiesti per sostituire in modo semplice la scatola di comando tradizionale. Tecnologia CANbus, Alimentazione standard 12V (24V on demand).

- Fino a 6 postazioni di controllo
- Auto sincronizzazione r.p.m.
- Possibilità di diminuire e aumentare i giri del motore, tramite un pulsante di controllo.
- Si può incorporare comandi di controllo remoto tramite la connessione CANbus
 - Memoria diagnostica di avviso e allarme.

Elle remplace et améliore le fonctionnement des commandes mécaniques traditionnelles, permettant un contrôle plus précis et plus fluide des manœuvres. Ils sont fournis en kits complets avec tous les composants pour remplacer facilement les commandes traditionnelles, prêts à installer et à utiliser. Système de connexion CANbus. Alimentation standard 12V (24V sur demande).

- Jusqu'à 6 points de contrôle peuvent être connectés.
- Synchronisation de r.p.m. dans les deux moteurs.
- Possibilité d'augmenter et de réduire les tours du moteur en appuyant légèrement sur les boutons de commande.
- Vous pouvez intégrer des commandes de télécommande via une connexion «CANbus».
- Mémoire de diagnostic des avertissements et alarmes.



KITS	KITS	KIT	KITS	
1 MOTOR INTERIOR 1 ESTACIÓN	1 INBOARD ENGINE 1 STATION	1 MOTORE ENTROBORDO 1 STAZIONE	1 MOTEUR IN-BORD 1 STATION	GLE1M1EI
Actuador SA2	Actuator SA2	1 attuatore SA2	Actionneur SA2	1
Mando 1 palanca - 2 pulsadores	Single Control Head - 2-buttons	Telecomando 1 leva - 2 pulsanti	1 commande à levier - 2 boutons	1
Cable comunicación mando-actuador 12 m	Station comm. cable 40ft.	Cavo comunicazione comando-attuatore 12m	Câble de communication commande-actionneur 12 m	1
Resistencia terminal BUS	Terminating resistor	Resistenza terminale BUS	Résistance de borne BUS	2
Cable alimentación DC - actuador 9 m.	Harness DC power-actuador 30ft.	Cavo alimentazione DC- attuatore 9m	Câble d'alimentation CC - actionneur 9 m.	1
Cable Start Interlock 9 m	Harness Start Interlock 30ft	Cablaggio start e blocco 9m	Câble de verrouillage de démarrage 9 m	1
Cable encendido «jumper»	Harness Ignition enable jumper	Cablaggio accensione	Câble d'allumage de cavalier	1
Cable encendido 9 m	Harness Ignition 40ft.	Cablaggio accensione	Câble sur 9 m	1
KIT 2ª ESTACIÓN 1 MOTOR INTERIOR	KIT 2ND STATION 1 ENGINE INBOARD	KIT 2ª STAZIONE 1 MOTORE ENTROBORDO	KIT DE 2E STATION 1 MOTEUR IN-BORD	GLE1M2EI
Mando 1 palanca - 2 pulsadores	Single Control Head - 2-buttons	Telecomando- 1 leva- 2 pulsanti	1 commande à levier - 2 boutons	1
Cable comunicación mando-actuador 12 m	Station comm. cable 40ft.	Cavo cablaggio comando-attuatore 12m.	Câble de communication commande-actionneur 12 m	1

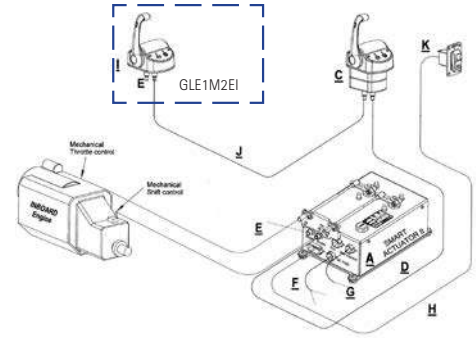

2 MOTORES INTERIORES 1 ESTACIÓN	2 INBOARD ENGINES 1 STATION	2 MOTORI ENTROBORDO 1 STAZIONE	2 MOTEURS IN-BORD 1 STATION	GLE2M1EI
Actuador SA2	Actuator SA2	Attuatore SA2	Actionneur SA2	2
Mando 2 palanca - 2 pulsadores	Twin Control Head - 2-buttons	Telecomando 2 leve- 2 pulsanti	2 commandes à levier - 2 boutons poussoirs	1
Cable comunicación mando-actuador 12 m	Station comm. cable 40ft.	Cavo cablaggio comando-attuatore 12m	Câble de communication commande-actionneur 12 m	1
Cable comunicación actuador-actuador 6 m	Station comm. cable 20ft.	Cavo cablaggio comando-attuatore 6m	Câble de communication actionneur-actionneur 6 m	1
Resistencia terminal BUS	Terminating resistor	Resistenza terminale BUS	Résistance de borne BUS	2
Cable alimentación DC - actuador 9 m.	Harness DC power-actuador 30ft.	Cavo alimentazione BUS-attuatore 9m	Câble d'alimentation CC - actionneur 9 m.	2
Cable Start Interlock 9 m	Harness Start Interlock 30ft	Cablaggio start e blocco 9m	Câble de verrouillage de démarrage 9 m	2
Cable encendido «jumper»	Harness Ignition enable jumper	Cablaggio accensione	Câble d'allumage de cavalier	1
Cable actuador sensor tacómetro	Harness Act. enable tach sender.	Cavo attuatore sensore tachimetro	Câble d'actionneur de capteur de tachymètre	1
Cable encendido 12 m	Harness Ignition 40ft.	Cavo accensione 12m	Câble sur 12 m	1
KIT 2ª ESTACIÓN 2 MOTORES INTERIOR	KIT 2ND STATION 2 ENGINE INBOARD	KIT 2ª STAZIONE 2 MOTORI ENTROBORDO	KIT DE 2E STATION 2 MOTEURS IN-BORD	GLE2M2EI
Mando 2 palanca - 2 pulsadores	Twin Control Head - 2-buttons	Telecomando 2 leve-2 pulsanti	2 commandes à levier - 2 boutons poussoirs	1
Cable comunicación mando-actuador 12 m	Station comm. cable 40ft.	Cavo cablaggio comando-attuatore 12m	Câble de communication commande-actionneur 12 m	1

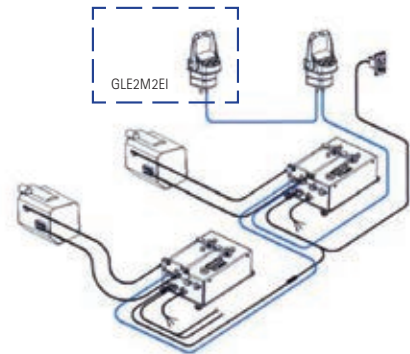

1 MOTOR INTRA/FUERABORDA O FUERABORDA 1 ESTACIÓN + TRIM	1 ENGINE I/O - OUTBOARD 1 STATION + TRIM	1 MOTORE ENTRO/FUORIBORDO O FUORIBORDO 1 STAZIONE + TRIM	1 MOTEUR IN-BORD OU HORS-BORD 1 STATION + GARNITURE	GLE1M1EC
Actuador SA2	Actuator SA2	Attuatore SA2	Actionneur SA2	1
Mando 1 palanca - 6 pulsadores	Single Control Head - 6-buttons	Telecomando 1 leva- 6 pulsanti	1 commande à levier - 6 boutons	1
Cable comunicación mando-actuador 12 m	Station comm. cable 40ft.	Cavo cablaggio comando-attuatore 12m	Câble de communication commande-actionneur 12 m	1
Resistencia terminal BUS	Terminating resistor	Resistenza terminale BUS	Résistance de borne BUS	2
Cable alimentación DC - actuador 9 m.	Harness DC power-actuator 30ft.	Cavo alimentazione DC- attuatore 9m	Câble d'alimentation CC - actionneur 9 m.	1
Cable Trim/Encendido/Start interlock	Harness Trim/Ignition/Start Interlock	Cavo trim/accensione/start e blocco	Câble de verrouillage Trim / On / Start	1

KIT 2ª ESTACIÓN 1 MOTOR INTRA/FUERABORDA O FUERABORDA 2 ESTACIONES + TRIM	KIT 2ND STATION 1 ENG. I/O - OUTBOARD 2 STATIONS + TRIM	KIT 2° STAZIONE 1 MOTORE ENTRO/FUORIBORDO O FUORIBORDO 2 STAZIONE + TRIM	KIT DE 2E STATION 1 MOTEUR IN-BORD OU HORS-BORD 2 STATIONS + GARNITURE	GLE1M2EC
Mando 1 palanca - 6 pulsadores	Single Control Head - 6-buttons	Telecomando 1 leva- 6 pulsanti	1 commande à levier - 6 boutons	1
Cable comunicación mando-actuador 12 m	Station comm. cable 40ft.	Cavo cablaggio comando-attuatore 12m	Câble de communication commande-actionneur 12 m	1

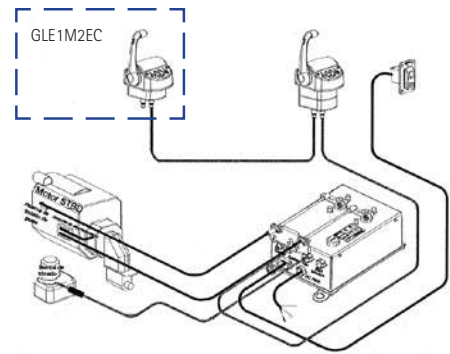

2 MOTORES INTRA/FUERABORDA O FUERABORDA 1 ESTACIÓN + TRIM	2 INBOARD ENIGNS 1 STATION	1 MOTORE ENTRO/FUORIBORDO O FUORIBORDO 1 STAZIONE + TRIM	2 MOTEURS IN-BORD OU HORS-BORD 1 STATION + GARNITURE	GLE2M1EC
Actuador SA2	Actuator SA2	Attuatore SA2	Actionneur SA2	2
Mando 2 palancas - 6 pulsadores	Twin Control Head - 6-buttons	Telecomando 2 leve- 6 pulsanti	Contrôle 2 leviers - 6 boutons	1
Cable comunicación mando-actuador 12 m	Station comm. cable 40ft.	Cavo cablaggio comando-attuatore 12m	Câble de communication commande-actionneur 12 m	1
Cable comunicación actuador-actuador 6 m	Station comm. cable 20ft.	Cavo cablaggio comando- attuatore 6m	Câble de communication actionneur-actionneur 6 m	1
Resistencia terminal BUS	Terminating resistor	Resistenza terminale BUS	Résistance de borne BUS	2
Cable alimentación DC - actuador 9 m.	Harness DC power-actuator 30ft.	Cavo alimentazione DC- actuatore 9m	Câble d'alimentation CC - actionneur 9 m.	2
Cable Encendido/Tacómetro babor.	Harness Ignition/Tach sender port	Cavo accensione/ tachimetro sinistra	Tachymètre pour câble d'alimentation / port.	1
Cable Tacómetro esribor.	Harness Tach sender starboard.	Cavo tachimetro destra	Câble tachymètre tachymétrique.	1
Cables Trim / Start Interlock.	Harness Trim / Start Interlock.	Cavo trim/ start e blocco	Trim / Start Interlock cables.	2

KIT 2ª ESTACION 2 MOTORES INTRA/FUERABORDA O FUERABORDA 2 ESTACIONES + TRIM	KIT 2ND STATION 2 ENGINE I/O - OUTBOARD 2 STATIONS + TRIM	KIT 2° STAZIONE 2 MOTORE ENTRO/FUORIBORDO O FUORIBORDO 2 STAZIONE + TRIM	KIT DE 2E STATION 2 MOTEURS IN-BORD OU HORS-BORDRES 2 STATIONS + GARNITURE	GLE2M2EC
Mando 2 palanca - 6 pulsadores	Twin Control Head - 6-buttons	Telecomando 2 leve- 6 pulsanti	2 commandes à levier - 6 boutons	1
Cable comunicación mando-actuador 12 m	Station comm. cable 40ft.	Cavo cablaggio comando-attuatore 12m	Câble de communication commande-actionneur 12 m	1

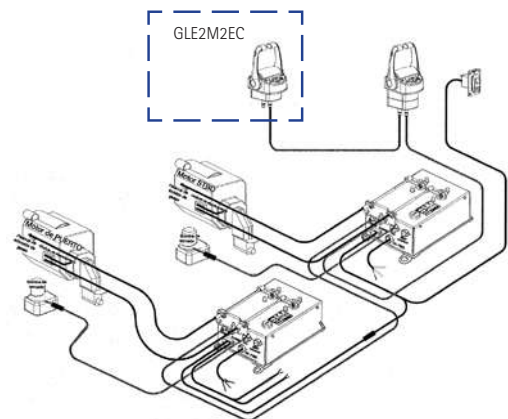

SISTEMA DE GOBIERNO Y ACCESORIOS DE INSTALACIÓN

STEERING SYSTEM & INSTALLATION ACCESSORIES

SISTEMA DI GUIDA E ACCESSORI DIREZIONE

SYSTÈME DE DIRECTION ET ACCESSOIRES D'INSTALLATION

MANGUERA DE PROTECCION

Manguera de protección para los cables de dirección, mando, etc. desde la salida del casco hasta el motor, presentando un sólo núcleo limpio y ordenado. Color gris.

PROTECTIVE CABLE SYSTEM



This system gives a good protection to the service cables of outboard engines against dirt and corrosion. Available in two diameters, complete with fittings in black colour. Hose in grey colour.

TUBO DI PROTEZIONE

Tubo di protezione per cavi di timoneria, comando etc. dall'uscita dello scafo fino al motore, per tenere i cavi ordinati. Colore grigio.

GAINE DE PROTECTION

Gaine de protection pour les câbles de direction, de commande, etc. de la sortie de coque au moteur, présentant un seul fourreau propre et bien rangé. Gris.

REF			Ø INT (mm)		
GS41164	Kit	80 cm	50	1	
GS41165		80 cm	32	1	
GS41160	Terminal casco Hull end fitting		50	1	
GS41166	Terminal scafo Terminal coque		32	1	
GS41161	Manguera Hose	15 m	50		15 m
GS41167	Tubo Gainé	15 m	32		15 m
GS41162	Terminal motor Engine end fitting		50	1	
GS41168	Terminal motore Terminal moteur		32	1	



ARO PROTECTOR

Protección de los cables de control y dirección. Vinilo marino resistente a los rayos U.V., gasolina y aceites. Se ajusta alrededor de los cables.

CABLE BOOTS

Finishes and protects pass thru hole for wires and cables. Rugged marine vinyl. Resists UV, gasoline and oil. Cable tie snugs around wires and cables.

CUFFIA PASSACAVO

Protezione di cavi di controllo e di comando. Vinile marino resistente a raggi UV, benzina e oli. Si adatta attorno ai cavi.

ANNEAU DE PROTECTION

Protection des câbles de commande et de direction. Vinyle marin résistant aux rayons UV, à l'essence et aux huiles. Il s'adapte autour des fils.

REF	PARA AGUJERO FOR HOLE PER FORI POUR TROU	
THCB-2	2"	1
THCB-1	3"	1
THCB-4	4 1/2"	1
THCB-2W	2"	1
THCB-1W	3"	1
THCB-4W	4 1/2"	1



Protección de los cables de control y dirección. Fabricado en plástico cromado.

Finishes and protects pass thru hole for wires and cables. Chrome plated plastic.

Protezione cavi di controllo e di comando. Fabbriato in plastica cromata.

Protection des câbles de commande et de direction. Fabriqué en plastique chromé.

REF	
THRF-1CP	1



PROTECTOR ESPEJO

Fabricada en aluminio. Con soporte para terminal del cable de dirección.

PROTECTION PLATE

Aluminum transom plate complete with support and tube for steering cable.

PIASTRA SALVA POPPA

Fabbriata in alluminio. Con supporto per i cavi di timoneria.

PLAQUE DE PROTECTION

Fabriqué en aluminium. Avec support pour de câble de direction.

REF		
GS73132	280 x 115 (mm)	1



Fabricada en plástico semirígido. Color blanco.

Made in plastic. White.

In plastica semirigida. Colore bianco.

Fabriqué en plastique Couleur blanche.

REF	(mm)	
GS73133	430 x 350	1

GOLDENSHIP



Fabricada en plástico semirígido.

Made in plastic.

In plastica semirigida.

Fabriqué en plastique.

REF	(mm)	
GS73130	225 x 85	1
GS73131	270 x 100	1

GOLDENSHIP



Fabricada en polipropileno resistente a los rayos UV. Color blanco.

Made in solid UV resistant polypropilene. Colour white.

Fabbricata in polipropileno resistente ai raggi UV. Colore bianco.

Fabriqué en polypropylène résistant aux UV. Couleur blanche.

REF	A (mm)	B (mm)	C (mm)	GRUESO THICKNESS SPESSORE EPAISSEUR (mm)	
OCE100133	390	350	330	8	1
OCE100134	390	350	330	15	1

OCEANSOUTH



CONTRAPLACA TRANSOM

TRANSOM SUPPORT PLATE

CONTROPIASTRA

CONTRE-PLAQUE

Reparte el esfuerzo de los tornillos de sujeción del motor. Fabricado en aluminio de alta calidad, de 10mm de espesor.

Distributes stress of engine bolts. Manufactured in high quality cast aluminum. All plates 3/8".

Contropiastra. Fabbricata in alluminio di alta qualità, di 10mm di spessore.

Répartissez l'effort des boulons de fixation du moteur. Fabriqué en aluminium de haute qualité, épaisseur 10 mm.

REF			
THTSP-1	Para tornillos superiores For top bolts Per viti superiori Pour vis supérieures	15" x 2"	13"
THTSP-2	Para tornillos inferiores For lower bolts Per viti inferiori Pour vis inférieures	12"	10"



TUERCA DE ENGRASE

STEERING GUARD

DADO LUBRIFICANTE

ÉCROU DE GRAISSAGE

Tuerca engrasadora para todos los cables de dirección. Sella el cable evitando el agua y la corrosión.

Steering guard to be installed in all cable and side mounted hydraulic steering systems to lubricate clean and seal the systems. Made of stainless steel.

Dado lubrificante per tutti i cavi di timoneria. Chiude il cavo evitando l'acqua e la corrosione.

Écrou de graissage pour tous les câbles de direction. Scellez le câble en évitant l'eau et la corrosion.

REF		
GS41170	7/8"	1

GOLDENSHIP



TELEFLEX «XTREME»



Cambios mínimos en el esquema de montaje o anidamiento de cables desde Osprey o SL-3.
Impulsiones de popa e interiores. La palanca de doble función controla el acelerador y el cambio de un motor. Enclavamiento neutro y protección de arranque en marcha (estándar) para controles de montaje lateral.
TRIM/TILT opcional en el mango.
Función de calentamiento del motor neutro (estándar).
Interruptor de apagado de emergencia del motor para controles de montaje lateral.
Acepta todos los tipos de cable OEM y 3300 / 33C.
Cumple / excede todos los estándares aplicables.

Minimal changes to mounting scheme or cable nesting from Osprey or SL-3.
Dual function lever controls both throttle and shift of one engine. Neutral interlock and start-in-gear protection (standard) for side mount controls.
Optional TRIM / TILT in the handle.
Neutral engine warm-up feature (standard).
Standard lanyard-style cut-off switch for emergency engine shut down for side mount controls.
Accepts every type of OEM and 3300/33C type cable.
Meets/exceeds all applicable standards.

Modifiche minime dello schema di assemblaggio o di nidificazione dei cavi da Osprey o SL-3.
Azionamenti di popa e interni. La leva a doppia funzione controlla l'acceleratore e il cambio di un motore.
Interblocco neutro e protezione marcia in marcia (standard) per comandi di montaggio laterali.
TRIM / TILT opzionale sul manico.
Funzione di riscaldamento del motore neutro (standard).
Interruttore di arresto di emergenza del motore per comandi di montaggio laterali.
Accetta tutti i tipi di cavi OEM e 3300 / 33C.
Soddisfa / supera tutti gli standard applicabili.

Modifications minimes dans le schéma d'assemblage des câbles d'Osprey ou SL-3.
Commandes latérales ou sur console. Le levier à double fonction contrôle l'accélérateur et l'inversion de marche. Verrouillage neutre et protection de démarrage (standard) pour les commandes à montage latéral.
TRIM / TILT en option sur la poignée.
Fonction de chauffage neutre du moteur (standard).
Interrupteur d'arrêt d'urgence du moteur pour commandes à montage latéral.
Accepte tous les types de câbles OEM et 3300 / 33C.
Répond / dépasse toutes les normes applicables.

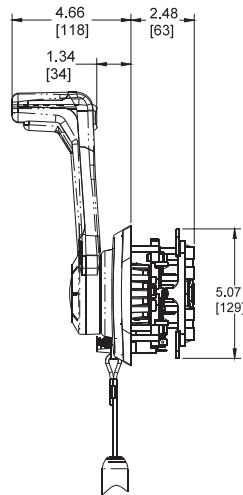

REF	LATERAL CENTRAL NEGRO	SIDE CENTER BLACK	LATERALE CENTRALE NERO	LATERAL NOIR
TXCHX8850P	Interlock Hombre al agua	Interlock Stoper, hang rope assy	Interlock Stacco aut. d'emergenza	Verrouillage Coupe circuit
TXCHX8852P	Interlock Hombre al agua Trim/Tilt	Interlock Stoper, hang rope assy Trim/Tilt switch	Interlock Stacco aut. d'emergenza Trim/Tilt switch	Verrouillage Coupe circuit Trim / Tilt

REF	LATERAL NEGRO	SIDE BLACK	LATERALE NERO	LATERAL NOIR
TXCHX8550P	Interlock Hombre al agua	Interlock Stoper, hang rope assy	Interlock Stacco aut. d'emergenza	Verrouillage Coupe circuit
TXCHX8552P	Interlock Hombre al agua Trim/Tilt	Interlock Trim/Tilt switch Stoper, hang rope assy	Interlock Trim/Tilt switch Stacco aut. d'emergenza	Verrouillage Coupe circuit Trim/Tilt
TXCHX8553P	Interlock	Interlock	Interlock	Verrouillage
TXCHX8555P	Interlock Trim/Tilt	Interlock Trim/Tilt switch	Interlock Trim/Tilt switch	Verrouillage Trim/Tilt

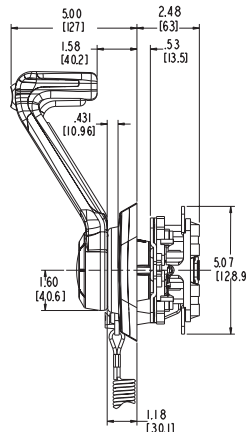
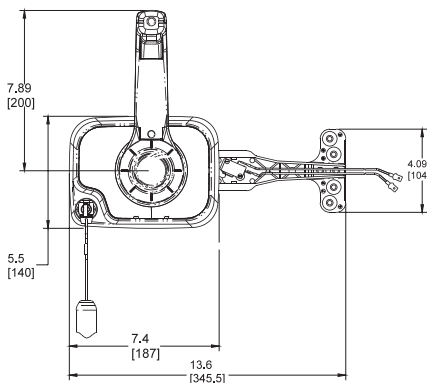

REF	CONSOLA NEGRO	CONSOLE BLACK	CONSOLE NERO	CONSOLE NOIR
TXCHX8640P	Estándar	Standard	Standard	Standard
TXCHX8642P	Trim/Tilt	Trim/Tilt switch	Trim/Tilt switch	Trim/Tilt

REF	CONSOLA CROMADO	CONSOLE CHROME	CONSOLE CROMATO	CONSOLE CHROME
TXCHX8650P	Interlock	Interlock	Interlock	Verrouillage
TXCHX8652P	Interlock Trim/Tilt	Interlock Trim/Tilt switch	Interlock Trim/Tilt switch	Trim/Tilt

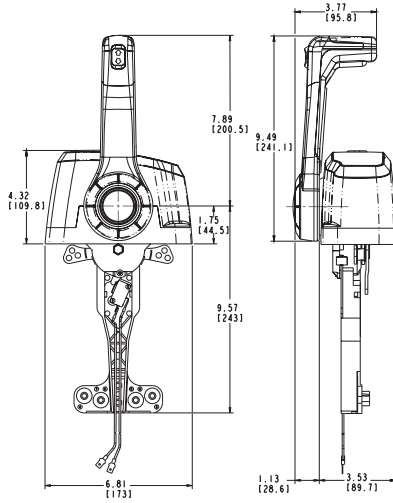

REF	CONSOLA DOBLE NEGRO	DOUBLE CONSOLE BLACK	DOPPIA CONSOLE NERO	DOUBLE CONSOLE NOIR
TXCHX8740P	Estándar	Standard	Standard	Standard
TXCHX8742P	Trim/Tilt	Trim/Tilt switch	Trim/Tilt switch	Trim/Tilt

REF	CONSOLA DOBLE CROMADO	DOUBLE CONSOLE CHROME	DOPPIA CONSOLE CROMATO	DOUBLE CONSOLE CHROME
TXCHX8240P	Estándar	Standard	Standard	Standard
TXCHX8242P	Trim/Tilt	Trim/Tilt switch	Trim/Tilt switch	Trim/Tilt

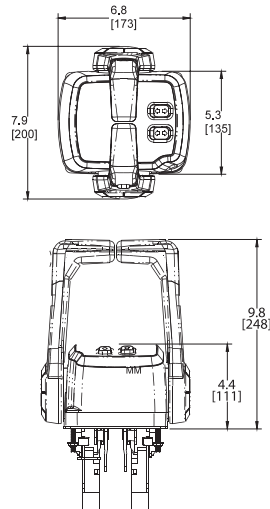
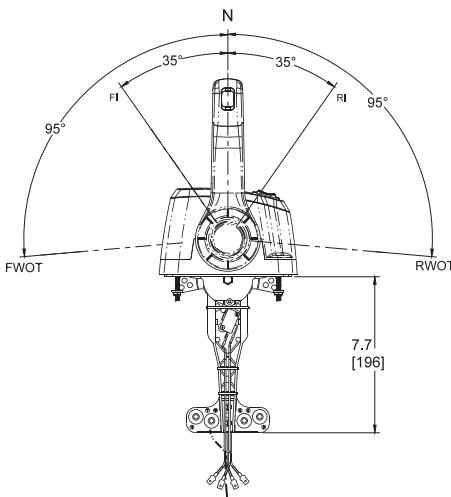

MANDO LATERAL

SIDE CONTROL

MANETTA LATERALE COMMANDE LATÉRALE

Doble función (acelerador y cambio).
Montaje lateral empotrado.
Apropiado para embarcaciones a vela.
Botón aceleración en punto muerto. Protección de arranque en punto muerto.
Utiliza 2 cables 33-C y 3300C.

Single Lever Dual action side mount control designed for sail boats. Single lever throttle/gear control. Neutral safety switch option (prevents starting in gear).
Uses 33-C and 3300C cables.

Doppia funzione (acceleratore e cambio).
Montaggio laterale ad incasso. Ideale per imbarcazioni a vela.
Pulsante acceleratore nel folle. Protezione di accensione nel folle.
Utilizza 2 cavi 33C e 3300C.

Double fonction (accélérateur et inverseur).
Montage latéral encastré. Convient aux voiliers.
Bouton d'accélération au point mort. Protection démarrage au point mort.
Il utilise 2 câbles 33-C et 3300C.



REF
TX172103

TELEFLEX



Fabricado en plástico Hostafon y palancas de aluminio anodizado, independientes para acelerador y cambio.
Con kit de adaptadores para cables 33C y 3300s, OMC, Mercury, Mariner y Suzuki.

Manufactured in Hostafon with levers in light alloy aluminum. Can be installed in both sides. With adaptors for 33C & 3300S, OMC, Mercury, Mariner and Suzuki.

Fabbricato in plastica. Manetta in alluminio anodizzato, indipendenti per acceleratore e cambio.
Con kit di adattatori per cavi 33C e 3300S, OMC, Mercury, Mariner e Suzuki

Fabriqu  en plastique et leviers en aluminium anodis , ind pendants pour l'acc l rateur et l'inverseur.
Avec kit adaptateur pour câbles 33C et 3300s, OMC, Mercury, Mariner et Suzuki.

REF
GS40001 114 x 228 mm

GOLDENSHIP



Palanca con doble función (acelerador y cambio).
Para motores intraborda e intra-fueraborda.
Montaje lateral superpuesto.
Utiliza cables 33-C y 3300S

Dual function, single lever control.
For virtually all stern drive, outboard and inboard engines.
Push button for neutral engine warm-up.
For 33-C & 3300S cables

Leva con doppia funzione (acceleratore e cambio).
Per motori entroborde e entro-fuoriborde.
Montaggio laterale.
Utilizza cavi 33-C e 3300S.

Levier   double fonction (acc l rateur et inverseur).
Pour moteurs in-bord et hors-bord.
Montage lat ral.
Utilise des câbles 33-C et 3300S

REF
GS40015 YMD-RCBOX-00-10 (6C-50H)

GOLDENSHIP

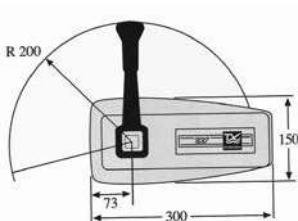

MANDO CONSOLA

CONSOLE CONTROL

MANETTA CONSOLE

BOITIER DE CONSOLE

Palanca de función única. (1 acelerador + 1 inversor).
Para trabajos pesados.
Con freno en la palanca de acelerador.
Carcasa y palancas cromada de función.
Con interruptor de protección de arranque en punto muerto.
Utiliza cables 33-C y 3300C

Chrome plated heavy duty single function control for clutch and throttle.
With twisting brake on throttle handle.
Uses 33-C and 3300C cables.

Leva con unica funzione (1 acceleratore + 1 invertitore).
Corpo e leve in acciaio cromato.
Con interruttore di protezione di partenza nel folle.
Utilizza cavi 33C e 3300C.

Levier   fonction unique. (1 acc l rateur + 1 inverseur).
Pour les travaux lourds.
Avec frein sur le levier d'acc l rateur.
Leviers en fonte et fonte chrom e.
Interrupteur de d marrage au point mort.
Utilise des câbles 33-C et 3300C

REF
PRE36468

PRETECH
Cable and Controls

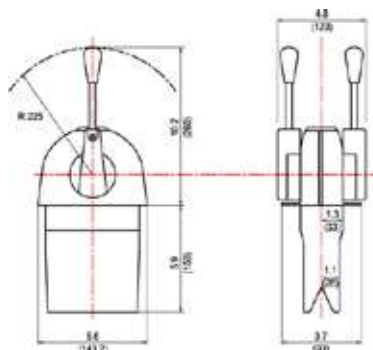

4300C

Para trabajos pesados.
Recorrido trabajo: 76 mm.
Rosca 1/4-28"

Heavy Duty.
Travel 3"
Threaded 1/4-28"

Per lavori pesanti
Estensione 7,6cm
Filetto 1/4-28"

Pour les travaux lourds.
Course: 76 mm.
Filetage 1/4-28"

REF		REF	
PRE6500C05	5' / 1,50 m	PRE6500C25	25' / 7,60 m
PRE6500C06	6' / 1,80 m	PRE6500C27	27' / 8,25 m
PRE6500C07	7' / 2,10 m	PRE6500C29	29' / 8,85 m
PRE6500C08	8' / 2,45 m	PRE6500C31	31' / 9,50 m
PRE6500C09	9' / 2,75 m	PRE6500C33	33' / 10,00 m
PRE6500C10	10' / 3,05 m	PRE6500C35	35' / 10,65 m
PRE6500C12	12' / 3,65 m	PRE6500C37	37' / 11,28 m
PRE6500C14	14' / 4,25 m	PRE6500C39	39' / 11,89 m
PRE6500C16	16' / 4,90 m	PRE6500C41	41' / 12,56 m
PRE6500C18	18' / 5,50 m	PRE6500C43	43' / 13,11 m
PRE6500C19	19' / 5,80 m	PRE6500C45	45' / 13,71 m
PRE6500C21	21' / 6,40 m	PRE6500C47	47' / 14,33 m
PRE6500C23	23' / 7,00 m		



maxflex

PINNACLE

CABLES DE STOP

UTILITY CABLE

CAVO DI STOP

TIRETTES D'ARRÊT

REF		REF	
PRE31507	7' / 2,10 m	PRE31512	12' / 3,65 m
PRE31508	8' / 2,45 m	PRE31513	13' / 3,95 m
PRE31509	9' / 2,75 m	PRE31514	14' / 4,25 m
PRE31510	10' / 3,05 m	PRE31515	15' / 4,60 m
PRE31511	11' / 3,35 m	PRE31516	16' / 4,90 m



maxflex



ACCESORIOS PARA CABLES DE MANDO

ACCESSORIES FOR CONTROL CABLES

ACCESSORI CAVI COMANDI

ACCESSOIRES POUR CÂBLES DE COMMANDE

REF					
PRE331125	Horquilla	Fork	Forcella	Chappe	1
PRE31799	Rótula	Ball joint	Snodo	Rotule	1
PRE308650	Pivote	Pivot	Perno	Pivot	1
PRE332010	Abrazadera	Clamp	Ferma cavo	Collier	1
PRE331538	Platina	Shim	Piastrina	Platine	1
PRE331980	Terminal ojo	Terminale eye	Terminale cavo	Terminal	1
PRE336174	Fijador 1 cable	Stop collar 1	Fissatore 1 cavo	Fixateur de câble	1
PRE215154	Fijador 2 cable	Stop collar 2	Fissatore 2 cavi	Fixateur 2 câbles	1
PRE31916	Tirador SD para cable de paro y otros usos	SD control. Handle for throttle, choke, stop, etc.	Tirante SD Tirante per cavi e altri usi	Poignée SD pour câble d'arrêt et autres utilisations	1
PRE31917	SopORTE angular para tirador SD	Mounting bracket for SD control	Supporto per tirante SD	Support angulaire pour SD shooter	1



SISTEMA DE COMBUSTIBLE

FUEL SYSTEM

SISTEMA DI COMBUSTIBILE



SYSTÈME DE CARBURANT



CONECTOR TANQUE DE COMBUSTIBLE

TANK CONNECTOR

ATTACCO PER SERBATOIO

CONNECTEUR POUR RÉSERVOIR DE CARBURANT

REF	R.O. OEM		
GS31025	MERCURY/MARINER		
GS31073	YAMAHA	1/4" NPT	1
GS31083	772681 JOHNSON/EVINRUDE		1
GS31081	MERCURY/MARINER		1

REF	R.O. OEM		
GS31022	MERCURY/MARINER STANDAR		
GS31023	MERCURY/MARINER NEW		1
GS31020	YAMAHA	1/4" NPT	1
GS31021	JOHNSON/EVINRUDE	1/4" NPT	1





CONECTOR DOBLE

DOUBLE CONNECTOR

CONNETTORE DOPPIO

DOUBLE CONNECTEUR

REF			
GS31091	OMC	8 mm	1
GS31092	YAMAHA	8 mm	1
GS31093	MERCURY/MARINER	8 mm	1



CODO DEPÓSITO DE LATÓN

TANK ELBOW IN BRASS

GOMITO SERBATOIO

COUDE EN LAITON

REF			
GS31068	1/4" NPT	1	



CONECTOR T

T CONNECTOR

CONNETTORE "T"

CONNECTEUR T

Para conectar dos motores a un sólo depósito, o viceversa.

Fabricado en latón. Made in machined brass.

Per collegare due motori a un singolo serbatoio o viceversa.

Pour connecter deux moteurs à un seul réservoir, ou vice versa.

REF			
GS31069	1/4" NPT	1	



PASAMAMPAROS

THRU HULL

PASSA SCAFO

PASSE CLOISONS

Para atravesar mamparos de hasta 12 mm. Fabricado en latón.

For bulkhead up to 12 mm. Made in machined brass.

Per attraversare paratie fino a 12 mm. Fabbricato in ottone.

Pour traverser des cloisons jusqu'à 12 mm. En laiton.

REF			
GS31064	3/8"	1	



VÁLVULA ANTIRETORNO

NON-RETURN VALVE

VALVOLA ANTI-RITORNO



CLAPET ANTI-RETOUR

Válvula antiretorno para líneas de combustible y ventilación.

In-Line non-return valve for fuel pipes.

Valvola anti-ritorno per linee di combustibile e ventilazione.

Clapet anti-retour pour les conduites de carburant et de ventilation.

REF			
GS31003	8 mm	10 mm	1
GS31004	10 mm	10 mm	1
GS31005	12 mm	10 mm	1



VÁLVULA DE COMBUSTIBLE

FUEL VALVE

VALVOLA CARBURANTE



VANNE POUR CARBURANT

Válvula manual a 3 vías, para combustible. Fabricada en latón pulido. Montaje mediante soporte con 2 agujeros. Para conectar 2 depósitos a un solo motor.



Three ways fuel valve. Made in brass, with 2 holes flange. To connect 2 tanks to one single feeding pipe.

Valvola manuale a 3 uscite, per carburante. Fabricata in ottone. Fissare mediante supporto con 2 fori. Per collegare 2 serbatoi a un solo motore.

Vanne manuelle 3 voies, pour carburant. Fabriqué en laiton poli. Montage par support à 2 trous pour connecter 2 réservoirs à un seul moteur.

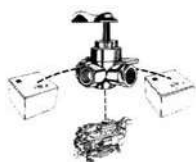
REF			
GS31010	1/4"	10 mm	1
GS31011	3/8"	10-13 mm	1



REF			
GS30111	1/4"	10 mm	1
GS30112	3/8"	12 mm	1



Válvula manual a 2 vías, para combustible. Fabricada en latón pulido.

Two ways fuel valve. Made in brass.

Valvola manuale a 2 uscite, per carburante. Fabricata in ottone.

Vanne manuelle 2 voies, pour carburant. Fabriqué en laiton poli.

REF			
GS31006	1/4" NPT	1/4" NPT	1



Válvula manual para combustible. Fabricada en latón cromado con racors. Puede montarse en línea o desmontando el soporte, incorporarla directamente al depósito.

Manual and remote fuel valve. Made in chrome plated brass. Can be mounted in line with hose or directly on gasoline tanks.

Valvola manuale per carburante. Fabricata in ottone cromato con raccordo. Si puo' montare in linea o smontando il supporto, incorporarla direttamente al serbatoio.

Vanne manuelle pour le carburant. Fabriqué en laiton chromé avec raccords. Elle peut être montée en ligne ou en l'intégrant directement dans le réservoir sans son support.

REF			
GS31012	1/4"	10 mm	1

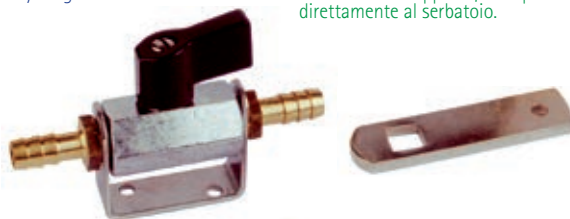

ELECTROVÁLVULA DE COMBUSTIBLE

FUEL ELECTRO-VALVE

ELETTROVALVOLA CARBURANTE





ÉLECTROVANNE POUR CARBURANT

Incluye conexiones para mangueras flexibles y para tubo de cobre. Accionamiento a 12V y manual. CE 94/25 (EN28846) y R.I.Na.DIP 61697

Fuel cut off electrovalve 12V with manual cock. Includes racors for flexible hose and cooper tube. CE 94/25 (EN28846) & R.I.Na.DIP 61697

Include raccordi per tubo flessibile e per tubi di rame. Avviamento a 12V e manuale. CE 94/25 (EN28846) e R.I.Na.DIP 61697

Comprend des connexions pour tuyaux flexibles et tube en cuivre. Entraînement 12V et manuel. CE 94/25 (EN28846) et R.I.Na.DIP 61697

REF					
GS31013	12V	100l/h	1/4"	8-10 mm	1



FILTROS DE COMBUSTIBLE

FUEL FILTERS

FILTRO BENZINA



FILTRES À CARBURANT

FILTRO PARA MONTAJE EN LINEA

IN-LINE FILTER

FILTRO PER MONTARE IN LINEA

FILTRE POUR MONTAGE EN LIGNE

REF		
GS31185	6-8 mm	1
GS31186	6-8 mm	1





GS31185





GS31186

Cubeta extraíble
Removable bowl
Vasca estraibile
Seau amovible

REF		
REC35-80365M	6 mm	2-8 HP (2 T/ Strokes) 8-15 HP (4 T/ Strokes)



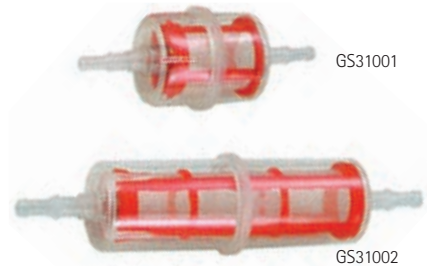

REF			
GS31001	50 l/h	6-8 mm	1
GS31002	150 l/h	8-10 mm	1





GS31001

GS31002

REF	R.O. OEM		
PAF4-05000300	35-16248	6 mm	4-9.8 HP (2 T/ Strokes) 4-25 HP (4 T/ Strokes)



REF			
REC40145	1/4"		
REC40155	5/16"		
REC40165	3/8"		
REC40135	5/16"	3/8"	



De metal y cristal. Montaje en línea.
Racors para mangueras de 6-8-10 mm.

In-line. Clear body permits visual inspection.
Racors 6-8-10 mm.

Di metallo e cristallo. Montare in linea.
Raccordi per tubi da 6-8-10 mm.

En métal et verre. Montage en ligne.
Raccors pour tuyaux 6-8-10 mm.

REF		
GS30435	6, 8, 10 mm	1



FILTRO COMBUSTIBLE SEPARADOR DE AGUA

WATER SEPARATING FUEL FILTER

FILTRO SEPARATORE ACQUA-BENZINA

FILTRE À CARBURANT SEPARATEUR D'EAU

REF	MICRAS MICRON	
REC24942	10	4-7/16"
REC35-802893Q01	10	4-7/16"
REC855686	28	4-7/16"
REC35-802893Q	25	3-3/4"
RACPF5510	10	4-7/16"



RACPF5510



REC24942

REC35-802893Q01

REC855686

REC35-802893Q

Filtro original.

OEM filter.

Filtro benzina originale.

Filtre d'origine

REF	MICRAS MICRON	
RM35-802893Q	10	3-3/4"



FILTRO CON BRACKET
Bracket de Aluminio.
Con 2 tapones de bronce y 1 tubo de extensión.

OEM FILTER WITH BRACKET
Cast Aluminium Bracket.
With 2 brass plugs & 1 extension tube.

FILTRO BENZINA CON SUPPORTO
Supporto in alluminio.
Con 2 tappi di bronzo e 1 tubo di estensione.

FILTRE AVEC SUPPORT
Support en aluminium
Avec 2 bouchons en bronze et 1 tube d'extension.

REF	MICRAS MICRON		
REC24950	25	1/4"	50 GPH
REC24952	10	1/4"	50 GPH



FILTRO DECANTADOR GASOLINA

Filtro de combustible con braket.

COMPLETE FUEL FILTER

Complete fuel filter with braket.

FILTRO DECANTATORE BENZINA

Filtro combustibile con supporto.

FILTRE DÉCANTEUR POUR ESSENCE

Filtre à carburant avec support.

REF		
RAC23299-10	RAC23289-10	130 HP (4 T/ Strokes)

RACOR



REF	OEM		MICRAS MICRON		
REC90794-46866	907-94469-05	REC90794-46868	10	117 l/h	175 hp

RECMAR



Ø 8mm



**LLAVE PARA FILTRO
FILTER KEY
CHIAVE DA FILTRO
CLÉ À FILTRE**

REF
RECYS-225-15



Consultar filtros específicos para una marca en su catálogo.
Consult specific filters for a brand in his catalog.
Consulta i filtri specifici per un marchio nel suo catalogo.
Consulter les filtres spécifique à une marque dans votre catalogue.

REF	
PAF40-0701000EI	70 hp



Ø 6mm



FILTRO DECANTADOR GASOLINA

COMPLETE FUEL FILTER

FILTRO DECANTATORE BENZINA

FILTRE DÉCANTEUR POUR ESSENCE

RACOR



	RAC120R-RAC-01	RAC320R-RAC-01	RAC320R-INOX-01	RAC320R-RAC-02
	114 l/h 30 gph	340 l/h 60 gph	340 l/h 60 gph	340 l/h 60 gph
	RACS3240	RACS3213	RACS3213	RACS3220UL
CAZOLETA TRANSPARENTE (sólo se recomienda para fueraborda.) CLEAR BOWL (Just for outboards) VASCHETTA TRASPARENTE (Solo nei fuoribordo.) CAZOLETA TRANSPARENTE (Uniquement recommandé pour le hors-bord.)	✓	✓	✓	✗
ROSCAS CENTRALES CENTRAL THREADS FILETTO CENTRALE FILS CENTRAUX	M18 x 1.5	1 1/4"	1 1/4"	1 1/4"
TAMAÑO ROSCA CABEZA HEAD PORT SIZE DIMENSIONE VITE TESTA TAILLE DU FIL DE TÊTE	1/4-18 NPTF	1/4-18 NPTF	1/4-18 NPTF	1/4-18 NPTF
X Ø (mm)	166 x 81 mm	238 x 102 mm	238 x 102 mm	238 x 102 mm
	0,5 kg	0,9 kg	0,9 kg	0,9 kg
CAIDA DE PRESIÓN PRESSURE DROP CADUTA DI PRESSIONE CHUTE DE PRESSION	0.15 PSI 0.01 bar	0.61 PSI 0.04 bar	0.61 PSI 0.04 bar	0.61 PSI 0.04 bar
MAX	7 PSI 0.05 bar	7 PSI 0.05 bar	7 PSI 0.05 bar	7 PSI 0.05 bar
DESMONTAJE CARTUCHO-CAZOLETA ELEMENT REMOVAL UNDERBOWL RIMOZIONE DELLA CARTUCCIA DÉMONTAGE DE LA CARTOUCHE	25,4 mm 1"	25,4 mm 1"	25,4 mm 1"	25,4 mm 1"
	-40°C +124°C			

ELEMENTOS DE RECAMBIO

ELEMENT

ELEMENTI DI RICAMBIO

CARTOUCHE DE RECHANGE

REF	R.OM. OEM	FILTRO FILTER FILTRO FILTRE
RACS3240		RAC120R-RAC-01
LENS3240		
RACS3227	YMM-2E227-00	Yamaha-Suzuki
LENS3227		
RACS3213		RAC320R-RAC-01 RAC320R-RAC-01 INOX RAC320R-RAC-03
LENS3213		
RACS3214		Johnson Et Evinrude
RACS3228UL		RAC320R-RAC-02, con/with/con/avec bracket RACOR



LENS3240
LENS3227
LENS3214



RACS3240
RACS3227
RACS3214



RACS3228UL

RÁCORES

RACORS

RACCORDI

RACCORDS

Para | for | per | pour: RAC120R-RAC-01, RAC320R-RAC-01, RAC320R-RAC-02

REF		90°	0°	
GS31065	1/4" NPT	3/8"		1
GS31066	1/4" NPT		5/16"	2
GS31067	1/4" NPT		3/8"	2

GOLDENSHIP



GS31065



GS31066
GS31067

SISTEMA ELÉCTRICO ELECTRIC SYSTEM

SISTEMA ELETTRICO SYSTEME ELECTRIQUE

FUSIBLE ATC

MARINE FUSES ATC

Ref	⚡	(mm)	📄
GS11501	3 A	19 x 19	5
GS11502	4 A	19 x 19	5
GS11503	10 A	19 x 19	5
GS11504	15 A	19 x 19	5
GS11505	20 A	19 x 19	5
GS11506	30 A	19 x 19	5



FUSIBILE ATC

FUSIBLE ATC

Con LED indicador de fundido. With illuminated LED when blown. Con indicatore LED. Avec indicateur LED.

Ref	⚡	(mm)	📄
BS5291	3 A	19 x 19	2
BS5292	5 A	19 x 19	2
BS5293	7,5 A	19 x 19	2
BS5294	10 A	19 x 19	2
BS5295	15 A	19 x 19	2
BS5296	20 A	19 x 19	2
BS5297	25 A	19 x 19	2
BS5298	30 A	19 x 19	2
BS5299	40 A	19 x 19	2



FUSIBLE ATM

MARINE FUSES ATM

Ref	⚡	(mm)	📄
AM603905	5 A	11 x 16	2
AM603910	10 A	11 x 16	2
AM603915	15 A	11 x 16	2
AM603920	20 A	11 x 16	2
AM603930	30 A	11 x 16	2



FUSIBILE ATM

FUSIBLE ATM

FUSIBLE MAXI

FUSES MAXI

Contactos estañados para resistir a la corrosión.

Tin plated connector blades for corrosion resistance.

Connettori stagni per resistere alla corrosione.

Contacts étamés pour résister à la corrosion.

Ref	⚡	📄
BS5138	30 A	1
BS5139	40 A	1
BS5140	50 A	1
BS5141	60 A	1
BS5142	70 A	1
BS5143	80 A	1

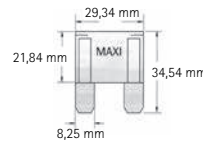

DESCONECTOR DE SEGURIDAD

IGNITION KILL SWITCHES

INTERRUTTORE DI STOP

INTERRUPTEUR DE SECURITE

Interruptor de encendido para motores. Aísla los circuitos en unidades dobles para prevenir el retorno al alternador.

Emergency and stop switch. Isolates circuits on dual units to prevent feedback.

Interruttore di accensione per motori. Isola i circuiti in doppie unità per prevenire il ritorno all'alternatore.

Contacteur d'allumage pour moteurs. Isolez les circuits en unités doubles pour empêcher le retour à l'alternateur.

REF					📄
THKS-1	Un fueraborda	Single outboard	Un fuoribordo	Un hors-bord	1
THKS-2	Un intraborda	Single I/O	Un entrobordeo	Un inboard	1
THKS-12	Dos fuerabordas	Dual outboard	Due fuoribordo	Deux hors-bord	1
THKS-22	Dos intrabordas	Dual I/O	Due entrobordeo	Deux inboard	1
THL-4	Cuerda recambio	Spare lanyard	Corde ricambio	Corde de rechange	1



REF	RO OEM		📄
REC87-823609A17	87-823609A17	Mercury / Mariner	1
REC37800-93954	37800-9354 37800-9353	Suzuki	1



REC87-823609A17



REC37800-9354

Interruptor de encendido para todo tipo de motores fueraborda o inaborda.

Emergency and stop switch for inboard or outboards.

Interruttore di accensione per tutti i tipi di motori entroabordo e fuoribordo.

Contacteur d'allumage pour tous types de moteurs hors-bord ou in-bord.

REF					
REC40970	Conjunto completo	Complete kit	Kit completo	Ensemble complet	1
REC40990	Cuerda tirador recambio	Spare	Corda tirante ricambio	Corde de rechange	1
GS11290	Conjunto completo	Complete kit	Kit completo	Ensemble complet	1
GS11291	Cuerda recambio	Spare lanyard	Corda ricambio	Corde de rechange	1
GS11292	Kit	Kit	Kit	kit	1



RECmar
REC40970- REC40990



GOLDENSHIP
GS11290



GOLDENSHIP
GS11292



GOLDENSHIP
GS11291

REF	RO OEM		
REC37830-89E03	37830-84E03	Suzuki	1
REC37820-92E03	37820-92E00	Suzuki	1
REC69W-82575-00	69W-82575-0	Yamaha / Mariner	1
REC688-82575-01	688-82575-01	Yamaha / Mariner	1
REC200		Mercury / Mariner	1
REC369-0682-0	369-0682-00	Tohatsu	1

RECmar



REC69W-82575-00



REC688-82575-01

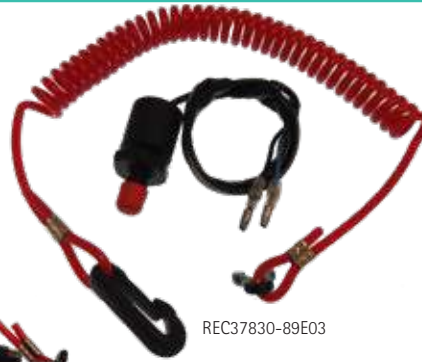

REC37830-89E03



REC369-0682-0



REC200



REC37820-92E03

KITS LLAVES

KILL SWITCHES KEYS

KIT CHIAVI

KITS DE CLÉS

REF		
GS11294	Johnson / Evinrude OMC Mercury Yamaha Honda Suzuki Tohatsu	1

GOLDENSHIP



LLAVE DE ARRANQUE

IGNITION STARTER SWITCHES

CHIAVE DI AVVIAMENTO

CONTACTEUR À CLÉ

3 posiciones con retroceso, Off-Contacto-Arranque (Choke).
Poliester anticorrosión.

3 positions, Off-Run-Start. Magneto.

3 posizioni con ritorno: Off-Contatto-Avviamento. Poliester anticorrosione.

3 positions, Off-Contact-Start (Choke). Polyester anti-corrosion.

REF	PANELES PANELS PANNELLI PANNEAUX	TERMINALES TERMINALS TERMINALI BORNES	POSICIONES POSITIONS POSIZIONE POSITIONS	
GS11152	28 mm	3	3	1



3 posiciones con retroceso, Off-Contacto-Arranque. Poliester anticorrosión.

3 positions, Off-Run-Start. Conventional

3 posizioni con ritorno: Off-Contatto-Avviamento. Poliester anticorrosione.

3 positions, Off-Contact-Start. Polyester anti-corrosion.

REF	RO OEM	TERMINALES TERMINALS TERMINALI BORNES	POSICIONES POSITIONS POSIZIONE POSITIONS	
MP39760	393301 508180	5 + 1	3	1



3 posiciones con retroceso, Off-Contacto-Arranque (Choke).
Poliester anticorrosión.
Para fuerabordas Mercury y Mariner.

3 positions, Off-Run-Start. Magneto

3 posizioni con ritorno: Off-Contatto-Avviamento. Poliester anticorrosione.
Per fuoribordo Mercury e Mariner.

3 positions, Off-Contact-Start (Choke). Polyester anti-corrosion.
Pour les moteurs hors-bord Mercury et Mariner.

REF	RO OEM	TERMINALES TERMINALS TERMINALI BORNES	POSICIONES POSITIONS POSIZIONE POSITIONS	
MP41070	MC 87-17009A2, 87-17009A5	6	3	1



3 posiciones con retroceso, Off-Contacto-Arranque (Choke).
Poliester anticorrosión.
Para fuerabordas Mercury y Mariner.

3 positions, Off-Run-Start. Magneto.

3 posizioni con ritorno: Off-Contatto-Avviamento. Poliester anticorrosione.
Per fuoribordo Mercury e Mariner.

3 positions, Off-Contact-Start (Choke). Polyester anti-corrosion.
Pour les moteurs hors-bord Mercury et Mariner.

REF	RO OEM	TERMINALES TERMINALS TERMINALI BORNES	POSICIONES POSITIONS POSIZIONE POSITIONS	
GS11158	MC 87-88107	6	3	1



3 posiciones con retroceso, Off-Contacto-Arranque. Poliester anticorrosión.
Montadas por Bayliner y SeaRay (1990+).

3 positions, Off-Run-Start. Conventional.

Chiave di avviamento a 3 posizioni con ritorno: Off-Contatto-Avviamento. Poliester anticorrosione.
Montato da Bayliner e SeaRay dall'anno 1990.

3 positions, Off-Contact-Start. Polyester anti-corrosion.
Assemblé par Bayliner et SeaRay (1990+).

REF	PANELES PANELS PANNELLI PANNEAUX	TERMINALES TERMINALS TERMINALI BORNES	POSICIONES POSITIONS POSIZIONE POSITIONS	
MP41030	15 mm	3	3	1



3 posiciones con retroceso, Off-Contacto-Arranque. Fabricada en latón con frontal cromado.
Chrome plated brass face nut and brass back-up nut.

3 positions with return, Off-Ignition-Start.

3 posizioni con ritorno Off-Contatto-Avviamento. In ottone con frontale cromato.

3 positions, Off-Contact-Start. Fabriqué en laiton avec façade chromée.
Ecrou frontal en laiton chromé et écrou d'appui en laiton.

REF	PANELES PANELS PANNELLI PANNEAUX	TERMINALES TERMINALS TERMINALI BORNES	POSICIONES POSITIONS POSIZIONE POSITIONS	
GS11150	28 mm	3, 15A 12V	3	1

 GOLDENSHIP



Fabricada en latón con frontal protector de goma. 3 posiciones con retroceso, Off-Contacto-Arranque.

Made in brass with rubber cap protector. 3 positions with return, Off-Ignition-Start.

Prodotta in ottone con parte frontale in gomma, 3 posizioni con ritorno, Off-Contatto-Avviamento.

En laiton avec façade de protection en caoutchouc. 3 positions: Off-Contact-Start.

REF	TERMINALES TERMINALS TERMINALI BORNES	POSICIONES POSITIONS POSIZIONE POSITIONS	
GS11151	3	3	1
GS11154	4	3	1

 GOLDENSHIP



Plástico con frontal protector de goma.
3 posiciones con retroceso,
Off-Contacto-Arranque.

Made in plastic with rubber cap protector.
3 positions with return,
Off-Ignition-Start.

In plastica con parte frontale in gomma
3 posizioni con ritorno,
Off-Contatto-Avviamento.

Plastique avec façade de protection en caoutchouc.
3 positions :
Off, contact et démarrage.

REF	TERMINALES TERMINALS TERMINALI BORNES	POSICIONES POSITIONS POSIZIONE POSITIONS	
GS11152	3	3	1
GS11153	5	3	1



GOLDENSHIP

Plástico.
4 posiciones con retroceso, Accesorios-
Off-Contacto-Arranque.

Made in plastic with rubber cap
protector.
4 positions with return,
Acc-Off-Ignition-Start.

Prodotta in plastica.
4 posizioni con ritorno, Blower-Off-
Contatto-Avviamento.

Plastique
4 positions avec recul, Accessoires-Off-
Contact-Start.

REF	PANELES PANELS PANNELLI PANNEAUX	TERMINALES TERMINALS TERMINALI BORNES	POSICIONES POSITIONS POSIZIONE POSITIONS	
GS11155	15 mm = 5/8"	7	4	1
GS11156	6 mm = 1/4"	7	4	1

GOLDENSHIP



Fabricada en plástico.
3 posiciones con retroceso, Off-
Contacto-Arranque (Starter).

Made in plastic. 3 positions with return,
Off-Ignition-Start (Choke).

Prodotta in plastica. 3 posizioni con
ritorno, Off-Contatto-Avviamento
(Starter).

En plastique.
3 positions avec recul, démarreur sans
contact.

REF	PANELES PANELS PANNELLI PANNEAUX	TERMINALES TERMINALS TERMINALI BORNES	POSICIONES POSITIONS POSIZIONE POSITIONS	
GS11158	15 mm = 5/8"	6	3	1
GS11157	6 mm = 1/4"	6	3	1

GOLDENSHIP



Fabricada en plástico.
Con cables incluidos.
3 posiciones con retroceso, Off-
Contacto-Arranque (Starter).
Made in plastic.

3 positions with return,
Off-Ignition-Start (Choke).
With wires included.

Prodotta in plastica.
Con cavi inclusi.
3 posizioni con ritorno, Off-Contatto-
Avviamento (Starter).

En plastique.
Avec câbles inclus.
3 positions avec recul, démarreur sans
contact.

REF	TERMINALES TERMINALS TERMINALI BORNES	POSICIONES POSITIONS POSIZIONE POSITIONS	
GS11159	6	3	1

GOLDENSHIP



LUBRICANTES Y PINTURAS

LUBRICANTS & PAINTS

LUBRIFICANTI E PITTURE

LUBRIFIANTS ET PEINTURES

PROTECTOR DE MOTOR

ENGINE PROTECTOR

PROTETTORE MOTORE

PROTECTION DU MOTEUR

Producto a base de aceites y grasas que protege del óxido y la corrosión las superficies exteriores y partes eléctricas de los motores durante el invierno. Evita la formación de agarramientos debido a la presencia de salitre. Facilita el arranque eliminando los residuos de agua y humedad. Se elimina fácilmente.

Oil & grease made, protects from rust & corrosion external engine surface during winter storage. Removes salt deposit and loosens rusted parts. Easy to remove.

Prodotto a base di olio e grasso che protegge dall'ossidazione e dalla corrosione le superfici esterne e parti elettriche dei motori durante l'invernaggio. Evita la formazione dell'ossidazione dovuta alla presenza del salmastro. Facilita l'accensione eliminando i residui di acqua e umidità. Si elimina facilmente.

Produit à base d'huiles et de graisses qui protège les surfaces extérieures et les parties électriques des moteurs de la rouille et de la corrosion pendant l'hivernage. Il empêche la formation de crasses dues à la présence de salpêtre. Il facilite le démarrage en éliminant les résidus d'eau et d'humidité. Il s'enlève facilement.

REF	
GS90090	500 ml

GOLDENSHIP



PINTURA EN SPRAY

SPRAY PAINT

PITTURE SPRAY

PEINTURE EN SPRAY

Sprays de pintura con los colores originales para retoque de los motores fueraborda, interiores, intra-fueraborda y colas fueraborda más usuales. Capacidad: 400ml.

Spray paints with the original colors for maintenance and painting inboards and outboard marine engine as well as stern-drives units. Bottle: 400ml.

Vernice spray con i colori originali per ritocchi dei motori fuoribordo, entrobordo, entro-fuoribordo ed i piedi. Capacità: 400ml.

Peinture en aérosol aux couleurs originales pour la retouche des moteurs hors-bord, in-bord et les embases les plus courantes. Capacité: 400 ml

REF	COLOR	COLOUR	COLORE	COULEUR
GS90019	Barniz transparente	Clear Varnish	Vernice trasparente	Vernis transparent
PS110410	Evinrude Azul (1989)	Blue (1989)	Blu (1989)	Bleu (1989)
GS90037	Evinrude Azul XP	Blue XP	Blu XP	XP bleu
PS111139	Honda Gris Beige (1991)	Grey (1991)	Grigio-Beige (1991)	Gris Beige (1991)
GS90038	Honda Gris metalizado	Grey Metal	Grigio metallizzato	Gris métallisé
GS90023	Honda Plata met.	Silver Metal	Argento metallizzato	Argent métallisé
GS90030	Johnson Blanco (1972-90) - (1993+)	White (1972-90) - (1993+)	Bianco (1972-90) - (1993+)	Blanc (1972-90) - (1993+)
GS90026	Johnson Blanco (1981-83)	White (1981-83)	Bianco (1981-83)	Blanc (1981-83)
GS90039	Johnson Plata metalizado	Silver Metal	Argento metallizzato	Argent métallisé
GS90040	Mariner Gris	Grey	Grigio	Gris
GS90002	Mercury Negro	Black	Nero	Noir
GS90049	Parsun Negro	Black	Nero	Noir
GS90032	Suzuki Plateado (1983-89)	Silver (1983-89)	Argento (1983-89)	Argent (1983-89)
GS90025	Suzuki Gris metalizado	Grey Metal	Grigio metallizzato	Gris métallisé
GS90042	Suzuki Negro metalizado	Black Metal	Nero Metallizzato	Noir métallisé
GS90024	Tohatsu Gris Metal (1991)	Grey Metal (1991)	Grigio Metallizzato (1991)	Gris métallisé (1991)
GS90027	Tohatsu Azul Cobalto (1988-90)	Blue Cobalt (1988-90)	Blu Cobalto (1988-90)	Bleu cobalt (1988-90)
GS90043	Tohatsu Azul	Blue	Blu	Bleu
PS114694	Yamaha Azul Metal (1974)	Blue Metal (1974)	Blu Metallizzato (1974)	Bleu métal (1974)
GS90021	Yamaha Azul (1984+)	Blue (1984+)	Blu (1984+)	Bleu (1984+)
GS90020	Yamaha Azul Origen	Blue Origin	Blu Origen	Bleu Origine
GS90022	Yamaha Gris Metal (1994)	Grey Metal (1994)	Grigio Metallizzato (1994)	Gris métallisé (1994)
PS110485	Yamaha Gris Capot (1994)	Grey Capot (1994)	Grigio Capot (1994)	Gris capot (1994)



GOLDENSHIP

PROTECTOR DIELECTRICO

DIELECTRIC PROTECTOR

PROTETTORE DIELETRICO

PROTECTEUR DIÉLECTRIQUE

Protector dieléctrico antihumedad para uso marino. Protege de la humedad y oxidación todos las partes eléctricas y mecánicas de los motores marinos. Ideal para invierno de motores y mantenimiento de temporada.

Prevents humidity and corrosion of all electric and mechanical parts in marine engines. Specially indicate for winter storages and maintenance in the season.

Protettore dielettrico anti-umidità per uso marino. Protegge dalla umidità e dall'ossidazione tutte le parti elettriche e meccaniche dei motori marini. Ideale per invernaggio dei motori e manutenzione di lunga durata.

Protecteur diélectrique anti-humidité pour usage marin. Protège toutes les pièces électriques et mécaniques des moteurs marins contre l'humidité et l'oxydation. Idéal pour l'hivernage des moteurs et l'entretien saisonnier.

REF	Image
GS90092	400 ml

GOLDENSHIP



DESCALCIFICADOR DE MOTOR

DESCALING ENGINE FLUSH

DECALCIFICANTE MOTORE

DÉTARTRANT MOTEUR

Limpiador para eliminar las incrustaciones, algas, y suciedad en los motores marinos. No daña las juntas ni impulsores de goma.

Removes scale, zebra mussels, general marine growth and vegetation rom all marine engines.

Pulitore per eliminare le incrostazioni, alghe, e sporczia nei motori marini. Non danneggia guarnizioni e giranti in gomma.

Nettoyant pour éliminer le tartre, les algues et la saleté dans les moteurs marins. N'endommage pas les joints ou les turbines en caoutchouc.

REF	Image
STA92600	3,8 L

Starbrite



LIMPIADOR CARBURADOR Y STARTER **CARBURATOR & CHOKE CLEANER**

Aerosol para motores de 2 y 4 tiempos. Para limpieza del carburador y de los componentes internos del motor. Asegura arranques fáciles y ralenti suave. Despega los aros de los pistones. Restablece la potencia del motor.

Spray for all 2 and 4 cycle engines. Marine motor de-carb. Dissolves gum, varnish dirt and carbon deposits. Restore power & performance. Reduce fuel consumption.

PULITORE CARBURATORE

Aerosol per motori di 2 e 4 tempi. Per la pulizia del carburatore e dei componenti interni del motore. Assicura partenze più facili e un minimo stabile. Lubrifica le fasce dei pistoni. Ristabilizza la potenza del motore.

NETTOYANT CARBURATEUR

Spray pour moteurs 2 et 4 temps. Pour nettoyer le carburateur et les composants internes du moteur. Assure des démarrages faciles et un ralenti en douceur. Décolle les segments du piston. Restaure la puissance du moteur.



REF	
GEGC15	354 g



ACEITE DE INVERNAJE **FOGGING OIL** **OLIO INVERNAGGIO** **FOGGING OIL**

Para inyectar en los carburadores de motores a 2 y 4 tiempos. Protege las paredes de los cilindros, aros de pistones y otras superficies de la cámara de combustión durante los periodos de invernaje, facilitando el arranque del motor después de este periodo.

Prevents corrosion when storing inboard or outboard engines for a extended period of time. Special formula makes starting engine after storage quick and easy.

Da inserire nei carburatori dei motori da 2 e 4 tempi. Protegge le pareti dei cilindri, le fasce dei pistoni e altre superfici della camera di combustione durante il periodo di invernaggio, facilitando la partenza del motore dopo questo periodo.

Pour injecter dans les carburateurs des moteurs 2 et 4 temps. Il protège les parois des cylindres, segments et autres surfaces de la chambre de combustion pendant les périodes d'hivernage, facilitant le démarrage du moteur après cette période.



REF	
STA84800	3,8 L
GE22001	340 g



GE22001

STA84800

ADITIVO GASOLINA **GASOLINE ADDITIVE** **ADDITIVO BENZINA** **ADDITIF ESSENCE**

Elimina y previene los problemas del etanol. Reduce todas las emisiones contaminantes. Estabiliza la química del combustible durante 1 año. Reduce el mantenimiento del sistema de combustible. Elimina la producción de carbonilla. Reduce el consumo de combustible.

Eliminates and prevents ethanol fuel problems. Reduces all emissions. Prevents fuel oxidation and stabilizes fuel chemistry for at least 1 year. Lower fuel system maintenance. Eliminates carbon build-up. Increases fuel economy.

Elimina e previene i problemi dell'etanolo. Riduce tutte le emissioni contaminanti. Stabilizza la chimica del combustibile durante 1 anno. Elimina la produzione di residui carboniosi. Riduce il consumo del combustibile.

Élimine et prévient les problèmes d'éthanol. Réduise toutes les émissions polluantes. Stabilise la chimie du carburant pendant 1 an. Réduit l'entretien du système de carburant. Élimine la production de charbon. Réduis la consommation de carburant.



REF		PARA TRATAR HASTA TREAT UP TRATTARE FINO A POUR TRAITER JUSQU'À
STA93008	237 ml	475 L
STA93016	473 ml	950 L



ESTABILIZADOR DE GASOLINA **FUEL STABILIZER** **STABILIZZATORE BENZINA** **STABILISATEUR D'ESSENCE**

Elimina el agua, limpia los carburadores e inyectores. Contiene antioxidantes para prevenir el óxido y la corrosión. No requiere vaciar el depósito para el invernaje y mantiene el combustible fresco para un rápido y fácil arranque.

Keeps fuel fresh and allows for easier starts after periods of storage. Removes water, cleans carburetors and fuel injectors. Contains antioxidant to prevent rust and corrosion.

Elimina l'acqua, pulisce i carburatori e iniettori. Contiene antiossidanti per prevenire l'ossidazione e la corrosione. Non è necessario svuotare il serbatoio per l'invernaggio e mantiene il carburante fresco per una rapida e facile partenza.

Élimine l'eau, nettoie les carburateurs et les injecteurs. Contient des antioxydants pour empêcher la rouille et la corrosion. Il ne nécessite pas de vider le réservoir pour l'hivernage et maintient le carburant frais pour un démarrage rapide et facile.

REF		PARA TRATAR HASTA TREAT UP TRATTARE FINO A POUR TRAITER JUSQU'À	
GE22207	475 ml	150 L	Gasolina Gasoline Benzina Gasoline
GE22254	946 ml	1.200 L	Diesel



GE22254

GE22207

**BARNACLE BUSTER®
LIMPIEZA DE CIRCUITOS
CONCENTRADO**

RÁPIDO, SEGURO, NO TÓXICO,
BIODEGRADABLE, NO CORROSIVO,
NO PELIGROSO

Limpieza de circuitos refrigerados
por agua salada.

Barnacle Buster elimina el
crecimiento de microorganismos
marinos de forma segura, no
tóxica y es 100% biodegradable.
Formulado para ofrecer una
alternativa rápida, segura y
rentable para la limpieza de los
sistemas de refrigeración con
agua de mar sin dañar juntas ni
metales.

Ha pasado la prueba de ensayo
California Marine Life Toxicity
Test.

Concentrado 1:4 (1 parte de Buster en 4
partes de agua).

**BARNACLE BUSTER®
MARINE GROWTH
REMOVER**

Barnacle Buster is a safe, non-
toxic, and biodegradable marine
growth remover specifically
formulated to be a fast, safe,
and cost effective alternative to
mechanical cleaning of water
cooled equipment. Barnacle
Buster can safely be recirculated
through the sea water cooling
systems of main engines,
generators, air conditioners,
etc., dissolving barnacles, zebra
mussels, calcium, rust, lime and
all other mineral deposits.

It passed the California Marine
Life Toxicity Test.

Concentrado 1:4 (1 parte de Buster en 4
partes de agua).

**BARNACLE BUSTER®
PULIZIA DI CIRCUITI
CONCENTRATI**

VELOCE, SICURO, NON TOSSICO,
BIODEGRADABILE, NON
CORROSIVO, NON PERICOLOSO

Pulizia dei circuiti raffreddati
ad acqua salata. Barnacle
Buster elimina la crescita
di microrganismi marini in
modo sicuro, non tossico
ed è biodegradabile al
100%. Formulato per offrire
un'alternativa rapida, sicura ed
economica per la pulizia dei
sistemi di raffreddamento con
acqua di mare senza danneggiare
guarnizioni o metalli. Ha superato
il test California Marine Life
Toxicity Test.

Concentrato 1:4 (1 parte di Buster in 4
parti d'acqua)

**BARNACLE BUSTER®
LA SOLUTION
ÉCOLOGIQUE**

RAPIDE, SÛR, NON TOXIQUE,
BIODEGRADABLE, NON CORROSIF,
NON DANGEREUX

Peut être recyclé en toute
sécurité à travers les systèmes de
refroidissement d'eau de mer.
Elimine tous les coquillages et tous
les autres dépôts minéraux.

Peut être utilisé en toute sécurité
dans: Moteurs, Systèmes de
réfrigération d'eau douce ou salée,
Condensateurs pour les systèmes
de climatisation et de réfrigération,
Systèmes d'eau potable, Echangeurs
de température, Tours de
refroidissement, Refroidisseurs de
quille, Réfrigérateurs, Chauffe-eau...

Il a passé le California Marine Life
Toxicity Test.
Format concentré : 1: 4 (1 partie de
Buster dans 4 parties d'eau).

new

TRAC
ECOLOGICAL
Green Products

REF		
TRE1206MQ	1/4 Gal	0.95 l
TRE1206MG	1 Gal	3.785 l
TRE1206MP	5 Gal	18.9 l

REF		
TRE1212MG	1 Gal	3.785 l



PORT-O-FLUSH JR.

Equipo de limpieza portátil para
barcos de hasta 40', motores
hasta 750hp.

Pequeños equipos de aire
acondicionado, generadores,
sistemas de refrigeración, etc.
Tubería hasta 1,5" de diámetro
interior, proyectos de lavado que
van de 1 a 20 galones.

To cure: Engine Overheating,
Clogged Pipes, Poor Heat
Transfer on Air Conditioning &
Refrigeration Systems, Small Parts
Cleaning
Flushing Projects Ranging From
1-20 Gallons, Engines up to 750
HP, Small air conditioning &
refrigeration systems, Piping up
to 1.5" ID.

Pulizie portatili per barche fino a
40', motori fino a 750hp. Piccoli
impianti di condizionamento,
generatori, sistemi di
raffreddamento, ecc. Tubi fino a
1,5" di diametro interno, progetti
di lavaggio che vanno da 1 a 20
galloni

Équipement de nettoyage
portable pour bateaux jusqu'à
40', moteurs jusqu'à 750hp.
Petit système de climatisation
et de réfrigération, Groupe
électrogène. Petit échangeur de
température.
Tuyauterie jusqu'à 1.5" ID.
Capacité de rinçage de 1-20
Gallons.

REF	
TRE1245E	220V AC 12V



LIMPIADOR DEPOSITOS

FUEL TANK CLEANER

PULITORE SERBATOIO



NETTOYANT RÉSERVOIR

Excepcionalmente efectivo en la limpieza de lodos y algas en depósitos de gasolina o diesel. Retrasa la formación de nuevas algas que puedan contaminar el combustible. Nuevo y revolucionario aditivo que reemplaza los costosos sistemas de limpieza de los depósitos de combustible.

Exceptionally effective at cleaning sludge and algae from gasoline and diesel tanks. Slows the recurrence of new algae that can contaminate fuel. A revolutionary new additive that replaces expensive fuel polishing and tank cleaning.

Eccezionale efficacia nella pulizia dal fango e alghe nel serbatoio benzina o diesel. Ritarda la formazione di nuove alghe che possono contaminare il combustibile. Nuovo e rivoluzionario additivo che rimpiazza i costosi sistemi di pulizia dei serbatoi del combustibile.

Exceptionnellement efficace pour nettoyer les boues et les algues dans les réservoirs d'essence ou de diesel. Il retarde la formation de nouvelles algues qui peuvent contaminer le carburant. Nouvel additif révolutionnaire qui remplace les systèmes coûteux de nettoyage des réservoirs de carburant.

REF		
STA93664	1,9 L	950 L
STA93116	473 ml	1.900 L



STA93116

STA93664

LUBRICANTE PARA 2 TIEMPOS

2 STROKE LUBRICANT

LUBRIFICANTE PER 2 TEMPI

HUILE 2 TEMPS TC-W3

2 STROKES TC-W3



Especialmente formulado para motores marinos de 2 tiempos. Inhibidor de corrosión y herrumbre. Gran capacidad de limpieza de las partes internas del motor (pistón, bujías...), evita el pegado de segmentos y la formación de depósitos. Alta fluidez a bajas temperaturas.

Specially formulated for 2-stroke marine engines. Excellent anti-wear protection for the internal parts of the engine. When the engine is not in use, it effectively protects from corrosion and rust. Very effective in maintaining the internal parts of the engine (pistons, spark plugs, etc.) clean, avoiding piston rings from sticking and sediments accumulating.

Formulazione specificamente studiata per motori marini a 2 tempi. Eccellente protezione contro l'usura dei componenti interni del motore. Garantisce un'alta protezione contro la corrosione e la ruggine. Contribuisce a mantenere pulite le parti interne del motore (pistone, candela, ecc.), evita l'aderenza delle fasce del pistone e la formazione di depositi. Alta fluidità a basse temperature.

Spécialement conçu pour des moteurs 2 temps. Elle vous offre une excellente protection face à l'usure des éléments internes du moteur et une haute protection contre la corrosion et la rouille. Elle a une haute fluidité à basses températures. Notamment applicable dans des conditions climatiques très froides.

QUALITY LEVELS
NMMA TC-W3
(NMMA, National Marine Manufacturers Association)

REF		
REC2TU6	1 L	6
REC2TU3	5 L	3





ACEITE MEZCLA 2 TIEMPOS

2 CYCLE OIL S

OLIO MISCELA 2 TEMPI

HUILE 2 TEMPS

REF	R.O. OEM			
RM92-858026QB1U6	92-858026QB1	1 L	6	PREMIUM PLUS
RM92-858027QB1U3	92-858027QB1	3,8 L	3	PREMIUM PLUS
RM92-858037QB1U3	92-858037QB1	3,8 L	3	OPTIMAX /DFI



RM92-858026QB1U6



RM92-858027QB1U3



RM92-858037QB1U3

ACEITE MINERAL FUERABORDAS TC-W3

Utilize el TC-W3 para obtener mayor potencia en su motor. Provee de una mayor protección contra la carbonilla en los pistones, el resacamiento de los aros, el fallo de las bujías en el arranque y del óxido. Recomendado para los sistemas de inyección de aceite.

2-CYCLE OIL TC-W3



Formulated from ultra-clean base stock oil to provide superior protection against piston scuffing, bearing wear, spark plug fouling, pre-ignition and rust. This formulation has outstanding lubricity and miscibility for better mixing of fuel and oil, resulting in a cleaner running engine. Contains no phosphorus. Recommended for oil injection systems. Outboard motor Oil.

OLIO MINERALE PER FUORIBORDO TC-W3

Utilizzare il TC-W3 per ottenere maggior potenza nel motore. Fornisce una maggiore protezione contro i residui di combustione nei pistoni, l'essiccazione delle fasce, il non funzionamento delle candele nell'accensione. Raccomandato per i sistemi di iniezione ad olio.

HUILE MINÉRALE 2 TEMPS TC-W3

Utilisez la TC-W3 pour augmenter la puissance de votre moteur. Elle offre une meilleure protection contre le carbone dans les pistons, le séchage des segments, la défaillance des bougies d'allumage au démarrage et la rouille. Recommandé pour les systèmes d'injection d'huile.

REF	R.O. OEM		
LUB11591U12		1 L	12
RM92-858021QB1U6	92-858021QB1	1 L	6
RM92-858022QB1U3	92-858022QB1	3,8 L	3
RM92-858023QB1U2	92-858023QB1	9,5 L	2



LUB11591U12 RM92-858021QB1U6 RM92-858022QB1U3 RM92-858023QB1U2

SAE 5W40

ACEITE 100% SINTÉTICO

Lubricante marino 100% sintético. Excelente fluidez en frío, facilita el arranque y reduce los desgastes de motor. Evita el pegado de segmentos al dispersar lodos, barnices y otros productos de oxidación a altas temperaturas. Contiene inhibidores antiherrumbre y anticorrosión.

100% SYNTHETIC OIL

100% synthetic lubricant designed for all types of 4T petrol engines. Good fluidity in cold temperatures facilitates performance and reduces engine wear. It avoids piston rings from sticking by clearing dirt, varnish and other oil oxidation deposits when subject to high temperatures. Contains effective anti-rust and anti-corrosion inhibitors that protect the engine in the marine environment.

OLIO 100% SINTETICO



Lubrificante 100% sintético pensato per motori a benzina 4T di ogni tipo. Buona fluidità a freddo, facilita la messa in moto e riduce l'usura del motore. Evita l'aderenza delle fasce del pistone, disperdendo fanghi, lacche e altri prodotti derivanti dall'ossidazione dell'olio ad alte temperature. Contiene efficaci inibitori antiruggine e anticorrosione, per proteggere il motore in ambiente marino.

HUILE 100% SYNTHÉTIQUE

Lubrifiant 100% synthétique adapté à tout type de moteurs à essence 4T. Bonne fluidité à froid qui aide au démarrage et réduit la détérioration du moteur. Évite le collage des segments lors de la dispersion de boue dans le moteur, vernis et autres produits oxydant l'huile à haute température. Contient des inhibiteurs de corrosion et antirouille.

QUALITY LEVELS
API SN/CF
ACEA A3/B3/B4
MB 229.3
VW 502.00/505.00
RN 710
OPEL A&B
JASO MA2



REF		
REC5W40U6	1 L	6
REC5W40U3	5 L	3
REC5W40205L	205L	1



Especialmente desarrollado para motores de alto rendimiento. Las propiedades especiales de este aceite le permiten lubricar el motor incluso durante el arranque a baja temperatura. El aceite combate la acumulación de lodo y brinda una excelente protección contra el desgaste. Especialmente adecuado para motores que están sujetos a arranques y paradas frecuentes.

Specially developed for high performance engines. The special properties of this oil allow it to lubricate the engine even during low temperature starting. The oil combats sludge build-up and gives excellent protection against wear. Particularly suitable for engines that are subject to frequent starting and stopping.

Sviluppato appositamente per motori ad alte prestazioni. Le proprietà speciali di questo olio consentono di lubrificare il motore anche durante l'avviamento a bassa temperatura. L'olio combatte il fango accumulato e offre un'eccellente protezione contro l'usura. Particolarmente adatto per motori soggetti a frequenti avviamenti e arresti.

Spécialement développé pour les moteurs hautes performances. Les propriétés particulières de cette huile vous permettent de lubrifier le moteur même lors d'un démarrage à basse température. L'huile combat l'accumulation de boue et offre une excellente protection contre l'usage. Particulièrement adapté aux moteurs soumis à des démarrages et arrêts fréquents.



REF	R.O. OEM		
REC21363429	21363429	1 L	API SM
REC21363430	21363430	5 L	



REC21363429

REC21363430

**SAE 10W30
SAE 10W40**

REF	R.O. OEM		
RM92-8M0086220U6	92-8M0086220	1 L	6
RM92-8M0086221U3	92-8M0086221	4 L	3



RM92-8M0086220U6

RM92-8M0086221U3

ACEITE SINTÉTICO PREMIUM

Lubricante marino reforzado con bases sintéticas, para motores gasolina 4T fueraborda e intraborda. Especificaciones NMMA FC-W. HTHS elevado, asegura viscosidad a elevadas temperaturas. Anticorrosivo con antioxidantes incorporados, elevadas propiedades antiespumantes.

SYNTHETIC PREMIUM OIL

Marine lubricant strengthened with a synthetic base, especially formulated for outboard and inboard 4T petrol engines, with NMMA FC-W specifications. With a high HTHS, it ensures great viscosity at high temperatures. Better anti-oxidant resistance. Improved anti-foaming properties.



OLIO SINTETICO PREMIUM

Lubrificante marino potenziato con basi sintetiche, specificamente formulato per motori a benzina 4T fuoribordo ed entro bordo, a norma specifiche NMMA FC-W. Con indice HTHS più elevato, garantisce un'alta viscosità a temperature elevate. Aumenta la protezione anticorrosione. Maggior resistenza all'ossidazione. Proprietà antischiuma migliorate.



HUILE SYNTHÉTIQUE PREMIUM

Lubrifiant marin renforcée avec des bases synthétiques, pour les moteurs à essence 4T hors-bord et inboard avec des spécifications NMMA FC-W. Avec des HTHS supérieures, qui vous assure une haute viscosité à des températures élevés. Résistance antioxydante majeure. Propriétés anti-mousse améliorées.

QUALITY LEVELS:
NMMA FC-31015T
(NMMA, National Marine Manufacturers Association)
API SJ/SG

REF		
REC10W30U6	1 L	6
REC10W30U3	5 L	3
REC10W3020L	20 L	1
REC10W3050L	50 L	1
REC10W30205L	205 L	1

QUALITY LEVELS
NMMA FC-11815R
(NMMA, National Marine Manufacturers Association)
API SJ/SG

REF		
REC10W40U6	1 L	6
REC10W40U3	5 L	3
REC10W4020L	20 L	1
REC10W4050L	50 L	1
REC10W40205L	205 L	1



SAE 15W40

MULTIGRADE HIGH PERFORMANCE



Lubricante multigrado marino, superior al nivel SHPD, especialmente formulado para motores marinos turboalimentados. Contiene inhibidores de corrosión, oxidación, herrumbre y antiespumantes. Capacidad detergente, reduce los depósitos en válvulas y pistones. Excelentes cualidades dispersantes antilodos.

Marine multigrade oil, exceeds the SHPD performance level, especially formulated to meet the demanding requirements of 4-stroke diesel turbocharged engine manufacturers in the marine environment. Contains effective corrosion, oxidation, rust and foam inhibitors. Excellent detergent effect that reduces sediments in valves and pistons. Very good dispersion qualities that prevent sludge in cold temperatures.

Olio marino multigrado, con prestazioni oltre il livello SHPD, specificamente formulato per soddisfare le particolari esigenze dei motori diesel a 4 tempi turboalimentati in ambiente marino. Contiene efficaci inibitori contro corrosione, ossidazione, ruggini e formazione di schiuma. Eccellente capacità detergente, riduce i depositi in valvole e pistoni. Ottime qualità disperdenti che impediscono la formazione di fanghi a freddo.

Huile multigrade marine, dépasse les niveaux de performances SHPD, spécialement conçu pour les moteurs diesel 4T avec turbo. Contient des inhibiteurs contre la corrosion, l'oxydation, antirouille et anti-mousse. Évite les dommages dans les chemises, habituel sur les moteurs suralimentés de haute puissance. Haute qualité dispersante pour empêcher l'apparition de boue dans le moteur.

QUALITY LEVELS
API CI-4/SL
ACEA E7
Caterpillar ECF-1^a
Cummins CES 20071/72/76/77/78
MACK EO-M+
MAN M3275
MB 228.3
MTU Level 2
Renault RLD/RLD-2
Volvo VDS-2 VDS-3

REF		
REC15W40U3	5 L	3
REC15W4020L	20 L	1
REC15W4050L	50 L	1
REC15W40205L	205 L	1



ACEITE MINERALES VDS-3

VDS-3 cubre los requisitos más estrictos sobre la limpieza del pistón en comparación con VDS-2, lo que garantiza la durabilidad y fiabilidad de los motores. La alta calidad del aceite VDS-3 permite un aumento en los intervalos de drenaje. Para motores diesel y de gasolina (ver manuales de los operadores).

VDS-3 MINERAL GEAR OILS

VDS-3 covers even more stringent requirements on piston cleanliness and bore polish compared to VDS-2, ensuring the durability and reliability of the engines. The high quality of VDS-3 oil allows in certain cases an increase in drain intervals. Fits both diesel and gas engines (check operators manuals).

OLIO MINERALE VDS-3

VDS-3 copre requisiti ancora più stringenti sulla pulizia del pistone e sulla lucidatura del foro rispetto a VDS-2, garantendo la durata e l'affidabilità dei motori. L'alta qualità dell'olio VDS-3 consente un aumento degli intervalli di scarico. Adatto sia ai motori diesel che a quelli a gas (consultare i manuali degli operatori).

HUILE MINÉRALE VDS-3

Le VDS-3 couvre les exigences les plus strictes en matière de nettoyage des pistons par rapport au VDS-2, ce qui garantit la durabilité et la fiabilité des moteurs. La haute qualité de l'huile VDS-3 permet une augmentation des intervalles de vidange. Pour les moteurs diesel et essence (voir les manuels d'utilisation).

REF	R.O. OEM		
REC22479638	22479638	1 L	API CI-4
REC22479642	22479642	5 L	ACEA E5



REC22479638

REC22479642

ACEITE MOTORES DIESEL

DIESEL ENGINES OIL

OLIO MOTORE DIESEL

HUILE MOTEUR DIESEL

REF	R.O. OEM		
RM92-8M0096794U3	92-8M0096794	3,8 L	3



SAE 25W40

ACEITE SEMISINTÉTICO 4T

Lubricante semisintético para motores con cargas y RPM elevadas. Excelentes inhibidores de corrosión, oxidación y desgaste. Buenas propiedades de arranque en frío, antiespumantes incorporados.

4 STROKES SEMI-SYNTHETIC OIL

Semi-synthetic oil for 4-stroke engines suitable for engines with high RPM and heavy loads. Lubrication of all engine components, great anti-corrosion, anti-oxidation and anti-wear properties. Good performance in cold conditions. Keeps the engine clean and increases protection against corrosion in saline water environments.

OLIO SEMISINTETICO 4 TEMPI



Olio semisintetico per motori a 4 tempi, adatto a motori con elevati RPM e carichi pesanti. Lubrificazione di tutti i componenti del motore, elevate proprietà anticorrosione, antiossidazione e antiusura. Buone proprietà di avvio a freddo.

HUILE SEMI-SYNTHÉTIQUE 4T

Huile semi-synthétique pour des moteurs 4T adapté aux moteurs avec des hauts RPM. Grande capacité anti-corrosion, anti-oxydation et contre l'usure. Propriétés adéquates pour un démarrage à froid. Elle maintient la propreté du moteur et augmente la protection face à la corrosion du à l'environnement salin.



QUALITY LEVELS
NMMA FC1310TT
(NMMA, National Marine
Manufacturers Association)
API SJ/SG

REF		
REC25W40U3	5 L	3
REC25W40205L	205 L	1



ACEITE SINTÉTICO PARA MOTORES VERADO

SYNTHETIC OIL FOR VERADO ENGINES

OLIO SINTETICO PER MOTORI VERADO

HUILE SYNTHÉTIQUE POUR VERADO

REF	R.O. OEM		
RM92-8M0086227U3	92-8M0086227	4 L	3





ACEITE MOTORES GASOLINA

GASOLINE ENGINES OIL

OLIO MOTORE BENZINA

HUILE MOTEUR ESSENCE

REF	R.O. OEM		
RM92-8M0086224U3	92-8M0086224	3,8 L	3



ACEITE SINTÉTICO TRASMISIONES

SYNTHETIC DRIVES OIL

OLIO SINTETICO PER TRASMISSIONE



HUILE SYNTHÉTIQUE POUR EMBASES

Aceite sintético de altas prestaciones. Para colas de transmisión mecánica.

High performance synthetic Lower Unit Gear Lube for mechanical drives.

Olio sintetico di alte prestazioni. Per piedi poppieri a trasmissione meccanica.

Huile synthétique haute performance. Pour les embases mécanique.

REF	R.O. OEM		
RM92-858064QB1U6	92-858064QB1	1 L	6
RM92-858065QB1U2	92-858065QB1	9,5 L	2



RM92-858064QB1U6

RM92-858065QB1U2

SAE 75W90

ACEITE PARA TRANSMISION IPS

Lubricante marino sintético GL-5 para transmisiones IPS y reductoras. Soporta elevadas temperaturas internas sin descomponerse así como cargas considerables sin causar desgaste. Excelente protección a cualquier temperatura.

OIL FOR IPS TRANSMISSION

GL-5 synthetic oil of the highest quality for marine drives and IPS transmissions. It can also withstand very high temperatures without breaking down. Withstands heavy loads preventing wear.



OLIO PER TRASMISSIONE IPS

Olio sintetico GL-5 di altissima qualità per s-drive, trasmissioni IPS e riduttori. In quanto olio sintetico, garantisce un'eccellente protezione a basse ed elevate temperature. Può inoltre sostenere altissime temperature senza decomporsi. Sostiene carichi considerevoli senza provocare usura.

HUILE SYNTHETIQUE POUR TRANSMISSIONS

Huile synthétique GL-5 de haute qualité pour transmissions IPS, SX etc... En tant qu'huile synthétique, elle garantit une excellente protection à basses et hautes températures. Elle peut également résister à des températures très élevées sans se détériorer. Elle supporte des charges considérables sans provoquer d'usure.

QUALITY LEVELS
API GL-5

REF		
REC75W90U6	1 L	6
REC75W90U3	5 L	3
REC75W9020L	20 L	1



SAE 75W140

ACEITE PARA TRANSMISION

Lubricante marino de alto rendimiento para transmisiones. Excelentes prestaciones que evitan el desgaste y presiones extremas, la temperatura ambiente y condiciones de trabajo no alteran su capacidad lubricante.

OIL FOR TRANSMISSION

High performance oil designed for marine transmissions. Excellent performance that prevents wear and extreme pressure, providing maximum protection to the transmission; temperatures and working conditions do not alter its lubricating effect.

OLIO PER TRASMISSIONE

Olio ad alto rendimento per trasmissioni nautiche. Eccellenti prestazioni che evitano usura e pressioni estreme, garantendo la massima protezione della trasmissione; la temperatura ambiente e le condizioni di lavoro non ne modificano le proprietà lubrificanti. Temperatura e rumore ridotti grazie alla riduzione dell'attrito.

HUILE SYNTHETIQUE POUR TRANSMISSIONS

Huile haute performance pour embase DP-G, DPH 1.59/1 qui évite l'usure et les pressions extrêmes, assurant une protection maximale de la transmission; la température ambiante et les conditions de travail ne modifient pas leurs propriétés lubrifiantes. Température et bruit réduits grâce à la réduction des frottements.



QUALITY LEVELS

API GL-5
API MT-1
ARVIN MERITOR 0-76-M
Mack GO-J
MIL-PRF-2105E
SAE J2360
Scania STO 1:0 - 2:0A
ZF TE-ML 05A - 07A - 12N - 16F - 19C - 21A

REF		
REC75W140U3	5 L	3



Lubricante marino para transmisiones de motores intraborda y fueraborda de los principales fabricantes, que requieren aceites con una calidad API GL 5. Consulte el manual de usuario antes de elegir el lubricante.



GL-5 synthetic oil of the highest quality for marine drives and IPS Oil recommended for the transmission of inboard and outboard engines of the main manufacturers that require API GL 5 quality oils. Read the user manual before choosing a lubricant.

Olio sintetico GL-5 di altissima qualità per s-drive, trasmissioni IPS e riduttori. Olio consigliato per trasmissioni entro-bordo e fuoribordo dai principali produttori che richiedono oli di qualità API GL 5. Consultare il manuale d'uso prima di scegliere il lubrificante.

Huile Synthétique recommandé par les principaux fabricants conçu pour des transmissions de moteur inboard et hors-bord qui précisent d'une qualité API GL 5. N'hésitez pas à consulter le manuel d'utilisation avant de choisir votre lubrifiant.

QUALITY LEVELS

API GL-5

REF		
REC80W90U6	1 L	6
REC80W90U3	5 L	3



ACEITE TRIM / TILT

POWER TRIM & TILT FLUID

OLIO TRIM / TILT

HUILE DE TRIM/TILT

Proporciona la viscosidad y lubricación necesaria para asegurar el perfecto funcionamiento de la bomba alargando la vida de los retenes y juntas.

Formulated to provide viscosity and lubricity necessary to ensure proper pump performance and seal life.

Fornisce la viscosità e la lubrificazione necessaria per assicurare il perfetto funzionamento della pompa allungando la vita delle guarnizioni.

Elle fournit la viscosité et la lubrification nécessaires pour assurer le fonctionnement parfait de la pompe, prolonge la durée de vie des joints/joints.

REF		
LUB11578U12	280 g	12



ACEITES SINTÉTICOS

SYNTHETIC OILS

OLIO SINTETICO



HUILES SYNTHÉTIQUES

Aceite sintético de alta calidad. Para colas de transmisión mecánica. Especialmente indicados para los motores de gran cilindrada o de uso frecuente. Reduce el grado de fricción y calentamiento. No se mezcla con el agua. No anula las garantías de los fabricantes.

Lower Unit Gear Lube for mechanical drives. A synthetic gear lube that protects high-performance lower units in extreme operating conditions. Highly recommended for all engines over 100 hp. Will not avoid manufacturers' warranties.

Olio sintetico di alta qualità. Per trasmissione meccanica. Indicato specialmente per motori di grande cilindrata o di uso frequente. Riduce il grado di attrito e riscaldamento. Non si mescola con l'acqua. Non annulla la garanzia del produttore.

Huile synthétique de haute qualité. Pour les embases mécanique. Particulièrement adapté pour les moteurs de grande cylindrée ou à usage fréquent. Réduit le degré de friction et d'échauffement. Elle ne se mélange pas à l'eau. N'annule pas les garanties du fabricant.

REF		
LUB11564U12	1 L	12
LUB11565	19 L	1



LUB11564U12

LUB11565

ACEITE MINERALES

MINERAL GEAR OILS

OLIO MINERALE



HUILE MINÉRALE

Para colas de transmisión mecánica. Especialmente indicados para los motores de gran cilindrada o de uso frecuente. Fabricado con aditivos especiales para proveer una máxima durabilidad e inhibidores de la corrosión para una mayor protección contra el óxido y la corrosión.

Lower Unit Gear Lube for mechanical drives. Lower Unit Gear Lube. Ideal for modern outboard and stern drive lower units. Will not avoid manufacturers' warranties.

Per piedi poppieri a trasmissione meccanica. Indicato specialmente per motori di grande cilindrata o di uso frequente. Fabricato con additivi speciali per fornire una massima durata e impedire la corrosione per una maggiore protezione contro l'ossidazione e la corrosione.

Pour les embases mécanique. Particulièrement adapté pour les moteurs de grande cylindrée ou à usage fréquent. Fabriqué avec des additifs spéciaux pour offrir une durabilité maximale et des inhibiteurs de corrosion pour une meilleure protection contre la rouille et la corrosion.

REF			
LUB11540U12	280 g	12	
LUB11552U12	1 L	12	
LUB11546	19 L	1	



LUB11540U12

LUB11552U12

LUB11546

KIT ACEITE COLAS

LOWER UNIT LUBE KIT

KIT OLIO PIEDI

KIT D'HUILE D'EMBASE

Kit para cambiar el aceite mineral de las colas OMC, Volvo, Mercruiser, Mercury y Mariner.

Includes 2 tubes of high-viscosity lower unit gear lube. For OMC, Volvo, Mercruiser, Mercury & Mariner drives.

Kit per cambiare l'olio minerale dei piedi poppieri OMC, Volvo, Mercruiser, Mercury e Mariner.

Kit pour changer l'huile minerale des embases OMC, Volvo, Mercruiser, Mercury et Mariner etc...

REF	
LUB11101	385 g



GRASA MARINA. INSOLUBLE AL AGUA

Grasa marina semisintética con base de litio-calcio, de cuerpo espeso y color azul. 100% insoluble al agua, especialmente formulada para todo tipo de aplicaciones náuticas incluso prensaestopas y hélices plegables, gracias a la buena adhesión al metal.

MARINE GREASE. NON-WATER-SOLUBLE



Semi-synthetic marine grease with lithium and calcium base, thick and blue. 100% non-water-soluble, especially formulated for all nautical uses, including cable glands and foldable propellers, thanks to good adherence to metal.

GRASSO MARINO. INSOLUBILE IN ACQUA

Grasso marino semisintetico a base di litio-calcio, di aspetto denso e di colore azzurro. 100% insolubile in acqua, specificamente formulato per applicazioni nautiche di tutti i tipi, compresi premistoppa ed eliche pieghevoli, grazie all'alta aderenza ai metalli.

GRAISSE MARINE INSOLUBLE A L'EAU

Graisse marine semi-synthétique à base de lithium-calcium, épais et bleu. 100% insoluble avec l'eau, spécialement conçu pour tout type d'application nautiques, même pour des presse-étoupes et les hélices pliables grâce à sa propriété d'adhésion au métal.

REF		
RECGREU1	5 kg	1
RECGREU2	400 g	12



Lubricante insoluble al agua, ideal para aplicaciones marinas. Excelente protección contra fricciones, óxido y corrosión.

Special calcium sulfonate complex, water insoluble formula ideal for marine applications. Provides excellent corrosion protection under severe conditions caused by salt water and air.

Lubrificante insolubile all'acqua, ideale per applicazioni marine. Eccellente protezione contro l'attrito, l'ossido e la corrosione.

Lubrifiant insoluble dans l'eau, idéal pour les applications marines. Excellente protection contre le frottement, la rouille et la corrosion.

REF		PISTOLA GUN PISTOLA PISTOLET	
LUB11400	85g	RECT30190	3
LUB11402	400 g	RECT30201	1
LUB11406	280 g	LUB30197	1
LUB11407	13,5 kg		1
LUB11404	450 g		1



GRASA DE LITIO

Grasa de litio con Teflón. Color blanco.

LITHIUM GREASE

Heavy duty white lithium grease with Teflon.

GRASSO AL LITIO

Grasso al litio con Teflón. Colore bianco.

GRAISSE AU LITHIUM

Graisse au lithium avec téflon. Couleur blanche.

REF	
LUB11363	350 ml



ACCESORIOS Y HERRAMIENTAS DE INSTALACIÓN

ACCESSORIES AND INSTALATION TOOLS

ACCESSORI E ATTREZZI ISTALAZIONE

ACCESSOIRES ET OUTILS D'INSTALLATION

PISTOLA DE GRASA

LEVER GREASE GUN

PISTOLE GRASSO



POMPE A GRAISSE

Incluye manguera curvada y conector standard. Ideal para engrasar crucetas, cables de dirección, cañas de motor fuerborda, piñones y cualquier otra parte del motor que precise engrase. Con visor para reservá. Se recarga sin necesidad de tubo.

Standard Lever grease gun. Includes curved pipe and std coupler. Ideal for greasing spreaders, steering wires, rods outboard engine, gear bearing and other parts of the engine that needs greasing. With Viewer for reservation. Will reload without tube.

Include tubo flessibile curvo e connettore standard. Ideale per ingrassare cavi dello sterzo, barre del motore fuoribordo, ingranaggi e qualsiasi altra parte del motore che abbia bisogno di lubrificazione. Con visora per la prenotazione. Si ricarica senza tubo.

Comprend un tuyau incurvé et un connecteur standard. Idéal pour graisser les traverses, les câbles de direction, les tiges de moteur entraîné, les pignons et toute autre partie du moteur qui a besoin d'être graissée. Avec viseur pour réservation. Il se recharge sans tube.

REF		
RECT30201	600 cc	16000 psi
LUB10212	Manguera 30 cm Hose 30 cm Tubo 30 cm Tuyau 30 cm	



LUB10212



RECT30201

Pistola para tubos de grasa. Incluye manguera flexible de 14 cm y adaptador standard.

All purpose gun operates handy, squeeze tubes. Includes 2-11/16" pipe and plastic push-type coupler.

Pistola per tubi di grasso. Include tubo flessibile da 14 cm e adattatore standard.

Pistolet pour tubes de graisse. Comprend un tuyau flexible de 14 cm et un adaptateur standard.

REF
LUB30197



KIT PISTOLA + GRASA

MIDGET GREASE GUN KIT

KIT PISTOLA + GRASSO

KIT PISTOLET + GRAISSE

Kit compuesto de una pistola pequeña y muy versátil que permite la salida del tubo conector frontal o superior. Presión máxima 300 k/cm². Incluye un bloqueador para mantener el cartucho en posición y tubo de salida de 14 cm. Admite cartuchos de 3 onzas (85 g) o grasa a granel.

Marine corrosion control lubrication kit. Small, versatile gun allows for front or top pipe placement. Barrel takes 3 oz grease cartridge or can be bulk loaded. Develops up to 4,500 psi.

Kit composto da una pistola piccola e molto versatile che permette l'uscita del grasso dal tubo frontale o superiore. Pressione massima 300 k/cm². Include un blocco per tenere la cartuccia in posizione, il tubo è da 14 cm. Utilizza cartuccia da 85 gr o grasso sfuso.

Kit composé d'un petit pistolet très polyvalent qui permet la sortie du tube de connexion avant ou supérieur. Pression maximale 300 k / cm². Il comprend un bloqueur pour maintenir la cartouche en position et un tube de sortie de 14 cm. Prend en charge des cartouches de 3 oz (85 g) ou de la graisse en vrac.

REF
RECT30190



PISTOLA DE ACEITE

BOTTLE GREASE PUMP

PISTOLA OLIO

POMPE POUR HUILE

Pistola para acoplar en los envases de botella de 1 litro de LUB11552 y LUB11564. Se suministra con kit de adaptación con válvula anti-retorno.

Lower unit quart pump. Complete with metal threaded filler fitting.

Pistola da accoppiare a bottiglie da 1 L LUB11552 e LUB11564. Si vende con kit di accoppiamento con valvola anti-ritorno.

Pompe pour les bidons de 1 litre de LUB11552 et LUB11564. Livré avec kit d'adaptation avec clapet anti-retour.

REF
REC55005
RECMAR



BOMBA DEPÓSITO

GREASECASE FILLER

POMPA OLIO

POMPE DE REMPLISSAGE

Para llenado de colas. Con válvula de ventilación para evitar derrames.

With check valve venting system to avoid overflow

Per mettere l'olio nei piedi poppier. Con valvola di sfianto per evitare fuoriuscite.

Pour le remplissage des embases. Avec valve de ventilation pour éviter les déversements.

REF				
REC55133GF	Bomba depósito	Greasecase filler	Pompa olio	Pompe de remplissage
REC55133M	Adaptador métrico (excepto Suzuki)	Metric adaptor (excl. Suzuki)	Adattatore metrico (eccetto Suzuki)	Adaptateur métrique (sauf Suzuki)
REC55133S	Adaptador para Suzuki	Adaptor for Suzuki	Adattatore per Suzuki	Adaptateur Suzuki

RECMAR



REC55133M

REC55133S



KI ENGRASADORES MÉTRICOS

METRIC GREASE FITTINGS

KIT LUBRIFICATORI METRICI

KIT GRAISSEURS MÉTRIQUES

REF	0°	45°	90°	
LUB11957	4	2	2	M6x1

LubriMatic

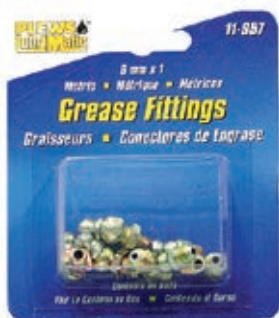

REF	90°	
RECT11958	4	M6x1

RECMAR



OREJERAS REDONDAS

Tomas de agua para refrigeración de motores fueraborda y colas intra-fueraborda.



REF	
GS30350	1



MOTOR FLUSHER ROUND

For use on most outboards and inboard/outboards engines with side water inlets.

CUFFIE LAVAGGIO ROTONDE

Cuffie lavaggio per motori entro-fuoribordo e fuoribordo.

USO PROFESIONAL
PROFESSIONAL
USO PROFESSIONALE
USAGE PROFESSIONNEL

REF	
GS30351	1



OREILLES RONDES

Sorties d'eau pour le refroidissement du moteur hors-bord et in-bord.

OREJERAS CUADRADAS

Tomas de agua para refrigeración de motores fueraborda y colas intra-fueraborda.



REF	
GS30352	1



MOTOR FLUSHER SQUARE

For use on most outboards and inboard/outboards engines with side water inlets.

CUFFIE LAVAGGIO QUADRATE

Cuffie lavaggio per motori entro-fuoribordo e fuoribordo.

USO PROFESIONAL
PROFESSIONAL
USO PROFESSIONALE
USAGE PROFESSIONNEL

REF	
GS30353	1



OREILLES CARRÉES

Sorties d'eau pour le refroidissement du moteur hors-bord et in-bord.

EXTRACTOR IMPULSORES

Extractor para impulsores flexibles de bombas, motores fueraborda e interiores.

REF	
GS20198	Ø 65 mm 2-1/2"
GS20199	Ø 77 - 127 mm Ø 3" - 5"



IMPELLER REMOVAL

Flexible impeller removal tool, suitable for all marine flexible impellers of water pumps, outboard and inboard engines.

ESTRATTORE GIRANTE

Estrattore per giranti di pompe di motori fuoribordo e entro-bordo.

EXTRACTEUR DE TURBINE

Extracteur pour turbines flexibles, moteurs hors-bord et in-bord.



EXTRACTOR COJINETES Y HÉLICES

Extractor de cojinetes y hélices, con patas. Para todos los cojinetes Mercruiser y la mayoría de las hélices.

REF
REC90095



PROP AND BEARING PULLER

Prop and bearing carrier puller. For Mercruiser All Style Bearing Carrier and Most Props.

ESTRATTORE CUSCINETTI E ELICHE

Estrattore cuscinetti e eliche. Per tutti i cuscinetti Mercruiser e la maggior parte delle eliche.

EXTRACTEUR DE ROULEMENT ET D'HELICE

Extracteur de roulements et hélices. Pour tous les roulements Mercruiser et la plupart des hélices.



Para hélices y cojinetes antiguos
For prop and old style bearing carrier.
Per eliche e cuscinetti vecchi.
Pour hélices et roulements anciens



Para cojinetes modernos
For new style bearing carrier.
Per cuscinetti moderni.
Pour roulements modernes



FONENDOSCOPIO	SPARK GAP TESTER	FONENDOSCOPIO	PHONENDOSCOPE
<p>Instrumento de precisión, resistente a golpes, detecta fácilmente ruidos en motores, cojinetes y otras partes móviles. Incluye varilla de test, trompeta y auriculares.</p>	<p>Sensitive, shockproof instrument, easily locates noises in engines bearings and other moving parts. Includes aluminium alloy probe / needle, surgical PVC, rubber trumpet and plastic earphones.</p>	<p>Strumento di precisione, resistente a colpi, rileva facilmente rumori nel motore, nei cuscinetti e altre parti mobili. Include la tromba e gli auricolari.</p>	<p>Instrument de précision, résistant aux chocs, détecte facilement le bruit dans les moteurs, roulements et autres pièces mobiles. Comprend une tige d'essai, une trompette et des écouteurs.</p>
<p>REF REC91-00003</p> 			

EXTRACTOR PIÑONES Y COJINETES	UNIVERSAL PULLER PLATE	ESTRATTORE PIGNONE E CUSCINETTI	EXTRACTEUR DE PIGNON ET PALIER								
<table border="1"> <thead> <tr> <th>REF</th> <th>PIÑONES BEARINGS PIGNONE PIGNON</th> </tr> </thead> <tbody> <tr> <td>REC91-00001</td> <td>30-50 mm / 1 1/4" ~ 2 1/4"</td> </tr> <tr> <td>REC91-00002</td> <td>50-75 mm / 2 1/4" ~ 3 1/2"</td> </tr> <tr> <td>REC91-37241</td> <td>75-105 mm / 3" ~ 4 1/2"</td> </tr> </tbody> </table> <p>REF REC91-00001 REC91-00002 REC91-37241</p> 	REF	PIÑONES BEARINGS PIGNONE PIGNON	REC91-00001	30-50 mm / 1 1/4" ~ 2 1/4"	REC91-00002	50-75 mm / 2 1/4" ~ 3 1/2"	REC91-37241	75-105 mm / 3" ~ 4 1/2"			
REF	PIÑONES BEARINGS PIGNONE PIGNON										
REC91-00001	30-50 mm / 1 1/4" ~ 2 1/4"										
REC91-00002	50-75 mm / 2 1/4" ~ 3 1/2"										
REC91-37241	75-105 mm / 3" ~ 4 1/2"										

LLAVE DINAMOMÉTRICA	TORQUE WRENCH	CHIAVE DINAMOMETRICA	CLÉ DYNAMOMÉTRIQUE
<p>Con escala en: 20-150 pie/lb y 33.9 - 210 N.m Incrementos cada 1 pie/lb y 1,4 N.m Dado de conexión: 1/2"</p>	<p>Scale in: 20-150 ft.-lbs. 33.9 - 210 N.m Increases each 1 ft.-lbs. & 1,4 N.m 1/2" drive.</p>	<p>Con scala da: 20-150 piedi/lb e 33.9 - 210 N.m Incremento di 1 pie/lb e 1,4 N.m Dado attacco: 1/2"</p>	<p>Avec échelle à: 20-150 pieds/livres et 33.9 - 210 N.m Incrémente tous les 1 pied/livre et 1,4 N.m Embout de connexion: 1/2"</p>
<p>REF CRA944595</p>  <p>518 x 35 x40 mm</p>			

LLAVE FRENO VOLANTE PARA FUERABORDAS	FLYWHEEL HOLDER PER OUTBOARDS	CHIAVE FRENO VOLANTE PER FUORIBORDO	CLÉ FREIN DE VOLANT POUR HORS-BORD
<p>REF REC5515100</p> 			

CHISPÓMETRO	SPARK GAP TESTER	SCINTILLOMETRO	CONTRÔLEUR D'ALLUMAGE						
<p>Se puede comprobar la chispa con el motor en funcionamiento.</p>	<p>Good for checking spark on running engine.</p>	<p>Si può provare la scintilla con il motore in funzione.</p>	<p>L'étincelle peut être vérifiée avec le moteur en marche.</p>						
<table border="1"> <thead> <tr> <th>REF</th> <th>CYL</th> </tr> </thead> <tbody> <tr> <td>REC5119766</td> <td>8</td> </tr> <tr> <td>REC004</td> <td>1</td> </tr> </tbody> </table> <p>REF REC5119766 REC004</p> 	REF	CYL	REC5119766	8	REC004	1	 <p>REC5119766</p>	 <p>REC004</p>	
REF	CYL								
REC5119766	8								
REC004	1								

KIT EXTRACTOR DE POLEAS PULLER TOOL KIT

Extractor de polea contrapesos. Contiene 5 juegos de tornillos de diferentes medidas.

Harmonic ballancer puller. 5 sets of screws are provided.

KIT ESTRATTORE PULEGGE KIT EXTRACTEUR DE POULIE

Estrattore di pulegge. Contiene 5 kit di viti di differenti misure.

Extracteur de poulie. Il contient 5 jeux de vis de différentes tailles.

REF
SSP4600
RECMAR



Kit para extraer e instalar poleas. Para uso en todos los motores Ford, GM y Chrysler. También puede utilizarse para volantes de dirección y poleas en general. Esfuerzo máximo recomendado: 20 kg.

Harmonic ballancer puller and installation tool kit. Use on all Ford, GM & Chrysler engines. Heavy duty tool. Can also be used for steering wheels and pulleys

Kit per estrarre e installare pulegge in tutti i motori Ford, GM e Chrysler. Si può utilizzare per volani di direzione e pulegge in generale. Carico massimo: 20 kg.

Kit pour extraire et installer les poulies. À utiliser sur tous les moteurs Ford, GM et Chrysler. Il peut également être utilisé pour les volants et les poulies en général. Effort maximal recommandé: 20 kg.

REF
SSPHBP100K
RECMAR



EXTRACTOR FILTROS

OIL FILTER WRENCH

ESTRATTORE FILTRI

CLÉ À FILTRE

REF
PARA FILTROS
FILTERS
PER FILTRI
POUR FILTRES
REC70720 65 - 110 mm

RECMAR

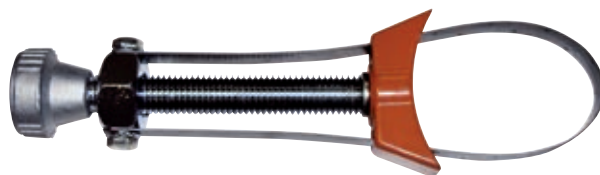

HERRAMIENTA AROS-PISTONES

RING COMPRESOR KIT

KIT FASCE-PISTONI

OUTIL SEGMENTS ET PISTONS

Kit herramientas para la instalación de aros y pistones. Incluye 6 bandas de 7 a 11 cm.

Ring compressor kit for pistons. Includes 6 band 2-7/8" - 4-3/8"

Kit per montare le fasce dei pistoni. Include 6 bande da 7 a 11 cm.

Kit d'outils pour l'installation des segments et pistons. Il comprend 6 colliers de 7 à 11 cm.

REF
SSP4213
RECMAR





REF
PARA AROS Y PISTONES
RING COMPRESOR PISTONS
PER FASCE E PISTONI
POUR SEGMENTS ET PISTONS
SSP4206 127 mm Ø / 2-1/8" - 5" Ø
SSP4207 178 mm Ø / 3-1/2" - 7" Ø

RECMAR



JUEGO DE MACHOS	TAP AND DIE SET	FILIERA	KIT TARAUDS ET FILIÈRES
Garantía de por vida.	Lifetime warranty.	Garantita a vita.	Garantie à vie
REF			
CRA952343	Pulgadas Inches Pollici		
CRA952344	Pouce Métricos Metrical Metrico Métrique		

EXTRACTOR TAPONES DE TRIM	TRIM PLUGS EXTRACTOR	ESTRATTORE PER TAPPI DI TRIM	EXTRACTEUR DE BOUCHON DE TRIM																																																																
REF																																																																			
RECTOOLTRIMKIT	RECTOOLTRIM1 + RECTOOLTRIM2 + RECTOOLTRIM3		KITS DE RECAMBIO SPARE KITS KIT DI RICAMBIO KITS DE RECHANGE																																																																
REF	ÚTIL TOOL ATTREZZO UTILE	(A)	REF																																																																
RECTOOLTRIM1	1/2" + RECPIN4 + RECPIN4.5	38 mm	RECPIN4																																																																
RECTOOLTRIM2	1/2" + RECPIN4 + RECPIN4.5	32 mm	RECPIN4.5																																																																
RECTOOLTRIM3	1/2" + RECPIN6	35 mm	RECPIN6																																																																
			PARA FOR PER POUR																																																																
			RECTOOLTRIM1																																																																
			RECTOOLTRIM1																																																																
			RECTOOLTRIM3																																																																
			Los pines de repuesto no tienen garantía. Replacement pins are not guaranteed. I perni di ricambio non sono garantiti. Les broches de remplacement ne sont pas garanties.																																																																
<table border="1"> <thead> <tr> <th>TRIM PISTON</th> <th>TILT PISTON</th> <th>HP</th> </tr> </thead> <tbody> <tr><td>RECTOOLTRIM1</td><td>Yamaha</td><td>F25 - F40</td></tr> <tr><td>RECTOOLTRIM2</td><td>RECTOOLTRIM3</td><td>Yamaha F115</td></tr> <tr><td>RECTOOLTRIM2</td><td>RECTOOLTRIM3</td><td>Yamaha F150</td></tr> <tr><td>RECTOOLTRIM2</td><td>RECTOOLTRIM1</td><td>Yamaha F150</td></tr> <tr><td>RECTOOLTRIM2</td><td>RECTOOLTRIM3</td><td>Yamaha F175 - F200 (2.8L)</td></tr> <tr><td>RECTOOLTRIM1</td><td>RECTOOLTRIM1</td><td>Yamaha F200 - F250 (3.3L)</td></tr> <tr><td>RECTOOLTRIM1</td><td>RECTOOLTRIM1</td><td>Yamaha F225 - F300 (4.2L)</td></tr> <tr><td>RECTOOLTRIM2</td><td>RECTOOLTRIM3</td><td>Yamaha F350</td></tr> <tr><td>RECTOOLTRIM2</td><td></td><td>Yamaha F425</td></tr> <tr><td>RECTOOLTRIM2</td><td></td><td>Yamaha 55-90 (2-Stroke)</td></tr> <tr><td>RECTOOLTRIM2</td><td>RECTOOLTRIM3</td><td>Yamaha 115-200 + VMAX</td></tr> <tr><td>RECTOOLTRIM1</td><td>RECTOOLTRIM1</td><td>Yamaha 225 (2-Stroke)</td></tr> <tr><td>RECTOOLTRIM2</td><td>RECTOOLTRIM3</td><td>Suzuki DF115 - DF300</td></tr> <tr><td>RECTOOLTRIM2</td><td>RECTOOLTRIM3</td><td>Evinrude 115 - 300 ETEC</td></tr> <tr><td>RECTOOLTRIM3</td><td>Johnson Evinrude</td><td>25 - 50 (2 Strokes)</td></tr> <tr><td>RECTOOLTRIM2</td><td>RECTOOLTRIM3</td><td>Johnson Evinrude 60 - 250 (2 Strokes)</td></tr> <tr><td>RECTOOLTRIM2</td><td>RECTOOLTRIM3</td><td>Honda 75 - 225</td></tr> <tr><td>RECTOOLTRIM1</td><td>Seastar Steering</td><td></td></tr> <tr><td>RECTOOLTRIM2</td><td>Volvo Penta Trim Cylinders</td><td></td></tr> <tr><td>RECTOOLTRIM1</td><td>Mercuriser Alpha One & Bravo Trim Cylinders</td><td></td></tr> </tbody> </table>			TRIM PISTON	TILT PISTON	HP	RECTOOLTRIM1	Yamaha	F25 - F40	RECTOOLTRIM2	RECTOOLTRIM3	Yamaha F115	RECTOOLTRIM2	RECTOOLTRIM3	Yamaha F150	RECTOOLTRIM2	RECTOOLTRIM1	Yamaha F150	RECTOOLTRIM2	RECTOOLTRIM3	Yamaha F175 - F200 (2.8L)	RECTOOLTRIM1	RECTOOLTRIM1	Yamaha F200 - F250 (3.3L)	RECTOOLTRIM1	RECTOOLTRIM1	Yamaha F225 - F300 (4.2L)	RECTOOLTRIM2	RECTOOLTRIM3	Yamaha F350	RECTOOLTRIM2		Yamaha F425	RECTOOLTRIM2		Yamaha 55-90 (2-Stroke)	RECTOOLTRIM2	RECTOOLTRIM3	Yamaha 115-200 + VMAX	RECTOOLTRIM1	RECTOOLTRIM1	Yamaha 225 (2-Stroke)	RECTOOLTRIM2	RECTOOLTRIM3	Suzuki DF115 - DF300	RECTOOLTRIM2	RECTOOLTRIM3	Evinrude 115 - 300 ETEC	RECTOOLTRIM3	Johnson Evinrude	25 - 50 (2 Strokes)	RECTOOLTRIM2	RECTOOLTRIM3	Johnson Evinrude 60 - 250 (2 Strokes)	RECTOOLTRIM2	RECTOOLTRIM3	Honda 75 - 225	RECTOOLTRIM1	Seastar Steering		RECTOOLTRIM2	Volvo Penta Trim Cylinders		RECTOOLTRIM1	Mercuriser Alpha One & Bravo Trim Cylinders			
TRIM PISTON	TILT PISTON	HP																																																																	
RECTOOLTRIM1	Yamaha	F25 - F40																																																																	
RECTOOLTRIM2	RECTOOLTRIM3	Yamaha F115																																																																	
RECTOOLTRIM2	RECTOOLTRIM3	Yamaha F150																																																																	
RECTOOLTRIM2	RECTOOLTRIM1	Yamaha F150																																																																	
RECTOOLTRIM2	RECTOOLTRIM3	Yamaha F175 - F200 (2.8L)																																																																	
RECTOOLTRIM1	RECTOOLTRIM1	Yamaha F200 - F250 (3.3L)																																																																	
RECTOOLTRIM1	RECTOOLTRIM1	Yamaha F225 - F300 (4.2L)																																																																	
RECTOOLTRIM2	RECTOOLTRIM3	Yamaha F350																																																																	
RECTOOLTRIM2		Yamaha F425																																																																	
RECTOOLTRIM2		Yamaha 55-90 (2-Stroke)																																																																	
RECTOOLTRIM2	RECTOOLTRIM3	Yamaha 115-200 + VMAX																																																																	
RECTOOLTRIM1	RECTOOLTRIM1	Yamaha 225 (2-Stroke)																																																																	
RECTOOLTRIM2	RECTOOLTRIM3	Suzuki DF115 - DF300																																																																	
RECTOOLTRIM2	RECTOOLTRIM3	Evinrude 115 - 300 ETEC																																																																	
RECTOOLTRIM3	Johnson Evinrude	25 - 50 (2 Strokes)																																																																	
RECTOOLTRIM2	RECTOOLTRIM3	Johnson Evinrude 60 - 250 (2 Strokes)																																																																	
RECTOOLTRIM2	RECTOOLTRIM3	Honda 75 - 225																																																																	
RECTOOLTRIM1	Seastar Steering																																																																		
RECTOOLTRIM2	Volvo Penta Trim Cylinders																																																																		
RECTOOLTRIM1	Mercuriser Alpha One & Bravo Trim Cylinders																																																																		

JUEGO DE LLAVES	MECHANICAL TOOL SET	CASSETTA ATTREZZI	MALETTE D'OUTILLAGE
154 llaves en métrico y en pulgadas para un completo trabajo en motores. Garantía de por vida.	154 pcs. Mechanics tool set in metric & inches. Lifetime warranty.	154 chiavi metriche e in pollici per un lavoro completo nel motore. Garantita a vita.	154 clés, métriques et en pouces pour un travail complet sur le moteur. Garantie à vie
REF			
CRA935154			

SOLUCIONES DE INSTALACIÓN • INTALATION SOLUTIONS • INTALAZIONE • SOLUZIONI INSTALLAZIONE • SOLUTIONS D'INSTALLATIONS





KIT LLAVE HÉLICE

PROP WRENCH KIT

KIT CHIAVE ELICHA

CLE POUR ECROU D'HELICE

REF	R.O. OEM		
REC91-859046Q4	91-821887T1	1 1/16"	75 - 300 HP



REF	R.O. OEM		
REC91-859046Q3	91-859046Q 3	15/16"	30, 40, 50 et 60 HP

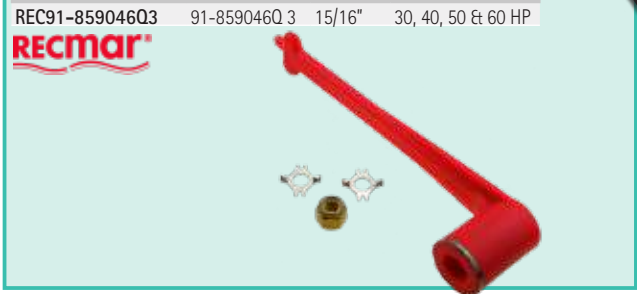



KIT ALARGADOR CABLE BUJIAS

EXTENSION WIRES

KIT PROLUNGA CAVI CANDELE

KIT EXTENSION DE FAISCEAU DE BOUGIE

REF		
REC5119902	18 cm	4
REC5119903	60 cm	4



REC5119902

REC5119903

PULIDORA DE CILINDROS

ENGINE CYLINDER HONE

PULITRICE CILINDRI

RODOIR DE CYLINDRE

Para pulir los cilindros de los bloques. Garantizada de por vida.

Quickly removes the glaze from engine cylinder walls before installing new piston rings. Lifetime warranty.

Per pulire i cilindri dei blocchi. Garantita a vita.

Poli les cylindres des blocs moteur. Garanti à vie.

REF
CRA904633



REF
CRA946331



VACUÓMETRO DOBLE FUNCION

PRESSURE / VACUUM TESTER

VACUOMETRO DOPPIA FUNZIONE

VACUOMÈTRE DOUBLE FONCTION

Presión y vacío. Ideal para comprobar las colas.

Combination unit that does pressure and vacuum testing in one units. Recommended to test drives.

Pressione e sottovuoto. Ideale per il controllo dei piedi.

Pression et vide. Idéal pour vérifier les embases.

REF
REC55134



COMPRESÍMETRO

Para motores gasolina con bases GM o Ford.

REF

CRA902171

COMPRESSION TESTER KIT

For gas engines with GM or Ford base.

MANOMETRO

Per motori benzina con base GM e Ford.

COMPRESSIONIÈTRE

Pour les moteurs à essence bases GM ou Ford.

**PISTOLA PUESTA A PUNTO**

Con regulador de avance 0-60.

REF

CRA921023

TIMING LIGHT

0-60 advance scale.

PISTOLA MESSA A PUNTO

Con regolatore avanzamento 0-60.

LAMPE STROBOSCOPIQUE

Avec régulateur d'avance 0-60.

**INTERRUPTOR ARRANQUE**

REF

CRA902175

REMOTE STARTER**INTERRUTTORE AVVIAMENTO****INTERRUPTEUR DE DÉMARRAGE A DISTANCE****TERMÓMETRO MULTIFUNCIONAL**

Termómetro multifunción digital, por rayos infrarrojos.
Emisividad fija: 0,95 Rango: -20°C + 320°C.
Lectura en grados centígrados y fahrenheit.
Precisión +/- 2%. Resolución: 1°C
Distancia óptima de medida: de 6 a 60 cm.
Retención de la última lectura.
Autoapagado.

REF

TECDT8580

INFRARED THERMOMETER

Multifunction digital infrared thermometer.
Fixed emissivity: 0.95 range: - 20 °C + 320 °C.
Reading in Celsius and Fahrenheit.
Precision +/- 2%. Resolution: 1°C
Distance optimal measurement: 6 to 60 cm.
Retention of the last reading.
Auto Off function.

TERMOMETRO MULTIFUNZIONALE

Termometro multifunzione digitale, a infrarrossi.
Misurazione: 0,95 Rango: -20°C + 320°C.
Lettura in gradi centigradi e fahrenheit.
Precisione +/- 2%. Risoluzione: 1°C
Distanza ottimale di misurazione: da 6 a 60 cm.
Memoria dell'ultima lettura.
Autospegnimento.

THERMOMÈTRE MULTIFONCTIONNEL

Thermomètre multifonction numérique, par rayons infrarouges.
Mesure fixe: 0,95 Plage: -20°C + 320°C.
Lecture en degrés Celsius et fahrenheit.
Précision +/- 2%. Résolution: 1°C
Distance de mesure optimale: de 6 à 60 cm.
Conservation de la dernière lecture.
Arrêt automatique



MULTITESTER DIGITAL DIGITAL MULTITESTER MULTITESTER DIGITALE MULTIMÈTRE DIGITAL

	RANGE	BEST ACCURACY
DC VOLTAGE (V)	V $\overline{\text{=}}$ 200mV ~ 1000V	\pm (0.5%+3)
AC VOLTAGE (V)	V \sim 2V ~ 700V	\pm (0.8%+5)
DC CURRENT (A)	A $\overline{\text{=}}$ 20 μ A ~ 10A	\pm (1.0%+3)
AC CURRENT (A)	A \sim 20mA ~ 10A	\pm (1.2%+5)
RESISTANCE (Ω)	Ω 200 Ω ~ 200M Ω	\pm (0.8%+3)
CAPACITOR (F)	$\overline{\text{ }}$ 2nF ~ 200 μ F	\pm (4.0%+5)
FREQUENCY (Hz)	Hz 200KHz	\pm (1.5%+10)
TEMPERATURE ($^{\circ}$ C)	$^{\circ}$ C -40 $^{\circ}$ C ~ 1832 $^{\circ}$ C	\pm (1.0%+3)
TEMPERATURE ($^{\circ}$ F)	$^{\circ}$ F -40 $^{\circ}$ C ~ 1832 $^{\circ}$ C	\pm (1.0%+3)

Display Count	1999	Power	9V (6F22*1)
Manual Range	✓	Product Color	Blue and Gray
Data Hold	✓	Product net weight	340 g
Diode measurement	✓	Product Size	190x80x33 mm
Transistor measurement	✓	Battery (not include)	
Auto Power OFF	✓	Standard Accessories	Test lead
Continuity Buzzer	✓		Temperature Probe
Mechanical protection	✓	Standard Individual Packing	Gift Box, Manual

REF
TEC145



VACUÓMETRO SINCRONIZADOR VACUUMMATE ALLWEATHER VACUOMETRO VACUOMETRE SYNCHRONISEUR

Vacuómetro, sincronizador de admisión, analizador dinámico de fugas y tacómetro. Impermeable e insumergible con una funda especial. Posee mayor estabilidad que los indicadores analógicos o que cualquier otro sistema. Se autorregula a los cambios de presión barométrica. Alimentación con corriente continua de 12 V, se puede utilizar con cualquier batería de embarcación o vehículo o con un adaptador de entrada a la red (230V/12V). Indicadores LED de batería descargada y de alimentación no adecuada. Contiene: Cable y pinzas por alimentación 12V, tubos de santoprene de conexión, 2 juegos de adaptadores flexi-rígidos, caja de almacenaje.

Vacuumate allweather, 4 x carb/throttle valve. Waterproof. Shock resistant composite-moulded polyurethane and polycarbonate casing for maximum strength and resilience. Self-calibrates for barometric changes. Solid state sensors are drop proof. It has internal rechargeable 1,5Ah 7,2V NiMH batteries providing up to 6 hours autonomy. Battery power is conserved by auto-switch-off 5 minutes after last being used and LEDs use full power only when measurements are taken. Kit includes custom travel case, battery cord-set, T-connector & 2 full sets of unique flexi-rigid.

Vacuometro, sincronizzatore d'aspirazione, analizzatore dinamico di fughe e tachimetro. Impermeabile e immergibile con una custodia speciale. Possiede maggiore sensibilità degli indicatori analogici o con altri sistemi. Si autoregola al cambio di pressione barometrica. Alimentazione con corrente continua da 12 V, si può utilizzare con qualsiasi batteria per imbarcazioni, veicoli e con un adattatore di entrata da 230V/12V. Indicatore LED di batteria scarica e di alimentazione non corretta. Contiene: Cavi e pinze per alimentazione 12V, tubi di santoprene di connessione, 2 adattatori flexi-rigidi, scatola per conservare l'attrezzo.

VacuumMate affiche la pression d'admission individuelle de 4 carburateurs séparés (ou boîtier papillons à injection de carburant). Imperméable et inmersible avec une housse spéciale. Il a une plus grande stabilité que les indicateurs analogiques ou tout autre système. Il autorégule les changements de pression barométrique. Alimentation 12 V DC, utilisable avec n'importe quelle batterie de bateau ou de véhicule ou avec un adaptateur secteur (230V/12V). Indicateurs LED de batterie déchargée et de puissance insuffisante. Contient: câble d'alimentation 12V et pinces, tubes de connexion, 2 jeux d'adaptateurs flexi-rigides, boîte de rangement.



REF
TCMVRM5

PINZA AMPERIMÉTRICA AMPERIC NIPPER PINZA AMPEROMETRICA PINCE AMPÈREMÉTRIQUE

Tenaza autorango y multifunción para AC y DC. Diámetro maxilar: 30 mm. Display de 3 3/4 dígitos. Máx. 3999. Realiza medidas en: AC/DC: 40A/400A. Precisión: +/- (1,9% + 5 d. en AC) Precisión: +/- (2,5% + 10 d. en DC) Ancho de banda: 50Hz - 500Hz (AC) Resolución: AC/DC 10mA. 100mV. Resistencia: 400 Ohms.

Iron autoranging and multifunction for AC and DC. Jaw diameter: 30 mm. Display of 3 3/4 digit. Max. 3999. Measurements in: AC/DC current: 40A/400A. Precision: +/- (1,9% + 5 d. en AC) Precision: +/- (2,5% + 10 d. en DC) Bandwidth: 50 Hz - 500 Hz (AC) Resolution: AC/DC 10mA. 100mV. Resistance: 400 Ohms.

Pinza multifunzione per AC e DC. Diametro max: 30 mm. Display da 3 3/4 digitale. Máx. 3999. Può realizzare misurazioni in: Corrente AC/DC: 40A/400A. Precisione: +/- (1,9% + 5 d. en AC) Precisione: +/- (2,5% + 10 d. en DC) Banda larga: 50Hz - 500Hz (AC) Risoluzione: AC/DC 10mA. 100mV. Resistenza: 400 Ohms.

Pince ampèremétrique multifonction pour AC et DC. Diamètre maxi: 30 mm. Affichage de 3 3/4 chiffres. Max. 3999. Effectue des mesures en: AC / DC: 40A / 400A. Précision: +/- (1,9% + 5 jours en CA) Précision: +/- (2,5% + 10 d. En DC) Bande passante: 50 Hz - 500 Hz (AC) Résolution: AC / DC 10mA. 100mV. Résistance: 400 Ohms.

REF
TEC218



ESTABILIZADORES, ELEVADORES Y SEGURIDAD

HYDROFOIL STABILIZER AND SECURITY

STABILIZZATORI, ASCENSORI E SICUREZZA

STABILISATEURS, POWER TRIM-LIFT ET SECURITE

ALETAS ESTABILIZADORAS

HYDROFOIL STABILIZER

ALETTE

HYDROFOIL

Aletas para acoplar a la placa de cavitación de los motores fueraborda y colas intra-fueraborda. Se obtiene el planeo en menor tiempo. Elimina la cavitación. Mejora la sustentación. Permite mayor estabilidad y ahorro de combustible.

Gives outboards and sterndrives a performance boost. Wipes out cavitation. On plane in less time. Saves fuel. Delivers true stabilization.

Alette da installare nei motori fuoribordo o nei piedi entro-fuoribordo. Planata in minor tempo. Elimina la cavitazione. Migliora la stabilità e riduce il consumo del carburante.

Hydrofoil à fixer sur la plaque de cavitation des moteurs hors-bord et les embases. Le déjaugage met moins de temps. Élimine la cavitation. Permet une plus grande stabilité et économie de carburant.



SRXPJR

SRXPI

Diseño de montaje SIN AGUJEROS.

NO-DRILL mounting design.

Montaggio senza fori.

Conception de montage SANS TROUS.

REF		
		(cm)
SRSF	40 HP - 300 HP	18,50





Diseño de montaje SIN AGUJEROS
Perfil hidrodinámico pulido
Empuje mejorado
Canalización del chorro de agua



NO-DRILL mounting design.
Sleeker hydrodynamic profile.
Captive Prop-Wash Resulting In
Improved Thrust
Fastest Hole Shot

Montaggio senza fori.
Profilo idrodinamico.
Spinta migliorata.
Canalizzazione del getto dell'acqua.

Conception de montage SANS TROUS
Profil hydrodynamique poli
Poussée améliorée
Canalisation par jet d'eau

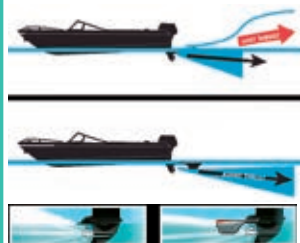
REF		
		(cm)
SRXRIIIJR.	2,5 HP - 75 HP	18,50
SRXRIII	75 HP +	18,50



REF		
		(cm)
SRPRO1	40 HP - 300 HP	19,55

POWER TRIM-LIFT

Soporte con kit de Power Trim y Tilt. Fabricado en extrusión de aluminio con tornillos de acero inox. El motor electro-hidráulico de 3500kg de empuje se encuentra dentro de un contenedor para una mayor protección.

Electric hydraulic Tilt & Trim with a rated thrust of 7800 lbs. Made with extruded aluminum and stainless steel fasteners.

Supporto con kit Power Trim e Tilt. Fabbriato in alluminio con viti in acciaio inox. Il motore elettroidraulico ha una spinta da 3500kg e si trova all'interno di un contenitore per una maggior protezione.

Prise en charge avec le kit Power Trim et Tilt. Fabriqué en aluminium extrudé avec des vis en acier inoxydable. Le moteur de poussée électro-hydraulique de 3500 kg est à l'intérieur d'un boîtier pour une protection supplémentaire.

				CMC13002Q	CMC13001Q
Fuerabordas	Outboards	Fuoribordo	Hors-bord	-130 HP	-130 HP
Recorrido Trim	Trim travel	Escursione Trim	Angle de Trim	20°	20°
Recorrido Tilt	Tilt travel	Escursione Tilt	Angle de Tilt	90°	90°
Alimentación	Operation	Alimentazione	Alimentation	12 V	12 V
Reloj indicador	Lift gauge	Indicatore trim	Indicateur de trim		✓
Separación del espejo	Set-Back from transom	Specchio di poppa	Recul de traverse	152 mm 6"	152 mm 6"



Soporte con kit de Power Trim y Tilt. Fabricado en extrusión de aluminio con tornillos de acero inox. El motor electro-hidráulico de 3500 kg de empuje se encuentra dentro de un contenedor para una mayor protección.

Electric hydraulic Tilt & Trim with a rated thrust of 7800 lbs. Made with extruded aluminum and stainless steel fasteners.

Supporto con kit Power Trim e Tilt. Fabbriato in alluminio con viti in acciaio inox. Il motore elettroidraulico ha una spinta di 3500kg e si trova all'interno di un contenitore per una maggior protezione.

Prise en charge avec le kit Power Trim et Tilt. Fabriqué aluminium extrudé avec des vis en acier inoxydable. Le moteur électro-hydraulique à une poussée de 3500 kg il est à l'intérieur d'un boîtier pour une protection supplémentaire.

				CMC52100D
Fuerabordas	Outboards	Fuoribordo	Hors-bord	-35 HP
Recorrido Trim	Trim Travel	Escursione Trim	Angle de Trim	84°
Alimentación	Operation	Alimentazione	Alimentation	12 V
Separación del espejo	Set-Back from transom	Specchio di poppa	Recul de traverse	140 mm 5 1/2"



ADAPTADORES. POWER TRIM-LIFT

Par de cuñas de 2º inclinación para espejo de popa.

BACK SPACERS. POWER TRIM-LIFT

Pair of 2 degrees wedge for the transom.

ADATTATORI. POWER TRIM-LIFT

Piastre per lo specchio di poppa inclinate di 2°

ADAPTATEURS. POWER TRIM-LIFT

Paire de cales avec 2ème inclinaison pour tableau arrière.

REF
CMC20122Q



Kit de adaptadores para la instalación de motores con palomillas.

Adaptors kit for motors mounted with transom clamps.

Kit per l'installazione di motori con chiusura con galletti.

Kit d'adaptateur pour l'installation du moteur.

REF
CMC13022Q



POWER LIFT

Soporte con kit elevador vertical. Fabricado en extrusión de aluminio con tornillos de acero inox. El motor electro-hidráulico de 3500 kg de empuje se encuentra dentro de un contenedor para una mayor protección. Tornillos de 3/4" de acero inoxidable, con tuercas de aleación de aluminio y bronce resistentes a los choques y corrosión.

Electric hydraulic power lift transom jack with a rated thrust of 7800 lbs. Made of 1/2" 6061 T6 alloy aluminum extrusions and stainless steel fasteners. Totally waterproof electro-hydraulic power lift transom jack with a rated thrust of 7800 lbs.

Supporto con kit elevatore verticale. Fabricato in alluminio con viti in acciaio inox. Il motore elettroidraulico ha una spinta da 3500kg e si trova all'interno di un contenitore per una maggior protezione. Viti da 3/4" in acciaio inox, con dadi in alluminio e bronzo resistenti alla corrosione.

Support avec kit de levage vertical. Fabriqué en aluminium extrudé avec des vis en acier inoxydable. Le moteur électro-hydraulique à poussée de 3500 kg est à l'intérieur d'un boîtier pour une protection supplémentaire. Vis 3/4" en acier inoxydable, avec écrous en alliage d'aluminium et de bronze résistant aux chocs et à la corrosion.

CMC65001Q				
Fuerabordas	Outboards	Fuoribordo	Hors-bord	V6
Recorrido vertical	Vertical travel	Lavoro verticale	Relevage vertical	125 mm / 5"
Alimentación	Operation	Alimentazione	Alimentation	12V
Dimensiones	Dimensions	Dimensioni	Les dimensions	460 x 420 mm 18 ^{1/8} " x 16 ^{1/2} "
Reloj indicador	Lift gauge	Indicatore trim	Indicateur de Trim	✓
Separación del espejo	Set-Back from transom	Specchio di poppa	Recul de traverse	140 mm / 5 ^{1/2} "



CMC61001Q				
Reloj indicador	Lift gauge	Indicatore trim	Indicateur de Trim	✓
Separación del espejo	Set-Back from transom	Specchio di poppa	Recul de traverse	254 mm / 10"



V-8 300 HP

CMC65501				
Fuerabordas	Outboards	Fuoribordo	Hors-bord	V8 300HP
Reloj indicador	Lift gauge	Indicatore trim	Indicateur de Trim	✓
Separación del espejo	Set-Back from transom	Specchio di poppa	Recul de traverse	140 mm 5-1/2"



Soporte con kit elevador vertical. Fabricado en extrusión de aluminio con tornillos de acero inox. de 3/4".

Electric hydraulic power lift transom jack. Made with extruded aluminum and stainless steel fasteners. Totally waterproof.

Supporto con kit elevatore verticale. Fabricato in alluminio con viti in acciaio inox da 3/4".

Support avec kit de levage vertical. Fabriqué en aluminium extrudé avec des vis en acier inoxydable. 3/4".

THAHJM-4DP				
Fuerabordas	Outboards	Fuoribordo	Hors-bord	75 HP
Recorrido vertical	Vertical travel	Lavoro verticale	Relevage vertical	127 mm / 5"
Alimentación	Operation	Alimentazione	Alimentation	12 V
Reloj indicador	Lift gauge	Indicatore trim	Indicateur de Trim	✓
Separación del espejo	Set-Back from transom	Specchio di poppa	Recul de traverse	37 x 30 cm 14 ^{5/8} " x 11 ^{1/2} "



ADAPTADORES. POWER LIFT

Kit de adaptadores para motores de 75 HP.

REF
THAHJM-CMADP



BACK SPACERS. POWER LIFT

Clampon motor adapter 75 HP.



ADATTATORI. POWER LIFT

Kit adattatori per motori 75 HP



ADAPTATEURS POWER LIFT

Kit adaptateur pour moteurs 75 CV.

ALARGO BARRA FUERABORDA

Prolongador de caña con pulsador de paro, para motores fueraborda. Fabricado en aluminio anodizado y maneta de plástico.

REF	(cm)	
GS73135	70	Fijo Fixed Fisso Fixe
GS73136	60 - 100	Telescópico Telescopic Telescopico Télescopique



EXTENSION HANDLE OUTBOARD

With push-button to switch-off the engine. Made of anodized aluminum and plastic handle.

PROLUNGA PER FUORIBORDO

Prolunga per fuoribordo, fabbricato in alluminio anodizzato e impugnatura in plastica.

RALLONGE DE BARRE FRANCHE POUR HB

Rallonge de barre franche avec bouton d'arrêt, pour moteurs hors-bord. Fabriqué en aluminium anodisé et poignée en plastique.



PROTECTOR DE HÉLICES

Mejora el control direccional y aumentando la eficiencia de la hélice. Fabricado en polipropileno de alto impacto.

NOTA: Todos los motores «Big Foot» y de arrastre requieren la medida superior. Velocidad Máx: 30 nudos

REF		Ø INT
REC5-9.8	5 - 9 HP	9"
REC9.9-20	9.9 - 20 HP	9"
REC25-35	25 - 35 HP	11"
REC40-65	40 - 65 HP	13"
REC70-100	70 - 100 HP	14"
REC110-230	110 - 230 HP	16"



PROPELLER PROTECTOR

Manufactured in high impact polypropylene. Better control in directional force. Increase the propeller efficiency. NOTE: All hp's with «Big Foot» and High Thrust applications require next size up. Max. Speed: 30 knots

PROTETTORI ELICHE

Migliora il controllo direzionale e aumentando l'efficienza delle eliche. Prodotto in polipropilene di alta qualità. NOTA: Tutti i motori «Big Foot» a alta spinta richiedono la referenza superiore. Velocità Mas.: 30 nodi

PROTECTION D'HÉLICE

Améliore le contrôle directionnel et augmente l'efficacité de l'hélice. Fabriqué en polypropylène résistant aux chocs. REMARQUE: Tous les moteurs "Big Foot" et à forte poussée nécessitent la taille supérieure. Vitesse maximale: 30 nœuds



ARNÉS FUERABORDA

Confeccionado con cincha sintética. Una sola medida se ajusta para fuerabordas de 2 a 15 HP.

REF
GS73069



HOISTING HARNESS

Outboard hoisting harness. One size works on virtually all 2 to 15 HP outboards.

IMBRAGATURA FUORIBORDO

Confezionato con cinghia sintetica. Una sola misura, si regola per i fuoribordo da 2 a 15 HP.

HARNAIS HORS-BORD

Fabriqué dans une sangle synthétique. Une seule taille à ajustée pour les moteurs hors-bord de 2 à 15 CV.

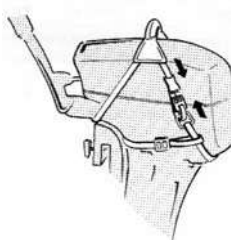

ANTI-ROBO

Para motores fueraborda. Fabricado en acero inox. de 3 mm con candado de latón con 2 llaves.

ANTI THEFT

Manufactured in 3 mm stainless steel pipe. Provided with a padlock in brass with 2 keys.

ANTI-FURTO

Per motori fuoribordo. Prodotto in acciaio inox da 3 mm con lucchetto in ottone con 2 chiavi.

ANTIVOL

Pour les moteurs hors-bord. Fabriqué en acier inoxydable, 3 mm avec serrure en laiton livré avec 2 clés.

REF	
GS73138	240 mm
GS73139	320 mm



FUNDAS PARA FUERABORDA

Para motores fueraborda de 2 y 4 tiempos. Confeccionadas en tejido de poliéster de 320 g/m². Impermeabilizado, transpirable. Costuras reforzadas. Color gris claro.

OUTBOARD COVERS

For outboard engines 2 & 4 stroke. Manufactured in 320 gsm polyester canvas. Weather proof, breathable. Reinforced top stitched seams. Grey color.

COPERTURA FUORIBORDO

Per motori fuoribordo di 2 e 4 tempi. Confezionato in tessuto di poliester e da 320 g/m². Impermeabile, traspirante. Cuciture rinforzate. Colore grigio chiaro.

HOUSES POUR HORS-BORD

Pour moteurs hors-bord 2 et 4 temps. Fabriqué en tissu polyester 320g/m². Imperméable, respirant. Coutures renforcées. Couleur gris clair.

REF		A	B	C
OCEMA0741	-15 hp	32 cm	27 cm	50 cm
OCEMA0742	15-30 hp	40 cm	30 cm	56 cm
OCEMA0743	30-60 hp	49 cm	36 cm	62 cm
OCEMA0744	60-100 hp	53 cm	40 cm	68 cm
OCEMA0745	100-150 hp	58 cm	46 cm	74 cm
OCEMA0746	175-250 hp	60 cm	50 cm	82 cm

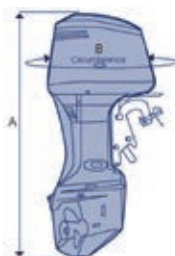

REF		A	B
OCEMA0751	- 6 hp	98 cm	126 cm
OCEMA0752	8 - 15 hp	110 cm	140 cm
OCEMA0753	15 - 20 hp	125 cm	150 cm
OCEMA0754	20 - 30 hp	137 cm	165 cm
OCEMA0755	30 - 60 hp	144 cm	180 cm
OCEMA0756	60 - 100 hp	170 cm	200 cm
OCEMA0757	115 - 150 hp	190 cm	226 cm
OCEMA0758	175 - 250 hp	197 cm	248 cm

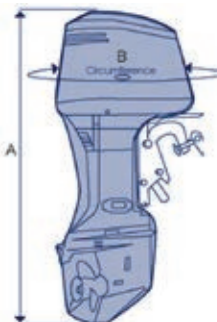

MERCURY

		2T STROKES	4T STROKES
OCEM000S	2018+	V8 4.6L 250HP, 300HP Et 200 - 300PRO XS	✓
OCEM00S	2005+	VERADO 6CYL 2.6L 200 TO 400HP	✓
OCEM05S	2005+	VERADO 4CYL 1.7L 135HP, 150HP, 175HP, 200HP	✓
OCEM10S	2011+	4CYL 3.0L 135HP, 150HP	✓
OCEM15S	2014+	4CYL 2.1L 75HP, 80HP, 90HP, 100HP 115HP	✓
OCEM20S	2008+	4CYL 995CC 40HP, 50HP, 60HP	✓
OCEM25S	2008+	3CYL 747CC 40HP	✓
OCEM30S	2007+	3CYL 526CC 25HP, 30HP	✓
OCEM35S	2018+	2CYL 333CC 15HP, 20HP	✓
OCEM40S	2006+	2CYL 209CC 8HP, 9.9HP	✓
OCEM45S	2012+	1CYL 123CC 4HP, 5HP, 6HP	✓
OCEM50S	2007+	1CYL 85CC 2.5HP, 3.5HP	✓



GUÍA MANTENIMIENTO COLAS Y Y KITS	68	SENSORES	109	PARTES DEL MOTOR	203
SISTEMA ALIMENTACIÓN Y FILTRACIÓN	74	GUÍA SENSORES EFI	113	BOMBA DE ACEITE 4 TIEMPOS	241
ACEITE Y GUÍA	83	SENSOR AGUA EN COMBUSTIBLE	111	BOMBAS Y JUNTAS	241
ACELERADOR - CABLE	107	SENSOR ÁRBOL DE LEVAS	112	CIGÜEÑAL 4 TIEMPOS	241
ALTERNADOR	136	SENSOR CAUDAL DEL AGUA	111	GUÍA CIGÜEÑAL COMPLETO	241
CORREA	137	SENSOR DE PICADO	113	COJINETES	242
BOMBA DE COMBUSTIBLE EN LÍNEA	71	SENSOR IAC	112	CIGÜEÑAL 2 TIEMPOS	263
ABRAZADERA PARA MANGUERA	72	SENSOR IAT	112	AGUJA DE COJINETE	266
ADAPTADOR LÍNEA DE COMBUSTIBLE	72	SENSOR MAT/MAP	109	AROS TÓRICOS	263
BOMBA	71	SENSOR POSICIÓN CIGÜEÑAL	112	COJIENTE DE BIELA	267
LÍNEA DE COMBUSTIBLE	71	SENSOR PRESIÓN DE ACEITE	111	COJINETES	263
MANGUERA	72	SENSOR PRESIÓN DE AGUA	111	GUÍA CIGÜEÑAL COMPLETO	264
MUELLE TUBO COMBUSTIBLE	72	SENSOR TEMPERATURA DEL AGUA	110	GUÍA RODAMIENTOS	266
BOMBA DE COMBUSTIBLE	84	SENSOR TPS	109	RETENES	263
BOMBA DE COMBUSTIBLE - KIT	90	SOLENOIDE RELÉ	132	DESPIECE MOTOR DE 4 TIEMPOS	203
BOMBA DE COMBUSTIBLE ALTA PRESIÓN	87	GUÍA	134	2, 2.5, 3.5 HP	203
BOMBA DE COMBUSTIBLE BAJA PRESIÓN	86	RELÉ	132	4, 5, 6 HP	204
BOMBA DE COMBUSTIBLE ELÉCTRICA	85	RELÉ DE ARRANQUE	132	8, 9.9 HP	205-206-208-210
BOMBA DE COMBUSTIBLE MECÁNICA	84	RELÉ DE TRIM	132	13.5, 15 HP	208-210
GUÍA BOMBA DE COMBUSTIBLE	92	STARTOR	144	10, 15, 20 HP	212
GUÍA BOMBA MECÁNICA	85	GUÍA CAJA NEGRA, STARTOR, TRIGGER, REGULADOR	147	25 HP	214-216
MEMBRANAS Y JUNTAS	89	GUÍA STARTOR EFI	146	30, 40 HP	218-220-222
REGULADORES PRESIÓN COMBUSTIBLE	97	TRIGGER	142	50, 60 HP	222
VST - GUÍA	87	TRIM, TILT & POWER TRIM	151	75, 80, 90, 110, 115 HP	224-226
VST - JUNTAS	97	INSTALACIÓN ELÉCTRICA	151	135, 150 HP	227-228
VST ALTA PRESIÓN - KIT	96	POWER TRIM COMPLETO	153	175 HP	228
CARBURADOR	100	TRIM - KIT REPARACIÓN	153	200, 225, 250, 275, 300 HP	230
AGUJA	105	TRIM - LATIGUILLOS	151	225 EFI V6	232
AGUJA - KIT	104	TRIM - SENSOR	153	DESPIECE MOTOR DE 2 TIEMPOS	243
BOYAS	105	VÁLVULA DE ALIVIO	151	MARINER 4A	243
CARBURADOR COMPLETO	100	SISTEMA DE GOBIERNO	155	4, 5, 6, 8, 9.8 HP	244
CARBURADOR- KITS	100	INTERRUPTORES PARA MANDOS	159	MARINER 6, 8 HP	245
GUÍA KITS DE CARBURADORES	103	INTERRUPTOR MANDO	159	8K, W8	246
JUNTAS FILTRO CARBURADOR	107	INTERRUPTOR TRIM	159	9.9, 15, 18, 25, 30 HP	248
PASADOR DE BOYA	107	ZUMBADOR ACÚSTICO ALARMA	159	40, 45, 50, 55, 60 HP	249
TORNILLOS	105	MANDOS DE CONTROL	155	40K W40	250
COMPONENTES TANQUE Y CONECTORES	73	ADAPTADORES DE CABLES MORSE	160	65 JET, 70, 75, 80, 90 HP	252
CONECTOR DE DEPÓSITO	73	CABLES DE DIRECCIÓN	160	75, 90 HP, 65 JET	253
PASAMAMPAROS	73	MANDO LATERAL	155	CORREAS DE DISTRIBUCIÓN	272
FILTRO DE ACEITE	80	MANDO PARA CONSOLA	158	CORREAS	272
GUÍA FILTRACIÓN EFI	81	SILENBLOCK	158	GUÍA	273
GUÍA FILTROS DE ACEITE	80	SISTEMA DE REFRIGERACIÓN	161	JUNTAS DE MOTOR 4 TIEMPOS	234
TAPÓN DEL CARTER	81	ÁNODOS	197	AROS TÓRICOS CULATA	238
FILTRO DE COMBUSTIBLE Y ELEMENTOS	74	ÁNODO CANADA METAL	197	BASE DE MOTOR	236
BRACKET	74	ÁNODO RECMAR	199	CULATA	234
FILTRO COMBUSTIBLE - EN LÍNEA	77	ÁNODO TECNOSEAL	200	CULATA - KIT	235
FILTRO COMBUSTIBLE - SEPARADOR AGUA	74	BOMBA DE AGUA	178	GUÍA	237
FILTRO DECANTADOR, VASO TRANSPARENTE	75	BASE	178	GUÍA JUNTAS EFI	239
FILTRO PARA CARBURADOR	79	BASE - KIT	179	RETENES DE ACEITE	238
VST - FILTRO	79	CASQUILLO	181	RETENES TAPA DE CULATA	239
LLAVES PARA FILTRO	76	CUERPO	179	JUNTAS DE MOTOR 2 TIEMPOS	254
RAÇOR DE LATÓN	76	CUERPO - KIT	180	CULATA	254
VÁLVULA	76	GUÍA BOMBAS DE AGUA	191	CULATA - KIT	255
FILTRO DE AIRE	79	GUÍA BOMBAS Y RETENES	188	BASE DE MOTOR	258
INYECTORES	98	JUNTAS DE LA BOMBA	182	GUÍA	260
GUÍA	99	KIT DE REPARACIÓN	184	RETENES TAPA DE CULATA	261
INYECTOR	98	TAPA	180	CULATÍN	262
PLATINOS Y CONDENSADORES	154	GUÍA DE IMPULSORES	171	PISTONES 4 TIEMPOS	242
CONDENSADORES Y PLATINOS	154	KITS DE RETENES Y JUNTAS	174	GUÍA CIGÜEÑAL, BIELAS Y PISTÓN	242
JUNTAS DISTRIBUIDOR	154	GUÍA KITS DE RETENES	176	KITS DE PISTONES	242
KITS	154	GUÍA RETENES	176	PISTONES 2 TIEMPOS	268
SEPARADOR DE VAPOR	108	LÍQUIDO INHIBIDOR DE LA CORROSIÓN	161	GUÍA DE BIELAS, CIGÜEÑAL Y PISTÓN	270
SISTEMA ELÉCTRICO	102	TERMOSTATO	162	GUÍA PISTÓN EUROPA	271
BOBINAS	116	ARANDELA	169	GUÍA PISTÓN USA	270
BOBINA DE CARGA	116	CONECTOR CULATA	168	PISTÓN - AROS ESTANDAR	272
BOBINA DE EXCITACIÓN	119	DEFLECTOR	168	PISTÓN - KIT	268
BOBINA DE IGNICIÓN	116	DESPLAZABLE	169	SISTEMA ESCAPE Y ADMISIÓN	274
GUÍA	119	DIAFRAGMA	168	SISTEMA DE ADMISIÓN	278
MÓDULO CMD	119	GRUPO	168	JUNTAS	278
BUJÍAS	121	GUÍA	164	SISTEMA DE ESCAPE	274
JUEGOS DE CABLES ALTO RENDIMIENTO	125	GUÍA EFI	164	JUNTAS	274
PIPA	125	JUNTAS TAPA DE REFRIGERACIÓN	169	JUNTAS DE CARTER	277
CDI Y CAJAS NEGRAS	140	NIPLE	169	JUNTAS DE COLECTOR DE ESCAPE	277
DESCONECTORES DE SEGURIDAD	150	RESORTE	168	UNIDADES DE TRANSMISIÓN	281
LLAVES DE ARRANQUE	131	RETÉN	168	COLA COMPLETA	281
LLAVE CON CHOQUE	131	TAPA	168	HERRAMIENTAS DE COLA	283
MÓDULOS Y LIMITADORES	149	TERMOSTATO	162	EXTRACTOR DE COJINETES Y HÉLICES	283
LIMITADOR RPM	149	TERMOSTATO - CUBIERTA	165	EXTRACTOR DE PÍNONES	284
MÓDULO ALARMA ACEITE	149	TERMOSTATO - JUNTAS	166	HERRAMIENTAS VOLANTE DE MOTOR	286
MOTORES DE ARRANQUE	126	TERMOSTATO - KIT JUNTAS	166	KIT HERRAMIENTAS	284
MUELLE DE ARRANQUE	130	TORNILLO PARA TODAS LAS VÁLVULAS	168	KIT LLAVE HÉLICE	284
REGULADORES Y RECTIFICADORES	138	VÁLVULA ANTIPRESIÓN	167		
GUÍA REGULADORES	139				

MERCURY

LLAVE CABLE CAMBIO	284	3.9 HP	317	EJE TRASMISIÓN	344
LLAVE ESTRIADO EJE	285	4 HP	288-317-318	KITS DE PIÑONES - GUÍA	338
LLAVE GALGADO PIÑONES	285	4.5 HP	317	MUELLE	346
LLAVE TUERCA DIÁBOLO	285	5 HP	317	PASADOR	344
LLAVE TUERCA EJE VERTICAL	285	6 HP	288-318	PIÑONES - GUÍA	339
LLAVE TUERCA VARILLA DEL CAMBIO	284	7.5 HP	288-290-292-320	PIÑONES ATAQUE	341
PISTOLA DE ACEITE	286	8 HP	317	PIÑONES MARCHA ATRÁS	341
VACUOMETRO DOBLE FUNCIÓN	286	9.8 HP	290-292-320-321	PIÑONES MARCHA AVANTE	341
DESPIECE COLAS 4 TIEMPOS	287	9.9 HP	292-322	RETÉN GOMA	345
2, 2.5, 3.5 HP	287	13.5 HP	292	SELECTORES	342
4, 5, 6 HP	288	15 HP	292-322	SUPLEMENTOS	346
8 HP	290-292-294-296	18 HP	294	TORNILLO	346
		20 HP	294-324	TORNILLO DRENAJE	345
9.9 HP	290-292-294-296-298	25 HP	294-300-324	TUBO DE AGUA	347
10 HP	296-298	30 HP	304-324-326	TUERCA DE PIÑÓN	341
13.5 HP	292-294	40 HP	328-330	SISTEMA DE PROPULSIÓN	348
15 HP	292-294-296-298	50 HP	300-302	HÉLICES AL E INOX DE 3 Y 4 PALAS	348
20 HP	296-298	55 HP	302	GUÍA HÉLICES CON NÚCLEO INTEGRADO	349
25, 30 HP EFI	299	60 HP	302-332	HÉLICES PARA NÚCLEO INTERCAMBIABLE	351
25 HP	300	70 HP	326	NÚCLEO INTERCAMBIABLE	350
30 HP	300-302-304	125 HP	304	PIEZAS DE HÉLICE	352
40, 45, 50 HP	300-302	V6	334	ARANDELA	352
135 HP	306	225 HP CARB., 225 EFI/DFI, 250 EFI/DFI	336	CIERRE HÉLICE	353
150 HP	304	PIEZAS TRANSMISIÓN	338	ESPACIADOR	353
175, 200, 225 HP	308	ACOPLE CAMBIO	344	GUÍA RECAMBIO DE HÉLICE	354
225 EFI	310	ACOPLE GOMA	344	KIT CIERRE HÉLICE	354
300 HP	306	ARANDELA	347	PASADOR	353
DESPIECE COLAS 2 TIEMPOS	314	CASQUILLO	345	TOPE CIERRE HÉLICE	354
2 HP	287-314-316-320	CHAVETA	346	TOPE HÉLICE	352
2.5 HP	287-316	EJE CAMBIO	346	TUERCA HÉLICE	352
3.5 HP	287	EJE HÉLICE	344	REF --> RO	355
				RO --> REF	368

EN

MAINTENANCE GUIDE & KITS	68	FUEL PUMP	71	ELECTRIC SYSTEM	109
FUEL & FILTRATION SYSTEM	71	FUEL PUMP IN LINE	71	COIL	116
ACCELERATOR - THROTTLE CABLE	107	HOSE	72	CHARGE COIL	116
AIR FILTER	79	SPRING	72	CMD MODULE	119
ALTERNATOR	136	FUEL PUMP	84	EXCITER COIL	119
BELT	137	DIAPHRAGMS & GASKETS	89	GUIDE	119
CARBURETOR	100	FUEL PUMP - ELECTRIC	85	IGNITION COIL	116
BOLT SCREW	105	FUEL PUMP - MECHANICAL	84	CUT OFF SWITCHES	150
CARBURETOR FILTER - GASKET	107	FUEL PUMP - GUIDE	92	CDI & POWER PACK	140
CARBURETOR KIT - GUIDE	103	FUEL PUMP - HIGH PRESSURE	87	IGNITION STARTER SWITCH	131
CARBURETOR- KIT	100	FUEL PUMP - KIT	90	PUSH T. CHOCKE	131
FLOAT - PIN	107	FUEL PUMP - LOW PRESSURE	86	MODULES & LIMITATORS	149
FLOATS	105	FUEL PUMP, MECHANICAL - GUIDE	85	OIL WARNING MODULE	149
FULL CARBURETOR	100	REGULATOR FUEL PRESSURE	97	RPM LIMITER	149
NEEDLE VALVE	105	VST - GUIDE	87	REGULATOR & RECTIFIER	138
NEEDLE VALVE - KIT	104	VST - GASKET	97	REGULATOR GUIDE	139
FUEL & FILTRATION SYSTEM	71	VST HIGH PRESSURE - KIT	96	SENSORS	109
FUEL FILTER & ELEMENTS	74	FUEL TANK COMPONENTS	73	CAMSHAFT POSITION	112
BRACKET	74	TANK CONNECTOR	73	EFI SENSORS GUIDE	113
CARBURETOR	79	THRU HULL	73	IAC	112
CHECK VALVE	76	INJECTOR	98	IAT	112
COMPLET WITH TRANSPARENT BOWL	75	GUIDE	99	KNOCK	113
FILTER KAY	76	INJECTOR	98	MAT/MAP	109
IN-LINE FUEL FILTER	77	OIL FILTER	80	OIL PRESSURE	111
RACORD IN BRASS	76	EFI FILTRATION APPLICATION	81	POSITION CRANCKSHAFT	112
VST - FILTER	79	OIL FILTER - GUIDE	80	TPS	109
WATER SEPARATING	74	OIL PAN CAP	81	WATER FLOW	111
FUEL PUMP IN LINE	71	POINTS & CONDENSERS	154	WATER PRESSURE	111
CLAMP SMALL	72	POINTS & CONDENSERS	154	WATER TEMPERATURE	110
COUPLE	72	DISTRIBUTOR GASKET	154	WATER-IN-FUEL	111
		KITS	154		
		VAPOR SEPARATOR	108		

MERCURY

RECAMBIOS MARINOS

SOLENOID RELAY	132	ENGINE GASKET 4 STROKES	234	GEAR CASE PARTS - 2 STROKES	314
GUIDE	134	CYLINDER GASKET	236	2 HP	287-314-316-320
RELAY	132	CYLINDER HEAD - O-RING	238	2.5 HP	287-316
STARTER	132	CYLINDER HEAD GASKET	234	3.5 HP	287
TRIM	132	CYLINDER HEAD GASKET KIT	235	3.9 HP	317
SPARK PLUG	121	EFI GASKET - GUIDE	239	4 HP	288-317-318
HD SPARK PLUG WIRE SET	125	GASKET CYLINDER SEALS	239	4.5 HP	317
SPARK PLUG PIPE	125	GUIDE	237	5 HP	288-318
STARTER	126	OIL SEAL	238	6 HP	288-290-292-320
STARTER SPRING	130	ENGINE GASKET 2 STROKES	254	7.5 HP	317
STARTOR	144	CYLINDER HEAD	254	8 HP	290-292-320-321
EFI GUIDE	146	CYLINDER HEAD GASKET KIT	255	9.8 HP	290-317
GUIDE	147	CYLINDER GASKET	258	9.9 HP	292-322
TRIGGER	142	GUIDE	260	13.5 HP	292
TRIM, TILT & POWER TRIM	151	GASKET CYLINDER SEALS	261	15 HP	292-322
MANUAL RELEASE VALVE	151	HEAD COVER - GASKET	262	18 HP	294
POWER TRIM ASSEMBLY	153	ENGINE PARTS, 4 STROKE	203	20 HP	294-324
TRIM - HOSES	151	2, 2.5, 3.5 HP	203	25 HP	294-300-324
TRIM - REPAIR KIT	153	4, 5, 6 HP	204	30 HP	304-324-326
TRIM - SENSOR	153	8, 9.9 HP	205-206-208-210	40 HP	328-330
WIRING HARNESS	151	13.5, 15 HP	208-210	50 HP	300-302
STEERING SYSTEM	155	10, 15, 20 HP	212	55 HP	302
ENGINE CONTROL	155	25 HP	214-216	60 HP	302-332
CABLES ADAPTERS	160	30, 40 HP	218-220-222	70 HP	326
CONSOLE CONTROL	158	50, 60 HP	222	125 HP	304
SIDE CONTROL	155	75, 80, 90, 110, 115 HP	224-226	V6	334
STEERING CABLE	160	135, 150 HP	227-228	225 HP CARB, 225 EFI/DFI, 250 EFI/DFI	336
SILENBLOCK	158	175 HP	228	STERN DRIVE PARTS	338
SWITCH & CABLES	159	200, 225, 250, 275, 300 HP	230	CLUTCH DOGS	342
ALARM ASSY	159	225 EFI V6	232	CLUTCH DOGS - GUIDE	342
CONTROL SWITCH	159	ENGINE PARTS, 2 STROKE	243	COUPLING ASSEMBLY	345
TRIM SWITCH	159	MARINER 4A	243	CROSS PIN	344
COOLING SYSTEM	161	4, 5, 6, 8, 9.8 HP	244	DRAIN SCREW	345
ANODES	197	MARINER 6, 8 HP	245	DRIVE SHAFT	344
CANADA METAL ANODE	197	8K, W8	246	FACE SEAL	345
RECMAR ANODE	199	9.9, 15, 18, 25, 30 HP	248	GEAR GUIDE	339
TECNOSEAL ANODE	200	40, 45, 50, 55, 60 HP	249	GEAR SET GUIDE	338
IMPELLER GUIDE	171	40K W40	250	GROMMET	344
SEAL KIT	174	65 JET, 70, 75, 80, 90 HP	252	INITIATIVE GEAR	341
SEAL APPLICATION	176	75, 90 HP, 65 JET	253	KEY	346
SEAL KIT - GUIDE	176	OIL PUMP, 4 STROKES	241	PINION NUT	341
SALT OFF	161	OIL PUMP & GASKET	241	POSITIVE GEAR	341
THERMOSTAT	162	PISTONS 4 STROKES	242	PROP SHAFT	344
CARRIER	169	GUIDE, CONNECTING ROD, CRANK-SHAFT & PISTON	242	REVERSE GEAR	341
CUP	168	PISTON KIT	242	SCREW	346
DEFLECTOR	168	PISTONS 2 STROKES	268	SHIFT BUSHING	344
DIAPHRAGM	168	GUIDE, CONNECTING ROD, CRANK-SHAFT & PISTON	270	SHIFT POOL	346
EFI GUIDE	164	PISTON - KIT	268	SHIMS	346
FITTING	168	PISTON - RINGS	272	SPRING	346
GASKET, EXHAUST INNER COVER	169	PISTON GUIDE - EUROPE	271	WASHER	347
GROMMET	168	PISTON GUIDE - USA	270	WATER HOSE	347
NIPPLE	169	TIMMING BELT	272	TOOLS	283
SCREW FOR ALL POPPET	168	BELT	272	BEARING CARRIER RETAINER WRENCH	285
SEAL	168	GUIDE	273	BOTTLE GEARCASE PUMP	286
SPRING	168	EXHAUST & INTAKE SYSTEM	274	FLYWHEEL PULLER	286
THERMOSTAT	162	EXHAUST SYSTEM	274	GEARCASE TOOL KIT	284
THERMOSTAT - GASKET KIT	166	GASKET	274	PINION GEAR SHIMMING TOOL	285
THERMOSTAT - COVER	165	OIL PAN, GASKET	277	PINION NUT ADAPTOR KIT	285
THERMOSTAT - GASKET	166	MANIFOLD, GASKET	277	PRESSURE / VACUUM TESTER	286
THERMOSTAT - GUIDE	164	INTAKE SYSTEM	278	PROP AND BEARING PULLER	283
THERMOSTAT, PRESSURE VALVE	167	GASKET	278	PROP SHAFT ADAPTOR	285
WASHER	169	UNIT DRIVES & COMPONENTS	281	PROP WRENCH KIT	284
WATER PUMP	178	GEAR CASE ASSY	281	SHIFT CABLE TOOL	284
BASE	178	GEAR CASE PARTS - 4 STROKES	287	SHIFT SHAFT BUSHING TOOL	284
BASE - KIT	179	2, 2.5, 3.5 HP	287	UNIVERSAL PULLER PLATE	284
GASKETS	182	4, 5, 6 HP	288	POPULSION SYSTEM	348
GUIDE	191	8 HP	290-292-294-296	3 & 4 BLADE AL & SS PROPELLERS	348
GUIDE, WATER PUMP AND SEALS	188	9.9 HP	290-292-294-298	INTERCHANGEABLE HUB	350
HOUSING	179	10 HP	296-298	PROPELLERS APPLICATION WITH RUBBER HUB	349
HOUSING - KIT	180	13.5 HP	292-294	PROPELLERS FOR INTERCHANGEABLE HUB	351
PLATE	180	15 HP	292-294-296-298	PROP SPARE PARTS	352
REPAIR KIT	184	20 HP	296-298	PIN	353
SLINGER	181	25, 30 HP EFI	299	PROP NUT	352
ENGINE PARTS	203	25 HP	300	PROP NUT KIT	354
CRANKSHAFT 4 STROKES	241	30 HP	300-302-304	PROPELLERS SPARE PARTS GUIDE	354
BEARING	242	40, 45, 50 HP	300-302	SPACER	353
CRANKSHAFT GUIDE	241	135 HP	306	TAB WAHER RECEIVER	354
CRANKSHAFT 2 STROKES	263	150 HP	304	TAB WASHER	353
BEARING	263	175, 200, 225 HP	308	THRUST HUB	352
CONNECTING ROD, BEARING	267	225 EFI	310	THRUST WASHER	353
CRANKSHAFT GUIDE	264	300 HP	306	WASHER	352
ENGINE BEARING, GUIDE	266			REF --> RO	355
NEEDLE BEARING	266			RO --> REF	368
O-RINGS	263				
OIL SEAL	263				

GUIDA MANUTENZIONE E KIT	68	REGOLATORI E RADDRIZATORI	138	TERMOSTATO – GUARNIZIONE	166
SISTEMA DI ALIMENTAZIONE E FILTRAZIONE	71	GUIDE	139	TERMOSTATO – KIT GUARNIZIONE	166
ACCELERATORE – CAVO	107	SENSORE	109	VALVOLA ANTI-PRESSIONE	167
ALTERNATORE	136	GUIDA SENSORI EFI	113	VITE PER TUTTE LE VALVOLE	168
CINGHIE	137	SENSORE ACQUA IN COMBUSTIBILE	111	PARTI MOTORE	203
CARBURATORE	100	SENSORE ALBERO A CAMME	112	ALBERO MOTORE 4 TEMPI	241
CARBURATORE – KIT	100	SENSORE ANTIDETONAZIONE	113	CUSCINETTO	242
CARBURATORI COMPLETO	100	SENSORE FLUSSO ACQUA	111	GUIDA ALBERO MOTORE COMPLETO	241
GALLEGGIANTE	105	SENSORE IAC	112	ALBERO MOTORE 2 TEMPI	263
GUARNIZIONE FILTRO CARBURATORE	107	SENSORE IAT	112	AGHIL CUSCINETTO	266
GUIDA – KIT	103	SENSORE MAT/MAP	109	CUSCINETTO	263
SPILLO CONICO	105	SENSORE POSIZIONE ALBERO	112	CUSCINETTO BIELLA	267
SPILLO CONICO – KIT	104	SENSORE PRESSIONE ACQUA	111	GUIDA CUSCINETTO	266
SPINOTTO GALLEGGIANTE	107	SENSORE PRESSIONE DELL'OLIO	110	GUIDA CUSCINETTO, TENUTE E FASCE	264
VITE	105	SENSORE TEMPERATURA ACQUA	110	O-RING	263
COMPONENTI SERBATOIO E CONETTORI	73	SENSORE TPS	109	PARAOLIO	263
ATTACCO SERBATOIO	73	SOLENOIDE RELE	132	CINGHIE DISTRIBUZIONE	272
PASSASCAFO	73	AVVIAMENTO	132	CINGHIE	272
FILTRO ARIA	79	GUIDA	134	GUIDA	273
FILTRI BENZINA E RACCORDI	74	RELE	132	GUARNIZIONI PER MOTORE 4 TEMPI	234
CHIAVE DA FILTRO	76	TRIM	132	GUARNIZIONE BASE MOTORE	236
FILTRO BENZINA PER MONTARE IN LINEA	77	STARTOR	144	GUARNIZIONE TESTATA	234
FILTRO CARBURATORI	79	GUIDA	147	GUARNIZIONE TESTATA – KIT	235
FILTRO DI DECANTAZIONE BENZINA COMPLETO CON VASCHETTA TRASPARENTE	75	GUIDA EFI	146	GUIDA	237
FILTRO SEPARATORE ACQUA-BENZINA	74	TRIGGER	142	GUIDA GUARNIZIONE EFI	239
FILTRO VST	79	TRIM, TILT & POWER TRIM	151	O-RINGS TESTATA	238
RACCORDO IN OTTONE	76	INSTALLAZIONE ELETTRICA	151	PARAOLIO	238
SUPPORTO	74	POWER TRIM COMPLETO	153	PARAOLIO COPERCHIO TESTATA	239
VALVOLA	76	TRIM – KIT RIPARAZIONE	153	GUARNIZIONI PER MOTORE 2 TEMPI	254
FILTRO OLIO	80	TRIM – TUBO	151	GUARNIZIONE BASE MOTORE	258
GUIDA FILTRO OLIO	80	TRIM – SENSORE	153	GUARNIZIONI COPERCHIO TESTATA	262
GUIDE FILTRAZIONE EFI	81	VALVOLA SCARICO MANUALE	151	GUIDA	260
TAPPO COPPA L'OLIO	81	SISTEMA DI GUIDA	155	PARAOLIO COPERCHIO TESTATA	261
INNIETORE	98	COMANDI DI CONTROLLO	155	TESTATA	254
GUIDA	99	ADATTATORI CAVI MORSE	160	TESTATA – KIT	255
INNIETORE	98	CAVI DI TIMONERIA	160	PARTI MOTORI 4 TEMPI	203
OLIO E GUIDA	83	COMANDO LATERALE	155	2, 2.5, 3.5 HP	203
POMPA BENZINA EN LINEA	71	COMANDO PER CONSOLLA	158	4, 5, 6 HP	204
ADATTATORE	72	INTERRUTTORI E CAVI	159	8, 9.9 HP	205-206-208-210
FASCETTE	72	INTERRUTTORI CONTROLLO	159	13.5, 15 HP	208-210
MOLLA TUBO COMBUSTIBILE	72	INTERRUTTORI TRIM	159	10, 15, 20 HP	212
POMPA	71	KIT ALLARME	159	25 HP	214-216
TUBO BENZINA	72	SILENBLOCK	158	30, 40 HP	218-220
TUBO CARBURANTE	71	SISTEMA DI RAFFREDDAMENTO	161	50, 60 HP	222
POMPA BENZINA	84	ANODI	197	75, 80, 90, 110, 115 HP	224-226
GUIDA POMPA BENZINA	92	CANADA METAL	197	135, 150 HP	227-228
GUIDA POMPA BENZINA MECCANICA	85	RECMAR	199	175 HP	228
KIT POMPA BENZINA	90	TECNOSEAL	200	200, 225, 250, 275, 300 HP	230
MEMBRANA E GUARNIZIONE	89	GUIDA GIRANTE	171	225 EFI V6	232
POMPA BENZINA ALTA PRESSIONE	87	KIT TENUTE	174	PARTI MOTORI 2 TEMPI	243
POMPA BENZINA BASSA PRESSIONE	86	GUIDA KIT TENUTE	176	MARINER 4A	243
POMPA BENZINA ELETTRICA	85	GUIDA TENUTE	176	4, 5, 6, 8, 9.8 HP	244
POMPA BENZINA MECCANICA	84	LIQUIDO INIBITORE DELLA CORROSIONE	161	MARINER 6, 8 HP	245
REGOLATORE PRESSIONE	97	POMPA ACQUA	178	8K, W8	246
VST – GUIDA	87	BASE	178	9.9, 15, 18, 25, 30 HP	248
VST – GUARNIZIONE	97	BASE – KIT	179	40, 45, 50, 55, 60 HP	249
VST ALTA PRESSIONE – KIT	96	BOCCOLA	181	40K W40	250
PUNTINE E CONDENSATORE	154	CORPO	179	65 JET, 70, 75, 80, 90 HP	252
CONDENSATORE	154	CORPO – KIT	180	75, 90 HP, 65 JET	253
GUARNIZIONE DISTRIBUTORE	154	GUARNIZIONE POMPA	182	PISTONE 4 TEMPI	242
KITS	154	GUIDA POMPA ACQUA	191	GUIDA ALBERO MOTORE, BIELLE E PISTONE	242
PUNTINE	154	GUIDA POMPA E TENUTE	188	KIT PISTONI	242
SISTEMA ELETTRICO	109	KIT RICAMBI	184	PISTONE 2 TEMPI	268
BOBINE	116	PIASTRA POMPA	180	FASCE STANDARD PER PISTONI	272
BOBINA AVVIAMENTO	116	TERMOSTATO	162	GUIDA ALBERO MOTORE, BIELLE E PISTONE	270
BOBINA DI CARICA	116	COPERCHIO	168	GUIDA PISTONE EUROPA	271
BOBINA LUCE	119	DEFLETTORE	168	GUIDA PISTONE USA	270
GUIDE	119	DISTANZIALE	169	PISTONE – KIT	268
MODULO CMD	119	GUARNIZIONE COPERCHIO REFRIGERAZIONE	169	POMPA OLIO	241
CANDELE	121	GUIDA	164	POMPA E GUARNIZIONE	241
GOMITO PER CANDELE	125	GUIDA EFI	164	SISTEMA DI SCARICO E ASPIRAZIONE	274
KIT CAVI CANDELE, ALTE PRESTAZIONI	125	MEMBRANA	168	SISTEMA ASPIRAZIONE	278
CDI E CENTRALINA	140	MOLLA	168	ASPIRAZIONE	278
CHIAVETTA DI SICUREZZA	150	NIPLE	169	SISTEMA SCARICO	274
CHIAVI DI ACCENSIONE	131	RACCORDO TESTATA	168	GUARNIZIONE	274
CHIAVE CON CONTATTO	131	RONDELLA	169	GUARNIZIONE CARTER	277
MODULI E LIMITATORI	149	SPESSORE	168	GUARNIZIONE COLLECTORE	277
LIMITATORE RPM	149	TENUTA	168		
MODULO DI ALLARME OLIO	149	TERMOSTATO	162		
MOTORINI AVVIAMENTO	126	TERMOSTATO – COPERCHIO	165		
MOLLA AVVIAMENTO	130				

UNITÀ DI TRASMISSIONE	281	PARTI PIEDI DE 4 TEMPI	287	20 HP	294-324
ATTREZZI	283	2, 2.5, 3.5 HP	287	25 HP	294-300-324
CHIAVE ASSE STRIATO	285	4, 5, 6 HP	288	30 HP	304-324-326
CHIAVE DADO ASSE VERTICALE	285	8 HP	290-292-294-296	40 HP	328-330
CHIAVE DADO LEVA CAMBIO	284	9.9 HP	290-292-294-296	50 HP	300-302
CHIAVE PER CAVO CAMBIO	284	10 HP	298	55 HP	302
CHIAVE PER CUSCINETTO	285	13.5 HP	296-298	60 HP	302-332
CHIAVE PER PIGNONI	285	15 HP	292-294-296-298	70 HP	326
ESTRATTORE CUSCINETTI E ELICHE	283	20 HP	296-298	125 HP	304
ESTRATTORE PIGNONE E CUSCINETTI	284	25, 30 HP EFI	299	V6	334
ESTRATTORE VOLANO	286	25 HP	300	225 HP CARB, 225 EFI/DFI, 250 EFI/DFI	336
KIT ATTREZZI PIEDI	284	30 HP	300-302-304	PIEDI COMPLETI	281
KIT CHIAVE ELICHA	284	40, 45, 50 HP	300-302	SISTEMA DI PROPULSIONE	348
PISTOLA OLIO	286	135 HP	306	ELICHE ALLUMINIO E INOX DA 3 E 4 PALE	348
VACUOMETRO DOPPIA FUNZIONE	286	150 HP	304	ELICHE PER MOZZO INTERCAMBIABILE	351
PARTI PIEDE	338	175, 200, 225 HP	308	GUIDE ELICHE CON MOZZO	349
ACCOPPIAMENTO CAMBIO	344	225 EFI	310	MOZZO INTERCAMBIABILE	350
ASSE CAMBIO	346	300 HP	306	PARTI ELICA	352
ASSE ELICA	344	PARTI PIEDI DE 2 TEMPI	314	CHIUSURA ELICA	353
ASSE TRASMISSIONE	344	2 HP	287-314-316-320	DADO ELICHE	352
CHIAVETTA	346	2.5 HP	287-316	DISTANZIALE	353
DADI PIGNONI	341	3.5 HP	287	FERMO PER ELICA	353
GHIERA	345	3.9 HP	317	GUIDA RICAMBIO ELICHE	354
GOMMINI	344	4 HP	288-317-318	KIT CHIUSURA ELICA	354
GUIDA KIT PIGNONI	338	4.5 HP	317	RONDELLA	352
GUIDA PIGNONI	339	5 HP	288-318	RONDELLA	352
MOLLA	346	6 HP	288-290-292-320	RONDELLA CHIUSURA	354
PARAOLIO	345	7.5 HP	317	SPINOTTO	352
PIGNONI INIZIATIVA	341	8 HP	290-292-320-321	REF --> RO	355
PIGNONI MARCIA AVANTI	341	9.8 HP	290-317	RO --> REF	368
PIGNONI MARCIA INDIETRO	341	9.9 HP	292-322		
PIN	344	13.5 HP	292		
RONDELLA	347	15 HP	292-322		
SELETTORI	342	18 HP	294		
SELETTORI - GUIDA	342				
SPESSORI	346				
TUBO ACQUA	347				
VITE	346				
VITE DRENAGGIO	345				

FR

GUIDE MAINTENANCE KITS	68	COMPOSANTS E CONNECTEURS DU RÉSERVOIR	73	CDI ET BOITIER ELECTRONIQUE	140
SYSTÈME D'ALIMENTATION ET DE FILTRATION	71	PASS-CLOISON	73	COUPE CIRCUIT DE SÉCURITÉ	150
HUILE ET GUIDE	83	RACCORDS DE RESERVOIR	73	CONTACTEUR À CLÉ	131
ACCELERATEUR - CÂBLE	107	FILTRE À HUILE	80	AVEC STARTER	131
ALTERNATEUR	136	BOUCHON CARTER	81	MODULES ET LIMITEURS	149
COURROIE	137	GUIDE FILTRATION EFI	81	LIMITEUR RPM	149
POIRE À CARBURANT	71	GUIDE FILTRES À HUILE	80	MODULE ALARME HUILE	149
COLLIER	72	FILTRE À ESSENCE ET CARTOUCHE DE RECHANGE	74	DÉMARRER	126
POMPE	71	CLÉ À FILTRE	76	RESSORT DE LANCEUR	130
RACCORD COUPLEUR	72	FILTRE À ESSENCE EN LIGNE	77	REGULATEURS ET RECTIFIEURS	138
RESSORT, TUYAU	72	FILTRE À ESSENCE	74	GUIDE	139
TUYAU	72	FILTRE DE CARBURATEUR	79	CAPTEURS	109
TUYAU CARBURANT	71	FILTRE SÉPARATEUR D'ESSENCE	75	FLUX D'EAU	111
POMPE À ESSENCE	84	FILTRE VST	79	GUIDE DES SONDAS EFI	113
GUIDE POMPE À ESSENCE	92	RACCORD EN LAITON	76	IAC	112
GUIDE POMPE MECANIQUE	85	SOUPAPE	76	IAT	112
MEMBRANES ET JOINTS	89	TÊTE DE FILTRE	74	KNOCK	113
POMPE À ESSENCE -KIT	90	FILTRE À AIR	79	MAT/MAP	109
POMPE À ESSENCE BASSE PRESSION	86	INJECTEURS	98	POSITION D'ARBRE À CAMES	112
POMPE À ESSENCE ELECTRIQUE	85	GUIDE	99	POSITION DE VILEBREQUIN	112
POMPE À ESSENCE HAUTE PRESSION	87	INJECTEUR	98	PRESENCE D'EAU	111
POMPE À ESSENCE MECANIQUE	84	INJECTEUR	98	PRESSION D'EAU	111
REGULATEUR DE PRESSION D'ESSENCE	97	VIS PLATINEES ET CONDENSATEUR	154	PRESSION D'HUILE	111
VST - GUIDE	87	CONDENSATEUR	154	TEMPERATURE	110
VST - JOINTS	97	JOINT DE DISTRIBUTEUR	154	TPS	109
VST HAUTE PRESSION - KIT	96	KITS	154	SOLENOIDE RELAIS	132
CARBURATEUR	100	VIS PLATINÉES	154	DÉMARRAGE	132
AXE DE FLOTTEUR	107	SÉPARATEUR DE VAPEUR	108	GUIDE	134
CARBURATEUR - GUIDE DE KITS	103	SYSTÈME ÉLECTRIQUE	109	RELAIS	132
CARBURATEUR - KIT	100	BOBINES	116	TRIM	132
CARBURATEUR COMPLET	100	BOBINE D'ALLUMAGE	116	STARTOR	144
FLOTTEUR	105	BOBINE D'EXCITATION	119	GUIDE	147
JOINT FILTRE CARBURATEUR	107	BOBINE DE CHARGE	116	GUIDE EFI	146
KIT SIEGE, POINTEAU ET GICLEUR	104	GUIDE	119	TRIGGER	142
POINTEAU	105	MODULE CMD	119	TRIM, TILT & POWER TRIM	151
VIS	105	BOUGGIES	121	COUPE DE DÉBLOCAGE MANUEL	151
		CAPUCHON DE BOUGIE	125	INSTALLATION ÉLECTRIQUE	151
		KIT FAISCEAU DE BOUGIE	125	KIT REPARATION TRIM	153
				MOTEUR DE TRIM	153
				SONDE TRIM	153
				TUYAU	151

SYSTÈME DE DIRECTION	155	PIÈCES MOTEURS 2 TEMPS	243	PIÈCES D'EMBASES DE 2 TEMPS	314
INTERRUPTEUR ET CÂBLES	159	MARINER 4A	243	2 HP	287-314-316-320
BUZZER D'ALARME	159	4, 5, 6, 8, 9,8 HP	244	2.5 HP	287-316
INTERRUPTEUR DE CONTRÔLE	159	MARINER 6, 8 HP	245	3.5 HP	287
INTERRUPTOR TRIM	159	8K, W8	246	3.9 HP	317
BOITIER DE COMMANDE	155	9.9, 15, 18, 25, 30 HP	248	4 HP	288-317-318
ADAPTATEURS POUR CÂBLES	160	40, 45, 50, 55, 60 HP	249	4.5 HP	317
BOITIER LATÉRAL	155	40K W40	250	5 HP	288-318
BOITIER POUR CONSOLE	158	65 JET, 70, 75, 80, 90 HP	252	6 HP	288-290-292-320
CÂBLES DE COMMANDE	160	75, 90 HP, 65 JET	253	7.5 HP	317
SILENBLOCK	158	COURROIES DE DISTRIBUTION	272	8 HP	290-292-320-321
SYSTÈME DE REFROIDISSEMENT	161	COURROIES	272	9.8 HP	290-317
ANODES	197	GUIDE	273	9.9 HP	292-322
CANADA METAL	197	GUIDE EFI	239	13.5 HP	292
RECMAR	199	GUIDE VILEBREQUIN DE CULASSE	239	15 HP	292-322
TECNOSEAL	200	JOINT SPI	238	18 HP	294
POMPE À EAU	178	JOINT TORIQUE DE CULASSE	238	20 HP	294-324
BASE	178	JOINTS DE CULASSE	234	25 HP	294-300-324
BASE - KIT	179	JOINTS DE CULASSE - KIT	235	30 HP	304-324-326
CORPS	179	JOINTS DE MOTEUR 2 TEMPS	254	40 HP	328-330
CORPS - KIT	180	BASE DE MOTEUR	258	50 HP	300-302
GUIDE DES KITS POMPE ET JOINTS	188	GUIDE	260	55 HP	302
GUIDE POMPE À EAU	191	JOINT COUVERCLE DE CULASSE	261	60 HP	302-332
INSERT	181	JOINT DE COUVRE CULASSE	262	70 HP	326
JOINTS	182	JOINTS DE CULASSE	254	125 HP	304
KIT REPARATION DE POMPE	184	JOINTS DE CULASSE - KIT	255	V6	334
PLAQUE DE POMPA	180	PISTONS 4 TEMPS	242	225 HP CARB, 225 EFI/DFI, 250 EFI/DFI	336
GUIDE DES TURBINES	171	GUIDE VILEBREQUIN, BIELLES ET PISTONS	242	PARTS D'EMBASES	338
KIT JOINTS	174	KIT PISTON	242	ACCOUPLÉMENT	345
GUIDE DES JOINTS	176	PISTONS 2 TEMPS	268	ARBRE D'HÉLICE	344
GUIDE DES KITS JOINTS	176	GUIDE EUROPE	271	ARBRE DE CHANGEMENT	346
LIQUIDE INHIBANT LA CORROSION	161	GUIDE ISA	270	ARBRE DE TRANSMISSION	344
THERMOSTAT	162	GUIDE PIS	270	BAGUE	344
BAGUE	168	PISTON - KIT	268	CALES	346
COUVERCLE	168	SEGMENTS STANDARD	272	CLAVETTE	346
COUVERCLE DE THERMOSTAT	165	SYSTÈME D'ÉCHAPPEMENT ET D'ADMISSION	274	CRABOT	342
DEFLECTEUR	168	SYSTÈME D'ADMISSION	278	ÉCROU PIGNON	341
DIAPHRAGME	168	JOINT	278	GUIDE DES CRABOTS	342
GUIDE	164	SYSTÈME D'ÉCHAPPEMENT	274	GUIDE DES PIGNONS	339
GUIDE EFI	164	JOINTS	274	GUIDE KIT DES PIGNONS	338
JOINT	168	JOINTS DE CARTER	277	JOINT	345
JOINT DE PLAQUE DE REFROIDISSEMENT	169	JOINTS COLLECTEUR	277	PIGNON DE MARCHE ARRIÈRE	341
JOINTS	166	EMBASES ET PIÈCES	281	PIGNON DE MARCHE AVANT	341
KIT THERMOSTAT	166	EMBASE COMPLETE	281	PIGNONS D'ATTAQUE	341
LOGEMENT	169	OUTILS	283	PIN	344
RACCORD DE CULASSE	168	CLÉ POUR ÉCROU DE DIABOLO	285	RESSORT	346
RESSORT	168	CLÉ POUR ARBRE D'HÉLICE	285	RONDELLE	347
RONDELLE	169	CLÉ POUR ARBRE DE SELECTION	284	SUPPORT SELECTEUR	344
SOUPAPE DE PRESSION	167	CLÉ POUR ARBRE VERTICAL	285	TUYAU D'EAU	347
TÉTINE	169	CLÉ POUR CÂBLE	284	VIS	346
THERMOSTAT	162	CLÉ POUR ÉCROU D'HÉLICE	284	SYSTÈME DE PROPULSION	348
VIS POUR TOUTES LES SOUPAPES	168	CLÉ POUR PIGNONS	285	HÉLICE ALUMINIUM ET INOX 3 ET 4 PALES	348
PIECES MOTEUR	203	EXTRACTEUR DE ROULEMENTS D'HELICE	283	GUIDE DES HÉLICES ET MOYEU	349
POMPE À HUILE	241	EXTRACTEUR DE VOLANT	286	HÉLICES AVEC MOYEU INTERCHANGEABLE	351
POMPE ET JOINTS	241	EXTRACTEUR PIGNONS	284	MOYEU INTERCHANGEABLE	350
VILEBREQUIN 4 TEMPS	241	KIT OUTILS POUT EMBASES	284	PIÈCES POUR HÉLICE	352
GUIDE VILEBREQUIN	241	PISTOLET POUR HUILE D'EMBASE	286	ÉCROU D'HÉLICE	352
ROULEMENT	242	VACUOMETRE DOUBLE FONCTION	286	ENTRETOISE	354
VILEBREQUIN 2 TEMPS	263	PIÈCES D'EMBASES DE 4 TEMPS	287	ENTRETOISE	352
AGUILLE DE PALIER	266	2, 2.5, 3.5 HP	287	ESPACIADOR	353
GUIDE	264	4, 5, 6 HP	288	GOUPILLE FENDUE	353
GUIDE ROULEMENT	266	8 HP	290-292-294-296	GUIDE DES PIÈCES POUR HÉLICE	354
JOINT SPI	263	9.9 HP	290-292-294-296-298	KIT ÉCROU D'HÉLICE	354
PALIER	263	10 HP	296-298	RONDELLE	352
PALIER DE BIELLE	267	13.5 HP	292-294	RONDELLE D'HÉLICE	353
TORIQUE	263	15 HP	292-294-296-298	RONDELLE VREIN	353
PIECES MOTEURS 4 TEMPS	203	20 HP	296-298	REF --> RO	355
2, 2.5, 3.5 HP	203	25, 30 HP EFI	299	RO --> REF	368
4, 5, 6 HP	204	25 HP	300		
8, 9.9 HP	205-206-208-210	30 HP	300-302-304		
13.5, 15 HP	208-210	40, 45, 50 HP	300-302		
10, 15, 20 HP	212	135 HP	306		
25 HP	214-216	150 HP	304		
30, 40 HP	218-220-222	175, 200, 225 HP	308		
50, 60 HP	222	225 EFI	310		
75, 80, 90, 110, 115 HP	224-226	300 HP	306		
135, 150 HP	227-228				
175 HP	228				
200, 225, 250, 275, 300 HP	230				
225 EFI V6	232				

GUÍA KITS
MANTENIMIENTO

MAINTENANCE GUIDE
& KITS

GUIDA
MANUTENZIONE E KIT





GUIDE
MAINTENANCE KITS





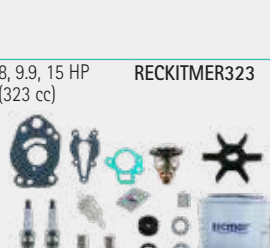

4 TIEMPOS

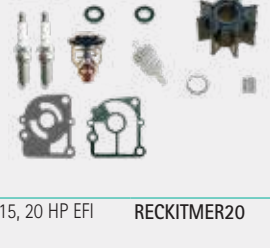

4 STROKES



4 TEMPI

4 TEMPS

KIT		REF					
	RECKITMER2.5	NGKDCPR6E	BUJÍA	SPARK PLUG	CANDELE	BOUGIE	1
		TEN00824	ÁNODO	ANODE	ANODO	ANODE	1
		RM804540	TERMOSTATO	THERMOSTAT	TERMOSTATO	THERMOSTAT	1
		REC90430-08020	JUNTA DESAGÜE	DRAIN GASKET	GUARNIZIONE DRENAGGIO	JOINT DE VIDANGE	x 2
		REC09168-10022	JUNTA DESAGÜE	DRAIN GASKET	GUARNIZIONE DRENAGGIO	JOINT DE VIDANGE	1
		PAGB/T91-2.5X30	PIN	PIN	PIN	PIN	1
		REC898101371	PLACA	PLATE	PIASTRA	PLAQUE	1
		REC47-161543	TURBINA	IMPELLER	GIRANTE	TURBINE	1
		REC27-898101331	JUNTA DE TURBINA	IMPELLER GASKET	GUARNIZIONE GIRANTE	JOINT DE TURBINE	1
			RECKITMER4	NGKDCPR6E	BUJÍA	SPARK PLUG	CANDELE
REC875208	ANODO			ANODE	ANODO	ANODE	1
RM804540	TERMOSTATO			THERMOSTAT	TERMOSTATO	THERMOSTAT	1
PAF4-05000300	FILTRO COMBUSTIBLE			FUEL FILTER	FILTRO COMBUSTIBILE	FILTRE A ESSENCE	1
REC90430-08020	JUNTA DESAGÜE			DRAIN GASKET	GUARNIZIONE DRENAGGIO	JOINT DE VIDANGE	x 2
REC09168-10022	JUNTA DESAGÜE			DRAIN GASKET	GUARNIZIONE DRENAGGIO	JOINT DE VIDANGE	1
PAGB/T91-2.5X20	PIN			PIN	PIN	PIN	1
REC16159	PLACA			PLATE	PIASTRA	PLAQUE	1
REC47-161543	TURBINA			IMPELLER	GIRANTE	TURBINE	1
PAT5-03000006	JUNTA DE TURBINA			IMPELLER GASKET	GUARNIZIONE GIRANTE	JOINT DE TURBINE	1
PAF6-03000003	JUNTA DE TURBINA	IMPELLER GASKET	GUARNIZIONE GIRANTE	JOINT DE TURBINE	1		
	RECKITMER209	NGKDCPR6E	BUJÍA	SPARK PLUG	CANDELE	BOUGIE	x 2
		TEN00823	ANODO	ANODE	ANODO	ANODE	1
		REC875208	ÁNODO	ANODE	ANODO	ANODE	x 2
		RM855676005	TERMOSTATO	THERMOSTAT	TERMOSTATO	THERMOSTAT	1
		PAF8-05010005	JUNTA TERMOSTATO	THERMOSTAT GASKET	GUARNIZIONE TERMOSTATO	JOINT THERMOSTAT	1
		PAF4-05000300	FILTRO COMBUSTIBLE	FUEL FILTER	FILTRO COMBUSTIBILE	FILTRE A ESSENCE	1
		REC90430-08020	JUNTA DESAGÜE	DRAIN GASKET	GUARNIZIONE DRENAGGIO	JOINT DE VIDANGE	x 2
		PAF15-04000003	JUNTA DESAGÜE	DRAIN GASKET	GUARNIZIONE DRENAGGIO	JOINT DE VIDANGE	1
		PAGB/T91-2.5X20	PIN HÉLICE	PIN PROPELLER	SPINOTTO ELICHA	GOUPILLE HÉLICE	1
		PAF8-04000007	PLACA	PLATE	PIASTRA	PLAQUE	1
		PAF8-04000200	TURBINA	IMPELLER	GIRANTE	TURBINE	1
		PAF8-04000021	CHAVETA	KEY	CHIAVE	CLAVETTE	1
		PAF8-04000006	JUNTA DE TURBINA	IMPELLER GASKET	GUARNIZIONE GIRANTE	JOINT DE TURBINE	1
PAF8-04000008	JUNTA DE TURBINA	IMPELLER GASKET	GUARNIZIONE GIRANTE	JOINT DE TURBINE	1		
	RECKITMER323	NGKDCPR6E-A-9	BUJÍA	SPARK PLUG	CANDELE	BOUGIE	x 2
		REC42121Q02AL	ANODO	ANODE	ANODO	ANODE	1
		PAF15-07010008	ÁNODO	ANODE	ANODO	ANODE	x 2
		REC09168-10022	JUNTA DESAGÜE	DRAIN GASKET	GUARNIZIONE DRENAGGIO	JOINT DE VIDANGE	1
		REC6AH-12411-00	TERMOSTATO	THERMOSTAT	TERMOSTATO	THERMOSTAT	1
		PAF15-07010022	JUNTA TERMOSTATO	THERMOSTAT GASKET	GUARNIZIONE TERMOSTATO	JOINT THERMOSTAT	1
		PAF4-05000300	FILTRO COMBUSTIBLE	FUEL FILTER	FILTRO COMBUSTIBILE	FILTRE A ESSENCE	1
		REC12-191833	JUNTA DESAGÜE	DRAIN GASKET	GUARNIZIONE DRENAGGIO	JOINT DE VIDANGE	x 2
		REC35-822626Q03	FILTRO ACEITE	OIL FILTER	FILTRO OLIO	FILTRE A HUILE	1
		PAF15-07010009	ALOJAMIENTO ANODO	GROMMET	ALLOGGIAMENTO ANODO	JOINT D'ANODE	1
		REC47-420382	TURBINA	IMPELLER	GIRANTE	TURBINE	1
		REC28-42376A2	CHAVETA	KEY	CHIAVE	CLAVETTE	1
		REC27-19202001	JUNTA DE TURBINA	IMPELLER GASKET	GUARNIZIONE GIRANTE	JOINT DE TURBINE	1
		REC27-192043	JUNTA DE TURBINA	IMPELLER GASKET	GUARNIZIONE GIRANTE	JOINT DE TURBINE	1
			RECKITMER15	NGKDCPR6E	BUJÍA	SPARK PLUG	CANDELE
TEN00823	ANODO			ANODE	ANODO	ANODE	1
REC875208	ÁNODO			ANODE	ANODO	ANODE	x 2
REC853762T01	ANODO			ANODE	ANODO	ANODE	1
TEN00824	ANODO			ANODE	ANODO	ANODE	1
RM855676005	TERMOSTATO			THERMOSTAT	TERMOSTATO	THERMOSTAT	1
PAF4-05000300	FILTRO COMBUSTIBLE			FUEL FILTER	FILTRO COMBUSTIBILE	FILTRE A ESSENCE	1
REC803753	PLACA			PLATE	PIASTRA	PLAQUE	1
REC90430-08020	JUNTA DESAGÜE			DRAIN GASKET	GUARNIZIONE DRENAGGIO	JOINT DE VIDANGE	x 2
PAF15-04000003	JUNTA DESAGÜE			DRAIN GASKET	GUARNIZIONE DRENAGGIO	JOINT DE VIDANGE	1
REC35-822626Q03	FILTRO ACEITE			OIL FILTER	FILTRO OLIO	FILTRE A HUILE	1
REC334-65021-1	TURBINA			IMPELLER	GIRANTE	TURBINE	1
REC28-803749	CHAVETA			KEY	CHIAVE	CLAVETTE	1
REC27-8M0075040	JUNTA DE TURBINA	IMPELLER GASKET	GUARNIZIONE GIRANTE	JOINT DE TURBINE	1		
	RECKITMER20	NGKDCPR6E	BUJÍA	SPARK PLUG	CANDELE	BOUGIE	1
		TEN00824	ANODO	ANODE	ANODO	ANODE	x 2
		REC875208	ÁNODO	ANODE	ANODO	ANODE	x 2
		REC41106-ZW9-000	ANODO	ANODE	ANODO	ANODE	1
		REC8M0139434	TERMOSTATO	THERMOSTAT	TERMOSTATO	THERMOSTAT	1
		PAF8-05010005	JUNTA TERMOSTATO	THERMOSTAT GASKET	GUARNIZIONE TERMOSTATO	JOINT THERMOSTAT	1
		REC35-8M0134466	FILTRO COMBUSTIBLE	FUEL FILTER	FILTRO COMBUSTIBILE	FILTRE A ESSENCE	1
		PAF15-04000003	JUNTA DESAGÜE	DRAIN GASKET	GUARNIZIONE DRENAGGIO	JOINT DE VIDANGE	1
		REC09168-10022	JUNTA DESAGÜE	DRAIN GASKET	GUARNIZIONE DRENAGGIO	JOINT DE VIDANGE	x 2
		REC35-822626Q03	FILTRO ACEITE	OIL FILTER	FILTRO OLIO	FILTRE A HUILE	1
		REC98-8M0135821	KIT BOMBA DE AGUA	WATER PUMP REPAIR KIT	KIT POMPA DELL'ACQUA	KIT POMPE À EAU	1
		PAGB/T91-2.5X20	PIN HÉLICE	PIN PROPELLER	SPINOTTO ELICHA	GOUPILLE HÉLICE	1

	KIT	REF							
	25, 30 HP EFI RECKITMER25	NGKDCPR6E	BUJÍA	SPARK PLUG	CANDELE	BOUGIE	x 3		
		TEN00823	ANODO	ANODE	ANODO	ANODE	1		
		TEN00841	ANODO	ANODE	ANODO	ANODE	1		
		REC55320-94900	ANODO	ANODE	ANODO	ANODE	1		
		REC853762	ANODO	ANODE	ANODO	ANODE	1		
		REC855676002	TERMOSTATO	THERMOSTAT	TERMOSTATO	THERMOSTAT	1		
		PAF8-05010005	JUNTA TERMOSTATO	THERMOSTAT GASKET	GUARNIZIONE TERMOSTATO	JOINT THERMOSTAT	1		
		PAF15-07080000	FILTRO COMBUSTIBLE	FUEL FILTER	FILTRO COMBUSTIBILE	FILTRE A ESSENCE	1		
		REC35-822626Q03	FILTRO ACEITE	OIL FILTER	FILTRO OLIO	FILTRE A HUILE	1		
		PAF15-04000003	JUNTA DESAGÜE	DRAIN GASKET	GUARNIZIONE DRENAGGIO	JOINT DE VIDANGE	1		
		REC90430-08020	JUNTA DESAGÜE	DRAIN GASKET	GUARNIZIONE DRENAGGIO	JOINT DE VIDANGE	x 2		
		REC853792T01	KIT BOMBA DE AGUA	WATER PUMP REPAIR KIT	KIT POMPA DELL'ACQUA	KIT POMPE À EAU	1		
		PAGB/T91-2.5X30	PIN HÉLICE	PIN PROPELLER	SPINOTTO ELICHA	GOUPILLE HÉLICE	1		
			40HP EFI (3 cyl) RECKITMER40	CHARA8HC	BUJÍA	SPARK PLUG	CANDELE	BOUGIE	x 3
				REC818298Q1AL	ANODO	ANODE	ANODO	ANODE	1
REC17264T2	ANODO			ANODE	ANODO	ANODE	1		
REC825212T02	TERMOSTATO			THERMOSTAT	TERMOSTATO	THERMOSTAT	1		
PAF15-07010022	JUNTA TERMOSTATO			THERMOSTAT GASKET	GUARNIZIONE TERMOSTATO	JOINT THERMOSTAT	1		
PAF15-07080000	FILTRO COMBUSTIBLE			FUEL FILTER	FILTRO COMBUSTIBILE	FILTRE A ESSENCE	1		
REC35-879885T	FILTRO COMBUSTIBLE			FUEL FILTER	FILTRO COMBUSTIBILE	FILTRE A ESSENCE	1		
REC35-822626Q04	FILTRO ACEITE			OIL FILTER	FILTRO OLIO	FILTRE A HUILE	1		
REC26-830749	JUNTA DESAGÜE			DRAIN GASKET	GUARNIZIONE DRENAGGIO	JOINT DE VIDANGE	x 2		
REC27-828816	JUNTA DESAGÜE			DRAIN GASKET	GUARNIZIONE DRENAGGIO	JOINT DE VIDANGE	1		
REC8M0005777	ARANDELA			WASHER	RONDELLA	RONDELLE	x 2		
REC27-8M4502052	JUNTA			GASKET	GUARNIZIONE	JOINT	1		
REC47-19453T	TURBINA			IMPELLER	GIRANTE	TURBINE	1		
REC27-822189	JUNTA DE TURBINA			IMPELLER GASKET	GUARNIZIONE GIRANTE	JOINT DE TURBINE	1		
REC28-8M0032831	CHAVETTA			KEY	CHIAVE	CLAVETTE	1		
REC19700A2	PLACA	PLATE	PIASTRA	PLAQUE	1				
	40, 50, 60 HP EFI (4 cyl) RECKITMER50	CHARA8HC	BUJÍA	SPARK PLUG	CANDELE	BOUGIE	x 4		
		REC818298Q1AL	ANODO	ANODE	ANODO	ANODE	1		
		REC17264T2	ANODO	ANODE	ANODO	ANODE	1		
		REC826134QAL	ANODO	ANODE	ANODO	ANODE	x 2		
		REC14586	TERMOSTATO	THERMOSTAT	TERMOSTATO	THERMOSTAT	1		
		PAF15-07010022	JUNTA TERMOSTATO	THERMOSTAT GASKET	GUARNIZIONE TERMOSTATO	JOINT THERMOSTAT	1		
		PAF15-07080000	FILTRO COMBUSTIBLE	FUEL FILTER	FILTRO COMBUSTIBILE	FILTRE A ESSENCE	1		
		REC35-879885T	FILTRO COMBUSTIBLE	FUEL FILTER	FILTRO COMBUSTIBILE	FILTRE A ESSENCE	1		
		REC35-822626Q04	FILTRO ACEITE	OIL FILTER	FILTRO OLIO	FILTRE A HUILE	1		
		REC26-830749	JUNTA DESAGÜE	DRAIN GASKET	GUARNIZIONE DRENAGGIO	JOINT DE VIDANGE	x 2		
		PAF15-04000003	JUNTA DESAGÜE	DRAIN GASKET	GUARNIZIONE DRENAGGIO	JOINT DE VIDANGE	1		
		REC8M0005777	ARANDELA	WASHER	RONDELLA	RONDELLE	x 2		
		REC27-8M4502052	JUNTA	GASKET	GUARNIZIONE	JOINT	1		
		REC47-19453T	TURBINA	IMPELLER	GIRANTE	TURBINE	1		
		REC27-822189	JUNTA DE TURBINA	IMPELLER GASKET	GUARNIZIONE GIRANTE	JOINT DE TURBINE	1		
REC28-8M0032831	CHAVETA	KEY	CHIAVE	CLAVETTE	1				
REC19700A2	PLACA	PLATE	PIASTRA	PLAQUE	1				
	75, 80, 90, 100, 115 HP EFI RECKITMER115	NGKLF4AE	BUJÍA	SPARK PLUG	CANDELE	BOUGIE	x 4		
		REC818298Q1AL	ANODO	ANODE	ANODO	ANODE	1		
		REC31640Q4AL	ANODO	ANODE	ANODO	ANODE	1		
		REC826134QAL	ANODO	ANODE	ANODO	ANODE	x 2		
		REC892864T06	TERMOSTATO	THERMOSTAT	TERMOSTATO	THERMOSTAT	1		
		REC35-879885T	FILTRO COMBUSTIBLE	FUEL FILTER	FILTRO COMBUSTIBILE	FILTRE A ESSENCE	x 2		
		REC35-877761Q01	FILTRO ACEITE	OIL FILTER	FILTRO OLIO	FILTRE A HUILE	1		
		RM35-8M0082911	FILTRO AIRE	AIR FILTER	FILTRO ARIA	FILTRE AIRE	1		
		REC12-191833	JUNTA DESAGÜE	DRAIN GASKET	GUARNIZIONE DRENAGGIO	JOINT DE VIDANGE	x 2		
		REC27-828816	JUNTA DESAGÜE	DRAIN GASKET	GUARNIZIONE DRENAGGIO	JOINT DE VIDANGE	1		
		REC47-43026Q06	KIT TURBINA	IMPELLER KIT	KIT GIRANTE	KIT TURBINE	1		
			135, 150 HP EFI RECKITMER150	NGKZFR5F	BUJÍA	SPARK PLUG	CANDELE	BOUGIE	x 4
				TEN00842	ANODO	ANODE	ANODO	ANODE	1
				REC76214Q5AL	ANODO	ANODE	ANODO	ANODE	1
				REC826134QAL	ANODO	ANODE	ANODO	ANODE	x 2
REC892864T06	TERMOSTATO			THERMOSTAT	TERMOSTATO	THERMOSTAT	1		
REC35-879885T	FILTRO COMBUSTIBLE			FUEL FILTER	FILTRO COMBUSTIBILE	FILTRE A ESSENCE	x 2		
REC35-877761Q01	FILTRO ACEITE			OIL FILTER	FILTRO OLIO	FILTRE A HUILE	1		
REC26-830749	JUNTA DESAGÜE			DRAIN GASKET	GUARNIZIONE DRENAGGIO	JOINT DE VIDANGE	x 2		
REC46-8M0061040	KIT TURBINA			IMPELLER KIT	KIT GIRANTE	KIT TURBINE	1		
	VERADO 135, 150, 175, 200 HP (4 cyl) RECKITMVERADO4			NGKILFR6G-E	BUJÍA	SPARK PLUG	CANDELE	BOUGIE	x 4
				RECKITMVERADO4AL	KIT ANODO	ANODE KIT	KIT ANODO	KIT ANODE	1
				REC892864T04	TERMOSTATO	THERMOSTAT	TERMOSTATO	THERMOSTAT	1
				REC35-879885T	FILTRO COMBUSTIBLE	FUEL FILTER	FILTRO COMBUSTIBILE	FILTRE A ESSENCE	1
				REC35-8M0122423	FILTRO COMBUSTIBLE	FUEL FILTER	FILTRO COMBUSTIBILE	FILTRE A ESSENCE	1
				REC35-896546T	FILTRO ACEITE	OIL FILTER	FILTRO OLIO	FILTRE A HUILE	1
		REC35-896247	FILTRO AIRE	AIR FILTER	FILTRO ARIA	FILTRE AIRE	1		
		REC26-830749	JUNTA DESAGÜE	DRAIN GASKET	GUARNIZIONE DRENAGGIO	JOINT DE VIDANGE	x 2		
		REC47-43026Q06	KIT TURBINA	IMPELLER KIT	KIT GIRANTE	KIT TURBINE	1		

	KIT	REF						
	RECKITMERVERAD06	NGKILFR6G-E	BUJÍA	SPARK PLUG	CANDELE	BOUGIE	x 6	
		TEN00837	ANODO	ANODE	ANODO	ANODE	1	
		RECKITMERVERAD06AL	KIT ANODO	ANODE KIT	KIT ANODO	KIT ANODE	1	
		REC892864T04	TERMOSTATO	THERMOSTAT	TERMOSTATO	THERMOSTAT	1	
		REC35-8M0122423	FILTRO COMBUSTIBLE	FUEL FILTER	FILTRO COMBUSTIBILE	FILTRE A ESSENCE	1	
		REC35-879885T	FILTRO COMBUSTIBLE	FUEL FILTER	FILTRO COMBUSTIBILE	FILTRE A ESSENCE	1	
		REC35-883701K01	FILTRO ACEITE	OIL FILTER	FILTRO OLIO	FILTRE A HUILE	1	
		REC35-893318T02	FILTRO AIRE	AIR FILTER	FILTRO ARIA	FILTRE A AIR	1	
		REC26-888593	JUNTA DESAGÜE	DRAIN GASKET	GUARNIZIONE DRENAGGIO	JOINT DE VIDANGE	1	
		REC26-830749	JUNTA DESAGÜE	DRAIN GASKET	GUARNIZIONE DRENAGGIO	JOINT DE VIDANGE	x 2	
	REC47-43026Q06	KIT TURBINA	IMPELLER KIT	KIT GIRANTE	KIT TURBINE	1		
	RECKITMER3.4	NGKIKAR7C-9	BUJÍA	SPARK PLUG	CANDELE	BOUGIE	x 6	
		REC818298Q1AL	ANODO	ANODE	ANODO	ANODE	1	
		REC97-8M0137814AL	ANODO	ANODE	ANODO	ANODE	1	
		REC8M0162139	TERMOSTATO	THERMOSTAT	TERMOSTATO	THERMOSTAT	1	
		REC35-8M0106635	FILTRO COMBUSTIBLE	FUEL FILTER	FILTRO COMBUSTIBILE	FILTRE A ESSENCE	1	
		REC35-8M0123025	FILTRO ACEITE	OIL FILTER	FILTRO OLIO	FILTRE A HUILE	1	
		REC26-830749	JUNTA DESAGÜE	DRAIN GASKET	GUARNIZIONE DRENAGGIO	JOINT DE VIDANGE	x 2	
		REC47-8M0142980	KIT TURBINA	IMPELLER KIT	KIT GIRANTE	KIT TURBINE	1	
			REC47-8M0142980	KIT TURBINA	IMPELLER KIT	KIT GIRANTE	KIT TURBINE	1
			REC47-8M0142980	KIT TURBINA	IMPELLER KIT	KIT GIRANTE	KIT TURBINE	1
	RECKITMER4.6	NGKIKAR7C-9	BUJÍA	SPARK PLUG	CANDELE	BOUGIE	x 8	
		REC818298Q1AL	ANODO	ANODE	ANODO	ANODE	1	
		REC97-8M0137814AL	ANODO	ANODE	ANODO	ANODE	1	
		REC8M0162139	TERMOSTATO	THERMOSTAT	TERMOSTATO	THERMOSTAT	1	
		REC35-8M0106635	FILTRO COMBUSTIBLE	FUEL FILTER	FILTRO COMBUSTIBILE	FILTRE A ESSENCE	1	
		REC35-8M0123025	FILTRO ACEITE	OIL FILTER	FILTRO OLIO	FILTRE A HUILE	1	
		REC26-830749	JUNTA DESAGÜE	DRAIN GASKET	GUARNIZIONE DRENAGGIO	JOINT DE VIDANGE	x 2	
		REC47-8M0142980	KIT TURBINA	IMPELLER KIT	KIT GIRANTE	KIT TURBINE	1	
			REC47-8M0142980	KIT TURBINA	IMPELLER KIT	KIT GIRANTE	KIT TURBINE	1
			REC47-8M0142980	KIT TURBINA	IMPELLER KIT	KIT GIRANTE	KIT TURBINE	1

2 TIEMPOS	2 STROKES	2 TEMPI	2 TEMPS					
	RECKITMEROP115	NGKIZFR5J	BUJÍA	SPARK PLUG	CANDELE	BOUGIE	x 3	
		REC818298Q1AL	ANODO	ANODE	ANODO	ANODE	1	
		REC31640Q4AL	ANODO	ANODE	ANODO	ANODE	1	
		REC826134QAL	ANODO	ANODE	ANODO	ANODE	x 2	
		REC833072004	TERMOSTATO	THERMOSTAT	TERMOSTATO	THERMOSTAT	1	
		REC35-8M0122423	FILTRO COMBUSTIBLE	FUEL FILTER	FILTRO COMBUSTIBILE	FILTRE A ESSENCE	1	
		REC12-191833	JUNTA DESAGÜE	DRAIN GASKET	GUARNIZIONE DRENAGGIO	JOINT DE VIDANGE	x 2	
		REC47-43026Q06	KIT TURBINA	IMPELLER KIT	KIT GIRANTE	KIT TURBINE	1	
			REC47-43026Q06	KIT TURBINA	IMPELLER KIT	KIT GIRANTE	KIT TURBINE	1
			REC47-43026Q06	KIT TURBINA	IMPELLER KIT	KIT GIRANTE	KIT TURBINE	1
	RECKITMEROP225	NGKIZFR5G	BUJÍA	SPARK PLUG	CANDELE	BOUGIE	x 6	
		REC76214Q5AL	ANODO	ANODE	ANODO	ANODE	1	
		REC818298Q1AL	ANODO	ANODE	ANODO	ANODE	1	
		REC826134QAL	ANODO	ANODE	ANODO	ANODE	x 2	
		REC833072003	TERMOSTATO	THERMOSTAT	TERMOSTATO	THERMOSTAT	1	
		REC35-8M0122423	FILTRO COMBUSTIBLE	FUEL FILTER	FILTRO COMBUSTIBILE	FILTRE A ESSENCE	1	
		REC26-830749	JUNTA DESAGÜE	DRAIN GASKET	GUARNIZIONE DRENAGGIO	JOINT DE VIDANGE	x 2	
		REC47-43026Q06	KIT TURBINA	IMPELLER KIT	KIT GIRANTE	KIT TURBINE	1	

SISTEMA DE ALIMENTACIÓN Y FILTRACIÓN FUEL & FILTRATION SYSTEM

SISTEMA DI ALIMENTAZIONE E FILTRAZIONE SYSTÈME D'ALIMENTATION ET DE FILTRATION

BOMBA DE COMBUSTIBLE FUEL PUMP POMPA BENZINA POIRE À CARBURANT



BOMBA DE COMBUSTIBLE FUEL PUMP POMPA BENZINA POIRE À CARBURANT

Fabricada con elastómeros termoplásticos inyectados, resistentes al alcohol y rayos UV.s



Premium quality bulb resistance to alcohol as well as UV and ozone.

Fabbricata con elastomero termoplastico, resistente ai solventi e raggi UV.



Fabriqué avec des élastomères thermoplastiques injectés, résistant aux carburants et aux rayons UV.

REF	R.O. OEM		
GS31187		1/4" = 6 mm	1
GS31090		5/16" = 8 mm	1
GS31095	8M0054313	3/8" = 9.5 mm	1



REF	R.O. OEM		
SIE18-8004	98396A38	5/16" = 8 mm	1
SIE18-8005	98396A38	3/8" = 9.5 mm	1



REF	R.O. OEM		
REC858763	858763	30 HP - 90 HP	1





LÍNEA DE COMBUSTIBLE FUEL LINE ASSEMBLY TUBO CARBURANTE TUYAU CARBURANT

Universal. Manguera resistente al alcohol.

Universal. Alcohol resistant hose.

Universale. Tubo resistente ai solventi.

Universel. Tuyau résistant aux carburants.

REF		
GS31096	5/16" x 2 m	1
GS31097	3/8" x 2 m	1
GS31099	8 mm x 2 m	1
SIE18-8013	5/16" x 2 m	1
SIE18-8015	3/8" x 2 m	1



SIE18-8013
SIE18-8015

new

REF		
GS31183	6 mm x 2 m	1

GOLDENSHIP

new

REF		
PAF15-09000000	6 mm x 3m	1

MANGUERA DE COMBUSTIBLE

FUEL HOSE

TUBO BENZINA

TUYAU CARBURANT

Con refuerzo termoplástico que le permite excelente flexibilidad y resistencia a los rayos UV. Color gris. Resistente al alcohol. Especialmente indicado para motores fueraborda. Garantía: 3 años

Fuel resistant thermo-plastic formulation with 2 spiral reinforcement provides excellent bendability and resistance to UV, aging and permeation by all marine fuels (gasoline/petrol and diesel) including alcohol blends. Warranty: 3 years

Con rinforzo termoplastico che gli permette un'eccellente flessibilità e resistenza ai raggi UV. Colore grigio. Resistente ai solventi. Indicato per i motori fuoribordo. Garanzia: 3 anni

Avec renfort thermoplastique qui permet une excellente flexibilité et résistance aux rayons UV. Gris. Résistant à l'essence et au diesel. Convient particulièrement aux moteurs hors-bord. Garantie: 3 ans

REF				
TRI305-0566	5/16" = 7,92 mm	15 m	1	SAE J1527
TRI305-0386	3/8" = 9,53 mm	15 m	1	ISO-8469 B1 CE

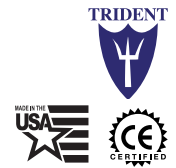

De goma para diesel y gasolina sin plomo. Ideal para fueraborda. Refuerzos textiles internos. Muy flexible. Contenido aromático 50%

Rubber Hose suitable for loading mineral oils, diesel and unleaded fuel

In gomma per diesel e benzina senza piombo. Ideale per motori fuoribordo. Tessuto interno rinforzato. Molto flessibile.

Caoutchouc pour diesel et essence sans plomb. Idéal pour le hors-bord. Renforts textiles internes. Très flexible

CARBUPOMP/10NL

REF						
GS35031	6x12	10 bar	50 mm	-25°C → 80° C	50 m	ISO R1307
GS35032	8x15	10 bar	65 mm		50 m	



MUELLE TUBO COMBUSTIBLE

SPRING, FUEL PIPE

MOLLA TUBO COMBUSTIBILE

RESSORT, TUYAU DE CARBURANT

new

REF	
PAF4-04000030	10
PAF4-05000010	13



ABRAZADERA

CLAMP SMALL

FASCETTE

COLLIER

new

REF	
REC650-24351-51	6 mm
REC6E5-24351-51	8 mm



REF		
REC09401-11425	6-8 mm	1
REC09401-11425BULK	6-8 mm	25



ADPATADOR LÍNEA DE COMBUSTIBLE

COUPLER

ADATTATORE

RACCORD COUPLEUR

REF	
REC22-8M0001721	Ø 11 mm --> Ø 9 mm



COMPONENTES TANQUE Y CONECTORES

FUEL TANK COMPONENTS & CONNECTORS

COMPONENTI SERBATOIO E CONETTORI

COMPOSANTS ET CONNECTEURS DU RÉSERVOIR

CONECTOR DE DEPÓSITO

TANK CONNECTOR

ATTACCO SERBATOIO

RACCORDS DE RESERVOIR

Fabricado en latón.

Made in machined brass.

Fabbricato in ottone.

Fabriquer en laiton.

REF		
GS31068	1/4" NPT	1



Para conectar dos motores a un sólo depósito, o viceversa.
Fabricado en latón.

To connect two motors to a single tank, or vice versa.
Made in machined brass.

Per collegare due motori a un singolo serbatoio o viceversa.
Fabbricato in ottone.

Pour connecter deux moteurs à un même réservoir, ou inversement.
Fabriquer en laiton.

REF		
GS31069	1/4" NPT	1



REF	OEM		
GS31078	22831T03	10 mm 3/8"	1
GS31079	30185T3	8 mm 5/16"	1
GS31080	30185T3	10 mm 3/8"	1





GS31078





GS31079-GS31080



REF	OEM		
GS31026	22-142131	6 mm 1/4"	1
GS31027	22-13563t-3	8 mm 5/16"	1
GS31028	22-13563t-3	10 mm 3/8"	1



REF	OEM			
GS31082	22-13563T-7	10 mm 3/8"	NEW 4 hp - V6 (1998+)	1





Toma de tanque de combustible.
Fabricado en latón.

Fuel tank connector
Made in machined brass

Filettatura per serbatoio benzina
Fabbricato in ottone.

Raccord pour réservoir de carburant.
Fabriquer en laiton.

REF		
GS31022	1/4" NPT Standard	1
GS31023	1/4" NPT New	1
GS31025	1/4" NPT	1
GS31081	1/4" NPT New	1

GS31022
GS31023



GS31025
GS31081



PASAMAMPAROS

THRU HULL

PASSASCAFO

PASSE-CLOISON

Para atravesar mamparos de hasta 12 mm. Fabricado en latón.

For bulkhead up to 12 mm. Made in machined brass.

Per attraversare paratie fino a 12 mm.
Fabbricato in ottone.

Pour traverser des cloisons jusqu'à 12 mm. Fabriquer en laiton.

REF		
GS31064	3/8"	1



FILTRO DE COMBUSTIBLE Y ELEMENTOS

FUEL FILTERS AND ELEMENTS

FILTRI BENZINA E RACCORDI

FILTRE A ESSENCE ET CARTOUCHE DE RECHANGE

BRACKET

Con 2 tapones de bronce y 2 tubos de extensión. (2 entradas y 2 salidas).

BRACKET



With 2 brass plugs and 2 extension tubes. (2 inputs & 2 outputs).

SUPPORTO

Con 2 tappi di bronzo e 2 tubi di estensione. (2 ingressi entrata carburante e 2 uscite carburante).

TÊTE DE FILTRE À ESSENCE

Avec 2 bouchons en bronze et 2 tubes d'extension. (2 entrées et 2 sorties).

REF	R.O. OEM		
REC25000	89876A3	1/4"	AL
REC25010		1/4"	INOX /SS AISI316
REC25020		3/8"	AL
REC25030		3/8"	INOX /SS AISI316
RECOBBRACKET		1/4"	Plástico Plastic Plastica Plastique



REC25000 - REC25020



REC25010 - REC25030



RECOBBRACKET

FILTRO COMBUSTIBLE SEPARADOR DE AGUA

WATER SEPARATING FUEL FILTER

FILTRO SEPARATORE ACQUA-BENZINA

FILTRE À ESSENCE

REF	MICRON	
REC24942	10	4 7/16" = 11 cm
REC35-802893Q01	10	3 3/4"
REC855686	28	4 7/16"
REC35-802893Q	25	3 3/4"
RACPF5510	10	4 7/16"

RACOR



RACPF5510

RECMAR



REC24942



REC35-802893Q01



REC855686





REC35-802893Q

Filtro original.

OEM filter.

Filtro benzina originale.

Filtre à essence original

REF	R.O. OEM	MICRON		
REC35-18458Q4	35-18458Q4	10	3 3/4"	V-135 DFI 2.5L (2001-03) V-150 DFI/EFI 2.5L (2000-10) V-175 DFI/EFI 2.5L (2000-03)
RM35-802893Q	35-802893Q01	10	3 3/4"	V-200/200 EFI 2.5/3.0L (2000-10) 225 DFI/EFI 3.0L (1998-09) 250 EFI 3.0L (1998-09) 200, 210, 250 HP Jet Drive (2001-10) 200, 225, 300 HP Mercury Racing (2001-05)



RM35-802893Q



REC35-18458Q4



REF	R.O. OEM	
REC35-8M0157620	35-8M0095658 8M0157616 8M0157620	6 cyl. Verado, Gen 5



new

FILTRO CON BRACKET

Con 2 tapones de bronce y 1 tubo de extensión.

OEM FILTER WITH BRACKET



With 2 brass plugs & 1 extension tube.

FILTRO BENZINA CON SUPPORTO

Con 2 tappi di bronzo e 1 tubo di estensione.

FILTRE A ESSENCE AVEC SUPPORT

avec 2 bouchons en bronze et 1 tube d'extension

REF	R.O. OEM	MICRON			
REC24950	35-802893Q4	25	1/4"	50 GPH	AL
REC24952		10	1/4"	50 GPH	AL





RECMAR

FILTRO DECANTADOR DE COMBUSTIBLE COMPLETO CON VASO TRANSPARENTE

COMPLET FUEL FILTER WITH TRANSPARENT BOWL

FILTRO DI DECANTAZIONE BENZINA COMPLETO CON VASCHETTA TRASPARENTE

FILTRE SÉPARATEUR D'ESSENCE

REF	OEM		BRACKET 	
RAC320R-RAC-01			AL	
RAC320R-RAC-03	8M0097838	RACS3213 LENS3213	Plástico Plastic Plastica Plastique	F75-150 HP SeaPro (2014+)



REF			BRACKET 
RECOBFILALU			AL
RECOBFILTER	RECOBELEMENT LENS3213	150 l/h	Plástico Plastic Plastica Plastique



REF		MICRON		
REC90794-46866	REC90794-46868	10	117 l/h	175 hp

RECMAR



**LLAVE PARA FILTRO
FILTER KEY
CHIAVE DA FILTRO
CLÉ A FILTRE**



REF
RECYS-225-15



REF	MICRON	
PAF40-0701000E1	10	70 hp

new



REF		MICRON		
RAC120R-RAC-01	RACS3240 LENS3227	10	114 l/h	50 -115 hp

RACOR

new

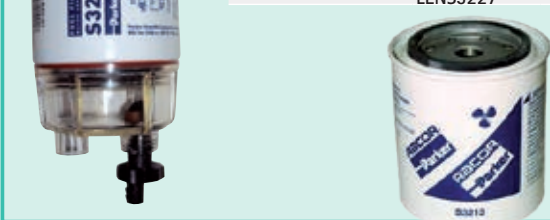

MERCURY

RECAMBIOS MARINOS

FILTRO CON BOMBA CEBADORA

FILTER WITH PRIMMING PUMP

FILTRO CON PEMPETA PER RIEMPIRE

FILTRE A ESSENCE AVEC POMPE D'AMORCAGE



REF	R.O. OEM		MICRON			
RAC490R-RAC-01	8M0097838	RACS3227 LENS3227	10	340 l/h	3/8" NPTF	150 hp



LLAVES PARA FILTRO

FILTER KEY

CHIAVE DA FILTRO

CLÉ À FILTRE

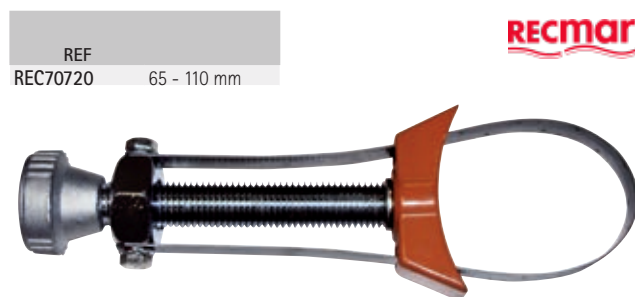

RACOR DE LATÓN

RACOR MADE IN BRASS

RACCORDO IN OTTONE

RACCORD EN LAITON



REF			
GS31065	1/4" NPT	3/8" = 9.5 mm	1
GS31166	1/4" NPT	5/16" = 7.9 mm	2
GS31155	3/8" NPT	3/8" = 9.5 mm	2
GS31156	3/8" NPT	5/16" = 7.9 mm	2
GS31157	3/8" NPT	1/4" = 6.4 mm	2



REF	R.O. OEM			
GS31066	22-89771Q2	1/4" NPT	5/16" = 7.9 mm	2
GS31067	22-34982	1/4" NPT	3/8" = 9.5 mm	2

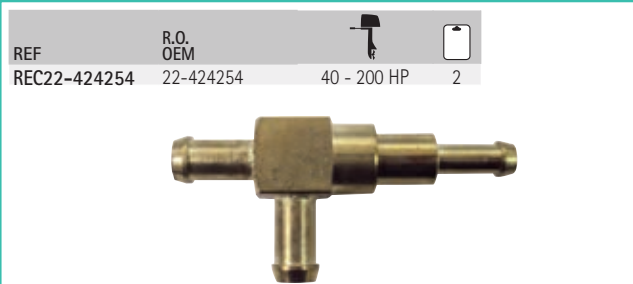

new

VÁLVULA

CHECK VALVE

VALVOLA

SOUPAPE

REF	R.O. OEM	
REC22-8189941	22-8189941	60 - 275 HP



**FILTRO COMBUSTIBLE
PARA MONTAJE EN LINEA**

IN-LINE FUEL FILTER

REF					GOLDENSHIP
GS31001	50 l/h	6-8 mm	plástico plastic	1	
GS31002	150 l/h	8-10 mm	plástica plastique	1	



GS31001



GS31002

REF			
GS30435	6, 8, 10 mm	metal + cristal metal + crystal metallo + cristallo métal + cristal	1

GOLDENSHIP



REF	OEM			
REC40145	35-816296Q03	1/4"	1/4"	plástico
REC40155	35-816296Q02	5/16"	5/16"	plastic
REC40165		3/8"	3/8"	plástica
REC40135		5/16"	3/8"	plastique



REF	OEM		2T STROKES	4T STROKES
REC35-879885T	35-879885T			✓

135/150/175 HP Verado (1B227000+)
200/225 HP Verado (OT980000+)
250/275/300 HP Verado (OT801000+)
30HP - 115HP EFI



REF	OEM		2T STROKES	4T STROKES
REC35-877565T	35-877565T1			✓

25HP (1998+)
30HP 3cyl. (1999-01)
40HP (1998-01)
40HP 4cyl. (2001-02)
40 Carb. 3Cyl. (2002+)
50HP 4cyl. (2001-02)
60HP - 75HP (2000+)
90HP (2000+)



**FILTRO BENZINA PER
MONTARE IN LINEA**

**FILTRE A ESSENCE EN
LIGNE**

REF	OEM			2T STROKES	4T STROKES
REC35-80365M	35-80365M	6 mm		✓	✓
			2 - 8 HP		
			8 - 15 HP		
PAF4-05000300	35-16248			✓	✓
			4 - 9.8 HP		
			4 - 25 HP		



REF	OEM		2T STROKES	4T STROKES
REC16910-GB2-005	35-8M0157133		✓	✓

4, 5 HP (1999+)
4, 5, 6 HP (1999+)
8, 9, 9 HP (2005+)
15, 20 HP 351cc(2008+)



REF	OEM		2T STROKES	4T STROKES
REC6C5-24251-00	35-892758001		✓	✓

75, 80, 90, 100 HP
EFI



REF	OEM		2T STROKES	4T STROKES
REC65L-24563-00	35-888289T2		✓	✓

75, 90 HP (2000+)
115, 225 HP EFI (2001+)



REF	OEM		2T STROKES	4T STROKES
REC68V-24563-00	881540		✓	✓

75, 80, 90 HP
80, 90, 100, 115 HP EFI



REF	OEM		2T STROKES	4T STROKES
REC35-8M0149607	35-8M0149607		✓	✓

30 - 60 HP
EFI



MERCURY

RECAMBIOS
MARINOS

REF	OEM		2T STROKES	4T STROKES
RAC31871	35-884380T	Verados		
REC35-8M0122423	35-8M0020349	75, 90, 115 DFI 3 cyl	✓	✓
	8M0060041	200 HP DFI		
	8M0122423	225 HP DFI incl. 3.0L DFI		



REF	OEM		2T STROKES	4T STROKES
REC69J-24502-00	35-888279001	75 - 100 HP EFI		✓



new

REF	OEM		2T STROKES	4T STROKES
REC6C5-13915-00	35-881323001	75 100 HP EFI		✓



REF	OEM		2T STROKES	4T STROKES
REC69J-24501-10	35-888279	225 EFI 0T653945+		✓

Filtros baja presión VST
Fuel filter low pressure VST
Filtro bassa pressione VST
Filtre basse presure VST

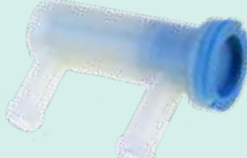

new

REF	OEM		2T STROKES	4T STROKES
REC35-87946Q04	35-87946Q3 35-87946Q04	6 HP - 60 HP		✓



REF	OEM		2T STROKES	4T STROKES
PAF15-07080000	35-826964T 35-879884T	8K, 15K, 25K, 40K 25 / 30 EFI		



REF	R.O. OEM		2T STROKES	4T STROKES
REC35-8M0134466	35-8M0134466 35-8M0088825 35-853733T03 35-853733T02 35-853733A2 35-898101T68	9.9, 10, 15, 20 HP EFI		✓
REC35-8M0088825	35-8M0117705 35-8M0101436	9.9 - 50 HP	✓	✓
REC6D8-WS24A-00	8M0106635	75, 80, 90, 100, 115 HP		✓
REC35-8M0106635		175-300 HP V6 Et V8		✓



REC6D8-WS24A-00



REC35-8M0106635



REC35-8M0134466



REC35-8M0088825

new

CARBURADOR

CARBURATOR

CARBURATORI

FILTRE DE CARBURATEUR

REF	OEM	
REC1399-3938	1399-3938	AJ, KA, KB, KC, KD, WM, WMC



FILTRO VST

VST FILTER

FILTRO VST

FILTRE VST

new



REF	OEM		2T STROKES	4T STROKES
REC68V-13915-00	35-881323T	115 EFI (OT178500- OT801000) (1B226999- 1B366822) 225 EFI (OT653945+)		

REF	OEM		2T STROKES	4T STROKES
REC66K-13915-00	808504 808504T1	150 - 250HP EFI Sport Jet 240		✓





FILTRO DE AIRE

AIR FILTER

FILTRO ARIA

FILTRE À AIR

REF	OEM	
REC35-853333T	35-853333T	115 DFI (2000) 130 DFI (1998+) 150 DFI (1998+) 175 DFI (2001+) 200 DFI (1998-02) 225 DFI (1998-02)



REF	OEM	
REC35-896247	35-896247	135, 150, 175 HP Verado (1B227000+)



REF	OEM	
RM35-8M0082911	35-897575T01 35-897575T02	75, 80, 90, 100, 115 EFI



new

REF	OEM	
REC35-893318T02	35-893318T02	L-6 VERADO



FILTRO DE ACEITE

OIL FILTER

FILTRO OLIO

FILTRE A HUILE

REF	OEM	
REC35-822626Q03	35-822626Q1	8 HP (2001-04) 323cc
	35-822626Q03	9.9 HP (1999-04) 323cc
		13.5 HP / 15 HP (1998+) 323cc
		15 HP
		20 HP (2008+) 492cc
		30 HP (2006+) 492cc



REF	OEM	
REC35-896546T	35-896546T	Verado 4L
	35-877767K01	135, 150, 175, 200 (1B227000+)
	35-877767Q01	



REF	OEM	
REC6G8-13440-00	35-825467T02	9.9 HP S/N (0H00058-0H017099) (1995-98)
	35-825467T1	8 HP (BONDENSEE)
	35-825467A1	9.9 HP 232 cc



REF	OEM		2T STROKES	4T STROKES
REC35-8M0123025	35-8M0123025	175 - 300 HP V6 (3.4L) V8 (4.6L)		✓



new

REF	OEM	
REC35-822626Q04	35-822626Q2	25 HP (1998-05) 498cc
	35-822626Q04	30 HP (1999-05) 747cc
	8M0065103	40/50/60 HP (1995+)
		75/90 HP Carbured (2000-05)
		100/115EFI (1B366822+)



REF	OEM	
REC35-883701K01	35-883701K01	VERADO 6L
	35-877769Q01	200, 225, 250, 275, 300 HP



REF	OEM		2T STROKES	4T STROKES
REC35-877761Q01	35-877761Q01	75, 80, 90, 115 HP (1B366823+) (2006+) 150 HP EFI		✓
	35-877761K01			



REF	OEM	
REC35-822626Q15	35-822626T7	225 HP EFI
	35-822626Q15	NOT VERADO



GUÍA FILTROS DE ACEITE

OIL FILTER GUIDE

GUIDA FILTRO OLIO

GUIDE DES FILTRES À HUILE

	REF
8 - 30HP (2006 +)	REC35-822626Q03
25 HP (2006-) 30 to 115HP (1998+)	REC35-822626Q04
225HP V6	REC35-822626Q15
75/90/115HP 1.731cc (1B366823-2B094995) & 150HP EFI	REC35-877761Q01
135/150/175/200HP VERADO 4 CYL IN-LINE	REC35-896546T
200/225/250/275/300HP VERADO 6 CYL IN-LINE	REC35-883701K01

TAPÓN CARTER

OIL PAN CAP

TAPPO COPPA L'OLIO

BOUCHON CARTER



PAF15-04000002



PAF15-04000003

new

REF	OEM			2T STROKES	4T STROKES
PAF15-04000002	19-825953	75 - 225 HP	M4 X 12		✓
PAF15-04000003	27-8886586				

REF	OEM	
REC26-888593	26-888593	VERADO
REC27-828816	27-828816	8 - 115 HP



REC26-888593



REC27-828816

new

GUÍA FILTRACIÓN EFI

EFI FILTRATION APPLICATION

GUIDE FILTRAZIONE EFI

GUIDE FILTRATION EFI

	CYL	FILTRO ACEITE OIL FILTRE FILTRO OLIO FILTRE A HUILE	FILTRO COMBUSTIBLE FUEL FILTRE FILTRO COMBUSTIBILE FILTRE A CARBURANT		
				HIGH PRESS	
10 EFI, 15 EFI, 15EFI SEAPRO 20EFI		OR832820 +	REC35-822626Q03	REC35-8M0134466	
25 EFI		OR106966 +	REC35-822626Q03	REC35-8M0088825	
30 EFI		OP153500 - OP400999	REC35-822626Q04	REC35-8M0149607	REC35-879885T
30 EFI		OR106999 +	REC35-822626Q03	REC35-8M0088825	
30 EFI		OT409000 - 1B226999	REC35-822626Q04	REC35-8M0149607	REC35-879885T
30 EFI		1C109093 - 1C456299	REC35-822626Q04	REC35-8M0149607	REC35-879885T
30 EFI		1C456300 +	REC35-822626Q04	REC35-8M0149607	REC35-879885T
40 EFI		OP153500 - OP400999	REC35-822626Q04	REC35-8M0149607	REC35-879885T
40 EFI		OP401000 - OP515896	REC35-822626Q04	REC35-8M0149607	REC35-879885T
40 EFI		OP409000 - 1B226999	REC35-822626Q04	REC35-8M0149607	REC35-879885T
40 EFI		1B227000 - 1B355027	REC35-822626Q04	REC35-8M0149607	REC35-879885T
40 EFI		1C000001 - 1C043416	REC35-822626Q04	REC35-8M0149607	REC35-879885T
40 EFI		1C043417 - 1C456299	REC35-822626Q04	REC35-8M0149607	REC35-879885T
40 EFI		1C456300 +	REC35-822626Q04	REC35-8M0149607	REC35-879885T
40 EFI		OP153500 - OP400999	REC35-822626Q04	REC35-8M0149607	REC35-879885T
40 EFI		OP401000 - OP515896	REC35-822626Q04	REC35-8M0149607	REC35-879885T
40EFI		OP515897 - OP580772	REC35-822626Q04	REC35-8M0149607	REC35-879885T
40 EFI		OT409000 - 1B355222	REC35-822626Q04	REC35-8M0149607	REC35-879885T
40 EFI		1C000001 - 1C050251	REC35-822626Q04	REC35-8M0149607	REC35-879885T
40 EFI		1C050252 - 1C453839	REC35-822626Q04	REC35-8M0149607	REC35-879885T
40 EFI & SEAPRO		1C453840 +	REC35-822626Q04	REC35-8M0149607	REC35-879885T
50 EFI		OP153500 - OP400999	REC35-822626Q04	REC35-8M0149607	REC35-879885T
50 EFI		OP401000 - OP515896	REC35-822626Q04	REC35-8M0149607	REC35-879885T
50 EFI		OP515897 - OP580772	REC35-822626Q04	REC35-8M0149607	REC35-879885T
50 EFI		OT409000 - 1B355222	REC35-822626Q04	REC35-8M0149607	REC35-879885T
50 EFI		1C000001 - 1C050251	REC35-822626Q04	REC35-8M0149607	REC35-879885T
50 EFI		1C050252 - 1C453839	REC35-822626Q04	REC35-8M0149607	REC35-879885T
50 EFI		1C453840 +	REC35-822626Q04	REC35-8M0149607	REC35-879885T
60 EFI		OP153500 - OP400999	REC35-822626Q04	REC35-8M0149607	REC35-879885T
60 EFI		OP401000 - OP515896	REC35-822626Q04	REC35-8M0149607	REC35-879885T
60 EFI		OP515897 - OP580772	REC35-822626Q04	REC35-8M0149607	REC35-879885T
60 EFI		OT409000 - 1B355222	REC35-822626Q04	REC35-8M0149607	REC35-879885T
60 EFI		1C000001 - 1C050251	REC35-822626Q04	REC35-8M0149607	REC35-879885T
60 EFI		1C050252 - 1C453839	REC35-822626Q04	REC35-8M0149607	REC35-879885T
60 EFI & SEAPRO		1C453840 +	REC35-822626Q04	REC35-8M0149607	REC35-879885T
75 EFI		1B172291 - 1B366822	REC35-822626Q04	REC68V-24563-00 REC6D8-WS24A-00	REC69J-24502-00 REC6C5-24251-00
75 EFI		1B366823 - 2B094995	REC35-877761Q01		REC35-879885T
75 EFI & SEAPRO		2B095049 +	REC35-822626Q04		REC35-879885T
80 EFI		OP459572 - 2B094995	REC35-877761Q01		REC35-879885T
80 EFI		1B227000 - 1B366822	REC35-822626Q04	REC68V-24563-00 REC6D8-WS24A-00	REC69J-24502-00 REC6C5-24251-00
80 EFI		1B366823 - 2B094995	REC35-877761Q01		REC35-879885T
80 EFI		2B095049 +	REC35-822626Q04		REC35-879885T
90 EFI		1B172291 - 1B366822	REC35-822626Q04	REC68V-24563-00 REC6D8-WS24A-00	REC69J-24502-00 REC6C5-24251-00
90 EFI		1B366823 - 2B094995	REC35-877761Q01		REC35-879885T
90 EFI & SEAPRO		2B095049 +	REC35-822626Q04		REC35-879885T
100 EFI		OP459572 - 2B094995	REC35-877761Q01		REC35-879885T
100 EFI		1B227000 - 1B366822	REC35-822626Q04	REC68V-24563-00 REC6D8-WS24A-00	REC69J-24502-00 REC6C5-24251-00
100 EFI		1B366823 - 2B094995	REC35-877761Q01		REC35-879885T
100 EFI		2B095049 +	REC35-822626Q04		REC35-879885T

MERCURY

RECAMBIOS MARINOS

			CYL	FILTRO ACEITE	FILTRO COMBUSTIBLE	HIGH PRESS
				OIL FILTER FILTRO OLIO FILTRE A HUILE	FUEL FILTER FILTRO COMBUSTIBLE FILTRE A CARBURANT	
115 EFI	OT178500 - OT800999	USA	4	REC35-822626Q04	REC68V-24563-00 REC6D8-WS24A-00	
115 EFI	OT801000 - 1B226999	USA	4	REC35-822626Q04	REC68V-24563-00 REC6D8-WS24A-00	
115 EFI	1B227000 - 1B366822	USA	4	REC35-822626Q04	REC68V-24563-00 REC6D8-WS24A-00	
115 EFI	1B366823 - 2B094995	USA	4	REC35-877761Q01		REC35-879885T
115 EFI Et SEAPRO (XS)	2B095049 +		4	REC35-822626Q04		REC35-879885T
135	2B131942 +		4	REC35-877761Q01		REC35-879885T
135 VERADO	OP419487 - OP464487	BEL	4	REC35-896546T	REC35-8M0122423	REC35-879885T
135 VERADO	OP464488 - OP514868	BEL	4	REC35-896546T	REC35-8M0122423	REC35-879885T
135 VERADO	OP514869 - OP593020	BEL	4	REC35-896546T	REC35-8M0122423	REC35-879885T
135 VERADO	1B227000 - 1B381711	USA	4	REC35-896546T	REC35-8M0122423	REC35-879885T
135 VERADO	1B381712 - 1B517158	USA	4	REC35-896546T	REC35-8M0122423	REC35-879885T
135 VERADO	1B517159 - 2B576734	USA	4	REC35-896546T	REC35-8M0122423	REC35-879885T
150	1B905505 +		4	REC35-877761Q01		REC35-879885T
150 SEAPRO	2B139139 +		4	REC35-877761Q01		REC35-879885T
150 Pro XS	2B550139 +		4	REC35-877761Q01		REC35-879885T
150 VERADO	OP419487 - OP464487	BEL	4	REC35-896546T	REC35-8M0122423	REC35-879885T
150 VERADO	OP464488 - OP514868	BEL	4	REC35-896546T	REC35-8M0122423	REC35-879885T
150 VERADO	OP514869 - OP593020	BEL	4	REC35-896546T	REC35-8M0122423	REC35-879885T
150 VERADO	1B227000 - 1B381711	USA	4	REC35-896546T	REC35-8M0122423	REC35-879885T
150 VERADO	1B381712 - 1B517158	USA	4	REC35-896546T	REC35-8M0122423	REC35-879885T
150 VERADO	1B517159 - 2B576734	USA	4	REC35-896546T	REC35-8M0122423	REC35-879885T
175 VERADO	OP419487 - OP464487	BEL	4	REC35-896546T	REC35-8M0122423	REC35-879885T
175 VERADO	OP464488 - OP514868	BEL	4	REC35-896546T	REC35-8M0122423	REC35-879885T
175 VERADO	OP514869 - OP593020	BEL	4	REC35-896546T	REC35-8M0122423	REC35-879885T
175 VERADO	1B227000 - 1B381711	USA	4	REC35-896546T	REC35-8M0122423	REC35-879885T
175 VERADO	1B381712 - 1B517158	USA	4	REC35-896546T	REC35-8M0122423	REC35-879885T
175 VERADO	1B517159 - 2B576734	USA	4	REC35-896546T	REC35-8M0122423	REC35-879885T
175 (3.4L) V6 Et Pro XS	2B529482 +	USA	6	REC35-8M0123025		REC35-8M0106635
200 VERADO	OP514869 - OP593020	BEL	4	REC35-896546T	REC35-8M0122423	REC35-879885T
200 VERADO	1B517159 - 2B576734	USA	4	REC35-896546T	REC35-8M0122423	REC35-879885T
200 VERADO	OP409357 - OP464487	BEL	6	REC35-883701K01	REC35-8M0122423	REC35-879885T
200 VERADO	OP464488 - OP520552	BEL	6	REC35-883701K01	REC35-8M0122423	REC35-879885T
200 VERADO	OP520553 - 2B144122	BEL	6	REC35-883701K01	REC35-8M0122423	REC35-879885T
200 VERADO	OT980000 - 1B226999	USA	6	REC35-883701K01	REC35-8M0122423	REC35-879885T
200 VERADO	1B227000 - 1B381711	USA	6	REC35-883701K01	REC35-8M0122423	REC35-879885T
200 VERADO	1B381712 - 1B517433	USA	6	REC35-883701K01	REC35-8M0122423	REC35-879885T
200 VERADO	1B517434 - 2B144122	USA	6	REC35-883701K01	REC35-8M0122423	REC35-879885T
200 VERADO	2B144123 - 2B578935	USA	6	REC35-883701K01	REC35-8M0122423	REC35-879885T
200 Pro VERADO	2B034840 - 2B144122		6	REC35-883701K01	REC35-8M0122423	REC35-879885T
200 Pro VERADO	2B144123 - 2B577715		6	REC35-883701K01	REC35-8M0122423	REC35-879885T
200 (3.4L) V6 Et SEAPRO	2B529482 +	USA	6	REC35-8M0123025		REC35-8M0106635
200 (4.6L) V8 PRO XS	2B529482 +	USA	8	REC35-8M0123025		REC35-8M0106635
225 EFI	OT653945 +	USA	6	REC35-822626Q15	REC65L-24563-00	REC69J-24501-10
225 VERADO	OP409357 - OP464487	BEL	6	REC35-883701K01	REC35-8M0122423	REC35-879885T
225 VERADO	OP464488 - OP520552	BEL	6	REC35-883701K01	REC35-8M0122423	REC35-879885T
225 VERADO	OP520553 - 2B144122	BEL	6	REC35-883701K01	REC35-8M0122423	REC35-879885T
225 VERADO	OT980000 - 1B226999	USA	6	REC35-883701K01	REC35-8M0122423	REC35-879885T
225 VERADO	1B227000 - 1B381711	USA	6	REC35-883701K01	REC35-8M0122423	REC35-879885T
225 VERADO	1B381712 - 1B517433	USA	6	REC35-883701K01	REC35-8M0122423	REC35-879885T
225 VERADO	1B517434 - 2B144122	USA	6	REC35-883701K01	REC35-8M0122423	REC35-879885T
225 VERADO	2B144123 - 2B578935	USA	6	REC35-883701K01	REC35-8M0122423	REC35-879885T
225 (3.4L) V6 Et SEAPRO	2B529482 +	USA	6	REC35-8M0123025		REC35-8M0106635
225 (4.6L) V8 PRO XS	2B529482 +	USA	8	REC35-8M0123025		REC35-8M0106635
250 VERADO	OP409357 - OP464487	BEL	6	REC35-883701K01	REC35-8M0122423	REC35-879885T
250 VERADO	OP464488 - OP520552	BEL	6	REC35-883701K01	REC35-8M0122423	REC35-879885T
250 VERADO	OP520553 - 2B144122	BEL	6	REC35-883701K01	REC35-8M0122423	REC35-879885T
250 VERADO	OT980000 - 1B226999	USA	6	REC35-883701K01	REC35-8M0122423	REC35-879885T
250 VERADO	1B227000 - 1B381711	USA	6	REC35-883701K01	REC35-8M0122423	REC35-879885T
250 VERADO	1B381712 - 1B517433	USA	6	REC35-883701K01	REC35-8M0122423	REC35-879885T
250 VERADO	1B517434 - 2B144122	USA	6	REC35-883701K01	REC35-8M0122423	REC35-879885T
250 VERADO	2B144123 - 2B578935	USA	6	REC35-883701K01	REC35-8M0122423	REC35-879885T
250 PRO VERADO	1B830170 - 2B144122		6	REC35-883701K01	REC35-8M0122423	REC35-879885T
250 PRO VERADO	2B144123 - 2B577715	USA	6	REC35-883701K01	REC35-8M0122423	REC35-879885T
250 (4.6L) V8, VERADO, SEAPRO Et PRO XS	2B529482 +	USA	8	REC35-8M0123025		REC35-8M0106635
250 (4.6L) V8 RACING	1E080500+	USA	8	REC35-8M0123025		REC35-8M0106635
275 VERADO	OP409357 - OP464487	BEL	6	REC35-883701K01	REC35-8M0122423	REC35-879885T
275 VERADO	OP464488 - OP520552	BEL	6	REC35-883701K01	REC35-8M0122423	REC35-879885T
275 VERADO	OP520553 - 2B144122	BEL	6	REC35-883701K01	REC35-8M0122423	REC35-879885T
275 VERADO	OT980000 - 1B226999	USA	6	REC35-883701K01	REC35-8M0122423	REC35-879885T
275 VERADO	1B227000 - 1B381711	USA	6	REC35-883701K01	REC35-8M0122423	REC35-879885T
275 VERADO	1B381712 - 1B517433	USA	6	REC35-883701K01	REC35-8M0122423	REC35-879885T
275 VERADO	1B517434 - 2B144122	USA	6	REC35-883701K01	REC35-8M0122423	REC35-879885T
275 VERADO	2B144123 - 2B578935	USA	6	REC35-883701K01	REC35-8M0122423	REC35-879885T

			CYL	FILTRO ACEITE	FILTRO COMBUSTIBLE
				OIL FILTER FILTRO OLIO FILTRE A HUILE	FUEL FILTER FILTRO COMBUSTIBILE FILTRE A CARBURANT
					HIGH PRESS
300 VERADO	0P520553 - 2B144122	BEL	6	REC35-883701K01	REC35-8M0122423
300 VERADO	1B517434 - 2B144122	USA	6	REC35-883701K01	REC35-8M0122423
300 VERADO	2B144123 - 2B578935	USA	6	REC35-883701K01	REC35-8M0122423
300 PRO VERADO	1B830170 - 2B144122		6	REC35-883701K01	REC35-8M0122423
300 PRO VERADO	2B144123 - 2B577715	USA	6	REC35-883701K01	REC35-8M0122423
300 (4.6L) V8, VERADO, SEAPRO et PRO XS	2B529482 +	USA	8	REC35-8M0123025	REC35-8M0106635
300 (4.6L) V8 RACING	1E080500+	USA	8	REC35-8M0123025	REC35-8M0106635
350ScI VERADO	1B716557 - 2B143542		6	REC35-883701K01	REC35-879885T
350 2.6L L6 VERADO	2B141617 +	USA	6	REC35-883701K01	REC35-8M0122423
350 2.6L L6 PRO VERADO	2B141124 +	USA	6	REC35-883701K01	REC35-8M0122423
400 2.6L L6 VERADO	2B618256 +	USA	6	REC35-883701K01	REC35-8M0122423
400R 2.6L L6 RACING	2B141124 +	USA	6	REC35-883701K01	REC35-8M0122423
450 4.6L V8 RACING	2B529482 +	USA	8	REC35-8M0123025	REC35-8M0106635

ACEITE OIL OLIO HUILE

REF	1 L	5 L	6	3	2 STROKES
REC2TU6	1 L	5 L	6	3	2 STROKES
REC2TU3	1 L	5 L	6	3	TC-W3
REC5W40U6	1 L	5 L	6	3	SAE 5W40
REC5W40U3	1 L	5 L	6	3	SAE 5W40
REC10W30U6	1 L	5 L	6	3	SAE 10W30
REC10W30U3	1 L	5 L	6	3	SAE 10W30
REC25W40U3	1 L	5 L	6	3	SAE 25W40

REF	OEM	1 L	3,8 L	6	3	2 STROKES
RM92-858026QB1U6	92-858026QB1	1 L	3,8 L	6	3	2 STROKES
RM92-858027QB1U3	92-858027QB1	1 L	3,8 L	6	3	SAE 10W30
RM92-8M0086220U6	92-8M0086220	1 L	3,8 L	6	3	SAE 10W30
RM92-8M0086221U3	92-8M0086221	1 L	3,8 L	6	3	SAE 10W30

RM92-858026QB1U6 RM92-858027QB1U3 RM92-8M0086220U6 RM92-8M0086221U3

GUÍA DE ACEITE OIL GUIDE GUIDA OLIO GUIDE DES HUILES

	SAE 10W30 MINERAL	SAE 10W30 SYNTHETIC	SAE 25W40 MINERAL	SAE 25W40 SYNTHETIC
2.5 --> 9.9	RM92-8M0086221U3	REC10W30U3	RM92-8M0086224U3 REC25W40U3 SS	RM92-8M0086227U3
15 --> 60	RM92-8M0086221U3	REC10W30U3	RM92-8M0086224U3 REC25W40U3 SS	RM92-8M0086227U3
Non Sea Pro	75 --> 115 (1.7L) 75 --> 115 (2.1L)	RM92-8M0086221U3 REC10W30U3	RM92-8M0086224U3 REC25W40U3 SS	RM92-8M0086227U3
150	RM92-8M0086221U3	REC10W30U3	RM92-8M0086224U3 REC25W40U3 SS	RM92-8M0086227U3
Sea Pro	15 --> 115	RM92-8M0086221U3 REC10W30U3	RM92-8M0086224U3 REC25W40U3 SS	RM92-8M0086227U3
Verado			RM92-8M0086224U3 REC25W40U3 SS	RM92-8M0086227U3
Four Stroke	RM92-8M0086221U3	REC10W30U3	RM92-8M0086224U3 REC25W40U3 SS	RM92-8M0086227U3
3.4L V6 4.6L V8	Sea Pro	RM92-8M0086221U3 REC10W30U3	RM92-8M0086224U3 REC25W40U3 SS	RM92-8M0086227U3
	ProXS	RM92-8M0086221U3 REC10W30U3	RM92-8M0086224U3 REC25W40U3 SS	RM92-8M0086227U3

Mejor opción | Best option | Opzione migliore | Meilleur choix
 TEMP <0°
 Semi Sintético | Semi Synthetic | Semi Sintetico | Semi-synthétique

BOMBA DE COMBUSTIBLE

FUEL PUMP

POMPA BENZINA

POMPE À ESSENCE

BOMBA DE COMBUSTIBLE MECÁNICA

FUEL PUMP MECHANICAL

POMPA BENZINA MECCANICA

POMPE À ESSENCE MECANIQUE



REF	OEM	STROKES	2T	4T
REC803529T06	803529T06 803529T03 802529T02 803529T1 803529T	4, 5, 6 HP USA (0R067090+ BEL (0P401000 - 0R411837)	✓	

REF	OEM	STROKES	2T	4T
PAF15-07140000	835389A2 835389T1 835389T02	8 (BODENSEE) 15, 13.5 Inter., 9.9 (323 cc)	✓	



REF	OEM	STROKES	2T	4T
REC692-24410-00	43113M 43113T	15 20C, 25C (Thru prop. exhaust) 30A 40 (Twin Carb) (W/oil injection) (w/auto-blend) 55, W-55	✓	



REF	OEM	STROKES	2T	4T
PAF40-05050000	881862T1 881862T07 892874T 8M0141844 899106T 8M0118176	25, 30, 40 HP PAGB/T3452.1-25X3.0	✓	



REF	OEM	STROKES	2T	4T
REC14360T74	14360T74	75, 90, 115 HP DFI (1.5L) 200, 225, 250, 300 HP DTS/DFI	✓	

REF	OEM	STROKES	2T	4T
PAF25-05130000	826398T3	25-60 HP	✓	



REF	OEM	STROKES	2T	4T
REC899106T01	899106T01 892874T01 808505T 827682T	30, 40 HP EFI (3 cyl) 40, 50, 60 HP EFI (4 cyl)	✓	



REF	OEM	STROKES	2T	4T
REC68V-24410-00	880890T1 880890A02 8M0091468	75 HP (0T409000+) 75 Bodensee (0T40900+) 90 HP (0T409000+) 115 EFI (0T178500 - 1B366822)	✓	



REF	OEM		2T STROKES	4T STROKES
REC14360T77	14360T77		200, 225 DFI, DTS (0T800999 - 1B417701)	✓

new



GUÍA BOMBA DE COMBUSTIBLE MECÁNICA

GUIDE, FUEL PUMP MECHANICAL

		CYL	
10 EFI			
15 EFI, 15EFI SEAPRO	0R832820 +	2	
20EFI			
25 EFI	OR106966 +	3	
30 EFI	OP153500 - OP400999	3	REC899106T01
30 EFI	OR106999 +	3	
30 EFI	OT409000 - 1B226999	3	REC899106T01
30 EFI	1C109093 - 1C456299	3	REC899106T01
30 EFI	1C456300 +	3	REC899106T01
40 EFI	OP153500 - OP400999	BEL 3	REC899106T01
40 EFI	OP401000 - OP515896	BEL 3	REC899106T01
40 EFI	OP409000 - 1B226999	USA 3	REC899106T01
40 EFI	1B227000 - 1B355027	USA 3	REC899106T01
40 EFI	1C000001 - 1C043416	3	REC899106T01
40 EFI	1C043417 - 1C456299	3	REC899106T01
40 EFI	1C456300 +	3	REC899106T01
40 EFI	OP153500 - OP400999	BEL 4	REC899106T01
40 EFI	OP401000 - OP515896	BEL 4	REC899106T01
40 EFI	OP409000 - 1B226999	USA 4	REC899106T01
40EFI	OP515897 - OP580772	BEL 4	REC899106T01
40 EFI	OT409000 - 1B355222	USA 4	REC899106T01
40 EFI	1C000001 - 1C050251	USA 4	REC899106T01
40 EFI	1C050252 - 1C453839	USA 4	REC899106T01

GUIDA POMPA BENZINA MECCANICA

GUIDE POMPE À ESSENCE MECANIQUE

		CYL	
40 EFI Et SEAPRO	1C453840 +	USA 4	REC899106T01
50 EFI	OP153500 - OP400999	BEL 4	REC899106T01
50 EFI	OP401000 - OP515896	BEL 4	REC899106T01
50 EFI	OP515897 - OP580772	BEL 4	REC899106T01
50 EFI	OT409000 - 1B355222	USA 4	REC899106T01
50 EFI	1C000001 - 1C050251	USA 4	REC899106T01
50 EFI	1C050252 - 1C453839	USA 4	REC899106T01
50 EFI	1C453840 +	USA 4	REC899106T01
60 EFI	OP153500 - OP400999	BEL 4	REC899106T01
60 EFI	OP401000 - OP515896	BEL 4	REC899106T01
60 EFI	OP515897 - OP580772	BEL 4	REC899106T01
60 EFI	OT409000 - 1B355222	USA 4	REC899106T01
60 EFI	1C000001 - 1C050251	USA 4	REC899106T01
60 EFI	1C050252 - 1C453839	USA 4	REC899106T01
60 EFI Et SEAPRO	1C453840 +	USA 4	REC899106T01
75 EFI	1B172291 - 1B366822	USA 4	REC68V-24410-00
80 EFI	1B227000 - 1B366822	USA 4	REC68V-24410-00
90 EFI	1B172291 - 1B366822	USA 4	REC68V-24410-00
100 EFI	1B227000 - 1B366822	USA 4	REC68V-24410-00
115 EFI	OT178500 - OT800999	USA 4	REC68V-24410-00
115 EFI	OT801000 - 1B226999	USA 4	REC68V-24410-00
115 EFI	1B227000 - 1B366822	USA 4	REC68V-24410-00

BOMBA DE COMBUSTIBLE ELECTRICA

FUEL PUMP ELECTRIC

REF	OEM		2T STROKES	4T STROKES
REC898101T67	898101T67		25, 30 HP EFI 3 CYL	✓







REF	OEM		2T STROKES	4T STROKES
REC883202T02	883202T02 883202A02		30, 40, 50, 60 HP EFI 3 Et 4 CYL.	✓





POMPA BENZINA ELETTRICA



POMPE À ESSENCE ELECTRIQUE

REF	OEM		2T STROKES	4T STROKES
REC880596T55	880596T55		75, 80, 90, 100, 115 EFI	✓
REC880596T58	880596T58		135 - 300 HP VERADO	✓

REF	OEM		2T STROKES	4T STROKES
REC63P-13907-03	880889T 80889T01		115 EFI	✓



REF	OEM		2T STROKES	4T STROKES
REC880596T55	881705T1		200, 225, 250 HP 3.0L EFI V-150, V-175, V-200, 2,52 EFI	✓



REF	OEM		2T STROKES	4T STROKES
REC67H-13907-00	809088T1 809088T01 808505T01		V150, V175, V200 HP (EFI) 200, 225 HP EFI ProMax	✓



REF	OEM		2T STROKES	4T STROKES
REC888733T02	888733T02 888733T1		200, 225 DFI 3L	✓



REF	OEM		2T STROKES	4T STROKES
REC14307T01	14307T01 14307A1		V150, V175, V200 (MAG/EFI) 150, 200 EFI PRO/MAX SUPER MA	✓





REF	OEM		2T STROKES	4T STROKES
REC69J-13907-03	888246T 888246T01		225 EFI	✓
REC69J-24410-02	888251T 888251T02			





REF	OEM	2T STROKES	4T STROKES
REC861155A3	861155A3 861155A2	✓	



REF	OEM		2T STROKES	4T STROKES
REC8M0047624	8M0047324 8558432		V135, V150, V175 DFI (2.5L) 200, 250 DFI	✓

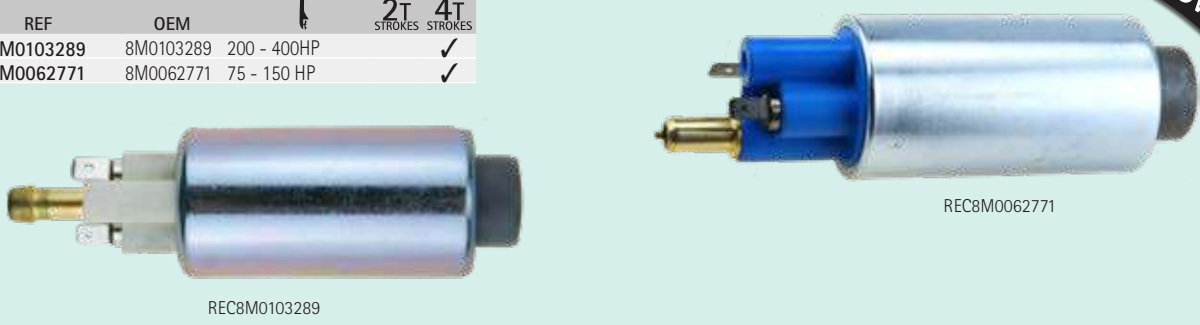

BOMBA DE COMBUSTIBLE BAJA PRESION **FUEL PUMP LOW PRESSURE** **POMPA BENZINA BASSA PRESIONE** **POMPE À ESSENCE BASSE PRESSION**

REF	OEM		2T STROKES	4T STROKES
REC8M0103289	8M0103289		200 - 400HP	✓
REC8M0062771	8M0062771		75 - 150 HP	✓

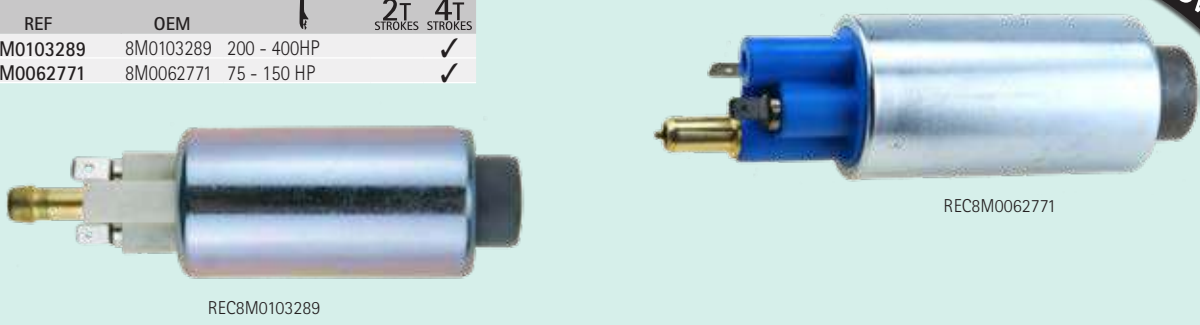

new

**BOMBA DE COMBUSTIBLE
ALTA PRESION**

**FUEL PUMP
HIGH PRESSURE**

**POMPA BENZINA
ALTA PRESIONE**

**POMPE À ESSENCE
HAUTE PRESSION**

REF	OEM		2T STROKES	4T STROKES
REC8M0134464	8M0134464		9.9, 10, 15, 20 HP EFI	
REC8M0062770	8M0062770		65 - 150 HP	✓
REC880596T60	880596T60		135, 150, 175, 200 HP VERADO (4 cyl)	✓
REC8M0103288	8M0103288		150 - 400 HP	✓



new

GUÍA VST

VST GUIDE

GUIDA VST

GUIDE VST

	SERIE	CYL	BOMBA ELECT. ALTA ELECT. FUEL PUMP HIGH POMPA ELECT. ALTA POMPE ELECT. HAUTE	BOMBA ELECT. BAJA ELECT. FUEL PUMP LOW POMPA ELECT. BASSA POMPE ELECT. BASSE	JUNTA VST VST GASKET GUARNIZIONE VST JOINT VST	FILTRO VST VST FILTRE FILTRU VST FILTRE VST	FLOTADOR VST VST FLOAT GALLEGGIANTE VST FLOTEUR VST
10 EFI, 15 EFI, 15EFI SEAPRO, 20EFI	OR832820 +	2	REC8M0134464		REC27-8M0135597		
25 EFI	OR106966 +	3	REC898101T67				
30 EFI	OP153500 - OP400999	3	REC883202T02 REC898101T67		REC27-883213 PAF40-05100704EI		
30 EFI	OR106999 +	3	REC898101T67				
30 EFI	OT409000 - 1B226999	3	REC883202T02 REC898101T67		REC27-883213 PAF40-05100704EI	PAF40-05100502EI	
30 EFI	1C109093 - 1C456299	3	REC898101T67		PAF40-05100704EI	PAF40-05100502EI	
30 EFI	1C456300 +	3	REC898101T67		PAF40-05100704EI	PAF40-05100502EI	
40 EFI	OP153500 - OP400999	BEL 3	REC883202T02 REC898101T67		REC27-883213 PAF40-05100704EI	PAF40-05100502EI	
40 EFI	OP401000 - OP515896	BEL 3	REC898101T67		PAF40-05100704EI	PAF40-05100502EI	
40 EFI	OP409000 - 1B226999	USA 3	REC883202T02 REC898101T67		REC27-883213 PAF40-05100704EI	PAF40-05100502EI	
40 EFI	1B227000 - 1B355027	USA 3	REC898101T67		PAF40-05100704EI	PAF40-05100502EI	
40 EFI	1C000001 - 1C043416	3	REC898101T67		PAF40-05100704EI	PAF40-05100502EI	
40 EFI	1C043417 - 1C456299	3	REC898101T67		PAF40-05100704EI	PAF40-05100502EI	
40 EFI	1C456300 +	3	REC898101T67		PAF40-05100704EI	PAF40-05100502EI	
40 EFI	OP153500 - OP400999	BEL 4	REC883202T02 REC898101T67		REC27-883213 PAF40-05100704EI	PAF40-05100502EI	
40 EFI	OP401000 - OP515896	BEL 4	REC898101T67		PAF40-05100704EI	PAF40-05100502EI	
40EFI	OP515897 - OP580772	BEL 4	REC898101T67		PAF40-05100704EI	PAF40-05100502EI	
40 EFI	OT409000 - 1B355222	USA 4	REC883202T02 REC898101T67		REC27-883213 PAF40-05100704EI	PAF40-05100502EI	
40 EFI	1C000001 - 1C050251	USA 4	REC898101T67		PAF40-05100704EI	PAF40-05100502EI	
40 EFI	1C050252 - 1C453839	USA 4	REC898101T67		PAF40-05100704EI	PAF40-05100502EI	
40 EFI & SEAPRO	1C453840 +	USA 4	REC898101T67		PAF40-05100704EI	PAF40-05100502EI	
50 EFI	OP153500 - OP400999	BEL 4	REC883202T02 REC898101T67		REC27-883213 PAF40-05100704EI	PAF40-05100502EI	
50 EFI	OP401000 - OP515896	BEL 4	REC898101T67		PAF40-05100704EI	PAF40-05100502EI	
50 EFI	OP515897 - OP580772	BEL 4	REC898101T67		PAF40-05100704EI	PAF40-05100502EI	
50 EFI	OT409000 - 1B355222	USA 4	REC883202T02 REC898101T67		REC27-883213 PAF40-05100704EI	PAF40-05100502EI	
50 EFI	1C000001 - 1C050251	USA 4	REC898101T67		PAF40-05100704EI	PAF40-05100502EI	
50 EFI	1C050252 - 1C453839	USA 4	REC898101T67		PAF40-05100704EI	PAF40-05100502EI	
50 EFI	1C453840 +	USA 4	REC898101T67		PAF40-05100704EI	PAF40-05100502EI	
60 EFI	OP153500 - OP400999	BEL 4	REC883202T02 REC898101T67		REC27-883213 PAF40-05100704EI	PAF40-05100502EI	
60 EFI	OP401000 - OP515896	BEL 4	REC898101T67		PAF40-05100704EI	PAF40-05100502EI	
60 EFI	OP515897 - OP580772	BEL 4	REC898101T67		PAF40-05100704EI	PAF40-05100502EI	
60 EFI	OT409000 - 1B355222	USA 4	REC883202T02 REC898101T67		REC27-883213 PAF40-05100704EI	PAF40-05100502EI	
60 EFI	1C000001 - 1C050251	USA 4	REC898101T67		PAF40-05100704EI	PAF40-05100502EI	
60 EFI	1C050252 - 1C453839	USA 4	REC898101T67		PAF40-05100704EI	PAF40-05100502EI	
60 EFI & SEAPRO	1C453840 +	USA 4	REC898101T67		PAF40-05100704EI	PAF40-05100502EI	
75 EFI	1B172291 - 1B366822	USA 4	REC866169T01		REC68V-14984-00	REC6C5-13915-00	
75 EFI	1B366823 - 2B094995	USA 4	REC880596T55	REC880596T58	REC26-880596502		REC8M6000359



MERCURY



RECAMBIOS
MARINOS



	SERIE	CYL	BOMBA ELECT. ALTA ELECT. FUEL PUMP HIGH POMPA ELECT. ALTA POMPE ELECT. HAUTE	BOMBA ELECT. BAJA ELECT. FUEL PUMP LOW POMPA ELECT. BASSA POMPE ELECT. BASSE	JUNTA VST VST GASKET GUARNIZIONE VST JOINT VST	FILTRO VST VST FILTRE FILTRO VST FILTRE VST	FLOTADOR VST VST FLOAT GALLEGGIANTE VST FLOTEUR VST
75 EFI & SEAPRO	2B095049 +	4	REC8M0062770	REC8M0062771			
80 EFI	0P459572 - 2B094995	BEL 4	REC880596T55	REC880596T58	REC26-880596502		REC8M6000359
80 EFI	1B227000 - 1B366822	USA 4	REC866169T01		REC68V-14984-00	REC6C5-13915-00	
80 EFI	1B366823 - 2B094995	USA 4	REC880596T55	REC880596T58	REC26-880596502		REC8M6000359
80 EFI	2B095049 +	4	REC8M0062770	REC8M0062771			
90 EFI	1B172291 - 1B366822	USA 4	REC866169T01		REC68V-14984-00	REC6C5-13915-00	
90 EFI	1B366823 - 2B094995	USA 4	REC880596T55	REC880596T58	REC26-880596502		REC8M6000359
90 EFI & SEAPRO	2B095049 +	USA 4	REC8M0062770	REC8M0062771			
100 EFI	0P459572 - 2B094995	BEL 4	REC880596T55	REC880596T58	REC26-880596502		REC8M6000359
100 EFI	1B227000 - 1B366822	USA 4	REC866169T01		REC68V-14984-00	REC6C5-13915-00	
100 EFI	1B366823 - 2B094995	USA 4	REC880596T55	REC880596T58	REC26-880596502		REC8M6000359
100 EFI	2B095049 +	USA 4	REC8M0062770	REC8M0062771			
115 EFI	0T178500 - 0T800999	USA 4	REC15200-96J00		REC68V-14984-00	REC68V-13915-00	
115 EFI	0T801000 - 1B226999	USA 4	REC15200-96J00		REC68V-14984-00	REC68V-13915-00	
115 EFI	1B227000 - 1B366822	USA 4	REC15200-96J00		REC68V-14984-00	REC68V-13915-00	
115 EFI	1B366823 - 2B094995	USA 4	REC880596T55	REC880596T58	REC26-880596502		REC8M6000359
115 EFI & SEAPRO (XS)	2B095049 +	4	REC8M0062770	REC8M0062771			
135	2B131942 +	4	REC8M0062770	REC8M0062771			
135 VERADO	0P419487 - 0P464487	BEL 4	REC880596T55	REC880596T58	REC26-880596502		REC8M6000359
135 VERADO	0P464488 - 0P514868	BEL 4	REC880596T55	REC880596T58	REC26-880596502		REC8M6000359
135 VERADO	0P514869 - 0P593020	BEL 4	REC880596T60	REC880596T58	REC26-880596502		REC8M6000359
135 VERADO	1B227000 - 1B381711	USA 4	REC880596T55	REC880596T58	REC26-880596502		REC8M6000359
135 VERADO	1B381712 - 1B517158	USA 4	REC880596T55	REC880596T58	REC26-880596502		REC8M6000359
135 VERADO	1B517159 - 2B576734	USA 4	REC880596T60	REC880596T58	REC26-880596502		REC8M6000359
150	1B905505 +	4	REC8M0062770	REC8M0062771			
150 SEAPRO	2B139139 +	4	REC8M0062770	REC8M0062771			
150 Pro XS	2B550139 +	4	REC8M0103288	REC8M0103289			
150 VERADO	0P419487 - 0P464487	BEL 4	REC880596T55	REC880596T58	REC26-880596502		REC8M6000359
150 VERADO	0P464488 - 0P514868	BEL 4	REC880596T55	REC880596T58	REC26-880596502		REC8M6000359
150 VERADO	0P514869 - 0P593020	BEL 4	REC880596T60	REC880596T58	REC26-880596502		REC8M6000359
150 VERADO	1B227000 - 1B381711	USA 4	REC880596T55	REC880596T58	REC26-880596502		REC8M6000359
150 VERADO	1B381712 - 1B517158	USA 4	REC880596T55	REC880596T58	REC26-880596502		REC8M6000359
150 VERADO	1B517159 - 2B576734	USA 4	REC880596T60	REC880596T58	REC26-880596502		REC8M6000359
175 VERADO	0P419487 - 0P464487	BEL 4	REC880596T55	REC880596T58	REC26-880596502		REC8M6000359
175 VERADO	0P464488 - 0P514868	BEL 4	REC880596T55	REC880596T58	REC26-880596502		REC8M6000359
175 VERADO	0P514869 - 0P593020	BEL 4	REC880596T60	REC880596T58	REC26-880596502		REC8M6000359
175 VERADO	1B227000 - 1B381711	USA 4	REC880596T55	REC880596T58	REC26-880596502		REC8M6000359
175 VERADO	1B381712 - 1B517158	USA 4	REC880596T55	REC880596T58	REC26-880596502		REC8M6000359
175 VERADO	1B517159 - 2B576734	USA 4	REC880596T60	REC880596T58	REC26-880596502		REC8M6000359
175 (3.4L) V6 & Pro XS	2B529482 +	USA 6	REC8M0103288	REC8M0103289			
200 VERADO	0P514869 - 0P593020	BEL 4	REC880596T60	REC880596T58	REC26-880596502		REC8M6000359
200 VERADO	1B517159 - 2B576734	USA 4	REC880596T60	REC880596T58	REC26-880596502		REC8M6000359
200 VERADO	0P409357 - 0P464487	BEL 6	REC880596T55	REC880596T58	REC26-880596502		REC8M6000359
200 VERADO	0P464488 - 0P520552	BEL 6	REC880596T55	REC880596T58	REC26-880596502		REC8M6000359
200 VERADO	0P520553 - 2B144122	BEL 6	REC880596T55	REC880596T58	REC26-880596502		REC8M6000359
200 VERADO	0T980000 - 1B226999	USA 6	REC880596T55	REC880596T58	REC26-880596502		REC8M6000359
200 VERADO	1B227000 - 1B381711	USA 6	REC880596T55	REC880596T58	REC26-880596502		REC8M6000359
200 VERADO	1B381712 - 1B517433	USA 6	REC880596T55	REC880596T58	REC26-880596502		REC8M6000359
200 VERADO	1B517434 - 2B144122	USA 6	REC880596T55	REC880596T58	REC26-880596502		REC8M6000359
200 VERADO	2B144123 - 2B578935	USA 6	REC8M0103288	REC8M0103289			
200 Pro VERADO	2B034840 - 2B144122	6	REC880596T55	REC880596T58	REC26-880596502		REC8M6000359
200 Pro VERADO	2B144123 - 2B577715	6	REC8M0103288	REC8M0103289			
200 (3.4L) V6 & SEAPRO	2B529482 +	USA 6	REC8M0103288	REC8M0103289			
200 (4.6L) V8 PRO XS	2B529482 +	USA 8	REC8M0103288	REC8M0103289			
225 EFI	0T653945 +	USA 6	REC69J-24410-02	REC69J-13907-03	REC68V-14984-00		
225 VERADO	0P409357 - 0P464487	BEL 6	REC880596T55	REC880596T58	REC26-880596502		REC8M6000359
225 VERADO	0P464488 - 0P520552	BEL 6	REC880596T55	REC880596T58	REC26-880596502		REC8M6000359
225 VERADO	0P520553 - 2B144122	BEL 6	REC880596T55	REC880596T58	REC26-880596502		REC8M6000359
225 VERADO	0T980000 - 1B226999	USA 6	REC880596T55	REC880596T58	REC26-880596502		REC8M6000359
225 VERADO	1B227000 - 1B381711	USA 6	REC880596T55	REC880596T58	REC26-880596502		REC8M6000359
225 VERADO	1B381712 - 1B517433	USA 6	REC880596T55	REC880596T58	REC26-880596502		REC8M6000359
225 VERADO	1B517434 - 2B144122	USA 6	REC880596T55	REC880596T58	REC26-880596502		REC8M6000359
225 VERADO	2B144123 - 2B578935	USA 6	REC8M0103288	REC8M0103289			
225 (3.4L) V6 & SEAPRO	2B529482 +	USA 6	REC8M0103288	REC8M0103289			
225 (4.6L) V8 PRO XS	2B529482 +	USA 8	REC8M0103288	REC8M0103289			
250 VERADO	0P409357 - 0P464487	BEL 6	REC880596T55	REC880596T58	REC26-880596502		REC8M6000359
250 VERADO	0P464488 - 0P520552	BEL 6	REC880596T55	REC880596T58	REC26-880596502		REC8M6000359
250 VERADO	0P520553 - 2B144122	BEL 6	REC880596T55	REC880596T58	REC26-880596502		REC8M6000359
250 VERADO	0T980000 - 1B226999	USA 6	REC880596T55	REC880596T58	REC26-880596502		REC8M6000359
250 VERADO	1B227000 - 1B381711	USA 6	REC880596T55	REC880596T58	REC26-880596502		REC8M6000359
250 VERADO	1B381712 - 1B517433	USA 6	REC880596T55	REC880596T58	REC26-880596502		REC8M6000359
250 VERADO	1B517434 - 2B144122	USA 6	REC880596T55	REC880596T58	REC26-880596502		REC8M6000359
250 VERADO	2B144123 - 2B578935	USA 6	REC8M0103288	REC8M0103289			
250 PRO VERADO	1B830170 - 2B144122	6	REC880596T55	REC880596T58	REC26-880596502		REC8M6000359
250 PRO VERADO	2B144123 - 2B577715	USA 6	REC8M0103288	REC8M0103289			
250 (4.6L) V8, VERADO, SEAPRO & PRO XS	2B529482 +	USA 8	REC8M0103288	REC8M0103289			
250 (4.6L) V8 RACING	1E080500+	USA 8	REC8M0103288	REC8M0103289			
275 VERADO	0P409357 - 0P464487	BEL 6	REC880596T55	REC880596T58	REC26-880596502		REC8M6000359
275 VERADO	0P464488 - 0P520552	BEL 6	REC880596T55	REC880596T58	REC26-880596502		REC8M6000359
275 VERADO	0P520553 - 2B144122	BEL 6	REC880596T55	REC880596T58	REC26-880596502		REC8M6000359
275 VERADO	0T980000 - 1B226999	USA 6	REC880596T55	REC880596T58	REC26-880596502		REC8M6000359
275 VERADO	1B227000 - 1B381711	USA 6	REC880596T55	REC880596T58	REC26-880596502		REC8M6000359

	SERIE	CYL	BOMBA ELECT. ALTA ELECT. FUEL PUMP HIGH POMPA ELECT. ALTA POMPE ELECT. HAUTE	BOMBA ELECT. BAJA ELECT. FUEL PUMP LOW POMPA ELECT. BASSA POMPE ELECT. BASSE	JUNTA VST VST GASKET GUARNIZIONE VST JOINT VST	FILTRO VST VST FILTRE FILTRO VST FILTRE VST	FLOTADOR VST VST FLOAT GALLEGGIANTE VST FLOTEUR VST
275 VERADO	1B381712 - 1B517433	USA 6	REC880596T55	REC880596T58	REC26-880596502		REC8M6000359
275 VERADO	1B517434 - 2B144122	USA 6	REC880596T55	REC880596T58	REC26-880596502		REC8M6000359
275 VERADO	2B144123 - 2B578935	USA 6	REC8M0103288	REC8M0103289			
300 VERADO	0P520553 - 2B144122	BEL 6	REC880596T55	REC880596T58	REC26-880596502		REC8M6000359
300 VERADO	1B517434 - 2B144122	USA 6	REC880596T55	REC880596T58	REC26-880596502		REC8M6000359
300 VERADO	2B144123 - 2B578935	USA 6	REC8M0103288	REC8M0103289			
300 PRO VERADO	1B830170 - 2B144122	USA 6	REC880596T55	REC880596T58	REC26-880596502		REC8M6000359
300 PRO VERADO	2B144123 - 2B577715	USA 6	REC8M0103288	REC8M0103289			
300 (4.6L) V8, VERADO, SEAPRO & PRO XS	2B529482 +	USA 8	REC8M0103288	REC8M0103289			
300 (4.6L) V8 RACING	1E080500+	USA 8	REC8M0103288	REC8M0103289			
350SCi VERADO	1B716557 - 2B143542	USA 6	REC880596T55	REC880596T58	REC26-880596502		REC8M6000359
350 2.6L L6 VERADO	2B141617 +	USA 6	REC8M0103288	REC8M0103289			
350 2.6L L6 PRO VERADO	2B141124 +	USA 6	REC8M0103288	REC8M0103289			
400 2.6L L6 VERADO	2B618256 +	USA 6	REC8M0103288	REC8M0103289			
400R 2.6L L6 RACING	2B141124 +	USA 6	REC8M0103288	REC8M0103289			



MEMBRANAS Y JUNTAS DIAPHRAGMS & GASKETS MEMBRANA E GUARNIZIONI MEMBRANES ET JOINTS

REF	OEM	2T STROKES	4T STROKES		
REC6E0-24471-00	91748M	2B 4A 5C	✓		



REF	OEM	2T STROKES	4T STROKES		
REC648-24411-00	80606M	8K 20C, 28 48, 55 W15, A, K W25, C W30, 30A W40, K40, 40A/B/C K25 W48, W55 60 (2cyl)	✓		

REF	OEM	2T STROKES	4T STROKES		
REC6G1-24431-01	27-11500M	3A/MSH 6C/CEM/D/DEM/TRV/MSH/CMH 8C/CEM/TRV/MSH/CMH/MH 9.9F 13.5AWH 15F	✓		

REF	OEM	2T STROKES	4T STROKES			
REC677-24411-02	84262M	8B/W8 (M)(ML)(SVL)				
REC677-24471-01	84265M	15C/W15 K40HP	✓			

REF	OEM	2T STROKES	4T STROKES		
REC6E0-24411-00	91753M	4A 5C	✓		



REF	OEM	2T STROKES	4T STROKES		
REC663-24411-00	84141M	8K 15K / W15 20C W25, 25K/C, K25/28 W30 W40 30A 40A/B/C 48 55, W-55 60 (2 cyl) K40			



REF	OEM	2T STROKES	4T STROKES			
REC6E0-24434-00	27-91754M	4AC/MSH/AS/A	✓			
REC6E0-24435-00	27-91746M	5C/CS/CMH				

REC6E0-24435-00 REC6E0-24434-00

REF	OEM	2T STROKES	4T STROKES			
REC6G1-24411-00	11499M	6C/D				
REC6G1-24471-00	11497M	8C	✓			

REC6G1-24471-00 REC6G1-24411-00

REF	OEM	2T STROKES	4T STROKES		
REC677-24435-01	27-84264M	9.9D 15D 20DM/DEO 25NE/NEMO	✓		

REF	OEM		2T STROKES	4T STROKES		
REC648-24434-01	20C/CM 25Q/D/B/BMH 25V/VE E30HMH 30G/H 40V/NM/VE/YE	50G/GEO/GETO/H/D 55B/BE 60FEO/FETO/TLR E60H 70B/BETO 75CETO/AE		✓		
REC648-24435-02	27-80613M 27-80614M	E75B 80A/AE 85A/AE 90A/AEO/AET				

KITS BOMBA COMBUSTIBLE **KIT, FUEL PUMP** **KIT POMPA BENZINA** **KIT POMPE ESSENCE**

REF	OEM		2T STROKES	4T STROKES
REC21-42990A10	21-42990A10	30, 45, 65, 105, 140 Jet 100, 115, 125 (4 cyl) 200 DFI 225 (3.0L) Carb / EFI / SeaPro 30, 40 (2 cyl) 40 (3 cyl) 40 (4 cyl) 50, 55, 60, 75, 90 (3 cyl) V-135 - V-200 / XR-6		✓

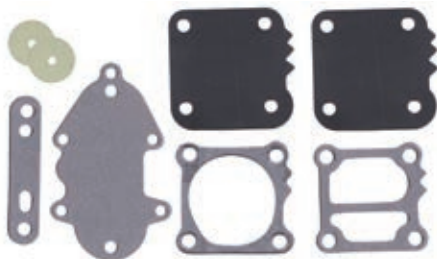

REF	OEM		2T STROKES	4T STROKES
REC55278A5	55278A5	75 (4 cyl)	✓	



REF	OEM		2T STROKES	4T STROKES
REC21-30430A13	21-30430A13	75 (4 cyl)	✓	



REF	OEM		2T STROKES	4T STROKES
REC21-13424A1	21-13424A1	35, 50, 60 (3 cyl)	✓	



REF	OEM		2T STROKES	4T STROKES
REC21-30430A14	21-30430A14	90,115 (6 cyl)	✓	



REF	OEM		2T STROKES	4T STROKES
REC55278A4	55278A4	35 - 70 HP	✓	





REF	OEM		2T STROKES	4T STROKES
REC89031A3	89031A3	90, 115, 140 (6 cyl)	✓	





REF	OEM		2T STROKES	4T STROKES
REC89031A1	89031A1	40 - 90 HP	✓	



REF	OEM		2T STROKES	4T STROKES
REC42909A3	42909A3		100, 115 (4 cyl)	✓



REF	OEM		2T STROKES	4T STROKES
REC155278A1	155278A1		1150, 1350, 1400, 1500 400 (2 cyl) 402, 40 (2 cyl) 650 (3 cyl)	✓





REF	OEM		2T STROKES	4T STROKES
REC21-30430A7	21-30430A7		115 (6 cyl) 1150, 115 140, 1400 1500 (xs) 900, 90	✓



REF	OEM		2T STROKES	4T STROKES
REC56678A1	56678A1		650 (4 cyl)	✓





REF	OEM		2T STROKES	4T STROKES
REC89031A2	89031A2		V-135, V-150 (Work / XR-2) V-150 (Mag-Marathon) V-1500 V-200, V-175 300 (3.4L)	✓





REF	OEM		2T STROKES	4T STROKES
REC21-30430A4	21-30430A4		650 (4 cyl)	✓





REF	OEM		2T STROKES	4T STROKES
REC89031A4	89031A4		V-200	✓





REF	OEM		2T STROKES	4T STROKES
REC21-30430A3	21-30430A3		650 (4 cyl) 1000 BP / SS 1100 1250 / BP 200, 350, 500 650, 800, 80 (4 cyl) 950 (6 cyl)	✓



REF	OEM		2T STROKES	4T STROKES
REC90363A1	90363A1		V-200, V-225	✓



REF	OEM		2T STROKES	4T STROKES
REC23014A1	23014A1		1000 BP / SS 1100 1250 / BP 200, 350, 500 650, 800, 80 (4 cyl) 950 (6 cyl)	✓



REF	OEM	2T	4T
		STROKES	STROKES
REC21-30430A1	1000 BP / SS		
	1100		
	1250 / BP		
	200, 350, 500	✓	
	650 (4 cyl)		
	800, 80 (4 cyl)		
	950 (6 cyl)		



GUÍA BOMBA COMBUSTIBLE

GUIDE, FUEL PUMP

GUIDE POMPA BENZINA

GUIDE POMPE ESSENCE



	SERIE	MEMBRANA DIAPHRAGM MEMBRANA MEMBRANA	KIT JUNTAS GASKET KIT KIT GUARNIZIONE KIT JOINTS	KIT AGUJAS INLET NEEDLE KIT AGHI KIT POINTEAU	BOYA FLOAT GALLEGGIANTE FLOTTEUR	KIT VÁLVULA VALVE KIT KIT VALVOLA KIT SOUPAPE
3.9 (39)	1964-68	1655013-2498135 (KB-7A, KB-7B)		REC1395-2015	REC1395-8673	
4 (40) (1-cyl.)	1969-71	2498136-4107219 (KB-10A)		REC1395-2015	REC1395-8673	
4 (1-cyl.)		(WMD-1)		REC1395-2015	REC1395-8318	REC1395-8673
4 (1-cyl.)		A855097+				REC16253
4.5 (1-cyl.)		(KB-10A)		REC1395-2015		REC1399-1473
4.5 (1-cyl.)		(WMD-1)		REC1395-2015	REC1395-8318	REC1395-8673
5 (1-cyl.)		A855097+				REC16253
6		KB-6A, 6B		REC1395-2015	REC1399-1473	REC1395-8673
6		(AJ-57A)			REC1399-1473	REC1395-8673
6		(WMC-5, 5A, 5B, 7, 7A, 17, 17B, 17C, 18, 18A, 18B, 19, 19A, 20, 20A, 20B)	REC1395-97611	REC1395-97611		
6		(WMC-23, 28, 34, 39, 41, 41A, 47, 47A, 49, 49A, 57)	REC1395-97611	REC1395-97611		
6	1986-98	OA197112+ 9461526	REC1395-97611			
7.5 (7.5, 75)		(BB-2A, 2B, 2C, 4A, 5A, 5B, 5C, 5D, 7A, 7C)	REC1399-5137	REC1395-5198	REC1395-9022	
7.5 (7.5, 75)		(KB-9A, 12A)		REC1395-2015	REC1399-1473	REC1395-8673
7.5		(WMB-2, 4)			REC1395-9022	
8		(WMC-5, 5A, 5B, 7, 7A, 17, 17B, 17C, 18, 18A, 18B, 19, 19A, 20, 20A, 20B)	REC1395-97611	REC1395-97611		
8		(WMC-23, 28, 34, 39, 41, 41A, 47, 47A, 49, 49A, 57)	REC1395-97611	REC1395-97611		
8	1986-98	OA197112+ 9461526	REC1395-97611			
9.8 (9.8, 110)		(BB-2A, 2B, 2C, 4A, 5A, 5B, 5C, 5D, 7A, 7C)	REC1399-5137	REC1395-5198	REC1395-9022	
9.8 (9.8, 110)		(KB-9A, 12A)		REC1395-2015	REC1399-1473	REC1395-8673
9.8		(WMB-2, 4)			REC1395-9022	
9.9		(WMC-5, 5A, 5B, 7, 7A, 17, 17B, 17C, 18, 18A, 18B, 19, 19A, 20, 20A, 20B)	REC1395-97611	REC1395-97611		
9.9		(WMC-23, 28, 34, 39, 41, 41A, 47, 47A, 49, 49A, 57)	REC1395-97611	REC1395-97611		
9.9	1986-98	OA197112+ 9461526	REC1395-97611			
9.9 4T	1999	G60300-T97999		REC66M-W0093-01		REC809569
10 (100)		(AJ-56AB)			REC1399-1473	REC1395-8673
10 (100)		(KB-1A, 4A)		REC1395-2015	REC1399-1473	REC1395-8673
10 (Sae Pro, Marathon)		(WMC-33, 33A, 40, 42, 50, 50A, 50B, 55, 55A)	REC1395-97611	REC1395-97611		
10 (XR10, Magnum 10)		(WMC-23, 48, 48A, 49, 49A)	REC1395-97611	REC1395-97611		
15 (150)		(KB-1A, 4A)		REC1395-2015	REC1399-1473	REC1395-8673
15		(WMC-5, 5A, 5B, 7, 7A, 17, 17B, 17C, 18, 18A, 18B, 19, 19A, 20, 20A, 20B)	REC1395-97611	REC1395-97611		
15		WMC-23, 28, 34, 39, 41, 41A, 47, 47A, 49, 49A, 57	REC1395-97611	REC1395-97611		
15	1988-98	OB292414+ 9542620	REC1395-97611			
15 (Super 15, 15XD)		(WMC-13, 13A, 14, 14A, 15A, 16A, 24, 25, 26, 27, 29, 30, 31, 31A, 32, 32A, 35, 35A, 35B, 36, 37, 44, 45, 46, 46A, 52, 52A, 53, 53A, 54, 54A, 56, 56A)	REC1395-97611	REC1395-97611		
15 (Sea Pro, Marathon)		(WMC-33, 33A, 40, 42, 50, 50A, 50B, 55, 55A)	REC1395-97611	REC1395-97611		
15 4T	1998	G59000+		REC66M-W0093-01		REC809569
18		(WMC-1, 2, 3, 4, 9, 10, 11, 12)	REC1395-97611	REC1395-97611		
18		(WMC-13, 13A, 14, 14A, 15A, 16A, 24, 25, 26, 27, 29, 30, 31, 31A, 32, 32A, 35, 35A, 35B, 36, 37, 44, 45, 46, 46A, 52, 52A, 53, 53A, 54, 54A, 56, 56A)	REC1395-97611	REC1395-97611		
20 (200)		(KA-22A, 22B, 22C, 23A, 25A)		REC1395-2015	REC1399-1473	REC1395-8673
20 (200)	1966-67	1866496-2296266	REC23014A1			
20 (20, 200)		(BA-1A, 2A, 2C, 2D, 2E)	REC1399-5137	REC1395-5198		
20		(WMC-1, 2, 3, 4, 9, 10, 11, 12)	REC1395-97611	REC1395-97611		
20		(WMC-13, 13A, 14, 14A, 15A, 16A, 24, 25, 26, 27, 29, 30, 31, 31A, 32, 32A, 35, 35A, 35B, 36, 37, 44, 45, 46, 46A, 52, 52A, 53, 53A, 54, 54A, 56, 56A)	REC1395-97611	REC1395-97611		
20	1986-87	6443973 9415101 7209533	REC1395-97611			
20 Jet	1994-98	OG044027 + (WMC-45, 53A)	REC1395-97611	REC1395-97611		
25 (2-cyl.)		(WMC-1, 2, 3, 4, 9, 10, 11, 12)	REC1395-97611	REC1395-97611		

		SERIE	MEMBRANA DIAPHRAGM MEMBRANA MEMBRANA	KIT JUNTAS GASKET KIT KIT GUARNIZIONE KIT JOINTS	KIT AGUJAS INLET NEEDLE KIT AGHI KIT POINTEAU	BOYA FLOAT GALLEGGIANTE FLOTTEUR	KIT VÁLVULA VALVE KIT KIT VALVOLA KIT SOUPAPE
25 (2-cyl.)		(WMC-13, 13A, 14, 14A, 15A, 16A, 24, 25, 26, 27, 29, 30, 31, 31A, 32, 32A, 35, 35A, 35B, 36, 37, 44, 45, 46, 46A, 52, 52A, 53, 53A, 54, 54A, 56, 56A)	REC1395-97611	REC1395-97611			
25	1984-87	6443973	REC1395-97611				
25	1986-87	9415101 7209533	REC1395-97611				
30 (300) (4-cyl.)		(AJ-54A)			REC1399-1473	REC1395-8673	
30 (300) (4-cyl.)		(KB-2A)		REC1395-2015	REC1399-1473	REC1395-8673	
30 (2-cyl.) (644cc)	1994-98	OG053314+ (WME-36, 36A, 37, 39A, 42, 42A, 63, 64, 65, 66, 67)	REC21-42990A10	REC1395-8112231	REC1395-9595-1	REC1395-9594	
30 Jet (4-cyl.)		(WMA-10, 13)		REC1395-9651	REC1395-9595-1		
30 Jet (4-cyl.)		(WME-53, 68, 69)		REC1395-9651	REC1395-9595-1	REC1395-9594	
30 Jet	1994-97	OC159200+		REC21-42990A10			
30 Jet	1998	G590000+		REC21-42990A10			
35 (350)	1966-69	1960827-2874703	REC23014A1	REC21-30430A1			
35 (350) (4-cyl.)		(AJ-54A)			REC1399-1473	REC1395-8673	
35 (350) (4-cyl.)		(KB-2A)		REC1395-2015	REC1399-1473	REC1395-8673	
35 (2-cyl.)		(KC-4A, 8A, 9A, 9B, 9C, 13A)		REC1395-2015	REC1395-8318	REC1395-8673	
35	1984-86	6445653-OB110788 9384476 209608	REC155278A1				REC21-13424A1
35	1987-89	OB110789+ 9384476	REC21-42990A10				
GLM40 (400) (4-cyl.)		(KA-2A, 9A)		REC1395-2015	REC1399-1473	REC1395-8673	
40 (40, 400, 402) (2-cyl.)		(KD-5A)		REC1395-2015	REC1399-1473	REC1395-8673	
40 (40, 400, 402) (2-cyl.)	1970-79	(WMK-1, 8, 21, 24, 31, 33, 34, 38) 2874704-5556229 8002335-8064749 3339688-9251455 3340783-7144762	REC155278A1				
40 (2-cyl.) (644cc)		(WME-36, 36A, 37, 37A, 38, 39A, 42, 42A, 63, 64, 65, 66, 67)		REC1395-8112231	REC1395-9595-1	REC1395-9594	
40 (2-cyl.) (644cc)	1994-98	OG053314+	REC21-42990A10				
40 (3-cyl.)		(WME-53, 68, 69)		REC1395-8112231	REC1395-9595-1	REC1395-9594	
40 (3-cyl.)	1997-98	OG531301+ 9973100	REC21-42990A10				
40 (4-cyl.)		(WMA-4)	REC1395-9024	REC1395-9024	REC1395-9022		
40 (4-cyl.)		(WMA-7B)		REC1395-9651	REC1395-9595-1		
40 (4-cyl.)		(WMA-9, 10, 13)					
40 (4 T/Stroke)	1998	OG231123+			REC809570-1	REC809569	
45 (450) (4-cyl.)		KA-17A		REC1395-8112231	REC1399-1473	REC1395-8673	
45 (4-cyl.)		(WMA-4)	REC1395-9024	REC1395-9024	REC1395-9022		
45 (4-cyl.)		(WMA-7B)		REC1395-9651	REC1395-9595-1		
45 (4-cyl.)		(WMA-9, 10, 13)					
45 (4-cyl.)	1987-89	OB110789+ 9466692	REC21-42990A10				
45 (4 T/Stroke, Nodensee)	1996-98	OG231123+			REC809570-1	REC809569	
45 Jet (3-cyl.)		(WME-57, 78)		REC1395-8112231	REC1395-9595-1	REC1395-9594	
45 Jet	1994-95	6428681-OB122929	REC155278A1				
45 Jet	1994-95	OB122930+	REC21-42990A10				
50 (50, 500) (4-cyl.)	1967-75	2116318-4357639	REC23014A1				
50 (50, 500) (4-cyl.)	1971-75	2863739-8030089 9001581-9107213	REC23014A1				
50 (50, 500) (4-cyl.)	1967-75	2097445-7068997	REC23014A1				
50 (4-cyl.)		(KA-13A, 18A, 19A, 21A, 21B, 21C, 21D, 24A, 26A, 26B, 27A)		REC1395-2015	REC1399-1473	REC1395-8673	
50 (4-cyl.)		(BA-3A, 3B, 3C, 3D, 4A)	REC1399-5137	REC1395-5198	REC1395-9022		
50 (4-cyl.)		(WMA-1, 3)	REC1395-9024	REC1395-9024	REC1395-9022		
50 (4-cyl.)		(WMK-8)		REC1395-48401	REC1395-8318	REC1395-8673	
50 (3-cyl.)		(WM-13, 13A, 15, 15A, 16, 16A, 18)		REC1395-6200	REC19271-1		
50 (3-cyl.)		(WME-22, 22B, 23, 24, 26, 27, 28, 35, 43, 44, 45, 53, 68, 69)		REC1395-8112231	REC1395-9595-1	REC1395-9594	
50 (3-cyl.)	1986-87	6428681-OB122929 9385911-9469199 7208333-0A721307	REC155278A1				
50 (3-cyl.)	1988-90	OB122930+ 9469200 0A721308+	REC21-42990A10				
50 (3-cyl.)	1998	OG590000 + 9973100	REC21-42990A10				
50 (4 T/Stroke)	1995-98	OG231123+			REC809570-1	REC809569	
55		(WM-13, 13A, 15, 15A, 16, 16A, 18)		REC1395-6200	REC19271-1		
55		(WME-22, 22B, 23, 24, 26, 27, 28, 35, 43, 44, 45, 57, 58)		REC1395-8112231	REC1395-9595-1	REC1395-9594	
55 (3-cyl.)	1996-97	OD000750+ 9741042	REC21-42990A10				
60 (600) (6-cyl.)		(KB-3A)		REC1395-2015	REC1399-1473	REC1395-8673	
60 (3-cyl.)		(WM13- 13A, 15, 15A, 16, 16A, 18)		REC1395-6200	REC19271-1		
60 (3-cyl.)		(WME-22, 22B, 23, 24, 26, 27, 28, 35, 43, 44, 45, 57, 58)		REC1395-8112231	REC1395-9595-1	REC1395-9594	
60 (3-cyl.)	1984-87	6428681-OB122929 9385911-9469199 7208333-0A721307	REC155278A1				
60 (3-cyl.)	1988-90	OB122930+ 9469200 0A721308+	REC155278A1				
65 (650) (4-cyl.)		(KC-2A, 5A, 5B, 5C, 11A, 15A)		REC1395-2015	REC1399-1473	REC1395-8673	
65 (650) (4-cyl.)	1967-69	2119749-2803561	REC23014A1				REC21-30430A1
65 (650) (4-cyl.)	1970-71	2803562-3293183	REC56678A1				REC21-30430A4
65 (650) (3-cyl.)		(WMK-5, 12, 13, 20) (WM-2) (WM-4)		REC1395-6200	REC1395-8318	REC1395-8673	
65 (650) (3-cyl.)	1972-76	3293184-4571651	REC56678A1				REC21-30430A3
65 (650) (3-cyl.)	1973-83	8006640	REC56678A1				REC21-30430A3
65 (650) (3-cyl.)	1973-76	9020074-9135824 7013633-7087822	REC56678A1				REC21-30430A3

		SERIE	MEMBRANA DIAPHRAGM MEMBRANA MEMBRANE	KIT JUNTAS GASKET KIT KIT GUARNIZIONE KIT JOINTS	KIT AGUJAS INLET NEEDLE KIT AGHI KIT POINTEAU	BOYA FLOAT GALLEGGIANTE FLOTTEUR	KIT VÁLVULA VALVE KIT KIT VALVOLA KIT SOUPAPE
65 Jet (3-cyl.)		(WME-29, 30, 41, 46, 47, 48, 49, 59, 60, 61, 62, 75, 76, 77, 78, 82, 83, 84, 87, 88)		REC1395-8112231	REC1395-9595-1	REC1395-9594	
65 Jet	1994-98	283222	REC21-42990A10				
70 (700) (6-cyl.)		(KA-8A, 12A)		REC1395-2015	REC1399-1473	REC1395-8673	
70 (3-cyl.)		(WM-6, 8, 9, 11)		REC1395-6200	REC1395-8318		
70 (3-cyl.)		(WME-1, 1A, 1B, 4, 5, 6, 6A, 7, 7B, 8, 9, 10, 10A, 15, 15A, 17, 18, 19, 25)		REC1395-8112231	REC1395-9595-1	REC1395-9594	
70 (3-cyl.)	1977-83	4571652-6428680 8042350 9135825-9385910 7087823-7208332	REC55278A4				REC21-13424A1
70 (3-cyl.)	1987	0A996142+ 9483121	REC42909A3				
75 (4-cyl.)		(WM-14, 17)		REC1395-6200	REC19271-1		
75 (4-cyl.)			REC55278A5				REC21-30430A13
Bomba triangular Triangular pump Pompa triangolare Pompe triangulaire	1984-88	6432901 9393856 7208573	REC55278A5				REC21-30430A13
75 (4-cyl.) Bomba cuadrada Square pump Pompa quadrata Pompe carrée	1984-88	6432901 9393856 7208573	REC21-42990A10				REC21-30430A13
75 (3-cyl.)		(WME-1, 1A, 1B, 4, 5, 6, 6A, 7, 7B, 8, 9, 10, 10A, 15, 15A, 17, 18, 19, 25, 29, 30, 31, 41, 46, 47, 48, 49, 59, 60, 61, 62, 75, 76, 77, 78, 82, 83, 84, 87, 88)		REC1395-8112231	REC1395-9595-1	REC1395-9594	
75 (3-cyl.)	1990-98	OC222000+ 9589039	REC42909A3				
75 (3-cyl.)	1990-98	OC222000+ 9589039	REC21-42990A10				
75 4T	2000	G960500+		REC67F-W0093-00		REC6H4-14985-01	
80 (800) (6-cyl.)		KA-10A, 11A, 14A, 16A, KC-3A		REC1395-2015	REC1399-1473	REC1395-8673	
80 (800) (4-cyl.)	1969-72	2559001-2670574	REC23014A1				REC21-30430A1
80 (800) (4-cyl.)	1969-72	2783253-2856331	REC56678A1				REC21-30430A3
80 (80, 800) (4-cyl.)		(KD-4A)		REC1395-48401	REC1395-8318	REC1395-8673	
80 (80, 800) (4-cyl.)		(WM-5, 10, 12, 14, 17)		REC1395-6200	REC1395-8318		
80 (80, 800) (4-cyl.)	1978-83	4831999-6432900 8050200 9177626-9393855 7110998-7208572	REC55278A5				REC21-30430A13
80 (3-cyl.)		(WME-1, 1A, 1B, 4, 5, 6, 6A, 7, 7B, 8, 9, 10, 10A, 15, 15A, 17, 18, 19, 25)		REC1395-8112231	REC1395-9595-1	REC1395-9594	
80 (3-cyl.)	1987	0A996142+	REC42909A3				
80 (3-cyl.)	1987	9483121	REC42909A3				
80 Jet (4-cyl.)	1994-98	(WME-32, 32A, 50, 79)		REC1395-8112231	REC1395-9595-1	REC1395-9594	
80 Jet	1994-98	OD283222+	REC21-42990A10				
85 (850) (6-cyl.)		(KA-10A, 11A, 14A, 16A, KC-3A)		REC1395-2015	REC1399-1473	REC1395-8673	
85 (850) (4-cyl.)		(WM-3, 5)		REC1395-6200	REC1395-8318		
85 (850) (4-cyl.)		(WMK-4, 16, 17)		REC1395-48401	REC1395-8318	REC1395-8673	
85 (850) (4-cyl.)	1973-77	3493913-4831998 8005440-8050199 9011604-9177625 7010108-7110997	REC55278A5				REC21-30430A13
90 (900) (6-cyl.)		(KC-6A)		REC1395-2015	REC1399-1473	REC1395-8673	
90 (90, 900) (6-cyl.)		(WMK-23, 27, 30, 35, 39)		REC1395-48401	REC1395-8318	REC1395-8673	
90 (90, 900) (6-cyl.)	1978-79	4845301-5299505 7111698-7123762	REC89031A1				REC21-30430A13
90 (6-cyl.) Bomba triangular Triangular pump Pompa triangolare Pompe triangulaire	1979-86	5299506 8060545 7147088	REC89031A3				REC21-30430A14
90 (6-cyl.) Bomba cuadrada Square pump Pompa quadrata Pompe carrée	1979-86	5299506 8060545 7147088	REC21-42990A10				
90 (3-cyl.)		(WME-1, 1A, 1B, 4, 5, 6, 6A, 7, 7B, 8, 9, 10, 10A, 15, 15A, 17, 18, 19, 25, 29, 30, 31, 41, 46, 47, 48, 49, 59, 60, 61, 62, 75, 76, 77, 78, 82, 83, 84, 87, 88)		REC1395-8112231	REC1395-9595-1	REC1395-9594	
90 (3-cyl.)	1987	0A996142+ 9483121	REC21-42990A10				
90 (3-cyl.)	1987	0A996142+ 9483121	REC42909A3				
90 (4 T) Stroke	2000	G960500+		REC67F-W0093-00		REC6H4-14985-01	
95 (950) (6-cyl.)		(KC-6A)		REC1395-2015	REC1399-1473	REC1395-8673	
95 (950) (6-cyl.)	1966-67	1869776-2318585	REC23014A1				REC21-30430A1
100 (1000) (6-cyl.)		(KC-1A, 7A, 7B, 10A, 14A)		REC1395-2015	REC1399-1473	REC1395-8673	
100 (1000) (6-cyl.)		(KD-1A, 1B, 2A, 3A)		REC1395-48401	REC1395-8318	REC1395-8673	
100 (1000SS/BP) (6-cyl.)	1968-69	2318586-3253111	REC23014A1				REC21-30430A1
100 (4-cyl.)		(WME-11, 14, 20, 20A, 21, 21A, 32, 32A, 50, 79)		REC1395-8112231	REC1395-9595-1	REC1395-9594	
100 (4-cyl.)	1988-93	0B209468-0D283221 9523034-9793576	REC42909A3				
100 (4-cyl.)	1988-93	0B209468-0D283221	REC21-42990A10				
100 (4-cyl.)	1988-93	9523034-9793576	REC21-42990A10				
100 (4-cyl.)	1994-98	0D283222+ 9793577	REC21-42990A10				
110 (1100) (6-cyl.)		(KC-1A, 7A, 7B, 10A, 14A)		REC1395-2015	REC1399-1473	REC1395-8673	
110 (1100) (6-cyl.)	1966-67	1870204-2314955	REC23014A1				REC21-30430A1
115 (1150) (6-cyl.)	1970-77	2836019-4855152	REC155278A1	REC21-30430A3			
115 (1150) (6-cyl.)	1973-77	8008665-8051949 7010763-7112248	REC155278A1	REC21-30430A3			
115 (115, 1150) (6-cyl.)		(KD-6A, 6B) (WMK-3, 10, 15, 18, 26, 28, 32, 36, 40, 41)		REC1395-48401	REC1395-8318	REC1395-8673	

		SERIE	MEMBRANA DIAPHRAGM MEMBRANA MEMBRANE	KIT JUNTAS GASKET KIT KIT GUARNIZIONE KIT JOINTS	KIT AGUJAS INLET NEEDLE KIT AGHI KIT POINTEAU	BOYA FLOAT GALLEGGIANTE FLOTTEUR	KIT VÁLVULA VALVE KIT KIT VALVOLA KIT SOUPAPE
115 (115, 1150) (6-cyl.)	1978-79	4855153-5314655 8051950-8061119 7112248-7131212	REC89031A1	REC21-30430A7			
115 Bomba triangular Triangular pump Pompa triangolare Pompe triangulaire	1979-88	5314656 7131213	REC89031A3				REC21-30430A14
	1979-83	8061120	REC89031A3				REC21-30430A14
115	1979-88	5314656 7131213	REC21-42990A10				
	1979-83	8061120	REC21-42990A10				
115 (4-cyl.)		(WME-11, 14, 20, 20A, 21, 21A, 33, 40, 40A)		REC1395-8112231	REC1395-9595-1	REC1395-9594	
115 (4-cyl.)	1989-93	OC100000-0D283221 9559771-9793576	REC42909A3				
115 (4-cyl.)	1989-93	OC100000-0D283221 9559771-9793576	REC21-42990A10				
115 (4-cyl.)	1994-98	OD283222+ 9793577	REC21-42990A10				
125 (1250) (6-cyl.)		(KD-1A, 1B, 2A, 3A)		REC1395-48401	REC1395-8318	REC1395-8673	
125 (1250) (6-cyl.)	1968-69	2314956-2839368	REC23014A1				REC21-30430A1
125 (1250BP) (6-cyl.)	1968	2400058-2641954	REC23014A1				REC21-30430A1
125 (4-cyl.)		(WME-34, 52, 81)		REC1395-8112231	REC1395-9595-1	REC1395-9594	
125 (4-cyl.)	1994-98	OD283222+	REC21- 42990A10				
135 (1350) (6-cyl.)		(KD-7A, 7B) (WMK-4)		REC1395-48401	REC1395-8318	REC1395-8673	
135 (1350) (6-cyl.)	1969	2839369-3293233	REC155278A1				REC21-30430A3
140 (1400) (6-cyl.)	1970-71	3293234-3502805	REC155278A1				REC21-30430A3
140 (140, 1400) (6-cyl.)		(WMK-7, 9, 25, 29)		REC1395-48401	REC1395-8318	REC1395-8673	
140 (140, 1400) (6-cyl.)	1978-79	4865678-5327662 8052650-8052879 7112773-7132512	REC89031A1				REC21-30430A7
140 (6-cyl.)	1980-81	5327663	REC89031A3				REC21-30430A14
140 (6-cyl.)	1981	8066065	REC89031A3				REC21-30430A14
140 (6-cyl.)	1980-81	7112773-7132512	REC89031A3				REC21-30430A14
150 (1500) (6-cyl.)		(WMK-7, 9, 25, 29)		REC1395-48401	REC1395-8318	REC1395-8673	
150 (1500) (6-cyl.)	1973-77	4865678-5327662 8052650-8052879 7112773-7132512	REC155278A1				REC21-30430A3
150 (1500XS) (6-cyl.)	1978	5327663	REC89031A2				
V-105 Jet	1994-95	OD08200-0G303045 (WMH-13, 23, 31)		REC8107492	REC1395-811690-1		
V-105 Jet	1996	OG303046+ (WMV-2, 2A)		REC8107492	REC1395-811690-1		
V-135 Bomba triangular Triangular pump Pompa triangolare Pompe triangulaire	1986-88	OA904646-OC100860 (WH-33, 40) OA904646-OC100860 (WH-32, 35, 38)	REC89031A2	REC1395-6452	REC1395-7824	REC1395-7623	
V-135 Bomba cuadrada Square pump Pompa quadrata Pompe carrée	1989-90	OC100861-OC239552 (WH-35, 38)	REC89031A2	REC1395-6452	REC1395-7824	REC1395-7623	
V-135 Bomba cuadrada Square pump Pompa quadrata Pompe carrée	1989-90	OC100861-OC239552 (WH-40, 48)	REC21-42990A10	REC1395-6452	REC1395-7824	REC1395-7623	
V-135	1991	OC239553-OD081999 (WMH-8, 8A)	REC89031A2	REC8107492	REC1395-7824		
V-135 Bomba triangular Triangular pump Pompa triangolare Pompe triangulaire	1992-95	OD082000-OG303045 (WMH-12A, 12B)	REC89031A2	REC8107492	REC1395-7824		
V-135 Bomba cuadrada Square pump Pompa quadrata Pompe carrée	1992-95	OD082000-OG303045 (WMH-28, 30)	REC21-42990A10	REC8107492	REC1395-7824		
V-135	1996-98	OG303046-OG760299 (WMV-1, 1A)	REC89031A2	REC8107493	REC1395-7824		
V-135		OG760300+ (WMV-1A)	REC89031A2	REC8107493	REC1395-7824		
V-135		(WMH 21, 22, 23, 24, 25, 28)		REC1395-811691-2			
V-135 DFI	1998	OG590000+	REC21- 42990A10				
V-140 Jet	1994-95	OG82000-OG303045 (WMH-16, 21, 34, 39)		REC8107492	REC1395-811690-1		
V-140 Jet	1996-98	OG303046-OG760299 (WMV-5, 5A) OG760300+ (WMV-5A)		REC8107493	REC1395-811690-1		
V-150 (1500) Bomba triangular Triangular pump Pompa triangolare Pompe triangulaire	1978-85	4868998	REC89031A2				
V-150 (1500) Bomba cuadrada Square pump Pompa quadrata Pompe carrée	1978-85	4868998	REC21- 42990A10				
V-150 (150, 1500)	1978-98	(WH-9)		REC1395-6452		REC1395-7623	
V-150 (150, 1500)	1978-98	(WH-12) (WH-29)		REC1395-6452	REC1395-7824	REC1395-7623	
V-150	1986-88	OA904646-OC239552 (WH-35, 38, 40, 48)		REC1395-6452	REC1395-7824	REC1395-7623	
V-150	1991	OC239553-OD081999 (WMH-1, 7)		REC8107492	REC1395-811690-1		
V-150	1992-95	OD08200-OG303045 (WMH-13, 13B, 23, 31)		REC8107492	REC1395-811690-1		
V-150	1996-98	OG303046-OG760299 (WMV-2, 2A)		REC8107492	REC1395-811690-1		
V-150		OG760300+ (WMV-3A)		REC8107492	REC1395-811690-1		
V-150 DFI	1998	OG590000+	REC21-42990A10				
V-150 EFI	1993-98		REC21- 42990A10				
V-150 (XR4, MAGII)	1988	OB242885-OC100860 (WH-41A)	REC21-42990A10	REC1395-6452	REC1395-7824	REC1395-7623	
V-150 (XR4, MAGII)	1989	OC100861-OC239552 (WH-41, 41A)	REC21-42990A10	REC1395-6452	REC1395-7824	REC1395-7623	
V-150 (XR4, MAGII)	1991	OC239553-OD081999 (WMH-6)	REC21-42990A10	REC8107492	REC1395-811690-1		
V-150 (XR4, MAGII)	1992-95	OD082000-OG303045 (WMH-14A, 25, 32A)	REC21-42990A10	REC8107492	REC1395-811690-1		

		SERIE	MEMBRANA DIAPHRAGM MEMBRANA	KIT JUNTAS GASKET KIT KIT GUARNIZIONE KIT JOINTS	KIT AGUJAS INLET NEEDLE KIT AGHI KIT POINTEAU	BOYA FLOAT GALLEGGIANTE FLOTTEUR	KIT VÁLVULA VALVE KIT KIT VALVOLA KIT SOUPAPE
V-150 (XR4, MAGII)	1996-98	OG303046-OG760299 (WMV-3, 3A)	REC21-42990A10	REC8107492		REC1395-811690-1	
V-150 (XR4, MAGII)	1996-98	OG762000+ (WMV-3A)	REC21-42990A10	REC8107492		REC1395-811690-1	
V-150		(WMH 21, 22, 23, 24, 25, 28)		REC1395-811691-2			
V-175 Bomba triangular Triangular pump Pompa triangolare Pompe triangulaire	1976-88	4301235-0C100860 (WH-13)	REC21-42990A10	REC1395-6452		REC1395-7824	REC1395-7623
	1976-79	8058870-8064249 (wh-13)	REC21-42990A10	REC1395-6452		REC1395-7824	REC1395-7623
V-175 Bomba cuadrada Square pump Pompa quadrata Pompe carrée	1976-88	4301235-0C100860 (WH-1, 4, 7, 28, 39, 46)	REC89031A2	REC1395-6452		REC1395-7824	REC1395-7623
	1976-79	8058870-8064249 (WH-13)	REC89031A2	REC1395-6452			REC1395-7623
V-175 Bomba triangular Triangular pump Pompa triangolare Pompe triangulaire	1976-88	4301235-0C100860 (WH-7A)	REC21-42990A10	REC1395-6452			REC1395-7623
	1976-79	8058870-8064249 (WH-7A)	REC21-42990A10	REC1395-6452		REC1395-7824	REC1395-7623
V-175 Bomba cuadrada Square pump Pompa quadrata Pompe carrée	1976-88	4301235-0C100860 (WH-17)	REC89031A2	REC1395-6452		REC1395-7824	REC1395-7623
	1976-79	8058870-8064249 (WH-17)	REC89031A2	REC1395-6452		REC1395-7824	REC1395-7623
V-175 Bomba triangular Triangular pump Pompa triangolare Pompe triangulaire	1976-88	4301235-0C100860 (WH-17R, 30, 34)	REC21-42990A10	REC1395-6452		REC1395-7824	REC1395-7623
	1976-79	8058870-8064249 (WH-17R, 30, 34)	REC21-42990A10	REC1395-6452		REC1395-7824	REC1395-7623
V-175	1989-90	OC100861-OC239552 (WH-34)		REC1395-6452		REC1395-7824	REC1395-7623
V-175	1991	OC239553-OD81999 (WMH-2, 11)		REC8107492		REC1395-811690-1	
V-175	1992-95	OD082000-OG303045 (WMH-15, 22, 33)		REC8107492		REC1395-811690-1	
V-175	1996-98	OG303046-OG760299 (WMV-4, 4A)		REC8107493		REC1395-811690-1	
V-175	1991	OG760300+ (WMV-4A)		REC8107493		REC1395-811690-1	
V-175	1991	OG760300+		REC1395-6452		REC1395-7824	REC1395-7623
V-175 EFI	1991-98		REC21-42990A10				
V-175		(WMH 21, 22, 23, 24, 25, 28)		REC1395-811691-2			
V-200 EFI	1989-98		REC21-42990A10				
V-200 (200, 2000)	1978-88	4839034-0C100860 (WH-3)	REC89031A2	REC1395-6452		REC1395-7824	
V-200 (200, 2000)	1980-81	8061595-8065672 (WH-3)	REC89031A2	REC1395-6452		REC1395-7824	REC1395-7623
V-200 (200, 2000)	1978-88	4839034-0C100860 (WH-3A, 11)	REC89031A2	REC1395-6452			REC1395-7623
V-200 (200, 2000)	1980-81	8061595-8065672 (WH-3A, 11)	REC89031A2	REC1395-6452			REC1395-7623
V-200 (200, 2000)	1978-88	4839034-0C100860 (WH-14, 16, 18, 20, 28, 39, 46)	REC89031A2	REC1395-6452		REC1395-7824	REC1395-7623
V-200 (200, 2000)	1980-81	8061595-8065672 (WH-14, 16, 18, 20, 28, 39, 46)	REC89031A2	REC1395-6452		REC1395-7824	REC1395-7623
V-200	1989-90	OC100861-OC291519 (WH-46)		REC1395-6452		REC1395-7824	REC1395-7623
V-200	1991	OC291520-OD081999 (WMH-3)		REC8107492		REC1395-811690-1	
V-200	1992-95	OD082000-OG303045 (WMH-16, 21, 34, 39)		REC8107492		REC1395-811690-1	
V-200	1996-98	OG303046-OG760299 (WMV.5, 5A)		REC8107493		REC1395-811690-1	
V-200	1996-98	OG760300+ (WMV-5A)		REC8107493		REC1395-811690-1	
V-200	1982-83	6073192-6357229	REC90363A1				
V-200	1983-84	6357230-6625220	REC89031A4				
V-200	1985-88	6625221	REC21-42990A10				
V-200		(WMH 21, 22, 23, 24, 25, 28)		REC1395-811691-2			
V-200 DFI	1998	OG590000+	REC21-42990A10				
V-220 Laser	1987-88	OB117316+	REC21-42990A10				
V-225 (2.4L)	1980-81	5628028 + (WH-5, 20)	REC90363A1	REC1395-6452		REC1395-7824	REC1395-7623
		OD280813-OG303045 (WMH-19, 46, 47)					
		OG303046-OG760299 (WMV-7, 13)					
		OG76300+ (WMV-13)					
V-225 (3.0L)	1994-98	OG245605-OG303045 (WMH-45)	REC21-42990A10	REC8107492		REC1395-811690-1	
		OG303046-OG760299 (WMH-6, 11)					
		(WMV-11)					
		OG760300+ (WMV-11A)					
V-250 (275) (3.4L)	1989-94	OC101891+ (WD-8A, 9, 9A)	REC21-42990A10				
V-225 DFI (3.0L)	1998	OG590000+	REC21-42990A10				
V-225 EFI (3.0L)	1995-98	OG129222+	REC21-42990A10				
V-250 EFI (3.0L)	1995-98	OG129222+	REC21-42990A10				
V-275 (3.4L)	1989-94	OC101891+	REC21-42990A10				
V-300 (3.4L)	1980-87	5611648+ (WD-3, 5)	REC89031A2				

KIT VST ALTA PRESIÓN		VST KIT HIGHT PRESSURE		KIT VST ALTA PRESIONE		KIT VST HAUTE PRESION	
REF	OEM			2T	4T		
PAF40-05100000EI	892267T03 892267T02		40, 50, 60 EFI (3 Et 4 cyl)	STROKES	STROKES	✓	
<p>Sin conector eléctrico Without electrical connector Senza connettore elettrico Sans connecteur électrique</p>							
							



**REGULADOR PRESIÓN
COMBUSTIBLE**

**REGULATOR FUEL
PRESSURE**

**REGOLATORE PRESSIONE
COMBUSTIBILE**

**REGULATEUR DE
PRESSION D'ESSENCE**

REF	OEM		2T STROKES	4T STROKES
REC69J-13906-00	888227	225E EFI V6 (0T653945+)		✓



new

JUNTAS VST

VST GASKETS

GUARNIZIONE VST

JOINTS VST



REF	OEM		2T STROKES	4T STROKES
REC27-8M0135597	27-8M0135597	9.9 EFI (1R008146-) 10, 15, 20 EFI (OR833820+)		✓

new





REF	OEM		2T STROKES	4T STROKES
REC6C5-14984-00	27-881325001	75, 80, 90, 100 HP EFI		✓

new

REF	OEM		2T STROKES	4T STROKES
REC27-883213	27-883213	30, 40 EFI (3Cyl) 40, 50, 60 EFI (4 Cyl) Formula 60 (Race Outboard)		✓





REF	OEM		2T STROKES	4T STROKES
REC27-883252	27-883252	110 Jet (2.5L9) 150, 175 Proxs (2.5 L) 200, 225, 250 (3.0 EFI) V-135 - V-200 EFI/ DFI (2.5L)		✓





REF	OEM		2T STROKES	4T STROKES
REC27-889319	27-889319	75, 90 DFI, 80 Jet (3 cyl) 1.5 L 115, 125 DFI (3 cyl) 1.5 L Pro xs 200 (3.0) DFI DTS 200 DFI 3.0L Pro xs 225 DFI 3.0L Pro xs Race Outboard 225 x 5 (3.0 & 3.2L DFI)		✓



REF	OEM		2T STROKES	4T STROKES
REC68V-14984-00	27-881325	115 EFI 225 EFI		✓



REF	OEM		2T STROKES	4T STROKES
REC26-880596502	26-880596502	75, 80, 90, 110, 115 EFI 135, 150, 175, 200 Verado (4 cyl) 200, 225, 250, 275, 300, 350 Verado (6 cyl)		✓



REF	OEM		2T STROKES	4T STROKES
REC25-809086	25-809086	200 DFI 225, 250 (3.0L EFI) V-150 - V-200 EFI		✓

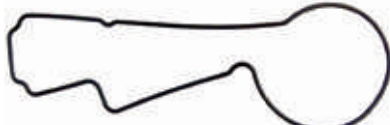

INYECTORES

INJECTOR

INNIETTORE

INJECTEURS

INJECTOR COMBUSTIBLE FUEL INJECTOR

INNIETTORE COMBUTIBILE INJECTEURS

REF	OEM		2T STROKES	4T STROKES
REC8M0134459	8M0134459		9.9 EFI, 10 EFI, 15 EFI, 20 EFI	✓



REF	OEM		2T STROKES	4T STROKES
REC8M0091784	8M0091784 89810174		25, 30 EFI (OR106966+)	✓



REF	OEM		2T STROKES	4T STROKES
REC892123002	892123002 892123001 877826		30 - 60 EFI	✓



REF	OEM		2T STROKES	4T STROKES
REC8M6002428	8M6002428 8M6000652 8M0057686		70 - 150 HP EFI	✓



new

REF	OEM		2T STROKES	4T STROKES
REC8M0041571	8M0041571 8M0006027 892811T02		75 - 300 HP EFI VERADO	✓



REF	OEM		2T STROKES	4T STROKES
REC6D8-13761-00	880887T02		75 - 100 EFI	✓



REF	OEM		2T STROKES	4T STROKES
REC68V-8A360-00	880887T1		115 EFI (0T178500 - 1B366822)	✓



REF	OEM		2T STROKES	4T STROKES
REC69J-13761-00	888212		225E EFI V6 (0T653945+)	✓



GUÍA INYECTORES

FUEL INKECTOR GUIDE

GUIDA INNIETTORE
COMBUTIBILE

GUIDE DES INJECTEURS

	SERIE	CYL	REF
10 EFI, 15 EFI 15EFI SEAPRO, 20EFI	OR832820 +	2	REC8M0134459
25 EFI	OR106966 +	3	REC8M0091784
30 EFI	OP153500 - OP400999	3	REC892123002
30 EFI	OR106999 +	3	REC8M0091784
30 EFI	OT409000 - 1B226999	3	REC892123002
30 EFI	1C109093 - 1C456299	3	REC892123002
30 EFI	1C456300 +	3	REC892123002
40 EFI	OP153500 - OP400999	BEL 3	REC892123002
40 EFI	OP401000 - OP515896	BEL 3	REC892123002
40 EFI	OP409000 - 1B226999	USA 3	REC892123002
40 EFI	1B227000 - 1B355027	USA 3	REC892123002
40 EFI	1C000001 - 1C043416	3	REC892123002
40 EFI	1C043417 - 1C456299	3	REC892123002
40 EFI	1C456300 +	3	REC892123002
40 EFI	OP153500 - OP400999	BEL 4	REC892123002
40 EFI	OP401000 - OP515896	BEL 4	REC892123002
40EFI	OP515897 - OP580772	BEL 4	REC892123002
40 EFI	OT409000 - 1B355222	USA 4	REC892123002
40 EFI	1C000001 - 1C050251	USA 4	REC892123002
40 EFI	1C050252 - 1C453839	USA 4	REC892123002
40 EFI & SEAPRO	1C453840 +	USA 4	REC892123002
50 EFI	OP153500 - OP400999	BEL 4	REC892123002
50 EFI	OP401000 - OP515896	BEL 4	REC892123002
50 EFI	OP515897 - OP580772	BEL 4	REC892123002
50 EFI	OT409000 - 1B355222	USA 4	REC892123002
50 EFI	1C000001 - 1C050251	USA 4	REC892123002
50 EFI	1C050252 - 1C453839	USA 4	REC892123002
50 EFI	1C453840 +	USA 4	REC892123002
60 EFI	OP153500 - OP400999	BEL 4	REC892123002
60 EFI	OP401000 - OP515896	BEL 4	REC892123002
60 EFI	OP515897 - OP580772	BEL 4	REC892123002
60 EFI	OT409000 - 1B355222	USA 4	REC892123002
60 EFI	1C000001 - 1C050251	USA 4	REC892123002
60 EFI	1C050252 - 1C453839	USA 4	REC892123002
60 EFI & SEAPRO	1C453840 +	USA 4	REC892123002
75 EFI	1B172291 - 1B366822	USA 4	REC6D8-13761-00
75 EFI	1B366823 - 2B094995	USA 4	REC8M0041571
75 EFI & SEAPRO	2B095049 +	4	REC8M6002428
80 EFI	OP459572 - 2B094995	BEL 4	REC8M0041571
80 EFI	1B227000 - 1B366822	USA 4	REC6D8-13761-00
80 EFI	1B366823 - 2B094995	USA 4	REC8M0041571
80 EFI	2B095049 +	4	REC8M6002428
90 EFI	1B172291 - 1B366822	USA 4	REC6D8-13761-00
90 EFI	1B366823 - 2B094995	USA 4	REC8M0041571
90 EFI & SEAPRO	2B095049 +	USA 4	REC8M6002428
100 EFI	OP459572 - 2B094995	BEL 4	REC8M0041571
100 EFI	1B227000 - 1B366822	USA 4	REC6D8-13761-00
100 EFI	1B366823 - 2B094995	USA 4	REC8M0041571
100 EFI	2B095049 +	USA 4	REC8M6002428
115 EFI	OT178500 - OT800999	USA 4	REC68V-8A360-00
115 EFI	OT801000 - 1B226999	USA 4	REC68V-8A360-00
115 EFI	1B227000 - 1B366822	USA 4	REC68V-8A360-00
115 EFI	1B366823 - 2B094995	USA 4	REC8M0041571
115 EFI & SEAPRO (XS)	2B095049 +	4	REC8M6002428
135	2B131942 +	4	REC8M6002428
135 VERADO	OP419487 - OP464487	BEL 4	REC8M0041571
135 VERADO	OP464488 - OP514868	BEL 4	REC8M0041571
135 VERADO	OP514869 - OP593020	BEL 4	REC8M0041571
135 VERADO	1B227000 - 1B381711	USA 4	REC8M0041571
135 VERADO	1B381712 - 1B517158	USA 4	REC8M0041571
135 VERADO	1B517159 - 2B576734	USA 4	REC8M0041571
150	1B905505 +	4	REC8M6002428
150 SEAPRO	2B139139 +	4	REC8M6002428
150 Pro XS	2B550139 +	4	REC8M6002428
150 VERADO	OP419487 - OP464487	BEL 4	REC8M0041571
150 VERADO	OP464488 - OP514868	BEL 4	REC8M0041571

	SERIE	CYL	REF
150 VERADO	OP514869 - OP593020	BEL 4	REC8M0041571
150 VERADO	1B227000 - 1B381711	USA 4	REC8M0041571
150 VERADO	1B381712 - 1B517158	USA 4	REC8M0041571
150 VERADO	1B517159 - 2B576734	USA 4	REC8M0041571
175 VERADO	OP419487 - OP464487	BEL 4	REC8M0041571
175 VERADO	OP464488 - OP514868	BEL 4	REC8M0041571
175 VERADO	OP514869 - OP593020	BEL 4	REC8M0041571
175 VERADO	1B227000 - 1B381711	USA 4	REC8M0041571
175 VERADO	1B381712 - 1B517158	USA 4	REC8M0041571
175 VERADO	1B517159 - 2B576734	USA 4	REC8M0041571
200 VERADO	OP514869 - OP593020	BEL 4	REC8M0041571
200 VERADO	1B517159 - 2B576734	USA 4	REC8M0041571
200 VERADO	OP409357 - OP464487	BEL 6	REC8M0041571
200 VERADO	OP464488 - OP520552	BEL 6	REC8M0041571
200 VERADO	OP520553 - 2B144122	BEL 6	REC8M0041571
200 VERADO	OT980000 - 1B226999	USA 6	REC8M0041571
200 VERADO	1B227000 - 1B381711	USA 6	REC8M0041571
200 VERADO	1B381712 - 1B517433	USA 6	REC8M0041571
200 VERADO	1B517434 - 2B144122	USA 6	REC8M0041571
200 VERADO	2B144123 - 2B578935	USA 6	REC8M0041571
200 Pro VERADO	2B034840 - 2B144122	6	REC8M0041571
200 Pro VERADO	2B144123 - 2B577715	6	REC8M0041571
225 EFI	OT653945 +	USA 6	REC69J-13761-00
225 VERADO	OP409357 - OP464487	BEL 6	REC8M0041571
225 VERADO	OP464488 - OP520552	BEL 6	REC8M0041571
225 VERADO	OP520553 - 2B144122	BEL 6	REC8M0041571
225 VERADO	OT980000 - 1B226999	USA 6	REC8M0041571
225 VERADO	1B227000 - 1B381711	USA 6	REC8M0041571
225 VERADO	1B381712 - 1B517433	USA 6	REC8M0041571
225 VERADO	1B517434 - 2B144122	USA 6	REC8M0041571
225 VERADO	2B144123 - 2B578935	USA 6	REC8M0041571
250 VERADO	OP409357 - OP464487	BEL 6	REC8M0041571
250 VERADO	OP464488 - OP520552	BEL 6	REC8M0041571
250 VERADO	OP520553 - 2B144122	BEL 6	REC8M0041571
250 VERADO	OT980000 - 1B226999	USA 6	REC8M0041571
250 VERADO	1B227000 - 1B381711	USA 6	REC8M0041571
250 VERADO	1B381712 - 1B517433	USA 6	REC8M0041571
250 VERADO	1B517434 - 2B144122	USA 6	REC8M0041571
250 VERADO	2B144123 - 2B578935	USA 6	REC8M0041571
250 PRO VERADO	1B830170 - 2B144122	6	REC8M0041571
250 PRO VERADO	2B144123 - 2B577715	USA 6	REC8M0041571
275 VERADO	OP409357 - OP464487	BEL 6	REC8M0041571
275 VERADO	OP464488 - OP520552	BEL 6	REC8M0041571
275 VERADO	OP520553 - 2B144122	BEL 6	REC8M0041571
275 VERADO	OT980000 - 1B226999	USA 6	REC8M0041571
275 VERADO	1B227000 - 1B381711	USA 6	REC8M0041571
275 VERADO	1B381712 - 1B517433	USA 6	REC8M0041571
275 VERADO	1B517434 - 2B144122	USA 6	REC8M0041571
275 VERADO	2B144123 - 2B578935	USA 6	REC8M0041571
300 VERADO	OP520553 - 2B144122	BEL 6	REC8M0041571
300 VERADO	1B517434 - 2B144122	USA 6	REC8M0041571
300 VERADO	2B144123 - 2B578935	USA 6	REC8M0041571
300 PRO VERADO	1B830170 - 2B144122	6	REC8M0041571
300 PRO VERADO	2B144123 - 2B577715	USA 6	REC8M0041571



P 38

REF
STA93008
STA93016

P 38

REF
GE22207

MERCURY

RECAMBIOS
MARINOS



CARBURADOR

CARBURATOR

CARBURATORE



CARBURATEUR

CARBURADOR COMPLETO FULL CARBURATOR





REF	OEM		2T STROKES	4T STROKES
PAF8-05040000	339-895110T01 339-895110T11		8 Et 9.9, (209 cc) OP325500+	✓

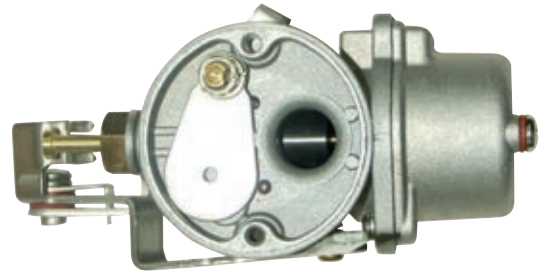

CARBURATORE COMPLETO CARBURATEUR COMPLET

REF	OEM		2T STROKES	4T STROKES
REC3303-8231752			2.5 (017000+) 3 (0A855097 - 0G710612) 3.3 0D901217+	✓



REF	OEM		2T STROKES	4T STROKES
REC3303-812648T			4, 5 (OP017000+)	✓
			4, 5 (9589154 - OP016999)	
			4, 5 (1 cyl Japan) (9542671+)	

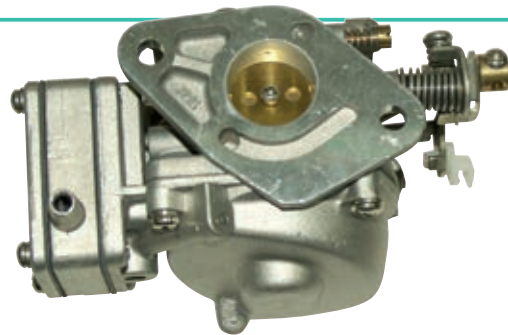

KITS CARBURADORES



CARBURETOR KITS

KIT CARBURATORI



KIT CARBURATEUR

REF	OEM		2T STROKES	4T STROKES
REC6A1-W0093-01	92520M		2 HP	✓

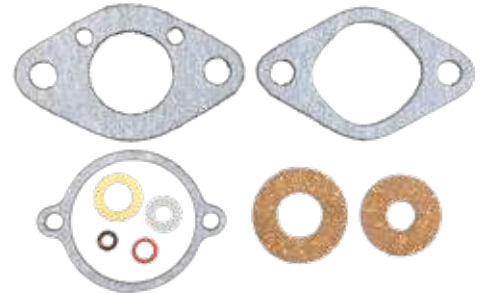

REF	OEM		2T STROKES	4T STROKES
REC1395-2015	1399-1717 1399-2015 1399-3523		4, 4.5 HP 4 CYL	✓



REF	OEM		2T STROKES	4T STROKES
REC40470	1395-9262-1		3.9-110 INLINE EARLY	✓



REF	OEM		2T STROKES	4T STROKES
REC6G1-W0093-00	11502M		6C/D 8C	✓



REF	OEM	2T STROKES	4T STROKES
REC1395-97611	1395-97611	1395-9645	
	1395-9761	1395-9377	
	1395-9803	1395-9179	
	1395-9725	1395-811357	
		6 -25 HP	✓

REF	OEM	2T STROKES	4T STROKES
REC677-W0093-00	84473M	W8 MARATHON	✓

REF	OEM	2T STROKES	4T STROKES
REC689-W0093-02	84456M	25, 28, 30 HP	✓

REF	OEM	2T STROKES	4T STROKES
REC1395-5198	1399-5135	7.5, 9.8 HP	
	1399-5198	TILLOTSON STAMPED	✓

REF	OEM	2T STROKES	4T STROKES
REC8542561	854256 1	25 - 60 HP	✓

REF	OEM	2T STROKES	4T STROKES
REC1399-5137	1399-5137	7.5 - 50 HP	✓
		TILLOTSON STAMPED	

REF	OEM	2T STROKES	4T STROKES
REC1395-823635-4	1395-823635-4	30 - 125HP	✓

REF	OEM	2T STROKES	4T STROKES
REC6E7-W0093-01	814481M	8.9 - 17 HP	✓

REF	OEM	2T STROKES	4T STROKES
REC1395-9650		30, 40, 45 HP	✓

REF	OEM	2T STROKES	4T STROKES
REC66M-W0093-01	802706A1	8, 9.9, 13.5, 15 HP	✓

REF	OEM	2T STROKES	4T STROKES
REC1395-8112231	1395-811223-1	30 - 125 HP	✓

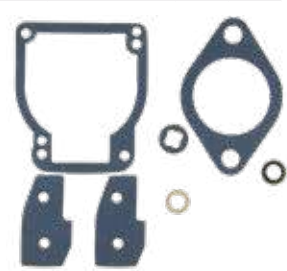

REF	OEM	2T STROKES	4T STROKES
REC1395-9651	1395-9651	40, 45, 50 HP 4 CYL	✓



REF	OEM	2T STROKES	4T STROKES
REC40480	1395-5109-1	CHRYSLER 35 - 50 HP FORCE 50 - 85 HP	✓



REF	OEM	2T STROKES	4T STROKES
REC1395-9024	1395-9024	45, 50 HP 4 CYL WALLBRO	✓

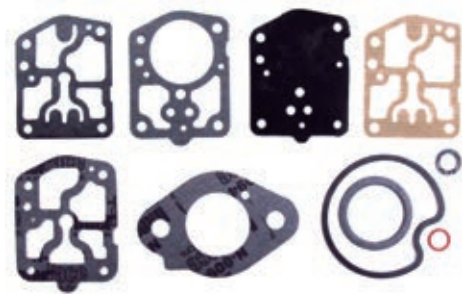

REF	OEM	2T STROKES	4T STROKES
REC6E9-W0093-03	97667M	40C TWIN CARB	✓



REF	OEM	2T STROKES	4T STROKES
REC6H1-W0093-01-00	84475M	40B	✓



REF	OEM	2T STROKES	4T STROKES
REC6E9-W0093-02	17068M	40 HP TWIN CARB	✓



REF	OEM	2T STROKES	4T STROKES
REC1395-6200	1395-6200	50, 60, 70, 75, 80 HP	✓





REF	OEM	2T STROKES	4T STROKES
REC6F6-W0093-00	11810M 11810T	W40 MARATHON	✓





REF	OEM	2T STROKES	4T STROKES
REC696-W0093-00	84419M	60 HP 2 CYL	✓

Para dos carburadores
For two carburetors
Contenuto per due carburatori
Pour 2 carburateurs



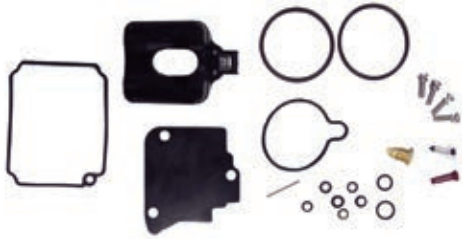

REF	OEM		2T STROKES	4T STROKES
REC67F-W0093-00	804346T01 804346T1 804346T02		75, 90 HP	✓



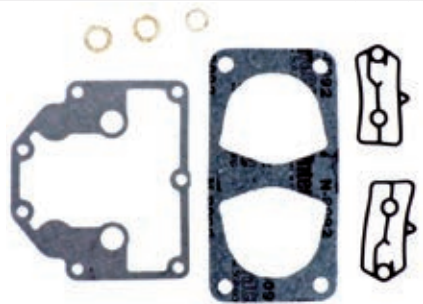

REF	OEM		2T STROKES	4T STROKES
REC8107493	810749-3		V135 - 225 HP	✓





REF	OEM		2T STROKES	4T STROKES
REC1395-48401	1395-4808-1		90 - 150 HP	✓



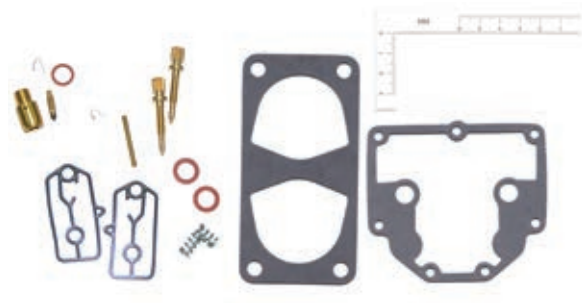

REF	OEM		2T STROKES	4T STROKES
REC1395-811691-3	1395-811691 3		V135 - 225 HP	✓



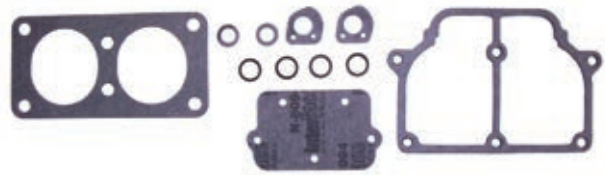

REF	OEM		2T STROKES	4T STROKES
REC1395-6452	1395-6452 1395-8506		135 - 225 HP 2.4L	✓

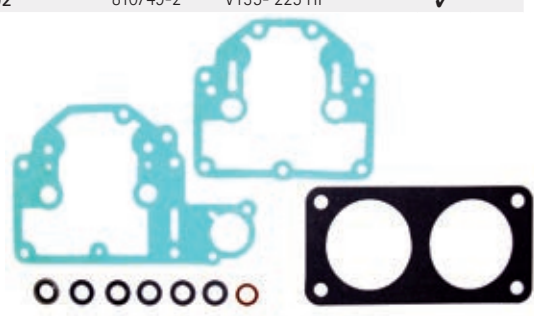

REF	OEM		2T STROKES	4T STROKES
REC8107492	810749-2		V135 - 225 HP	✓



REF	OEM		2T STROKES	4T STROKES
REC1395-811691-2	1395-811691 2		V135 - 225 HP	✓



GUÍA KITS CARBURADOR GUIDE, CARBURATOR KIT GUIDA KIT CARBURATORE GUIDE KIT CARBURATEURS

4T STROKES	REF	4T STROKES	REF
8 (Bodensee)	OP400999+	30	OP017000 - OP153499
9.9 (323cc)	OP075166 - OP400999	30 CARB (3 cyl)	OP153500 - OP400999
13.5 Internat.	OP134638+	40	OP017000 - OP153499
15	OP9973100+	40 CARB (3 cyl)	OP153500+
75 (Bodensee)	OG960500 - 1B226999	40 (4 cyl)	OP094500 - OP206999
90	OG960500 - 1B226999	50 (4 cyl)	OP094500 - OP206999
25	9973100	60 (4 cyl)	OP094500 - OP206999

GUÍA KITS CARBURADOR

GUIDE, CARBURATOR KIT

GUIDA KIT CARBURATORE

GUIDE KIT CARBURATEURS

2T STROKES		REF
2B	6A1-000101 +	REC6A1-W0093-01
6	9464526	REC1395-97611
6 C/ D	6H8 & 6H6	REC6G1-W0093-00
8	9461526	REC1395-97611
8 B	677	REC677-W0093-00
8 C	6G1	REC6G1-W0093-00
W8 (W/Marathon) M/ML/SUL	677	REC677-W0093-00
9.9	9461526	REC1395-97611
9.9 C	6E7/ 70-71 (682) M-682-070796+ ML-682-368040+ E-682-251511+ EL-682-55146+	REC6E7-W0093-01
10 Sea Pro , Viking		REC1395-97611
15	9542620	REC1395-97611
15 SeaPro	992700	REC1395-97611
15 Viking	OP32550 +	REC1395-97611
15C	6E8/ 71 (684) M-684-052848+ ML-684-332302+ E-684-252381+ EL-684-553251+	REC6E7-W0093-01
15 C		REC6E7-W0093-01
20 (2 cyl)	9415101	REC1395-97611
20 JET	9807909 - OP016999	REC1395-97611
25 (2 cyl)	9415101	REC1395-97611
25, 25 SeaPro (super 15)	9415101	REC1395-97611
25A	M-648-24991+ ML-648-64046+ E-648-27056+ EL-648-56526+	REC689-W0093-02
25 C	695	REC689-W0093-02
28	M-664-05306+ ML-664-41686+ E-664-26236+ EL-664-57421+	REC689-W0093-02
30 (2Cyl)	9854537	REC1395-823635-4
30A	M-689-230100+ ML-689-530100+ E-689-250100+ EL-689-550100+	REC689-W0093-02

2T STROKES		REF
30 Jet (3Cyl)	9973100	REC1395-823635-4
30 Jet	9570790	REC1395-9650
40 (2 Cyl)	9854537	REC1395-823635-4
40 (3 Cyl)	9973100	REC1395-823635-4
40 (4 Cyl)	9570790	REC1395-9650
40 (Twin Carb)	6E9-000106 -42316	REC6E9-W0093-03
40 (Twin Carb) (w/oil inject) (w/auto blend)	6E9-	REC6E9-W0093-02
40 A/ B (above / thru prop. exhaust)	676	REC6H1-W0093-01-00
40 (W/Marathon)	6F6	REC6F6-W0093-00
40 Jet	OP094500+	REC1395-823635-4
45 Jet	9885385+	REC1395-823635-4
45 (4 Cyl)	9466692+	REC1395-9650
48	M-670-02641+ ML-670-34581+	REC696-W0093-00
W48	670	REC696-W0093-00
50 (3 Cyl)	9885345+	REC1395-823635-4
55 / W55	663	REC696-W0093-00
55 (3 Cyl)	9885345+	REC1395-823635-4
60	675	REC696-W0093-00
60 (3Cyl) & (BIGFOOT)	9885345+	REC1395-823635-4
65 Jet	9793577 - OP325499	REC1395-823635-4
75 (3 Cyl)	9793577+	REC1395-823635-4
80 Jet	9793577 - OP325499	REC1395-823635-4
90 (3 Cyl)	9793577+	REC1395-823635-4
100 (4 Cyl)	9523034 - OP058999	REC1395-823635-4
115 (4 Cyl)	OP017000+	REC1395-823635-4
125 (4 Cyl)	3793577+	REC1395-823635-4
V-135/V-150/ V-175/V-200HP	OG303045 +	REC1395-811691-2
V-135/V-150/ V-175/V-200HP	OG303046 +	REC1395-811691-3
225HP (3.0L Carb) (Sea Pro)	OG303045+	REC1395-811691-2
225HP (3.0L Carb) (Sea Pro)	OG303046 +	REC1395-811691-3
XR-6	OG303045+	REC1395-811691-2
XR-6	OG303046+	REC1395-811691-3

KIT AGUJA CARBURADOR

NEEDLE VALVE, KIT

KIT SPILLO CONICO CARBURATORE

KIT SIEGE, POINTEAU ET GICLEUR

REF	OEM	2T STROKES	4T STROKES	
REC1399-1473	1395-9258 1399-1138 1399-1473	3.9 - 15 HP	✓	

REF	OEM	2T STROKES	4T STROKES	
REC1395-8318	1395-8318	4 - 115 HP	✓	

REF	OEM	2T STROKES	4T STROKES	
REC6G1-14546-00	11490M	6C (677) 6D (6H6) 8C (6G1)	✓	

REF	OEM	2T STROKES	4T STROKES	
REC6E8-14390-12	14216M	W8 (677) W15 (684) 15C (684) (6E8-04)	✓	

REF	OEM	2T STROKES	4T STROKES	
REC626-14390-90	80447M	15C (684) 8K (680) 8B (677) 9.9C (682) W8 (677) W15 (662)	✓	

REF	OEM	2T STROKES	4T STROKES	
REC677-14343-68	95495M	15C (684)#136 W15 (684)	✓	

REF	OEM	2T STROKES	4T STROKES	
REC6H3-14590-00	17050M	75 (OG960500+) 75 BODENSEE (OG960500+) 90 (OG960500+)	✓	

REF	OEM	2T STROKES	4T STROKES	
REC19271-1	19271-1	75 HP 4 CYL	✓	

REF	OEM	2T STROKES	4T STROKES
REC1395-7824	1395-7824 V135 - V200	✓	



REF	OEM	2T STROKES	4T STROKES
REC1395-811690-1	1395-811690-1 V135 - 225 HP	✓	



AGUJA CARBURADOR NEEDLE VALVE

REF	OEM	2T STROKES	4T STROKES
REC1395-9595-1	1395-9595-1 50 HP 3 CYL	✓	



SPILLO CONICO POINTEAU

REF	OEM	2T STROKES	4T STROKES
REC809570-1	809570-1 8 - 50 HP	✓	



REF	OEM	2T STROKES	4T STROKES
REC1395-9022	1395-9022 8 - 50 HP	✓	



TORNILLOS CARBURADOR BOLT SCREW

REF	OEM
REC647-14323-00	4A 5A/C 8A/B/K/W8 9.9C 15A/C/K 20C 25C/K/K25/W25 28 30A/W30



VITE CARBURATORE

REF	OEM	2T STROKES	4T STROKES
REC6A0-14325-00	10-41889M 8 - 50 HP M3x5		✓



VIS DE CARBURATEUR

BOYAS FLOATS

REF	OEM	2T STROKES	4T STROKES
REC16253	16253 4, 5, 6, 8, 9.8 HP	✓	



GALLEGGIANTE

REF	OEM	2T STROKES	4T STROKES
REC6G1-14985-00	11489M 6C/D 8C	✓	



FLOTTEUR

REF	OEM	2T STROKES	4T STROKES
REC6E7-14385-00	14180M 4A (M070824-ML325784+) 5C (M144067-ML425197+) W8 9.9C (6E7-72) 15C / W15 (6E8-04)	✓	



REF	OEM	2T STROKES	4T STROKES
REC676-14966-00	22-83369M 6C/D 40A/B/C 75 90	✓	✓





REF	OEM	2T STROKES	4T STROKES
REC647-14385-00	80450M 4A 5A/C 8A / B / K-L-S 9.9C 15A / C / K / W15 K40 W8 (M)(ML)(SVL)	✓	



REF	OEM	2T STROKES	4T STROKES
REC162532	162532 8 HP 9.9 HP 2005+	✓	



new

REF	OEM	 2T STROKES	 4T STROKES
REC809569	809569	9, 9.9, 13.5, 40, 45, 50 HP	✓





new

REF	OEM	 2T STROKES	 4T STROKES
REC6H4-14985-01	804184	75 HP (OG960500-1B226999) 90 HP (OG960500-1B226999)	✓





REF	OEM	 2T STROKES	 4T STROKES
REC648-14385-00	80591M	20C 25C/K/K25/W25 28 30A/W30	✓



REF	OEM	 2T STROKES	 4T STROKES
REC1395-8673	1395-8983 1395-8673	90, 115 HP 6 CYL	✓





REF	OEM	 2T STROKES	 4T STROKES
REC1395-9594	1395-9594	30 - 115 HP	✓



REF	OEM	 2T STROKES	 4T STROKES
REC1395-7623	1395-7623 1395-9267	V150 - V200 HP	✓



new

REF	OEM	 2T STROKES	 4T STROKES
REC676-14985-01	891730A01	40 HP (676)	✓



KIT

REF	OEM	 2T STROKES	 4T STROKES
REC19273	19273	WM-3, 5, 6, 8, 9, 10, 77, 12, 13, 13A, 14, 15, 15A, 16, 16A, 17, 18	✓



REF	OEM	 2T STROKES	 4T STROKES
REC8M6000359	8M6000359 880596504 880596522 880596524 8M0007943	75 - 300 HP VST SYSTEM	✓



PASADOR DE BOYA		PIN FLOAT		SPINOTTO GALLEGGIANTE		AXE DE FLOTTEUR			
REF	OEM		2T STROKES	4T STROKES	REF	OEM		2T STROKES	4T STROKES
REC647-14386-10	17-80451M	4A			REC6E5-14386-01	17-11794M	9.9 / 13.5 / 15HP		
		5C					40 / 45 / 50HP		✓
		8A / K / W8		✓			20C / 25K / 30A / K40 / 40 Italy		
		8 Bondensee / Inter.					40A		
REC688-14548-00	17-97730M	9.9C (323 cc.)			REC663-14548-00	17-81278M	40B		
		15C / K / W15		✓			48 / W-48		✓
		6C / D					55		
REC676-14186-00	17-92639M	8C		✓			60 (2 cyl)		
		40C							
		6C / D							
		8C							
		40A / B / C		✓					
		W-48							
55									
W-55									
60 (2 cyl)									
75 HP									
90 HP				✓					



JUNTAS FILTRO CARBURADOR		GASKETS, CARBURETOR FILTER		GUARNIZIONE FILTRO CARBURATORE		JOINT FILTRE CARBURATEUR	
CORTO SHORT CORTO COURT							
REF	OEM						
REC27-25849	27-25849	10-115 HP (1-6 cyl) (1970-85)					

ACELERADOR		ACCELERATOR		ACCELERATORE		ACCELERATEUR	
CABLE ACELERADOR		THROTTLE CABLE		CAVO ACCELERATORE		CÂBLE ACCELERATEUR	
REF	OEM		CAMBIO SHIFT CAMBIO CHANGE				
REC43242-5	43242-5	30 HP, 2 cyl					
	43242-7	40 HP, 2 cyl					
REC43242-6	43242-6	6 HP / 8 HP / 9.9 HP, XR10			Lateral Side Laterale Lateral		
		10 Magnum, Marathon, Sea Pro					
		Viking, 15 hp Marathon, Sea Pro					
		Viking, 20 (2 cyl.), 20 Jet					
REC43242-5	86210	25 Marathon, Sea Pro					
		7.5 HP et 9.8 HP					
REC43242-9	43242-9	6 HP / 8 HP / 9.9 HP / 9.9 HP (4T)			Manual Handle Manuale Manuel		
		XR10, 10 Magnum					
REC43242-3	43242-3	13.5 HP (4T), 15 HP, 15 HP(4T)					
		15 Marathon XP, 15 Sea Pro XP					
REC677-26301-02	95405M	20 (2 cyl.) 20 Jet, 25 (2 cyl.)					
		25 Marathon (2 cyl.), 25 Sea Pro (2 cyl.)					
REC6E0-26301-01	11921M	8K / W8					
		AC / A / AS					
		5C / CS / CMH					



SEPARADOR DE VAPOR

VAPOR SEPARATOR

SEPARATORE DI
VAPORESÉPARATEUR DE
VAPEUR

30, 40, 50, 60 HP EFI VST

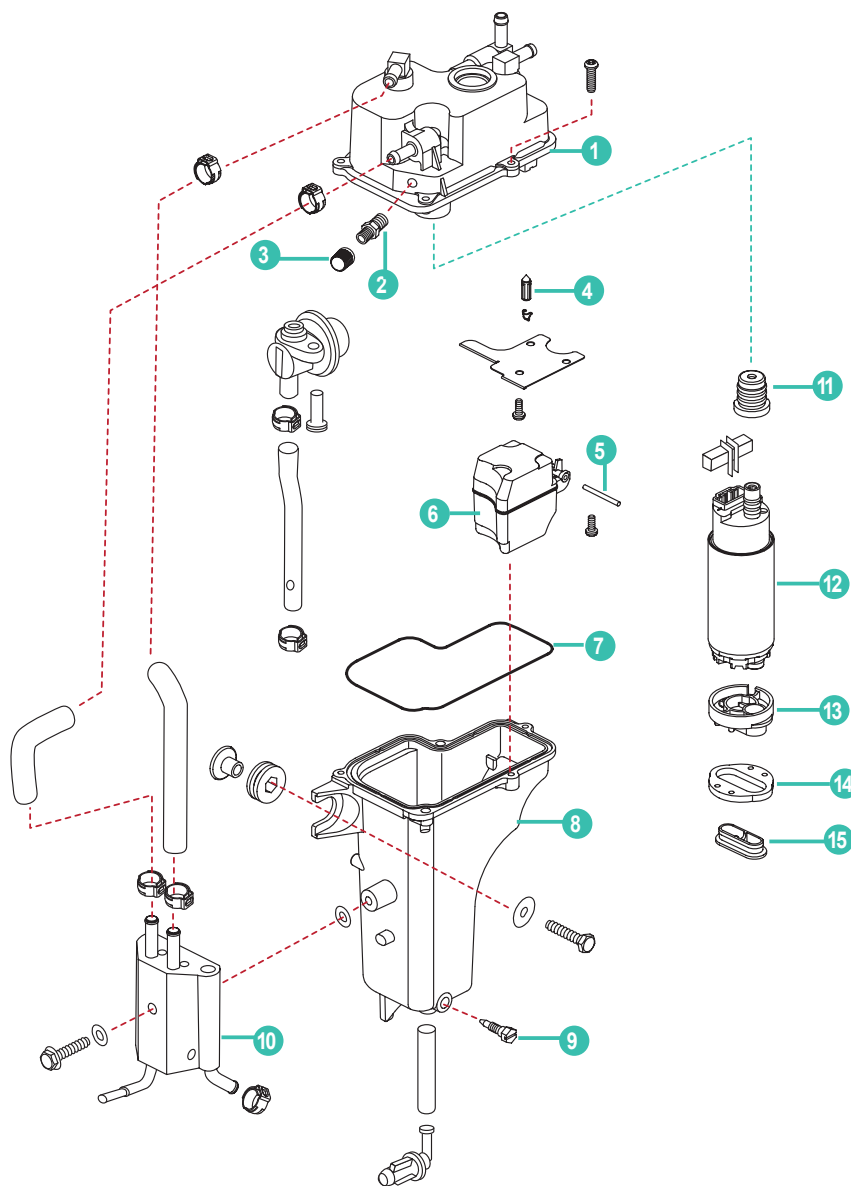

	REF	OEM				UN.	
	PAF40-05100000EI	892267T03	SEPARADOR VAPOR COMPLETO	VAPOR SEPARATOR ASSY	SEPARATORE DI VAPORE	SÉPRATEUR DE VAPEUR	1
1	PAF40-05100100EI	892267T57	TAPA COMPLETA	COVER ASSY	COPERCHIO COMPLETO	COUVERCLE COMPLÈTE	1
2	PAF40-05100201EI	892267537	VÁLVULA	VALVE	VÁLVOLA	SOUPAPE	1
3	PAF40-05100202EI	883220	TAPA	CAP	TAPPO	BOUCHON	1
4	PAF40-05100301EI	892267A52	AGUJA	NEEDLE VALVE	AGHI	POINTEAU	1
5	PAF40-05100002EI	892267528	PIN BOYA	FLOAT PIN	PIN GALLEGIANTE	AXE DE FLOTEUR	1
6	PAF40-05100001EI	892267527	BOYA	FLOAT	GALLEGIANTE	FLOTEUR	1
7	PAF40-05100704EI	892267530	JUNTA	GASKET	GUARNIZIONE	JOINT	1
8	PAF40-05100701EI	892267A54	CUERPO COMPLETO	BODY ASSY	CORPO COMPLETO	RESERVOIR COMPLET	1
9	PAF40-05100703EI	892267506	TORNILLO DRENAJE	SCREW DRAIN	VITE DRENAGGIO	VIS DE VIDANGE	1
10	PAF40-05100800EI	892267A55	EMFRIADOR GASOLINA	COOLER FUEL	RAFFREDDATORE CARBURANTE	REFROIDISSEUR DE CARBURANT	1
11	PAF40-05100501EI	892267521	ADAPTADOR	RUBBER SLEEVE	ADATTATORE IN GOMMA	MANCHON CAOUTCHOUC	1
12	PAF40-05100500EI	892267A51	KIT BOMBA COMBUSTIBLE	PUMP KIT	KIT POMPA COMBUSTIBILE	KIT POMPE À ESSENCE	1
13	PAF40-05100504EI	892267510	CUBIERTA, BOMBA COMBUSTIBLE	PADDING BLOCK, FUEL PUMP	COPERCHIO POMPA COMBUSTIBILE	COUVERCLE POMPE À ESSENCE	1
14	PAF40-05100503EI	892267523	PLACA	RUBBER PAD	PIASTRA POMPA	TAMPON CAOUTCHOUC POMPE	1
15	PAF40-05100502EI	892267534	FILTRO	FILTER NET	FILTRO POMPA	FILTRE DE POMPE	1

SISTEMA ELÉCTRICO ELECTRIC SYSTEM

SISTEMA ELETTRICO SYSTÈME ÉLECTRIQUE

SENSORES	SENSORS	SENSORE	CAPTEURS
SENSOR TPS	TPS SENDER	SENSORE TPS	CAPTEUR TPS

REF	OEM	2T STROKES	4T STROKES
REC69J-85885-00	888204T	225 EFI V6 (OT653945+)	✓



new

REF	OEM	2T STROKES	4T STROKES
REC6C5-85885-00	880884001	75, 80, 90, 100 EFI	✓



new

REF	OEM	2T STROKES	4T STROKES
REC8M0125617	881070T 8M125617	30 - 150 HP	✓



new

REF	OEM	2T STROKES	4T STROKES
REC68V-85885-00	880884T	115 EFI (OT178500-1B366822)	✓



new

SENSOR MAP/MAT	MAP/MAT SENSOR	SENSORE MAP/MAT	CAPTEUR MAP/MAT
----------------	----------------	-----------------	-----------------

REF	OEM	2T STROKES	4T STROKES
REC13650-56B00	880882T	25, 30 EFI	✓



new

REF	OEM	2T STROKES	4T STROKES
REC891663001	891663001 891663	75 - 450 HP	✓



new

REF	OEM	2T STROKES	4T STROKES
REC68F-83688-00	880885001	75, 80, 90, 100 EFI	✓



new

REF	OEM	2T STROKES	4T STROKES
REC854445	854445	100 EFI, 115 EFI, 90 EFI 90, 115 DFI (3 Cyl.) 1.5 L 200 DFI (3 Cyl.) 1.5 L 200 (3.0 L DFI) (EFI) (DTS) 225 (3.0 L DFI) (EFI) (DTS) Seapro 250 (3.0 L EFI) (DFI) 40, 30 EFI (3 Cyl.) 40, 50, 60 EFI (4 Cyl.) 75 DFI (3 Cyl.) (1.5 L) 75, 80 EFI V-115 - V-175 DFI (2.5 L) V-150 - V-200 EFI (2.5 L)	✓



new



REF	OEM		2T STROKES	4T STROKES
REC68V-82380-00	880885T	115 EFI (OT178500-OT801000) 115 EFI (1B226999-1B366822) 225 EFI (OT653945+)		✓

new

REF	OEM		2T STROKES	4T STROKES
REC8M0142690	8M0142690	175 - 450 HP		✓



new

REF	OEM		2T STROKES	4T STROKES
REC8M6000639	8M6000639 8M0010248 885548002 885548001	135 - 400 HP		✓



SENSOR TEMPERATURA DEL AGUA **SENSOR, WATER TEMPERATURE**

REF	OEM		
REC12415	12415	1/8"-27NPT	30 Jet 40 / 100 / 115 (4 cyl) 40 / 50 / 60 / 70 / 75 / 80 / 90 (3 cyl) 300 (3.4L) V-50 Work / XR-2 V-135 - V-200



SENSORE TEMPERATURA ACQUA **SONDE DE TEMPERATURE**

new

REF	OEM		2T STROKES	4T STROKES
REC804295T	804295T	75, 80, 90, 100, 115 HP		✓



new

REF	OEM		2T STROKES	4T STROKES
PAF40-05000400	889575	25 - 300 HP	✓	✓



new

REF	OEM		2T STROKES	4T STROKES
REC8M0142542	8M0142542 8M0010146	135 - 450 HP VERADO		✓



new

REF	OEM		2T STROKES	4T STROKES
REC8M0148668	8M0148668 885342002 885342001	30 - 400 HP	✓	✓





SENSOR CAUDAL AGUA WATER FLOW SENSOR SENSORE FLUSSO ACQUA CAPTEUR DE FLUX D'EAU



REF	OEM	
REC8M6000623	V-135 - V-175 DFI (2.5 L) 110 JET (2.5 L) 175 PRO XS (2.5 L)	

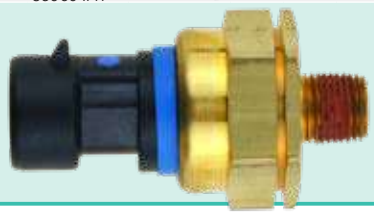

SENSOR PRESIÓN DE AGUA WATER PRESSURE SENSOR SENSORE PRESSIONE ACQUA SONDE DE PRESSION D'EAU

REF	OEM		2T STROKES	4T STROKES	PSI
REC881879T11	881879T11 881879011 881879A6 859210T 859210 859604A1			✓	0-100



REF	OEM		2T STROKES	4T STROKES
REC881879T26	881879T26 881879A20 881879A19		135 - 400 HP	✓



SENSOR AGUA EN COMBUSTIBLE WATER-IN-FUEL SENSOR SENSORE ACQUA IN COMBUSTIBILE SONDE PRESENCE D'EAU



REF	OEM	
REC8M0021043	8M0021043	L6 VERADO





SENSOR PRESION DE ACEITE SENSOR, OIL PRESSURE SENSORE PRESSIONE DELL'OLIO SONDE DE PRESSION D'HUILE

REF	OEM		2T STROKES	4T STROKES
PAF15-07010100	87-803538		4 - 25 hp	✓





REF	OEM		2T STROKES	4T STROKES
REC8M6000637	8M6000637 8M0010469		200 - 400 HP	✓









REF	OEM		2T STROKES	4T STROKES
REC8M0142688	71-8M0142688		175- 450 HP	✓



REF	OEM		2T STROKES	4T STROKES
REC8M6000634	8M6000634 889659002 897447002		75 - 275 HP	✓



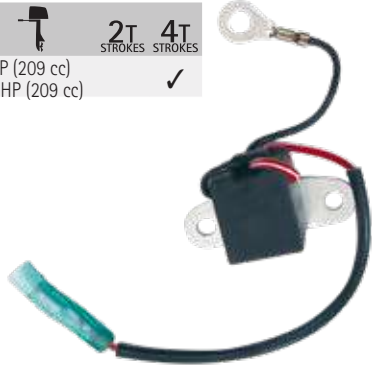







SENSOR POSICIÓN CIGÜENAL		POSITION CRANCKSHAFT SENDER		SENSORE POSIZIONE ALBERO		CAPTEUR DE POSITION DE VILEBREQUIN	
REF	OEM	 2T STROKES	 4T STROKES	 2T STROKES	 4T STROKES	new	
REC16066004	16066004	8 HP (209 cc) 9.9 HP (209 cc)	✓	REC8M0082988	8M0082988 8M0030022 828358 8283582	30 - 450 HP	✓ ✓

SENSOR ÁRBOL DE LEVAS		CAMSHAFT POSITION SENDER		SENSORE ALBERO A CAMME		CAPTEUR DE POSITION D'ARBRE A CAMES	
REF	OEM	 2T STROKES	 4T STROKES	new			
REC8M0011987	8M0011987 880609	75 - 450 HP	✓				

SENSOR IAT		IAT SENSOR		SENSORE IAT		SONDE IAT	
REF	OEM	new					
REC13650-52G00	898101118						

SENSOR IAC		IAC SENSOR		SENSORE IAC		SONDE IAC	
REF	OEM	 2T STROKES	 4T STROKES	new			
REC897526T	897526T	65 - 150 HP	✓				
REF	OEM	 2T STROKES	 4T STROKES	new			
REC877805T	877805T	30 - 60 HP	✓				
REF	OEM	 2T STROKES	 4T STROKES	new			
REC881447T	881447T	115 EFI (OT178500-1B366822) 225 EFI (OT653945+)	✓				

SENSOR DE PICADO

KNOCK SENDER

SENSORE ANTIDETONAZIONE

CAPTEUR KNOCK

REF	OEM		2T STROKES	4T STROKES
REC8M6003194	8M6003194 878187	VERADO 6 CYL		✓



GUÍA SENSORES EFI

EFI SENSORS GUIDE

GUIDA SENSORE EFI

GUIDE DES SONDES EFI

	CYL	PICADO KNOCK ANTIDETON. KNOCK	TEMP. AGUA WATER TEMP. TEMP. ACQUA TEMP. EAU	PRESIÓN AGUA PRESS. WATER PRES. ACQUA PRESSION EAU	PRESIÓN ACEITE OIL PRESSURE PRESSIONE OLIO PRESSION HUILE	CIGÜEÑAL CRANKSHAFT ALBERO VILEBREQUIN	ARBOL LEVAS CAMSHAFT ALBERO CAMME ARBRE À CAME	IAC	MAT	MAP	TPS
10, 15, 20 EFI SEAPRO	OR832820+	2			PAF15-07010100						
25 EFI	OR106966+	3			PAF15-07010100			REC13650-52G00			
30 EFI	OP153500- OP400999	3	REC8M0148668 PAF40-05000400		PAF15-07010100	REC8M0082988		REC877805T	REC854445	REC8M0125617	
	OR106999+	3			PAF15-07010100			REC13650-52G00			
	OT409000- 1B226999	3	REC8M0148668 PAF40-05000400		PAF15-07010100	REC8M0082988		REC877805T	REC854445	REC8M0125617	
	1C109093- 1C456299	3	PAF40-05000400		PAF15-07010100	REC8M0082988		REC877805T	REC854445	REC8M0125617	
40 EFI	1C456300+	3	PAF40-05000400		PAF15-07010100	REC8M0082988		REC877805T	REC854445	REC8M0125617	
	OP153500- OP400999	BEL 3	REC8M0148668		PAF15-07010100	REC8M0082988		REC877805T	REC854445	REC8M0125617	
	OP401000- OP515896	BEL 3	PAF40-05000400		PAF15-07010100	REC8M0082988		REC877805T	REC854445	REC8M0125617	
	OP409000- 1B226999	USA 3	REC8M0148668 PAF40-05000400		PAF15-07010100	REC8M0082988		REC877805T	REC854445	REC8M0125617	
	1B227000- 1B355027	USA 3	PAF40-05000400		PAF15-07010100	REC8M0082988		REC877805T	REC854445	REC8M0125617	
	1C000001- 1C043416	3	PAF40-05000400		PAF15-07010100	REC8M0082988		REC877805T	REC854445	REC8M0125617	
	1C043417- 1C456299	3	PAF40-05000400		PAF15-07010100	REC8M0082988		REC877805T	REC854445	REC8M0125617	
	1C456300+	3	PAF40-05000400		PAF15-07010100	REC8M0082988		REC877805T	REC854445	REC8M0125617	
	OP153500- OP400999	BEL 4	REC8M0148668 PAF40-05000400		PAF15-07010100	REC8M0082988		REC877805T	REC854445	REC8M0125617	
	OP401000- OP515896	BEL 4	REC8M0148668 PAF40-05000400		PAF15-07010100	REC8M0082988		REC877805T	REC854445	REC8M0125617	
40 EFI & SEAPRO	OP515897- OP580772	BEL 4	REC8M0148668		PAF15-07010100	REC8M0082988		REC877805T	REC854445	REC8M0125617	
	OT409000- 1B355222	USA 4	REC8M0148668 PAF40-05000400		PAF15-07010100	REC8M0082988		REC877805T	REC854445	REC8M0125617	
	1C000001- 1C050251	USA 4	REC8M0148668		PAF15-07010100	REC8M0082988		REC877805T	REC854445	REC8M0125617	
	1C050252- 1C453839	USA 4	REC8M0148668 PAF40-05000400		PAF15-07010100	REC8M0082988		REC877805T	REC854445	REC8M0125617	
	1C453840+	USA 4	REC8M0148668 PAF40-05000400		PAF15-07010100	REC8M0082988		REC877805T	REC854445	REC8M0125617	
	OP153500- OP400999	BEL 4	REC8M0148668 PAF40-05000400		PAF15-07010100	REC8M0082988		REC877805T	REC854445	REC8M0125617	
	OP401000- OP515896	BEL 4	REC8M0148668 PAF40-05000400		PAF15-07010100	REC8M0082988		REC877805T	REC854445	REC8M0125617	
	OP515897- OP580772	BEL 4	REC8M0148668 PAF40-05000400		PAF15-07010100	REC8M0082988		REC877805T	REC854445	REC8M0125617	
	OT409000- 1B355222	USA 4	REC8M0148668 PAF40-05000400		PAF15-07010100	REC8M0082988		REC877805T	REC854445	REC8M0125617	
	1C000001- 1C050251	USA 4	REC8M0148668 PAF40-05000400		PAF15-07010100	REC8M0082988		REC877805T	REC854445	REC8M0125617	
50 EFI	1C050252- 1C453839	USA 4	REC8M0148668 PAF40-05000400		PAF15-07010100	REC8M0082988		REC877805T	REC854445	REC8M0125617	
	1C453840+	USA 4	REC8M0148668 PAF40-05000400		PAF15-07010100	REC8M0082988		REC877805T	REC854445	REC8M0125617	
	OP153500- OP400999	BEL 4	REC8M0148668 PAF40-05000400		PAF15-07010100	REC8M0082988		REC877805T	REC854445	REC8M0125617	
	OP401000- OP515896	BEL 4	REC8M0148668 PAF40-05000400		PAF15-07010100	REC8M0082988		REC877805T	REC854445	REC8M0125617	
	OP515897- OP580772	BEL 4	REC8M0148668 PAF40-05000400		PAF15-07010100	REC8M0082988		REC877805T	REC854445	REC8M0125617	
	OT409000- 1B355222	USA 4	REC8M0148668 PAF40-05000400		PAF15-07010100	REC8M0082988		REC877805T	REC854445	REC8M0125617	
	1C000001- 1C050251	USA 4	REC8M0148668 PAF40-05000400		PAF15-07010100	REC8M0082988		REC877805T	REC854445	REC8M0125617	
	1C050252- 1C453839	USA 4	REC8M0148668 PAF40-05000400		PAF15-07010100	REC8M0082988		REC877805T	REC854445	REC8M0125617	
	1C453840+	USA 4	REC8M0148668 PAF40-05000400		PAF15-07010100	REC8M0082988		REC877805T	REC854445	REC8M0125617	
	OP153500- OP400999	BEL 4	REC8M0148668 PAF40-05000400		PAF15-07010100	REC8M0082988		REC877805T	REC854445	REC8M0125617	
60 EFI	OP401000- OP515896	BEL 4	REC8M0148668 PAF40-05000400		PAF15-07010100	REC8M0082988		REC877805T	REC854445	REC8M0125617	
	OP515897- OP580772	BEL 4	REC8M0148668 PAF40-05000400		PAF15-07010100	REC8M0082988		REC877805T	REC854445	REC8M0125617	
	OT409000- 1B355222	USA 4	REC8M0148668 PAF40-05000400		PAF15-07010100	REC8M0082988		REC877805T	REC854445	REC8M0125617	
	1C000001- 1C050251	USA 4	REC8M0148668 PAF40-05000400		PAF15-07010100	REC8M0082988		REC877805T	REC854445	REC8M0125617	
60 EFI & SEAPRO	1C050252- 1C453839	USA 4	REC8M0148668 PAF40-05000400		PAF15-07010100	REC8M0082988		REC877805T	REC854445	REC8M0125617	
	1C453840+	USA 4	REC8M0148668 PAF40-05000400		PAF15-07010100	REC8M0082988		REC877805T	REC854445	REC8M0125617	
	OP153500- OP400999	BEL 4	REC8M0148668 PAF40-05000400		PAF15-07010100	REC8M0082988		REC877805T	REC854445	REC8M0125617	
	OP401000- OP515896	BEL 4	REC8M0148668 PAF40-05000400		PAF15-07010100	REC8M0082988		REC877805T	REC854445	REC8M0125617	
75 EFI	OP515897- OP580772	BEL 4	REC8M0148668 PAF40-05000400		PAF15-07010100	REC8M0082988		REC877805T	REC854445	REC8M0125617	
	OT409000- 1B355222	USA 4	REC8M0148668 PAF40-05000400		PAF15-07010100	REC8M0082988		REC877805T	REC854445	REC8M0125617	
	1C000001- 1C050251	USA 4	REC8M0148668 PAF40-05000400		PAF15-07010100	REC8M0082988		REC877805T	REC854445	REC8M0125617	
75 EFI & SEAPRO	1C050252- 1C453839	USA 4	REC8M0148668 PAF40-05000400		PAF15-07010100	REC8M0082988		REC877805T	REC854445	REC8M0125617	
	1C453840+	USA 4	REC8M0148668 PAF40-05000400		PAF15-07010100	REC8M0082988		REC877805T	REC854445	REC8M0125617	
75 EFI	1B172291- 1B366822	USA 4	REC804295T						REC68F-83688-00	REC6C5-85885-00	
	1B366823- 2B094995	USA 4	REC8M0148668		REC8M6000634	REC8M0082988	REC8M0011987	REC897526T	REC891663001	REC854445	REC8M0125617
75 EFI & SEAPRO	2B095049+	4	REC8M0148668		REC8M6000634	REC8M0082988	REC897526T	REC891663001	REC854445	REC8M0125617	

MERCURY

RECAMBIOS MARINOS

			PICADO KNOCK ANTIDETON. KNOCK	TEMP. AGUA WATER TEMP. TEMP. ACQUA TEMP. EAU	PRESIÓN AGUA PRESS. WATER PRES. ACQUA PRESSION EAU	PRESIÓN ACEITE OIL PRESSURE PRESSIONE OLIO PRESSION HUILE	CIGÜENAL CRANKSHAFT ALBERO VILEBREQUIN	ARBOL LEVAS CAMSHAFT ALBERO CAMME ARBRE A CAME	IAC	MAT	MAP	TPS
80 EFI	OP459572-2B094995	BEL 4		REC8M0148668		REC8M6000634	REC8M0082988	REC8M0011987	REC897526T	REC891663001	REC8544445	REC8M0125617
	1B227000-1B366822	USA 4		REC804295T							REC68F-83688-00	REC6C5-85885-00
	1B366823-2B094995	USA 4		REC8M0148668		REC8M6000634	REC8M0082988	REC8M0011987	REC897526T	REC891663001	REC8544445	REC8M0125617
	2B095049+	4		REC8M0148668		REC8M6000634	REC8M0082988		REC897526T	REC891663001	REC8544445	REC8M0125617
90 EFI	1B172291-1B366822	USA 4		REC804295T							REC68F-83688-00	REC6C5-85885-00
	1B366823-2B094995	USA 4		REC8M0148668		REC8M6000634	REC8M0082988	REC8M0011987	REC897526T	REC891663001	REC8544445	REC8M0125617
90 EFI & SEAPRO	2B095049+	USA 4		REC8M0148668		REC8M6000634	REC8M0082988		REC897526T	REC891663001	REC8544445	REC8M0125617
100 EFI	OP459572-2B094995	BEL 4		REC8M0148668		REC8M6000634	REC8M0082988	REC8M0011987	REC897526T	REC891663001	REC8544445	REC8M0125617
	1B227000-1B366822	USA 4		REC804295T							REC68F-83688-00	REC6C5-85885-00
	1B366823-2B094995	USA 4		REC8M0148668		REC8M6000634	REC8M0082988	REC8M0011987	REC897526T	REC891663001	REC8544445	REC8M0125617
	2B095049+	USA 4		REC8M0148668		REC8M6000634	REC8M0082988		REC897526T	REC891663001	REC8544445	REC8M0125617
115 EFI	OT178500-OT800999	USA 4		REC804295T					REC881447T		REC68V-82380-00	REC68V-85885-00
	OT801000-1B226999	USA 4		REC804295T					REC881447T		REC68V-82380-00	REC68V-85885-00
	1B227000-1B366822	USA 4		REC804295T					REC881447T		REC68V-82380-00	REC68V-85885-00
	1B366823-2B094995	USA 4		REC8M0148668		REC8M6000634	REC8M0082988	REC8M0011987	REC897526T	REC891663001	REC8544445	REC8M0125617
115 EFI & SEAPRO (XS)	2B095049+	4		REC8M0148668		REC8M6000634	REC8M0082988		REC897526T	REC891663001	REC8544445	REC8M0125617
135	2B131942+	4		REC8M0148668		REC8M6000634	REC8M0082988		REC897526T	REC891663001	REC8544445	REC8M0125617
135 VERADO	OP419487-OP464487	BEL 4	REC8M6003194	REC8M0148668		REC8M6000634	REC8M0082988	REC8M0011987		REC891663001	REC8M6000639	
	OP464488-OP514868	BEL 4	REC8M6003194	REC8M0142542	REC881879T26	REC8M6000634	REC8M0082988	REC8M0011987		REC891663001	REC8M6000639	
	OP514869-OP593020	BEL 4	REC8M6003194	REC8M0142542	REC881879T26	REC8M6000634	REC8M0082988	REC8M0011987		REC891663001	REC8M6000639	
	1B227000-1B381711	USA 4	REC8M6003194	REC8M0148668	REC881879T26	REC8M6000634	REC8M0082988	REC8M0011987		REC891663001	REC8M6000639	
	1B381712-1B517158	USA 4	REC8M6003194	REC8M0148668	REC881879T26	REC8M6000634	REC8M0082988	REC8M0011987		REC891663001	REC8M6000639	
	1B517159-2B576734	USA 4	REC8M6003194	REC8M0142542	REC881879T26	REC8M6000634	REC8M0082988	REC8M0011987		REC891663001	REC8M6000639	
150	1B905505+	4		REC8M0148668		REC8M6000634	REC8M0082988		REC897526T	REC891663001	REC8544445	REC8M0125617
150 SEAPRO	2B139139+	4		REC8M0148668		REC8M6000634	REC8M0082988		REC897526T	REC891663001	REC8544445	REC8M0125617
150 Pro XS	2B550139+	4		REC8M0148668		REC8M6000634	REC8M0082988		REC897526T	REC891663001	REC8544445	REC8M0125617
150 VERADO	OP419487-OP464487	BEL 4	REC8M6003194	REC8M0148668	REC881879T26	REC8M6000634	REC8M0082988	REC8M0011987		REC891663001	REC8M6000639	
	OP464488-OP514868	BEL 4	REC8M6003194	REC8M0148668	REC881879T26	REC8M6000634	REC8M0082988	REC8M0011987		REC891663001	REC8M6000639	
	OP514869-OP593020	BEL 4	REC8M6003194	REC8M0142542	REC881879T26	REC8M6000634	REC8M0082988	REC8M0011987		REC891663001	REC8M6000639	
	1B227000-1B381711	USA 4	REC8M6003194	REC8M0148668	REC881879T26	REC8M6000634	REC8M0082988	REC8M0011987		REC891663001	REC8M6000639	
	1B381712-1B517158	USA 4	REC8M6003194	REC8M0148668	REC881879T26	REC8M6000634	REC8M0082988	REC8M0011987		REC891663001	REC8M6000639	
	1B517159-2B576734	USA 4	REC8M6003194	REC8M0142542	REC881879T26	REC8M6000634	REC8M0082988	REC8M0011987		REC891663001	REC8M6000639	
175 VERADO	OP419487-OP464487	BEL 4	REC8M6003194	REC8M0148668	REC881879T26	REC8M6000634	REC8M0082988	REC8M0011987		REC891663001	REC8M6000639	
	OP464488-OP514868	BEL 4	REC8M6003194	REC8M0142542	REC881879T26	REC8M6000634	REC8M0082988	REC8M0011987		REC891663001	REC8M6000639	
	OP514869-OP593020	BEL 4	REC8M6003194	REC8M0148668	REC881879T26	REC8M6000634	REC8M0082988	REC8M0011987		REC891663001	REC8M6000639	
	1B227000-1B381711	USA 4	REC8M6003194	REC8M0148668	REC881879T26	REC8M6000634	REC8M0082988	REC8M0011987		REC891663001	REC8M6000639	
	1B381712-1B517158	USA 4	REC8M6003194	REC8M0148668	REC881879T26	REC8M6000634	REC8M0082988	REC8M0011987		REC891663001	REC8M6000639	
	1B517159-2B576734	USA 4	REC8M6003194	REC8M0142542	REC881879T26	REC8M6000634	REC8M0082988	REC8M0011987		REC891663001	REC8M6000639	
175 (3.4L) V6 & Pro XS	2B529482+	USA 6		REC8M0142542	REC881879T11	REC8M0142688	REC8M0082988	REC8M0011987		REC891663001	REC8M6000639	
200 VERADO	OP514869-OP593020	BEL 4	REC8M6003194	REC8M0148668	REC881879T26	REC8M6000634	REC8M0082988	REC8M0011987		REC891663001	REC8M6000639	
	1B517159-2B576734	USA 4	REC8M6003194	REC8M0148668	REC881879T26	REC8M6000634	REC8M0082988	REC8M0011987		REC891663001	REC8M6000639	
	OP409357-OP464487	BEL 6	REC8M6003194	REC8M0148668	REC881879T26	REC8M6000634	REC8M0082988	REC8M0011987		REC891663001	REC8M6000639	
	OP464488-OP520552	BEL 6	REC8M6003194	REC8M0148668	REC881879T26	REC8M6000637	REC8M0082988	REC8M0011987		REC891663001	REC8M6000639	
	OP520553-2B144122	BEL 6	REC8M6003194	REC8M0142542	REC881879T26	REC8M6000637	REC8M0082988	REC8M0011987		REC891663001	REC8M6000639	
	OT980000-1B226999	USA 6	REC8M6003194	REC8M0148668	REC881879T26	REC8M6000634	REC8M0082988	REC8M0011987		REC891663001	REC8M6000639	
	1B227000-1B381711	USA 6	REC8M6003194	REC8M0148668	REC881879T26	REC8M6000634	REC8M0082988	REC8M0011987		REC891663001	REC8M6000639	
	1B381712-1B517433	USA 6	REC8M6003194	REC8M0148668	REC881879T26	REC8M6000637	REC8M0082988	REC8M0011987		REC891663001	REC8M6000639	
	1B517434-2B144122	USA 6	REC8M6003194	REC8M0148668	REC881879T26	REC8M6000637	REC8M0082988	REC8M0011987		REC891663001	REC8M6000639	
	2B144123-2B578935	USA 6		REC8M0142542	REC881879T26	REC8M6000637	REC8M0082988	REC8M0011987		REC891663001	REC8M6000639	
200 Pro VERAD	2B034840-2B144122	6	REC8M6003194	REC8M0148668	REC881879T26	REC8M6000637	REC8M0082988	REC8M0011987		REC891663001	REC8M6000639	
200 (3.4L) V6 & SEAPRO	2B529482+	USA 6		REC8M0142542	REC881879T11	REC8M0142688	REC8M0082988	REC8M0011987		REC891663001	REC8M0142690	
200 (4.6L) V8 PRO XS	2B529482+	USA 8		REC8M0142542	REC881879T11	REC8M0142688	REC8M0082988	REC8M0011987		REC891663001	REC8M0142690	
225 EFI	OT653945+	USA 6							REC881447T	REC13650-56B00	REC68V-82380-00	REC69J-85885-00

MOTOR	CYL	PICADO KNOCK ANTIDETON. KNOCK	TEMP. AGUA WATER TEMP. TEMP. ACQUA TEMP. EAU	PRESIÓN AGUA PRESS. WATER PRES. ACQUA PRESSION EAU	PRESIÓN ACEITE OIL PRESSURE PRESSIONE OLIO PRESSION HUILE	CIGÜENAL CRANKSHAFT ALBERGO VILEBREQUIN	ARBOL LEVAS CAMSHAFT ALBERO CAMME ARBRE A CAME	IAC	MAT	MAP	TPS
225 VERADO	OP409357- OP464487	BEL 6	REC8M6003194	REC8M0148668	REC881879T26	REC8M6000634	REC8M0082988	REC8M0011987	REC891663001	REC8M6000639	
	OP464488- OP520552	BEL 6	REC8M6003194	REC8M0148668 REC8M0142542	REC881879T26	REC8M6000637	REC8M0082988	REC8M0011987	REC891663001	REC8M6000639	
	OP520553- 2B144122	BEL 6	REC8M6003194	REC8M0148668 REC8M0142542	REC881879T26	REC8M6000637	REC8M0082988	REC8M0011987	REC891663001	REC8M6000639	
	0T980000- 1B226999	USA 6	REC8M6003194	REC8M0148668	REC881879T26	REC8M6000634	REC8M0082988	REC8M0011987	REC891663001	REC8M6000639	
	1B227000- 1B381711	USA 6	REC8M6003194	REC8M0148668	REC881879T26	REC8M6000634	REC8M0082988	REC8M0011987	REC891663001	REC8M6000639	
	1B381712- 1B517433	USA 6	REC8M6003194	REC8M0148668 REC8M0142542	REC881879T26	REC8M6000637	REC8M0082988	REC8M0011987	REC891663001	REC8M6000639	
	1B517434- 2B144122	USA 6	REC8M6003194	REC8M0148668 REC8M0142542	REC881879T26	REC8M6000637	REC8M0082988	REC8M0011987	REC891663001	REC8M6000639	
	2B144123- 2B578935	USA 6		REC8M0148668 REC8M0142542	REC881879T26	REC8M6000637	REC8M0082988	REC8M0011987	REC891663001	REC8M6000639	
	225 (3.4L) V6 Et SEA PRO	USA 6		REC8M0142542	REC881879T11	REC8M0142688	REC8M0082988	REC8M0011987	REC891663001	REC8M0142690	
	225 (4.6L) V8 PRO XS	USA 8		REC8M0142542	REC881879T11	REC8M0142688	REC8M0082988	REC8M0011987	REC891663001	REC8M0142690	
250 VERADO	OP409357- OP464487	BEL 6	REC8M6003194	REC8M0148668	REC881879T26	REC8M6000634	REC8M0082988	REC8M0011987	REC891663001	REC8M6000639	
	OP464488- OP520552	BEL 6	REC8M6003194	REC8M0148668 REC8M0142542	REC881879T26	REC8M6000637	REC8M0082988	REC8M0011987	REC891663001	REC8M6000639	
	OP520553- 2B144122	BEL 6	REC8M6003194	REC8M0148668 REC8M0142542	REC881879T26	REC8M6000637	REC8M0082988	REC8M0011987	REC891663001	REC8M6000639	
	0T980000- 1B226999	USA 6	REC8M6003194	REC8M0148668	REC881879T26	REC8M6000634	REC8M0082988	REC8M0011987	REC891663001	REC8M6000639	
	1B227000- 1B381711	USA 6	REC8M6003194	REC8M0148668	REC881879T26	REC8M6000634	REC8M0082988	REC8M0011987	REC891663001	REC8M6000639	
	1B381712- 1B517433	USA 6	REC8M6003194	REC8M0148668 REC8M0142542	REC881879T26	REC8M6000637	REC8M0082988	REC8M0011987	REC891663001	REC8M6000639	
	1B517434- 2B144122	USA 6	REC8M6003194	REC8M0148668 REC8M0142542	REC881879T26	REC8M6000637	REC8M0082988	REC8M0011987	REC891663001	REC8M6000639	
	2B144123- 2B578935	USA 6		REC8M0148668 REC8M0142542	REC881879T26	REC8M6000637	REC8M0082988	REC8M0011987	REC891663001	REC8M6000639	
	250 PRO VERADO	USA 6	REC8M6003194	REC8M0148668 REC8M0142542	REC881879T26	REC8M6000637	REC8M0082988	REC8M0011987	REC891663001	REC8M6000639	
	250 (4.6L) V8, VERADO, SEA- PRO Et PRO XS	USA 8		REC8M0142542	REC881879T11	REC8M0142688	REC8M0082988	REC8M0011987	REC891663001	REC8M0142690	
275 VERADO	1E080500+	USA 8		REC8M0142542	REC881879T11	REC8M0142688	REC8M0082988	REC8M0011987	REC891663001	REC8M0142690	
	OP409357- OP464487	BEL 6	REC8M6003194	REC8M0148668	REC881879T26	REC8M6000634	REC8M0082988	REC8M0011987	REC891663001	REC8M6000639	
	OP464488- OP520552	BEL 6	REC8M6003194	REC8M0148668 REC8M0142542	REC881879T26	REC8M6000637	REC8M0082988	REC8M0011987	REC891663001	REC8M6000639	
	OP520553- 2B144122	BEL 6	REC8M6003194	REC8M0148668 REC8M0142542	REC881879T26	REC8M6000637	REC8M0082988	REC8M0011987	REC891663001	REC8M6000639	
	0T980000- 1B226999	USA 6	REC8M6003194	REC8M0148668	REC881879T26	REC8M6000634	REC8M0082988	REC8M0011987	REC891663001	REC8M6000639	
	1B227000- 1B381711	USA 6	REC8M6003194	REC8M0148668	REC881879T26	REC8M6000634	REC8M0082988	REC8M0011987	REC891663001	REC8M6000639	
	1B381712- 1B517433	USA 6	REC8M6003194	REC8M0148668 REC8M0142542	REC881879T26	REC8M6000637	REC8M0082988	REC8M0011987	REC891663001	REC8M6000639	
	1B517434- 2B144122	USA 6	REC8M6003194	REC8M0148668 REC8M0142542	REC881879T26	REC8M6000637	REC8M0082988	REC8M0011987	REC891663001	REC8M6000639	
	2B144123- 2B578935	USA 6		REC8M0148668 REC8M0142542	REC881879T26	REC8M6000637	REC8M0082988	REC8M0011987	REC891663001	REC8M6000639	
	300 VERADO	USA 6	REC8M6003194	REC8M0148668 REC8M0142542	REC881879T26	REC8M6000637	REC8M0082988	REC8M0011987	REC891663001	REC8M6000639	
300 PRO VERADO	OP520553- 2B144122	BEL 6	REC8M6003194	REC8M0148668 REC8M0142542	REC881879T26	REC8M6000637	REC8M0082988	REC8M0011987	REC891663001	REC8M6000639	
	1B517434- 2B144122	USA 6	REC8M6003194	REC8M0148668 REC8M0142542	REC881879T26	REC8M6000637	REC8M0082988	REC8M0011987	REC891663001	REC8M6000639	
	2B144123- 2B578935	USA 6		REC8M0148668 REC8M0142542	REC881879T26	REC8M6000637	REC8M0082988	REC8M0011987	REC891663001	REC8M6000639	
	1B830170- 2B144122	USA 6	REC8M6003194	REC8M0148668 REC8M0142542	REC881879T26	REC8M6000637	REC8M0082988	REC8M0011987	REC891663001	REC8M6000639	
	2B144123- 2B577715	USA 6		REC8M0148668 REC8M0142542	REC881879T26	REC8M6000637	REC8M0082988	REC8M0011987	REC891663001	REC8M6000639	
	300 (4.6L) V8, VERADO, SEA- PRO Et PRO XS	USA 8		REC8M0142542	REC881879T11	REC8M0142688	REC8M0082988	REC8M0011987	REC891663001	REC8M0142690	
	300 (4.6L) V8 RACING	USA 8		REC8M0142542	REC881879T11	REC8M0142688	REC8M0082988	REC8M0011987	REC891663001	REC8M0142690	
	350SCi VERADO	USA 6		REC8M0148668 REC8M0142542	REC881879T26	REC8M6000634 REC8M6000637	REC8M0082988	REC8M0011987	REC891663001	REC8M6000639	
	350 (2.6L) L6 VERADO	USA 6		REC8M0148668 REC8M0142542	REC881879T26	REC8M6000637	REC8M0082988	REC8M0011987	REC891663001	REC8M6000639	
	350 (2.6L) L6 PRO VERADO	USA 6		REC8M0148668 REC8M0142542	REC881879T26	REC8M6000637	REC8M0082988	REC8M0011987	REC891663001	REC8M6000639	
400 (2.6L) L6 VERADO	2B618256+	USA 6		REC8M0148668 REC8M0142542	REC881879T26	REC8M6000637	REC8M0082988	REC8M0011987	REC891663001	REC8M6000639	
	400R (2.6L) L6 RACING	USA 6		REC8M0148668 REC8M0142542	REC881879T26	REC8M6000637	REC8M0082988	REC8M0011987	REC891663001	REC8M6000639	
450 (4.6L) V8 RACING	USA 8		REC8M0142542	REC881879T11	REC8M0142688	REC8M0082988	REC8M0011987	REC891663001	REC8M0142690		

BOBINAS

COILS

BOBINE

BOBINES

BOBINA DE CARGA

CHARGE COIL

BOBINA DI CARICA

BOBINE DE CHARGE

REF	OEM		2T STROKES	4T STROKES
REC803702	803702T			✓



REF	OEM		2T STROKES	4T STROKES
PAF8-05090000W	855944T01		8, 9,9 HP (209cc)	✓



BOBINA DE IGNICIÓN

IGNITION COIL

BOBINA AVVIAMENTO

BOBINE D'ALLUMAGE

REF	OEM		2T STROKES	4T STROKES
REC61N-85570-01	823033		2.5, 3, 3.3 HP USA (0T894577+) BEL (0P401000+)	✓



REF	OEM		2T STROKES	4T STROKES
PAF15-07000600	855685T		8 HP (BONDENSE) 9.9 HP (323 cc) 13.5 HP (inter.) 15 HP	✓



REF	OEM		2T STROKES	4T STROKES
REC815113T02	815113T02 16064A1 16064 16064A3		4, 5 HP (1 cyl)	✓



new

REF	OEM		2T STROKES	4T STROKES
REC803844T01	339-803844T01		8, 9,9 HP (209 cc)	✓



REF	OEM		2T STROKES	4T STROKES
REC6E7-85570-19	95188T		MARINER 8K, K40 HP (2 cyl)	✓



REF	OEM		2T STROKES	4T STROKES
REC8M0071855	339-803706A1		9.9, 15, 18 HP (inter.) 2 cyl	✓



REF	OEM	2T STROKES	4T STROKES
PAF8-05000500	339-803559A02	8, 9.9 HP USA (OR042475+) BEL (OP325500+)	✓

REF	OEM	2T STROKES	4T STROKES
REC3G2-06040-2	160643	25, 30 HP (inter)	2 cyl ✓

REF	OEM	2T STROKES	4T STROKES
REC8M0134472	8M0134472	9.9 HP EFI (1R008146+) 10, 15, 20 HP EFI (OR833820+) (2 cyl)	✓

REF	OEM	2T STROKES	4T STROKES
PAF25-05120000	339-859738T1	25 HP (2 cyl)	40, 50, 60 HP (4 cyl) ✓

REF	OEM	2T STROKES	4T STROKES
REC300-08309	339-7370A13	10 - 220 HP XR-4, XR-6, XR10	✓

REF	OEM	2T STROKES	4T STROKES
REC8M0045124	8M0045124	30, 40 EFI (3cyl)	✓

REF	OEM	2T STROKES	4T STROKES
PAF20-05000400	339-879147T71	F10, F15, F20 (OR235168+)	✓

REF	OEM	2T STROKES	4T STROKES
REC339-877807A2	339-877807A2	30, 40 EFI (3cyl)	40, 50, 60 EFI (4 cyl) ✓

REF	OEM	2T STROKES	4T STROKES
REC6R3-85570-01	339-898103T	25, 30 HP EFI (3 cyl) (OR106999+)	✓

REF	OEM	2T STROKES	4T STROKES
PAF40-05000200	339-858942T1	30 HP, 40 HP (OP153500+) 3 cyl Carb.	✓

REF	OEM		USA	BEL	2T STROKES	4T STROKES	
REC300-8M0077471	339-8M0077471 339-879984A01 339-879984T01 339-879984T00		75 DFI (3 Cyl) (1.5L)	OT980000 +		✓	
			80 Jet (3 Cyl) (1.5L)	1B586067 +			
			90 DFI (3 Cyl) (1.5L)	OT801000 +			
			115 DFI (3 Cyl) (1.5L)	OT801000 +			
			115 Pro Xs (3 Cyl) (1.5L)	1B751825			
			125 DFI (3 Cyl) (1.5L)	1B736885			
			200 (DFI) 3.0L	1B504989 - 1B912785			
			200 Pro Xs (DFI) 3.0L	1B504989 - 1B912785			
			200 (DFI) 3.0L	1B504989 +			
			200 (DFI) 3.0L	1B528615 +			
			30 EFI (3 Cyl)	OT409000 - 1B226999	OP153500 - OP400999		✓
			40 EFI (3 Cyl)	OT409000 +	OP153500 - OPP515896		✓
40, 50, 60 EFI (4 Cyl)	OT409000 +	OP153500 +		✓			



REF	OEM		2T STROKES	4T STROKES
REC300-8M0044991	300-8M0044991	35- 450 HP		✓



REF	OEM		2T STROKES	4T STROKES
REC398-173	398-173	60 - 250 HP		✓



REF	OEM		2T STROKES	4T STROKES
REC339-825101T	339-825101T	40 HP Italy 45 HP Bodensee 50 HP Bigfoot USA (OG760300-OT178499) BEL (OP017000-OP094499)		✓



REF	OEM		2T STROKES	4T STROKES
REC339-880615T01	339-880615T01	75, 80, 90, 100, 115 HP EFI 135 - 400 Verado		✓



REF	OEM		2T STROKES	4T STROKES
REC67F-85570-00	339-804271T	75, 90 HP (OG960500 - OT800999)		✓



REF	OEM		2T STROKES	4T STROKES
REC697-85570-00	97077M	MARINER 55, 60, W48 (2 cyl)		✓



REF	OEM		2T STROKES	4T STROKES
REC339-8M0077473	339-8M0077473 339-883778A01 339-883778A02	110 Jet (2.5 L), 150 ProXS (2.5L) (1B690542+)		
		200 (3.0L DFI)		
		DTS, 200 (DFI) 3.0L, 200 ProXS (DFI) 3.0L (1B504989+)		✓
		225 (3.0L DFI) DTS, 225 (DFI) 3.0L (1B504989+)		
		250 (DFI) 3.0L (1B528615+)		



REF	OEM		2T STROKES	4T STROKES
REC300-08310	339-85699A1	200 DFI, 225DFI, V135DFI (2.5L), V150DFI (2.5L), 3.0 DFI		✓



REF	OEM		2T STROKES	4T STROKES
REC1463-9382	32193A2 806529A1	800 (6 cyl)		✓

Usar con resistencia externa.
Use external resistor.
Utilizzare con resistenza esterna.
Utiliser avec une résistance externe.



MÓDULO CMD	CMD MODULE	MODULO CMD	MODULE CMD	
REF	OEM		2T STROKES	4T STROKES
REC827509A10	827509A10,T7	30 - 250 HP (1997+) (3 & 4 cyl)		✓



BOBINA DE EXCITACIÓN	COIL EXCITER	BOBINA LUCE	BOBINE D'EXCITATION	
REF	OEM		2T STROKES	4T STROKES
REC16058	16058T	4, 5 HP - 1cyl.		✓
REF	OEM		2T STROKES	4T STROKES
PAF8-05000300	803844T01	8, 9.9 HP (209cc)		✓



GUÍA DE BOBINAS	COIL GUIDE	GUIDA BOBINA	GUIDE DE BOBINE		
	CYL	REF		CYL	REF
10 EFI, 15 EFI 15EFI SEAPRO 20EFI	OR832820 +	2 REC8M0134472	40 EFI	OP153500 - OP400999	BEL 4 REC339-877807A2 REC300-8M0077471
25 EFI	OR106966 +	3 REC6R3-85570-01	40 EFI	OP401000 - OP515896	BEL 4 REC300-8M0077471
30 EFI	OP153500 -OP400999	3 REC339-877807A2 REC300-8M0077471	40EFI	OP515897 - OP580772	BEL 4 REC300-8M0077471 REC300-8M0044991
30 EFI	OR106999 +	3 REC6R3-85570-01	40 EFI	OT409000 - 1B355222	USA 4 REC339-877807A2 REC300-8M0077471
30 EFI	OT409000 - 1B226999	3 REC339-877807A2 REC300-8M0077471	40 EFI	1C000001 - 1C050251	USA 4 REC300-8M0077471
30 EFI	1C109093 - 1C456299	3 REC300-8M0077471 REC8M0045124	40 EFI	1C050252 - 1C453839	USA 4 REC300-8M0077471 REC300-8M0044991
30 EFI	1C456300 +	3 REC8M0045124	40 EFI & SEAPRO	1C453840 +	USA 4 REC300-8M0044991
40 EFI	OP153500 -OP400999	BEL 3 REC339-877807A2 REC300-8M0077471	50 EFI	OP153500 - OP400999	BEL 4 REC339-877807A2 REC300-8M0077471
40 EFI	OP401000 - OP515896	BEL 3 REC300-8M0077471	50 EFI	OP401000 - OP515896	BEL 4 REC300-8M0077471
40 EFI	OP409000 - 1B226999	USA 3 REC339-877807A2 REC300-8M0077471	50 EFI	OP515897 - OP580772	BEL 4 REC300-8M0077471 REC300-8M0044991
40 EFI	1B227000 - 1B355027	USA 3 REC300-8M0077471	50 EFI	OT409000 - 1B355222	USA 4 REC339-877807A2 REC300-8M0077471
40 EFI	1C000001 - 1C043416	3 REC300-8M0077471	50 EFI	1C000001 - 1C050251	USA 4 REC300-8M0077471
40 EFI	1C043417 - 1C456299	3 REC300-8M0077471 REC8M0045124	50 EFI	1C050252 - 1C453839	USA 4 REC300-8M0077471 REC300-8M0044991
40 EFI	1C456300 +	3 REC8M0045124	50 EFI	1C453840 +	USA 4 REC300-8M0044991

			CYL	REF
60 EFI	OP153500 - OP400999	BEL	4	REC339-877807A2 REC300-8M0077471
60 EFI	OP401000 - OP515896	BEL	4	REC300-8M0077471
60 EFI	OP515897 - OP580772	BEL	4	REC300-8M0077471 REC300-8M0044991
60 EFI	OT409000 - 1B355222	USA	4	REC339-877807A2 REC300-8M0077471
60 EFI	1C000001 - 1C050251	USA	4	REC300-8M0077471
60 EFI	1C050252 - 1C453839	USA	4	REC300-8M0044991
60 EFI & SEAPRO	1C453840 +	USA	4	REC300-8M0044991
75 EFI	1B366823 - 2B094995	USA	4	REC339-880615T01
75 EFI & SEAPRO	2B095049 +		4	REC300-8M0044991
80 EFI	OP459572 - 2B094995	BEL	4	REC339-880615T01
80 EFI	1B366823 - 2B094995	USA	4	REC339-880615T01
80 EFI	2B095049 +		4	REC300-8M0044991
90 EFI	1B366823 - 2B094995	USA	4	REC339-880615T01
90 EFI & SEAPRO	2B095049 +	USA	4	REC300-8M0044991
100 EFI	OP459572 - 2B094995	BEL	4	REC339-880615T01
100 EFI	1B366823 - 2B094995	USA	4	REC339-880615T01
100 EFI	2B095049 +	USA	4	REC300-8M0044991
115 EFI	1B366823 - 2B094995	USA	4	REC339-880615T01
115 EFI & SEAPRO (XS)	2B095049 +		4	REC300-8M0044991
135	2B131942 +		4	REC300-8M0044991
135 VERADO	OP419487 - OP464487	BEL	4	REC339-880615T01
135 VERADO	OP464488 - OP514868	BEL	4	REC339-880615T01
135 VERADO	OP514869 - OP593020	BEL	4	REC339-880615T01
135 VERADO	1B227000 - 1B381711	USA	4	REC339-880615T01
135 VERADO	1B381712 - 1B517158	USA	4	REC339-880615T01
135 VERADO	1B517159 - 2B576734	USA	4	REC339-880615T01
150	1B905505 +		4	REC300-8M0044991
150 SEAPRO	2B139139 +		4	REC300-8M0044991
150 Pro XS	2B550139 +		4	REC300-8M0044991
150 VERADO	OP419487 - OP464487	BEL	4	REC339-880615T01
150 VERADO	OP464488 - OP514868	BEL	4	REC339-880615T01
150 VERADO	OP514869 - OP593020	BEL	4	REC339-880615T01
150 VERADO	1B227000 - 1B381711	USA	4	REC339-880615T01
150 VERADO	1B381712 - 1B517158	USA	4	REC339-880615T01
150 VERADO	1B517159 - 2B576734	USA	4	REC339-880615T01
175 VERADO	OP419487 - OP464487	BEL	4	REC339-880615T01
175 VERADO	OP464488 - OP514868	BEL	4	REC339-880615T01
175 VERADO	OP514869 - OP593020	BEL	4	REC339-880615T01
175 VERADO	1B227000 - 1B381711	USA	4	REC339-880615T01
175 VERADO	1B381712 - 1B517158	USA	4	REC339-880615T01
175 VERADO	1B517159 - 2B576734	USA	4	REC339-880615T01
175 (3.4L) V6 & Pro XS	2B529482 +	USA	6	REC300-8M0044991
200 VERADO	OP514869 - OP593020	BEL	4	REC339-880615T01
200 VERADO	1B517159 - 2B576734	USA	4	REC339-880615T01
200 VERADO	OP409357 - OP464487	BEL	6	REC339-880615T01
200 VERADO	OP464488 - OP520552	BEL	6	REC339-880615T01
200 VERADO	OP520553 - 2B144122	BEL	6	REC339-880615T01
200 VERADO	OT980000 - 1B226999	USA	6	REC339-880615T01
200 VERADO	1B227000 - 1B381711	USA	6	REC339-880615T01
200 VERADO	1B381712 - 1B517433	USA	6	REC339-880615T01
200 VERADO	1B517434 - 2B144122	USA	6	REC339-880615T01
200 VERADO	2B144123 - 2B578935	USA	6	REC339-880615T01

			CYL	REF
200 Pro VERADO	2B034840 - 2B144122		6	REC339-880615T01
200 Pro VERADO	2B144123 - 2B577715		6	REC339-880615T01
200 (3.4L) V6 & SEAPRO	2B529482 +	USA	6	REC300-8M0044991
200 (4.6L) V8 PRO XS	2B529482 +	USA	8	REC300-8M0044991
225 EFI	OT653945 +	USA	6	
225 VERADO	OP409357 - OP464487	BEL	6	REC339-880615T01
225 VERADO	OP464488 - OP520552	BEL	6	REC339-880615T01
225 VERADO	OP520553 - 2B144122	BEL	6	REC339-880615T01
225 VERADO	OT980000 - 1B226999	USA	6	REC339-880615T01
225 VERADO	1B227000 - 1B381711	USA	6	REC339-880615T01
225 VERADO	1B381712 - 1B517433	USA	6	REC339-880615T01
225 VERADO	1B517434 - 2B144122	USA	6	REC339-880615T01
225 VERADO	2B144123 - 2B578935	USA	6	REC339-880615T01
225 (3.4L) V6 & SEAPRO	2B529482 +	USA	6	REC300-8M0044991
225 (4.6L) V8 PRO XS	2B529482 +	USA	8	REC300-8M0044991
250 VERADO	OP409357 - OP464487	BEL	6	REC339-880615T01
250 VERADO	OP464488 - OP520552	BEL	6	REC339-880615T01
250 VERADO	OP520553 - 2B144122	BEL	6	REC339-880615T01
250 VERADO	OT980000 - 1B226999	USA	6	REC339-880615T01
250 VERADO	1B227000 - 1B381711	USA	6	REC339-880615T01
250 VERADO	1B381712 - 1B517433	USA	6	REC339-880615T01
250 VERADO	1B517434 - 2B144122	USA	6	REC339-880615T01
250 VERADO	2B144123 - 2B578935	USA	6	REC339-880615T01
250 PRO VERADO	1B830170 - 2B144122		6	REC339-880615T01
250 PRO VERADO	2B144123 - 2B577715	USA	6	REC339-880615T01
250 (4.6L) V8, VERADO, SEAPRO & PRO XS	2B529482 +	USA	8	REC300-8M0044991
250 (4.6L) V8 RACING	1E080500+	USA	8	REC300-8M0044991
275 VERADO	OP409357 - OP464487	BEL	6	REC339-880615T01
275 VERADO	OP464488 - OP520552	BEL	6	REC339-880615T01
275 VERADO	OP520553 - 2B144122	BEL	6	REC339-880615T01
275 VERADO	OT980000 - 1B226999	USA	6	REC339-880615T01
275 VERADO	1B227000 - 1B381711	USA	6	REC339-880615T01
275 VERADO	1B381712 - 1B517433	USA	6	REC339-880615T01
275 VERADO	1B517434 - 2B144122	USA	6	REC339-880615T01
275 VERADO	2B144123 - 2B578935	USA	6	REC339-880615T01
300 VERADO	OP520553 - 2B144122	BEL	6	REC339-880615T01
300 VERADO	1B517434 - 2B144122	USA	6	REC339-880615T01
300 VERADO	2B144123 - 2B578935	USA	6	REC339-880615T01
300 PRO VERADO	1B830170 - 2B144122		6	REC339-880615T01
300 PRO VERADO	2B144123 - 2B577715	USA	6	REC339-880615T01
300 (4.6L) V8, VERADO, SEAPRO & PRO XS	2B529482 +	USA	8	REC300-8M0044991
300 (4.6L) V8 RACING	1E080500+	USA	8	REC300-8M0044991
350SCi VERADO	1B716557 - 2B143542		6	REC339-880615T01
350 2.6L L6 VERADO	2B141617 +	USA	6	REC339-880615T01
350 2.6L L6 PRO VERADO	2B141124 +	USA	6	REC339-880615T01
400 2.6L L6 VERADO	2B618256 +	USA	6	REC339-880615T01
400R 2.6L L6 RACING	2B141124 +	USA	6	REC339-880615T01
450 4.6L V8 RACING	2B529482 +	USA	8	REC300-8M0044991

BUJÍAS

SPARK PLUG

CANDELE

BOUGIES

MERCURY

4T
STROKES

				RO OEM	NGK	NGK IRIIDIUM	CHAMPION
2.5 HP 85cc 1 cyl	2006-11				NGKDCPR6E		CHARA8HC
2.5 HP		JPN	OR131842 +	33-803507	NGKDCPR6E		
3.5 HP 85cc 1cyl	2006-11				NGKDCPR6E	NGKDCPR6EIX	CHARA8HC
3.5 HP		JPN	OR131842 +	33-803507	NGKDCPR6E		
4 HP 123cc 1 cyl	2000-11				NGKDCPR6E	NGKDCPR6EIX	CHARA8HC
4 HP		JPN	OR000001 +	33-803507	NGKDCPR6E		
4 HP		BEL	OP073456 +	33-803507	NGKDCPR6E		
5 HP 123 cc 1 cyl	2000-11				NGKDCPR6E	NGKDCPR6EIX	CHARA8HC
5 HP		JPN	OR000001 +	33-803507	NGKDCPR6E		
5 HP		BEL	OP073456 +	33-803507	NGKDCPR6E		
6 HP 123cc 1 cyl	2000-11				NGKDCPR6E	NGKDCPR6EIX	CHARA8HC
6 HP		JPN	OR000001 +	33-803507	NGKDCPR6E		
6 HP		BEL	OP073456 +	33-803507	NGKDCPR6E		
8 HP 208cc 2 cyl	2005-11				NGKDCPR6E	NGKDCPR6EIX	CHARA8HC
8 Bodensee		USA	OH000058 - OH017349	33-827859	NGKCR6HS		
8 Bodensee		USA	OG760300 - OT178499	33-827859	NGKCR6HS		
8 Bodensee		BEL	OP086824 - OP325499	33-827858Q	NGKDCPR6EA-9		
8 HP		JPN	OR042475 +	33-803507	NGKDCPR6E		
8 HP		BEL	OP325500 +	33-803507	NGKDCPR6E		
9.9	1999-02				NGKDCPR6EA-9		CHARA8HC
9.9	1995-98				NGKCR6HS		
9.9 HP, Bigfoot, Prockicker 208cc 2cyl	2001-11				NGKDCPR6E	NGKDCPR6EIX	CHARA8HC
9.9 HP		USA	OH000058 - OH016909	33-827859	NGKCR6HS		
9.9 HP		USA	OG760300 - OT979999	33-827858Q	NGKDCPR6EA-9		
9.9 HP		BEL	OP075166 - OP325499	33-827858Q	NGKDCPR6EA-9		
9.9 HP		JPN	OR042475 +	33-803507	NGKDCPR6E		
9.9 HP		BEL	OP325500 +	33-803507	NGKDCPR6E		
15 Bigfoot	1998-06				NGKDCPR6EA-9		CHARA8HC
15 HP	2007-11				NGKDCPR6E	NGKDCPR6EIX	CHARA8HC
Prokicker, Bigfoot 351cc 2cyl		USA	OG590000 - 1B727495	33-827858Q	NGKDCPR6EA-9		
15 HP		BEL	9973100	33-827858Q	NGKDCPR6EA-9		
15 HP (Carb & EFI)		JPN	OR235949 +	33-803507	NGKDCPR6E		
20 HP 351cc 2 cyl	2008-11				NGKDCPR6E	NGKDCPR6EIX	CHARA8HC
20 HP (Carb & EFI)		JPN	OR235168 +	33-803507	NGKDCPR6E		
25 HP	1998-05				NGKDCPR6EA-9		CHARA8HC
25 (Carb)		USA	OG590000 - 1B344298	33-827858Q	NGKDCPR6EA-9		
25 (Carb)		BEL	9973100 - OP388282	33-827858Q	NGKDCPR6EA-9		
25 (EFI)		JPN	OR106999 +	33-803507	NGKDCPR6E		
25 (EFI)		BEL	OP401000 +	33-803507	NGKDCPR6E		
25 Jet		JPN	OR165086 +	33-803507	NGKDCPR6E		
25 EFI 526cc 3cyl	2006-11				NGKDCPR6E	NGKDCPR6EIX	CHARA8HC
30, 30 EFI 526cc, 3 cyl	1999-11				NGKDCPR6EA-9		CHARA8HC
30 (Carb)		USA	OG760300 - 1B226999	33-827858Q	NGKDCPR6EA-9		
30 (Carb)		BEL	OP094500 - OP400999	33-827858Q	NGKDCPR6EA-9		
30 (EFI)		USA	OT409000 - 1B226999	33-883323001	CHARA8HC		
30 (EFI)		JPN	OR106999 +	33-803507	NGKDCPR6E		
40, Big Foot 4cyl	2001-06				NGKDCPR6EA-9		CHARA8HC
40 EFI, Bigfoot 995cc 4 cyl	2007-11				NGKDCPR6E	NGKDCPR6EIX	CHARA8HC
40 (3 cyl. Carb)		USA	OG760300 - 1B226999	33-827858Q	NGKDCPR6EA-9		
40 (3 cyl. Carb)		BEL	OP094500 - OP400999	33-827858Q	NGKDCPR6EA-9		
40 (3 cyl. EFI)		USA	OT409000 +	33-883323001			CHARA8HC
40 (3 cyl. EFI)		BEL	OP153500 +	33-883323001			CHARA8HC
40 (3 cyl. EFI)		CHN	1C000001 +	33-883323001			CHARA8HC
40, 45 (4 cyl.)		USA	OG231123 - OT178499	33-827858Q	NGKDCPR6EA-9		
40 (4 cyl. Carb)		USA	OT228405 - OT598999	33-827858Q	NGKDCPR6EA-9		
40 (4 cyl. Carb)		BEL	OP094500 - OP206999	33-827858Q	NGKDCPR6EA-9		
40 (4 cyl. EFI)		USA	OT409000 +	33-883323001			CHARA8HC
40 (4 cyl. EFI)		BEL	OP207000 +	33-883323001			CHARA8HC
40 (4 cyl. EFI)		CHN	1C000001 +	33-883323001			CHARA8HC
40 JET (4 cyl. EFI)		CHN	1C051324 +	33-883323001			CHARA8HC
45 Bodensee 4 cyl	1995-02				NGKDCPR6EA-9		CHARA8HC
50, Bigfoot 4cyl	1995-00				NGKDCPR6EA-9		CHARA8HC
50 EFI, Bigfoot 995cc 4cyl	2006-11				NGKDCPR6E	NGKDCPR6EIX	CHARA8HC
50		USA	OG231123 - OT178499	33-827858Q	NGKDCPR6EA-9		
50 (Carb)		USA	OT178500 - OT598999	33-827858Q	NGKDCPR6EA-9		
50 (Carb)		BEL	OP094500 - OP206999	33-827858Q	NGKDCPR6EA-9		
50 (EFI)		USA	OT409000 +	33-883323001			CHARA8HC
50 (EFI)		BEL	OP207000 +	33-883323001			CHARA8HC
50 (EFI)		CHN	1C000001 +	33-883323001			CHARA8HC
60 EFI, Bigfoot 995cc 4 cyl	2001-11				NGKDCPR6EA-9		CHARA8HC
60 (Carb)		USA	OT178500 - OT598999	33-827858Q	NGKDCPR6EA-9		
60 (Carb)		BEL	OP094500 - OP206999	33-827858Q	NGKDCPR6EA-9		
60 (EFI)		USA	OT409000 +	33-883323001			CHARA8HC

MERCURY

RECAMBIO
MARINOS

				RO OEM	NGK	NGK IRIIDIUM	CHAMPION
60 (EFI)		BEL	0P207000 +	33-883323001			CHARA8HC
60 (EFI)		CHN	1C000001 +	33-883323001			CHARA8HC
75 EFI 1.7L 4cyl	2000-11					NGKLF5A-11	
75 , 1596cc		USA	0G960500 - 1B366822	859495Q	NGKLF5A-11		
75 , 1.7L		USA	1B366823 - 2B094995	33-8M0157328	NGKLF4AE		
75 , 2.1L		USA	2B094996 +	33-8M0057936	NGKZFR5F		
80 , 1.7L		USA	1B366823 - 2B094995	33-8M0157328	NGKLF4AE		
80 , 2.1L		USA	2B094956 +	33-8M0057936	NGKZFR5F		
80		BEL	0P401000 +	33-8M0157328	NGKLF4AE		
90 EFI 1.7L 4 cyl	2000-11					NGKLF5A-11	
90 , 1596cc		USA	0G960500 - 1B366822	859495Q	NGKLF5A-11		
90 , 1.7L		USA	1B366823 - 2B094995	33-8M0157328	NGKLF4AE		
90 , 2.1L		USA	2B094996 +	33-8M0057936	NGKZFR5F		
100 , 1.7L		USA	1B366823 - 2B094995	33-8M0157328	NGKLF4AE		
100 , 2.1L		USA	2B094996 +	33-8M0057936	NGKZFR5F		
100		BEL	0P401000 +	33-8M0157328	NGKLF4AE		
115 (EFI) , 1741cc		USA	0T178500 - 1B366822	33-881284Q	NGKLF6A-11		
115 , 1.7L		USA	1B366823 - 2B094995	33-8M0157328	NGKLF4AE		
115/115 ProXS , 2.1L		USA	2B094996 +	33-8M0057936	NGKZFR5F		
135 Verado		USA	1B227000 +	33-889246Q39	NGKILFR6G-E		
135 Verado		BEL	0P419487 +	33-889246Q39	NGKILFR6G-E		
150 Verado 1.7L 4cyl Supercharged	2006-11					NGKLF5A-11	
150 EFI		USA	1B905505 +	33-8M0057936	NGKZFR5F		
150 Verado		USA	1B227000 +	33-889246Q39	NGKILFR6G-E		
150 Verado		BEL	0P419487 +	33-889246Q39	NGKILFR6G-E		
175 Verado		USA	1B227000 +	33-889246Q39	NGKILFR6G-E		
175 Verado		BEL	0P464488 +	33-889246Q39	NGKILFR6G-E		
200 Verado, 4&6 cylinder		USA	0T980000 +	33-889246Q39	NGKILFR6G-E		
200 Verado, 4&6 cylinder		BEL	0P409357 +	33-889246Q39	NGKILFR6G-E		
225 (EFI)		USA	0T653945 +	859495Q	NGKLF5A-11		
225 Verado		USA	0T980000 +	33-889246Q39	NGKILFR6G-E		
225 Verado		BEL	0P409357 +	33-889246Q39	NGKILFR6G-E		
250 Verado, Pro Four Stroke 2.6L Supercharged	2004-11					NGKLF5A-11	
250 Verado		USA	0T980000 +	33-889246Q39	NGKILFR6G-E		
250 Verado		BEL	0P409357 +	33-889246Q39	NGKILFR6G-E		
275 Verado 6 cyl Supercharged	2004-10					NGKLF5A-11	
275 Verado		USA	0T980000 +	33-889246Q39	NGKILFR6G-E		
275 Verado		BEL	0P409357 +	33-889246Q39	NGKILFR6G-E		
300 Verado, Pro FourStroke 2.6L 6cyl Supecharged	2008-11					NGKLF5A-11	
300 Verado		USA	0T980000 +	33-889246Q39	NGKILFR6G-E		
300 Verado		BEL	0P520553 +	33-889246Q39	NGKILFR6G-E		
350 Verado		USA	1B718256 +	33-889246Q39	NGKILFR6G-E		
175-300, V6(3.4L) & V8(4.6L)		USA	2B529482 +	33-8M0135348	NGKFKAR7C-9		

2T STROKES

				RO OEM	NGK	NGK IRIIDIUM	CHAMPION	
Classic 1 cyl	1993-05	NGK	NGKBP6HS				CHAL87YCC	
2.5 EFI High Performance Engine	1994-97	NGK	NGKBUZHW					
3.0	1990-92	NGK	NGKBPR6HS-10					
3.3	1993-06	NGK	NGKBPR6HS-10					
3.5	1983-85	NGK	NGKBP6HS				CHAL87YCC	
3.6	1980-82	NGK	NGKBP7HS-10				CHAL82YC	
39	1967-68	NGK	NGKBR5HS				CHAL90C	
39	1964-66	NGK	NGKBR6S				CHARJ8C	
Classic 1 cyl	1988-05	NGK	NGKBPR7HS-10				CHARL82YC	
4.0	1986-87	NGK	NGKBUZHW-2					
4.0	1980-82	NGK	NGKBPR7HS				CHARL82YC	
40 Gnat	1976-79	NGK	NGKBR6HS				CHARL86C	
40	1970-74	NGK	NGKBUZHW-2					
40	1969	NGK	NGKBR5HS				CHAL90C	
4.5	1985-75	NGK	NGKBUZHW-2					
Classic 1 cyl	1988-06	NGK	NGKBPR7HS-10				CHARL82YC	
6.0	1986-03	NGK	NGKBPZ8HN-10				CHAQL78YC	
60	1967-68	NGK	NGKBR6HS				CHARL86C	
60	1963-66	NGK	NGKBR6S				CHARJ8C	
75	1979-85	NGK	NGKB9HS-10				CHAL77JC4	
75	1975-78	NGK	NGKBUZHW-2					
75	1970-73	NGK	NGKBUZHW-2					
75	1974	NGK	NGKBUZHW					
75	1969	NGK	NGKBR6HS				CHARL86C	
8.0	2001-06	NGK	NGKBPZ8HN-10				CHAQL78YC	
8.0 Bodensee	1995-06	NGK	NGKCR6HS					
8.0	1986-00	NGK	NGKBP8HN-10					
				9.8	1979-85	NGK	NGKB9HS-10	CHAL77JC4
				110	1970-73	NGK	NGKBUZHW-2	
				110	1967-69	NGK	NGKBR7HS	CHARL82C
				100, 110	1960-66	NGK	NGKBR6S	CHARJ8C
				110	1974	NGK	NGKBUZHW	
				110	1975-78	NGK	NGKBUZHW-2	
				9.9	2001-06			
				9.9	1995-00	NGK	NGKBP8HS-15	
				9.9	1986-94	NGK	NGKBP8HN-10	
				10 Sea Pro 2 cyl	2001-02			
				10, XR10, Sea Pro 2cyl	1991-00	NGK	NGKBP8HS-15	
				15 Sea Pro	2001-06			
				15 Sea Pro	1989-00	NGK	NGKBP8HS-15	
				150	1960-61	NGK	NGKBR6S	CHARJ8C
				18, XD	1981-85	NGK	NGKBP8HN-10	
				20, Jet, Sea Pro 2 cyl	2001-06	NGK	NGKBPZ8HN-10	CHAQL78YC
				20, Jet 2cyl	1986-00	NGK	NGKBP8HN-10	
				20, 200	1970-80	NGK	NGKBUZHW-2	
				200	1967-69	NGK	NGKBR7HS	CHARL82C
				200	1960-66	NGK	NGKBR6S	CHARJ8C
				25	2001-06	NGK	NGKBPZ8HN-10	CHAQL78YC
				25, XD, Sea Pro	1980-00	NGK	NGKBP8HN-10	
				250	1962	NGK	NGKBR6S	CHARJ8C
				30, Sea Pro, Jet 2cyl	2001-02	NGK	NGKBPZ8HN-10	CHAQL78YC
				30, Sea Pro, Jet 2cyl	1995-00	NGK	NGKBP8HN-10	
				30 3cyl	1995-97	NGK	NGKBUZHW-2	
				300 4cyl	1960	NGK	NGKBR6S	CHARJ8C

		NGK	NGK IRIDIUM	CHAMPION
35	1984-91	NGKBUZHW		
350	1967-69	NGKBR7HS		CHARL82C
350	1961-6			CHAJ6C
40, Sea Pro 2 cyl	2001-06	NGKBPZ8HN-10		CHAQL78YC
40 3 cyl	2001-02	NGKBPZ8HN-10		CHAQL78YC
40 3 cyl	1998-00	NGKBP8HN-10		
40, Sea Pro 2 cyl	1995-00	NGKBP8HN-10		
40 4cyl	1988-97	NGKBUZHW-2		
40, 400, 402 2 cyl	1970-83	NGKBUZHW		
400	1960-61	NGKBR6S		CHARJ8C
40HP, EFI 747cc 3cyl	2003-11	NGKDP86EA-9		CHARA8HC
45 Jet 3 cyl	2001-02	NGKBPZ8HN-10		CHAQL78YC
45 Jet 3 cyl	1995-00	NGKBP8HN-10		
45	1986-89	NGKBUZHW-2		
450	1962	NGKBR6S		CHARJ8C
50 3cyl	2001-06	NGKBPZ8HN-10		CHAQL78YC
50 3cyl	1991-00	NGKBP8HN-10		
50 3cyl	1986-90	NGKBUZHW		
50, 500	1978-85	NGKBUZHW-2		
500, 500SS	1967-77	NGKBUZHW		
500	1961-66			CHAJ6C
500M, 500S	1967	NGKBR7HS		CHARL82C
55, Sea Pro, 3cyl	2001-06	NGKBPZ8HN-10		CHAQL78YC
55, Sea Pro, 3cyl	1992-00	NGKBP8HN-10		
60, Sea Pro, 3cyl	2001-06	NGKBPZ8HN-10		CHAQL78YC
60, Sea Pro, Bigfoot, 3cyl	1991-00	NGKBP8HN-10		
60	1984-90	NGKBUZHW		
600 6 cyl	1960-61	NGKBR6S		CHARJ8C
65 Jet 3cyl	2001-02	NGKBUZHW-2		
65 Jet 3cyl	1995-00	NGKBUZHW-2		
650	1972-76	NGKBUZHW		
650S	1968-71	NGKBUZHW		
650	1963-66			CHAJ6C
650S	1967-68	NGKBR7HS		CHARL82C
70	1987-89	NGKBUZHW-2		
70	1979-83	NGKBUZHW		
700	1977-78	NGKBUZHW		
700 6cyl	1960-61	NGKBR6S		CHARJ8C
Walleye L4N4 Engine	2007	NGKLF4AE		
75 3cyl	2001-06	NGKBUZHW-2		
75, Sea Pro 3cyl	1987-00	NGKBUZHW-2		
75XD 4cyl	1984-86	NGKBUZHW-2		
75 Jet 3cyl	2001-02	NGKBUZHW-2		
80 Jet 4cyl	1995-00	NGKBP8HN-10		
80 3cyl	1987-89	NGKBUZHW-2		
80 4cyl	1979-83	NGKBUZHW-2		
800	1970-72	NGKBUZHW		
800 6cyl	1960-61			CHAJ6C
80 Jet 4cyl	2001	NGKBPZ8HN-10		CHAQL78YC
800	1978	NGKBUZHW-2		
800	1969	NGKBUZHW		
850	1973-77	NGKBUZHW		
850 6cyl	1962-64			CHAJ6C
Walleye L4N4 Engine	2007	NGKLF4AE		
90 3cyl	1999-06	NGKBUZHW-2		
90	1987-98	NGKBUZHW-2		
90, 900 6cyl	1978-86	NGKBUZHW		
900	1965			CHAJ6C
950SS	1966-67	NGKBUZHW		
950	1966	NGKBR7HS		CHARL82C
100	1988-99	NGKBP8HN-10		
1000BP, 1000SS	1968-69	NGKBUZHW		
1000	1962-64			CHAJ6C
105 Jet	1995-98	NGKBU8H		CHAQL6VC
1100SS	1966-67	NGKBUZHW		
1100	1966	NGKBR7HS		CHARL82C
Walleye L4N4 Engine	2007	NGKLF4AE		
115 4cyl	2001-06	NGKBPZ8HN-10		CHAQL78YC
115 4cyl	1989-00	NGKBP8HN-10		
115, 1150	1970-88	NGKBUZHW		
125 4cyl	2001-06	NGKBPZ8HN-10		CHAQL78YC
125 4cyl	1994-00	NGKBP8HN-10		

		NGK	NGK IRIDIUM	CHAMPION
1250 BP, SS	1968-69	NGKBUZHW		
135 6 cyl	2000-02	NGKBPZ8HS-10		CHAQL78YC
135	1986-99	NGKBU8H		CHAQL6VC
1350	1970-71	NGKBUZHW		
140 Jet	1995-99	NGKBU8H		CHAQL6VC
140	1979-80	NGKBUZHW		
1400	1972-78	NGKBUZHW		
1400	1970-73	NGKBUZHW		
150, EFI, XRI, XR-2, XR-4 6cyl	2000-06	NGKBPZ8HS-10		CHAQL78YC
150, 1500	1978-02	NGKBU8H		CHAQL6VC
1500	1973-77	NGKBUZHW		
175 Xri	1991-02	NGKBU8H		CHAQL6VC
175, EFI MFI 6 cyl	2000-01	NGKBPZ8HS-10		CHAQL78YC
175, EFI	1979-99	NGKBU8H		CHAQL6VC
1750	1976-78	NGKBUZHW		
200, EFI, MFI, 6 cyl	2000-06	NGKBPZ8HS-10		CHAQL78YC
200 Xri	1989-02	NGKBUZ8H		CHAQL6VC
200, EFI	1979-99	NGKBU8H		CHAQL6VC
200 EFI 6 cyl	2006	NGKBR8HS		CHAQL78C
Duece High EFI 2.0L	1997	NGKBUZ8H		CHAQL6VC
F1 EFI 2.0L	1997	NGKBUZHW		
200 SST, EFI, SS, XR2 2.0L	1997	NGKBUZHW		
2000	1978	NGKBUZHW		
V-220 Laser	1987-88	NGKBUZ8H		CHAQL6VC
225 EFI, Sea Pro, Xri, Work 6 cyl	1995-06	NGKBR8HS	NGKBR8HIX	CHAQL78C
225, Work 3.0l V-6	1994-97	NGKBPZ8HN-10		CHAQL78YC
225	1980-81	NGKBU8H		CHAQL6VC
2.5L	1995-96	NGKBU8H		CHAQL6VC
250 Xri EFI 6 cyl	1995-06	NGKBR8HS	NGKBR8HIX	CHAQL78C
250 3.4L	1989-90	NGKBU8H		CHAQL6VC
2.5L Offshore	1995-97	NGKBU8H		CHAQL6VC
2.5L SS Drag EFI	1997	NGKBU8H		CHAQL6VC
275	1989-94	NGKBU8H		CHAQL6VC
EFI Sport, SS, Offshore 2.5L	2002	NGKBZ7HS-10		
3.4L	1984-88	NGKBU8H		CHAQL6VC
300 4cyl	1981-83	NGKBU8H		CHAQL6VC
2.5L S3000 EFI	1997	NGKBU8H		CHAQL6VC
2.5L Carb High Performance	1991-93	NGKBUZHW		
21.9 cu in 25SS Racing		NGKBUZHW		
49.9 cu in 650X Racing		NGKBUZHW		
99.9 cu in Twister 11-x Racing		NGKBUZHW		
10X High Performance		NGKBP8HS-10		
150 Magnum Pro Max Super		NGKBUZHW		
2.0L F1 Carb/EFI High Performance		NGKBUZHW		
2.4L Bass High Performance		NGKBUZHW		
2.4L EFI High Performance		NGKBUZHW		
2.4L Mod VP High Performance		NGKBUZHW		
200 Magnum EFI Pro Max Super		NGKBUZHW		
225 Magnum EFI Pro Max Super		NGKBUZHW		
25SS High Performance		NGKBUZHW-2		
25XS High Performance		NGKBUZHW		
44XS High Performance		NGKBUZHW-2		
SST 140 High Performance		NGKBUZHW		
XR-2 Magnum High Performance		NGKBUZHW		

MARINER

4T STROKES				4T STROKES				
		NGK	NGK IRIDIUM	CHAMPION		NGK	NGK IRIDIUM	CHAMPION
2.5 Carb		NGKDCPR6E	NGKDCPR6EIX		15 Carb 2 Cyl	NGKDCPR6E	NGKDCPR6EIX	CHARA8HC
3.5 Carb		NGKDCPR6E	NGKDCPR6EIX		20 Carb 2 Cyl	NGKDCPR6E	NGKDCPR6EIX	CHARA8HC
4.0	1999-02	NGKDCPR6E	NGKDCPR6EIX		25	1998-02	NGKDCPR6EIX	CHARA8HC
5.0	1999-02	NGKDCPR6E	NGKDCPR6EIX	CHARA8HC	25 EFI 3Cyl		NGKDCPR6EIX	CHARA8HC
6.0	2000-02	NGKDCPR6E	NGKDCPR6EIX	CHARA8HC	30 2 Cyl	1999-02	NGKDCPR6EIX	CHARA8HC
8.0 209cc		NGKDCPR6E	NGKDCPR6EIX	CHARA8HC	40 3 Cyl	1998-01	NGKDCPR6EIX	CHARA8HC
9.9	1999-02	NGKDCPR6EIX			50 4 Cyl	1995-01	NGKDCPR6EIX	
9.9 Big Foot, Sail Power	1995-02	NGKCR6HS			75, 90	2000	NGKDCPR6EIX	NGKLF5A-11
9.9 209cc		NGKDCPR6E	NGKDCPR6EIX		225 Super Magnum EFI	1997-99	NGKDCPR6EIX	CHAQL6VC
15	1998-02	NGKDCPR6EIX						

2T STROKES				2T STROKES				
		NGK	NGK IRIDIUM	CHAMPION		NGK	NGK IRIDIUM	CHAMPION
2A 646		NGKBR6HS		CHARL86C	30 Marathon 698B		NGKBR7HS	CHARL82C
2B 6A1 (M011600+)		NGKBR6HS		CHARL86C	40 Marathon, 2 Cyl.	1995-02	NGKBR8HN-10	
2B 6A1 (-M011600)		NGKBR6HS		CHARL86C	40 2, 3 Cyl	1998-01	NGKBR8HN-10	
2.5	1990-02	NGKBR6HS-10			K40 6F5 2 Cyl	1984-00	NGKBR7HS	
3.3	1993-02	NGKBR6HS-10			40, 2 Cyl	1989-97	NGKBUZHW-2	
3.5 642 (-M23740)		NGKBR7HS			40 Marathon 6F6	1985-94	NGKBR7HS	
3.5 642 (M23741+)		NGKBR6HS			40C 6E9, 40A 676A, 40B 675B, W40 676B	1981-94	NGKBR8HS	NGKBR8HIX CHAQL78C
3.5 642 (ML41691+)		NGKBR6HS			W40 6F6		NGKBR7HS	
3.5 642 (-ML41690)		NGKBR7HS			45 Jet 3 Cyl	1995-01	NGKBR8HN-10	
4.0	1990-02	NGKBR7HS-10		CHARL82YC	45 Bodensee 4 Cyl	1995-98	NGKDCPR6EIX	
4A 6E0		NGKBR7HS		CHARL82C	45 4 Cyl	1986-89	NGKBUZHW-2	
5.0	1990-02	NGKBR7HS-10		CHARL82YC	48 670		NGKBR7HS	
5A 661		NGKBR7HS		CHARL82C	W48 670		NGKBR7HS	
5C 6E3		NGKBR7HS		CHARL82C	50	1991-01	NGKBR8HN-10	
6.0	1992-02	NGKBR8HN-10		CHARL82YC	50 4 Cyl	1986-90	NGKBUZHW	
6B 678		NGKBR5HS		CHAL90C	50 4 Cyl	1980-85	NGKBUZHW-2	
6C 6H8		NGKBR7HS-10		CHAL82C	55 Marathon	1991-02	NGKBR8HN-10	
6D 6H6		NGKBR7HS-10		CHAL82C	M55 663 (E004041+, EL315379+)		NGKBR8HS-10	CHAL78C
8.0	1993-02	NGKBR8HN-10		CHARA8HC	M55 663 (-E004040, -EL315378)		NGKBR8HS	CHAQL78C
K8 680	1991-00	NGKBR6HS		CHARL86C	Marathon 55 663 W55 663		NGKBR8HS	NGKBR8HIX CHAQL78C
8.0 Bondensee	1995-99	NGKCR6HS		CHARL86C	60 Marathon	1995-02		
8	1987-92	NGKBR8HS-10			60	1991-01		
8A 647 / 655		NGKBR6HS		CHARL86C	60 Big Foot	1995-99	NGKBR8HN-10	
8B 677		NGKBR7HS		CHARL82C	60 3 Cyl. 849cc	1984-90	NGKBUZHW	
8C 6G1		NGKBR7HS-10		CHAL82C	675 (S000781+, L302051+)		NGKBR8HS-10	CHAL78C
8 Marathon / W8 / 8 677		NGKBR7HS		CHARL82C	60 6F0		NGKBR8HS-10	
9.9	1995-00	NGKBR8HS-15			60 675 (-L302050, -L000780)		NGKBR8HS	NGKBR8HIX CHAQL78C
9.9C 682 CDI		NGKBR7HS-10			65 Jet	1995-01	NGKBUZHW-2	
9.9C 682		NGKBR7HS			70 3 Cyl.		NGKBUZHW	
10 Marathon	1991-02	NGKBR8HS-15			75 Marathon	1987-91	NGKBUZHW-2	
10 Magnum	1991-98	NGKBR8HS-15			75	1987-01	NGKBUZHW-2	
15 Marathon	1997-02	NGKBR8HS-15			75 4 Cyl		NGKBUZHW-2	
15 2Cyl	1989-02	NGKBR8HS-15			80 Jet	1995-01	NGKBR8HN-10	
15 K15 6K4	1984-00	NGKBR7HS-10		CHAL82C	80 4 Cyl		NGKBUZHW-2	
15 Marathon	1992-96	NGKBR8HN-10			85		NGKBUZHW-2	
15 Marathon 684 CDI		NGKBR7HS-10		CHARL82C	90	1987-01	NGKBUZHW-2	
15 Marathon 684		NGKBR7HS			90		NGKBUZHW	
15A 651		NGKBR7HS			100	1988-99	NGKBR8HN-10	
15C 684 CDI		NGKBR7HS-10			105 Jet, 6 Cyl	1995-99	NGKBU8H	CHAQL6VC
15C 684		NGKBR7HS			115 4Cyl	1989-02	NGKBR8HN-10	
K15 669		NGKBR6HS			115	1977-88	NGKBUZHW	
K15 6M7		NGKBR7HS-10		CHAL82C	EFI, 4 Cyl (1B366823+)		NGKLF6A-11	
W15 662		NGKBR7HS			125	1994-04	NGKBR8HN-10	
W15 684		NGKBR7HS-10		CHAL82C	135	2000-01	NGKBR8HS-10	CHAQL78YC
20 Jet	1995-01	NGKBR8HN-10			135	1986-99	NGKBU8H	
20A 653		NGKBR6HS		CHARL86C	135 Marathon	1986-99	NGKBU8H	
20C 6A9		NGKBR7HS		CHARL82C	135 Work	1986-93	NGKBU8H	CHAQL6VC
25 Marathon	1993-02	NGKBR8HN-10			140 Jet	1995-99	NGKBU8H	CHAQL6VC
25	1985-01	NGKBR8HN-10			140 6 Cyl		NGKBUZHW	
K25 6A4	1997-00	NGKBR7HS		CHAL82C	150	2000-01	NGKBR8HS-10	
25 Marathon 648, 694, 695		NGKBR7HS		CHARL82C	150 EFI	2000-01	NGKBR8HS-10	CHAQL78YC
25A, 25B, 25C		NGKBR7HS			150 EFI	1997-99	NGKBU8H	CHAQL6VC
W25, WS25		NGKBR7HS			150	1979-99	NGKBU8H	
25	1992	NGKBU8H		CHAQL6VC	150 Magnum EFI	1993-97	NGKBU8H	CHAQL6VC
28 664		NGKBR7HS		CHARL82C	150 Magnum III	1992-97	NGKBU8H	
30 Marathon	1995-02	NGKBR8HN-10			150 Magnum II	1988-91	NGKBU8H	
30 Jet 3 Cyl	1998-01	NGKBR8HN-10			150 Magnum		NGKBU8H	
30	1995-00	NGKBR8HN-10			150 Work		NGKBU8H	
30 Jet 3 Cyl	1995-97	NGKBUZHW-2			175 EFI	1998-99	NGKBU8H	
30A 689	1992-94	NGKBR7HS			175	1978-98	NGKBU8H	
W30 689A	1992-93	NGKBR7HS						
W30 698B	1992-93	NGKBR7HS						

		NGK	NGK IRIIDIUM	CHAMPION			NGK	NGK IRIIDIUM	CHAMPION
175 Magnum EFI	1991-97	NGKBU8H		CHAQL6VC	200 Magnum EFI	1987-88	NGKBU8H		
175 SKI	1989-94	NGKBU8H		CHAQL78YC	3.0L Marathon	1994-01	NGKBU8H	NGKBR8HIX	
175 EFI	2000-01	NGKBPZ8HS-10			225 EFI/Carb	1995-04	NGKBU8H	NGKBR8HIX	
200 EFI	1998-99	NGKBU8H			Magnum EFI	1996-01	NGKBR8HS	NGKBR8HIX	CHAQL78C
200	1979-99	NGKBU8H			250 3.4L	1989-90	NGKBU8H		CHAQL6VC
200 Magnum EFI	1989-97	NGKBU8H		CHAQL6VC	2.5L EFI	1995-98	NGKBU8H		
200	2000	NGKBPZ8HS-10			2.5L EFI	1997	NGKBU8H		CHAQL6VC
200 EFI	2000	NGKBPZ8HS-10		CHAQL78YC	275 3.4L	1991-94	NGKBU8H		CHAQL6VC
200 Super Magnum EFI	1997	NGKBU8H		CHAQL6VC	2.5L Drag EFI V6	1997-98	NGKBUZHW		

JUEGOS DE CABLES, ALTO RENDIMIENTO

Núcleo del cable de Kevlar de 8 mm antimagnético. Funda de silicona amarilla. Terminales bujías con muelle de acero inox. Terminal del distribuidor de cobre. Terminales bobina. Silicona resistente a altas temperaturas. Garantía de 5 años.

Capuchón de silicona
Silicone jacket
Rivestimento in silicone
Capuchon en silicone



Rizado especial
Fiberglass braiding
Fibra di vetro
Tresse en fibre de verre

Terminal de acero inox
Stainless Steel terminal
Terminale di acciaio inox
Terminal en acier inox

REF	OEM	
REC15-201		5" = 12,7 cm
REC15-202		7" = 17,78 cm
REC15-203	84-813715A1	9" = 22,86 cm
REC15-204		12" = 30,48 cm

HD SPARK PLUG WIRE SET

Antimagnetic Kevlar core. Yellow silicone boot Et jacket. SS snaplock. Brass distributor terminal. Coil terminals. High resistant silicone. 5 year warranty.

KIT CAVI CANDELE, ALTE PRESTAZIONI

Núcleo del cavo di Kevlar da 8 mm antimagnetico. Copertura di silicone gialla. Terminali candele con molle di acciaio inox. Terminale lato spinterogeno in rame. Terminale Bobine. Silicone resistente alle alte temperature. Garanzia di 5 anni.

KIT FAISCEAU DE BOUGIE

Noyau en Kevlar antimagnétique. Gaine en silicone jaune. Bornes de bougie d'allumage avec ressort en acier inoxydable. Terminal de distribution en laiton. Bornes de bobine. Silicone haute résistance. Garantie de 5 ans.

Camisa de silicona de 8 mm
8 mm silicone jacket
Rivestimento in silicone da 8 mm
Gaine silicone de 8mm

Látex resistente altas temperaturas
Heat resistant latex
Latex resistente alle alte temperature
Latex résistant à haute température

Núcleo de Kevlar
Kevlar core
Nucleo de Kevlar
Noyau de Kevlar

Acero inox
Stainless Steel
Acciaio inox
Acier inox

REF	
REC84-813715A8	100, 115, 125 Et 80 JET(4 Cyl)

REF	OEM	CABLES CAVI WIRE CABLES		2T STROKES	4T STROKES
REC84-881908T3	84-881908T	3	Mercury 30-40- EFI 3 cyl		✓
REC84-881908T4	84-881908T	4	Mercury 40-60- EFI 4 cyl		✓

KIT

REF	OEM
REC84-813706A26	84-99215A26 84-813706A26



PIPA PARA BUJÍAS

SPARK PLUG PIPE

GOMITO PER CANDELE

CAPUCHON DE BOUGIE

Pipa de silicona para bujía con resistor. Conexión a prueba de agua.

Silicone pipe with resistor. Waterproof connection.

Gomito in silicone per candele. Connessione a prova di acqua.

Capuchon de bougie en silicone avec résistance. Connexion étanche

REF
CHAPROSU





MOTORES DE ARRANQUE



STARTERS

MOTORINI AVVIAMENTO



DEMARREUR

REF	OEM				2T STROKES	4T STROKES
PH130-0021	50-90983T1 50-90983A1 50-893889T 50-8M0033984	12V	10 CCW	6 - 25 HP (1977-06)	✓	





REF	OEM				2T STROKES	4T STROKES
PH130-0061	50-803835T02	12V	10 CCW	8, 9.9HP (209cc)	✓	





REF	OEM				2T STROKES	4T STROKES
PH130-0014	50-825991A2	12V	10 CCW	(Bodensee, Inter.) 232 cc	✓	





REF	OEM				2T STROKES	4T STROKES
PH130-0034	50-852570T 50-859168 50-859168T 50-857065	12V	9 CCW	8, 9.9 HP (323 cc) (1999-04) 15 HP (323 cc) (1998+)	✓	





REF	OEM				2T STROKES	4T STROKES
PH130-0006	50-853805T03	12V	9 CCW	10 Carb (2 cyl) 15 Carb (2 cyl) / JCI OR235949 - OR833819 20 Carb (2 cyl) 25 EFI (3 cyl) 25 Jet EFI (3 Cyl) OR106999+ 30 EFI (3 cyl)	✓	





REF	OEM				2T STROKES	4T STROKES
PH130-0049	50-97693M, 50-96359M 50-814980M	12V	11 CCW	MARINER 20-40HP (1977-92)	✓	





REF	OEM				2T STROKES	4T STROKES
PH130-0029	50-830308T 50-859169T 50-888151T 50-893886T	12V	9 CCW	25 HP (1998-06)	✓	





REF	OEM				2T STROKES	4T STROKES
PH130-0028	50-854636T 50-859170T 50-884045T 50-888160T 50-893897T 854636T 859170T 893887T	12V	9 CCW	30-40 HP (1999+)	✓	





REF	OEM				2T STROKES	4T STROKES
PH130-0024	50-822462 50-822462T1 50-893890T 822462T1 893890T	12V	10 CCW	30-60 HP (1994-10) 2 cyl, 3 cyl	✓	





REF	OEM				2T STROKES	4T STROKES
PH130-0072	50-41583 50-41583T	12V	10 CCW	35, 40 HP (1980-89)	✓	





REF	OEM				2T STROKES	4T STROKES
PH130-0040	50-55601A 50-55601A2 50-30829 50-32403 50-37345 50-38890 50-38890A1	12V	9 CCW	35, 50 HP (1980-89) 40 HP 2 cyl	✓	





REF	OEM				2T STROKES	4T STROKES
PH130-0033	50-859377T 50-884044T 50-888161T 50-893888T	12V	9 CCW	40, 50, 60 HP (2001+) 4 cyl	✓	





REF	OEM				2T STROKES	4T STROKES
PH130-0062	50-814980M	12V	11 CCW	40HP (Twin Carb) (1986-92)	✓	





REF	OEM				2T STROKES	4T STROKES
PH130-0011	50-73521 50-73521T 50-44369A1 50-44369	12V	10 CCW	40-60 HP (1976-06)	✓	





REF	OEM				2T STROKES	4T STROKES
ARC5362	50-834749 50-859171T 50-898265001	12V	9 CCW	40 HP 40 ITALY 45 BONDESEE 50 50 BigFoot	✓	



REF	OEM				2T STROKES	4T STROKES
PH130-0041	50-65436 50-44369A1 50-57485 50-60315 50-66015 50-66015-2 50-88119 50-893891T	12V	10 CCW	40-100 HP (1979-10)	✓	



REF	OEM				2T STROKES	4T STROKES
PH130-0015	50-44369A1 50-73521	12V	10 CCW	40-45-50-55-60 HP (1984-06)	✓	



REF	OEM	⚡	☀️	🔧	2T STROKES	4T STROKES
REC50-879150A85	50-879150A85 50-897525T05 50-898103T94 50-898103T95	12V	14 CCW	75, 80, 90, 100, 115 HP EFI NEW MODELS		✓



REF	OEM	⚡	☀️	🔧	2T STROKES	4T STROKES
PH130-0022	50-820193 50-820193-1 50-820193-T1	12V	13 CCW	40-50 HP (1992-99)		✓



REF	OEM	⚡	☀️	🔧	2T STROKES	4T STROKES
PH130-0025	50-819271 50-820193A1	12V	13 CCW	40-50HP (1991-94)		✓



REF	OEM	⚡	☀️	🔧	2T STROKES	4T STROKES
PH130-0007	97072M 81490M 50-92669M	12V	9 CCW	50-60HP (2 Cyl) (1977-87)		✓



REF	OEM	⚡	☀️	🔧	2T STROKES	4T STROKES
PH130-0010	50-673341 50-87788 50-55304A-1 50-48643 50-45822 50-37274 50-32411 50-31976 50-30842 50-29105	12V	10 CCW	65-125HP (2 Cyl) (1977-87)		✓



REF	OEM	⚡	☀️	🔧	2T STROKES	4T STROKES
PH130-0019	50-66015 50-66015T1 50-893891T	12V	8 CCW	65-90 HP 3 cyl		✓





REF	OEM	⚡	☀️	🔧	2T STROKES	4T STROKES
PH130-0042	50-60975 50-72467 50-57465A1 50-58330	12V	10 CCW	90 - 140 HP INLINE 6 V-150, V-175, XR2		✓





REF	OEM	⚡	☀️	🔧	2T STROKES	4T STROKES
PH130-0047	480955 490955 50-819085 50-819085-1 50-819085-T1 50-583869 50-616955-1	12V	9 CCW	70-150HP (1983-99)		✓





REF	OEM				2T STROKES	4T STROKES
PH130-0057	50-881368T 50-881368T1 50-881368T2	12V	13 CCW	75, 80, 90, 100, 115HP EFI (2001-06)		✓





REF	OEM				2T STROKES	4T STROKES
PH130-0055	50-804312T1	12V	13 CCW	75, 90HP (2000-05)		✓





REF	OEM				2T STROKES	4T STROKES
REC86976	50-856996T 50-86976	12V	9 CCW	115-250 V6 (2000-03) 200-225 V6 (1978-88) Con volante de 135 dientes. With 135 tooth flywheel. Per volano da 135 denti. Pour volant avec 135 dents		✓





REF	OEM				2T STROKES	4T STROKES
REC50-8M0166297	50-8M0166297 50-8M0088064 50-8M0159603	12V 1.4 KW	13 CCW	75, 80, 90, 100, 115 EFI (2B095049+) 115EFI (2B225488+)		✓





new

REF	OEM				2T STROKES	4T STROKES
PH130-0066	50-892339T 50-853329T 50-853329T01 50-893892T	12V	14 CCW	75, 90, V135, V150, V175, V200, 2.5L DFI, (OT178500+) 200HP, 250HP, 3.0L, (OT467442+) 4 - 6 cyl. inline Verados. Funcionan con solenoides Bendix. Models with solenoid operated Bendix. Funzionano con solenoidi Bendix. Modèle avec solénoïde Bendix	✓	✓



REF	OEM				2T STROKES	4T STROKES
PH130-0009	50-819968 50-819968-1 50-819968-2 50-819968-3 50-819968-4 50-819968T4 50-853869 50-853869-T	12V	9 CCW	90-135HP (1993-00) JET DRIVE & Outboard		✓



REF	OEM				2T STROKES	4T STROKES
PH130-0046	50-79472 50-44415 50-79472 1 50-77141 50-884238T	12V	8 CCW	100-250HP (1976-05)		✓



MERCURY

RECAMBIOS
MARINOS

REF	OEM	⚡	☀️	🔧	2T STROKES	4T STROKES	
PH130-0030	50-833153	12V	9 CCW	V6 DFI, 135 - 150 DFI (2.5L), 200 - 225 DFI (1997-99)	✓	✓	
	50-833153-1						
	50-833153-2						
	50-833153-5						
	50-833153-3						
PH130-0031	50-832997 1	12V	8 CCW	SPORT JET V6, 2.5L (1997-05)	✓	✓	
	50-832997 2						
PH130-0023	50-818445-2	12V	8 CCW	225-250HP (1994-01)	✓	✓	
	50-818445-3						
	50-818445-5						
PH130-0074	50-888333T	12V	13 CCW	225 EFI (2003-06)	✓	✓	
	50-888333T1						

MUELLE DE ARRANQUE STARTER SPRING MOLLA AVVIAMENTO RESSORT DE LANCEUR

REF	OEM	🔧
REC24-13421	24-29340A1-T1	Merc 4
		Merc 4.5
		Merc 6
		Merc 7.5
		Merc 9.8
		Mark (10) 10
		Merc 10
		Mark (15) 15
		Merc 15
		Merc 20
		Merc 20
		Mark (28) 22
		Merc 25
		Merc 30
		Merc 35
		Merc 35
		Merc 35 (4 cyl NOT)
		Mark (55) 40
		Merc 40
		Mark (58) 45
		Merc 45
		Merc 50
		Mark (75) 60
		Merc 60
		Merc 65
		Mark (78) 70
		Merc 70



LLAVES DE ARRANQUE

IGNITION STARTER SWITCH

CHIAVI DI ACCENSIONE CONTACTEUR A CLÉ

REF	OEM		POSICIONES POSITIONS POSIZIONE POSITIONS
MP41070	87-17009A2 87-17009A5	6	3 OFF - RUN - START
GS11158	87-88107A5	6	



REF	OEM	POSICIONES POSITIONS POSIZIONE POSITIONS		2T STROKES	4T STROKES
REC87-897716K01	87-897716K01 87-897716	3	40, 50, 60 HP EFI JET		✓



LLAVE CON CHOQUE

PUSH T. CHOKE

CHIAVE CON CONTATTO

AVEC STARTER

REF	OEM		POSICIONES POSITIONS POSIZIONE POSITIONS
MP39760	802136A1	6	3 OFF - RUN - START



SOLENOIDE RELE

SOLENOID RELAY

SOLENOIDE RELE

SOLENOIDE RELAIS

ARRANQUE

STARTER

AVVIAMENTO

DÉMARRAGE

REF	OEM	2T STROKES	4T STROKES
PH375-0031	65057A1	✓	



REF	OEM	40 - 150 HP (1970-85)	2T STROKES	4T STROKES
PH375-0011	25661-1		✓	



REF	OEM	100 - 250 HP (1976-95)	2T STROKES	4T STROKES
PH375-0028	89-68258A4		✓	



REF	OEM	MCM DELCO REMY PG260 75, 90 (1.5L) - 225 HP DFI 3.0 L EFI 200 - 300 HP VERADO	12 V
PH375-0008	809463A1		



REF	OEM	30 HP +	12 V	2T STROKES	4T STROKES
PH375-0042	8M0098898			✓	✓
	881352T	225 EFI (OT653945+)			✓
	89-853809001	9.9, 25, 30 HP EFI (OR106999+)			✓

TRIM



REF	OEM	225 EFI (OT653945+)	12 V	2T STROKES	4T STROKES
REC63P-81950-00	888320T				✓
	881356001	75, 90 HP EFI (1596 cc) (1B172291-1B366822)			✓

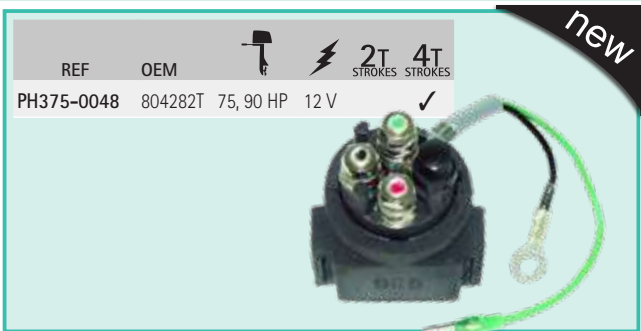

REF	OEM	40-50 HP 10, 15, 20 HP (2 cyl) Carb. & EFI 75, 90 HP	12 V	2T STROKES	4T STROKES
PH375-0047	87-851839 87-8518391 804281T			✓	✓



RELÉ

RELAY

RELE

RELAIS

REF	OEM			2T STROKES	4T STROKES
REC89-825096T01	89-825096T	6 HP +	12 V	✓	✓
PAF15-05170300W	89-825096T01				



REF	OEM			2T STROKES	4T STROKES
PHSEL-239	89-96158	35 - 300 HP	12 V	✓	





REF	OEM			2T STROKES	4T STROKES
REC89-96054T	89-96054	15 - 200 HP	12 V	✓	

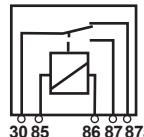

REF	OEM			2T STROKES	4T STROKES
REC87-18211	87-18211	35 - V-200	12 V 30A	✓	

87
86 87a 85
30







REF	OEM			2T STROKES	4T STROKES
PH375-0034	89-818997A1	30 - 225 HP	12 V	✓	
	89-850187T1	25, 30, 40 HP			✓



REF	OEM			2T STROKES	4T STROKES
REC1504952	87-19761	40 HP USA OC159200+ BEL 9570790+	12 V	✓	



REF	OEM			2T STROKES	4T STROKES
REC882751A1	882751A1	30 HP +		✓	✓
	828151				
	828151A1				
	882751A2				



REF	OEM			2T STROKES	4T STROKES
PAF40-05091400E1	821509T01	45HP BODENSEE (0G231123 - 0G472132)	12 V		✓



REF	OEM			2T STROKES	4T STROKES
REC882751A04	821509 821509T01	30 - 115 HP	12 V	✓	✓



REF	OEM			2T STROKES	4T STROKES
PH375-0036	89-825842A1	65 - 3.0L	12 V	✓	✓
	89-850188A1				
	89-818999A1/A2				



REF	OEM			2T STROKES	4T STROKES
PH375-0037	89-817109A1 89-817109A2 89-817109A3	65 - 250 HP	12 V	✓	✓



REF	OEM			2T STROKES	4T STROKES
REC68V-81950-00	881350T	115 EFI (0T801000-0T800999) (1B226999-1B366822) 225 EFI (0T653945+)	12 V		✓

REF	OEM			2T STROKES	4T STROKES
REC54293A10	54293A10	75 HP (4 Cyl) V-150 - V-200 HP	12 V	✓	



REF	OEM			2T STROKES	4T STROKES
REC89-818864T	89-818864T	V-150 - V-200 HP XR-4	12 V	✓	



REF	OEM			2T STROKES	4T STROKES
REC60E-81950-00	881350T01	75, 90 EFI (1B172291-1B366822) 80, 100 EFI (1B227000-1B366822)	12 V		✓

REF	OEM			2T STROKES	4T STROKES
REC882751A04	882751A04	VERADO	12 V		✓



GUÍA RELÉ RELAY GUIDE GUIDA RELE GUIDE DES RELAIS

REF	RELÉ TRIM TRIM RELAY RELE TRIM RELAIS TRIM	RELÉ ARRANQUE STARTER RELAY RELE AVVIAMENTO RELAIS DEMARRAGE	RELÉ MOTOR ENGINE RELAY RELE MOTORE RELAIS MOTEUR
10 EFI	OR832820 +	2 PH375-0047	PH375-0042
15 EFI	OR106966 +	3	PH375-0042
15EFI SEAPRO	OP153500 - OP400999	3 REC882751A1	REC89-825096T01
20EFI	OR106999 +	3	PH375-0042
25 EFI	OT409000 - 1B226999	3 REC882751A1	REC89-825096T01
30 EFI	1C109093 - 1C456299	3 REC882751A1	REC89-825096T01
30 EFI	1C456300 +	3 REC882751A1	REC89-825096T01
30 EFI	OP153500 - OP400999	3 REC882751A1	REC89-825096T01
30 EFI	OP401000 - OP515896	BEL 3 REC882751A1	REC89-825096T01
30 EFI	OP409000 - 1B226999	BEL 3 REC882751A1	REC89-825096T01
30 EFI	OP409000 - 1B355027	USA 3 REC882751A1	REC89-825096T01
30 EFI	1B227000 - 1B355027	USA 3 REC882751A1	REC89-825096T01
30 EFI	1C000001 - 1C043416	3 REC882751A1	REC89-825096T01
30 EFI	1C043417 - 1C456299	3 REC882751A1	REC89-825096T01
30 EFI	1C456300 +	3 REC882751A1	REC89-825096T01
30 EFI	OP153500 - OP400999	BEL 4 REC882751A1	REC89-825096T01
30 EFI	OP401000 - OP515896	BEL 4 REC882751A1	REC89-825096T01
30 EFI	OP515897 - OP580772	BEL 4 REC882751A1	REC89-825096T01
30 EFI	OT409000 - 1B355222	USA 4 REC882751A1	REC89-825096T01
30 EFI	1C000001 - 1C050251	USA 4 REC882751A1	REC89-825096T01
30 EFI	1C050252 - 1C453839	USA 4 REC882751A1	REC89-825096T01
30 EFI & SEAPRO	1C453840 +	USA 4 REC882751A1	REC89-825096T01
40 EFI	OP153500 - OP400999	BEL 4 REC882751A1	REC89-825096T01
40 EFI	OP401000 - OP515896	BEL 4 REC882751A1	REC89-825096T01
40 EFI	OP515897 - OP580772	BEL 4 REC882751A1	REC89-825096T01
40 EFI	OT409000 - 1B355222	USA 4 REC882751A1	REC89-825096T01
40 EFI	1C000001 - 1C050251	USA 4 REC882751A1	REC89-825096T01
40 EFI	1C050252 - 1C453839	USA 4 REC882751A1	REC89-825096T01
40 EFI	1C453840 +	USA 4 REC882751A1	REC89-825096T01
40 EFI	OP153500 - OP400999	BEL 4 REC882751A1	REC89-825096T01
40 EFI	OP401000 - OP515896	BEL 4 REC882751A1	REC89-825096T01
40 EFI	OP515897 - OP580772	BEL 4 REC882751A1	REC89-825096T01
40 EFI	OT409000 - 1B355222	USA 4 REC882751A1	REC89-825096T01
40 EFI	1C000001 - 1C050251	USA 4 REC882751A1	REC89-825096T01

REF				RELÉ TRIM TRIM RELAY RELE TRIM RELAIS TRIM	RELE ARRANQUE STARTER RELAY RELE AVVIAMENTO RELAIS DEMARRAGE	RELÉ MOTOR ENGINE RELAY RELE MOTORE RELAIS MOTEUR
50 EFI	1C050252 - 1C453839	USA	4	REC882751A1	REC89-825096T01	REC882751A1
50 EFI	1C453840 +	USA	4	REC882751A1	REC89-825096T01	REC882751A1
60 EFI	0P153500 - 0P400999	BEL	4	REC882751A1	REC89-825096T01	REC882751A1
60 EFI	0P401000 - 0P515896	BEL	4	REC882751A1	REC89-825096T01	REC882751A1
60 EFI	0P515897 - 0P580772	BEL	4	REC882751A1	REC89-825096T01	REC882751A1
60 EFI	0T409000 - 1B355222	USA	4	REC882751A1	REC89-825096T01	REC882751A1
60 EFI	1C000001 - 1C050251	USA	4	REC882751A1	REC89-825096T01	REC882751A1
60 EFI	1C050252 - 1C453839	USA	4	REC882751A1	REC89-825096T01	REC882751A1
60 EFI & SEAPRO	1C453840 +	USA	4	REC882751A1	REC89-825096T01	REC882751A1
75 EFI	1B172291 - 1B366822	USA	4	REC63P-81950-00	PH375-0042	REC60E-81950-00
75 EFI	1B366823 - 2B094995	USA	4	REC882751A1	PH375-0037	REC882751A1
75 EFI & SEAPRO	2B095049 +		4	REC882751A1	REC89-825096T01	REC882751A1
80 EFI	0P459572 - 2B094995	BEL	4	REC882751A1	PH375-0037	REC882751A1
80 EFI	1B227000 - 1B366822	USA	4	REC63P-81950-00	REC89-825096T01	REC60E-81950-00
80 EFI	1B366823 - 2B094995	USA	4	REC882751A1	PH375-0042	REC60E-81950-00
80 EFI	2B095049 +		4	REC882751A1	REC89-825096T01	REC882751A1
90 EFI	1B172291 - 1B366822	USA	4	REC63P-81950-00	PH375-0042	REC60E-81950-00
90 EFI	1B366823 - 2B094995	USA	4	REC882751A1	PH375-0037	REC882751A1
90 EFI & SEAPRO	2B095049 +	USA	4	REC882751A1	REC89-825096T01	REC882751A1
100 EFI	0P459572 - 2B094995	BEL	4	REC882751A1	PH375-0037	REC882751A1
100 EFI	1B227000 - 1B366822	USA	4	REC63P-81950-00	REC89-825096T01	REC60E-81950-00
100 EFI	1B366823 - 2B094995	USA	4	REC882751A1	PH375-0042	REC60E-81950-00
100 EFI	2B095049 +	USA	4	REC882751A1	PH375-0037	REC882751A1
115 EFI	0T178500 - 0T800999	USA	4	REC882751A1	REC89-825096T01	REC882751A1
115 EFI	0T801000 - 1B226999	USA	4	REC882751A1	PH375-0042	REC68V-81950-00
115 EFI	1B227000 - 1B366822	USA	4	REC882751A1	PH375-0042	REC68V-81950-00
115 EFI	1B366823 - 2B094995	USA	4	REC882751A1	PH375-0037	REC882751A1
115 EFI & SEAPRO (XS)	2B095049 +		4	REC882751A1	REC89-825096T01	REC882751A1
135	2B131942 +		4	PH360-0003		PH360-0003
135 VERADO	0P419487 - 0P464487	BEL	4	REC882751A04		
135 VERADO	0P464488 - 0P514868	BEL	4	REC882751A04		REC882751A04
135 VERADO	0P514869 - 0P593020	BEL	4	REC882751A04		REC882751A04
135 VERADO	1B227000 - 1B381711	USA	4	REC882751A04		REC882751A04
135 VERADO	1B381712 - 1B517158	USA	4	REC882751A04		REC882751A04
135 VERADO	1B517159 - 2B576734	USA	4	REC882751A04		REC882751A04
150	1B905505 +		4	PH360-0003		PH360-0003
150 SEAPRO	2B139139 +		4	PH360-0003		PH360-0003
150 Pro XS	2B550139 +		4	PH360-0003		PH360-0003
150 VERADO	0P419487 - 0P464487	BEL	4	REC882751A04		REC882751A04
150 VERADO	0P464488 - 0P514868	BEL	4	REC882751A04		REC882751A04
150 VERADO	0P514869 - 0P593020	BEL	4	REC882751A04		REC882751A04
150 VERADO	1B227000 - 1B381711	USA	4	REC882751A04		REC882751A04
150 VERADO	1B381712 - 1B517158	USA	4	REC882751A04		REC882751A04
150 VERADO	1B517159 - 2B576734	USA	4	REC882751A04		REC882751A04
175 VERADO	0P419487 - 0P464487	BEL	4	REC882751A04		REC882751A04
175 VERADO	0P464488 - 0P514868	BEL	4	REC882751A04		REC882751A04
175 VERADO	0P514869 - 0P593020	BEL	4	REC882751A04		REC882751A04
175 VERADO	1B227000 - 1B381711	USA	4	REC882751A04		REC882751A04
175 VERADO	1B381712 - 1B517158	USA	4	REC882751A04		REC882751A04
175 VERADO	1B517159 - 2B576734	USA	4	REC882751A04		REC882751A04
175 (3.4L) V6 & Pro XS	2B529482 +	USA	6	PH360-0003		PH360-0003
200 VERADO	0P514869 - 0P593020	BEL	4	REC882751A04		REC882751A04
200 VERADO	1B517159 - 2B576734	USA	4	REC882751A04		REC882751A04
200 VERADO	0P409357 - 0P464487	BEL	6	REC882751A04		REC882751A04
200 VERADO	0P464488 - 0P520552	BEL	6	REC882751A04		REC882751A04
200 VERADO	0P520553 - 2B144122	BEL	6	REC882751A04		REC882751A04
200 VERADO	0T980000 - 1B226999	USA	6	REC882751A04		REC882751A04
200 VERADO	1B227000 - 1B381711	USA	6	REC882751A04		REC882751A04
200 VERADO	1B381712 - 1B517433	USA	6	REC882751A04		REC882751A04
200 VERADO	1B517434 - 2B144122	USA	6	REC882751A04		REC882751A04
200 VERADO	2B144123 - 2B578935	USA	6	REC882751A04		REC882751A04
200 Pro VERADO	2B034840 - 2B144122		6	REC882751A04		REC882751A04
200 Pro VERADO	2B144123 - 2B577715		6	REC882751A04		REC882751A04
200 (3.4L) V6 & SEAPRO	2B529482 +	USA	6	PH360-0003		PH360-0003
200 (4.6L) V8 PRO XS	2B529482 +	USA	8	PH360-0003		PH360-0003
225 EFI	0T653945 +	USA	6	REC63P-81950-00	PH375-0042	REC68V-81950-00
225 VERADO	0P409357 - 0P464487	BEL	6	REC882751A04		REC882751A04
225 VERADO	0P464488 - 0P520552	BEL	6	REC882751A04		REC882751A04
225 VERADO	0P520553 - 2B144122	BEL	6	REC882751A04		REC882751A04
225 VERADO	0T980000 - 1B226999	USA	6	REC882751A04		REC882751A04
225 VERADO	1B227000 - 1B381711	USA	6	REC882751A04		REC882751A04
225 VERADO	1B381712 - 1B517433	USA	6	REC882751A04		REC882751A04
225 VERADO	1B517434 - 2B144122	USA	6	REC882751A04		REC882751A04
225 VERADO	2B144123 - 2B578935	USA	6	REC882751A04		REC882751A04
225 (3.4L) V6 & SEAPRO	2B529482 +	USA	6	PH360-0003		PH360-0003
225 (4.6L) V8 PRO XS	2B529482 +	USA	8	PH360-0003		PH360-0003
250 VERADO	0P409357 - 0P464487	BEL	6	REC882751A04		REC882751A04
250 VERADO	0P464488 - 0P520552	BEL	6	REC882751A04		REC882751A04

REF				RELÉ TRIM TRIM RELAY RELE TRIM RELAIS TRIM	RELE ARRANQUE STARTER RELAY RELE AVVIAMENTO RELAIS DEMARRAGE	RELÉ MOTOR ENGINE RELAY RELE MOTORE RELAIS MOTEUR
250 VERADO	OP520553 - 2B144122	BEL	6	REC882751A04		REC882751A04
250 VERADO	0T980000 - 1B226999	USA	6	REC882751A04		REC882751A04
250 VERADO	1B227000 - 1B381711	USA	6	REC882751A04		REC882751A04
250 VERADO	1B381712 - 1B517433	USA	6	REC882751A04		REC882751A04
250 VERADO	1B517434 - 2B144122	USA	6	REC882751A04		REC882751A04
250 VERADO	2B144123 - 2B578935	USA	6	REC882751A04		REC882751A04
250 PRO VERADO	1B830170 - 2B144122		6	REC882751A04		REC882751A04
250 PRO VERADO	2B144123 - 2B577715	USA	6	REC882751A04		REC882751A04
250 (4.6L) V8, VERADO, SEAPRO & PRO XS	2B529482 +	USA	8	PH360-0003		PH360-0003
250 (4.6L) V8 RACING	1E080500+	USA	8	PH360-0003		PH360-0003
275 VERADO	OP409357 - OP464487	BEL	6	REC882751A04		REC882751A04
275 VERADO	OP464488 - OP520552	BEL	6	REC882751A04		REC882751A04
275 VERADO	OP520553 - 2B144122	BEL	6	REC882751A04		REC882751A04
275 VERADO	0T980000 - 1B226999	USA	6	REC882751A04		REC882751A04
275 VERADO	1B227000 - 1B381711	USA	6	REC882751A04		REC882751A04
275 VERADO	1B381712 - 1B517433	USA	6	REC882751A04		REC882751A04
275 VERADO	1B517434 - 2B144122	USA	6	REC882751A04		REC882751A04
275 VERADO	2B144123 - 2B578935	USA	6	REC882751A04		REC882751A04
300 VERADO	OP520553 - 2B144122	BEL	6	REC882751A04		REC882751A04
300 VERADO	1B517434 - 2B144122	USA	6	REC882751A04		REC882751A04
300 VERADO	2B144123 - 2B578935	USA	6	REC882751A04		REC882751A04
300 PRO VERADO	1B830170 - 2B144122		6	REC882751A04		REC882751A04
300 PRO VERADO	2B144123 - 2B577715	USA	6	REC882751A04		REC882751A04
300 (4.6L) V8, VERADO, SEAPRO & PRO XS	2B529482 +	USA	8	PH360-0003		PH360-0003
300 (4.6L) V8 RACING	1E080500+	USA	8	PH360-0003		PH360-0003
350SCi VERADO	1B716557 - 2B143542		6	REC882751A04		REC882751A04
350 2.6L L6 VERADO	2B141617 +	USA	6	REC882751A04		REC882751A04
350 2.6L L6 PRO VERADO	2B141124 +	USA	6	REC882751A04		REC882751A04
400 2.6L L6 VERADO	2B618256 +	USA	6	REC882751A04		REC882751A04
400R 2.6L L6 RACING	2B141124 +	USA	6	REC882751A04		REC882751A04
450 4.6L V8 RACING	2B529482 +	USA	8	REC882751A1		

ALTERNADOR

ALTERNATOR



ALTERNATORE

ALTERNATEUR

REF	OEM			
PH300-0048	892940T/T01	Verado 135 HP+ (4 & 6 cyl)	12 V 70 A	6

POLEA SERPENTIN
SERPENTINE PULLEY
PULLEGGIA SERPENTINA
POULIE SERPENTIN





REF	OEM		
PH300-0019	821663A1 821663	3.0 L 200 / 225 Carb & EFI	12 V 50 A

POLEA SENCILLA
SINGLE PULLEY
PULLEGGIA DFASDFASD
POULIE SIMPLE







REF	OEM			
PH300-0030	881248T 875285T1 889955	2.5 L NO NIPPONESO	12 V 50 A	4



REF	OEM			
PH300-0031	881247A1 875286A1 889956	3.0 L NO NIPPONESO	12 V 50 A	4



REF	OEM		2T STROKES	4T STROKES		
PH300-0047	50-897755T 8M0063970	75, 80, 90, 100, 115 HP EFI		✓	12 V 50 A	4



CORREA ALTERNADOR

ALTERNATOR BELT

CINGHIE ALTERNATORE

COURROIE ALTERNATEUR

REF	OEM		4T STROKES	2T STROKES
REC892318	57-892318 8M0012623 8M0026410	75 DFI (2005-06) 90 DFI (2005-06) 150 DFI (2004-06)		✓
REC828507Q4	57-828507Q4	135 DFI (1998+) 150 DFI (1998+) 175 DFI (2001+)		✓
REC57-880566Q14	57-880566Q14	135 - 400HP, VERADOS	✓	
REC57-828507Q01	57-828507 1	200 DFI (1997+) 225 DFI (1998+)		✓



REF	OEM	
REC57-897574Q01	57-897574Q01	75, 80, 90, 100, 115 HP EFI





new

REF	OEM	
REC57-8M0031641	57-8M0031641	135, 150 HP (PROXS, SEAPRO)



new

REF	OEM	
REC57-8M0142251	57-8M0142251	V6 (3.4L) V8 (4.6L) NEW MODELS



new

P. 272

CORREA DISTRIBUCIÓN
TIMING BELT
CINGHIE DISTRIBUZIONE
COURROIE DE DISTRIBUTION

REGULADORES Y RECTIFICADORES

REGULATOR AND RECTIFIERS

REGOLATORI E RADDRIZZATORI

REGULATEURS ET RECTIFIEURS

REF	OEM	
PH350-0003	332-2910 62351 816770/T 78614 8M0058226	7.5 - 200HP





REF	OEM		2T STROKES	4T STROKES
PAF15-07060001	853811008	8, 9.9HP (209cc)		✓





REF	OEM	
REC6G1-81970-62	810937M 810937T 8M0091976	9.9C (682-) 15C (684-) 55 (663-)





REF	OEM		2T STROKES	4T STROKES
REC8M0134477	8M0134477	9.9 EFI (1R008146+) 10, 15, 20 EFI (OR833820+)		✓





REF	OEM		2T STROKES	4T STROKES
REC879147T62	879147T62	10, 15, 20 HP (2 cyl) (OR721383-OR721384)	12 V 50 A	✓





REF	OEM		2T STROKES	4T STROKES
REC893640T01	883072T2 854515T2 893640T01/T1	2, 3, 4 cyl 6 cyl (x2 un.) 25HP- 2 cyl. (1999-05) 30-40 HP - 3 cyl. (2002-05) 40, 50, 60 HP - 4 cyl. (2002-07) 135, 140, 150, 175, 200, 240 HP - 6 cyl. (2000-05) 30, 40, 50, 60 HP EFI		✓



REF	OEM		2T STROKES	4T STROKES
REC853811T10	853811T10 898103T14	25, 30 EFI (3 cyl) 25 JET EFI (3 cyl)		✓



REF	OEM		2T STROKES	4T STROKES
REC67F-81960-12	804278T11 804278T 804278T1	Design I 75 HP (OG960500 - 1B226999) 90 HP (OG960500 - 1B226999)		✓



REF	OEM		2T STROKES	4T STROKES
REC32800-38F10	881346T	75, 80, 90, 100, 115 HP EFI		✓



REF	OEM	2T STROKES	4T STROKES
REC8M0133642	8M0133642 8M0088351	75 - 115 EFI 115 PROXS 65, 80 JET	✓

REF	OEM	2T STROKES	4T STROKES
REC883072T	81579-1-2-3-4-5 815279T-2-4-5 815279A1-2-3 817411 830179-2 830179A1-2-3 830179T 854515/T1	105, 225 HP (1989-91) 105 - 225HP (1992-05)	✓

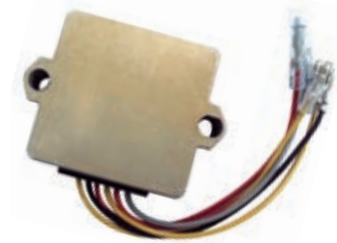

REF	OEM	2T STROKES	4T STROKES
REC815279A2	815279A2 12082A8 12082A7 12082A1 8152791	(1989-91) 16A 40A Charging system	✓

REF	OEM	2T STROKES	4T STROKES
REC69J-81960-13	888315A1 8M0057158	225 EFI (0T653945+)	✓

GUÍA REGULADORES

REGULATORS GUIDE

GUIDA REGOLATORI

GUIDE REGULATEUR

2T STROKES	4T STROKES	CYL	REF
10 EFI			
15 EFI			
15EFI SEAPRO 20EFI	OR832820+	2	REC8M0134477
25 EFI	OR106966+	3	REC853811T10
30 EFI	OP153500 -OP400999	3	REC883072T
30 EFI	OR106999+	3	REC853811T10
30 EFI	OT409000 - 1B226999	3	REC883072T
30 EFI	1C109093 - 1C456299	3	REC893640T01
30 EFI	1C456300+	3	REC893640T01
40 EFI	BEL OP153500 -OP400999	3	REC883072T
40 EFI	BEL OP401000 - OP515896	3	REC893640T01
40 EFI	USA OP409000 - 1B226999	3	REC883072T
40 EFI	USA 1B227000 - 1B355027	3	REC893640T01
40 EFI	1C000001 - 1C043416	3	REC893640T01
40 EFI	1C043417 - 1C456299	3	REC893640T01
40 EFI	1C456300+	3	REC893640T01
40 EFI	BEL OP153500 - OP400999	4	REC883072T
40 EFI	BEL OP401000 - OP515896	4	REC893640T01
40EFI	BEL OP515897 - OP580772	4	REC893640T01
40 EFI	USA OT409000 - 1B355222	4	REC883072T REC893640T01
40 EFI	USA 1C000001 - 1C050251	4	REC893640T01
40 EFI	USA 1C050252 - 1C453839	4	REC893640T01
40 EFI Et SEAPRO	USA 1C453840+	4	REC893640T01
50 EFI	BEL OP153500 - OP400999	4	REC883072T
50 EFI	BEL OP401000 - OP515896	4	REC893640T01
50 EFI	BEL OP515897 - OP580772	4	REC893640T01
50 EFI	USA OT409000 - 1B355222	4	REC883072T REC893640T01
50 EFI	USA 1C000001 - 1C050251	4	REC893640T01
50 EFI	USA 1C050252 - 1C453839	4	REC893640T01
50 EFI Et SEAPRO	USA 1C453840+	4	REC893640T01
50 EFI	BEL OP153500 - OP400999	4	REC883072T
50 EFI	BEL OP401000 - OP515896	4	REC893640T01

2T STROKES	4T STROKES	CYL	REF
50 EFI	BEL OP515897 - OP580772	4	REC893640T01
50 EFI	USA OT409000 - 1B355222	4	REC883072T REC893640T01
50 EFI	USA 1C000001 - 1C050251	4	REC893640T01
50 EFI	USA 1C050252 - 1C453839	4	REC893640T01
50 EFI	USA 1C453840+	4	REC893640T01
60 EFI	BEL OP153500 - OP400999	4	REC883072T REC893640T01
60 EFI	BEL OP401000 - OP515896	4	REC893640T01
60 EFI	BEL OP515897 - OP580772	4	REC893640T01
60 EFI	USA OT409000 - 1B355222	4	REC883072T REC893640T01
60 EFI	USA 1C000001 - 1C050251	4	REC893640T01
60 EFI	USA 1C050252 - 1C453839	4	REC893640T01
60 EFI Et SEAPRO	USA 1C453840+	4	REC893640T01
75 EFI	USA 1B172291 - 1B366822	4	REC32800-38F10
75 EFI Et SEAPRO	2B095049+	4	REC8M0133642
80 EFI	USA 1B227000 - 1B366822	4	REC32800-38F10
80 EFI	2B095049+	4	REC8M0133642
90 EFI	USA 1B172291 - 1B366822	4	REC32800-38F10
90 EFI Et SEAPRO	USA 2B095049 +	4	REC8M0133642
100 EFI	USA 1B227000 - 1B366822	4	REC32800-38F10
100 EFI	USA 2B095049+	4	REC8M0133642
115 EFI	USA OT178500 - OT800999	4	REC32800-38F10
115 EFI	USA OT801000 - 1B226999	4	REC32800-38F10
115 EFI	USA 1B227000 - 1B366822	4	REC32800-38F10
115 EFI Et SEAPRO (XS)	2B095049+	4	REC8M0133642

CDI Y CAJAS NEGRAS

CDI & POWER PACK

CDI E CENTRALINA

CDI ET BOITIER ELECTRONIQUE

REF	OEM		2T STROKES	4T STROKES
REC803034T	823034T	2.5, 3.3, 3 HP - 1 cyl	✓	





REF	OEM		2T STROKES	4T STROKES
REC696-85540-12	41305M	Mariner 6C/D, 8C, W-48/W-55	✓	



REF	OEM		2T STROKES	4T STROKES
REC16061T04	16061T04	4, 5 HP - 1 cyl	✓	



REF	OEM		2T STROKES	4T STROKES
PAF8-05000400	835401T02	8 HP USA (OR042475+) 8 HP BEL (OP325500+) 9.9 HP USA (OR042475+) 9.9 HP BEL (OP325500+) (209cc)	✓	





new

REF	OEM		2T STROKES	4T STROKES
REC339-6222A10	339-5287A1-2-3-4 339-6222A10 899883229	4 - 20 HP - 2 cyl	✓	



REF	OEM		2T STROKES	4T STROKES
REC6G9-85540-29	825667 825667T	8 Bodensee Inter. USA (OH017100+) 9.9 (232 cc) USA (OH000058-OH016909)	✓	



REF	OEM		2T STROKES	4T STROKES
REC855713A3	855713A3 855713A4	6 - 25 HP - 2 cyl	✓	





REF	OEM		2T STROKES	4T STROKES
REC803704	803704T	Mercury 9.9, 15, 18 HP (Inter.) 2 cyl	✓	



REF	OEM		2T STROKES	4T STROKES
REC695-85540-11	430775/M	Mariner 9.9C, 15C, 15K, W15, 20C, 25C	✓	





REF	OEM		2T STROKES	4T STROKES
REC332-4911A8	332-4911A2-3-5-8 338-4733A2	20 - 40 HP - 2 cyl	✓	





REF	OEM		2T STROKES	4T STROKES
REC3G2-06060-2	803706A3 8M0047313 8M0071855	9.9, 15, 18 HP - 2 cyl. (Inter.)	✓	





REF	OEM		2T STROKES	4T STROKES
REC300-03107	332-5772A5 332-5772A1 332-5772A2 332-5772A3 332-5772A7	30 - 115 HP - 4 cyl	✓	





REF	OEM		2T STROKES	4T STROKES
REC18495A30	18495A9, A14, A15, A20, A21, A25, A30	15 - 25 HP - 2 cyl.	✓	



REF	OEM		2T STROKES	4T STROKES
REC18495A13	18495A4-5-6-8-13	40 - 50 HP - 2 cyl. Not A9-14-16-20-21-30	✓	



REF	OEM		2T STROKES	4T STROKES
REC899883230	339-7452 A2, A3 899883230	18 - 20 HP (1979-87) - 2 cyl	✓	





REF	OEM		2T STROKES	4T STROKES
REC6F5-85540-22	11737T	Mariner K40 HP	✓	





REF	OEM		2T STROKES	4T STROKES
REC339-7452A19	339-7452A1, A2, A3, A7, A8, A9, A10, A11, A14, A15, A21	20 - 35 HP - 2 cyl	✓	





REF	OEM		2T STROKES	4T STROKES
REC19052A8	19052A1, 2, 3, 4, 5, 6, 8	45 - 60 HP - 3 cyl	✓	



REF	OEM		2T STROKES	4T STROKES
REC663-85540-15	3030T/M	MARINER 48 / 55 / W-48, 60 HP - 2 cyl	✓	



REF	OEM		2T STROKES	4T STROKES
REC18495A26	18495-A10-12-15-18-19-26	65 - 95 HP - 3 cyl	✓	



REF	OEM		2T STROKES	4T STROKES
REC300-01852	332-5524, A1 332-7778, A1, A3, A5, A6, A9, A12, A14	50 - 250 HP	✓	



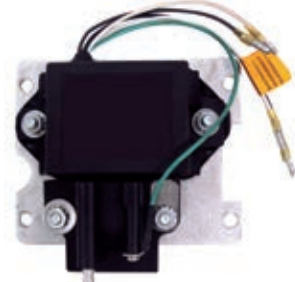

REF	OEM		2T STROKES	4T STROKES
REC332-2986A27	332-2986A22 332-2986A21 332-2986A25 332-2986A27	65 - 150 HP - 4/6 cyl	✓	





TRIGGERS

REF	OEM		2T STROKES	4T STROKES
REC98450A10	98450A1-A3-A5-A10	6 - 25 HP - 2 cyl	✓	





REF	OEM		2T STROKES	4T STROKES
REC853960T	853960T 855747A1	30 - 40 HP - 2 cyl (1998-05)	✓	





REF	OEM		2T STROKES	4T STROKES
REC99021A14	99021A14 99021A11	30 - 40 HP - 2 Cyl. (1994-99) Motores con módulos TPM. Engines w/TPM Modules. Motori con moduli TPM. Moteurs avec modules TPM	✓	





REF	OEM		2T STROKES	4T STROKES
REC854512T	854512T 834520T 855745A12	30, 40, 50, 65, 75, 90 HP (1996-05)	✓	





REF	OEM		2T STROKES	4T STROKES
REC96452A4	73372A1	4 Cyl.		
	73410A1	40, 45 HP (1989-97)		
	76681A1	45 HP (1981-89)		✓
	770002	50 HP (1976-85)		
	96452A1-A4-A5	80 HP (1978-79) 85 HP (1976-77)		





REF	OEM		2T STROKES	4T STROKES
REC854513T	834821T	100, 115, 125 HP		
	855748A2	80JET-		✓
	854513T	4 cyl		





REF	OEM		2T STROKES	4T STROKES
REC96455A8	68162A3	3 Cyl.		
	68162A6	50, 60 HP (1984-90)		✓
	96455A1	65 HP (1976-79)		
	96455A8	70 HP (1977-87)		





REF	OEM		2T STROKES	4T STROKES
REC99021A6	99021A2, A6, K2	Mariner 100, 115, 125 HP - 4 cyl JET 80 HP		✓



REF	OEM		2T STROKES	4T STROKES
REC99021A16	99021A3, A5, A8, A13, A15, A16	70, 75, 80, 90 HP 3 cyl		✓





REF	OEM		2T STROKES	4T STROKES
REC96455T18	96455A18	135 - 240 HP - 6 cyl 6 PIN CONNECTOR		
	96455T18	135, 150, 175, 200 - XR6 HP 2.5L, 240 HP (2000 - 07)		✓



REF	OEM		2T STROKES	4T STROKES
REC96455A9	681621, A5, A8	90 - V225 HP - 6 cyl Jet, MagnumII, MagnumIII (105, 150 HP)		✓
	96455A4, A6, A9	XR4, XR6 (150, 175 HP) Promax, Super Magnum (150, 200, 225 HP)		





STARTOR

REF	OEM			2T STROKES	4T STROKES
REC398-5454A17	398-5454A2, A5, A6, A7, A8, A9, A17, A18, A55 6 cyl (1978-88) 9 A			✓	





REF	OEM			2T STROKES	4T STROKES
REC398-855721T8	398-855721T8 398-855721A4 6, 8, 9.9, 10, 15, 20 HP (1997-05)			✓	





REF	OEM			2T STROKES	4T STROKES
REC398-5454A35	398-5454A11-A15-A16-A30-A31-A32-A34-A35-A36-A61-A64-A66 6 cyl (1980-88) 16 A			✓	



REF	OEM			2T STROKES	4T STROKES
REC398-852386T8	398-852386T8 398-852386A4 25, 30, 40 HP Arranque manual Manual Start Avviamento manuale Démarrage manuel (2 et 3 cyl))			16 A	✓





REF	OEM			2T STROKES	4T STROKES
REC339-6120A1	339-5212A1 339-5313A1 339-5589A1 339-5590A1 339-6119A1 339-6120A1 2 cyl 2 bobinas coils bobine bobine			✓	





REF	OEM			2T STROKES	4T STROKES
REC398-852387T9	398-852387T9 398-852387A4 25, 30, 40 HP Arranque eléctrico Electric Start Avviamento elettrico Démarrage électrique (2 et 3 cyl))			16 A	✓



REF	OEM			2T STROKES	4T STROKES
REC86617A20	86617A2-A3-A5-A9-A11-A13-A17-A20 2 cyl Kit. 6 - 25 HP			✓	



REF	OEM			2T STROKES	4T STROKES
PH400-0002	398-832075A3-A4-A5-A6-A9-A12, 398-9873A22-A28 30 HP - 2 cyl. (1996-99) 3, 40, 50, 55, 65, 75, 90 HP - 3 cyl. (1997-07) 80, 115, 125 HP - 4 cyl. (1996-06) 100, 120 HP - 4 cyl. (1995-00)			16 A	✓





new



REF	OEM			2T STROKES	4T STROKES
REC398-878143T05	398-878143T05 398-878143T3	30 - 60 HP 3,4 cyl EFI	16 A		✓

new

REF	OEM			2T STROKES	4T STROKES
REC398-5255	398-5255 398-4770	2 cyl 40 HP (3859435-5323917)	10 A	✓	



REF	OEM			2T STROKES	4T STROKES
REC398-832074A4	398-9710A11-12-14-15-22-23-25-28-30-31-33-34-36-38-39-43-45-46-47-48-49 398-9873A9-17-19-24-25-28-29-32-33-35-38-39 398-818535A17-18 F747095	40, 50, 55, 60, 65, 70, 75, 80, 90, 95 HP - 3 cyl. (1987-97) 30 Jet, 40, 80, 100, 115, 120, 125 HP - 4 cyl. (1989-97)	16 A		✓



Se debe usar con regulador REC883072T.
Must be used with regulator REC883072T.
Bisogna utilizzarlo con regolatore REC883072T.
Utiliser avec le régulateur REC883072T.



new



REF	OEM			2T STROKES	4T STROKES
REC398-832075A20	398-832075A20	45, 50 HP 4 cyl	16A		✓



REF	OEM			2T STROKES	4T STROKES
REC398-8778A29	398-8778A10-16-17-18-21-22-23-24-25-26-27-28-29 398-818535A3-5-8-9-10-13-14-15 F749095	40 HP - 4 cyl. (1989-91) 70-80 HP (1987-89) 90 HP (1987-92) 90 HP- 3 cyl. (1993) 100 HP (1988-96) 115 HP (1989-93) 125 HP - 4 cyl. (1994-96)	9 A		✓

Se puede usar tanto con regulador como con rectificador.
It can be used with either a voltage regulator or a rectifier.
Si più utilizzae sia con il regolatore che con il rettificatore.
On doit l'utiliser avec un régulateur ou un redresseur.



REF	OEM			2T STROKES	4T STROKES
REC398-5704A7	398-5704A2-A4-A5-A7	50, 60 HP - 3 cyl. (1984-90) 65 HP- 3 cyl. (1976) 70 HP - 3 cyl. (1977-85)	9 A		✓



new

REF	OEM			2T STROKES	4T STROKES
REC398-5454A26	398-5454A26	50, 60, 70 HP (3 cyl) (1976-90) 40, 45, 50, 55, 75, 80, 85 HP (4 cyl) (1976-97)	9 A		✓





REF	OEM	Icon	STROKES	2T	4T
REC300-8M0088059	300-8M0088059	75 - 115 HP EFI (2.1L) (2B095049+)	✓		

REF	OEM	Icon	STROKES	2T	4T
REC398-9610A19	398-9610A3-A5-A6-A9-A14-A19-A22-A24-A33	135 HP+ 6 cyl	40 A	✓	



REF	OEM	Icon	STROKES	2T	4T
REC398-9610A18	398-9610A18	135-200 HP V-models	40 A	✓	

Kit conversión de arranque
Kit starter conversion
Kit conversione Starter
kit kit conversion démarreur



REF	OEM	Icon	STROKES	2T	4T
REC398-5454A7	398-5454A2 398-5454A7	6 cyl V-150-ZR-2 V-150 V-150 WORK V-1500 V-150 MAGNUM, (5600162-MARATHON MARATHON V-175, V-200	(4868998 - 0A904645) 9 A	✓	

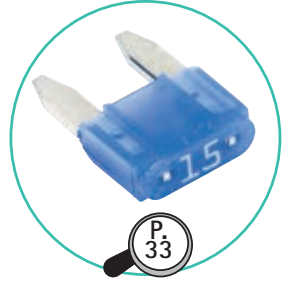

GUÍA STARTOR EFI				STARTOR GUIDE EFI				GUIDA STARTOR EFI				GUIDE STARTOR EFI			
Icon		CYL	REF	Icon		CYL	REF	Icon		CYL	REF	Icon		CYL	REF
30 EFI	OP153500 -OP400999	3	REC398-878143T05	50 EFI	USA 1C453840 +	4	REC398-878143T05								
30 EFI	OT409000 - 1B226999	3	REC398-878143T05	60 EFI	BEL OP153500 - OP400999	4	REC398-878143T05								
30 EFI	1C109093 - 1C456299	3	REC398-878143T05	60 EFI	BEL OP401000 - OP515896	4	REC398-878143T05								
30 EFI	1C456300 +	3	REC398-878143T05	60 EFI	BEL OP515897 - OP580772	4	REC398-878143T05								
40 EFI	BEL OP153500 -OP400999	3	REC398-878143T05	60 EFI	USA OT409000 - 1B355222	4	REC398-878143T05								
40 EFI	BEL OP401000 - OP515896	3	REC398-878143T05	60 EFI	USA 1C000001 - 1C050251	4	REC398-878143T05								
40 EFI	USA OP409000 - 1B226999	3	REC398-878143T05	60 EFI	USA 1C050252 - 1C453839	4	REC398-878143T05								
40 EFI	USA 1B227000 - 1B355027	3	REC398-878143T05	60 EFI & SEAPRO	USA 1C453840 +	4	REC398-878143T05								
40 EFI	1C000001 - 1C043416	3	REC398-878143T05	75 EFI & SEAPRO	2B095049 +	4	REC300-8M0088059								
40 EFI	1C043417 - 1C456299	3	REC398-878143T05	80 EFI	2B095049 +	4	REC300-8M0088059								
40 EFI	1C456300 +	3	REC398-878143T05	90 EFI & SEAPRO	USA 2B095049 +	4	REC300-8M0088059								
40 EFI	BEL OP153500 - OP400999	4	REC398-878143T05	100 EFI	USA 2B095049 +	4	REC300-8M0088059								
40 EFI	BEL OP401000 - OP515896	4	REC398-878143T05	115 EFI & SEAPRO (XS)	2B095049 +	4	REC300-8M0088059								
40EFI	BEL OP515897 - OP580772	4	REC398-878143T05	80 EFI	USA 1B227000 - 1B366822	4	REC32800-38F10								
40 EFI	USA OT409000 - 1B355222	4	REC398-878143T05	80 EFI	2B095049 +	4	REC8M0133642								
40 EFI	USA 1C000001 - 1C050251	4	REC398-878143T05	90 EFI	USA 1B172291 - 1B366822	4	REC32800-38F10								
40 EFI	USA 1C050252 - 1C453839	4	REC398-878143T05	90 EFI & SEAPRO	USA 2B095049 +	4	REC8M0133642								
40 EFI & SEAPRO	USA 1C453840 +	4	REC398-878143T05	100 EFI	USA 1B227000 - 1B366822	4	REC32800-38F10								
50 EFI	BEL OP153500 - OP400999	4	REC398-878143T05	100 EFI	USA 2B095049 +	4	REC8M0133642								
50 EFI	BEL OP401000 - OP515896	4	REC398-878143T05	115 EFI	USA OT178500 - OT800999	4	REC32800-38F10								
50 EFI	BEL OP515897 - OP580772	4	REC398-878143T05	115 EFI	USA OT801000 - 1B226999	4	REC32800-38F10								
50 EFI	USA OT409000 - 1B355222	4	REC398-878143T05	115 EFI	USA 1B227000 - 1B366822	4	REC32800-38F10								
50 EFI	USA 1C000001 - 1C050251	4	REC398-878143T05	115 EFI & SEAPRO (XS)	2B095049 +	4	REC8M0133642								
50 EFI	USA 1C050252 - 1C453839	4	REC398-878143T05												

GUÍA	APPLICATION	GUIDA	GUIDE
	CYL	CAJA NEGRA POWER PACK CENTRALINA BOITIER ELECTRONIQUE	STARTOR TRIGGER REGULADOR REGULATOR REGULATEUR REGULATEUR
2	1	OT884302 +	REC803034T
2.5, 3.3	1	OP017000 +	REC803034T
4	2	1976-80 9075839-5595531	REC339-6222A10
Gnat	2	1980 5589202-5595531	REC339-6222A10
40	2	1986-96 A197112-OG289100	REC339-7452A19
6	2	1974-86 3801458-A197111	REC339-6222A10
7.5	2	1986-96 A197112-OG289100	REC339-7452A19
75	2	1974-86 3801458-A197111	REC339-6222A10
8	2	1986-96 A197112-OG289100	REC339-7452A19
110	2	1974-78 3795659-5206549	REC339-6222A10
9.8	2	1979-85 5206550-6620196	REC339-6222A10
9.9	2	1986-96 A197112-OG289100	REC339-7452A19
10	2	1986-96 A197112-OG289100	REC339-7452A19
S15	2	1988-93 B238464-OG044365	REC339-7452A19
XD/S15	2	1996-97 OG438000-OG760299	REC339-7452A19
15	2	1996-97 OG438000-OG760299	REC339-7452A19
Sea Pro	2	1994-97 OG044027-437999	REC18495A30
SEAPRO XD	2	1994-97 OG044027-437999	REC18495A30
SUPER	2	1980-93 5837437-OG044026	REC899883230
18	2	1979-87 5837437-B114230	REC899883230
XD	2	1973-77 3537531-4709592	REC332-4911A8
200	2	1977-81 4709593-5837436	
XD	2	1979-87 5837437-B114230	REC899883230
20	2	1980-87 5705532 - B238463	REC339-7452A19
JET	2	1980-87 5705532 - B238463	REC899883230
Sea Pro	2	1988-94 B238464-OG044026	REC339-7452A19
XD	2	1994-97 OG044027-437999	REC18495A30
25	2	1994-97 OG044027-437999	REC18495A30
Jet 20	2	1996-97 OG438000-OG760299	REC339-7452A19
MARATHON	2	1997-98 OG438000-OG760299	REC86617A20
SEA PRO	2	1979-87 5837437-B114230	REC899883230
Sea Pro	2	1979-87 5705532 - OB238463	REC339-7452A19
4T/Stroke (Man. Start) 16 A	2	1988-93 OB238464-OG044365	REC339-7452A19
4T/Stroke (Elect. Start) 16 A	2	1994-97 OG044027-437999	REC18495A30
Man.-Elec.	1998-99	OG590000 - OG760299	REC853960T
Man.-Elec.	1999-06	OG760300 - OT979999	REC853960T
30	4	1989-97 C159200-OG589999	REC300-03107
JET	3	-OG960499	REC398-5704A7
4T/Stroke (Man. Start) 16 A	3	-OG960499	REC398-852386T8
4T/Stroke (Elect. Start) 16 A	3	-OG960499	REC398-852387T9
35	2	1984-89 6445653-B393190	REC899883230
402 Elect. Start.	2	1984-89 6445653-B393190	REC339-7452A19
Man. Start	2	1975-77 4117710-4860102	REC332-4911A8
Elect. Start	2	1975-81 4117710-5823917	REC332-4911A8
Elect. Start	2	1978-81 4860103 - 5823917	REC332-4911A8
Elect. Start	2	1981-84 5823918-6052942	REC899883230
Elect. Start	2	1981-84 6052943-6999999	REC899883230
Man. Start	2	1981-84 5823918-6999999	REC899883230
40	4	1989-91 C159200 - D055047	REC300-03107
Elect. Start	4	1989-91 C159200 - D055047	REC300-03107
Man. Start	4	1991-96 D055048-OG291031	REC300-03107
Elect. Start	4	1991-96 D055048-OG291031	REC300-03107
Man. Elec.	1998-05	OG760300 - OT979999	REC398-832074A4
JET	3	1997-99 OG531301-OG760300	PH400-0002
4T/Stroke (Man. Start) 16 A	4	1989-97 C159200 - OG589999	REC300-03107
4T/Stroke (Elect. Start) 16 A	3	-OG960499	REC398-5704A7
Elect. Start	3	-OG960499	REC398-852386T8
Man. Start	4	1981-89 5531630-B393190	REC300-03107
Man. Start	4	1981-89 5531630-B393190	REC300-03107
JET	3	1991-99 D000750-OG589999	REC19052A8
Elect. Start	4	1976-79 4357640-5531629	REC300-03107
Man. Start	4	1976-79 4357640-5531629	REC300-03107
Elect. Start	4	1980-85 5531630-6586624	REC300-03107
Man. Start	4	1980-85 5531630-6586624	REC300-03107
50	3	1984-90 6428681-D000749	REC300-01852
Man. Start	3	1991-99 D000750-OG589999	REC19052A8
Elect. Start	3	1997-99 OG531301-OG760300	PH400-0002
Man. Start	3	1997-00 OG531301-OG760300	PH400-0002
55	3	1991-99 D000750-OG589999	REC19052A8
Elect. Start	3	1996-98 G290585-OG589999	REC19052A8
Man. Start	3	1996-98 G290585-OG589999	REC19052A8
60	3	1984-90 6428681-D000749	REC300-01852
650	3	1991-97 D000750-OG589999	REC19052A8
65	4	1967 2119749-2309310	REC332-2986A27
Jet Elect Start	4	1969-71 2503991-3293183	REC332-2986A27
Jet Man Start	3	1976-79 4382057-4571651	REC300-01852
65	3	1994-96 D283222-OG437999	REC18495A26
Jet Man Start	3	1994-96 D283222-OG437999	REC18495A26

		CYL	CAJA NEGRA POWER PACK CENTRALINA			REGULADOR REGULATOR REGULATEUR	
			BOITIER ELECTRONIQUE	STARTOR	TRIGGER		
70	9 A	3 1977-87	4571652-A730815	REC300-01852	REC398-5704A7	REC96455A8	PH350-0003
	16 A	3 1987-93	A996142 - D283221	REC300-01852	REC398-8778A29		PH350-0003
		3 1987-93	A996142 - D283221	REC300-01852	REC398-832074A4		REC883072T
75	9 A	3 1987-93	A996142 - D283221	REC300-03107		REC96455A8	PH350-0003
	16 A	3 1987-93	A996142 - D283221	REC300-01852	REC398-8778A29	REC99021A16	PH350-0003
	Elect. Start	3 1987-93	A996142 - D283221	REC300-01852	REC398-832074A4	REC99021A16	REC883072T
	Man. Start	3 1994-96	D283222-OG437999	REC18495A26	REC398-832074A4	REC99021A16	REC883072T
		3 1994-96	D283222-OG437999	REC18495A26		REC99021A16	
		3 1996-00	OG438000-OG760299		PH400-0002		
80	800	4 1969	2559001-2991033	REC332-2986A27			PH350-0003
	800	4 1970	3052381-3059820	REC332-2986A27			PH350-0003
	800	4 1971-72	3307347-3493912	REC332-2986A27			PH350-0003
	9 A	3 1987-93	A996142-D283221	REC300-01852	REC398-8778A29	REC99021A16	PH350-0003
	16 A	3 1987-93	A996142-D283221	REC300-01852	REC398-832074A4	REC99021A16	PH350-0003
	JET	4 1994-97	D283222-OG437999	REC300-03107	REC398-832074A4	REC99021A16	PH350-0003
	JET	4 1996-06	OG438000-IB000001			REC854513T	
	850	4 1973-75	3493913-4366801	REC332-2986A27			PH350-0003
	850	4 1976-77	4366802-4831998	REC300-03107		REC96452A4	PH350-0003
	Inline	1978-79	845301-5299505	REC332-2986A27			PH350-0003
	Inline	6 1979-86	5299506 - B110053	REC300-01852	REC398-5454A17	REC96455A9	PH350-0003
	Elect. Start	3 1987-92	A996142 - C221999	REC300-01852	REC398-8778A29	REC96455A8	PH350-0003
Elect. Start	3 1993-96	C222000-OG437999	REC18495A26	REC398-832074A4	REC99021A16	REC883072T	
Man. Start	3 1994-96	D283222-OG437999	REC18495A26		REC99021A16		
	3 1996-99	OG438000-OG760299		PH400-0002			
Sport Jet	3 1995	E021000-E095087	REC300-01852	REC398-8778A29		REC883072T	
Sport Jet	3 1995-96	E080400-E145579	REC18495A26	REC398-8778A29		REC883072T	
950	6 1966-67	2101743-2318585	REC332-2986A27			PH350-0003	
XRSprtJet	3 1995-97	E141089 - E315900	REC18495A26	REC398-832074A4		REC883072T	
1000 Inline	6 1967-69	2641855-3253111	REC332-2986A27				
95	9 A	4 1988-93	B209468 - D283221	REC300-03107	REC398-8778A29	REC99021A16	REC883072T
	16 A	4 1994-96	D283222-OG437999	REC300-03107	REC398-8778A29	REC99021A16	REC883072T
	JET	4 1994-96	D283222-OG437999	REC300-03107	REC398-832074A4	REC99021A16	REC883072T
	JET	6 1992-95	D082000-OG201874	REC300-01852	PH400-0002	REC96455A9	REC883072T
1100 Inline	6 1996-00	OG303046-OG840500	REC300-01852	PH400-0002	REC96455A9	REC883072T	
150SSInlin	6 1967	2113898-2314955	REC332-2986A27			PH350-0003	
Inline	6 1970-79	2836019-5314655	REC332-2986A27			PH350-0003	
Inline	6 1979-80	5314656-5600966	REC300-01852	REC398-5454A17	REC96455A9	PH350-0003	
Inline	6 1980-82	5600967-6051525	REC300-01852	REC398-5454A17	REC96455A9	PH350-0003	
Inline	6 1982-89	6051526-C10000	REC300-01852	REC398-5454A17	REC96455A9	PH350-0003	
9 A	4 1989-93	C100000-D252460	REC300-03107	REC398-8778A29	REC99021A16	REC883072T	
16 A	4 1989-97	C100000-OG437999	REC300-03107	REC398-832074A4	REC99021A16	REC883072T	
XRSprtJet	4 1995-97	E141089 - E315900		PH400-0002		REC883072T	
1250 Inline	6 1968-69	2314956-3253111	REC332-2986A27			PH350-0003	
9 A	4 1994-96	D283222-OG437999	REC300-03107	REC398-8778A29	REC99021A16	REC883072T	
16 A	4 1994-96	D283222-OG437999	REC300-03107	REC398-832074A4	REC99021A16	REC883072T	
1350 Inline	6 1970-71	2839369-3293233	REC332-2986A27			PH350-0003	
V-135	6 1985-88	A904646-C100860	REC300-01852	REC398-5454A17	REC96455A9	PH350-0003	
V-135	6 1989-90	C100861-C239552	REC300-01852	REC398-9610A19	REC96455A9		
V-135 16 A	6 1990-91	C239553-D081999	REC300-01852	REC398-832074A4	REC96455A9	PH350-0003	
V-135 40 A	6 1990-91	C239553-D081999	REC300-01852	REC398-9610A19	REC96455A9		
V-135 40 A	6 1992-95	D082000-OG201874	REC300-01852	REC398-9610A19	REC96455A9	REC883072T	
V-135 40 A	6 1996-00	G303046-G840500	REC300-01852	REC398-9610A19	REC96455A9	REC883072T	
V-135	6 1900-01	OG960500-OT178499			REC96455T18		
1400 Inline	6 1972	3293234-3502805	REC332-2986A27			PH350-0003	
Inline	6 1978-79	4855153-5314655	REC332-2986A27			PH350-0003	
Inline	6 1979	5327663-5625107	REC300-01852	REC398-5454A17	REC96455A9	PH350-0003	
140	6 1980	5625108-5669999	REC300-01852	REC398-5454A17	REC96455A9	PH350-0003	
Jet	6 1992-95	D082000-OG201874	REC300-01852	REC398-9610A19	REC96455A9	REC883072T	
Jet	6 1996-99	OG303046-OG760300	REC300-01852	REC398-9610A19	REC96455A9	REC883072T	
Jet	6 2000-01	OG960500-OT178499			REC96455T18		
1500 Inline	6 1973-77	3502806-4868997	REC332-2986A27				
XR2 Mag	6 1978-86	4868998-0A904645	REC300-01852		REC96455A9	PH350-0003	
V-135	6 1985-88	A904646-C100860	REC300-01852	REC398-5454A17	REC96455A9	PH350-0003	
V-150	6 1989-90	C100861-C239552	REC300-01852	REC398-9610A19	REC96455A9		
V-150 16 A	6 1990-91	C239553-D081999	REC300-01852	REC398-5454A17	REC96455A9	PH350-0003	
V-150 40 A	6 1990-91	C239553-D081999	REC300-01852	REC398-9610A19	REC96455A9		
V-150 40 A	6 1992-95	D082000-OG201874	REC300-01852	REC398-9610A19	REC96455A9	REC883072T	
V-150 40 A	6 1996-00	OG303046-OG840500	REC300-01852	REC398-9610A19	REC96455A9	REC883072T	
V-150 2T	6 2000-05	OG960500-OT178499			REC96455T18		
Black Max	6 1976-79	4301235-5393736	REC300-01852	REC398-5454A17	REC96455A9	PH350-0003	
Black Max	6 1979-84	5593737-6618750	REC300-01852	REC398-5454A17	REC96455A9	PH350-0003	
V-175 9 A	6 1985-88	6618751-C100860	REC300-01852	REC398-5454A17	REC96455A9	PH350-0003	
V-175 15 A	6 1985-88	6618751-C100860	REC300-01852	REC398-5454A35	REC96455A9	PH350-0003	
V-175 40 A	6 1989-90	C100861-C239552	REC300-01852	REC398-9610A19	REC96455A9		
V-175 16 A	6 1990-91	OC239553-OD081999	REC300-01852	REC398-5454A35	REC96455A9	PH350-0003	
V-175 40 A	6 1990-91	OC239553-OD081999	REC300-01852	REC398-9610A19	REC96455A9		
XRi 40A	6 1992-95	OD082000-OG201874	REC300-01852	REC398-9610A19	REC96455A9	REC883072T	
XRi 40A	6 1996-00	OG303046-OG840500	REC300-01852	REC398-9610A19	REC96455A9	REC883072T	
XR2 SptJet	6 1997-99	OE151580-OE345000	REC18495A26		REC96455A9	REC883072T	
V-175 EFI 2T	6 2000-01	OG960500-OT178499			REC96455T18		

	CYL			CAJA NEGRA	STARTOR	TRIGGER	REGULADOR	
				POWER PACK			REGULATOR	
				BOITIER ELECTRONIQUE			REGOLATORE	
							REGULATEUR	
200	Black Max	6	1978-79	4839034 - 5363917	REC300-01852	REC398-5454A17	REC96455A9	PH350-0003
	Black Max	6	1979-81	5363918-6073191	REC300-01852	REC398-5454A17	REC96455A9	PH350-0003
	V-200 15 A	6	1982-90	6073192-C239553	REC300-01852	REC398-5454A17	REC96455A9	PH350-0003
	V-200 16 A	6	1985-90	6625221-C239553	REC300-01852	REC398-5454A17	REC96455A9	PH350-0003
	V-200 16 A	6	1989-95	C100861-OG201874	REC300-01852	REC398-5454A17	REC96455A9	PH350-0003
	V-200 Xri 40A	6	1989-91	C100861-OG303045	REC300-01852	PH400-0002	REC96455A9	
	V-200 16 A	6	1992-99	D082000-OG201874	REC300-01852	REC398-5454A17	REC96455A9	REC883072T
	V-200 40 A	6	1989-91	OG201875-OG30345	REC300-01852	REC398-9610A19	REC96455A9	
	V-200 2T	6	2000-05	OG960500-OT178499			REC96455T18	
	EFI	6	1992-99	D082000-OG840500	REC300-01852	REC398-9610A19	REC96455A9	REC883072T
	EFI	6	2000-05	OG960500-OT178499			REC96455T18	
	V-200	6	1987-88	B117316-C100860	REC300-01852	REC398-5454A17	REC96455A9	PH350-0003
	225 V-225	6	1981-93	5628028-D280812	REC300-01852	REC398-5454A17	REC96455A9	PH350-0003
	250 2.5L 16 A	6	1989-94	C101891-D280900	REC300-01852	REC398-5454A17		PH350-0003
250 2.5L 40 A	6	1989-94	C101891-D280900	REC300-01852	REC398-9610A19			
275 16 A	6	1989-94	C101891-D280900	REC300-01852	REC398-5454A17		PH350-0003	
275 40 A	6	1989-94	C101891-D280900	REC300-01852	REC398-9610A19			
300 3.4L	6	1980-87	5611648-A996135	REC300-01852	REC398-5454A17		PH350-0003	

MÓDULOS Y LIMITADORES	MODULES & LIMITATORS	MODULI E LIMITATORI	MODULES ET LIMITEURS
-----------------------	----------------------	---------------------	----------------------

MÓDULO ALARMA ACEITE	OIL WARNING MODULE	MODULO DI ALLARME OLIO	MODULE ALARME HUILE
----------------------	--------------------	------------------------	---------------------

REF	OEM	
REC14857A16	14857A10, A16	30 Jet, 40, 45 Jet, 50, 55, 60 HP (3 Et 4 cyl)



LIMITADOR RPM	RPM LIMITER	LIMITATORE RPM	LIMITEUR RPM
---------------	-------------	----------------	--------------

REF	OEM	
REC821889A50	821889A9, A22, A29, A34, A38, A40, A42, A46, A50, A51	5.200 r.p.m.



MERCATHODE

REF	OEM	
REC42600A09	42600A1/3/5/09	Verado 4Et 6 cyl (in-line) 2.5l (DFI) 3.0L (EFI)

new

MERCURY

RECAMBIO
MARINOS

DESCONECTORES DE SEGURIDAD

REF	OEM
REC200	



CUT OFF SWITCHES

REF	OEM
REC6A0-82550-01	87-93102M



CHIAVETTA DI SICUREZZA

REF	OEM
REC688-82575-01	87-97682M



COUPE CIRCUIT DE SECURITE

REF	OEM
REC65W-82575-01	87-97757M



REF	OEM	HP
REC87-823609A17	87-823609A17	6 - 25



REF	OEM
REC87-19674A1	87-19674A1



REF	OEM
REC8M0092849	15920A54
	8M0092850
	8M0092849
	86352
	86352A48
86352A54	



KITS
Interruptor de encendido para todo tipo de motores fueraborda o intraborda

KITS
Emergency and stop switch for inboard or outboards.

KIT
Interruttore di accensione per tutti i tipi di motori fuoribordo o entroaborda.

KITS
Coupe circuit de sécurité pour moteur inboard ou hors-bord

REF KIT	CUERDA WIRE CORDA CORDON	1
REC40970	REC40990	1



REF KIT	CUERDA WIRE CORDA CORDON	1
GS11290	GS11291	1



REF KIT	1
GS11292	1



REF	1
GS11294	1

J/E, OMC, Mercury, Yamaha, Honda, Suzuki, Tohatsu.



TRIM, TILT & POWER TRIM

INSTALACIÓN ELÉCTRICA

WIRING HARNESS

INSTALLAZIONE ELETTRICA

INSTALLATION ELECTRIQUE

KIT CONVERSIÓN
Sustituye de 2 a 3 cables.

CONVERSION KIT
Converts 3-wire Tilt and Trim motors to 2-Wire design

KIT CONVERSIONE
Sustituisce da 2 a 3 cavi.

FAISCEAU CONVERTISSEUR 3 A 2 FILS

REF	OEM
PH200-WH01	84-819514T26 84-826075A2 84-826802A4



VÁLVULA DE ALIVIO

MANUAL RELEASE VALVE

VALVOLA SCARICO MANUALE

SOUPAPE DE DEBLOCAGE MANUEL

REF	OEM
REC893929A01	893929A01 813442A2 813442A1 811618A1 811618 812843A1 99660A1



LATIGUILLOS TRIM

TRIM HOSES

TUBO TRIM

TUYAU DE TRIM

REF	OEM	Icon
REC32-88005	32-88005	35 HP (2 cyl) 50, 60, 70 HP (3 cyl)
REC32-88006	32-88006	45, 50 HP (4 cyl)



MOTOR TRIM COMPLETO

COMPLETE TRIM ASSEMBLY

MOTORINO TRIM COMPLETO

MOTEUR DE TRIM COMPLET

REF	OEM	Icon	Icon	Icon	2T STROKES	4T STROKES
REC827675A1	827675A1	25 - 50 HP	4	2		✓



REF	OEM	Icon	Icon	2T STROKES	4T STROKES
PH200-T003	818903A1	30 JET			
	819762A4-A7	35			
	819479A1	40 2, 3, 4 cyl			
	809885A2	40, 45 & BIGFOOT			
	819480A1	50 3 cyl & BIGFOOT			
	81977A8-A9	55 3 cyl			
	822870A1	60 3 cyl & BIGFOOT	2		✓
	830250A3-T3	65 JET			
	832021A1-T4-A2-T2	75 3 cyl			
	855654A1-T2	80 JET			
19217A1-A5	90 3 cyl 100,115 & 125 4 cyl.				



REF	OEM	Icon	Icon	2T STROKES	4T STROKES
REC878265A6	811628 878265A6	40 - 225HP (1985+)	2		✓

Con sistema TRIM, Design II
With TRIM system, Design II
Con il sistema di TRIM, Design II
Avec système Trim, Design II



REF	OEM			2T STROKES	4T STROKES
REC826729A10	99186/T			3	✓
	99186-1				
	826729A4				
	826729A4/07				
	826729A/08				

40 - 220HP
O/B (1985-92)

Con sistema TRIM, Design I
With TRIM system, Design I
Con il sistema di TRIM, Design I
Avec système Trim, Design I



REF	OEM			2T STROKES	4T STROKES
PH200-T015	17649A1/A02			3	✓





V150, V175, V200, V225, V3.4L



REF	OEM			2T STROKES	4T STROKES
PH200-T033	824051			2	✓
	830250A6				

65 Et 80 JET,
75 Et 90 (3 cyl)
100, 115 Et 125
(4 cyl)



REF	OEM			2T STROKES	4T STROKES
PH200-T008	823653A5/A9			3	✓
	92459A4				





225-250-275HP
V-3.4L



REF	OEM			2T STROKES	4T STROKES
REC8M0089940	8M0089940			2	✓
	8M0142591				

65 - 300HP
EFI
NEW V6 Et V8



REF	OEM			2T STROKES	4T STROKES
PH200-T069	888645T1			2	✓
	88845T02				

225 EFI V6
(0T653945+)



REF	OEM			2T STROKES	4T STROKES
PH200-T010	135, 150XR6, 175, 200, 225, 250, (EFI / DFI)			2	✓
	300X (3.0L EFI)				
	MAGNUM III, 105-140 JET				
	Último modelo V6				
	Late model V6				
	Último modelo V6				
	Dernière modèle V6				



P 45



REF
LUB11578U12

POWER TRIM COMPLETO



COMPLETE POWER TRIM ASSEMBLY

MOTORINO POWER TRIM COMPLETO

POWER TRIM COMPLET

REF	OEM			
REC8M0143219	8M0143219 855998A3, 05, 07, 08, 09, 10, 11 855998T1 826729T2 862729A2, 6			3-RAM SYSTEM (1996-10) DESIGN II AFT FILL 2



REF	OEM			
REC826729A10K	818186A6 826729A07 826729A08 826729A09 826729AA10 826729A4			3-RAM SYSTEM (1984-95) 3



KIT REPARACIÓN TRIM

RAPAIR KIT, TRIM

KIT RIPARAZIONE TRIM

KIT REPARATION TRIM

REF	OEM		2T STROKES	4T STROKES
REC878408A1	878408A1		110 - 300 HP	✓ ✓

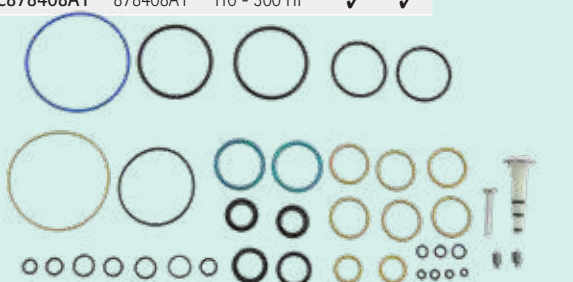

P. 53

REF
RECTOOLTRIMKIT

SENSOR DE TRIM

TRIM SENSOR

SENSORE TRIM

SONDE TRIM

REF	OEM		2T STROKES	4T STROKES
REC8M0098264	8M0098264 8M0075845 821400A2		30 - 125 HP	✓ ✓



REF	OEM		2T STROKES	4T STROKES
REC888590002	888590002 888590		200 - 300 HP VERADO 6 cyl	✓



REF	OEM		2T STROKES	4T STROKES
REC896688001	896688001		135 - 225 HP VERADO 4 cyl	✓ ✓



PLATINOS Y CONDESADORES

POINTS & CONDENSERS

PUNTINE E CONDENSATORE

VIS PLATINEES ET CONDENSATEUR

CONDENSADORES

CONDENSERS

CONDENSATORI

CONDENSATEUR

REF	OEM	
REC394-1130A1	394-1130A1	500



REF	OEM	
REC398-693	398-693	60, 100, 110, 150, 200, 250



PLATINOS

POINTS

PUNTINE

VIS PLATINEES

REF	OEM	
REC398-174	398-174	60, 100, 110, 150, 200, 250



REF	OEM	
REC398-2202	398-2202	39, 40 HP (1 cyl) 60, 75, 110, 350



REF	OEM	
REC394-1100A3	394-1100A3	300, 350



KITS

REF	PLATINO POINT PUNTINO VIS PLATINEE	CONDENSADOR CONDENSER CONDENSATORE CONDENSATEUR
REC18-5007	REC398-174	REC398-693
REC18-5012	REC394-1100A3	REC394-1130A1



REC18-5007



REC18-5012

JUNTAS DISTRIBUIDOR

DISTRIBUTOR GASKET

GUARNIZIONE
DISTRIBUTORE

JOINT DE DISTRIBUTEUR

REF	OEM	
REC27-25725	27-25725	40-65 HP



REF	OEM	
REC27-47190	27-47190	500 650 (4 cyl) (1970-75)



REF	OEM	
REC27-46351	27-46351	650 (4 cyl) 950 (6 cyl)

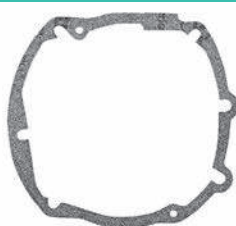

REF	OEM	
REC27-29166	27-29166	L4 cyl 300, 400, 450, 500, 650

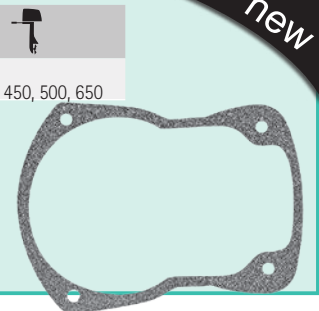

new

SISTEMA DE GOBIERNO STEERING SYSTEM

SISTEMA DI GUIDA SYSTÈME DE DIRECTION

MANDOS DE CONTROL ENGINE CONTROLS

COMANDI DI CONTROLLO

BOITIER DE COMMANDE

MANDO LATERAL

SIDE CONTROL

COMANDO LATERALE

BOITIER LATÉRAL

REF	OEM		CABLES	
REC881170A3	881170A3 16901A15 16902A15	8	15 ft 4.58 m	4000 (1993)





Mando de control de generación 1. Cuando se usa con motores fueraborda de 4 tiempos de 8, 9.9, 15, 20 HP de 2005 y posteriores, se requiere un arnés adaptador

This is a generation 1 control box. When used with 2005 and newer 8, 9.9, 15, 20 HP 4 Stroke outboards an adapter harness is required

Questa è una scatola di controllo di prima generazione. Se utilizzato con fuoribordo a 4 tempi 8, 9.9, 15, 20 HP dal 2005 e più recenti, è necessario un cablaggio adattatore

Il s'agit d'un boîtier de commande de génération 1. Lorsqu'il est utilisé avec les moteurs hors-bord 8, 9.9, 15, 20 HP 4 temps 2005 et plus récents, un câble adaptateur est requis

REF	OEM	TRIM		CABLES	
REC881170A15	881170A15 881170A1 16900A15	✓	8	15 ft 4.58 m	4000 (1993-05) 40 HP



MERCURY

RECAMBIOS
MARINOS



Mariner 30 a 55 (origen japonés), excepto 30/40 (2 cil.) con inyección de aceite integral

Mariner 30 to 55 (Japanese origin), except 30/40 (2 cyl.) with integral oil injection

Mariner da 30 a 55 (origine giapponese), tranne 30/40 (2 cil.) Con iniezione d'olio integrale

Mariner 30 à 55 (origine japonaise), sauf 30/40 (2 cyl.) avec injection d'huile intégrée

new

REF	OEM	 CABLES	
REC881170A7	881170A7 16907A15	7 16 ft	30 - 55 HP (JAPAN)





Fueraborda de cuatro tiempos con arranque eléctrico y Power trim.

Four Stroke outboards with electric start and Power trim.

Fuoribordo a quattro tempi con avviamento elettrico e Power trim.

Hors-bord à quatre temps avec démarrage électrique et Power Trim.

new

REF	OEM	TRIM	 CABLES		2T STROKES	4T STROKES
REC881170A11	881170A11	✓	10 15 ft		MY2005+ 8, 9.9 HP 8, 9.9 HP (OR192772) 15, 20 HP GEN I	✓





Tiene un arnés con conector Amp y se conecta directamente sin el uso de un arnés adaptador.

Has a harness with Amp connector and will direct connect without the use of an adapter harness.

Ha un cablaggio con connettore Amp e si collegherà direttamente senza l'uso di un cablaggio adattatore.

Possède un faisceau avec connecteur Amp et se connecte directement sans l'utilisation d'un faisceau adaptateur.

new

REF	OEM	TRIM	 CABLES		2T STROKES	4T STROKES
REC881170A12	881170A12	✓	10 15 ft 4.58 m		MY2005+ 8, 9.9 HP	✓





Power Trim y alarma acústica incorporada. Power Trim Motors. Warning horn.

Power Trim e clacson integrado.



Power Trim et klaxon intégré.

new

REF	OEM	TRIM		CABLES		2T STROKES	4T STROKES
REC881170A14	881170A13 881170A14	✓	14	20 ft 4.58 m	Mercury Optimax (2006-14)		✓



new

REF	OEM	TRIM		CABLES		2T STROKES	4T STROKES
REC881170A16	881170A16		14	20 ft 4.58 m	Mercury Optimax (2006-14)		✓



Power Trim y alarma acústica incorporada. Power trim models. Warning horn.

Power Trim e clacson integrado.

Power Trim et klaxon intégré.

new

REF	OEM	TRIM		CABLES	
REC881170A20	881170A20 16900A20	✓	8	20 ft	Mercury Mariner OB



MERCURY

RECAMBIOS
MARINOS

MANDO PARA CONSOLA

CONSOLE CONTROL

COMANDO PER
CONSOLLA

BOITIER POUR CONSOLE

REF	OEM	TRIM	CABLES	
REC8M0075245	8M0075245 8M0041426	✓		4500 DUAL



new

REF	OEM	TRIM	CABLES	
REC8M0059686	8M0059686	✓		4500 SINGLE



new

INTERRUPTORES
Y CABLES

SWITCHS & CABLES

INTERRUTTORI E CAVI

INTERRUPTEUR
ET CÂBLES

INTERRUPTOR MANDO

CONTROL SWITCH

INTERRUTTORI
CONTROLLO

INTERRUPTEUR DE
CONTRÔLE

REF	OEM	
REC87-91941A8	87-91941A8 87-91941A6	COMANDER 2000 SERIAL 4000 LATERAL SIDE LATERALE LATERAL



new

INTERRUPTOR TRIM

TRIM SWITCH

INTERRUTTORI TRIM

INTERRUPTEUR TRIM

REF	OEM	
REC87-18286A43	87-18286A43 87-18286A26 87-18286A2 87-16991A1	4000 (1994+)



new

REF	OEM	
REC87-858679T2	87-858679T2	4500 GEN II Dual & Single



new



new

REF	OEM	
REC87-859032T02	87-859032T02	4000 GEN II LATERAL SIDE LATERALE LATERAL

ZUMBADOR ACÚSTICO ALARMA

ALARM ASSY

KIT ALLARME

BUZZER D'ALARME

REF	OEM	
REC8M0144930	84-8M0144930 84-8M3001068 84-816492A1 17065A1	12V



new

ADAPTADORES DE CABLES MORSE 33C

CABLES ADAPTERS MORSE 33C

ADATTATORI CAVI MORSE 33C

ADAPTATEURS POUR CÂBLES MORSE 33C

REF	
PRE30107	82779



REF	
PRE30212	892790A01



CABLES DE DIRECCIÓN

STEERING CABLE

CAVI DI TIMONERIA

CÂBLES DE COMMANDE

GEN I

Mercury, Mercruiser, Mariner

REF	OEM	
PREKM63706	8M0082479	6' / 1,80 m
PREKM63707	8M0082480	7' / 2,10 m
PREKM63708	8M0082481	8' / 2,45 m
PREKM63709	8M0082482	9' / 2,75 m
PREKM63710	8M0082483	10' / 3,05 m
PREKM63711	8M0082484	11' / 3,35 m
PREKM63712	8M0082485	12' / 3,65 m
PREKM63713	8M0082486	13' / 3,95 m
PREKM63714	8M0082487	14' / 4,25 m
PREKM63715	8M0082488	15' / 4,60 m
PREKM63716	8M0082489	16' / 4,90 m
PREKM63717	8M0082490	17' / 5,20 m
PREKM63718	8M0082491	18' / 5,50 m
PREKM63719	8M0082492	19' / 5,80 m
PREKM63720	8M0082493	20' / 6,10 m
PREKM63721	8M0082494	21' / 6,40 m
PREKM63722	8M0082495	22' / 6,70 m
PREKM63723	8M0082496	23' / 7,00 m
PREKM63724	8M0082497	24' / 7,30 m



GEN II

Mercury 4000 / 4500 GEN II PLATINUM

REF	OEM	
PRE53006	8M0082529	6' / 1,80 m
PRE53007	8M0082530	7' / 2,10 m
PRE53008	8M0082531	8' / 2,45 m
PRE53009	8M0082532	9' / 2,75 m
PRE53010	8M0082533	10' / 3,05 m
PRE53011	8M0082534	11' / 3,35 m
PRE53012	8M0082535	12' / 3,65 m
PRE53013	8M0082536	13' / 3,95 m
PRE53014	8M0082537	14' / 4,25 m
PRE53015	8M0082538	15' / 4,60 m
PRE53016	8M0082539	16' / 4,90 m
PRE53017	8M0082540	17' / 5,20 m
PRE53018	8M0082541	18' / 5,50 m
PRE53019	8M0082542	19' / 5,80 m
PRE53020	8M0082543	20' / 6,10 m
PRE53021	8M0082544	21' / 6,40 m
PRE53022	8M0082545	22' / 6,70 m
PRE53023	8M0082546	23' / 7,00 m
PRE53024	8M0082547	24' / 7,30 m



3300C

Recorrido trabajo: 76 mm.
Rosca 10-32"

Travel 3"
Threaded 10-32"

Estensione: 76 mm
Filetto 10-32"

Course: 76 mm.
Fil 10-32"

REF	RO	
PRE3300C05	8M0082577	5' / 1,50 m
PRE3300C06	8M0082578	6' / 1,80 m
PRE3300C07	8M0082579	7' / 2,10 m
PRE3300C08	8M0082580	8' / 2,45 m
PRE3300C09	8M0082581	9' / 2,75 m
PRE3300C10	8M0082582	10' / 3,05 m
PRE3300C11	8M0082583	11' / 3,35 m
PRE3300C12	8M0082584	12' / 3,65 m
PRE3300C13	8M0082585	13' / 3,95 m
PRE3300C14	8M0082586	14' / 4,25 m
PRE3300C15	8M0082587	15' / 4,60 m
PRE3300C16	8M0082588	16' / 4,90 m
PRE3300C17	8M0082589	17' / 5,20 m
PRE3300C18	8M0082590	18' / 5,50 m
PRE3300C19	8M0082591	19' / 5,80 m
PRE3300C20	8M0082592	20' / 6,10 m
PRE3300C21	8M0082593	21' / 6,40 m
PRE3300C22	8M0082594	22' / 6,70 m
PRE3300C23	8M0082595	23' / 7,00 m
PRE3300C24	8M0082596	24' / 7,30 m

REF	RO	
PRE3300C25	8M0082597	25' / 7,60 m
PRE3300C26	8M0082598	26' / 7,90 m
PRE3300C27	8M0082599	27' / 8,25 m
PRE3300C28	8M0082600	28' / 8,55 m
PRE3300C29	8M0082601	29' / 8,85 m
PRE3300C30	8M0082602	30' / 9,15 m
PRE3300C31	8M0082603	31' / 9,50 m
PRE3300C32		32' / 9,75 m
PRE3300C33		33' / 10,00 m
PRE3300C34	8M0082604	34' / 10,35 m
PRE3300C35		35' / 10,65 m
PRE3300C36	8M0082605	36' / 11,00 m
PRE3300C38	8M0082606	38' / 11,50 m
PRE3300C40		40' / 12,10 m
PRE3300C42		42' / 12,70 m
PRE3300C44		44' / 13,30 m
PRE3300C46		46' / 14,00 m
PRE3300C48		48' / 14,50 m
PRE3300C50		50' / 15,00 m

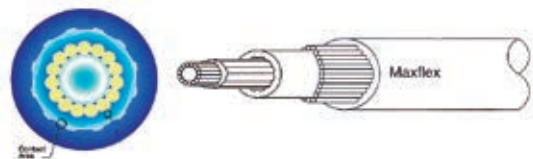

SILENBLOCK

SILENBLOCK

SILENBLOCK

SILENT BLOC

REF	OEM	2T STROKES	4T STROKES
PAF8-02000100	853771004		
PAF8-00000002	803775006	8, 9.8 HP (209 cc)	✓
PAF8-00000100	895167001		



SISTEMA DE REFRIGERACIÓN COOLING SYSTEM

SISTEMA DI RAFFREDDAMENTO SYSTÈME DE REFROIDISSEMENT

LÍQUIDO INHIBIDOR DE LA CORROSIÓN

Diseñado especialmente para eliminar sedimentos de sal de cualquier superficie pintada, de metal, fibra de vidrio, vinilo, caucho, cristal o plástico. Es el método más eficaz para proteger los motores, los aparejos de pesca... Genera una capa de polímeros que evita futuras sedimentaciones.

SALT OFF

It is specifically formulated to quickly and effectively remove salt deposits from metal, fiberglass, plastic or painted surfaces. It contains special polymers that bond to the treated surface to help prevent the formation of future deposits.

LIQUIDO INIBITORE DELLA CORROSIONE

Appositamente progettato per rimuovere depositi di sale da qualsiasi superficie verniciata, metallo, fibra di vetro, vinile, gomma, vetro o plastica. È il metodo più efficace per proteggere motori, attrezzi da pesca... Genera uno strato di polimeri che impedisce la futura sedimentazione.

LIQUIDE INHIBANT LA CORROSION

La protection SALT OFF est formulé pour éliminer les dépôts de sel sur toutes les surfaces marines. Utilisable pour le rinçage des moteurs hors bord et inboard et les embases. Il laisse un film de protection spécial pour prévenir des attaques futures du sel.

new



REF
STA94100

Star brite



REF	Image of Jug	Volume
STA93900		3,78 L
STA93922		650 ml
STA93932		1 L

STA93900



STA93932



STA93922



P
37



P
39

MERCURY

RECAMBIOS
MARINOS

TERMOSTATO

THERMOSTAT

TERMOSTATO

THERMOSTAT

TERMOSTATO

THERMOSTAT

REF	OEM		2T STROKES	4T STROKES	°C	°F
RM804540	804540	2 - 30 HP	✓	✓	52	12



TERMOSTATO

THERMOSTAT

REF	OEM		2T STROKES	4T STROKES	°C	°F
RM855676005	855676005	8, 9,9 HP		✓	71	160



REF	OEM		2T STROKES	4T STROKES	°C
REC6E5-12411-02	11919M	6C, 6D 8C, 8K W8 (MARATHON)		✓	50



REF	OEM		2T STROKES	4T STROKES	°C	°F
REC855676002	855676002	8 (209cc) 15 (2 cyl), 20, 25 HP		✓	60	140



REF	OEM		2T STROKES	4T STROKES	°C	°F
REC14586	14586	6 - 125 hp	✓	✓	48.8	120



new

REF	OEM		2T STROKES	4T STROKES	°C	
REC8M0139434	8M0139434	9.9 EFI (1R008146+) 10, 15, 20 EFI (OR833820+) 2 cyl		✓	52°	✓



REF	OEM		2T STROKES	4T STROKES	°C	°F
REC6F5-12411-03	75692 814554T01	7.5 - 250 hp	✓		61,6	143



REF	OEM		2T STROKES	4T STROKES	°C	°F
REC825212T02	855676003 855676A1 825212A1	13.5, 15, 25, 30, 40, 45, 50 HP		✓	60	140



new



REF	OEM		2T STROKES	4T STROKES	°C
REC13350	75692 27-62386	7.5 - 25 HP (2 cyl) 55 - 90 HP (3 cyl) 100 - 125 HP (4 cyl) 150 - 300 HP (V6)		✓	60°



new

REF	OEM		2T STROKES	4T STROKES	°C
REC8M0117413	8M0117413	30, 35, 40, 50, 60 HP EFI		✓	48.8





REF	OEM		2T STROKES	4T STROKES	°C	°F
REC895338	F97068-2 895338		30, 40 HP 2 CYL	✓	54,4	130



REF	OEM		2T STROKES	4T STROKES	°C	°F
REC892864T04	892864T04		135 - 400 Verado	✓	60	



REF	OEM		2T STROKES	4T STROKES	°C	°F
REC850055001	850055 850055001		30 - 60 HP	✓	43,3	110





REF	OEM		2T STROKES	4T STROKES	°C	°F
REC833072003	833072003		V-135 - 200 HP	✓	61,6	143



REF	OEM		2T STROKES	4T STROKES	°C	°F
REC67F-12411-01	8M0117413		75 EFI, 80 EFI, 90 EFI, 100 EFI	✓	60	



REF	OEM		2T STROKES	4T STROKES	°C	°F
REC8M0162139	8M0162139 8M0137816		175, 200, 225 HP 3.4L V6 200, 225, 250, 300 HP 4.6L V8	✓	60	



REF	OEM		2T STROKES	4T STROKES	°C	°F
REC892864T06	892864T06 8M0090819		75 - 115 HP EFI (1B366823 - 2B094995) 150, 135 HP (1B905505+)	✓	48,8	✓



REF	OEM		2T STROKES	4T STROKES	°C	°F
REC8M0067307	885599004 8M0057307		200 - 300 HP	✓	54,4	130



REF	OEM		2T STROKES	4T STROKES	°C	°F
REC60V-12411-00	881429		115 EFI (0T178500 - 1B366822)	✓	50°	



REF	OEM	°C	°F
REC833072004	833072004	61,6	143



GUÍA DE TERMOSTATO			THERMOSTAT GUIDE			GUIDA TERMOSTATO			GUIDE THERMOSTAT		
4T			REF			2T			KIT REF		
STROKES						STROKES					
2HP, 2.5HP (Carb)	OR131842 +	RM804540	4A/ 5C/ 6C-D		REC6E5-12411-02	6HP	9461526	REC14586A3	REC14586		
3.5HP (Carb)			8HP (C/K) W8		REC6E5-12411-02	8HP	9461526	REC14586A3	REC14586		
4HP, 5HP, 6HP	OP073456 +	RM804540	9.9HP	9461526	REC14586A3	9.9HP	9461526	REC14586A3	REC14586		
8HP (209 cc)	OP325500 +	REC855676002	15HP	9542620	REC14586A3	15HP	9542620	REC14586A3	REC14586		
8HP (Bodensee)	OP086824 - OP400999	REC825212T02	15 Sea Pro	9927000	REC14586A3	15 Sea Pro	9927000	REC14586A3	REC14586		
9.9HP (209 cc)	OP325500 +	REC855676002	Super 15	9507381	REC14586A3	Super 15	9507381	REC14586A3	REC14586		
9.9HP (323 cc)	OP075166 - OP400999	REC825212T02	20HP	9467988	REC14586A3	20HP	9467988	REC14586A3	REC14586		
13.5 (International)	OP134638 +	REC825212T02	25HP (2Cyl)	9467988	REC14586A3	25HP (2Cyl)	9467988	REC14586A3	REC14586		
15HP	OP9973100 +	REC825212T02	25 Sea Pro	9507381	REC14586A3	25 Sea Pro	9507381	REC14586A3	REC14586		
15HP (Carb) (2 Cyl)	OR235949 +	REC855676002	30HP (2Cyl)	9855139	REC14586A7	30HP (2Cyl)	9855139	REC14586A7	REC895338		
15HP (SEAPRO)	OR123565 +	REC855676002	35HP	9384476	REC75692A6	35HP	9384476	REC75692A6	REC6F5-12411-03		
20HP (Carb) (2 Cyl)	OR235168 +	REC855676002	40HP (2Cyl)	9855139	REC14586A7	40HP (2Cyl)	9855139	REC14586A7	REC895338		
25HP	OP9973100 +	REC825212T02	40HP (3Cyl)	9973100	REC850055A2	40HP (3Cyl)	9973100	REC850055A2	REC850055001		
25HP (SEAPRO) (EFI)	OR051710 +	REC855676002	50HP (3Cyl)	9482600 - 9671686	REC75692A7	50HP (3Cyl)	9482600 - 9671686	REC75692A7	REC6F5-12411-03		
30HP	OP017000 +	REC825212T02	50HP (3Cyl)	9682500 - 9740999		50HP (3Cyl)	9682500 - 9740999		REC14586		
30HP (Carb) (3 Cyl) (EFI)	OP153500 - OP400999	REC825212T02	50HP (3Cyl)	9741000 - 9973099		50HP (3Cyl)	9741000 - 9973099		REC14586		
40HP	994408	REC825212T02	55HP (3Cyl)	9973100	REC850055A2	55HP (3Cyl)	9973100	REC850055A2	REC850055001		
40HP (Carb) (3 Cyl)	OP153500 - OP400999	REC825212T02	55HP (3Cyl)	9682500 - 9740999		55HP (3Cyl)	9682500 - 9740999		REC14586		
40HP (4Cyl)	OP094500 - OP206999	REC14586	55HP (3Cyl)	9741000 - 9973099		55HP (3Cyl)	9741000 - 9973099		REC14586		
40HP (EFI) (3 Cyl)	OP401000 - OP400999	REC825212T02	60HP (3Cyl)	9482600 - 9671686	REC75692A7	60HP (3Cyl)	9482600 - 9671686	REC75692A7	REC6F5-12411-03		
40HP (EFI) (4 Cyl)	OP401000 +	REC14586	60HP (3Cyl)	9682500 - 9740999		60HP (3Cyl)	9682500 - 9740999		REC14586		
40HP ITALY	OP017000 - OP094499	REC825212T02	60HP (3Cyl)	9741000 - 9973099		60HP (3Cyl)	9741000 - 9973099		REC14586		
45HP Bodensee	9944807	REC825212T02	60HP (3Cyl)	9973100	REC850055A2	60HP (3Cyl)	9973100	REC850055A2	REC850055001		
50HP (BIGFOOT)			70HP (3Cyl)	9483121	REC803061T1	70HP (3Cyl)	9483121	REC803061T1	REC14586		
50HP (EFI)	OP153500 +	REC14586	75HP (3Cyl)	9589039	REC803061T1	75HP (3Cyl)	9589039	REC803061T1	REC14586		
50HP (4 Cyl)	OP94500 - OP206999	REC14586	80HP (3Cyl)	9483121	REC803061T1	80HP (3Cyl)	9483121	REC803061T1	REC14586		
60HP (4 Cyl)	OP94500 - OP206999	REC14586	90HP (3Cyl)	9483121	REC803061T1	90HP (3Cyl)	9483121	REC803061T1	REC14586		
60HP (EFI) (4 Cyl)	OP153500 +	REC14586	100HP (4Cyl)	9523034	REC803061T1	100HP (4Cyl)	9523034	REC803061T1	REC14586		
75HP (EFI) (Bodensee)	OG960500 - OT800999	REC825212T02	115HP (4Cyl)	9559771	REC803061T1	115HP (4Cyl)	9559771	REC803061T1	REC14586		
90HP (EFI)	OG960500 - OT800999	REC825212T02	125HP (4Cyl)	9793577	REC803061T1	125HP (4Cyl)	9793577	REC803061T1	REC14586		
100HP (EFI)	1B227077 - 1B366822	REC67F-12411-01	V-135	0A904646 +	REC6F5-12411-03	V-135	0A904646 +	REC6F5-12411-03			
			V-150	0A904646 +	REC75692Q2	V-150	0A904646 +	REC75692Q2	REC6F5-12411-03		
			XR-4	0C239553 -	REC75692Q2	XR-4	0C239553 -	REC75692Q2	REC6F5-12411-03		
				0D081999			0D081999				
			Magnum II	0C239553 -	REC75692Q2	Magnum II	0C239553 -	REC75692Q2	REC6F5-12411-03		
				0D081999			0D081999				
			XR-6	0D082000 +	REC75692Q2	XR-6	0D082000 +	REC75692Q2	REC6F5-12411-03		
			Magnum III	0D082000 +	REC75692Q2	Magnum III	0D082000 +	REC75692Q2	REC6F5-12411-03		
			V-175	0C100861 +	REC75692Q2	V-175	0C100861 +	REC75692Q2	REC6F5-12411-03		
			V-200	6435503	REC75692Q2	V-200	6435503	REC75692Q2	REC6F5-12411-03		

GUÍA DE TERMOSTATO			THERMOSTAT GUIDE			GUIDA TERMOSTATO			GUIDE THERMOSTAT		
EFI			REF			EFI			EFI		
CYL						CYL					
9.9 EFI	1R008146+	2	REC8M0139434			60 EFI	OP153500 - OP400999	BEL	4	REC14586	PAF15-07010022
10 EFI						60 EFI	OP401000 - OP515896	BEL	4	REC14586	PAF15-07010022
15 EFI						60 EFI	OP515897 - OP580772	BEL	4	REC14586	PAF15-07010022
15EFI SEAPRO	OR832820 +	2	REC8M0139434	PAF8-05010005		60 EFI	OT409000 - 1B355222	USA	4	REC14586	PAF15-07010022
20EFI						60 EFI	1C000001 - 1C050251	USA	4	REC14586	PAF15-07010022
25 EFI	OR106966 +	3	REC855676002	PAF8-05010005		60 EFI	1C050252 - 1C453839	USA	4	REC14586	PAF15-07010022
30 EFI	OP153500 - OP400999	3	REC825212T02	PAF15-07010022		60 EFI et SEAPRO	1C453840 +	USA	4	REC8M0117413	PAF15-07010022
30 EFI	OR106999 +	3	REC855676002	PAF8-05010005		75 EFI	1B172291 - 1B366822	USA	4	REC67F-12411-01	
30 EFI	OT409000 - 1B226999	3	REC825212T02	PAF15-07010022		75 EFI	1B366823 - 2B094995	USA	4	REC892864T06	
30 EFI	1C109093 - 1C456299	3	REC825212T02	PAF15-07010022		75 EFI et SEAPRO	2B095049 +		4	REC892864T06	
30 EFI	1C456300 +	3	REC825212T02	PAF15-07010022		80 EFI	OP459572 - 2B094995	BEL	4	REC892864T06	
40 EFI	OP153500 - OP400999	BEL	3	REC825212T02	PAF15-07010022	80 EFI	1B227000 - 1B366822	USA	4	REC67F-12411-01	
40 EFI	OP401000 - OP515896	BEL	3	REC825212T02	PAF15-07010022	80 EFI	1B366823 - 2B094995	USA	4	REC892864T06	
40 EFI	OP409000 - 1B226999	USA	3	REC825212T02	PAF15-07010022	80 EFI	2B095049 +		4	REC892864T06	
40 EFI	1B227000 - 1B355027	USA	3	REC825212T02	PAF15-07010022	90 EFI	1B172291 - 1B366822	USA	4	REC67F-12411-01	
40 EFI	1C000001 - 1C043416	3	REC825212T02	PAF15-07010022		90 EFI	1B366823 - 2B094995	USA	4	REC892864T06	
40 EFI	1C043417 - 1C456299	3	REC825212T02	PAF15-07010022		90 EFI et SEAPRO	2B095049 +	USA	4	REC892864T06	
40 EFI	1C456300 +	3	REC825212T02	PAF15-07010022		100 EFI	OP459572 - 2B094995	BEL	4	REC892864T06	
40 EFI	OP153500 - OP400999	BEL	4	REC14586	PAF15-07010022	100 EFI	1B227000 - 1B366822	USA	4	REC67F-12411-01	
40 EFI	OP401000 - OP515896	BEL	4	REC14586	PAF15-07010022	100 EFI	1B366823 - 2B094995	USA	4	REC892864T06	
40EFI	OP515897 - OP580772	BEL	4	REC14586	PAF15-07010022	100 EFI	2B095049 +	USA	4	REC892864T06	
40 EFI	OT409000 - 1B355222	USA	4	REC14586	PAF15-07010022	115 EFI	OT178500 - OT800999	USA	4	REC60V-12411-00	
40 EFI	1C000001 - 1C050251	USA	4	REC14586	PAF15-07010022	115 EFI	OT801000 - 1B226999	USA	4	REC60V-12411-00	
40 EFI	1C050252 - 1C453839	USA	4	REC14586	PAF15-07010022	115 EFI	1B227000 - 1B366822	USA	4	REC60V-12411-00	
40 EFI et SEAPRO	1C453840 +	USA	4	REC8M0117413	PAF15-07010022	115 EFI	1B366823 - 2B094995	USA	4	REC892864T06	
50 EFI	OP153500 - OP400999	BEL	4	REC14586	PAF15-07010022	115 EFI et SEAPRO (XS)	2B095049 +		4	REC892864T06	
50 EFI	OP401000 - OP515896	BEL	4	REC14586	PAF15-07010022	135	2B131942 +		4	REC892864T06	
50 EFI	OP515897 - OP580772	BEL	4	REC14586	PAF15-07010022	135 VERADO	OP419487 - OP464487	BEL	4	REC892864T04	
50 EFI	OT409000 - 1B355222	USA	4	REC14586	PAF15-07010022	135 VERADO	OP464488 - OP514868	BEL	4	REC892864T04	
50 EFI	1C000001 - 1C050251	USA	4	REC14586	PAF15-07010022						
50 EFI	1C050252 - 1C453839	USA	4	REC14586	PAF15-07010022						
50 EFI	1C453840 +	USA	4	REC8M0117413	PAF15-07010022						

			CYL	REF	
135 VERADO	OP514869 - OP593020	BEL	4	REC892864T04	
135 VERADO	1B227000 - 1B381711	USA	4	REC892864T04	
135 VERADO	1B381712 - 1B517158	USA	4	REC892864T04	
135 VERADO	1B517159 - 2B576734	USA	4	REC892864T04	
150	1B905505 +		4	REC892864T06	
150 SEAPRO	2B139139 +		4	REC892864T06	
150 Pro XS	2B550139 +		4	REC892864T06	
150 VERADO	OP419487 - OP464487	BEL	4	REC892864T04	
150 VERADO	OP464488 - OP514868	BEL	4	REC892864T04	
150 VERADO	OP514869 - OP593020	BEL	4	REC892864T04	
150 VERADO	1B227000 - 1B381711	USA	4	REC892864T04	
150 VERADO	1B381712 - 1B517158	USA	4	REC892864T04	
150 VERADO	1B517159 - 2B576734	USA	4	REC892864T04	
175 VERADO	OP419487 - OP464487	BEL	4	REC892864T04	
175 VERADO	OP464488 - OP514868	BEL	4	REC892864T04	
175 VERADO	OP514869 - OP593020	BEL	4	REC892864T04	
175 VERADO	1B227000 - 1B381711	USA	4	REC892864T04	
175 VERADO	1B381712 - 1B517158	USA	4	REC892864T04	
175 VERADO	1B517159 - 2B576734	USA	4	REC892864T04	
175 (3.4L) V6 Et Pro XS	2B529482 +	USA	6	REC8M0162139	
200 VERADO	OP514869 - OP593020	BEL	4	REC892864T04	
200 VERADO	1B517159 - 2B576734	USA	4	REC892864T04	
200 VERADO	OP409357 - OP464487	BEL	6	REC892864T04	
200 VERADO	OP464488 - OP520552	BEL	6	REC892864T04	
200 VERADO	OP520553 - 2B144122	BEL	6	REC892864T04	
200 VERADO	OT980000 - 1B226999	USA	6	REC892864T04	
200 VERADO	1B227000 - 1B381711	USA	6	REC892864T04	
200 VERADO	1B381712 - 1B517433	USA	6	REC892864T04	
200 VERADO	1B517434 - 2B144122	USA	6	REC892864T04	
200 VERADO	2B144123 - 2B578935	USA	6	REC892864T04	
200 Pro VERADO	2B034840 - 2B144122		6	REC892864T04	
200 Pro VERADO	2B144123 - 2B577715		6	REC892864T04	
200 (3.4L) V6 Et SEAPRO	2B529482 +	USA	6	REC8M0162139	
200 (4.6L) V8 PRO XS	2B529482 +	USA	8	REC8M0162139	
225 EFI	OT653945 +	USA	6	REC67F-12411-01	
225 VERADO	OP409357 - OP464487	BEL	6	REC892864T04	
225 VERADO	OP464488 - OP520552	BEL	6	REC892864T04	
225 VERADO	OP520553 - 2B144122	BEL	6	REC892864T04	
225 VERADO	OT980000 - 1B226999	USA	6	REC892864T04	
225 VERADO	1B227000 - 1B381711	USA	6	REC892864T04	
225 VERADO	1B381712 - 1B517433	USA	6	REC892864T04	
225 VERADO	1B517434 - 2B144122	USA	6	REC892864T04	
225 VERADO	2B144123 - 2B578935	USA	6	REC892864T04	
225 (3.4L) V6 Et SEAPRO	2B529482 +	USA	6	REC8M0162139	

			CYL	REF	
225 (4.6L) V8 PRO XS	2B529482 +	USA	8	REC8M0162139	
250 VERADO	OP409357 - OP464487	BEL	6	REC892864T04	
250 VERADO	OP464488 - OP520552	BEL	6	REC892864T04	
250 VERADO	OP520553 - 2B144122	BEL	6	REC892864T04	
250 VERADO	OT980000 - 1B226999	USA	6	REC892864T04	
250 VERADO	1B227000 - 1B381711	USA	6	REC892864T04	
250 VERADO	1B381712 - 1B517433	USA	6	REC892864T04	
250 VERADO	1B517434 - 2B144122	USA	6	REC892864T04	
250 VERADO	2B144123 - 2B578935	USA	6	REC892864T04	
250 PRO VERADO	1B830170 - 2B144122		6	REC892864T04	
250 PRO VERADO	2B144123 - 2B577715	USA	6	REC892864T04	
250 (4.6L) V8, VERADO, SEAPRO Et PRO XS	2B529482 +	USA	8	REC8M0162139	
250 (4.6L) V8 RACING	1E080500+	USA	8	REC8M0162139	
275 VERADO	OP409357 - OP464487	BEL	6	REC892864T04	
275 VERADO	OP464488 - OP520552	BEL	6	REC892864T04	
275 VERADO	OP520553 - 2B144122	BEL	6	REC892864T04	
275 VERADO	OT980000 - 1B226999	USA	6	REC892864T04	
275 VERADO	1B227000 - 1B381711	USA	6	REC892864T04	
275 VERADO	1B381712 - 1B517433	USA	6	REC892864T04	
275 VERADO	1B517434 - 2B144122	USA	6	REC892864T04	
275 VERADO	2B144123 - 2B578935	USA	6	REC892864T04	
300 VERADO	OP520553 - 2B144122	BEL	6	REC892864T04	
300 VERADO	1B517434 - 2B144122	USA	6	REC892864T04	
300 VERADO	2B144123 - 2B578935	USA	6	REC892864T04	
300 PRO VERADO	1B830170 - 2B144122		6	REC892864T04	
300 PRO VERADO	2B144123 - 2B577715	USA	6	REC892864T04	
300 (4.6L) V8, VERADO, SEAPRO Et PRO XS	2B529482 +	USA	8	REC8M0162139	
300 (4.6L) V8 RACING	1E080500+	USA	8	REC8M0162139	
350SCI VERADO	1B716557 - 2B143542		6		
350 2.6L L6 VERADO	2B141617 +	USA	6	REC892864T04	
350 2.6L L6 PRO VERADO	2B141124 +	USA	6	REC892864T04	
400 2.6L L6 VERADO	2B618256 +	USA	6	REC892864T04	
400R 2.6L L6 RACING	2B141124 +	USA	6	REC892864T04	
450 4.6L V8 RACING	2B529482 +	USA	8		

CUBIERTAS TERMOSTATO THERMOSTAT COVER COPERCHIO TERMOSTATO COUVERCLE DE THERMOSTAT



new

REF	OEM			2T STROKES	4T STROKES
PAF8-05010006	8537052			✓	✓





new

REF	OEM			2T STROKES	4T STROKES
PAF15-07010021	8M0008243 8250311 857080			8 - 60 HP	✓



new

REF	OEM			2T STROKES	4T STROKES
REC6E9-12413-00-1S	19255M K40HP 6F5-000711+ 6F5K-302372+				✓

KITS TERMOSTATO

THERMOSTATO KITS

KIT TERMOSTATO

KIT THERMOSTAT

REF	OEM
REC14586A3	14586A3

REF	OEM
REC850055A2	850055A2

REF	OEM
REC75692A7	75692A7

REF	OEM
REC75692Q2	75692Q2

REF	OEM
REC803061T1	803061T1

REF	OEM
REC75692A6	75692A6

REF	OEM
REC14586A7	14586A7

JUNTAS TERMOSTATO

THERMOSTATO GASKETS

GUARNIZIONI TERMOSTATO

JOINTS DE THERMOSTAT

REF	OEM
REC27-62386001	27-62386

Para termostatos de Ø 1".
For thermostat Ø 1".
Per termostato Ø 1".
Pour thermostats Ø 1".

REF	OEM
PAF15-07010022	27-824853

8 Bodensee
9.9, 13.5, 15, 25
30 (Carb) (EFI)
40 (Carb) (EFI)
Italy
45 Bodensee
50 (EFI, Bigfoot)
60 (EFI)

REF	OEM
PAF8-05010005	27-853702005

4 - 25 HP

REF	OEM
REC655-12414-A1	27-81031M

8A
20C
25C, K
28
30A / W30

REF	OEM
REC27-19205002	27-19205-1

6, 8, 9.9, 10, 15 HP

REF	OEM	
REC682-12414-A1	27-83940M	9.9C 15C / K W15
REC27-83940		





REF	OEM	
REC6E9-12414-A1	27-814555M	40 (Twin Carb) (con inyección de aceite with oil injection con iniezione dell'olio avec injection d'huile) W40 (w/Marathon)





REF	OEM	
REC27-14318005	27-14318-3	20 Jet 20, 25 HP (2cyl)



REF	OEM	
REC663-12414-00	27-81266M	MARINER 48 / W-48 55 / W-55 60 (2 cyl)



REF	OEM	
REC27-66847	27-66847	30, 40 HP (2 cyl)



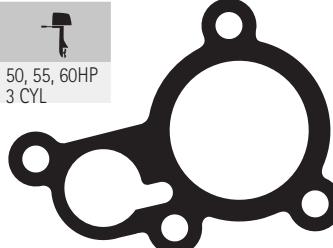

REF	OEM	
REC27-8128671	27-812867-1	50, 55, 60HP 3 CYL

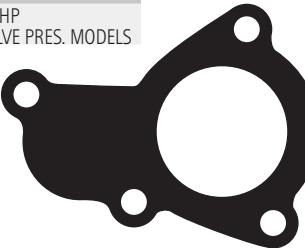

REF	OEM	
REC27-827284	27-827284	30 - 60 HP NOT VALVE PRES. MODELS





REF	OEM	
REC27-8128672	27-8128672	30 - 60 HP

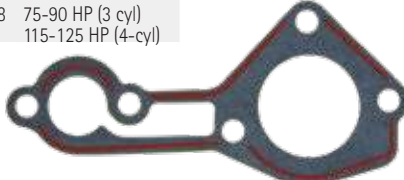

REF	OEM	
REC27-430068	27-43006-8	65-80 Jet 75-90 HP (3 cyl) 115-125 HP (4-cyl)



REF	OEM	
REC27-78690002	27-78690 27-78690002	V6



VÁLVULA ANTIPRESIÓN DE TERMOSTATO **THERMOTAT, PRESSURE VALVE**

REF	OEM	
REC318395	878907	65 - 140 hp (4 cyl)



new

VALVOLA ANTI-PRESSIONE DI TERMOSTATO **SOUPAPE DE PRESSION DE THERMOSTAT**

REF	OEM	
REC86596T	86596T	40-90 HP (2, 3 cyl) 135-225 HP V6





REF	OEM	
REC14480	14480	V6 (2.5L)



REF	OEM	
REC8612882-1	8612882-1	30, 40 HP (2 cyl) 50, 55, 60 HP (3 cyl)

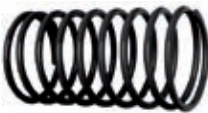

RESORTE	SPRING	MOLLA	RESSORT
			
REF	OEM		
REC24-64878	24-64878	135-200 HP V6	
REC24-47968	24-47968	30, 35, 40 (400) (402) 2 cyl	
REC24-42996	24-42996	70, 75, 80, 90 HP 3 cyl V6 (2.5L)	
REC24-90392	24-90392	30-60 HP 2 / 3 cyl V6 (3.4L)	



CONECTOR CULATA	FITTING	RACCORDO TESTATA	RACCORD DE CULASSE
ESTRIBOR STB TRIBORDO TRIBORD			
			
REF	OEM		
REC22-687271	22-687271		

GRUESO	GROMMET	SPESSORE	BAGUE
			
REF	OEM		
REC25-64872	25-64872	30-125 HP (2, 3, 4 cyl)	

RETÉN	SEAL	TENUTA	JOINT
			
REF	OEM		
REC25-854639	25-854639	30-60 HP (3 cyl) V6 (3.0L)	

DIAFRAGMA	DIAPHRAGM	MEMBRANA	DIAPHRAGME
			
REF	OEM		
REC648771	64877-1	3, L4-Cyl Et V6 (3.0L)	
REC14479-1	14479-1	V6 (2.5L)	
REC812887002	812887-1	30, 40 HP (2 cyl) 50-90 HP (3 cyl)	

TAPA	CUP	COPERCHIO	COUVERCLE
			
REF	OEM		
REC12-94182	12-94182	30-125 HP (2, 3, 4 cyl)	

DEFLECTOR	DEFLECTOR	DEFLETTORE	DEFLECTEUR
			
REF	OEM		
REC16496	16496	V6 (2.5L)	

TORNILLO PARA TODAS LAS VÁLVULAS	SCREW FOR ALL POPPET	VITE PER TUTTE LE VALVOLE	VIS POUR TOUTES LES SOUPAPES
			
REF	OEM		
REC10-69570	10-69570		

NIPLE	NIPPLE	NIPLE	TETINE
-------	--------	-------	--------



REF	OEM	 int	
REC331886	22-9964-1	Ø 3/8"	



DESPLAZABLE	CARRIER	DISTANZIALE	LOGEMENT
-------------	---------	-------------	----------

REF	OEM		
REC65848	65848	30-125 HP (2, 3, 4 cyl)	

REF	OEM		
REC827365	827365	30 Jet, 40, 45, 50, 55,60 HP (3 cyl)	



ARANDELA	WASHER	RONDELLA	RONDELLE
----------	--------	----------	----------

REF	OEM		
REC12-85303	12-85303	L6-cyl V6 (2.5L)	

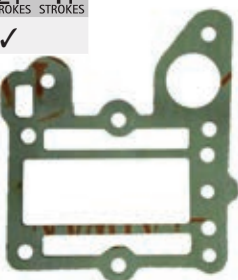

REF	OEM		
REC12-76451	12-76451	V6 (2.5L) V6 (3.0L)	Plástico Plastic Plastica Plastique



JUNTAS TAPA DE REFRIGERACIÓN	GASKET, EXHAUST INNER COVER	GUARNIZIONE COPERCHIO REFRIGERAZIONE	JOINT DE PLAQUE DE REFRROIDISSEMENT
------------------------------	-----------------------------	--------------------------------------	-------------------------------------

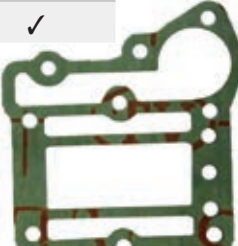

REF	OEM		2T STROKES	4T STROKES	
REC6E0-41112-A1	27-99995M	4A (1981-89)	✓		

REF	OEM		2T STROKES	4T STROKES	
REC6G1-11193-A1	27-11454M	6C/D 8D (1978-86)	✓		

REF	OEM		2T STROKES	4T STROKES	
REC6E0-41114-A1	21-41279M 99993M	5C, 4A (1977-89)	✓		

REF	OEM		2T STROKES	4T STROKES	
PAF8-05010004	27-834952001	8, 9,9 HP (209 cc)		✓	

REF	OEM		2T STROKES	4T STROKES	
REC6G1-41112-A1	27-11456M	6C/D 8C (1978-86)	✓		

REF	OEM		2T STROKES	4T STROKES	
PAF15-07010018	27-834952	8, 9,9, 13,5, 15 HP		✓	

REF	OEM		2T STROKES	4T STROKES	
REC27-62386001	27-62386	6-25 HP (1972-10)	✓		

REF	OEM		2T STROKES	4T STROKES	
REC682-41114-00	27-83951M	9.9C 15C, K W15 (1979-86)	✓		

REF	OEM	2T STROKES	4T STROKES	
REC27-25848	27-25848	10-350 HP (1970-86)	✓	

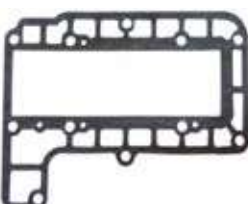
REF	OEM	2T STROKES	4T STROKES	
REC664-41114-A0	27-81570M	20C (Thru prop. exhaust) 25C (Thru prop. exhaust) 28 (1977-88)	✓	

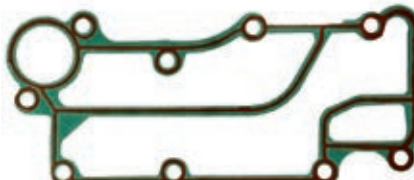
REF	OEM	2T STROKES	4T STROKES	
PAF25-05010111	27-830298	25 HP	✓	

REF	OEM	2T STROKES	4T STROKES	
REC12-38453	12-38453	30-70 HP (1970-97)	✓	

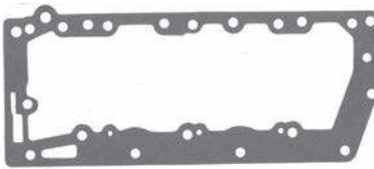
REF	OEM	2T STROKES	4T STROKES	
REC27-854913	27-85491-2	30-50 HP (1980-97)	✓	

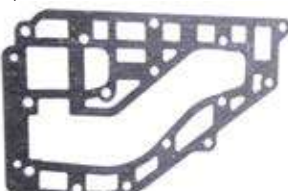
REF	OEM	2T STROKES	4T STROKES	
REC689-41112-A0	27-96656M	30A W30 (w/Marathon) (1977-92)	✓	

REF	OEM	2T STROKES	4T STROKES	
REC689-41114-A0	27-84741M	30A W30 (w/Marathon) (1977-92)	✓	

REF	OEM	2T STROKES	4T STROKES	
REC6E9-41114-A0	27-827176M	40 (Twin Carb) (1986-92) con inyección de aceite with oil injection con iniezione dell'olio avec injection d'huile	✓	

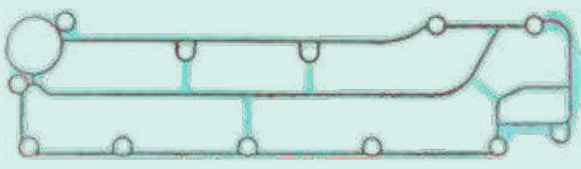
REF	OEM	2T STROKES	4T STROKES	
PAF60-05000004	27-857078	40, 50, 60 EFI 4 CYL	✓	

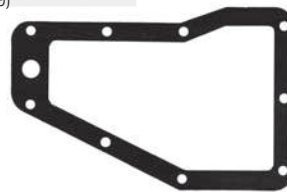
REF	OEM	2T STROKES	4T STROKES	
REC663-41114-00	27-81331M	40, W-48 55, W-55 60 (2 cyl) (1977-89)	✓	

REF	OEM	2T STROKES	4T STROKES	
REC676-41112-A0	27-83338M	40 (Twin Carb) 40A, B, C (1977-92)	✓	

REF	OEM	2T STROKES	4T STROKES	
REC27-430057	27-430057	75, 90 HP (3 cyl)	✓	

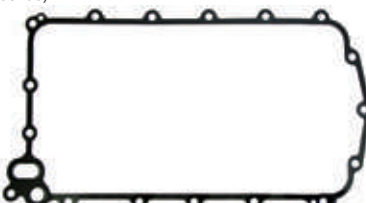
REF	OEM	2T STROKES	4T STROKES	
REC887825	27-887825	225 EFI (2003-06)	✓	

2T STROKES	OEM	CEF	A	B	C
REC6G1-44352-00	47-11590M	CEF500302	11,9	40	18
REC47-22748	47-22748	CEF500309	11,6	32	14,4
REC6L5-44352-00		CEF500322	10	36	14,5
REC6H3-44352-00	47-81423M 47-97108M	CEF500316	19,05	51,8	19,5
REC682-44352-01	47-84027T	CEF500320	13	40	22
REC689-44352-02	47-84797M	CEF500326	16,15	69,5	12,8
REC47-89980	47-89980	CEF500314	11	32	14,35
REC47-89982	47-89982	CEF500311G	16	51	19,05
REC47-89983T	47-89983T	CEF500312	19	61,8	19,05
REC47-89984T4	47-89984T4	CEF500313G	22,2	60	38,8
REC662-44352-01	47-95611M	CEF500321	14	40	22
REC6E0-44352-00	47-96305M	CEF500325	11	40	12,6
REC47-89981	47-89981	CEF500310	11,6	32	14,4
REC47-20813	47-20813		16	39	22,5
REC47-803630T	47-803630T		21	57	30
REC47-952892	47-952892 47-95289	CEF500396	12	41	14
REC646-44352-01	47-80395M	CEF500324	11,5	47,5	13,7
REC6F5-44352-00	47-99971M	CEF500352	16,04	69,8	22,1

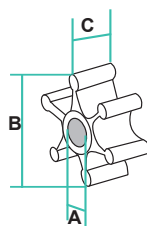

REC6G1-44352-00



REC47-22748



REC6L5-44352-00



REC6H3-44352-00



REC682-44352-01



REC689-44352-02



REC47-89980



REC47-89982



REC47-89983T



REC47-89984T4



REC662-44352-01



REC6E0-44352-00



REC47-89981



REC47-20813



REC47-803630T



REC47-952892



REC646-44352-01



REC6F5-44352-00

P. 191

GUIA BOMBAS AGUA
WATER PUMP GUIDE
GUIDA POMPA ACQUA
GUIDE DE POMPE D'EAU

4T STROKES				REF	CEF	A	B	C
2/2.5/3.5 (Carb)	OR131842 +			REC47-161543	CEF500377	10,25	33,6	14,2
04/05/06	OP073456 +			REC47-161543	CEF500377	10,25	33,6	14,2
8	OP325500 +	NON BIG FOOT		REC3B2-65021-1	CEF500344	12,1	40	18
8 (Bodensee)(Intern)	OP086824 - OP400999	BIG FOOT		REC47-8508910	CEF500315	16	73	12,6
8 (Bodensee)(Intern)	OP086824 - OP400999	NON BIG FOOT		REC47-420382	CEF500318	13	58,8	11,7
9.9 (209cc)	OP325500 +	NON BIG FOOT		REC3B2-65021-1	CEF500344	12,1	40	18
9.9 (323cc)	OP075166 - OP400999	BIG FOOT		REC47-8508910	CEF500315	16	73	12,6
9.9 (323cc)	OP075166 - OP400999	NON BIG FOOT		REC47-420382	CEF500318	13	58,8	11,7
13.5 (International)	OP134638 +	BIG FOOT		REC47-8508910	CEF500315	16	73	12,6
13.5 (International)	OP134638 +	NON BIG FOOT		REC47-420382	CEF500318	13	58,8	11,7
15	OP9973100 +	BIG FOOT		REC47-8508910	CEF500315	16	73	12,6
15	OP9973100 +	NON BIG FOOT		REC47-420382	CEF500318	13	58,8	11,7
25	9973100 - OP388282			REC47-8508910	CEF500315	16	73	12,6
30	OP017000 - OP153499	2.31:1		REC47-43026Q02	CEF500301	22,4	89	32,5
30	OP017000 - OP153499	02:01:00		REC47-8508910	CEF500315	16	73	12,6
30 Carb (3Cyl)	OP153500 - OP400999			REC47-43026Q02	CEF500301	22,4	89	32,5
40	9944807 - OP153499	2.31:1		REC47-43026Q02	CEF500301	22,4	89	32,5
40	9944807 - OP153499	02:01:00		REC47-8508910	CEF500315	16	73	12,6
40 Carb (3Cyl)	OP153500 +	DRIVE SHAFT L		REC47-19453T	CEF500378	19,25	78,2	25,15
40 Carb (3Cyl)	OP153500 +	DRIVE SHAFT S		REC47-8508910	CEF500315	16	73	12,6
40 (4Cyl)	OP094500 - OP206999	1.83:1		REC47-19453T	CEF500378	19,25	78,2	25,15
40 (4Cyl)	OP094500 - OP206999	2.31:1		REC47-43026Q02	CEF500301	22,4	89	32,5
40 ITALY	OP017000 - OP094499	BIG FOOT		REC47-43026Q02	CEF500301	22,4	89	32,5
40 ITALY	OP017000 - OP094499	NON BIG FOOT		REC47-8508910	CEF500315	16	73	12,6
45 Bodensee	OP017000 +	2.31:1		REC47-43026Q02	CEF500301	22,4	89	32,5
45 Bodensee	OP017000 +	1.83:1 / 2:1		REC47-8508910	CEF500315	16	73	12,6
50 Et BIGFOOT	9944807 - OP094499	2.31:1		REC47-43026Q02	CEF500301	22,4	89	32,5
50 Et BIGFOOT	9944807 - OP094499	1.83:1 / 2:1		REC47-8508910	CEF500315	16	73	12,6
50	OP094500 - OP206999	1.83:1		REC47-19453T	CEF500378	19,25	78,2	25,15
50	OP094500 - OP206999	2.31:1		REC47-43026Q02	CEF500301	22,4	89	32,5
60 (4Cyl)	OP094500 - OP206999	1.83:1		REC47-19453T	CEF500378	19,25	78,2	25,15
60 (4Cyl)	OP094500 - OP206999	2.31:1		REC47-43026Q02	CEF500301	22,4	89	32,5
135/150/175/200 VERADO (4Cyl)	OP419487 +			REC47-43026Q02	CEF500301	22,4	89	32,5
200/225/250/275/300 VERADO (6Cyl)	OP409357 +			REC47-43026Q02	CEF500301	22,4	89	32,5



REC47-161543



REC3B2-65021-1



REC47-8508910



REC47-420382



REC47-43026Q02



REC47-19453T

EFI	CYL	REF	EFI	CYL	REF
10 EFI			40 EFI	1C043417 - 1C456299	3 REC47-19453T
15 EFI			40 EFI	1C456300 +	3 REC47-19453T
15 EFI SEAPRO	OR832820+	2 REC334-65021-1	40 EFI	OP153500 - OP400999	4 REC47-19453T
20 EFI			40 EFI	OP401000 - OP515896	4 REC47-43026Q02
25 EFI	OR106966 +	3 REC345-65021-0	40 EFI	OP515897 - OP580772	4 REC47-19453T
30 EFI	OP153500 - OP400999	3 REC47-8508910	40 EFI	OT409000 - 1B355222	4 REC47-43026Q02
30 EFI	OR106999 +	3 REC345-65021-0	40 EFI	1C000001 - 1C050251	4 REC47-19453T
30 EFI	OT409000 - 1B226999	3 REC47-8508910	40 EFI	1C050252 - 1C453839	4 REC47-43026Q02
30 EFI	1C109093 - 1C456299	3 REC47-19453T	40 EFI Et SEAPRO	1C453840 +	4 REC47-19453T
30 EFI	1C456300 +	3 REC47-19453T	50 EFI	OP153500 - OP400999	4 REC47-43026Q02
40 EFI	OP153500 - OP400999	BEL 3 REC47-8508910	50 EFI	OP401000 - OP515896	4 REC47-19453T
40 EFI	OP401000 - OP515896	BEL 3 REC47-8508910			
40 EFI	OP409000 - 1B226999	USA 3 REC47-8508910			
40 EFI	1B227000 - 1B355027	USA 3 REC47-8508910			
40 EFI	1C000001 - 1C043416	3 REC47-19453T			

EFI		CYL	REF
50 EFI	OP515897 - OP580772	BEL 4	REC47-19453T REC47-43026Q02
50 EFI	OT409000 - 1B355222	USA 4	REC47-19453T REC47-43026Q02
50 EFI	1C000001 - 1C050251	USA 4	REC47-19453T REC47-43026Q02
50 EFI	1C050252 - 1C453839	USA 4	REC47-19453T REC47-43026Q02
50 EFI	1C453840 +	USA 4	REC47-19453T REC47-43026Q02
60 EFI	OP153500 - OP400999	BEL 4	REC47-19453T REC47-43026Q02
60 EFI	OP401000 - OP515896	BEL 4	REC47-19453T REC47-43026Q02
60 EFI	OP515897 - OP580772	BEL 4	REC47-19453T REC47-43026Q02
60 EFI	OT409000 - 1B355222	USA 4	REC47-19453T REC47-43026Q02
60 EFI	1C000001 - 1C050251	USA 4	REC47-19453T REC47-43026Q02
60 EFI	1C050252 - 1C453839	USA 4	REC47-19453T REC47-43026Q02
60 EFI & SEAPRO	1C453840 +	USA 4	REC47-19453T REC47-43026Q02
75 EFI	1B172291 - 1B366822	USA 4	REC47-43026Q02
75 EFI	1B366823 - 2B094995	USA 4	REC47-43026Q02
75 EFI & SEAPRO	2B095049 +	4	REC47-43026Q02
80 EFI	OP459572 - 2B094995	BEL 4	REC47-43026Q02
80 EFI	1B227000 - 1B366822	USA 4	REC47-43026Q02
80 EFI	1B366823 - 2B094995	USA 4	REC47-43026Q02
80 EFI	2B095049 +	4	REC47-43026Q02
90 EFI	1B172291 - 1B366822	USA 4	REC47-43026Q02
90 EFI	1B366823 - 2B094995	USA 4	REC47-43026Q02
90 EFI & SEAPRO	2B095049 +	USA 4	REC47-43026Q02
100 EFI	OP459572 - 2B094995	BEL 4	REC47-43026Q02
100 EFI	1B227000 - 1B366822	USA 4	REC47-43026Q02
100 EFI	1B366823 - 2B094995	USA 4	REC47-43026Q02
100 EFI	2B095049 +	USA 4	REC47-43026Q02
115 EFI	OT178500 - OT800999	USA 4	REC47-43026Q02
115 EFI	OT801000 - 1B226999	USA 4	REC47-43026Q02
115 EFI	1B227000 - 1B366822	USA 4	REC47-43026Q02
115 EFI	1B366823 - 2B094995	USA 4	REC47-43026Q02
115 EFI & SEAPRO (XS)	2B095049 +	4	REC47-43026Q02
135	2B131942 +	4	REC47-43026Q02
135 VERADO	OP419487 - OP464487	BEL 4	REC47-43026Q02
135 VERADO	OP464488 - OP514868	BEL 4	REC47-43026Q02
135 VERADO	OP514869 - OP593020	BEL 4	REC47-43026Q02
135 VERADO	1B227000 - 1B381711	USA 4	REC47-43026Q02
135 VERADO	1B381712 - 1B517158	USA 4	REC47-43026Q02
135 VERADO	1B517159 - 2B576734	USA 4	REC47-43026Q02
150	1B905505 +	4	REC47-43026Q02
150 SEAPRO	2B139139 +	4	REC47-43026Q02
150 Pro XS	2B550139 +	4	REC47-43026Q02
150 VERADO	OP419487 - OP464487	BEL 4	REC47-43026Q02
150 VERADO	OP464488 - OP514868	BEL 4	REC47-43026Q02
150 VERADO	OP514869 - OP593020	BEL 4	REC47-43026Q02
150 VERADO	1B227000 - 1B381711	USA 4	REC47-43026Q02
150 VERADO	1B381712 - 1B517158	USA 4	REC47-43026Q02
150 VERADO	1B517159 - 2B576734	USA 4	REC47-43026Q02
175 VERADO	OP419487 - OP464487	BEL 4	REC47-43026Q02
175 VERADO	OP464488 - OP514868	BEL 4	REC47-43026Q02
175 VERADO	OP514869 - OP593020	BEL 4	REC47-43026Q02
175 VERADO	1B227000 - 1B381711	USA 4	REC47-43026Q02
175 VERADO	1B381712 - 1B517158	USA 4	REC47-43026Q02
175 VERADO	1B517159 - 2B576734	USA 4	REC47-43026Q02
175 (3.4L) V6 Et Pro XS	2B529482 +	USA 6	REC47-43026Q02
200 VERADO	OP514869 - OP593020	BEL 4	REC47-43026Q02

EFI		CYL	REF
200 VERADO	1B517159 - 2B576734	USA 4	REC47-43026Q02
200 VERADO	OP409357 - OP464487	BEL 6	REC47-43026Q02
200 VERADO	OP464488 - OP520552	BEL 6	REC47-43026Q02
200 VERADO	OP520553 - 2B144122	BEL 6	REC47-43026Q02
200 VERADO	OT980000 - 1B226999	USA 6	REC47-43026Q02
200 VERADO	1B227000 - 1B381711	USA 6	REC47-43026Q02
200 VERADO	1B381712 - 1B517433	USA 6	REC47-43026Q02
200 VERADO	1B517434 - 2B144122	USA 6	REC47-43026Q02
200 VERADO	2B144123 - 2B578935	USA 6	REC47-43026Q02
200 Pro VERADO	2B034840 - 2B144122	6	REC47-43026Q02
200 Pro VERADO	2B144123 - 2B577715	6	REC47-43026Q02
200 (3.4L) V6 Et SEAPRO	2B529482 +	USA 6	REC47-43026Q02
200 (4.6L) V8 PRO XS	2B529482 +	USA 8	REC47-43026Q02
225 EFI	OT653945 +	USA 6	REC6E5-44352-01
225 VERADO	OP409357 - OP464487	BEL 6	REC47-43026Q02
225 VERADO	OP464488 - OP520552	BEL 6	REC47-43026Q02
225 VERADO	OP520553 - 2B144122	BEL 6	REC47-43026Q02
225 VERADO	OT980000 - 1B226999	USA 6	REC47-43026Q02
225 VERADO	1B227000 - 1B381711	USA 6	REC47-43026Q02
225 VERADO	1B381712 - 1B517433	USA 6	REC47-43026Q02
225 VERADO	1B517434 - 2B144122	USA 6	REC47-43026Q02
225 VERADO	1B517434 - 2B144122	USA 6	REC47-43026Q02
225 VERADO	2B144123 - 2B578935	USA 6	REC47-43026Q02
225 (3.4L) V6 Et SEAPRO	2B529482 +	USA 6	REC47-43026Q02
225 (4.6L) V8 PRO XS	2B529482 +	USA 8	REC47-43026Q02
250 VERADO	OP409357 - OP464487	BEL 6	REC47-43026Q02
250 VERADO	OP464488 - OP520552	BEL 6	REC47-43026Q02
250 VERADO	OP520553 - 2B144122	BEL 6	REC47-43026Q02
250 VERADO	OT980000 - 1B226999	USA 6	REC47-43026Q02
250 VERADO	1B227000 - 1B381711	USA 6	REC47-43026Q02
250 VERADO	1B381712 - 1B517433	USA 6	REC47-43026Q02
250 VERADO	1B517434 - 2B144122	USA 6	REC47-43026Q02
250 VERADO	2B144123 - 2B578935	USA 6	REC47-43026Q02
250 VERADO	2B144123 - 2B578935	USA 6	REC47-43026Q02
250 VERADO	2B144123 - 2B577715	USA 6	REC47-43026Q02
250 VERADO	2B529482 +	USA 8	REC47-43026Q02
250 (4.6L) V8 RACING	1E080500+	USA 8	REC47-43026Q02
275 VERADO	OP409357 - OP464487	BEL 6	REC47-43026Q02
275 VERADO	OP464488 - OP520552	BEL 6	REC47-43026Q02
275 VERADO	OP520553 - 2B144122	BEL 6	REC47-43026Q02
275 VERADO	OT980000 - 1B226999	USA 6	REC47-43026Q02
275 VERADO	1B227000 - 1B381711	USA 6	REC47-43026Q02
275 VERADO	1B381712 - 1B517433	USA 6	REC47-43026Q02
275 VERADO	1B517434 - 2B144122	USA 6	REC47-43026Q02
275 VERADO	2B144123 - 2B578935	USA 6	REC47-43026Q02
275 VERADO	2B144123 - 2B577715	USA 6	REC47-43026Q02
300 VERADO	OP520553 - 2B144122	BEL 6	REC47-43026Q02
300 VERADO	1B517434 - 2B144122	USA 6	REC47-43026Q02
300 VERADO	2B144123 - 2B578935	USA 6	REC47-43026Q02
300 PRO VERADO	1B830170 - 2B144122	6	REC47-43026Q02
300 PRO VERADO	2B144123 - 2B577715	USA 6	REC47-43026Q02
300 (4.6L) V8, VERADO, SEAPRO Et PRO XS	2B529482 +	USA 8	REC47-43026Q02
300 (4.6L) V8 RACING	1E080500+	USA 8	REC47-43026Q02
350SCi VERADO	1B716557 - 2B143542	6	REC47-43026Q02
350 2.6L L6 VERADO	2B141617 +	USA 6	REC47-43026Q02
350 2.6L L6 PRO VERADO	2B141124 +	USA 6	REC47-43026Q02
400 2.6L L6 VERADO	2B618256 +	USA 6	REC47-43026Q02
400R 2.6L L6 RACING	2B141124 +	USA 6	REC47-43026Q02
450 4.6L V8 RACING	2B529482 +	USA 8	REC47-43026Q02



REC334-65021-1



REC47-8508910



REC47-19453T



REC47-43026Q02



REC6E5-44352-01



REC345-65021-0

KITS DE RETENES

SEAL KIT

KIT TENUTE

KITS JOINTS

REF	OEM		2T STROKES	4T STROKES
REC26-77066A1	26-77066A1		4, 4.5, 45 (1 cyl) 7.5, 9.8 HP	✓



REF	OEM		2T STROKES	4T STROKES
REC26-79831A1	26-79831A1		30 Jet 35 - 70 HP	✓



REF	OEM		2T STROKES	4T STROKES
REC26-41365A3	26-41365A3		6 - 15 HP	✓



REF	OEM		2T STROKES	4T STROKES
REC26-814669A2	26-814669A2		30 - 60 HP	✓



REF	OEM		2T STROKES	4T STROKES
REC26-85090A2	26-85090A2		8 - 55 HP	✓

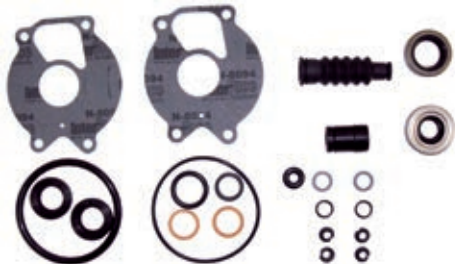

REF	OEM		2T STROKES	4T STROKES
REC26-43035A4	26-43035A4		30 - 125 HP	✓

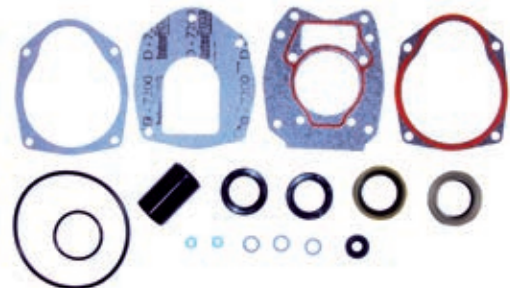

REF	OEM		2T STROKES	4T STROKES
REC26-85090A1	26-85090A1		18, 25 HP	✓

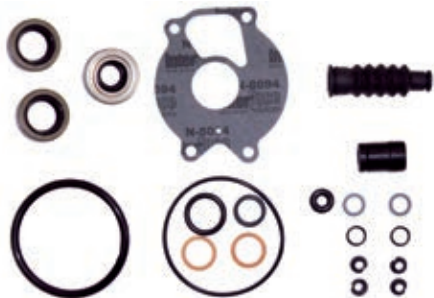

REF	OEM		2T STROKES	4T STROKES
REC26-820645A1	26-820645A1		40 / 50 HP (1992-94)	✓



REF	OEM		2T STROKES	4T STROKES
REC823547A2	823547A2		25 - 50 HP	✓



REF	OEM		2T STROKES	4T STROKES
REC8M0088080	8M0088080		65 - 115 HP	✓



new

REF	OEM	2T STROKES	4T STROKES
REC8M0088081	8M0088081	65 - 115 HP CR	✓

new

REF	OEM	2T STROKES	4T STROKES
REC26-66303A1	26-66303A1	200 / 20 HP	✓

REF	OEM	2T STROKES	4T STROKES
REC26-55682A1	26-55682A1	75 - V225 HP	✓

REF	OEM	2T STROKES	4T STROKES
REC26-816575A4	26-816575A4	200 - 250 HP (DFI / EFI) Race Outboard 225 - 300 (2.5 & 3.0L)	✓ ✓

REF	OEM	2T STROKES	4T STROKES
REC26-89238A2	26-89238A2	105 / 140 Jet 150 / 1475 ProXS V-115 - V-220 (EFI / DFI) XR-4 / XR-6	✓

REF	OEM	2T STROKES	4T STROKES
REC69J-W0001-20-00		225 EFI	✓

REF	OEM	2T STROKES	4T STROKES
REC8M0057716	8M0057716	135, 150	✓

new

REF	OEM	2T STROKES	4T STROKES
REC26-8M0142979	26-8M0142979	V6 (3.4 L) V8 (4.6L) New Models	✓

new

REF	OEM	2T STROKES	4T STROKES
REC26-816575A5	26-816575A5	200 - 250 HP (DFI / EFI) (3.0L) Race Outboard (3.0L EFI)	✓ ✓

REF	OEM	2T STROKES	4T STROKES
REC8M0065064	8M0065064	VERADO 6 cyl (5.44 torpedo)	✓

new

MERCURY

RECAMBIOS MARINOS

GUÍA KITS RETENES			GEARCASE SEAL KITS APPLICATION			GUIDA KIT TENUTE PIEDE			GUIDE DES KITS JOINTS		
	USA	BEL	REF		USA	BEL	REF		USA	BEL	REF
4 (1 cyl.)	5595532 - 0A809600	9258281 - 9477829	REC26-77066A1	60 (3 cyl.)	OD000750 +	9683055	REC26-814669A2	(No Big Foot)			
4.5 (1 cyl.)	4107220	9072179	REC26-77066A1	60 (3 cyl.) (Big Foot)	OD000750 +	9683055	REC26-43035A4				
6	0A197112 +	9461526	REC26-41365A3	70 (3 cyl.)	4571652 - 0A996141	9135825 - 9385910	REC26-79831A1				
7.5 (7.5, 75)	4851693	9181726	REC26-77066A1	70 (3 cyl.)	0A996142 +	9483121	REC26-43035A4				
8	0A197112 +	9461526	REC26-41365A3	75 (3 cyl.)	0C222000 +	9589039	REC26-43035A4				
8 Bodense	0H00058 - 0H017349		REC26-41365A3	75 (4 cyl.)	6432901	9393856	REC26-55682A1				
4 T/ Strokes	0G760300 +			80 (80, 800) (4 cyl.)	4831999 - 6432900	9177626 - 9393855	REC26-55682A1				
9.8 (9.8, 110)	4839254	9165303	REC26-77066A1	80 (3 cyl.)	0A996142 +	9483121	REC26-43035A4				
9.9	0A197112 +	9461526	REC26-41365A3	90 (90, 900) (6 cyl.)	4845301		REC26-55682A1				
9.9 4 T/ Strokes	0H00058 - 0H017349		REC26-41365A3	90 (3 cyl.)	0A996142 +	9483121	REC26-43035A4				
10 (XR10/SEA PRO 10)	OD038000 +	9596000	REC26-41365A3	100 (4 cyl.)	0B209468 +	9523034	REC26-43035A4				
10 Magnum / Marathon	OD038000 +	9596000	REC26-41365A3	115 (115, 1150) (6 cyl.)	4855153		REC26-55682A1				
15 (15, 15 Sea Pro / Marathon)	0B292414 +	9927000	REC26-41365A3	115 (4 cyl.)	0C100000 +	9559771	REC26-43035A4				
15 XD Sea Pro / Marathon		9927000	REC26-85090A2	125 (4 cyl.)	0D283222 +	9793577	REC26-43035A4				
15 (Super 15)	0B238464 +	9507381	REC26-85090A2	140 (140, 1400) (6 cyl.)	4865678		REC26-55682A1				
18	5837437 - 6443972	9308306 - 9415100	REC26-85090A1	V-135	0A904646 - 0C239552		REC26-89238A2				
18 (18XD)	6443973	9378151	REC26-85090A2	V-135	0C239553 +		REC26-89238A2				
20 (20, 200)	4709593 - 6443972	9157230 - 9415100	REC26-66303A1	V-135 DFI	0G590000 +		REC26-89238A2				
20 (20, 20XD)	6443973	9415101	REC26-85090A2	V-150 (150, 1500)	4868998 - 0A904645		REC26-55682A1				
25	5705532 - 6443972	9315316 - 9415100	REC26-85090A1	V-150 (CARB)	0A904646 +		REC26-89238A2				
25 (25, 25XD)	6416713	9378116	REC26-85090A2	V-150 (XR4/MAGNUM II)	0B242885 - 0C239552		REC26-89238A2				
25 LIGHTNING (3 cyl.)	0E268781 +		REC26-85090A2	V-150 (XR4)	0C239553 - 0D081999		REC26-89238A2				
25 4 T/ Strokes	0G590000 +		REC823547A2	V-150 (XR6/MAGNUM III)	0D082000 +		REC26-89238A2				
30 (2 cyl.) (644cc)	0G053314 +		REC823547A2	V-150 EFI	0D082000 +		REC26-89238A2				
35 (2 cyl.)	6445653	9384476	REC26-79831A1	V-150 DFI	0G590000 +		REC26-89238A2				
40 (40, 402) (2 cyl.)	4860103 - 0G053313	9184451	REC26-79831A1	V-175 (175, 1750)	4301235 - 6618750		REC26-55682A1				
40 (2 cyl.) (644cc)	0G053314 +		REC823547A2	V-175 (CARB, EFI)	6618751		REC26-89238A2				
40 (4 cyl.)	0C159200 +	9570790	REC26-79831A1	V-200 (200, 2000)	4839034 - 6625220		REC26-55682A1				
40 (3 cyl.)	0G531301 +	9973100	REC823547A2	V-200 (CARB, EFI)	6625221 - 6203990		REC26-89238A2				
40 4 T/ Strokes (No Big Foot)	0G231123 +		REC823547A2	V-200 DFI (3.0L)	0G386496 +		REC26-816575A5				
45 (4 cyl.)	5531630	9248006	REC26-79831A1	V-220	0B117316 +		REC26-89238A2				
45 BODENSEE (No Big Foot)	0G231123 +		REC823547A2	V-225	5628028		REC26-55682A1				
4 T/ Strokes				V-225 (3.0L) (C-2)	0D280813 +		REC26-816575A5				
50 (500) (4 cyl.)	4357640	9107214	REC26-79831A1	V-225 (3.0L) (C-3)	0D280813 +		REC26-816575A4				
50 (3 cyl.)	6428681 - 0D000749	9385911 - 9683054	REC26-79831A1	(Sea Pro, Marathon)	0G245605 +		REC26-816575A5				
50 (3 cyl.)	OD000750 - 0G589999	9683055 - 9973099	REC26-814669A2	(C-2)							
50 (3 cyl.)	0G590000 +	9973100	REC823547A2	V-225 (3.0L)	0G245605 +		REC26-816575A4				
50 (No Big Foot) 4 T/ Strokes	0G231123 +		REC823547A2	(C-3)							
50 (Big Foot) 4 T/ Strokes	0G231123 +		REC26-43035A4	V-225 EFI (3.0L)	0G129222 +		REC26-816575A5				
55 (3 cyl.)	OD000750 +	9683055	REC26-814669A2	V-225 DFI (3.0L)	0G590000 +		REC26-816575A5				
60 (3 cyl.)	6428681 - 0D000749	9385911 - 9683054	REC26-79831A1	V-250 EFI (3.0L)	0G129222 +		REC26-816575A5				

GUÍA RETENES		GEARCASE SEAL APPLICATION		GUIDA TENUTE PIEDE		GUIDE DES JOINTS	
		1	2	3	4	5	6
3.5,3.6	5404657			REC26-897153		REC26-30913	
3.9	1655013 - 2498135					REC26-30913	
4	2498136 - 5569201					REC26-30913	
4	5569202 - 5595531			REC26-897153		REC26-30913	
4,4.5	5595532 - A809601			REC26-897153		REC26-30913	
6	1408611 - 2529894					REC26-30913	
7.5	2529895 - 3801457					REC26-30913	
7.5	3801458 - 5206549					REC26-30913	
7.5	5206550			REC26-897153		REC26-30913	
9.8	1470349 - 3795657					REC26-30913	
9.8	3795658 - 5206549					REC26-30913	
9.8	5206550			REC26-897153		REC26-30913	
18	5837437 - 6443972			REC26-33467	REC26-33467		
20	1558310 - 1866494			REC26-33467		REC908855	
20	1866495 - 6443972			REC908855	REC26-33467	REC908855	
25	5705532 - 6443972			REC26-33467	REC26-33467		
30	1271885 - 1356947	REC26-90562		REC26-90562			REC26-8164641
30	G055314 +	REC26-69188	REC26-69189				
MK35A	1217222 - 1271884	REC26-90562	REC26-90562				REC26-8164641
35	1356948 - 1448139	REC26-90562		REC26-90562			REC26-8164641
35	1571114 - 1960826	REC26-90562		REC26-90562			REC26-8164641
35	1960827 - 2874703	REC26-90562		REC26-90562	REC26-79831		REC26-8164641
35	6445653	REC26-69188		REC26-90562	REC26-79831		REC26-8164641
40	1279685 - 2874703	REC26-90562		REC26-90562			REC26-8164641
40	2874704 - 3336257	REC26-56788		REC26-90562	REC26-79831		REC26-8164641
40	3338258 - 4117709	REC26-56788		REC26-90562	REC26-79831		REC26-24590
40	4117710 - 4860102	REC26-69188	REC26-69189	REC26-90562	REC26-79831		REC26-8164641/ REC26-24590
40	4880103 - 6445652	REC26-69188	REC26-69189	REC26-90562	REC26-79831		REC26-8164641
40 (4 Cyl)	C159200 - G053313	REC26-69188	REC26-69189	REC26-90562	REC26-79831		REC26-8164641

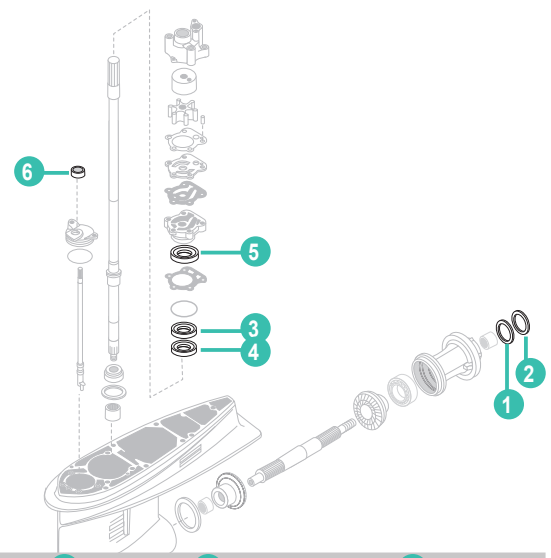

		1	2	3	4	5	6
40 (2 Cyl)	G055314 +	REC26-69188	REC26-69189				
45	1476510 - 1531568	REC26-90562		REC26-90562			REC26-8164641
45 (4 Cyl)	5531630	REC26-69188	REC26-69189	REC26-90562	REC26-79831		REC26-8164641
50	1421113 - 1639472	REC26-90562		REC26-90562			REC26-8164641
50	1639473 - 1770178	REC26-90562		REC26-90562			REC26-8164641
50	1770179 - 2305100	REC26-90562		REC26-90562	REC26-79831		REC26-8164641
50	2305101 - 2858813	REC26-90562		REC26-90562	REC26-79831		REC26-24590
50	2858814 - 4140999	REC26-56788		REC26-90562	REC26-79831		REC26-8164641/ REC26-24590
50	4141000 - 4962055	REC26-69188	REC26-69189	REC26-90562	REC26-79831		REC26-8164641/ REC26-24590
50	4962056 - 5531630	REC26-69188	REC26-69189	REC26-90562	REC26-79831		REC26-8164641
50 (3 Cyl)	6428681 - D000750	REC26-69188	REC26-69189	REC26-90562	REC26-79831		REC26-8164641
50-60 (3 C)	D00075 +	REC26-69188	REC26-69189			REC26-8164641	
60	1303411 - 1542744			REC26-90562			
60	6428681 - D000750	REC26-69188	REC26-69189	REC26-90562	REC26-79831		REC26-8164641
65	1542745 - 2874263	REC26-76868	REC26-76868	REC26-94038		REC26-16977	REC26-8164641
65	2874263 - 3293183	REC26-76868		REC26-94038	REC26-55682	REC26-16977	REC26-8164641/ REC26-24590
65 (3 Cyl)	3293164 - 4138684	REC26-56788		REC26-90562	REC26-79831		REC26-8164641/ REC26-24590
65 (3 Cyl)	4136685 - 4571651	REC26-69188	REC26-69189	REC26-90562	REC26-79831		REC26-8164641/ REC26-24590
70	1296411 - 1413610	REC26-90562					
70	1413811 - 1566239	REC26-76868	REC26-76868	REC26-94038		REC26-16977	REC26-8164641
70 (3 Cyl)	4571652 - 4977156	REC26-69188	REC26-69189	REC26-90562	REC26-79831		REC26-8164641/ REC26-24590
70 (3 Cyl)	4977157 - 5579016	REC26-69188	REC26-76127	REC26-90562	REC26-79831		REC26-8164641
70 (3 Cyl)	5679017 - A996142	REC26-69188		REC26-90562	REC26-79831		REC26-8164641
70,75 (3 C)	A996142 +	REC26-76868	REC26-70081		REC26-43036		
75 (4 Cyl)	6432901 - A996142	REC26-76868	REC26-70081	REC26-16977	REC26-94038		REC26-8164641
80	1335465 - 1398629	REC26-76868	REC26-76868	REC26-94038		REC26-16977	REC26-8164641
80	1398630 - 1566239	REC26-76868	REC26-76868	REC26-94038		REC26-16977	REC26-8164641
80 (4 Cyl)	2559001 - 3144218	REC26-76868	REC26-76868	REC26-16977	REC26-94038	REC26-16977	REC26-8164641/ REC26-24590
80 (4 Cyl)	3144219 - 4831998	REC26-76868	REC26-76868	REC26-55682	REC26-94038	REC26-16977	REC26-8164641/ REC26-24590
80 (4 Cyl)	4831999 - 5582561	REC26-76868	REC26-76868	REC26-16977	REC26-94038		REC26-8164641
80 (4 Cyl)	5582562 - A996142	REC26-76868	REC26-70081	REC26-16977	REC26-94038		REC26-8164641
80 (3 Cyl)	A996142 +	REC26-76868	REC26-70081		REC26-43036		
85	1460999 - 1766823	REC26-76868	REC26-76868	REC26-94038		REC26-16977	REC26-8164641
85 (4 Cyl)	3493913 - 4590511	REC26-76868	REC26-76868	REC26-55682	REC26-94038		REC26-8164641/ REC26-24590
85 (4 Cyl)	4590512 - 4831998	REC26-76868	REC26-76868	REC26-16977	REC26-94038		REC26-8164641/ REC26-24590
90	1766824 - 1869775	REC26-76868	REC26-76868	REC26-16977	REC26-94038	REC26-16977	REC26-8164641
90	4845301 - 5594856	REC26-76868	REC26-76868	REC26-16977	REC26-94038		REC26-8164641
90	5594657 - A996142	REC26-76868	REC26-70081	REC26-16977	REC26-94038		REC26-8164641
90 (3 Cyl)	A996142 +	REC26-76868	REC26-70081		REC26-43036		
95	1869776 - 2318585	REC26-76868	REC26-76868	REC26-16977	REC26-94038	REC26-16977	REC26-8164641/ REC26-24590
100, 100SS	1464949 - 2836018	REC26-76868	REC26-76868	REC26-16977	REC26-94038	REC26-16977	REC26-8164641
100BP	2399698 - 2641854	REC26-76868	REC26-76868	REC26-16977	REC26-94038	REC26-16977	REC26-8164641/ REC26-24590
100 (4 Cyl)	B209468 +	REC26-76868	REC26-70081		REC26-43036		
110	1870204 - 2314955	REC26-76868	REC26-76868	REC26-16977	REC26-94038	REC26-16977	REC26-8164641/ REC26-24590
115	2836019 - 3525440	REC26-76868	REC26-76868	REC26-16977	REC26-94038	REC26-16977	REC26-8164641/ REC26-24590
115	3525440 - 4122634	REC26-76868	REC26-76868	REC26-16977		REC26-8164641	REC26-90562/ REC26-24590
115	4122635 - 4855152	REC26-76868	REC26-76868	REC26-16977	REC26-94038		REC26-8164641/ REC26-24590
115	4855153 - 5600966	REC26-76868	REC26-76868	REC26-16977	REC26-94038		REC26-8164641
115	5600967 - C100000	REC26-76868	REC26-70081	REC26-16977	REC26-94038		REC26-8164641
115 (4 Cyl)	C100000 +	REC26-76868	REC26-70081		REC26-43036		
125	2314956 - 2839368	REC26-76868	REC26-76868	REC26-16977	REC26-94038	REC26-16977	REC26-8164641
135	2839369 - 3293233	REC26-76868	REC26-76868	REC26-16977	REC26-94038	REC26-16977	REC26-8164641
140	3293234 - 3502805	REC26-76868	REC26-76868	REC26-16977	REC26-94038	REC26-16977	REC26-8164641/ REC26-24590
140	4865678	REC26-76868	REC26-76868	REC26-16977	REC26-94038		REC26-8164641
150	3502806 - 4121434	REC26-76868	REC26-76868	REC26-16977	REC26-94038		REC26-8164641/ REC26-24590
150	4121434 - 5327662	REC26-76868	REC26-76868	REC26-16977	REC26-94038		REC26-8164641/ REC26-24590
150/150XR2	4868998 - 5432021	REC26-76868	REC26-76868	REC26-16977	REC26-89238		REC26-8164641
150/150XRS	5432021 - A904646	REC26-76868	REC26-76868	REC26-16977	REC26-89238		REC26-8164641
150/150XR2	A904646 +	REC26-76868	REC26-76868	REC26-16977	REC26-89238		REC26-8164641
175	4301235 - 6618750	REC26-76868	REC26-76868	REC26-16977	REC26-89238		REC26-8164641
175	6618751	REC26-76868	REC26-76868	REC26-16977	REC26-89238		REC26-8164641
200	4839034 - 6073191	REC26-76868	REC26-76868	REC26-16977	REC26-89238		REC26-8164641
200	6073192	REC26-76868	REC26-76868	REC26-16977	REC26-89238		REC26-8164641
220	B117316 +	REC26-76868	REC26-76868	REC26-16977	REC26-89238		REC26-8164641
225	5628028 - D280813	REC26-76868	REC26-76868	REC26-16977	REC26-89238		REC26-8164641
250/275	C101891 +	REC26-76868	REC26-76868	REC26-16977	REC26-89238		REC26-8164641
3.4L	5611648	REC26-76868	REC26-76868	REC26-16977	REC26-89238		REC26-8164641

BOMBA DE AGUA

WATER PUMP

POMPA ACQUA

POMPE À EAU

BASES BOMBA DE AGUA

WATER PUMP BASE ASSEMBLY

BASE, POMPA ACQUA

BASE DE POMPE À EAU

REF	OEM	STROKES	2T	4T
REC46-70941T01	46-70941A1	3.9 - 9.8 HP	✓	



REF	OEM	STROKES	2T	4T
REC8M0057748	8M0057748 8M0050522	75 - 150 HP EFI		✓



new

REF	OEM	STROKES	2T	4T
REC8M0134493	8M0134493	9.9, 10, 15, 20 EFI		✓



new

REF	OEM	STROKES	2T	4T
REC46-8M0077147	46-42579A3	105- 1470 Jet / 150-175 ProXS V-135 - V-220 (DFI/EFI) (2.5L) XR-4 / XR-6		



REF	OEM	STROKES	2T	4T
REC46-821307A2	46-821307A2	25 - 50 HP	✓	✓



REF	OEM	STROKES	2T	4T
REC8M0007131	888909A1	135 - 300 HP Verado 200 - 250 HP		✓



REF	OEM	STROKES	2T	4T
REC46-77177A1	46-77177A1	30 Jet 35 - 70 HP		

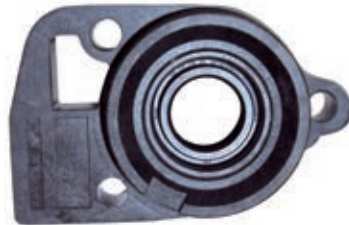

REF	OEM	STROKES	2T	4T
REC46-96146A6	46-96146A6	V-150 - V-225 (Work /XR-2 / Marathon) 2.4L (EFI) Race Outboard		✓



REF	OEM	STROKES	2T	4T
REC46-812966A7	46-812966A7	30 - 60 HP	✓	✓





REF	OEM	STROKES	2T	4T
REC8M0046297	8M0046297	175 - 400 HP VERADO V6 Et V8		✓



new

REF	OEM		2T STROKES	4T STROKES
REC807929A1	807929A1		200 - 300 HP (DFI / EFI / Carb) (3.0L)	✓



REF	OEM		2T STROKES	4T STROKES
REC46-73640A1	46-73640A1		402 500, 50, 70, 650 (3 Cyl)	✓



KIT BASES BOMBA DE AGUA

KIT WATER PUMP BASE ASSEMBLY

KIT BASE, POMPA ACQUA

KIT BASE DE POMPE À EAU

REF	OEM		2T STROKES	4T STROKES
REC39580			35 - 60 HP	✓



CUERPO BOMBA DE AGUA

HOUSING, WATER PUMP

CORPO, POMPA ACQUA

CORPS DE POMPE À EAU

REF	OEM		2T STROKES	4T STROKES
PAF6-03000001	46-16156		4, 5, 6 HP JPN OR000001+ BEL OP073456+	✓

new



REF	OEM		2T STROKES	4T STROKES
REC46-99157A02	46-99157A02		8, 9.9, 13.5, 15 18, 20, 25	✓



REF	OEM		2T STROKES	4T STROKES
REC93224A1	46-93224A1		4, 4.5, 39, 40 (1 cyl) 7.5, 9.8 HP	



REF	OEM		2T STROKES	4T STROKES
REC8M0134492	8M0134492		9.9, 10, 15, 20 EFI	✓

new



REF	OEM		2T STROKES	4T STROKES
REC46-42089A2	46-42089A2		6 - 15 HP	





REF	OEM		2T STROKES	4T STROKES
REC46-77822A1	46-77822A1		30 Jet 35, 40, 402 (2 cyl) 50, 60, 70 (3 cyl) 45, 50, 500 (4 cyl)	



REF	OEM		2T STROKES	4T STROKES
PAF8-04000009	803752A02		8 Et 9.9 (209 cc)	✓



REF	OEM		2T STROKES	4T STROKES
REC14334A3	14334A3		30 - 60 HP Formula 60	✓



REF	OEM		2T STROKES	4T STROKES
REC817275A2	817275A2	40 - 250 HP 3.0L EFI / SeaPro	✓	✓



REF	OEM		2T STROKES	4T STROKES
REC61A-44311-00	888686T	225 EFI (0T653945+)		✓



new

REF	OEM		2T STROKES	4T STROKES
REC46-96148T1	46-96148T1	110 - 140 Jet V-115 - V-200 XR-6		



P 283

REF	OEM		2T STROKES	4T STROKES
REC817275A1 RM817275A1	817275A1	200 - 400 HP	✓	✓



TAPA BOMBA DE AGUA WATER PUMP PLATE PIASTRA POMPA ACQUA PLAQUE DE POMPE À EAU

REF	OEM		2T STROKES	4T STROKES
REC46895	46895	4, 4.5, 40, 45 HP (1 cyl) 7.5, 75, 60, /9.8 HP 110 HP	✓	



REF	OEM		2T STROKES	4T STROKES
REC803753	80375	8 - 20 HP	✓	✓



new

REF	OEM		2T STROKES	4T STROKES
REC16159	16159	4, 5 HP 4, 5, 6 HP	✓	✓



REF	OEM		2T STROKES	4T STROKES
REC85083	85083	8 - 25 HP	✓	✓



REF	OEM		2T STROKES	4T STROKES
PAF8-04000007	8037531	6, 8, 9.8 HP 6, 8, 9.8 HP (209 cc)	✓	✓



REF	OEM		2T STROKES	4T STROKES
REC8M0135805	8M0135805	9.9, 10, 15, 20 EFI		✓



new

REF	OEM		2T STROKES	4T STROKES
REC42200	42200	6, 15 hp	✓	✓



REF	OEM		2T STROKES	4T STROKES
REC682-44323-40	84026M	9.9, 15 (682/684)	✓	

new





REF	OEM		2T STROKES	4T STROKES
REC663-44323-00	81420M	60 HP (2 cyl) E-675	✓	

new





REF	OEM		2T STROKES	4T STROKES
REC8213542	821354-2	25 - 50 HP	✓	✓





REF	OEM		2T STROKES	4T STROKES
REC8172761	817276-1	100 - 350 HP	✓	✓



REF	OEM		2T STROKES	4T STROKES
REC19700A2	19700A2	30 - 60 HP	✓	✓



REF	OEM		2T STROKES	4T STROKES
REC324351	32435	110 - 140 Jet 150 - 175 ProXs(2.5L) V-135 - V-200 HP XR-6	✓	



REF	OEM		2T STROKES	4T STROKES
REC32768	54705	350 / 500 400 (2 Cyl) 450 (4 Cyl)	✓	



CASQUILLO SLINGER BOCCOLA INSERT

REF	OEM
REC48752T	48752
REC48753	48753
REC70977T	70977
REC16157	16157



REC48752T



REC48753



REC70977T



REC16157

REF	OEM
REC48752T	48752
REC48753	48753
REC70977T	70977
REC16157	16157
REC25-20273	25-20273
REC25-86203	25-86203
REC25-30271	25-30271



REC25-20273





REC25-86203



REC25-30271

REF	OEM		2T STROKES	4T STROKES
PAF8-04000010	8037511	6, 8, 9.8 HP 8 Et 9.9 (209 cc)	✓	✓



REF	OEM		2T STROKES	4T STROKES
REC682-44322-00	84025M	9.9, 15C (682/688)	✓	

new



REF	OEM		2T STROKES	4T STROKES
REC663-44322-00	81419M	60 HP (2 cyl) (E9675)	✓	

new



JUNTAS BOMBA WATER PUMP GASKETS GUARNIZIONI POMPA JOINTS DE POMPE

REF	OEM	2T STROKES	4T STROKES
PAF8-0400006	161586	6, 8, 9,8 HP	✓
		8, 9,9 HP	✓



REF	OEM	2T STROKES	4T STROKES
PAF8-0400005	161587	6, 8, 9,8 HP	✓
		8, 9,9 HP	✓

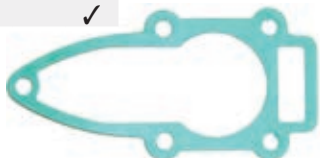

REF	OEM	2T STROKES	4T STROKES
REC27-1920201	27-19202	6, 15 hp (1999-06)	✓



REF	OEM	2T STROKES	4T STROKES
REC27-192043	27-19202	6 - 25 HP (1986-05)	✓



REF	OEM	2T STROKES	4T STROKES
REC27-8M0075040	27-8M0075040	9.9, 15, 18 (Inter.)	✓
		8, 9.9, 10, 15, 20 hp	✓

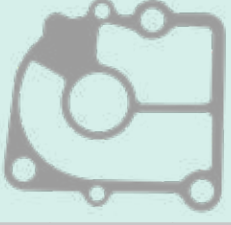

REF	OEM	2T STROKES	4T STROKES
REC27-8M0135804	27-8M0135804	9.9, 10, 15, 20 EFI	✓



REF	OEM	2T STROKES	4T STROKES
REC27-8M0135806	27-8M0135806	9.9, 10, 15, 20 EFI	✓



REF	OEM	2T STROKES	4T STROKES
REC27-85087	27-85087	18, 25 HP	✓

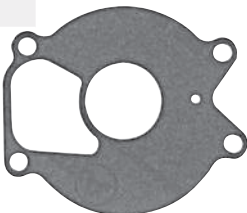

REF	OEM	2T STROKES	4T STROKES
REC27-993261	27-99326-1	200, 18, 20, 25 HP	✓



REF	OEM	2T STROKES	4T STROKES
REC27-39626	27-39626	20, 200 HP	✓

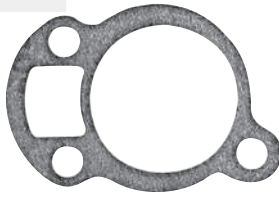

REF	OEM	2T STROKES	4T STROKES
REC27-396231	27-39623	20, 200 HP	✓





REF	OEM	2T STROKES	4T STROKES
REC27-39625	27-39625	20, 200 HP	✓



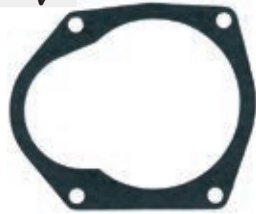

REF	OEM		2T STROKES	4T STROKES
REC27-822189	27-822189	25 - 50 HP	✓	✓





REF	OEM		2T STROKES	4T STROKES
REC27-19552	19552	30 Jet 35 40, 45 (4cyl)	✓	





REF	OEM		2T STROKES	4T STROKES
REC27-822217	27-822217	25 - 50 HP	✓	✓



REF	OEM		2T STROKES	4T STROKES
REC27-8172771	27-43034-1	40-125 HP	✓	✓



REF	OEM		2T STROKES	4T STROKES
REC27-19553	27-19553	30 - 45 HP (1987-97)	✓	



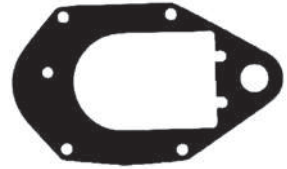

REF	OEM		2T STROKES	4T STROKES
REC27-8M4502052	27-8M4502052	40 - 60 HP 50 - 60 HP	✓	✓

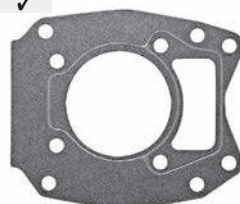

REF	OEM		2T STROKES	4T STROKES
REC27-430472	27-43047-2	30-125 HP	✓	✓



REF	OEM		2T STROKES	4T STROKES
REC27-8M0142616	8M0142616 27-8M0050720	40 - 400 HP	✓	✓





new

REF	OEM		2T STROKES	4T STROKES
REC27-430331	27-43033-1	30 HP +	✓	✓



REF	OEM		2T STROKES	4T STROKES
REC27-32438	27-32438	65-150 HP (1970-85)	✓	



REF	OEM		2T STROKES	4T STROKES
REC27-19551	27-19551	30-60 HP (1987-97)	✓	



REF	OEM		2T STROKES	4T STROKES
REC27-426311	27-42631-1	105, 140 JET 175 PROXS (2.5 L) V-115 DFI (2.5L) V-135, V-140, V-150, V-175, V-200 XR-4, XR-6		✓

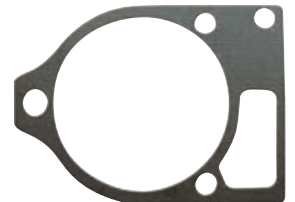

REF	OEM		2T STROKES	4T STROKES
REC27-856081	27-85608-1	V-115 - V-200		



REF	OEM		2T STROKES	4T STROKES
REC27-32771	27-32771	440 - 350 (1970-79)	✓	



REF	OEM		2T STROKES	4T STROKES
REC27-858524	27-858524	V-115 - V-200	✓	



REF	OEM		2T STROKES	4T STROKES
REC27-856704	27-85610-1	RM/MR (1983-90)	✓	



KITS DE REPARACIÓN BOMBA DE AGUA WATER PUMP SERVICE KITS

KIT RICAMBI POMPA ACQUA KIT REPARATION DE POMPE A EAU

REF	OEM		2T STROKES	4T STROKES
REC47-89980T1	47-89980T1	Int. Ø 0.438	✓	



REF	OEM		2T STROKES	4T STROKES
REC46-42040T5	46-42040A5	6 - 15 HP	✓	✓



REF	OEM		2T STROKES	4T STROKES
REC6A1-W0078-01	814453M	MARINER 2B (6A1-000101+)	✓	



REF	OEM		2T STROKES	4T STROKES
REC46-42089A5	46-42089A5	6 - 15 HP	✓	✓



REF	OEM		2T STROKES	4T STROKES
REC46-70941A3	46-70941A3	(1975-85) 4, 4.5, 7.5, 9.8 HP	✓	



REF	OEM		2T STROKES	4T STROKES
REC6G1-W0078-A1	11656T 11656M	MARINER 6C, 8C (6H8, 6G1)	✓	

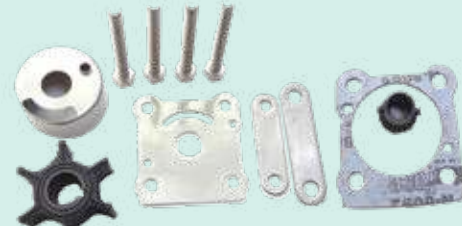

REF	OEM		2T STROKES	4T STROKES
REC47-89981Q1	47-89981T2	4 - 9.8 HP Int. Ø 0.456	✓	



REF	OEM		2T STROKES	4T STROKES
REC47-42038Q3	47-42038T4	8 - 15 HP	✓	



REF	OEM	2T STROKES	4T STROKES
REC46-99157T2	46-99157T2	(1984+) 15XD, 18XD, 20XD, 25XD, 25 HP (3 cyl) 8- 25 HP	✓

REF	OEM	2T STROKES	4T STROKES
REC853792T01	853792T01 853792A1	20, 25, 30 HP 2cyl INTER. (BEL ON001875+)	✓

REF	OEM	2T STROKES	4T STROKES
REC47-803748K01	47-803748K01 47-803748Q01	8, 9.9HP (209cc) USA OR042475+ BEL OP325500+ (2005+) STANDARD GEARCASE	✓

REF	OEM	2T STROKES	4T STROKES
REC689-W0078-A6	42431M	MARINER 20C (6A9) 25C (695) 30A (689)	✓

REF	OEM	2T STROKES	4T STROKES
REC98-8M0135821	98-8M0135821	9.9 EFI (1R00814+) 10, 15, 20 EFI (OR833820+)	✓

REF	OEM	2T STROKES	4T STROKES
REC689-W0078-A6	95661T	MARINER 20C (6A9) (010112+) 25C (695) (023896+) 30A (689) (022059+)	✓

REF	OEM	2T STROKES	4T STROKES
REC682-W0078-A1	46-84277T 46-84277M	MARINER 9.9 (682) 15C (684)	✓

REF	OEM	2T STROKES	4T STROKES
REC47-89982T1	47-89982T1	20 HP	✓

REF	OEM	2T STROKES	4T STROKES
REC47-85089Q4	47-85089T7	15 - 25 HP	✓

REF	OEM	2T STROKES	4T STROKES
REC821354A2	821354A2	25 - 50 HP	✓

new

REF	OEM	2T STROKES	4T STROKES
REC821354A04	821354A04	25 HP (2.4:1 gear ratio) 30, 40 HP (3 cyl) (2:1 gear ratio)	✓

REF	OEM	2T STROKES	4T STROKES
REC46-60366T1	46-60366T1 46-60366Q1	30, 40, 50, 60 HP (-1976)	✓

REF	OEM	2T STROKES	4T STROKES
REC46-77177A3	46-77177A3	30 - 70 HP	✓

new

REF	OEM	2T STROKES	4T STROKES
RECMC00004	8M0100526	40 - 350 HP	✓

REF	OEM	2T STROKES	4T STROKES
REC46-812966A12	46-812966A11 46-812966A12	30 - 60 HP	✓

REF	OEM	2T STROKES	4T STROKES
REC46-812966A12	46-812966A12	(1991+) 40, 50, 60 EFI HP 30 - 60 HP Formula 60	✓

REF	OEM	2T STROKES	4T STROKES
REC43055A4	43055A4	30 - 125 HP	✓

REF	OEM	2T STROKES	4T STROKES
REC12094	46-43024A7 46-8M0113799	40 - 125 HP	✓

REF	OEM	2T STROKES	4T STROKES
REC47-43026Q06	47-43026T11, T8	30 - 350HP	✓

new

REF	OEM	2T STROKES	4T STROKES
REC679-W0078-A1	84363T	MARINER 40B (676) B000106+ 40C (6E9) 000106+	✓

REF	OEM	2T STROKES	4T STROKES
REC47-89983Q1	47-89983T2	35 - 70 HP	✓

REF	OEM	2T STROKES	4T STROKES
REC47-19453QZ	47-19453Q2	40 - 60 HP	✓ ✓

REF	OEM	2T STROKES	4T STROKES
REC46-73640A2	46-73640A2	70 HP (3 cyl) 500/50 HP (4 cyl)	✓

REF	OEM	2T STROKES	4T STROKES
REC663-W0078-01	84188T	MARINER 55 (663) 60 (675, 6F0)	✓

REF	OEM	2T STROKES	4T STROKES
REC46-96148A8	46-96148A8	75 - 200 HP XR-6 (V-Models)	✓

REF	OEM	2T STROKES	4T STROKES
REC46-8M0061040	46-8M0061040	65 - 150 HP	✓

REF	OEM	2T STROKES	4T STROKES
REC817275A08	817275A08	135 - 300 (4, 6 cyl) 3.0L DF/EFI	✓

REF	OEM	2T STROKES	4T STROKES
REC47-89984Q5	47-89984T6	65 HP (4 cyl) V6	✓

PALETA CORTA
SHORT VANE
PALE CORTO
PALES COURTES

REF	OEM	2T STROKES	4T STROKES
REC817275A09	817275A09	(2005+) 135, 150, 175, 200, 225, 250, 275, 300 HP Verado 200, 225, 250, 300 (DFI) (3.0L)	✓ ✓

new

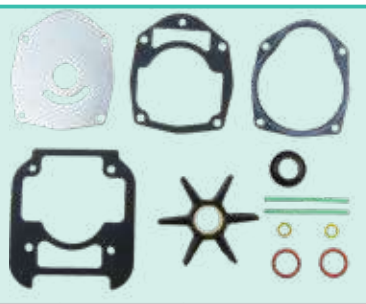

REF	OEM	2T STROKES	4T STROKES
REC47-8M0142980	47-8M0142980	175, 200, 225 HP 3.4L (V6) 225, 250, 300, 450 HP 4.6L (V8)	✓

REF	OEM	2T STROKES	4T STROKES
REC817275A6	817275A6	200 DFI 225 (3.0L Carb) EFI (SeaPro) 250 (3.0L EFI)	✓



REF	OEM	2T STROKES	4T STROKES
REC46-96148A8	46-60367A1 46-96148A8	V-115 - V-200 (2.5L) (EFI/DFI)	✓



new



REF	OEM	2T STROKES	4T STROKES
REC817275Q05	817275A5	3.0L DFI/EFI 200, 225, 25, 300 HP (3.0L) 300 HP (3.2L)	✓

new

REF	OEM	2T STROKES	4T STROKES
REC8M0065072	8M0065072	200 - 400 HP VERADO (5.44 torpedo) (6 cyl)	✓



new

REF	OEM	2T STROKES	4T STROKES
REC6G5-W0078-A1	888687A1	225 EFI OT653945+	✓













GUÍA BOMBA Y RETENES		GUIDE, WATER PUMP AND SEALS		GUIDA POMPA E TENUTE		GUIDE DES KITS POMPE ET JOINTS	
🔧	CYL	KIT BOMBA PUMP SET KIT POMPA KIT POMPE		KIT RETÉN COLA DRIVE SEAL SET KIT TENUTA PIEDE KIT JOINT EMBASE		RETÉN HÉLICE PROPELLER SEAL PARAOILIO ELICA JOINT SPI D'HELICE	
10 EFI, 15 EFI, 15EFI SEAPRO		OR832820 +	2	REC98-8M0135821		REC26-161622	
20EFI		OR106966 +	3	REC853792T01		REC26-161301	
25 EFI		OP153500 -OP400999	3	REC821354A04		REC26-69188	
30 EFI		OR106999 +	3	REC853792T01		REC26-69189	
30 EFI		OT409000 - 1B226999	3	REC821354A04		REC26-161301	
30 EFI		1C109093 - 1C456299	3	REC46-812966A12	REC26-814669A2	REC26-69188	
30 EFI		1C456300 +	3	REC46-812966A12	REC26-814669A2	REC26-69189	
40 EFI		OP153500 -OP400999	BEL 3	REC821354A04		REC26-69188	
40 EFI		OP401000 - OP515896	BEL 3	REC821354A04 REC46-812966A12	REC26-814669A2	REC26-69189	
40 EFI		OP409000 - 1B226999	USA 3	REC821354A04		REC26-69188	
40 EFI		1B227000 - 1B355027	USA 3	REC821354A04 REC46-812966A12	REC26-814669A2	REC26-69189	
40 EFI		1C000001 - 1C043416	3	REC821354A04 REC46-812966A12	REC26-814669A2	REC26-69188	
40 EFI		1C043417 - 1C456299	3	REC46-812966A12	REC26-814669A2	REC26-69189	
40 EFI		1C456300 +	3	REC46-812966A12	REC26-814669A2	REC26-69188	
						REC26-69189	





			CYL	KIT BOMBA PUMP SET KIT POMPA KIT POMPE	KIT RETÉN COLA DRIVE SEAL SET KIT TENUTA PIEDE KIT JOINT EMBASE	RETÉN HÉLICE PROPELLER SEAL PARAOLIO ELICA JOINT SPI D'HELICE
40 EFI	OP153500 - OP400999	BEL	4	REC46-812966A12 REC47-43026Q06	REC26-814669A2 REC26-43035A4	REC26-69188 REC26-69189 REC26-70080 REC26-70081
40 EFI	OP401000 - OP515896	BEL	4	REC46-812966A12 REC47-43026Q06	REC26-814669A2 REC26-43035A4	REC26-69188 REC26-69189 REC26-70080 REC26-70081
40EFI	OP515897 - OP580772	BEL	4	REC46-812966A12 REC47-43026Q06	REC26-814669A2 REC26-43035A4	REC26-69188 REC26-69189 REC26-70080 REC26-70081
40 EFI	OT409000 - 1B355222	USA	4	REC46-812966A12 REC47-43026Q06	REC26-814669A2 REC26-43035A4	REC26-69188 REC26-69189 REC26-70080 REC26-70081
40 EFI	1C000001 - 1C050251	USA	4	REC46-812966A12 REC47-43026Q06	REC26-814669A2 REC26-43035A4	REC26-69188 REC26-69189 REC26-70080 REC26-70081
40 EFI	1C050252 - 1C453839	USA	4	REC46-812966A12 REC47-43026Q06	REC26-814669A2 REC26-43035A4	REC26-69188 REC26-69189 REC26-70080 REC26-70081
40 EFI Et SEAPRO	1C453840 +	USA	4	REC46-812966A12 REC47-43026Q06	REC26-814669A2 REC26-43035A4	REC26-69188 REC26-70080 REC26-69189 REC26-70081
50 EFI	OP153500 - OP400999	BEL	4	REC46-812966A12 REC47-43026Q06	REC26-814669A2 REC26-43035A4	REC26-69188 REC26-69189 REC26-70080 REC26-70081
50 EFI	OP401000 - OP515896	BEL	4	REC46-812966A12 REC47-43026Q06	REC26-814669A2 REC26-43035A4	REC26-69188 REC26-69189 REC26-70080 REC26-70081
50 EFI	OP515897 - OP580772	BEL	4	REC46-812966A12 REC47-43026Q06	REC26-814669A2 REC26-43035A4	REC26-69188 REC26-69189 REC26-70080 REC26-70081
50 EFI	OT409000 - 1B355222	USA	4	REC46-812966A12 REC47-43026Q06	REC26-814669A2 REC26-43035A4	REC26-69188 REC26-69189 REC26-70080 REC26-70081
50 EFI	1C000001 - 1C050251	USA	4	REC46-812966A12 REC47-43026Q06	REC26-814669A2 REC26-43035A4	REC26-69188 REC26-69189 REC26-70080 REC26-70081
50 EFI	1C050252 - 1C453839	USA	4	REC46-812966A12 REC47-43026Q06	REC26-814669A2 REC26-43035A4	REC26-69188 REC26-69189 REC26-70080 REC26-70081
50 EFI	1C453840 +	USA	4	REC46-812966A12 REC47-43026Q06	REC26-814669A2 REC26-43035A4	REC26-69188 REC26-69189 REC26-70080 REC26-70081
60 EFI	OP153500 - OP400999	BEL	4	REC46-812966A12 REC47-43026Q06 REC12094	REC26-814669A2 REC26-43035A4	REC26-69188 REC26-69189 REC26-70080 REC26-70081
60 EFI	OP401000 - OP515896	BEL	4	REC46-812966A12 REC47-43026Q06 REC12094	REC26-814669A2 REC26-43035A4	REC26-69188 REC26-69189 REC26-70080 REC26-70081
60 EFI	OP515897 - OP580772	BEL	4	REC46-812966A12 REC47-43026Q06 REC12094	REC26-814669A2 REC26-43035A4	REC26-69188 REC26-69189 REC26-70080 REC26-70081
60 EFI	OT409000 - 1B355222	USA	4	REC46-812966A12 REC47-43026Q06	REC26-814669A2 REC26-43035A4	REC26-69188 REC26-69189 REC26-70080 REC26-70081
60 EFI	1C000001 - 1C050251	USA	4	REC46-812966A12 REC47-43026Q06	REC26-814669A2 REC26-43035A4	REC26-69188 REC26-69189 REC26-70080 REC26-70081
60 EFI	1C050252 - 1C453839	USA	4	REC46-812966A12 REC47-43026Q06	REC26-814669A2 REC26-43035A4	REC26-69188 REC26-69189 REC26-70080 REC26-70081
60 EFI Et SEAPRO	1C453840 +	USA	4	REC46-812966A12 REC47-43026Q06	REC26-814669A2 REC26-43035A4	REC26-69188 REC26-69189 REC26-70080 REC26-70081
75 EFI	1B172291 - 1B366822	USA	4	REC47-43026Q06	REC26-43035A4	REC26-70080 REC26-70081
75 EFI	1B366823 - 2B094995	USA	4	REC47-43026Q06	REC26-43035A4	REC26-70080 REC26-70081
75 EFI Et SEAPRO	2B095049 +		4	REC46-8M0061040	REC8M0088080 (RR) REC8M0088081 (CR)	REC26-12224 REC26-76868
80 EFI	OP459572 - 2B094995	BEL	4	REC47-43026Q06	REC26-43035A4	REC26-70080 REC26-70081
80 EFI	1B227000 - 1B366822	USA	4	REC47-43026Q06	REC26-43035A4	REC26-70080 REC26-70081
80 EFI	1B366823 - 2B094995	USA	4	REC47-43026Q06	REC26-43035A4	REC26-70080 REC26-70081
80 EFI	2B095049 +		4	REC46-8M0061040	REC8M0088080 (RR) REC8M0088081 (CR)	REC26-76868 REC26-12224
90 EFI	1B172291 - 1B366822	USA	4	REC47-43026Q06	REC26-43035A4	REC26-70080 REC26-70081
90 EFI	1B366823 - 2B094995	USA	4	REC47-43026Q06	REC26-43035A4	REC26-70080 REC26-70081
90 EFI Et SEAPRO	2B095049 +	USA	4	REC46-8M0061040	REC8M0088080 (RR) REC8M0088081 (CR)	REC26-76868 REC26-12224
100 EFI	OP459572 - 2B094995	BEL	4	REC47-43026Q06	REC26-43035A4	REC26-70080 REC26-70081
100 EFI	1B227000 - 1B366822	USA	4	REC47-43026Q06	REC26-43035A4	REC26-70080 REC26-70081
100 EFI	1B366823 - 2B094995	USA	4	REC47-43026Q06	REC26-43035A4	REC26-70080 REC26-70081
100 EFI	2B095049 +	USA	4	REC46-8M0061040	REC8M0088080 (RR) REC8M0088081 (CR)	REC26-76868 REC26-12224
115 EFI	OT178500 - OT800999	USA	4	REC47-43026Q06	REC26-43035A4	REC26-70080 REC26-70081
115 EFI	OT801000 - 1B226999	USA	4	REC47-43026Q06	REC26-43035A4	REC26-70080 REC26-70081
115 EFI	1B227000 - 1B366822	USA	4	REC47-43026Q06	REC26-43035A4	REC26-70080 REC26-70081
115 EFI	1B366823 - 2B094995	USA	4	REC47-43026Q06	REC26-43035A4	REC26-70080 REC26-70081
115 EFI Et SEAPRO (XS)	2B095049 +		4	REC46-8M0061040	REC8M0088080 (RR) REC8M0088081 (CR)	REC26-76868 REC26-12224
135	2B131942 +		4	REC46-8M0061040	REC8M0057716	REC26-76868
135 VERADO	OP419487 - OP464487	BEL	4	REC47-43026Q06	REC26-830749A01	REC26-888483
135 VERADO	OP464488 - OP514868	BEL	4	REC47-43026Q06	REC26-830749A01	REC26-888483
135 VERADO	OP514869 - OP593020	BEL	4	REC47-43026Q06	REC26-830749A01	REC26-888483
135 VERADO	1B227000 - 1B381711	USA	4	REC47-43026Q06	REC26-830749A01	REC26-888483
135 VERADO	1B381712 - 1B517158	USA	4	REC47-43026Q06	REC26-830749A01	REC26-888483
135 VERADO	1B517159 - 2B576734	USA	4	REC47-43026Q06	REC26-830749A01	REC26-888483
150	1B905505 +		4	REC46-8M0061040	REC8M0057716	REC26-76868
150 SEAPRO	2B139139 +		4	REC46-8M0061040	REC8M0057716	REC26-76868
150 Pro XS	2B550139 +		4	REC817275A08		REC26-888483
150 VERADO	OP419487 - OP464487	BEL	4	REC47-43026Q06	REC26-830749A01	REC26-888483
150 VERADO	OP464488 - OP514868	BEL	4	REC47-43026Q06	REC26-830749A01	REC26-888483
150 VERADO	OP514869 - OP593020	BEL	4	REC47-43026Q06	REC26-830749A01	REC26-888483
150 VERADO	1B227000 - 1B381711	USA	4	REC47-43026Q06	REC26-830749A01	REC26-888483
150 VERADO	1B381712 - 1B517158	USA	4	REC47-43026Q06	REC26-830749A01	REC26-888483
150 VERADO	1B517159 - 2B576734	USA	4	REC47-43026Q06	REC26-830749A01	REC26-888483

			CYL	KIT BOMBA PUMP SET KIT POMPA KIT POMPE	KIT RETÉN COLA DRIVE SEAL SET KIT TENUTA PIEDE KIT JOINT EMBASE	RETÉN HÉLICE PROPELLER SEAL PARAOLIO ELICA JOINT SPI D'HELICE
175 VERADO	OP419487 - OP464487	BEL	4	REC47-43026Q06	REC26-830749A01	REC26-888483
175 VERADO	OP464488 - OP514868	BEL	4	REC47-43026Q06	REC26-830749A01	REC26-888483
175 VERADO	OP514869 - OP593020	BEL	4	REC47-43026Q06	REC26-830749A01	REC26-888483
175 VERADO	1B227000 - 1B381711	USA	4	REC47-43026Q06	REC26-830749A01	REC26-888483
175 VERADO	1B381712 - 1B517158	USA	4	REC47-43026Q06	REC26-830749A01	REC26-888483
175 VERADO	1B517159 - 2B576734	USA	4	REC47-43026Q06	REC26-830749A01	REC26-888483
175 (3.4L) V6 Et Pro XS	2B529482 +	USA	6	REC47-8M0142980	REC26-8M0142979	REC26-888483
200 VERADO	OP514869 - OP593020	BEL	4	REC47-43026Q06	REC26-830749A01	REC26-888483
200 VERADO	1B517159 - 2B576734	USA	4	REC47-43026Q06	REC26-830749A01	REC26-888483
200 VERADO	OP409357 - OP464487	BEL	6	REC47-43026Q06	REC26-830749A01	REC26-888483
200 VERADO	OP464488 - OP520552	BEL	6	REC47-43026Q06	REC26-830749A01	REC26-888483
200 VERADO	OP520553 - 2B144122	BEL	6	REC47-43026Q06 REC8M0065072	REC26-830749A01 (4,80) REC8M0065064 (5,44)	REC26-888483
200 VERADO	OT980000 - 1B226999	USA	6	REC47-43026Q06	REC26-830749A01	REC26-888483
200 VERADO	1B227000 - 1B381711	USA	6	REC47-43026Q06	REC26-830749A01	REC26-888483
200 VERADO	1B381712 - 1B517433	USA	6	REC47-43026Q06	REC26-830749A01	REC26-888483
200 VERADO	1B517434 - 2B144122	USA	6	REC47-43026Q06 REC8M0065072	REC26-830749A01 (4,80) REC8M0065064 (5,44)	REC26-888483
200 VERADO	2B144123 - 2B578935	USA	6	REC47-43026Q06 REC8M0065072	REC26-830749A01 (4,80) REC8M0065064 (5,44)	REC26-888483
200 Pro VERADO	2B034840 - 2B144122		6	REC47-43026Q06	REC26-830749A01	REC26-888483
200 Pro VERADO	2B144123 - 2B577715		6	REC47-43026Q06	REC26-830749A01	REC26-888483
200 (3.4L) V6 Et SEAPRO	2B529482 +	USA	6	REC47-8M0142980	REC26-8M0142979	REC26-888483
200 (4.6L) V8 PRO XS	2B529482 +	USA	8	REC47-8M0142980	REC26-8M0142979	REC26-888483
225 EFI	OT653945 +	USA	6	REC6G5-W0078-A1	REC69J-W0001-20-00	REC93101-30M17
225 VERADO	OP409357 - OP464487	BEL	6	REC47-43026Q06	REC26-830749A01	REC26-888483
225 VERADO	OP464488 - OP520552	BEL	6	REC47-43026Q06	REC26-830749A01	REC26-888483
225 VERADO	OP520553 - 2B144122	BEL	6	REC47-43026Q06 REC8M0065072	REC26-830749A01 (4,80) REC8M0065064 (5,44)	REC26-888483
225 VERADO	OT980000 - 1B226999	USA	6	REC47-43026Q06	REC26-830749A01	REC26-888483
225 VERADO	1B227000 - 1B381711	USA	6	REC47-43026Q06	REC26-830749A01	REC26-888483
225 VERADO	1B381712 - 1B517433	USA	6	REC47-43026Q06	REC26-830749A01	REC26-888483
225 VERADO	1B517434 - 2B144122	USA	6	REC47-43026Q06 REC8M0065072	REC26-830749A01 (4,80) REC8M0065064 (5,44)	REC26-888483
225 VERADO	2B144123 - 2B578935	USA	6	REC47-43026Q06 REC8M0065072	REC26-830749A01 (4,80) REC8M0065064 (5,44)	REC26-888483
225 (3.4L) V6 Et SEAPRO	2B529482 +	USA	6	REC47-8M0142980	REC26-8M0142979	REC26-888483
225 (4.6L) V8 PRO XS	2B529482 +	USA	8	REC47-8M0142980	REC26-8M0142979	REC26-888483
250 VERADO	OP409357 - OP464487	BEL	6	REC47-43026Q06	REC26-830749A01	REC26-888483
250 VERADO	OP464488 - OP520552	BEL	6	REC47-43026Q06	REC26-830749A01	REC26-888483
250 VERADO	OP520553 - 2B144122	BEL	6	REC47-43026Q06 REC8M0065072	REC26-830749A01 (4,80) REC8M0065064 (5,44)	REC26-888483
250 VERADO	OT980000 - 1B226999	USA	6	REC47-43026Q06	REC26-830749A01	REC26-888483
250 VERADO	1B227000 - 1B381711	USA	6	REC47-43026Q06	REC26-830749A01	REC26-888483
250 VERADO	1B381712 - 1B517433	USA	6	REC47-43026Q06	REC26-830749A01	REC26-888483
250 VERADO	1B517434 - 2B144122	USA	6	REC47-43026Q06 REC8M0065072	REC26-830749A01 (4,80) REC8M0065064 (5,44)	REC26-888483
250 VERADO	2B144123 - 2B578935	USA	6	REC47-43026Q06 REC8M0065072	REC26-830749A01 (4,80) REC8M0065064 (5,44)	REC26-888483
250 PRO VERADO	1B830170 - 2B144122		6	REC47-43026Q06	REC26-830749A01	REC26-888483
250 PRO VERADO	2B144123 - 2B577715	USA	6	REC47-43026Q06	REC26-830749A01	REC26-888483
250 (4.6L) V8, VERADO, SEAPRO Et PRO XS	2B529482 +	USA	8	REC47-8M0142980	REC26-8M0142979	REC26-888483
250 (4.6L) V8 RACING	1E080500+	USA	8	REC47-8M0142980	REC26-8M0142979	REC26-888483
275 VERADO	OP409357 - OP464487	BEL	6	REC47-43026Q06	REC26-830749A01	REC26-888483
275 VERADO	OP464488 - OP520552	BEL	6	REC47-43026Q06	REC26-830749A01	REC26-888483
275 VERADO	OP520553 - 2B144122	BEL	6	REC47-43026Q06 REC8M0065072	REC26-830749A01 (4,80) REC8M0065064 (5,44)	REC26-888483
275 VERADO	OT980000 - 1B226999	USA	6	REC47-43026Q06	REC26-830749A01	REC26-888483
275 VERADO	1B227000 - 1B381711	USA	6	REC47-43026Q06	REC26-830749A01	REC26-888483
275 VERADO	1B381712 - 1B517433	USA	6	REC47-43026Q06	REC26-830749A01	REC26-888483
275 VERADO	1B517434 - 2B144122	USA	6	REC47-43026Q06 REC8M0065072	REC26-830749A01 (4,80) REC8M0065064 (5,44)	REC26-888483
275 VERADO	2B144123 - 2B578935	USA	6	REC47-43026Q06 REC8M0065072	REC26-830749A01 (4,80) REC8M0065064 (5,44)	REC26-888483
300 VERADO	OP520553 - 2B144122	BEL	6	REC47-43026Q06 REC8M0065072	REC26-830749A01 (4,80) REC8M0065064 (5,44)	REC26-888483
300 VERADO	1B517434 - 2B144122	USA	6	REC47-43026Q06 REC8M0065072	REC26-830749A01 (4,80) REC8M0065064 (5,44)	REC26-888483
300 VERADO	2B144123 - 2B578935	USA	6	REC47-43026Q06 REC8M0065072	REC26-830749A01 (4,80) REC8M0065064 (5,44)	REC26-888483
300 PRO VERADO	1B830170 - 2B144122		6	REC47-43026Q06	REC26-830749A01	REC26-888483
300 PRO VERADO	2B144123 - 2B577715	USA	6	REC47-43026Q06	REC26-830749A01	REC26-888483
300 (4.6L) V8, VERADO, SEAPRO Et PRO XS	2B529482 +	USA	8	REC47-8M0142980	REC26-8M0142979	REC26-888483
300 (4.6L) V8 RACING	1E080500+	USA	8	REC47-8M0142980	REC26-8M0142979	REC26-888483
350SCI VERADO	1B716557 - 2B143542		6	REC47-43026Q06		REC26-888483
350 2.6L L6 VERADO	2B141617 +	USA	6	REC8M0065072	REC8M0065064	REC26-888483
350 2.6L L6 PRO VERADO	2B141124 +	USA	6	REC8M0065072	REC8M0065064	REC26-888483
400 2.6L L6 VERADO	2B618256 +	USA	6	REC8M0065072	REC8M0065064	REC26-888483
400R 2.6L L6 RACING	2B141124 +	USA	6	REC8M0065072	REC8M0065064	REC26-888483
450 4.6L V8 RACING	2B529482 +	USA	8	REC47-8M0142980	REC8M0065064	REC26-888483

2 T/STROKES		KIT		KIT SUPERIOR UPPER KIT KIT SUPERIORE KIT SUPERIEUR		KIT		KIT		KIT		
3.5	1983-85	6202173									REC47-89980	REC70977T
3.6	1980-82 USA	5404657									REC47-89980	REC70977T
3.6	1980-82 BEL	9252831									REC47-89980	REC70977T
3.6	1980-82 CAN	7145388									REC47-89980	REC70977T
3.9 (14)	1964-71	1655013-2200317									REC47-22748	
3.9 (14)	1964-71	2200318-2498135									REC47-22748	
	1982-86 USA	5595532-0A809600									REC47-89980	REC47-89980T1 REC93224A1 REC70977T REC46895
4 (1 cyl)	1982-86 AUS	8068065									REC47-89980	REC47-89980T1 REC93224A1 REC70977T REC46895
.438" Ø Int.	1982-86 BEL	9258281-9477829									REC47-89980	REC47-89980T1 REC93224A1 REC70977T REC46895
	1982-86 CAN	7143688									REC47-89980	REC47-89980T1 REC93224A1 REC70977T REC46895
4 (1 cyl)	1982-86 USA	5595532	REC46-70941A3		REC46-70941T01		REC47-89981	REC47-89981Q1	REC93224A1	REC70977T	REC46895	
	1982-86 AUS	8068065	REC46-70941A3		REC46-70941T01		REC47-89981	REC47-89981Q1	REC93224A1	REC70977T	REC46895	
.456" Ø Int.	1982-86 BEL	9258281	REC46-70941A3		REC46-70941T01		REC47-89981	REC47-89981Q1	REC93224A1	REC70977T	REC46895	
	1982-86 CAN	7143688	REC46-70941A3		REC46-70941T01		REC47-89981	REC47-89981Q1	REC93224A1	REC70977T	REC46895	
40/4 (2 cyl) GNAT	1976-79 BEL	9075839-9256980									REC47-89980	REC70977T
.438" Ø Int.	1976-79 CAN	7085673-7146487									REC47-89980	REC70977T
40/4 (2 cyl)	1976-79 BEL	9075839-9256980									REC47-89981	REC70977T
.456" Ø Int.	1976-79 CAN	7085673-7146487									REC47-89981	REC70977T
40/4 (2 cyl)	1980-81 USA	5589202									REC47-89980	REC70977T
40/4 (2 cyl)	1980-81 AUS	8065265									REC47-89980	REC70977T
40/4 (2 cyl)	1980-81 BEL	9256981									REC47-89980	REC70977T
40/4 (2 cyl)	1980-81 CAN	7146488									REC47-89980	REC70977T
45/4.5 (1 cyl)	1975-79 USA	4107220-5595531	REC46-70941A3		REC46-70941T01		REC47-89981	REC47-89981Q1	REC93224A1	REC70977T	REC46895	
45/4.5 (1 cyl)	1975-79 AUS	8026540-8068064	REC46-70941A3		REC46-70941T01		REC47-89981	REC47-89981Q1	REC93224A1	REC70977T	REC46895	
45/4.5 (1 cyl)	1975-79 BEL	9072179-9258280	REC46-70941A3		REC46-70941T01		REC47-89981	REC47-89981Q1	REC93224A1	REC70977T	REC46895	
45/4.5 (1 cyl)	1975-79 CAN	7045758-7147237	REC46-70941A3		REC46-70941T01		REC47-89981	REC47-89981Q1	REC93224A1	REC70977T	REC46895	
	1980-85 USA	5595532									REC47-89980	REC47-89980T1 REC93224A1 REC70977T REC46895
45/4.5 (1 cyl)	1980-85 AUS	8068065									REC47-89980	REC47-89980T1 REC93224A1 REC70977T REC46895
.438" Ø Int.	1980-85 BEL	9258281									REC47-89980	REC47-89980T1 REC93224A1 REC70977T REC46895
	1980-85 CAN	7147238									REC47-89980	REC47-89980T1 REC93224A1 REC70977T REC46895
	1980-85 USA	5595532	REC46-70941A3		REC46-70941T01		REC47-89981	REC47-89981Q1	REC93224A1	REC70977T	REC46895	
45/4.5 (1 cyl)	1980-85 AUS	8068065	REC46-70941A3		REC46-70941T01		REC47-89981	REC47-89981Q1	REC93224A1	REC70977T	REC46895	
.456" Ø Int.	1980-85 BEL	9258281	REC46-70941A3		REC46-70941T01		REC47-89981	REC47-89981Q1	REC93224A1	REC70977T	REC46895	
	1980-85 CAN	7147238	REC46-70941A3		REC46-70941T01		REC47-89981	REC47-89981Q1	REC93224A1	REC70977T	REC46895	
60 (6 HP)	1963-65	1408611-1490054									REC47-22748	
60 (6 HP)	1963-65	1490055-1582402									REC47-22748	
60 (6 HP) (12)	1963-65	1582403-1916138									REC47-22748	
60 (6 HP) (12)	1966-68	1916139-2193817									REC47-89981	
60 (6 HP)	1966-68	2193818-2529894									REC47-89981	REC93224A1 REC70977T REC46895
60J (6 HP)	1967-68	2385673-2387383									REC47-89981	
6	1986-93 USA	0A197112-07800749	REC46-42089A5		REC46-42040T5		REC47-420382	REC47-42038Q3	REC46-42089A2		REC42200	
6	1986-93 BEL	9461526	REC46-42089A5		REC46-42040T5		REC47-420382	REC47-42038Q3	REC46-42089A2		REC42200	
75 (7.5 HP)	1969-77 USA	2529895-4131609									REC47-89981	REC93224A1 REC70977T REC46895
75 (7.5 HP)	1974-77 AUS	8015315-8028839									REC47-89981	REC93224A1 REC70977T REC46895
75 (7.5 HP)	1974-77 BEL	9043194-9079488									REC47-89981	REC93224A1 REC70977T REC46895
75 (7.5 HP)	1974-77 CAN	7028598-7050207									REC47-89981	REC93224A1 REC70977T REC46895
75 (7.5 HP)	1974-78 USA	4131610-5226934	REC46-70941A3		REC46-70941T01		REC47-89981	REC47-89981Q1	REC93224A1	REC70977T	REC46895	
75 (7.5 HP)	1974-77 AUS	8028840-8058019	REC46-70941A3		REC46-70941T01		REC47-89981	REC47-89981Q1	REC93224A1	REC70977T	REC46895	
75 (7.5 HP)	1974-78 BEL	9079489-9219255	REC46-70941A3		REC46-70941T01		REC47-89981	REC47-89981Q1	REC93224A1	REC70977T	REC46895	
75 (7.5 HP)	1974-78 CAN	7050206-7136037	REC46-70941A3		REC46-70941T01		REC47-89981	REC47-89981Q1	REC93224A1	REC70977T	REC46895	
	1979-86 USA	5206550									REC47-89980	REC47-89980T1 REC93224A1 REC70977T REC46895
7.5 HP	1979-86 AUS	8057545									REC47-89980	REC47-89980T1 REC93224A1 REC70977T REC46895
.438" Ø Int.	1979-86 BEL	9217756									REC47-89980	REC47-89980T1 REC93224A1 REC70977T REC46895
	1979-86 CAN	7125388									REC47-89980	REC47-89980T1 REC93224A1 REC70977T REC46895
	1979-86 USA	5206550	REC46-70941A3		REC46-70941T01		REC47-89981	REC47-89981Q1	REC93224A1	REC70977T	REC46895	
7.5 HP	1979-86 AUS	8057545	REC46-70941A3		REC46-70941T01		REC47-89981	REC47-89981Q1	REC93224A1	REC70977T	REC46895	
.456" Ø Int.	1979-86 BEL	9217756	REC46-70941A3		REC46-70941T01		REC47-89981	REC47-89981Q1	REC93224A1	REC70977T	REC46895	
	1979-86 CAN	7125388	REC46-70941A3		REC46-70941T01		REC47-89981	REC47-89981Q1	REC93224A1	REC70977T	REC46895	
8	1986-93 USA	0A197112 +	REC46-42089A5		REC46-42040T5		REC47-420382	REC47-42038Q3	REC46-42089A2		REC42200	
8	1986-93 BEL	9461526	REC46-42089A5		REC46-42040T5		REC47-420382	REC47-42038Q3	REC46-42089A2		REC42200	
110 (9.8 HP) (13)	1966-69	1865779-2196388									REC47-89981	
110 (9.8 HP)	1970-73	2196389-3795657									REC47-89981	REC93224A1 REC70977T REC46895
110 (9.8 HP)	1974-77 USA	3795658-4126459									REC47-89981	REC46-42089A2 REC70977T REC46895
110 (9.8 HP)	1974-77 AUS	8015040-8028439									REC47-89981	REC46-42089A2 REC70977T REC46895
110 (9.8 HP)	1974-77 BEL	9041439-9078138									REC47-89981	REC46-42089A2 REC70977T REC46895
110 (9.8 HP)	1974-77 CAN	7027323-7049107									REC47-89981	REC46-42089A2 REC70977T REC46895
110 (9.8 HP)	1974-78 USA	4126460-5206549	REC46-70941A3		REC46-70941T01		REC47-89981	REC47-89981Q1	REC93224A1	REC70977T	REC46895	
110 (9.8 HP)	1974-78 AUS	8028440-8057554	REC46-70941A3		REC46-70941T01		REC47-89981	REC47-89981Q1	REC93224A1	REC70977T	REC46895	
110 (9.8 HP)	1974-78 BEL	9078139-9217755	REC46-70941A3		REC46-70941T01		REC47-89981	REC47-89981Q1	REC93224A1	REC70977T	REC46895	
110 (9.8 HP)	1974-78 CAN	7049108-7125387	REC46-70941A3		REC46-70941T01		REC47-89981	REC47-89981Q1	REC93224A1	REC70977T	REC46895	
	1979-85 USA	5206550									REC47-89980	REC47-89980T1 REC93224A1 REC70977T REC46895
9.8 HP	1979-85 AUS	8057545									REC47-89980	REC47-89980T1 REC93224A1 REC70977T REC46895
.438" Ø Int.	1979-85 BEL	9217756									REC47-89980	REC47-89980T1 REC93224A1 REC70977T REC46895
	1979-85 CAN	7125388									REC47-89980	REC47-89980T1 REC93224A1 REC70977T REC46895
	1979-85 USA	5206550	REC46-70941A3		REC46-70941T01		REC47-89981	REC47-89981Q1	REC93224A1	REC70977T	REC46895	
9.8 HP	1979-85 AUS	8057545	REC46-70941A3		REC46-70941T01		REC47-89981	REC47-89981Q1	REC93224A1	REC70977T	REC46895	
.456" Ø Int.	1979-85 BEL	9217756	REC46-70941A3		REC46-70941T01		REC47-89981	REC47-89981Q1	REC93224A1	REC70977T	REC46895	
	1979-85 CAN	7125388	REC46-70941A3		REC46-70941T01		REC47-89981	REC47-89981Q1	REC93224A1	REC70977T	REC46895	
9.9	1986-98 USA	0A197112 +	REC46-42089A5		REC46-42040T5		REC47-420382	REC47-42038Q3	REC46-42089A2		REC42200	

				KIT	KIT SUPERIOR UPPER KIT KIT SUPERIORE KIT SUPERIEUR			KIT				
9.9		1986-93	BEL	9461526	REC46-42089A5	REC46-42040T5	REC47-420382	REC47-42038Q3	REC46-42089A2		REC42200	
XR10, Sea Pro, 10 Mag. Et Marat		1990-98	USA	0D038000 +	REC46-42089A5	REC46-42040T5	REC47-420382	REC47-42038Q3	REC46-42089A2		REC42200	
XR10, Sea Pro, 10 Mag. Et Mara		1990-98	BEL	9596000	REC46-42089A5	REC46-42040T5	REC47-420382	REC47-42038Q3	REC46-42089A2		REC42200	
15		1988-98	USA	0B292414 +	REC46-42089A5	REC46-42040T5	REC47-420382	REC47-42038Q3	REC46-42089A2		REC42200	
15		1988-93	BEL	9542620	REC46-42089A5	REC46-42040T5	REC47-420382	REC47-42038Q3	REC46-42089A2		REC42200	
15 Sea Pro Et Marathon		1994-98	USA	0G044365 +	REC46-42089A5	REC46-42040T5	REC47-420382	REC47-42038Q3	REC46-42089A2		REC42200	
15 Sea Pro Et Marathon		1997-98	BEL	9927000	REC46-42089A5	REC46-42040T5	REC47-420382	REC47-42038Q3	REC46-42089A2		REC42200	
15 XD, Big Foot		1997-98	BEL	9927000		REC46-99157T2	REC47-8508910	REC47-85089Q4	REC46-99157T2		REC85083	
18, 18XD		1980-85	USA	5837437		REC46-99157T2	REC47-8508910	REC47-85089Q4	REC46-99157T2		REC85083	
18, 18XD		1980-83	AUS	8071973		REC46-99157T2	REC47-8508910	REC47-85089Q4	REC46-99157T2		REC85083	
18, 18XD		1980-85	BEL	9308306		REC46-99157T2	REC47-8508910	REC47-85089Q4	REC46-99157T2		REC85083	
200 (20 HP)		1966-67		1866496-2296266							REC46-96146A6	
200 (20 HP) (2)		1968-69		2296267-2827676							REC46-96146A6	
200 (20 HP) (4)		1968-69		2296267-2827676							REC46-96146A6	
200 (20 HP)		1970-81	USA	2827677-6443972				REC47-89982	REC47-89982T1		REC46-96146A6	
200 (20 HP)		1973-81	AUS	8006265				REC47-89982	REC47-89982T1		REC46-96146A6	
200 (20 HP)		1973-81	BEL	9016254-9415100				REC47-89982	REC47-89982T1		REC46-96146A6	
200 (20 HP)		1973-81	CAN	7012358-7209532				REC47-89982	REC47-89982T1		REC46-96146A6	
20, 20XD		1986-87	USA	6443973-07800749		REC46-99157T2	REC47-8508910	REC47-85089Q4	REC46-99157T2		REC85083	
20, 20XD		1986-87	BEL	9415101		REC46-99157T2	REC47-8508910	REC47-85089Q4	REC46-99157T2		REC85083	
20, 20XD		1986-87	CAN	7209533		REC46-99157T2	REC47-8508910	REC47-85089Q4	REC46-99157T2		REC85083	
25, 25XD		1980-87	USA	5705532		REC46-99157T2	REC47-8508910	REC47-85089Q4	REC46-99157T2		REC85083	
25, 25XD		1980-83	AUS	8073158		REC46-99157T2	REC47-8508910	REC47-85089Q4	REC46-99157T2		REC85083	
25 Sea Pro, Mara., Super 15		1988-98	USA	0B238464 +		REC46-99157T2	REC47-8508910	REC47-85089Q4	REC46-99157T2		REC85083	
25 Sea Pro, Mara., Super 15		1988-94	BEL	9507381		REC46-99157T2	REC47-8508910	REC47-85089Q4	REC46-99157T2		REC85083	
25 Sea Pro, Mara., Super 15		1988-94	CAN	0A730007 +		REC46-99157T2	REC47-8508910	REC47-85089Q4	REC46-99157T2		REC85083	
25 (3 cyl)		1997	USA	0,00E+00		REC46-99157T2	REC47-8508910	REC47-85089Q4	REC46-99157T2		REC85083	
300 (30 HP)		1959-61		1271884-1448139				REC47-89983T				
30 (2 cyl) (644cc)		1994-98	USA	0G053314-0T598999		REC46-821307A2	REC47-8508910	REC821354A2			REC8213542	
30 Jet		1994-97	USA	0C159200-0G58999	REC46-77177A3	REC46-60366T1	REC46-77177A1	REC47-89983T	REC47-89983Q1	REC46-77822A1	REC48753	REC32768
30 Jet		1998	USA	0G590000 +				REC47-8508910	REC821354A2		REC8213542	
350 (35 HP)		1963-65		157114-1960826				REC47-89983T				
350 (35 HP) (4)		1966-69		1960827-2453068		REC46-60366T1		REC47-89983T	REC46-77822A1	REC48753	REC32768	
35 (2 cyl)		1984-89	USA	6445653	REC46-77177A3	REC46-60366T1	REC46-77177A1	REC47-89983T	REC47-89983Q1	REC46-77822A1	REC48753	REC32768
35 (2 cyl)		1984-86	BEL	9384476	REC46-77177A3	REC46-60366T1	REC46-77177A1	REC47-89983T	REC47-89983Q1	REC46-77822A1	REC48753	REC32768
35 (2 cyl)		1984-86	USA	7209608	REC46-77177A3	REC46-60366T1	REC46-77177A1	REC47-89983T	REC47-89983Q1	REC46-77822A1	REC48753	REC32768
400 (40 HP)		1960-61		1279685-1476509				REC47-89983T				
400, 402 (40 HP)		1970-77	USA	2874704-4362214		REC46-60366T1	REC47-89983T	REC47-89983Q1	REC46-77822A1	REC48753	REC32768	
400, 402 (40 HP)		1970-77	AUS	8002335-8036449		REC46-60366T1	REC47-89983T	REC47-89983Q1	REC46-77822A1	REC48753	REC32768	
400, 402 (40 HP)		1970-77	BEL	3339688-9108563		REC46-60366T1	REC47-89983T	REC47-89983Q1	REC46-77822A1	REC48753	REC32768	
400, 402 (40 HP)		1970-77	CAN	3340783-7070272		REC46-60366T1	REC47-89983T	REC47-89983Q1	REC46-77822A1	REC48753	REC32768	
402 (40 HP)		1975-77	USA	4362215-4860102		REC46-60366T1	REC46-73640A1	REC47-89983T	REC47-89983Q1	REC46-77822A1	REC48753	REC32768
402 (40 HP)		1975-77	AUS	8036450-8052124		REC46-60366T1	REC46-73640A1	REC47-89983T	REC47-89983Q1	REC46-77822A1	REC48753	REC32768
402 (40 HP)		1975-77	BEL	9108564-9184450		REC46-60366T1	REC46-73640A1	REC47-89983T	REC47-89983Q1	REC46-77822A1	REC48753	REC32768
402 (40 HP)		1975-77	CAN	7070273-7112422		REC46-60366T1	REC46-73640A1	REC47-89983T	REC47-89983Q1	REC46-77822A1	REC48753	REC32768
402, 40 (2 cyl) 1983 +		1978-83	USA	4860103	REC46-77177A3	REC46-60366T1	REC46-77177A1	REC47-89983T	REC47-89983Q1	REC46-77822A1	REC48753	REC32768
402, 40 (2 cyl) 1983 +		1978-83	AUS	8052125	REC46-77177A3	REC46-60366T1	REC46-77177A1	REC47-89983T	REC47-89983Q1	REC46-77822A1	REC48753	REC32768
402, 40 (2 cyl) 1983 +		1978-83	BEL	9184451	REC46-77177A3	REC46-60366T1	REC46-77177A1	REC47-89983T	REC47-89983Q1	REC46-77822A1	REC48753	REC32768
402, 40 (2 cyl) 1983 +		1978-83	CAN	7112423	REC46-77177A3	REC46-60366T1	REC46-77177A1	REC47-89983T	REC47-89983Q1	REC46-77822A1	REC48753	REC32768
40 (2 cyl) (644cc) 1994 +		1994-98	USA	0G053314 +		REC46-821307A2	REC47-8508910	REC821354A2			REC8213542	
40 (3 cyl)		1997-98	USA	0G531301 +		REC46-821307A2	REC47-8508910	REC821354A2			REC8213542	
40 (3 cyl)		1997-98	BEL	9973100		REC46-821307A2	REC47-8508910	REC821354A2			REC8213542	
40 (4 cyl)		1989	USA	0C159200 +	REC46-77177A3	REC46-60366T1	REC46-77177A1	REC47-89983T	REC47-89983Q1	REC46-77822A1	REC48753	REC32768
40 (4 cyl)		1989	BEL	9570790	REC46-77177A3	REC46-60366T1	REC46-77177A1	REC47-89983T	REC47-89983Q1	REC46-77822A1	REC48753	REC32768
45 Jet		1994-95	USA	0D000750 +	REC46-812966A12			REC47-19453T	REC47-19453QZ	REC14334A3	REC19700A2	
45 (4 cyl)		1986	USA	5531630	REC46-77177A3	REC46-60366T1	REC46-77177A1	REC47-89983T	REC47-89983Q1	REC46-77822A1	REC48753	REC32768
45 (4 cyl)		1986	AUS	8063985	REC46-77177A3	REC46-60366T1	REC46-77177A1	REC47-89983T	REC47-89983Q1	REC46-77822A1	REC48753	REC32768
45 (4 cyl)		1986	BEL	9248006	REC46-77177A3	REC46-60366T1	REC46-77177A1	REC47-89983T	REC47-89983Q1	REC46-77822A1	REC48753	REC32768
45 (4 cyl)		1986	CAN	743688	REC46-77177A3	REC46-60366T1	REC46-77177A1	REC47-89983T	REC47-89983Q1	REC46-77822A1	REC48753	REC32768
500 (50 HP)		1961-64		1421113-1460498				REC47-89983T				
500 (50 HP)		1961-64		1477910-1521913				REC47-89983T				
500 (50 HP)		1961-67	USA	1521914-2305100				REC47-89983T			REC32768	
500 (50 HP)		1965-67	CAN	1755549-2305100				REC47-89983T			REC32768	
500 (50 HP) (2)		1968-70	USA	2305101-2478119				REC47-89983T			REC32768	
500 (50 HP) (4)		1968-70	USA	2305101-2478119		REC46-60366T1		REC47-89983T	REC47-89983Q1	REC46-77822A1	REC48753	REC32768
500 (50 HP) (2)		1971-74	CAN	2305101-2308830				REC47-89983T			REC32768	
500 (50 HP) (4)		1971-74	CAN	2305101-2308830		REC46-60366T1		REC47-89983T	REC47-89983Q1	REC46-77822A1	REC48753	REC32768
500 (50 HP)		1971-75	USA	2514919-4357639		REC46-60366T1		REC47-89983T	REC47-89983Q1	REC46-77822A1	REC48753	REC32768
500 (50 HP)		1971-75	AUS	2863739-8030089		REC46-60366T1		REC47-89983T	REC47-89983Q1	REC46-77822A1	REC48753	REC32768
500 (50 HP)		1971-75	BEL	9001581-9107213		REC46-60366T1		REC47-89983T	REC47-89983Q1	REC46-77822A1	REC48753	REC32768
500 (50 HP)		1971-75	CAN	2519919-7068997		REC46-60366T1		REC47-89983T	REC47-89983Q1	REC46-77822A1	REC48753	REC32768
500, 50 HP (4 cyl)		1976-79	USA	4357640-5531629	REC46-73640A2	REC46-60366T1	REC46-73640A1	REC47-89983T	REC47-89983Q1	REC46-77822A1	REC48753	REC32768
500, 50 HP (4 cyl)		1976-79	AUS	8030090-8063984	REC46-73640A2	REC46-60366T1	REC46-73640A1	REC47-89983T	REC47-89983Q1	REC46-77822A1	REC48753	REC32768
500, 50 HP (4 cyl)		1976-79	BEL	9107214-9248005	REC46-73640A2	REC46-60366T1	REC46-73640A1	REC47-89983T	REC47-89983Q1	REC46-77822A1	REC48753	REC32768
500, 50 HP (4 cyl)		1976-79	CAN	7068998-7143687	REC46-73640A2	REC46-60366T1	REC46-73640A1	REC47-89983T	REC47-89983Q1	REC46-77822A1	REC48753	REC32768
50 HP (4 cyl)		1980-85	USA	5531630	REC46-77177A3	REC46-60366T1	REC46-77177A1	REC47-89983T	REC47-89983Q1	REC46-77822A1	REC48753	REC32768

				KIT	KIT SUPERIOR UPPER KIT KIT SUPERIORE KIT SUPERIEUR			KIT			
50 HP (4 cyl)	1980-85	AUS	8063985	REC46-77177A3	REC46-60366T1	REC46-77177A1	REC47-89983T	REC47-89983Q1	REC46-77822A1	REC48753	REC32768
50 HP (4 cyl)	1980-85	BEL	9248006	REC46-77177A3	REC46-60366T1	REC46-77177A1	REC47-89983T	REC47-89983Q1	REC46-77822A1	REC48753	REC32768
50 HP (4 cyl)	1980-85	CAN	7143688	REC46-77177A3	REC46-60366T1	REC46-77177A1	REC47-89983T	REC47-89983Q1	REC46-77822A1	REC48753	REC32768
50 HP (3 cyl)	1986-87	USA	6428681-0D000749	REC46-77177A3	REC46-60366T1	REC46-77177A1	REC47-89983T	REC47-89983Q1	REC46-77822A1	REC48753	REC32768
50 HP (3 cyl)	1986-87	BEL	9385911-9683054	REC46-77177A3	REC46-60366T1	REC46-77177A1	REC47-89983T	REC47-89983Q1	REC46-77822A1	REC48753	REC32768
50 HP (3 cyl)	1986-87	CAN	7208333	REC46-77177A3	REC46-60366T1	REC46-77177A1	REC47-89983T	REC47-89983Q1	REC46-77822A1	REC48753	REC32768
50 HP (3 cyl)	1991-97	USA	0D000750-0G58999	REC46-812966A12	REC46-812966A7	REC46-812966A7	REC47-19453T	REC47-19453QZ	REC14334A3		REC19700A2
50 HP (3 cyl)	1991-97	BEL	9683055-9973099	REC46-812966A12	REC46-812966A7	REC46-812966A7	REC47-19453T	REC47-19453QZ	REC14334A3		REC19700A2
50 HP (3 cyl)	1998	USA	0G590000 +		REC46-821307A2	REC46-821307A2	REC47-8508910	REC821354A2			REC821354A2
50 HP (3 cyl)	1998	BEL	9973100		REC46-821307A2	REC46-821307A2	REC47-8508910	REC821354A2			REC821354A2
55 HP (3 cyl)	1996-97	USA	0D000750 +	REC46-812966A12	REC46-812966A7	REC46-812966A7	REC47-19453T	REC47-19453QZ	REC14334A3		REC19700A2
55 HP (3 cyl)	1996-97	BEL	9741042	REC46-812966A12	REC46-812966A7	REC46-812966A7	REC47-19453T	REC47-19453QZ	REC14334A3		REC19700A2
60 HP (3 cyl)	1984-87	USA	6428681-0D000749	REC46-77177A3	REC46-60366T1	REC46-77177A1	REC47-89983T	REC47-89983Q1	REC46-77822A1	REC48753	REC32768
60 HP (3 cyl)	1984-87	BEL	9385911-9683054	REC46-77177A3	REC46-60366T1	REC46-77177A1	REC47-89983T	REC47-89983Q1	REC46-77822A1	REC48753	REC32768
60 HP (3 cyl)	1984-87	CAN	7208333	REC46-77177A3	REC46-60366T1	REC46-77177A1	REC47-89983T	REC47-89983Q1	REC46-77822A1	REC48753	REC32768
60 HP (3 cyl) Standard	1991-95	USA	0D000750 +	REC46-812966A12	REC46-812966A7	REC46-812966A7	REC47-19453T	REC47-19453QZ	REC14334A3		REC19700A2
60 HP (3 cyl) Standard	1991-95	BEL	9683055	REC46-812966A12	REC46-812966A7	REC46-812966A7	REC47-19453T	REC47-19453QZ	REC14334A3		REC19700A2
60 HP (3 cyl) Bigfoot	1991-95	USA	0D000750 +	REC12094	REC43055A4	REC43055A4	REC47-43026Q02	REC47-43026Q06	REC817275A2		REC8172761
60 HP (3 cyl) Bigfoot	1991-95	BEL	9683055	REC12094	REC43055A4	REC43055A4	REC47-43026Q02	REC47-43026Q06	REC817275A2		REC8172761
650 (65 HP) (4 cyl) (2)	1963-69		1542745-2803561		REC46-96148A8		REC47-89984T4	REC47-89984Q5	REC46-96148T1		REC324351
650 (65 HP) (4 cyl) (4)	1963-69		1542745-2803561		REC46-96148A8		REC47-89984T4	REC47-89984Q5	REC46-96148T1	REC48752T	REC324351
650 (65 HP) (4 cyl)	1970-72		2803562-2874263		REC46-96148A8		REC47-89984T4	REC47-89984Q5	REC46-96148T1	REC48752T	REC324351
650 (65 HP) (4 cyl)	1970-72		2997439-3293183		REC46-96148A8		REC47-89984T4	REC47-89984Q5	REC46-96148T1	REC48752T	REC324351
65 HP (3 cyl)	1972-75	USA	3293184-4382056		REC46-60366T1		REC47-89983T		REC46-77822A1	REC48753	REC32768
65 HP (3 cyl)	1973-75	AUS	8006640-8042349		REC46-60366T1		REC47-89983T		REC46-77822A1	REC48753	REC32768
65 HP (3 cyl)	1973-75	BEL	9020074-9112988		REC46-60366T1		REC47-89983T		REC46-77822A1	REC48753	REC32768
65 HP (3 cyl)	1973-75	CAN	7013633-7073472		REC46-60366T1		REC47-89983T		REC46-77822A1	REC48753	REC32768
65 HP (3 cyl)	1976	USA	4382057-4571651		REC46-60366T1	REC46-73640A1	REC47-89983T		REC46-77822A1	REC48753	REC32768
65 HP (3 cyl)	1976	BEL	9112989-9135824		REC46-60366T1	REC46-73640A1	REC47-89983T		REC46-77822A1	REC48753	REC32768
65 HP (3 cyl)	1976	CAN	7073473-7087822		REC46-60366T1	REC46-73640A1	REC47-89983T		REC46-77822A1	REC48753	REC32768
65 Jet	1994-98	USA	0D283222 +	REC12094		REC43055A4	REC47-43026Q02	REC47-43026Q06	REC817275A2		REC8172761
65 Jet	1994-98	BEL	9793577	REC12094		REC43055A4	REC47-43026Q02	REC47-43026Q06	REC817275A2		REC8172761
700 (70 HP) (6 cyl)	1961		1413611-1436114				REC47-89984T4				REC324351
700 (70 HP) (6 cyl)	1961		1482212-1503458				REC47-89984T4				REC324351
700 E-2 (70 HP) (6 cyl)	1961		1503459-1503958				REC47-89984T4				REC324351
700 EL-2 (70 HP) (6 cyl)	1961		1503459-1505110				REC47-89984T4				REC324351
700 E-2 (70 HP) (6 cyl) (11)	1961		1503959-1566239		REC46-96148A8		REC47-89984T4	REC47-89984Q5	REC46-96148T1		REC324351
700 EL-2 (70 HP) (6 cyl) (11)	1961		1505111-1566239		REC46-96148A8		REC47-89984T4	REC47-89984Q5	REC46-96148T1		REC324351
70 HP (3 cyl)	1977-79	USA	4571652-4977156	REC46-73640A2	REC46-60366T1	REC46-73640A1	REC47-89983T		REC46-77822A1	REC48753	REC32768
70 HP (3 cyl)	1977-79	AUS	8042350-8050199	REC46-73640A2	REC46-60366T1	REC46-73640A1	REC47-89983T		REC46-77822A1	REC48753	REC32768
70 HP (3 cyl)	1977-79	BEL	9135825-9196960	REC46-73640A2	REC46-60366T1	REC46-73640A1	REC47-89983T		REC46-77822A1	REC48753	REC32768
70 HP (3 cyl)	1977-79	CAN	7087823-7110997	REC46-73640A2	REC46-60366T1	REC46-73640A1	REC47-89983T		REC46-77822A1	REC48753	REC32768
70 HP (3 cyl)	1977-83	USA	4977157-6428680	REC46-77177A3	REC46-60366T1	REC46-77177A1	REC47-89983T	REC47-89983Q1	REC46-77822A1	REC48753	REC32768
70 HP (3 cyl)	1977-83	AUS	8050200	REC46-77177A3	REC46-60366T1	REC46-77177A1	REC47-89983T	REC47-89983Q1	REC46-77822A1	REC48753	REC32768
70 HP (3 cyl)	1977-83	BEL	9196961-9385910	REC46-77177A3	REC46-60366T1	REC46-77177A1	REC47-89983T	REC47-89983Q1	REC46-77822A1	REC48753	REC32768
70 HP (3 cyl)	1977-83	CAN	7110998-7208332	REC46-77177A3	REC46-60366T1	REC46-77177A1	REC47-89983T	REC47-89983Q1	REC46-77822A1	REC48753	REC32768
70 HP (3 cyl) (6)	1987	USA	0A996142-0C221999	REC12094		REC43055A4	REC47-43026Q02		REC817275A2		REC817275A2
70 HP (3 cyl) (6)	1987	BEL	9483121-9589038	REC12094		REC43055A4	REC47-43026Q02		REC817275A2		REC817275A2
70 HP (3 cyl) (5)	1987	USA	0A996142-0C221999	REC12094		REC43055A4	REC47-43026Q02	REC47-43026Q06	REC817275A2		REC8172761
70 HP (3 cyl) (5)	1987	BEL	9483121-9589038	REC12094		REC43055A4	REC47-43026Q02	REC47-43026Q06	REC817275A2		REC8172761
75 HP (4 cyl)	1984-88	USA	6432901		REC46-96148A8		REC47-89984T4	REC47-89984Q5	REC46-96148T1	REC48752T	REC324351
75 HP (4 cyl)	1984-88	BEL	9393856		REC46-96148A8		REC47-89984T4	REC47-89984Q5	REC46-96148T1	REC48752T	REC324351
75 HP (4 cyl)	1984-88	CAN	7208573		REC46-96148A8		REC47-89984T4	REC47-89984Q5	REC46-96148T1	REC48752T	REC324351
75 HP (3 cyl) (6)	1990-98	USA	0C222000 +	REC12094		REC43055A4	REC47-43026Q02	REC47-43026Q06	REC817275A2		REC817275A2
75 HP (3 cyl) (6)	1990-98	BEL	9589039	REC12094		REC43055A4	REC47-43026Q02	REC47-43026Q06	REC817275A2		REC817275A2
75 HP (3 cyl) (5)	1990-98	USA	0C222000 +	REC12094		REC43055A4	REC47-43026Q02	REC47-43026Q06	REC817275A2		REC8172761
75 HP (3 cyl) (5)	1990-98	BEL	9589039	REC12094		REC43055A4	REC47-43026Q02	REC47-43026Q06	REC817275A2		REC8172761
75 (3 cyl) Optimax	1994-98	USA	0T980000 +	REC12094		REC43055A4	REC47-43026Q02	REC47-43026Q06	REC817275A2		REC8172761
800 (80 HP) (6 cyl)	1960		1335465-1398629				REC47-89984T4				REC324351
800 (80 HP) (6 cyl)	1961		1398630-1566239				REC47-89984T4				REC324351
800 (80 HP) (4 cyl)	1969-72		2559001-3144218		REC46-96148A8		REC47-89984T4	REC47-89984Q5	REC46-96148T1	REC48752T	REC324351
800 (80 HP) (4 cyl)	1969-72		3144219-3493912		REC46-96148A8		REC47-89984T4	REC47-89984Q5	REC46-96148T1	REC48752T	REC324351
80 HP (4 cyl)	1978-83	USA	4831999-6432900		REC46-96148A8		REC47-89984T4	REC47-89984Q5	REC46-96148T1	REC48752T	REC324351
80 HP (4 cyl)	1978-83	AUS	8050200		REC46-96148A8		REC47-89984T4	REC47-89984Q5	REC46-96148T1	REC48752T	REC324351
80 HP (4 cyl)	1978-83	BEL	9177626-9393855		REC46-96148A8		REC47-89984T4	REC47-89984Q5	REC46-96148T1	REC48752T	REC324351
80 HP (4 cyl)	1978-83	CAN	7110998-7208572		REC46-96148A8		REC47-89984T4	REC47-89984Q5	REC46-96148T1	REC48752T	REC324351
80 HP (3 cyl) (6)	1987	USA	0A996142-0C221999	REC12094		REC43055A4	REC47-43026Q02		REC817275A2		REC817275A2
80 HP (3 cyl) (6)	1987	BEL	9483121-9589038	REC12094		REC43055A4	REC47-43026Q02		REC817275A2		REC817275A2
80 HP (3 cyl) (5)	1987	USA	0A996142-0C221999 12094		REC43055A4	REC47-43026Q02	REC47-43026Q06		REC817275A2		REC8172761
80 HP (3 cyl) (5)	1987	BEL	9483121-9589038	REC12094		REC43055A4	REC47-43026Q02	REC47-43026Q06	REC817275A2		REC8172761
80 Jet	1994-98	USA	0D283222 +	REC12094		REC43055A4	REC47-43026Q02	REC47-43026Q06	REC817275A2		REC8172761
80 Jet	1994-98	BEL	9793577	REC12094		REC43055A4	REC47-43026Q02	REC47-43026Q06	REC817275A2		REC8172761
850 E, EL (85 HP) (6 cyl)	1963-64		1460999-1567039				REC47-89984T4				REC324351
850 E-1, EL-1 (85 HP) (6 cyl) (11)	1963-64		1566240-1766823		REC46-96148A8		REC47-89984T4	REC47-89984Q5	REC46-96148T1		REC324351
850, 850 XS (85 HP) (4 cyl)	1973-77	USA	3493913-4590511		REC46-96148A8		REC47-89984T4	REC47-89984Q5	REC46-96148T1	REC48752T	REC324351
850, 850 XS (85 HP) (4 cyl)	1973-77	BEL	9011604-9139349		REC46-96148A8		REC47-89984T4	REC47-89984Q5	REC46-96148T1	REC48752T	REC324351
850, 850 XS (85 HP) (4 cyl)	1973-77	CAN	7010108-7091097		REC46-96148A8		REC47-89984T4	REC47-89984Q5	REC46-96148T1	REC48752T	REC324351

			KIT	KIT SUPERIOR UPPER KIT KIT SUPERIORE KIT SUPERIEUR			KIT			
V-135 DFI	1998	USA	0G590000 +	REC46-96148A8	REC46-8M0077147	REC47-89984T4	REC47-89984Q5	REC46-96148T1	REC48752T	REC324351
140 Jet	1994-95	USA	0D082000 +	REC46-96148A8	REC46-8M0077147	REC47-89984T4	REC47-89984Q5	REC46-96148T1	REC48752T	REC324351
140 Jet	1994-95	BEL	9682500	REC46-96148A8	REC46-8M0077147	REC47-89984T4	REC47-89984Q5	REC46-96148T1	REC48752T	REC324351
V-150 Carb. (8)	1978-85	USA	4868998-0A904645	REC46-96148A8	REC46-96146A6	REC47-89984T4	REC47-89984Q5	REC46-96148T1	REC48752T	REC324351
V-150 Carb. (7)	1978-85	USA	4868998-0A904645	REC46-96148A8	REC46-8M0077147	REC47-89984T4	REC47-89984Q5	REC46-96148T1	REC48752T	REC324351
V-150 Carb. EFI Et DFI	1986-88	USA	0A904646 +	REC46-96148A8	REC46-8M0077147	REC47-89984T4	REC47-89984Q5	REC46-96148T1	REC48752T	REC324351
V-150 XR2, 4, 6, Mag.II, III (8)	1978-88	USA	4868998	REC46-96148A8	REC46-8M0077147	REC47-89984T4	REC47-89984Q5	REC46-96148T1	REC48752T	REC324351
V-150 XR2, 4, 6, Mag.II, III (7)	1978-88	USA	4868998	REC46-96148A8	REC46-8M0077147	REC47-89984T4	REC47-89984Q5	REC46-96148T1	REC48752T	REC324351
V-1750, 175 (8)	1976-81	USA	4301235-6618750	REC46-96148A8	REC46-96146A6	REC47-89984T4	REC47-89984Q5	REC46-96148T1	REC48752T	REC324351
V-1750, 175 (8)	1980-81	AUS	8064250	REC46-96148A8	REC46-96146A6	REC47-89984T4	REC47-89984Q5	REC46-96148T1	REC48752T	REC324351
V-1750, 175 (7)	1976-81	USA	4301235-6618750	REC46-96148A8	REC46-8M0077147	REC47-89984T4	REC47-89984Q5	REC46-96148T1	REC48752T	REC324351
V-1750, 175 (7)	1980-81	AUS	8064250	REC46-96148A8	REC46-8M0077147	REC47-89984T4	REC47-89984Q5	REC46-96148T1	REC48752T	REC324351
V-175 Carb., EFI Et DFI	1985-88	USA	6618751	REC46-96148A8	REC46-8M0077147	REC47-89984T4	REC47-89984Q5	REC46-96148T1	REC48752T	REC324351
V-200 (8)	1978-84	USA	4839034-6625220	REC46-96148A8	REC46-96146A6	REC47-89984T4	REC47-89984Q5	REC46-96148T1	REC48752T	REC324351
V-200 (8)	1980-81	AUS	8061595-8065672	REC46-96148A8	REC46-96146A6	REC47-89984T4	REC47-89984Q5	REC46-96148T1	REC48752T	REC324351
V-200 (7)	1978-84	USA	4839034-6625220	REC46-96148A8	REC46-8M0077147	REC47-89984T4	REC47-89984Q5	REC46-96148T1	REC48752T	REC324351
V-200 (7)	1980-81	AUS	8061595-8065672	REC46-96148A8	REC46-8M0077147	REC47-89984T4	REC47-89984Q5	REC46-96148T1	REC48752T	REC324351
V-200 Carb. Et EFI (2.5L)	1985-88	USA	6625221	REC46-96148A8	REC46-8M0077147	REC47-89984T4	REC47-89984Q5	REC46-96148T1	REC48752T	REC324351
V-200 EFI (3.0L)		USA	0T750164 +	REC817275A6	REC807929A1	REC47-43026Q02	REC47-43026Q06	REC817275A1		REC8172761
V-200 DFI (3.0L)	1997	USA	0G386496-0G589999	REC817275A6	REC807929A1	REC47-43026Q02	REC47-43026Q06	REC817275A1		REC8172761
V-200 DFI (3.0L)	1998	USA	0G590000 +		REC807929A1	REC47-43026Q02	REC47-43026Q06	REC817275A1		REC8172761
V-220 Laser	1987-88	USA	0B117316 +	REC46-96148A8	REC46-8M0077147	REC47-89984T4	REC47-89984Q5	REC46-96148T1	REC48752T	REC324351
V-225 (2.4L) (8)	1980-81	USA	5628028	REC46-96148A8	REC46-96146A6	REC47-89984T4	REC47-89984Q5	REC46-96148T1	REC48752T	REC324351
V-225 (2.4L) (7)	1980-81	USA	5628028	REC46-96148A8	REC46-8M0077147	REC47-89984T4	REC47-89984Q5	REC46-96148T1	REC48752T	REC324351
V-225 (3.0L) Carb. Et EFI	1994-98	USA	0D280813 +		REC807929A1	REC47-43026Q02	REC47-43026Q06	REC817275A1		REC8172761
V-225 DFI	1998	USA	0G590000 +		REC807929A1	REC47-43026Q02	REC47-43026Q06	REC817275A1		REC8172761
V-250 (3.0L) EFI	1995-98	USA	0G129222 +		REC807929A1	REC47-43026Q02	REC47-43026Q06	REC817275A1		REC8172761
MARK 5			574128-786612			REC47-22748				
MARK 6, 6A			888005			REC47-22748				
MARK 50						REC47-89983T				
MARK 55			831021			REC47-89983T				
MARK 55A			1227131			REC47-89983T				
MARK 58 (E)			1139538			REC47-89983T				

MARINER

					KIT	KIT COMPLETO COMPLET SET KIT COMPLETO KIT COMPLET
2A	646		REC646-44352-01			
2B	6A1		REC646-44352-01			
4A	6,00E+000		REC6E0-44352-00			
5C	6,00E+003		REC6E0-44352-00			
6C	6H8		REC6G1-44352-00			
6D	6H6		REC6G1-44352-00			
8A(M)	655	000000-000300	REC662-44352-01			
8A(ML)	655	000000-300101	REC662-44352-01			
8B(M)	677	101	REC662-44352-01			
8B(ML)	677	300101	REC662-44352-01			
8C	6G1		REC6G1-44352-00			
9.9C	682		REC682-44352-01		REC682-W0078-A1	
15A(M)	651	-285	REC662-44352-01			
15A(ML)	651	-3000100	REC662-44352-01			
15C	684		REC682-44352-01		REC682-W0078-A1	
20C(M)	6A9	000101-005810	REC689-44352-02		REC689-W0078-A6	
20C(ML)	6A9	300101-306542	REC689-44352-02		REC689-W0078-A6	
20C(E)	6A9	250101-250819	REC689-44352-02		REC689-W0078-A6	
20C(EL)	6A9	550101-550693	REC689-44352-02		REC689-W0078-A6	
20C(M)	6A9	10112	REC689-44352-02	REC689-W4432-01		REC689-W0078-A6
20C(ML)	6A9	306543	REC689-44352-02	REC689-W4432-01		REC689-W0078-A6
20C(E)	6A9	250820	REC689-44352-02	REC689-W4432-01		REC689-W0078-A6
20C(EL)	6A9	550694	REC689-44352-02	REC689-W4432-01		REC689-W0078-A6
25C(M)	695	000101-014870	REC689-44352-02			REC689-W0078-A6
25C(ML)	695	000000-312185	REC689-44352-02			REC689-W0078-A6
25C(E)	695	000000-252290	REC689-44352-02			REC689-W0078-A6
25C(EL)	695	000000-553575	REC689-44352-02			REC689-W0078-A6
25C(M)	695	14871	REC689-44352-02	REC689-W4432-01		REC689-W0078-A6
25C(ML)	695	312186	REC689-44352-02	REC689-W4432-01		REC689-W0078-A6
25C(E)	695	252291	REC689-44352-02	REC689-W4432-01		REC689-W0078-A6
25C(EL)	695	553576	REC689-44352-02	REC689-W4432-01		REC689-W0078-A6
28	664		REC689-44352-02			
30	689		REC689-44352-02			
30A(M)	689	000366-014805	REC689-44352-02			REC689-W0078-A6
30A(ML)	689	301911-315315	REC689-44352-02			REC689-W0078-A6
30A(E)	689	100251-103275	REC689-44352-02			REC689-W0078-A6
30A(EL)	689	401216-407815	REC689-44352-02			REC689-W0078-A6
30A(M)	689	22059	REC689-44352-02	REC689-W4432-01		REC689-W0078-A6
30A(ML)	689	321377	REC689-44352-02	REC689-W4432-01		REC689-W0078-A6
30A(E)	689	105325	REC689-44352-02	REC689-W4432-01		REC689-W0078-A6
30A(EL)	689	411947	REC689-44352-02	REC689-W4432-01		REC689-W0078-A6
48/48W	670		REC6H3-44352-00	REC663-44322-00	REC663-W0078-01	
55/W55	663		REC6H3-44352-00	REC663-44322-00	REC663-W0078-01	
60	675, 6F0		REC6H3-44352-00	REC663-44322-00	REC663-W0078-01	



ÁNODO ANODE ANODI ANODE

TRIM TAB

ZN	KG (kg)	AL	KG (kg)	OEM
CM34762	0,24	CM34762A	0,09	34762A1



ZN	KG (kg)	OEM	HP
CM17264	0,46	17264T2	60 HP



ZN	KG (kg)	AL	KG (kg)	OEM
CM34127	0,59	CM34127A	0,22	34127T2



ZN	KG (kg)	OEM
CM822157T2	0,48	822157T2



ZN	KG (kg)	OEM
CM42121A2	0,30	42121A2



ZN	KG (kg)	AL	KG (kg)	OEM	HP
CM880653	0,50	CM880653A	0,20	880653	Verado V6



ZN	KG (kg)	OEM	HP
CM942860	0,28	94286T1	25 HP



ZN	KG (kg)	AL	KG (kg)	OEM
CM984325	0,42	CM984325A	0,11	98432Q6



ZN	KG (kg)	AL	KG (kg)	OEM
CM76214	0,28	CM762145A	0,11	76214



ZN	KG (kg)	OEM
CM822777	0,67	822777Q1



ZN	KG (kg)	OEM
CM89026	0,23	89026



ZN	KG (kg)	OEM	HP
CM09411	0,05	09411	4 - 7 HP



ZN	KG (kg)	OEM
CM41106-ZW9-000A	8M0137344	NEW MODELS 10, 15, 20 EFI (OR833820+)

new



ZN	KG (kg)	OEM	HP
CM47820	0,33	47820	20 HP



COLA DRIVE PIEDE EMBASE

ZN	KG (kg)	AL	KG (kg)	OEM
CM826134	0,25	CM826134A	0,10	826134



MERCURY

RECAMBIOS MARINOS

SOPORTE BRACKET SUPPORTO SUPPORT

ZN	KG (kg)	AL	KG (kg)	OEM
CM818298	0,66	CM818298A	0,26	818298A1



ZN	KG (kg)	AL	KG (kg)	OEM
CM43396	0,66	CM43396A	0,25	43396

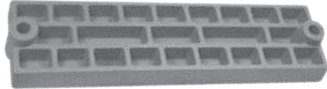

ZN	KG (kg)	AL	KG (kg)	OEM
CM89949	1,07	CM89949A	0,42	89949A1



ZN	KG (kg)	AL	KG (kg)	OEM	
CM825271	0,29	CM825271A	0,11	8252711	25 / 30 / 40 HP 4T/STROKES



ZN	KG (kg)	OEM	
CM8239121	0,91	8239121	50, 75, 90, 100 HP Super America 80, 155 HP

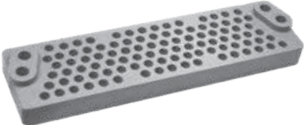

TRIM

ZN	KG (kg)	AL	KG (kg)	OEM	
CM892227	0,50	CM892227A	0,20	893404	Verado V6



ZN	KG (kg)	OEM	
CM6G1-45251-02			6C (6H8), 6D (6H6), 8C (6G1)



new

MOTOR ENGINE MOTORE MOTEUR

ZN	KG (kg)	OEM	
CM820503	0,02	8205031	



ZN	KG (kg)	OEM	
CM826887M	0,33	826887M	



ZN	KG (kg)	OEM	
CM67F-11325-00	0,07	894079002	90 HP 4T/STROKES



KITS

MG	AL		
CMVERADO6KITM	CMVERADO6KITA	8M0126670	VERADO 6 cyl
CMVERADO4KITM	CMVERADO4KITA	97-8M0107550	Verado 4 cyl. / Optimax.



AL			
CMPNCF16A	809664A 1	70HP + NOT 225EFI	new



ÁNODO

ANODE

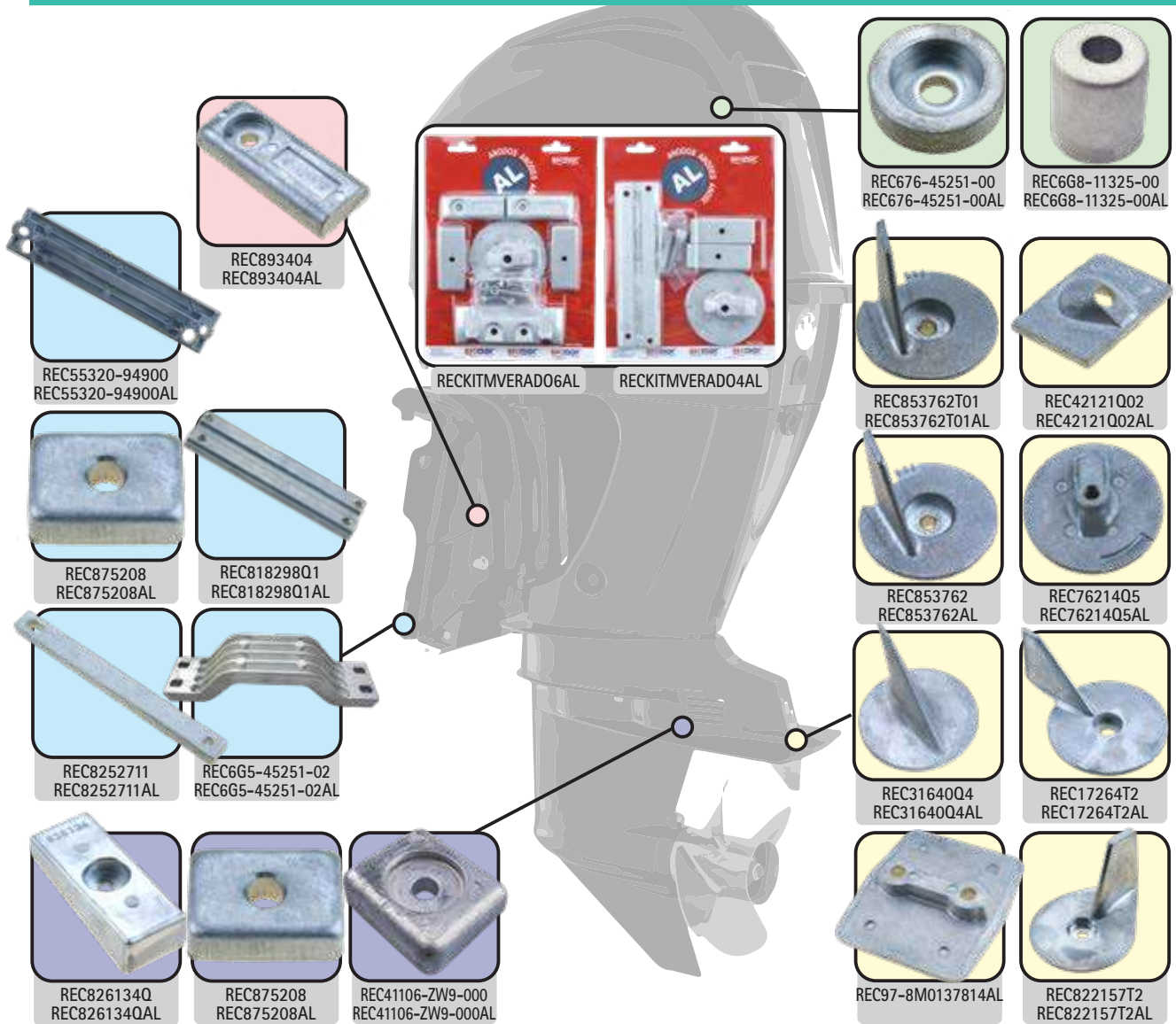

ANODI

ANODE



	MOTOR ENGINE MOTORE MOTEUR	SOPORTE BRACKET SUPPORTO SUPPORT	TRIM	COLA GEAR CASE PIEDE EMBASE	TRIM TAB
4/ 5 / 6 HP (4 STROKE)				REC875208 REC875208AL	
8 - 20HP (4 STROKE)		REC875208 REC875208AL			
6 - 20HP (TOHATSU)					REC853762T01 REC853762T01AL
8/ 9.9/ 13.5/ 15 (4 STROKE) 6/ 8/ 9.9/ 10/ 15 (2 STROKE)					REC42121Q02AL
9.9 / 10 / 15 / 20 EFI				REC41106-ZW9-000 REC41106-ZW9-000AL	
8 Bodensee (4Stroke) international 9.9 (4Stroke) 232cc	REC6G8-11325-00 REC6G8-11325-00AL				REC853762 REC853762AL
25/30/40/50 (Tohatsu) 1.92:1					REC853762 REC853762AL
K40 (6F5)/ 40C (6E9)	REC676-45251-00 REC676-45251-00AL				
75 - 115 (4 STROKE) 135 To 300 Verado 2.5L/ 3.0L (EFI & DFI)				REC826134Q REC826134QAL	REC76214Q5 REC76214Q5AL
30HP +		REC818298Q1 REC818298Q1AL			
35HP +					REC31640Q4 REC31640Q4AL
40 - 75HP					REC17264T2 REC17264T2AL
25/30 EFI 40 / 50.MXL, LIGHTNING		REC55320-94900 REC55320-94900AL			
25/ 30/ 35/ 40/ 50 HP					REC822157T2 REC822157T2AL
25 - 50HP		REC8252711 REC8252711AL			
175 -300 HP V6 (3.4L) VO (4.6L)			REC893404 REC893404AL		REC97-8M0137814AL
225 HP EFI (OT6539945+)		REC6G5-45251-02 REC6G5-45251-02AL			
VERADO 6 CYL/ 4.6 V8			REC893404 REC893404AL		

new

ZN	 (kg)		OEM	2T STROKES	4T STROKES	GROMMET
PAF15-07010008	8, 9.9, 13.5, 15 HP		97-855678 8M0099896	✓	PAF15-07010009	



ÁNODO

ANODE

ANODI

ANODE

ÁNODO TRIM TAB

TRIM TAB ANODE

ANODO TRIM TAB

ANODE TRIM TAB

ZN	 (kg)	OEM	
TEN00808	0,27	34762	



ZN	 (kg)	OEM		25 HP (1990+)
TEN00812	0,35	98432		



ZN	 (kg)	AL	 (kg)	OEM	
TEN00800	0,48	TEN00800AL	31640		50 HP



ZN	 (kg)	AL	 (kg)	OEM	
TEN00829	0,44	TEN00829AL	822157		F25 - F50



ZN	 (kg)	OEM	
TEN00801	0,6	34127	80 - 140 HP



ZN	 (kg)	OEM	
TEN00830	0,68	822777	35 HP, V6 - MCM



ZN	 (kg)	OEM	
TEN00802	0,27	94286	25 HP



ZN	 (kg)	OEM	
TEN00839	0,15	853762	



ZN	 (kg)	OEM	
TEN00804	0,4	46399	50 - 140 HP



ZN	 (kg)	OEM	
TEN00827	0,51	17264	Formula 60 HP



MERCURY MARINER

RECAMBIOS MARINOS

ZN	 (kg)	OEM	
TEN00826	0,31	76214	Verado



ZN	 (kg)	OEM	
TEN00835	0,26	76214-4	





ZN	 (kg)	OEM	
TEN00809	0,03	85824	4.5 - 9 HP



ZN	 (kg)	OEM	
TEN00811	0,05	09411	4.5 - 7 HP



ZN	 (kg)	OEM	
TEN00810	0,03	42121	6 - 9.9 HP



ZN	 (kg)	OEM	
TEN00803	0,31	47820	20 HP



ZN	 (kg)	OEM	
TEN00832	0,49	80653	Verado 215- 275



ÁNODO SOPORTE	BRACKET ANODE	ANODO SUPPORTO	ANODE SUPPORT
---------------	---------------	----------------	---------------

ZN	 (kg)	OEM	
TEN00837	0,33	8M0012083	Verado 350 Cl - 6 cyl 4T/strokes





ZN	 (kg)	OEM	
TEN00840	0,51	8239121	



ZN	 (kg)	AL	 (kg)	OEM	
TEN00816	0,64	TEN00816AL		818298	40 - V6 135, 150, 175 HP Verado.



ZN	 (kg)	OEM	
TEN00805	0,67	46396	25, 50, 60, 75, 80, 90, 100, 115, 190 HP



ZN	 (kg)	OEM	
TEN00821	1,18	89949	150 - 200 HP





ZN	 (kg)	OEM	
TEN00822	0,29	825271	30 - 40 HP



ÁNODO TRIM	TRIM ANODE	ANODO TRIM	ANODE TRIM
------------	------------	------------	------------

ZN	 (kg)	OEM	
TEN00833	0,11	893404	Verado 215- 275 hp



ZN	 (kg)	OEM	
TEN01108			6C (6H8), 6D (6H6), 8C (6G1)



new

ÁNODO COLA		DRIVE ANODE		ANODO PIEDE		ANODE EMBASE	
ZN	 (kg)	AL	 (kg)	OEM			
TEN00825	0,24	TEN00825AL		818298		40 - V6 135, 150, 175 HP Verado.	



MOTOR		ENGINE		MOTORE		MOTEUR	
ZN	 (kg)	OEM		ZN	 (kg)	OEM	
TEN00813	0,01	823912-1	4.5 HP	TEN00823	20 mm	0,01	825271
				TEN00824	24 mm	0,02	823913







ZN	 (kg)	OEM	
TEN00841	0,04	804043	





ZN	 (kg)	OEM	
TEN00838	1	847635001	Verado 350 CI - 6 cyl 4T/Strokes



ZN	 (kg)	AL	 (kg)	OEM
TEN00842	0,858	TEN00842AL		8M0057772



ZN	 (kg)	OEM	
TEN00834	0,03	875208	4T - 4 - 9.9 HP



AL	 (kg)	OEM
TEN00843AL	0,89	879150A65



ZN	 (kg)	OEM
TEN00831	0,02	826887M



PARTES DEL MOTOR ENGINE PARTS

PARTI MOTORE PIECES MOTEUR

DESPIECE MOTOR DE 4
TIEMPOS

ENGINE PARTS
4 STROKES

PARTI MOTORI
4 TEMPI

PIECES MOTEURS 4
TEMPS

4T
STROKES

2, 2.5, 3.5 HP

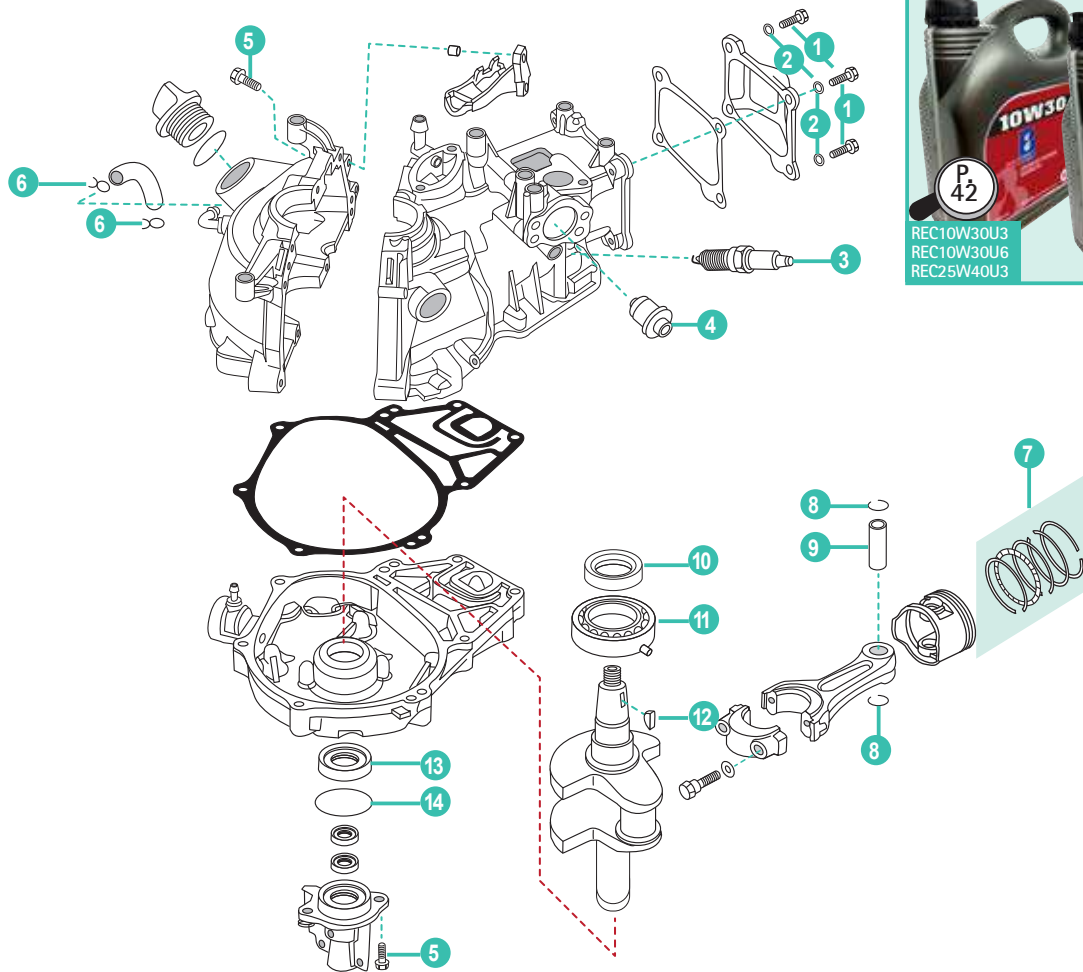

	REF	OEM				UN.	
1	PAGB/T5783-M6X16	16832	TORNILLO	BOLT	VITE	VIS	4
2	PAGB/T848-6	953921	ARANDELA	WASHER	RONDELLA	RONDELLE	4
3	NGKDCPR6E	803507	BUJÍA	SPARK PLUG	CANDELA	BOUGIE	1
4	RM804540	804540	TERMOSTATO	TEHRMOSTAT	TERMOSTATO	THERMOSTAT	1
5	PAGB/T5787-M6X20	167051	TORNILLO	BOLT	VITE	VIS	4
6	PAF4-04000030	95395	CLIP INOX	CLIP SS	CLIP INOSS	CLIPS INOX	2
7	REC39-8M0055809	898103A47	KIT SEGMENTOS	PISTON RING KIT	KIT FASCIA	KIT DE SEGMENTS	1
8	REC53-16057	16057	CLIP	CLIP	CLIP	CLIPS	2
9	PAF8-05020105	825713001	PIN, PISTÓN	PIN, PISTON	SPINOTTO PISTONE	AXE DE PISTON	1
10	REC26-803514	898101285	RETÉN	OIL SEAL	PARAOILIO	JOINT SPI	2
11	REC30-16049	16049	RODAMIENTO	BEARING	CUSCINETTO	ROULEMENT	1
12	PAT3.6-04000006	95229	CHAVETA	KEY WOODRUFF	CHIAVETTA	CLAVETTE	1
13	REC26-803514	898101285	RETÉN	OIL SEAL	PARAOILIO	JOINT SPI	1
14	PAGB/T3452.1-32.5X1.	825057003	TÓRICA	O-RING	O-RING	JOINT TORIQUE	1

MERCURY

RECAMBIOS
MARINOS

4T 4, 5, 6 HP
STROKES

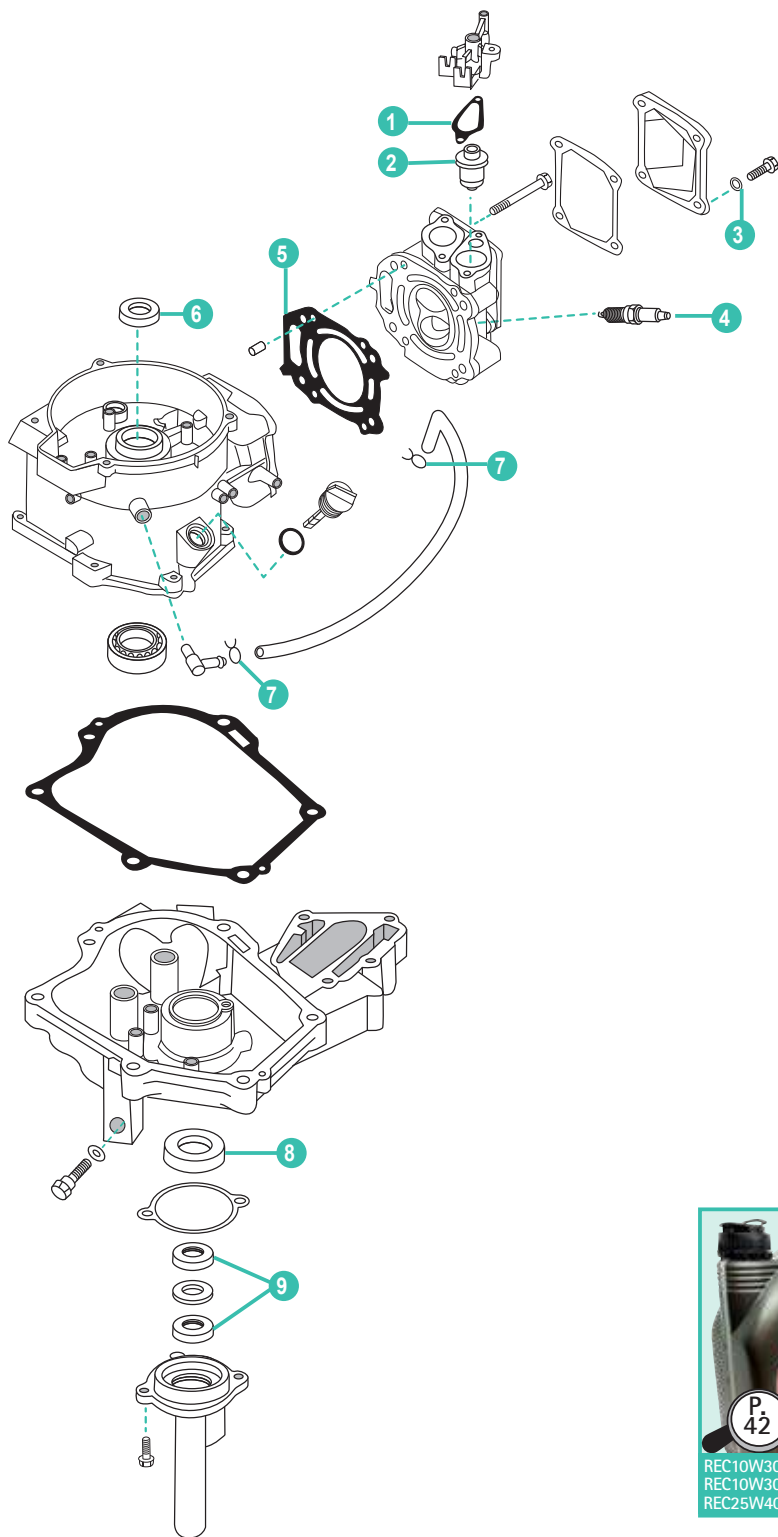

	REF	OEM					UN.
1	PAF8-05010005	27-853702	JUNTA	GASKET	GUARNIZIONE	JOINT DE THERMOSTAT	1
2	RM804540	804540	TERMOSTATO	TEHRMOSTAT	TERMOSTATO	THERMOSTAT	1
3	PAGB/T848-6	12-953921	ARANDELA	WASHER	RONDELLA	RONDELLE	4
4	NGKDCPR6E	33-803507	BUJÍA	SPARK PLUG	CANDELA	BOUGIE	1
5	REC27-803508	803508	JUNTA	GASKET	GUARNIZIONE	JOINT DE CULASSE	1
6	REC26-803514	26-803514	RETÉN	OIL SEAL	PARAOLIO	JOINT SPI	1
7	PAF4-04000030	54-952245	CLIP	CLIP	CLIP	CLIPS	2
8	REC26-8537077	26-8537077	RETÉN	OIL SEAL	PARAOLIO	JOINT SPI	1
9	REC26-16703	26-16703	RETÉN	OIL SEAL	PARAOLIO	JOINT SPI	2

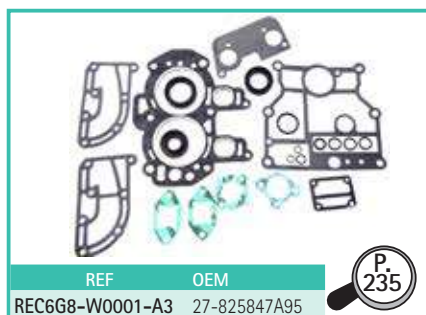
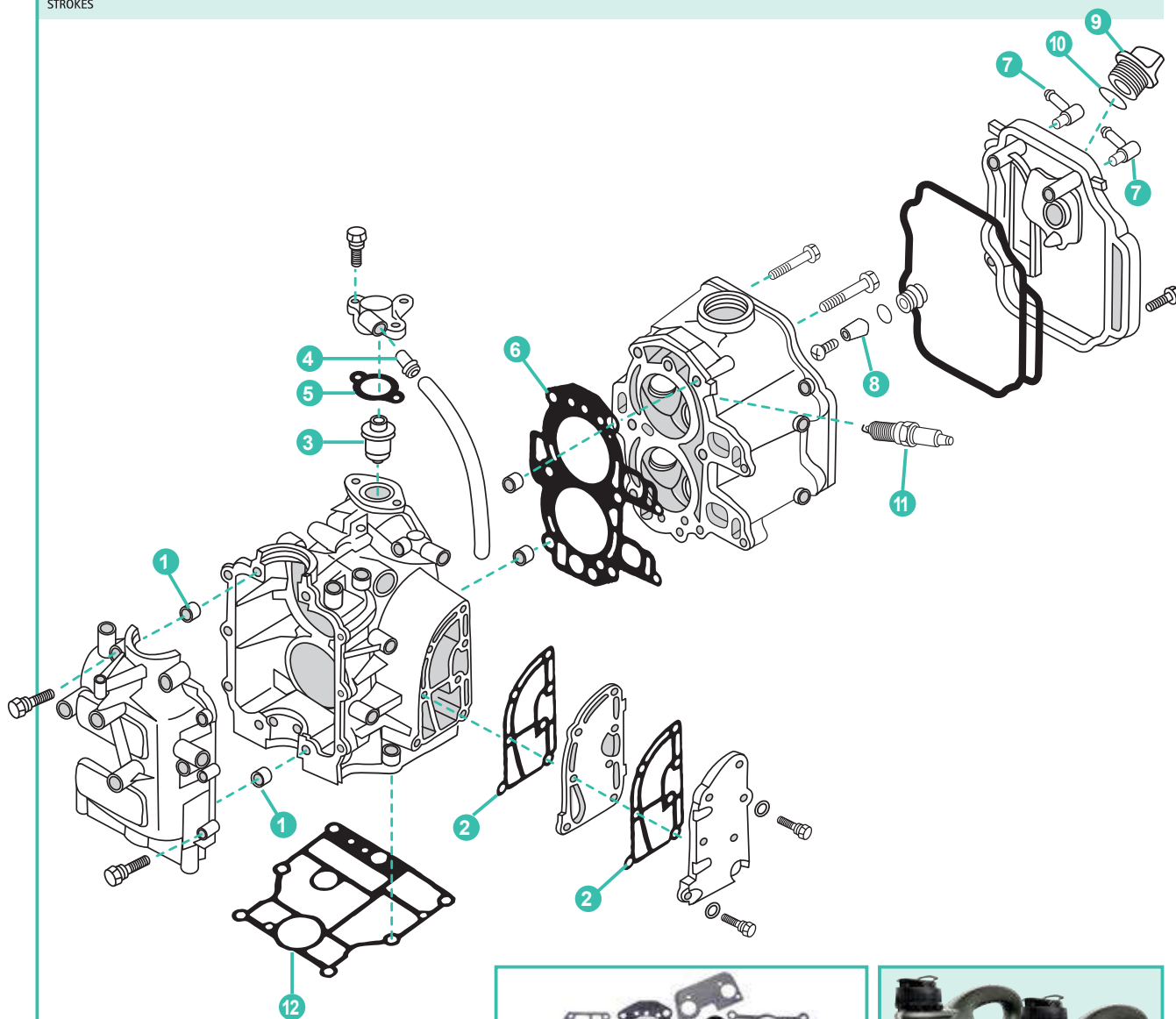

REF	OEM
REC6G8-W0001-A3	27-825847A95



P. 42
 REC10W30U3
 REC10W30U6
 REC25W40U3

	REF	OEM				UN.	
1	PAF15-07000001	17-825689	PIN	PIN	PIN	PIN	2
2	REC6G8-41112-02	27-825693	JUNTA	GASKET	GUARNIZIONE	JOINT	2
3	REC6AH-12411-00	825212T02	TERMOSTATO	THERMOSTAT	TERMOSTATO	THERMOSTAT	1
4	PAF15-07010006	88305914	PIPA DE AGUA	PIPE, WATER	TUBO	RACCORD TUYAU D'EAU	1
5	REC6G8-12414-A0	27-825701	JUNTA TAPA TERMOSTATO	GASKET, THERMOSTAT COVER	GUARNIZIONE COPERCHIO TERMOSTATO	JOINT COUVERCLE DE THERMOSTAT	1
6	REC6G8-11181-A1	27-8254821	JUNTA CULATA	GASKET, CYLINDER HEAD	GUARNIZIONE TESTATA	JOINT DE CULASSE	1
7	PAF15-04000005	22-83326M	NIPLE	HOSE NIPLE	TUBO	TUYAU	2
8	CM6G8-11325-00	825435	ÁNODO	ANODE	ANODO	ANODE	1
9	PAF15-07050004	859578A1	TAPÓN ACEITE	PLUG, OIL	TAPPO OLIO	BOUCHON REMPLISSAGE D'HUILE	1
10	PAJASOF40431-025	25-8M0052669	TÓRICA	O-RING	O-RING	JOINT TORIQUE	1
11	NGKCR6HS	33-827859	BUJÍA	SPARK PLUG	CANDELA	BOUGIE	2
12	REC6G8-11351-A0	27-825847	JUNTA BASE MOTOR	GASKET ENGINE	GUARNIZIONE BASE MOTOR	JOINT DE TETE MOTRICE	1

4T 8 HP • 9.9 HP (209 CC) (0P325500+)

STROKES



REC10W30U3
REC10W30U6
REC25W40U3

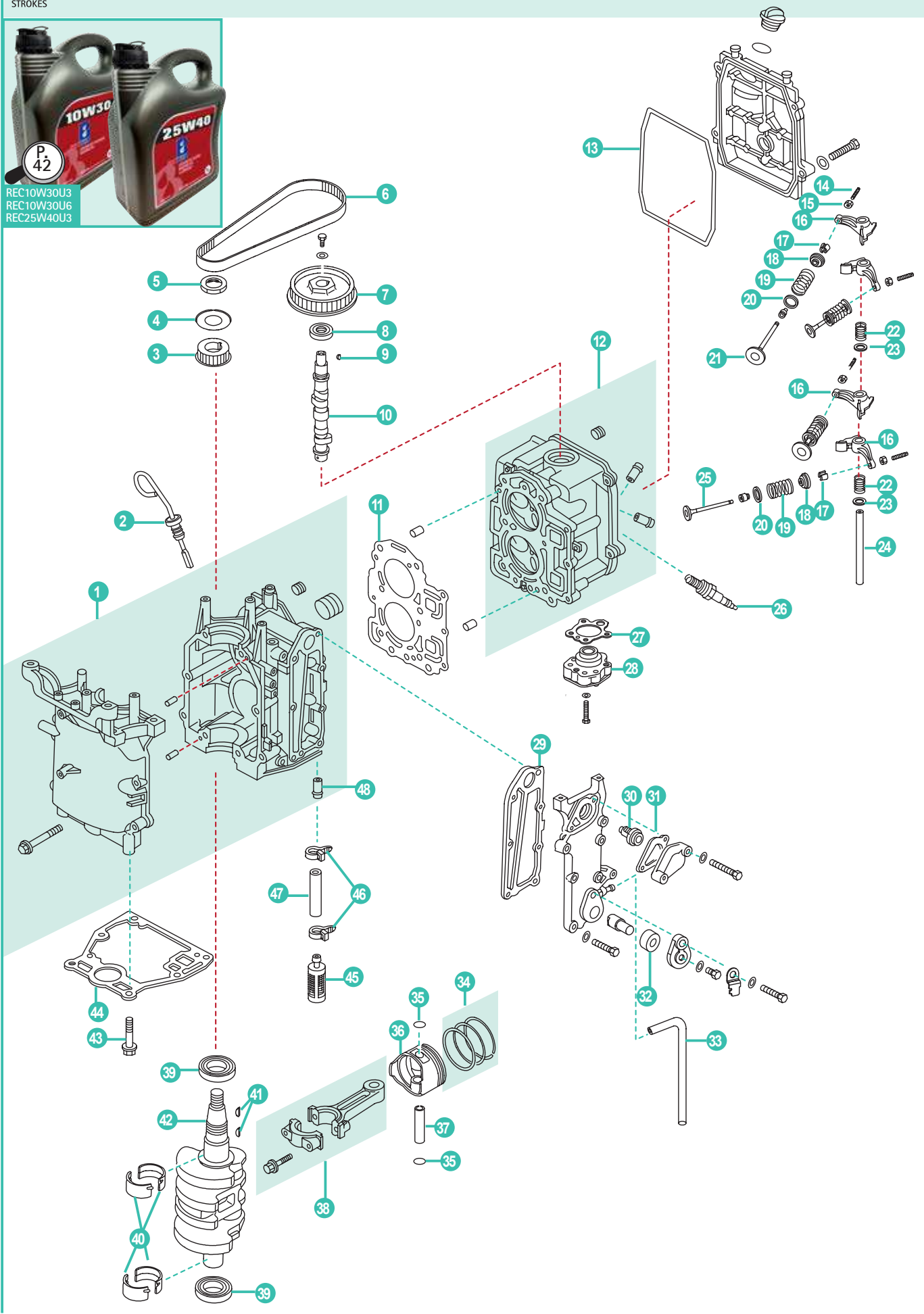

	REF	OEM				UN.	
1	PAF8-05010000	878-815013T06	BLOQUE COMPLETO	CRANKCASSE ASSY	BLOCCO MOTORE	BLOC COMPLET	1
2	PAF8-00000200	803512001	MEDIDOR NIVEL ACEITE	OIL LEVEL GAUGE	MISURATORE LIVELLO OLIO	JAUGE D'HUILE	1
3	PAF8-05010014	43-834955001	POLEA	DRIVER PULLEY	PULEGGIA	POULIE	1
4	PAF8-05010015	895119	ARANDELA	WASHER	RONDELLA	RONDELLE	1
5	PAF8-05010016	11-855679001	TUERCA	NUT	DADO	ÉCROU	1
6	PAF8-05000004	57-895120	CORREA	TIMING BELT	CINGHIA DI DISTRIBUZIONE	COURROIE DE DISTRIBUTION	1
7	PAF8-05030400	43-834973001	POLEA	DRIVER PULLEY	PULEGGIA	POULIE	1
8	PAF8-05030011	26-825455001	RETÉN	OIL SEAL	PARAOLIO	JOINT SPI	1
9	PAT3.6-04000006	28-95229	CHAVETA	KEY WOODRUFF	CHIAVETTA	CLAVETTE	1
10	PAF8-05030008	834956005	ÁRBOL DE LEVAS	CAMSHAFT ASSY	ALBERO A CAMME	ARBRE À CAMES	1
11	PAF8-05000100	27-850836001	JUNTA CULATA	CYLINDER HEAD GASKET	GUARNIZIONE TESTATA	JOINT DE CULASSE	1
12	PAF8-05030100	900-835430T03	CULATA	CYLINDER HEAD ASSY	TESTATA	CULASSE	1
13	PAF8-05000002	27-803508017	JUNTA TAPA CULATA	CYLINDER HEAD COVER GASKET	GUARNIZIONE COPERCHIO TESTATA	JOINT CACHE CULBUTEUR	1
14	PAF15-07040303	10-825046001	TORNILLO AJUSTE	SCREW, VALVE ADJUSTING	VITE, REGOLATORE	VIS POINTEAU	4
15	PAF15-07040304	11-826150001	TUERCA	LOCK NUT	GHIERA	ÉCROU	4
16	PAF8-05030200	850841002	BALANCIÓN	ROCKER	BILANCIERE	CULBUTEUR	4
17	PAF8-05030007	28-803556	SEGURO	COTTER, VALVE	CHIUSURA DI SICUREZZA	CLAVETTE DE SOUPAPE	8
18	PAF8-05030006	822650001	RETÉN MUELLE DE VÁLVULA	RETAINER, VALVE SPRINGER	VALVOLA DI RITEGNO	COUPELLE RESSORT DE SOUPAPE	4
19	PAF8-05030005	24-803554005	MUELLE VÁLVULA	SPRING VALVE	VALVOLA MOLLA	RESSORT	4
20	PAF8-05030004	855959001	SELLO MUELLE VÁLVULA	SEAL, VALVE SPRING	SIGILLO MOLLA	JOINT RESSORT DE SOUPAPE	4
21	PAF8-05030001	850838T01	VÁLVULA ADMISIÓN	VALVE INTAKE	VALVOLA ASPIRAZIONE	SOUPAPE D'ADMISSION	2
22	PAF8-05030009	24-825452001	MUELLE	SPRING ROCKER	MOLLA	RESSORT	4
23	PAF8-05030015	12-895118001	ARANDELA	WASHER	RONDELLA	RONDELLE	2
24	PAF8-005030010	850842001	EJE	SHAFT ROCKER	ASSE	AXE DE CULBUTEUR	1
25	PAF8-05030002	850839T01	VÁLVULA ESCAPE	VALVE EXHAUST	VALVOLA SCARICO	SOUPAPE D'ÉCHAPPEMENT	2
26	NGKDCPR6E	33-803507	BUJÍA	SPARK PLUG	CANDELA	BOUGIE	1
27	PAF8-05030012	27-853523001	JUNTA BOMBA ACEITE	OIL PUMP GASKET	GUARNIZIONE POMPA OLIO	JOINT DE POMPE À HUILE	1
28	PAF8-05030300	834967T03	BOMBA ACEITE	OIL PUMP	POMPA OLIO	POMPE À HUILE	1
29	PAF8-05010004	27-834952001	JUNTA ESCAPE	GASKET, EXHAUST COVER	GUARNIZIONE SCARICO	JOINT ÉCHAPPEMENT	1
30	REC855676002	855676002	TERMOSTATO	THERMOSTAT	TERMOSTATO	THERMOSTAT	1
31	PAF8-05010005	27-853702005	JUNTA TERMOSTATO	GASKET, THERMOSTAT	GUARNIZIONE TERMOSTATO	JOINT DE THERMOSTAT	1
32	TEN00813	97-823912	ÁNODO	ANODE	ANODO	ANODE	1
33	PAF8-05000024	35-851848003	TUBO	WATER PIPE	TUBO	TUYAU	1
34	REC39-8M0055809	39-8M0055809	KIT SEGMENTOS	PISTON RING KIT	KIT FASCIA	KIT DE SEGMENTS	1
35	PAF15-07020005	53-16057	CLIP	CLIP	CLIP	CLIPS	4
36	PAF8-05020101	700-834963A02	PISTÓN	PISTON	PISTONE	PISTON	2
37	PAF8-05020105	41-825713001	PIN, PISTÓN	PIN, PISTON	SPINOTTO PISTONE	AXE DE PISTON	
38	PAF8-05020200	600-834961002	BIELA	CONNENCTING ROD	BIELLA	BIELLE	2
39	PAF8-05010012	26-855681001	RETÉN	OIL SEAL	PARAOLIO	JOINT SPI	2
40	PAF8-05010009	31-834960T08	COJINETE DE BANCADA	BUSH	BRONZINA	BAGUE	4
41	PAF4-04000019	28-825666001	CHAVETA	KEY WOODRUFF	CHIAVETTA	CLAVETTE	2
42	PAF8-05020001	400-834957T01	CIGÜEÑAL	CRANK	ALBERO MOTORE	VILEBREQUIN	1
43	PAF8-00000003	10-89514001	TRONILLO M8X35	BOLT M8X35	VITE M8X35	VIS M8X35	6
44	PAF8-00000004	27-835427003	JUNTA BASE MOTOR	GSKET ENGINE BASEMENT	GUARNIZIONE BASE MOTORE	JOINT BASE DE MOTEUR	1
45	PAF8-05000800	35-895152002	FILTRO ACEITE	OIL FILTER	FILTRO OLIO	FILTRE A HUILE	1
46	PAF8-05000025	54-816311T	CLIP	HOOP	CLIP	CLIPS POUR DURITE D'HUILE	2
47	PAF8-05000017	32-895153	MANAGUERA	HOSE	TUBO	TUYAU	1
48	PAF8-05010002	22-822644001	RACOR	NIPPLE	RACCORDO	TETINE	1

4T 8 (BONDESEE) (INT.) (OP086824 - OP4000999) • 9.9 (323 CC) (OP075166 - OP400999)
 13.5 (INT.) (OP134638+) • 15 (9973100+)

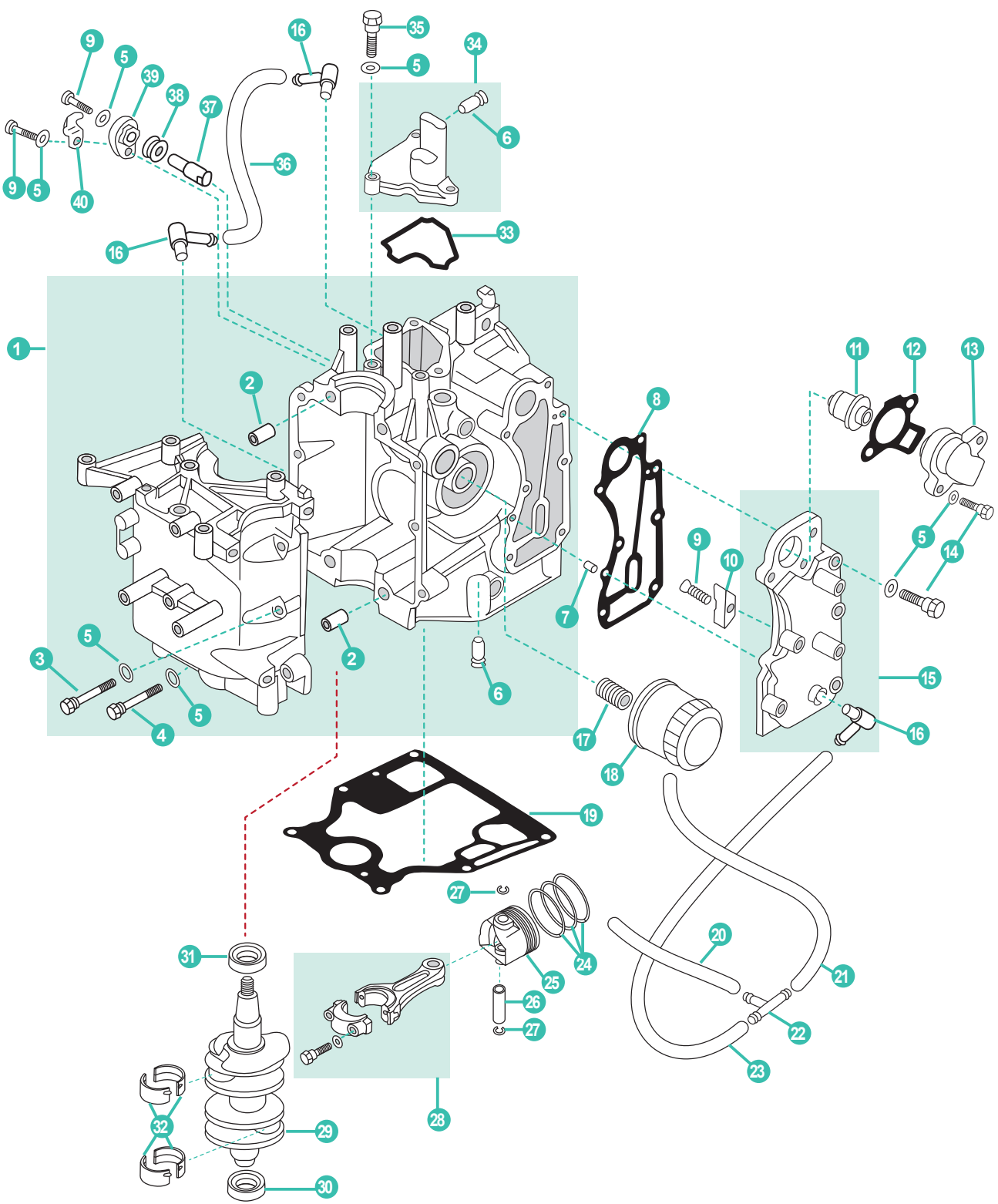

REF	OEM
REC66M-W0001-01	27-835427A00



REC10W30U3
 REC10W30U6
 REC25W40U3

	REF	OEM				UN.	
1	PAF15-07010000	8M0055024	BLOQUE MOTOR COMPLETO	CRANKCASE ASSY	BLOCCO MOTORE COMPLETO	CARTER BLOC MOTEUR	1
2	PAF15-07000001	17-825689	PIN CENTRADOR	HOLLOW PIN	SPINOTTO DI CENTRAGGIO	PIN DE CENTRAGE	2
3	PAGB/T5783-M5X12	10-43092M	TORNILLO	BOLT	VITE	VIS	6
4	PAGB/T5783-M5X12	10-41884M	TORNILLO	BOLT	VITE	VIS	4
5	PAGB/T97.1-8		ARANDELA	WASHER	RONDELLA	RONDELLE	22
6	PAF15-07010006	22-822644	PIPA DE AGUA	PIPE, WATER	TUBO	RACCORD TUYAU D'EAU	2
7	PAF15-07000013		PIN	OPIN	SPINOTTO	LEVIER D'ENTRAINEMENT	2
8	PAF15-07010018	27-834952002	JUNTA EXTERIOR, TAPA DE ESCAPE	GASKET, EXHAUST OUTER COVER	GUARNIZIONE ESTERIORE, COPERCHIO SCARICO	JOINT COUVERCLE EXT ECHAPPEMENT	1
9	PAGB/T5783-M5X12		TORNILLO	SCREW	VITE	VIS	1
10	PAF15-07010026		ÁNODO	ANODE	ANODO	ANODE	1
11	PAF15-07000031	855676003	TERMOSTATO	THERMOSTAT	TERMOSTATO	THERMOSTAT	1
12	PAF15-07010022	27-824853	JUNTA TAPA TERMOSTATO	GASKET, THERMOSTAT COVER	GUARNIZIONE COPERCHIO TERMOSTATO	JOINT COUVERCLE DE THERMOSTAT	1
13	PAF15-07010021	8250311	TAPA TERMOSTATO	COVER, THERMOSTAT	COPERCHIO TERMOSTATO	COUVERCLE DE THERMOSTAT	1
14	PAGB/T5783-M5X12	10-82500930	TORNILLO	SCREW	VITE	VIS	7
15	PAF15-07010019	834953T02	TAPA ESCAPE COMPLETA	OUTTER COVER, EXHAUST	COPERCHIO SCARICO COMPLETA	COUVERCLE ECHAPPEMENT EXTERIEUR	1
16	PAF15-04000005		NIPLE DE MANGUERA	NIPPLE	TUBO	RACCORD D'EAU	3
17	PAF15-07010003	822625	TORNILLO	BOLT	VITE	VIS	1
18	PAF15-07010023	35-822626Q03	FILTRO ACEITE	OIL FILTER	FILTRO DELL'OLIO	FILTRE À HUILE	1
	REC5GH-13440-00	35-822626Q03	FILTRO ACEITE	OIL FILTER	FILTRO DELL'OLIO	FILTRE À HUILE	1
19	PAF15-00000014	27-8354272	JUNTA BASE MOTOR	GASKET ENGINE	GUARNIZIONE BASE MOTORE	JOINT DE TETE MOTRICE	1
20	PAF15-05000013		TUBO B	HOSE B	TUBO B	DURITE D'EAU B	1
21	PAF15-05000014		TUBO C	HOSE C	TUBO C	DURITE D'EAU C	1
22	PAF15-05000011		CONECTOR DE 3 VÍAS	THREE-WAY PIPE	CONNETTORE T	RACCORD EN TE	1
23	PAF15-05000012		TUBO A	HOSE A	TUBO A	DURITE D'EAU A	1
24	REC66N-11603-00	850846+ 850847+ 825839	KIT SEGMENTOS DE PISTÓN	PISTON RING KIT	KIT FASCIA PISTONE	KIT DE SEGMENTS	2
25	PAF15-07020001	700-834963	PISTÓN	PISTON	PISTONE	PISTON	2
26	PAF15-07020006	41-825713	BULÓN	PIN, PISTON	BULLONE	AXE DE PISTON	2
27	PAF15-07020005	53-82343M	CIRCLIP	CIRCLIP	CIRCLIP	CIRCLIP	4
28	PAF15-07020100	600-834961A1	BIELA	ROD, CONNECTING	BIELLA	BIELLE	2
29	PAF15-07030000	400-834957	CIGÜEÑAL	CRANK ASSY	ALBERO MOTORE	VILEBREQUIN	1
30	PAF15-07030007	26-855681	RETÉN DE ACEITE	OIL SEAL	PARAOLIO	JOINT SPI	1
31	PAF15-07030006	26-855680	RETÉN DE ACEITE	OIL SEAL	PARAOLIO	JOINT SPI	1
32	PAF15-07010024	31-834960	COJINETE BANCADA	MAIN BEARING	CUSCINETTO	PALIER DE VILEBREQUIN	4
33	PAF15-07010014	26-850850	JUNTA TAPA	GASKET, COVER	GAURNIZIONE COPERCHIO	JOINT COUVERCLE	1
34	PAF15-07010200	834974	TAPA	COVER, BREATHER	COPERCHIO	COUVERCLE	1
35	PAGB/T5783-M5X12	10-855778	TORNILLO	BOLT	VITE	VIS	1
36	PAF15-07010007		TUBO	HOSE, RETURN OIL	TUBO	TUYAU	1
37	PAF15-07010008	855678	ÁNODO	ANODE	ANODO	ANODE	1
38	PAF15-07010009	27-825040	ALOJAMIENTO ÁNODO	GROMMET, ANODE	ALLOGGIAMENTO ANODO	JOINT D'ANODE	1
39	PAF15-07010011	855776	TAPA ÁNODO	COVER, ANODE	COPERTURA ANODO	COUVERCLE D'ANODE	1
40	PAF15-07010012	855779	EMPAQUETADORA DE ÁNODO	PLATE, ANODE	PIASTRA ANODO	PLAQUE D'ANODE	1

	REF	OEM				UN.	
1	PAF15-07000024	85691	TAPA	COVER, DUST	COPERCHIO	COUVERCLE	1
2	PAF15-07050003	25-8527681	GOMA	RING RUBBER A	GOMMINO	BAGUE DE COUVERCLE	2
3	REC66M-46241-00	835392	CORREA DISTRIBUCIÓN	BELT TIMING	CINGHIA DISTRIBUZIONE	COURROIE DISTRIBUTION	1
4	PAGB/T5783-M5X12	10-826957M	TORNILLO	BOLT	VITE	VIS	1
5	PAGB/T5287-6	12-825498	ARANDELA	BIG WASHER	RONDELLA	RONDELLE	1
6	PAF15-07040018	43-834973	POLEA DE CORREA	BELT PULLEY, DRIVEN	PULEGGIA	POULIE DE COURROIE	1
7	PAF15-07040017	12-82710M	ARANDELA	WASHER	RONDELLA	RONDELLE	1
8	PAF15-07040008	26-825455	RETÉN DE ACEITE	OIL SEAL	PARAOLIO	JOINT SPI	1
9	PAGB/T1099-3X5X13	28-825666	CHAVETA	KEY, WOODRUFF	CHIAVETTA	CLAVETTE	2
10	PAF15-07040200	834956	ÁRBOL DE LEVAS	CAMSHAFT ASSY	ALBERO A CAMME	ARBRE À CAMES	1
11	PAF15-07040016	27-853523	JUNTA	MAF, AIRPROOF	GUARNIZIONE	JOINT	1
12	PAF15-07040500	834967A1	BOMBA ACEITE	OIL PUMP ASSY	POMPA DELL'OLIO	POMPE À HUILE	1
13	PAGB/T97.1-8		ARANDELA	WASHER	RONDELLA	RONDELLE	3
14	PAGB/T5783-M5X12	10-850879	TORNILLO	BOLT	VITE	VIS	3
15	PAF15-07030005	1-855679	TUERCA	NUT	GHIERA	ÉCROU	1
16	PAF15-07030004	12-850843	ARANDELA	WASHER	RONDELLA	RONDELLE	1
17	PAF15-07030003	43-834955	POLEA DENTADA	BELT PULLEY, TIMING	PULEGGIA	POULIE	1
18	PAF15-07010027	25-855690	GOMA	RUBBER RING	GOMMINO	BAGUE DE COUVERCLE	1
19	PAF15-07000100	27-850836	JUNTA CULATA	GASKET, CYLINDER HEAD	GUARNIZIONE TESTATA	JOINT DE CULASSE	1
20	PAF15-07000001	17-825689	PIN CENTRADOR	HOLLOW PIN	SPINOTTO DI CENTRAGGIO	PIN DE CENTRAGE	2
21	PAF15-07040000	900-835430A1	CULATA	CYLINDER HEAD ASSY	TESTATA	CULASSE	1
22	PAGB/T97.1-6		ARANDELA	WASHER	RONDELLA	RONDELLE	3
23	PAGB/T5783-M6X25	10-82500925	TORNILLO	BOLT	VITE	VIS	3
24	NGKDPR7EA-9	33-827858	BUJÍA	SPARK PLUG	CANDELA	BOUGIE	2
25	PAF15-07000028	10-855677	TORNILLO	BOLT	VITE	VIS	6
26	PAF15-07050002	850837	JUNTA TAPA	SEAL, CYLINDER COVER	GAURNIZIONE COPERCHIO	JOINT COUVERCLE	1
27	PAF15-07050001	834954	TAPA BALANCINES	COVER, CYLINDER HEAD	COPERCHIO PUNTERIE	CACHE CULBUTEUR	1
28	PAGB/T97.1-6		ARANDELA	WASHER, PLATE	RONDELLA	RONDELLE	7
29	PAGB/T5783-M6X20	825702	TORNILLO	BOLT	VITE	VIS	4
30	PAF4-04000008	25-825492	TÓRICA	O-RING	O-RING	JOINT TORIQUE	1
31	PAF15-07050004	825490	TAPÓN ACEITE	PLUG, OIL	TAPPO OLIO	BOUCHON REMPLISSAGE D'HUILE	1
32	PAF15-10030001		ADHESIVO 4	MARK 4	ADESIVO 4	AUTOCOLLANT 4	1
33	PAF15-07040001	850838	VÁLVULA ADMISIÓN	VALVE, INTAKE	VALVOLA ASPIRAZIONE	SOUPAPE D ADMISSION	2
34	PAF15-07040002	850839	VÁLVULA ESCAPE	VALVE, EXHAUST	VALVOLA SCARICO	SOUPAPE D'ÉCHAPPEMENT	2
35	PAF15-07040004	855959	ARANDELA DE ASIENTO	SEAT, VALVE SPRING	RONDELLA BASAMENTO	SIEGE RESSORT DE SOUPAPE	4
36	PAPS2700.04.03	26-822647	RETÉN	SEAL, VALVESTEM	GUARNIZIONE	JOINT SPI	4
37	PAF15-07040005	24-850840	MUELLE	SPRING, VALVE	MOLLA	RESSORT	4
38	PAF15-07050006	822650	RETÉN RESORTE	SPRING, VALVE RETAINER	VALVOLA DI RITEGNO	JOINT DE RESSORT	4
39	PAF15-07040007	28-822651	SEGURO DE VÁLVULA	CLAMP, VALVE	BLOCCAGGIO DI VALVOLA	CLAVETTE DE SOUPAPE	8
40	PAF15-07040304	11-826150	TUERCA	LOCK NUT	DADO	ÉCROU	4
41	PAF15-07040303	10-825046	TORNILLO REGULADOR	SCREW, VALVE ADJUSTING	VITE REGOLATORE	VIS POINTEAU	4
42	PAF15-07040301	825451	BALANCÍN	VALVE ROCKER	BILANCIERE	CULBUTEUR	4
43	PAF15-07040014	24-825452	MUELLE	SPRING, ROCKER	MOLLA	RESSORT	3
44	PAF15-07040009	880135	CASQUILLO	BUSHER	GOMMINO	DOUILLE	1
45	PAF15-07040013	24-825453	MUELLE	SPRING, ROCKER A	MOLLA	RESSORT	1
46	PAF15-07040015	850842	EJE DE BALANCÍN	SHAFT, ROCKER	ASSE BILANCERE	AXE DE CULBUTEUR	2
47	PAF15-07040012	825451	CASQUILLO B	BUSHER B	GOMMINO B	BAGUE B	1
48	PAF15-07040011	880134	CASQUILLO A	BUSHER A	GOMMINO A	BAGUE A	1
49	PAF15-07000000	802733A98	MOTOR COMPLETO	POWER HEAD COMPLETE	MOTORE COMPLETO	MOTEUR COMPLET	1

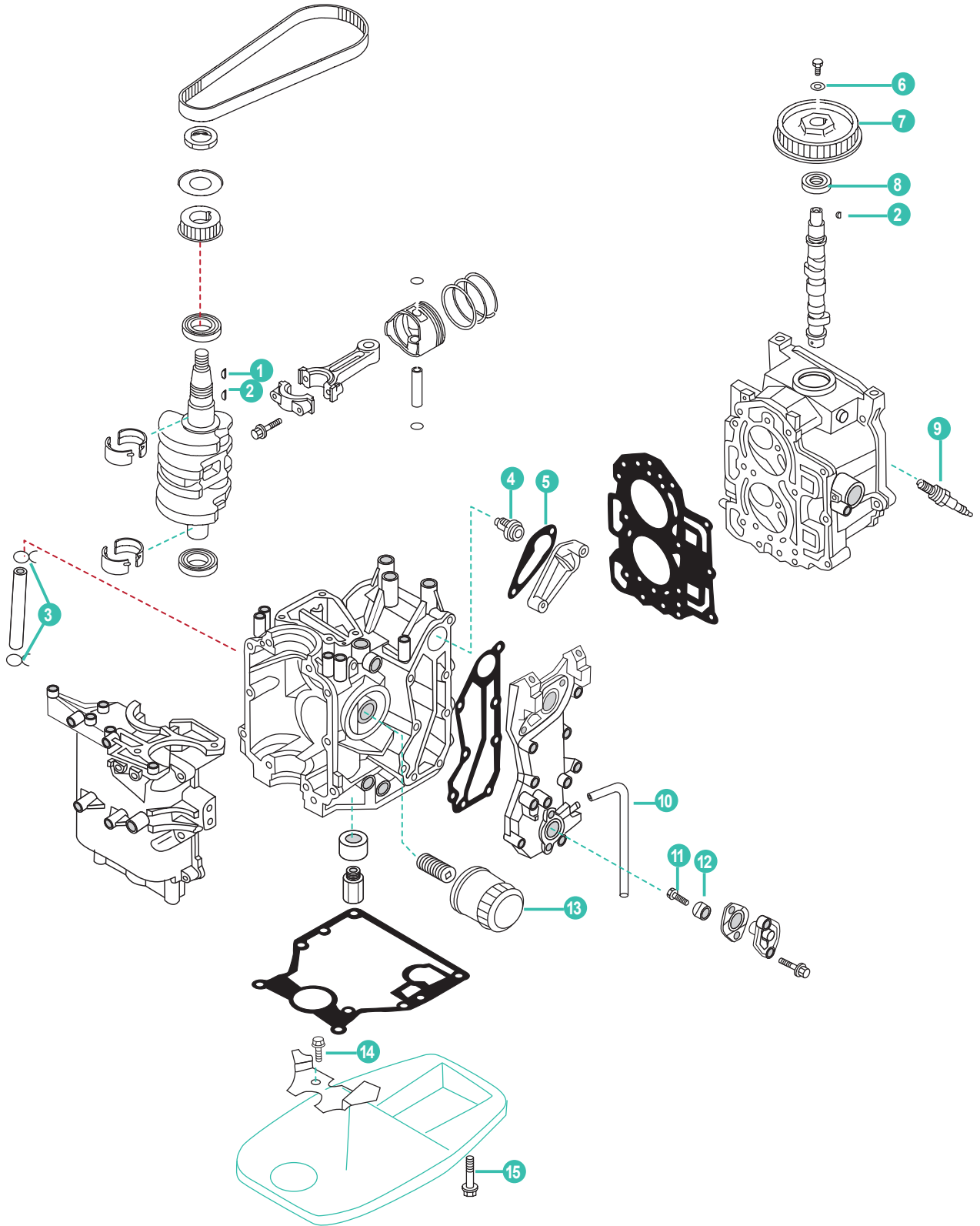

	REF	OEM					UN.
1	PAF4-04000019	825666001	CHAVETA	KEY, MAGNETO	CIAVETTA	CLAVETTE	1
2	PAT3.6-04000006	95229	CHAVETA	KEY, DRIVE PULLEY	CIAVETTA	CLAVETTE	1
3	PAF4-04000030	95395	MUELLE TUBO COMBUSTIBLE	SPRING, FUEL PIPE	MOLLA TUBO COMBUSTIBILE	RESSORT, TUYAU DE CARBURANT	2
4	REC855676002	855676002	TERMOSTATO 60°	THERMOSTAT 60°	TERMOSTATO 60°	THERMOSTAT 60°	1
5	PAF8-05010005	853702005	JUNTA TERMOSTATO	THERMOSTAT GASKET	GUARNIZIONE TERMOSTATO	JOINT DE THERMOSTAT	1
6	PAF8-05030015	895118	ARANDELA	WASHER	RONDELLA	RONDELLE	1
7	PAF8-05030400	834973001	POLEA DE CORREA	DRIVER PULLEY	PULEGGIA	POULIE	1
8	PAF8-05030011	825455001	RETÉN ACEITE	OIL SEAL	PARAOLIO	JOINT SPI	1
9	NGKDCPR6E	803507	BUJÍA	SPARK PLUG	CANDELA	BOUGIE	1
10	PAF8-05000024	851848003	MANGUERA	HOSE	TUBO	TUYAU	1
11	PAGB/T5783-M6X16	16832	TORNILLO M6X16	BOLT M6X16	VITE M6X16	VIS M6X16	1
12	TEN00823	823912	ÁNODO	ANODE	ANODO	ANODE	1
13	REC35-822626Q03	822626K03	FILTRO ACEITE	OIL FILTER	FILTRO OLIO	FILTRE À HUILE	1
14	PAGB/T5783-M6X12	8230427	TORNILLO M6X12	BOLT M6X12	VITE M6X12	VIS M6X12	1
15	PAGB/T5783-M8X35	879194192	TORNILLO M8X35	BOLT M8X35	VITE M8X35	VIS M8X35	1



4T 25 HP (9973100+)
STROKES

P 101

REF	OEM
REC8542561	

P 235

REF	OEM
REC65W-W0001-00	

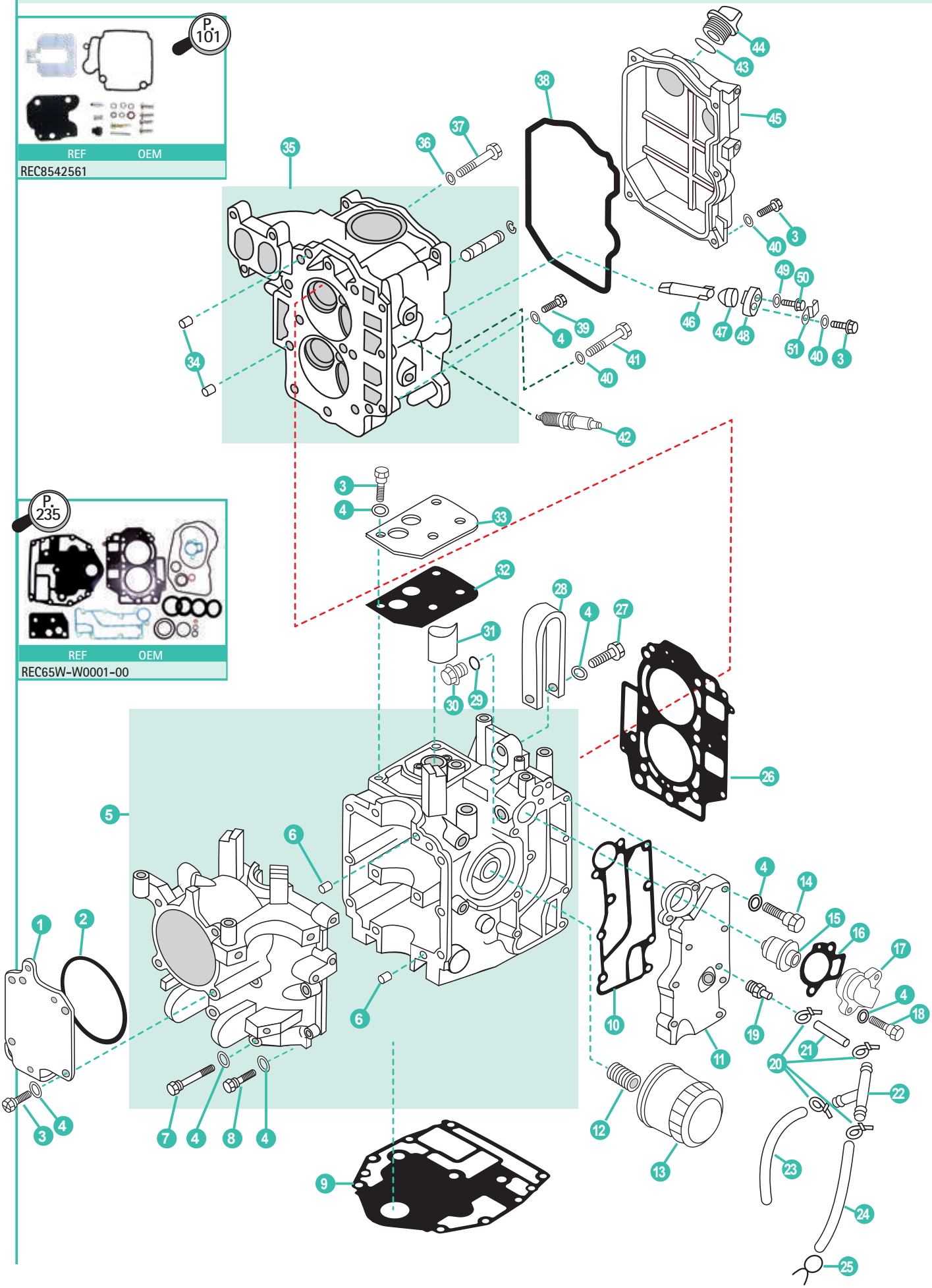

	REF	OEM				UN.	
1	PAF25-05000007	8556692	TAPA	COVER	COPERCHIO	COUVERCLE	1
2	PAGBT3452.1-97.5X1.8	25-854722	JUNTA	SEAL	GUARNIZIONE	JOINT	1
3	PAGB/T5783-M6X20	10-40011128	TORNILLO M6X20	BOLT M6X20	VITE M6X20	VIS M6X20	15
4	PAGB/T97.1-8		ARANDELA	WASHER 6	RONDELLA	RONDELLE	34
5	PAF25-05010000	2806-0830267T3	BLOQUE MOTOR COMPLETO	CRANKCASE ASSY	BLOCCO MOTORE COMPLETO	CARTER BLOC MOTEUR	1
6	PAF25-00000014	17-825010	PIN CENTRADOR	HOLLOW PIN	SPINOTTO DI CENTRAGGIO	PIN DE CENTRAGE	2
7	PAGB/T5782-M8X80	10-82506182	TORNILLO M8X80	BOLT M8X80	VITE M8X80	VIS M8X80	6
8	PAGB/T5782-M6X35	10-88348935	TORNILLO M6X35	BOLT M6X35	VITE M6X35	VIS M6X35	6
9	PAF25-00000013	27-8252310	JUNTA BASE MOTOR	GASKET ENGINE	GUARNIZIONE BASE MOTORE	JOINT DE TETE MOTRICE	1
10	PAF25-05010111	27-830298	JUNTA EXTERIOR, TAPA DE ESCAPE	GASKET, EXHAUST OUTER COVER	GUARNIZIONE ESTERIORE, COPERCHIO SCARICO	JOINT DE COUVERCLE EXT ECHAPPEMENT	1
11	PAF25-05010112	883336T1	TAPA EXTERIOR DE ESCAPE	OUTTER COVER, EXHAUST	COPERCHIO SCARICO	COUVERCLE D'ECHAPPEMENT	1
12	PAF15-07010003	822625	TORNILLO	BOLT, UNION	VITE	VIS	1
13	PAF25-05000100	35-822626Q04	FILTRO ACEITE	OIL FILTER	FILTRO DELL'OLIO	FILTRE À HUILE	1
14	REC5GH-13440-00		FILTRO ACEITE	OIL FILTER	FILTRO DELL'OLIO	FILTRE À HUILE	1
15	PAGB/T5783-M6X35	10-88348935	TORNILLO	BOLT	VITE	VIS	7
16	PAF15-07000031	825212	TERMOSTATO	THERMOSTAT	TERMOSTATO	THERMOSTAT	1
17	PAF15-07010022	27-824853	JUNTA TAPA TERMOSTATO	GASKET, THERMOSTAT COVER	GUARNIZIONE COPERCHIO TERMOSTATO	JOINT COUVERCLE DE THERMOSTAT	1
18	PAF15-07010021	8250311	TAPA TERMOSTATO	COVER, THERMOSTAT	COPERCHIO TERMOSTATO	COUVERCLE DE THERMOSTAT	1
19	PAGB/T5783-M6X25	10-88348935	TORNILLO M6X25	BOLT M6X25	VITE M6X25	VISM6X25	2
20	PAF25-05010113	22-996642	NIPLE DE MANGUERA	NIPPLE	TUBO	RACCORD D'EAU	1
21	PAHT-2.5x60		BRIDA	CLAMP	FLANGIA	COLLIER	5
22	PAF25-03000008		TUBO DE AGUA	WATER TUBE	TUBO DELL'ACQUA	DURITE D'EAU	1
23	PAF15-05000011		CONECTOR DE 3 VÍAS	THREE-WAY PIPE	CONNETTORE T	RACCORD EN TE	1
24	PAF25-03000009		TUBO DE AGUA	WATER TUBE	TUBO DELL'ACQUA	DURITE D'EAU	1
25	PAF25-03000011		TUBO DE AGUA	WATER TUBE	TUBO DELL'ACQUA	DURITE D'EAU	1
26	PAF4-04000030		MUELLE TUBO COMBUSTIBLE B	SPRING, FUEL PIPE B	MOLLA TUBO COMBUSTIBILE B	RESSORT, TUYAU DE CARBURANT B	1
27	PAF25-05040000	27-830270	JUNTA CULATA	GASKET, CYLINDER HEAD	GUARNIZIONE TESTATA	JOINT DE CULASSE	1
28	PAGB/T5782-M8X35	10-857139	TORNILLO	BOLT, HEXAGON	VITE	VIS	1
29	PAF25-05010106	8525601	SOPORTE	HANGER, ENGINE	SUPPORTO	CROCHET LEVAGE MOTEUR	1
30	PAF15-04000003		ARANDELA	WASHER	RONDELLA	RONDELLE	1
31	PAF15-04000002	22-479452	TORNILLO DRENAJE	BOLT, DISCHARGING OIL	VITE DRENAGGIO	VIS DE VIDANGE	1
32	PAF25-05010107	35-8548091	FILTRO ACEITE	OIL FILTER	FILTRO DELL'OLIO	FILTRE À HUILE	1
33	PAF25-05010108	27-8547801	JUNTA DE CUBIERTA	GASKET, BREATHER	GUARNIZIONE COPERCHIO	JOINT DE PLAQUE	1
34	PAF25-05010109	832734A2	CUBIERTA DE RESPIRADERO	COVER, BREATHER	COPERCHIO	PLAQUE	1
35	PAF25-00000014	17-825010	PIN CENTRADOR	HOLLOW PIN	SPINOTTO DI CENTRAGGIO	PIN DE CENTRAGE	2
36	PAF25-05050100	830271T2	CULATA	CYLINDER HEAD	TESTATA	CULASSE	1
37	PAF25-05050007	27-827610	JUNTA	GASKET	GUARNIZIONE	JOINT	1
38	PAF25-05050006	10-827607	TORNILLO	BOLT	VITE	VIS	1
39	PAF25-05000004	25-833103	JUNTA TAPA	GASKET, COVER	GAURNIZIONE COPERCHIO	JOINT COUVERCLE	1
40	PAGB/T5783-M6X25	10-82500925	TORNILLO	BOLT, HEXAGON	VITE	VIS	6
41	PAF25-05000003		ARANDELA	WASHER, PLATE	RONDELLA	RONDELLE	10
42	PAF25-05000002	10-82503395	TORNILLO	BOLT, FLANGE	VITE	VIS	9
43	NGKDPR7EA-9	33-827858	BUJÍA	SPARK-PLUG	CANDELA	BOUGIE	2
44	PAJASOF40431-025	25-825492	TÓRICA	O-RING	O-RING	TORIQUE	1
45	PAF15-07050004	825490	TAPÓN ACEITE	PLUG, OIL	TAPPO OLIO	BOUCHON REMPLISSAGE D'HUILE	1
46	PAF25-05000005	830272A1	TAPA BALANCINES	COVER, CYLINDER HEAD	COPERCHIO PUNTERIE	CACHE CULBUTEUR	1
47	PAF25-02010005	826887M	ÁNODO	ANODE	ANODO	ANODE	2
48	PAF15-07010009	25-825040	ALOJAMIENTO ÁNODO	GROMMET, ANODE	ALLOGGIAMENTO ANODO	JOINT D'ANODE	2
49	PAF15-07010011		TAPA	COVER, ANODE	COPERTURA ANODO	COUVERCLE D'ANODE	2
50	PAGB/T97.1-5		ARANDELA	WASHER, PLATE	RONDELLA	RONDELLE	2
51	PAGB/T5783-M5X12		TORNILLO	BOLT, HEXAGON	VITE	VIS	2
52	PAF15-07010012		PLETINA	PLATE, ANODE	PIASTRA ANODO	PLAQUE	2

4T 25 HP (9973100+)
STROKES

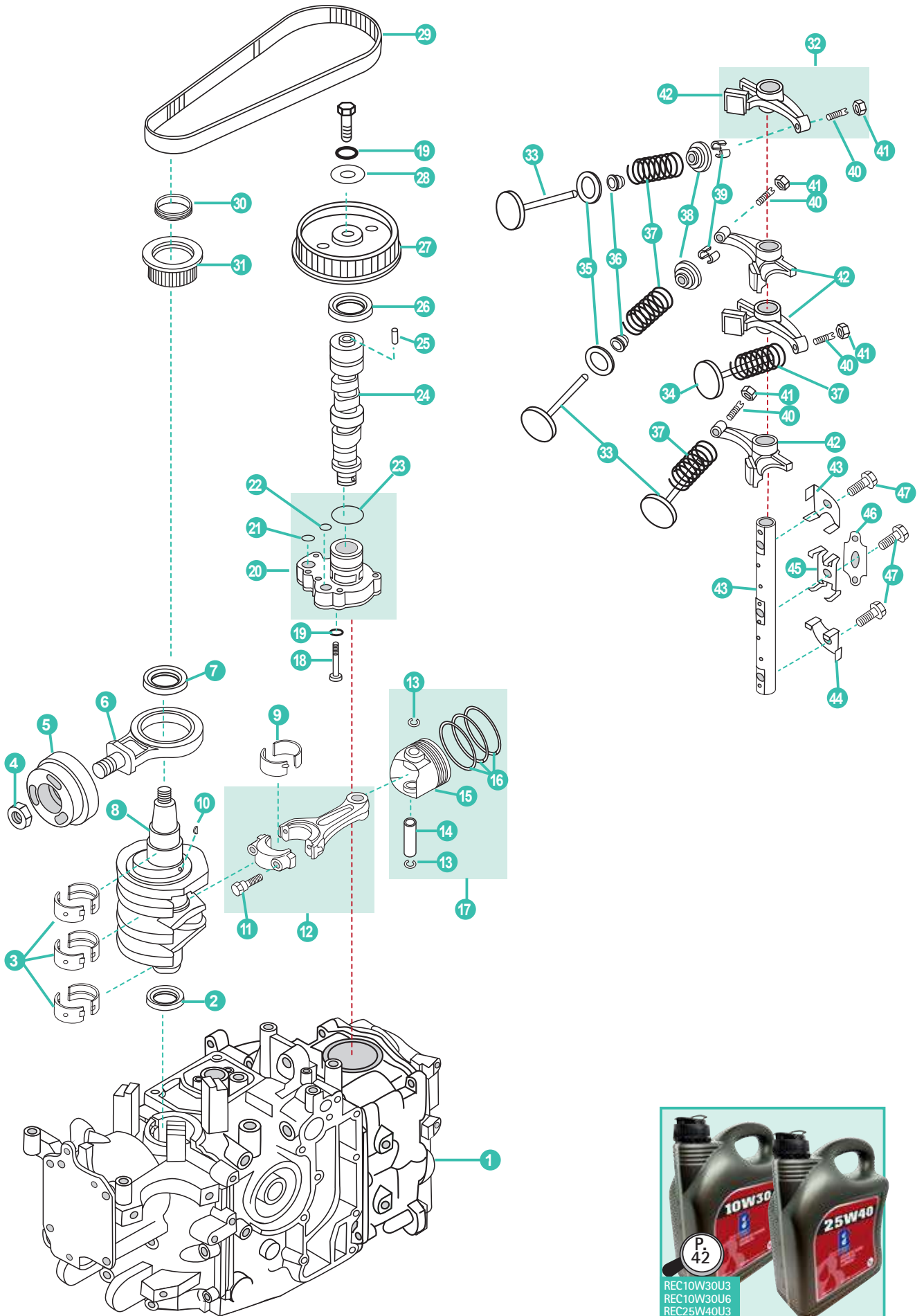

	REF	OEM				UN.	
1	POWERHEAD20-25		MOTOR	COMPLETE, POWER	BLOCCO COMPLETO	TÊTE MOTRICE	1
2	PAF25-05020002	26-832013	RETÉN	OIL-SEAL	GUARNIZIONE	JOINT SPI	1
3	PAF25-05010302-1	23-825024	COJINETE BANCADA BROWN	MAIN BEARING BROWN	CUSCINETTO BROWN	PALIER DE VILEBREQUIN MARRON	6
3	PAF25-05010302-2	23-8250241	COJINETE BANCADA BLACK	MAIN BEARING BLACK	CUSCINETTO BLACK	PALIER DE VILEBREQUIN NOIR	6
4	PAF25-05000026	11-81773M	TUERCA	LOCK NUT	DADO	ÉCROU	1
5	PAF25-05020301	701-8318751	PISTÓN, CONTRA	PISTON, BALANCE	PISTONE, CONTRO	PISTON D'EQUILIBRAGE	1
6	PAF25-05020310	652-831876A1	BIELA, CONTRO	CON-ROD ASSY, BALANCE	BIELLA, CONTRO	BIELLE D'EQUILIBRAGE	1
7	PAF25-05020003	26-825027	RETÉN	OIL SEAL	PARAOLIO	JOINT SPI	1
8	PAF25-05020001	2417-830269A1	CIGÜEÑAL	CRANK ASSY	ALBERO MOTORE	VILEBREQUIN	1
9	PAF25-05020203-1	23-825021	COJINETE BIELA	BEARING, CONNECTING ROD	CUSCINETTO BIELLA	COUSSINET DE BIELLE	2
9	PAF25-05020203-2	23-8250212	COJINETE BIELA	BEARING, CONNECTING ROD	CUSCINETTO BIELLA	COUSSINET DE BIELLE	2
10	PAF4-04000019	28-18856M	CUÑA	KEY WOODRUFF	CHIAVETTA	CLAVETTE	1
11	PAF25-05020204	10-825010	TORNILLO	BOLT, CONNECTING ROD	VITE	VIS	2
12	PAF25-05020200	650-825018A1	BIELA	CONNECTING ROD	BIELLA	BIELLE	2
13	PAF25-05020106	40-825017	CLIP	CIRCLIP	CLIP	CLIPS	4
14	PAF25-05020105	41-825016	PIN, PISTÓN	PIN, PISTON	SPINOTTO PISTONE	AXE DE PISTON	2
15	PAF25-05020101	702-833098A1	PISTÓN	PISTON	PISTONE	PISTON	2
16	REC67C-11603-00		KIT SEGMENTOS DE PISTÓN	PISTON RING KIT	KIT FASCIA PISTONE	KIT SEGMENTS	2
17	PAF25-05020100		PISTÓN COMPLETO	PISTON ASSY	PISTONE COMPLETO	PISTON COMPLET	2
18	PAGB/T5782-M6X125		TORNILLO	BOLT	VITE	VIS	4
19	PAGB/T97.1-8		ARANDELA	WASHER , PLATE	RONDELLA	RONDELLE	5
20	PAF25-05050400	852388A1	BOMBA ACEITE COMPLETA	OIL PUMP ASSY	POMPA DELL'OLIO COMPLETA	POMPE À HUILE COMPLÈTE	1
21	PAF25-05050014	25-826154	TÓRICA B	O-RING B	O-RING B	JOINT TORIQUE B	1
22	PAF25-05050013	25-826153	TÓRICA A	O-RING A	O-RING A	JOINT TORIQUE A	1
23	PAF25-05050015	25-826152	TÓRICA C	O-RING C	O-RING C	JOINT TORIQUE C	1
24	PAF25-05050200	2419-82500935	ÁRBOL DE LEVAS	CAMSHAFT ASSY	ALBERO A CAMME	ARBRE À CAMES	1
25	PAF25-05050016	17-825956	PIN CENTRADOR	HOLLOW PIN	SPINOTTO DI CENTRAGGIO	PIN DE CENTRAGE	1
26	PAF25-05050021	26-825048	RETÉN	OIL SEAL	PARAOLIO	JOINT SPI	1
27	PAF25-05050017	833104	POLEA DE CORREA	BELT PULLEY, DRIVEN	PULEGGIA CINGHIA	POULIE DE COURROIE	1
28	PAF25-05050018	12-4002319	ARANDELA	WASHER, PLATE	RONDELLA	RONDELLE	1
29	REC65W-46241-00	831294	CORREA DISTRIBUCIÓN	BELT, TIMING	CINGHIA DISTRIBUZIONE	COURROIE DISTRIBUTION	1
30	PAF25-05000022		MUELLE	BUSH, SPRING	MOLLA	RESSORT	1
31	PAF25-05000021	833102	ENGRANAJE DE DISTRIBUCIÓN	BELT PULLEY, TIMING	PULEGGIA DE DISTRIBUZIONE	POULIE DE DISTRIBUTION	1
32	PAF25-05050300		BALANCÍN COMPLETO	ROCKET ASSY	BILANCERE COMPLETO	CULBUTEUR COMPLET	4
33	PAF25-05050002	832990	VÁLVULA ESCAPE	VALVE, EXHAUST	VALVOLA SCARICO	SOUPAPE D'ÉCHAPPEMENT	2
34	PAF25-05050001	822649	VÁLVULA ADMISIÓN	VALVE, INTAKE	VALVOLA ASPIRAZIONE	SOUPAPE D'ADMISSION	2
35	PAF25-05050003	12-825044	ARANDELA ASIENTO	SEAT, VALVE SPRING	RONDELLA BASAMENTO	SIEGE RESSORT DE SOUPAPE	4
36	PAF166-010003	26-822647	RETÉN DE ACEITE	OIL SEAL	PARAOLIO	JOINT SPI	4
37	PAF25-05050005	24-823678	MUELLE DE VÁLVULA	SPRING, VALVE STEM	MOLLA DI VALVOLA	RESSORT DE SOUPAPE	4
38	PAF15-07040006	822650	RETÉN RESORTE	SPRING, VALVE RETAINER	VALVOLA DI RITEGNO	JOINT DE RESSORT	4
39	PAF15-07040007	28-822651	SEGURO DE VÁLVULA	CLAMP, VALVE	BLOCCAGGIO DI VALVOLA	CLAVETTE DE SOUPAPE	8
40	PAF15-07040303	10-825046	TORNILLO REGULADOR	SCREW, VALVE ADJUSTING	VITE REGOLATORE	VIS POINTEAU	4
41	PAF15-07040304	11-826150	TUERCA	NUT	GHIERA	ÉCROU	4
42	PAF25-05050301	825045A2	BALANCÍN	VALVE ROCKER	BILANCERE	CULBUTEUR	4
43	PAF25-05050008	830274	EJE DE BALANCÍN	SHAFT, ROCKER	ASSE BILANCERE	AXE DE CULBUTEUR	1
44	PAF25-05050009	825050	PLETINA	PLATE, BOLT STOPPER	PIASTRINA	PLAQUE	2
45	PAF25-05050011	24-825052	RESORTE	SPRING	MOLLA	RESSORT	1
46	PAF25-05050012	24-825052	PLETINA	PLATE B, BOLT STOPPER	PIASTRINA	PLAQUE	1
47	PAF25-05050019	10-82641030	TORNILLO	BOLT	VITE	VIS	3

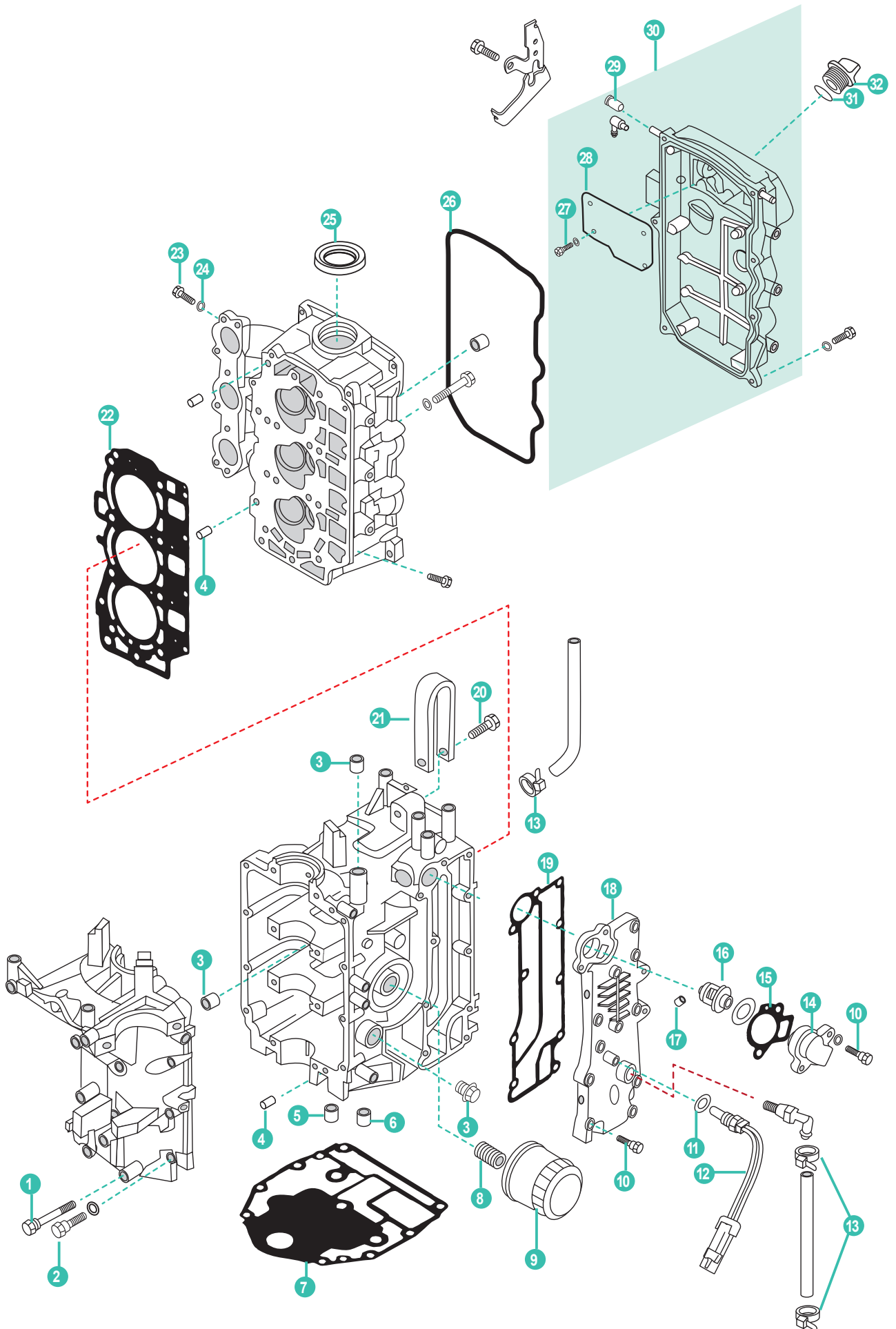

	REF	OEM				UN.	
	PAF40-05010000	893500T02	CILINDRO COMPLETO	CRANKCASE ASSY	BLOCCO MOTORE COMPLETO	CARTER BLOC MOTEUR	1
1	PAF25-05000035	82506182	TORNILLO	STUD	BULLONE	BOULON	8
2	PAF15-07000030	88348935	TORNILLO	STUD	BULLONE	BOULON	8
3	PAF15-07010004	479452	TORNILLO DRENAJE	BOLT, DISCHARGING OIL	VITE DRENAGGIO	BOUCHON DE VIDANGE	3
4	PAF25-00000014	825010	PIN CENTRADOR	HOLLOW PIN	SPINOTTO DI CENTRAGGIO	PIN DE CENTRAGE	2
5	PAF25-05010104	384073	TAPÓN 1/2"	JAM 1/2"	TAPPO 1/2"	BOUCHON 1/2"	1
6	PAF25-05010103	416223	TAPÓN 3/4"	JAM 3/4"	TAPPO 3/4"	BOUCHON 3/4"	1
7	REC67C-11351-00	892319001	JUNTA BASE MOTOR	GASKET ENGINE	GUARNIZIONE BASE MOTORE	JOINT DE TETE MOTRICE	1
8	PAF15-07010003	822625	TORNILLO, UNIÓN	BOLT, UNION	VITE, UNIONE	VIS UNION	1
9	REC35-822626Q04	822626K04	FILTRO ACEITE	OIL FILTER	FILTRO OLIO	FILTRE À HUILE	1
10	PAGB/T5783-M6X35	88348935	TORNILLO M6X35	SCREW M6X35	VITE M6X35	VIS M6X35	10
11	REC25-62702	627021	TÓRICA	O-RING	O-RING	JOINT TORIQUE	1
12	PAF40-05000400	889575	SENSOR	SENSOR	SENSORE	SONDE DE TEMPERATURE	1
13	PAHT-2.5X60	816311T	BRIDA	CLAMP	FASCETTA	COLLIER	3
14	PAF15-07010021	8M0008243	TAPA TERMOSTATO	COVER, THERMOSTAT	COPERCHIO TERMOSTATO	COUVERCLE DE THERMOSTAT	1
15	PAF15-07010022	824853	JUNTA TAPA TERMOSTATO	GASKET, THERMOSTAT COVER	GUARNIZIONE COPERCHIO TERMOSTATO	JOINT COUVERCLE DE THERMOSTAT	1
16	PAF15-07000031	825212001	TERMOSTATO	THERMOSTAT	TERMOSTATO	THERMOSTAT	1
17	PAF15-07010004	479452	TAPÓN 1/8"	JAM 1/8"	TAPPO 1/8"	BOUHON 1/8"	1
18	PAF40-05000005	893691T02	TAPA DE ESCAPE	EXHAUST OUTER COVER	COPERCHIO SCARICO	COUVERCLE ECHAPPEMENT	1
19	REC67C-41114-00	834775005	JUNTA EXTERIOR, TAPA DE ESCAPE	GASKET, EXHAUST OUTER COVER	GUARNIZIONE ESTERIORE, COPERCHIO SCARICO	JOINT DE COUVERCLE EXT ECHAPPEMENT	1
20	PAGB/T5783-M8X35	857139	TORNILLO	SCREW	VITE	VIS	1
21	PAF40-05000011	893697	SOPORTE	POTHOOK, ENGINE	SUPPORTO	CROCHET DE LEVAGE MOTEUR	1
22	REC67C-11181-01	834777	JUNTA CULATA	GASKET, CYLINDER HEAD	GUARNIZIONE TESTATA	JOINT DE CULASSE	1
23	PAGB/T5783-M6X8	400325	TORNILLO M6X8	SCREW M6X8	VITE M6X8	VIS M6X8	3
24	PAF25-05050007	893586	ARANDELA	WASHER	RONDELLA	RONDELLE	3
25	PAF25-05050021	893549	RETÉN	OIL SEAL	PARAOLIO	JOINT SPI	1
26	PAF40-05000002	854341	TÓRICA	O-RING	O-RING	JOINT TORIQUE	1
27	PAGB/T818-M4X10	4005685	TORNILLO M4X10	SCREW M4X10	VITE M4X10	VIS M4X10	1
28	PAF40-05070003	855236	PLACA	PLATE, BREATHER	PIASTRA	PLAQUE CACHE CULBUTEUR	1
29	PAF40-05070002	825054	CONECTOR	CONNECTOR, BREATHER	CONNETTORE	CONNECTEUR	1
30	PAF40-05070000	893693A04	TAPA COMPLETA, CILINDRO	COVER ASSY, CYLINDER HEAD	COPERCHIO COMPLETO,	CACHE CULBUTEUR	1
31	PAJASOF404-35-025	90196	TÓRICA	O-RING	O-RING	JOINT TORIQUE	1
32	PAF15-07050004	859578A1	TAPÓN	PLUG	TAPPO	BOUCHON	1

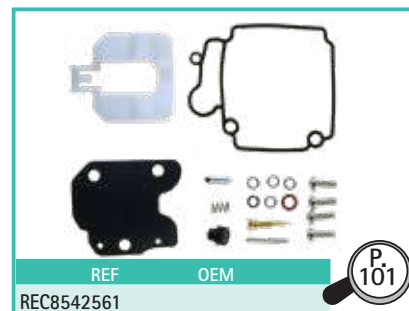
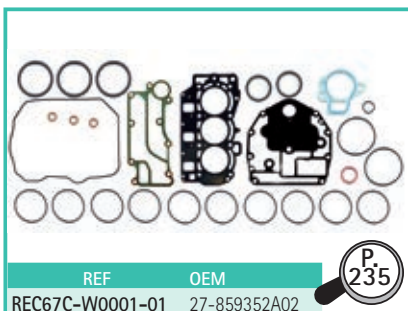

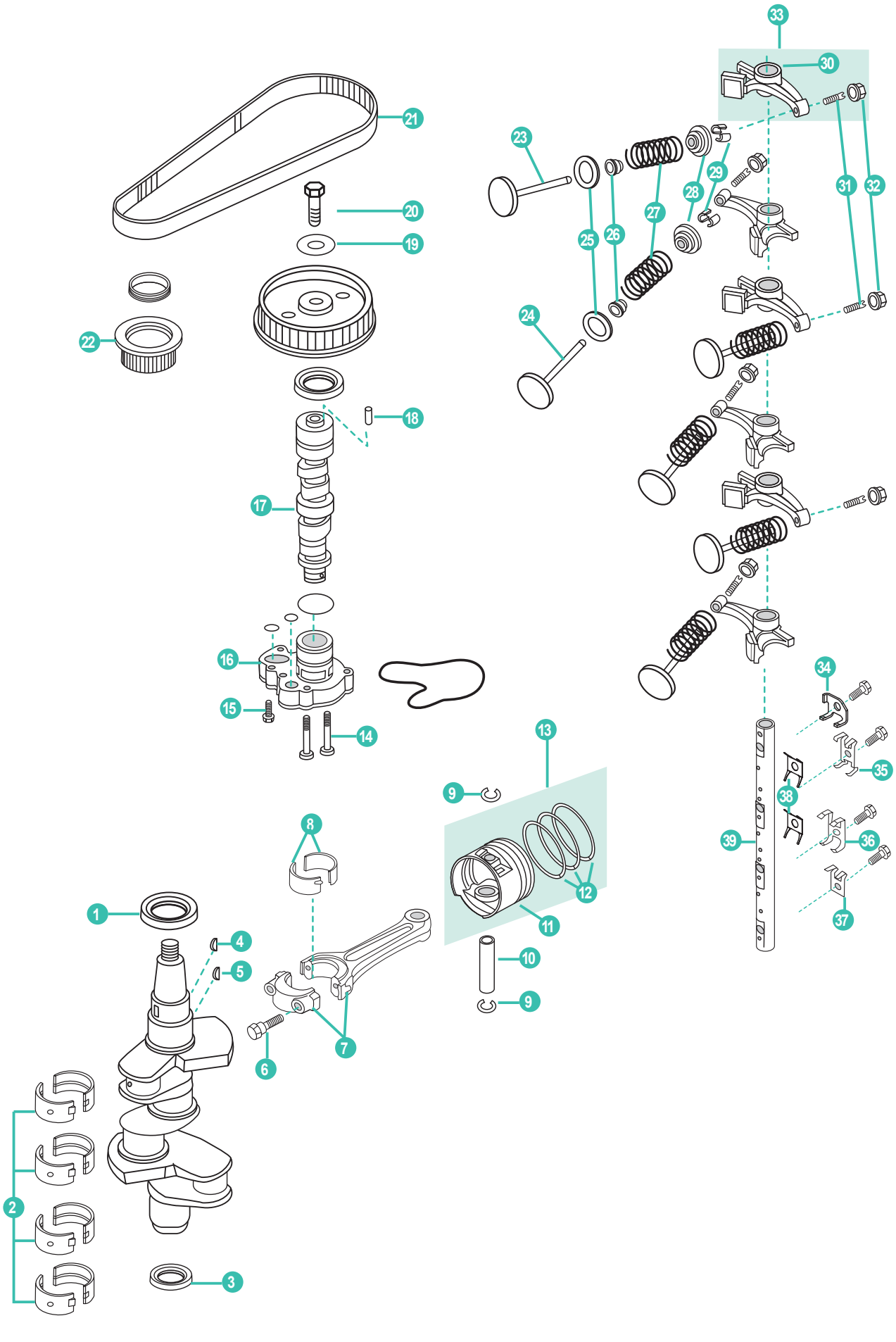

	REF	OEM					UN.
1	PAF25-05020003	825027	RETÉN DE ACEITE	OIL SEAL	PARAOLIO	JOINT SPI	1
2	PAF25-05010302-1	893631001	COJINETE BANCADA BROWN	MAIN BEARING BROWN	CUSCINETTO BROWN	PALIER DE VILEBREQUIN BROWN	8
	PAF25-05010302-2	893631	COJINETE BANCADA BLACK	MAIN BEARING BLACK	CUSCINETTO BLACK	PALIER DE VILEBREQUIN BLACK	8
3	PAF25-05020002	832013	RETÉN DE ACEITE	OIL SEAL	PARAOLIO	JOINT SPI	1
4	PAF25-05000024	91800	CHAVETA	KEY WOODRUFF	CHIAVETTA	CLAVETTE	1
5	PAF4-04000019	18856M	CHAVETA	KEY WOODRUFF	CHIAVETTA	CLAVETTE	1
6	PAF25-05020204	825019	TORNILLO	SCREW	VITE	VIS	6
7	PAF25-05020200	856065T1	BIELA COMPLETA	ROD, CONNECTING ASSY	BIELLA COMPLETA	BIELLE COMPLÈTE	3
8	PAF25-05020203-1	893630001	COJINETE DE BIELA BROWN	BEARING, CONNECTING ROD BROWN	CUSCINETTO BIELA BROWN	PALIER DE BIELLE BROWN	6
	PAF25-05020203-2	893630	COJINETE DE BIELA BLACK	BEARING, CONNECTING ROD BLACK	CUSCINETTO BIELA BLACK	PALIER DE BIELLE BLACK	6
9	PAF25-05020106	893529	CIRCLIP	CIRCLIP	CIRCLIP	CIRCLIP	6
10	PAF25-05020105	893863	PIN, PISTÓN	PIN, PISTON	SPINOTTO PISTONE	AXE DE PISTON	3
11	PAF40-05020101	893524T08	PISTÓN	PISTON	PISTONE	PISTON	3
12	REC67C-11603-00	893525A01	KIT SEGMENTOS DE PISTÓN	PISTON RING KIT	KIT FASCIA PISTONE	KIT SEGMENTS	3
13	PAF40-05020100		KIT PISTÓN	PISTON KIT	KIT PISTONE	KIT PISTON	3
14	PAGB/T5782-M6X40	4000333	TORNILLO	SCREW	VITE	VIS	4
15	PAGB/T5783-M6X16	875206	TORNILLO	SCREW	VITE	VIS	2
16	PAF40-05040400	857087T1	BOMBA ACEITE	OIL PUMP	POMPA OLIO	POMPE A HUILE	1
17	PAF40-05040200	834781T1	ÁRBOL DE LEVAS	CAMSHAFT ASSY	ALBERO A CAMME	ARBRE A CAMES	1
18	PAF25-05050016	893581	PIN CENTRADOR	PIN CENTRADOR	SPINOTO CENTRAGGIO	PIN DE CENTRAGE	1
19	PAF25-05050018	4002320	ARANDELA	WASHER	RONDELLA	RONDELLE	1
20	PAGB/T5785-M10X1.25X40		TORNILLO	SCREW	VITE	VIS	1
21	REC65W-46241-00	57-831294	CORREA	BELT PULLEY	CINGHIA	COURROIE	1
22	PAF25-05000021	833102T	ENGRANAJE DE DISTRIBUCIÓN	BELT PULLEY, DRIVEN	PULEGGIA DI DISTRIBUZIONE	POULIE DE DISTRIBUTION	1
23	PAF25-05050002	832991T3	VÁLVULA ESCAPE	VALVE, EXHAUST	VALVOLA SCARICO	SOUPAPE D'ÉCHAPPEMENT	3
24	PAF25-05050001	832990T3	VÁLVULA ADMISIÓN	VALVE, INTAKE	VALVOLA ASPIRAZIONE	SOUPAPE D'ADMISSION	3
25	PAPS2700.04.03		ARANDELA ASIENTO	SEAT, VALVE SPRING	RONDELLA BASAMENTO	SIEGE RESSORT DE SOUPAPE	6
26	PAF25-05050003		RETÉN DE ACEITE	OIL SEAL	PARAOLIO	JOINT SPI	6
27	PAF25-05050005	893552	MUELLE DE VÁLVULA	SPRING, VALVE STEM	MOLLA DI VALVOLA	RESSORT DE SOUPAPE	6
28	PAF15-07040006	893553	RETÉN RESORTE	SPRING, VALVE RETAINER	VALVOLA DI RITEGNO	JOINT DE RESSORT	6
29	PAF15-07040007	893554	SEGURO DE VÁLVULA	CLAMP, VALVE	BLOCCAGGIO DI VALVOLA	CLAVETTE DE SOUPAPE	12
30	PAF25-05050301	825045A2	BRAZO DE BALANCÍN	ARM, VALVE ROCKER	BILANCIERE	CULBUTEUR	1
31	PAF15-07040303	825046	TORNILLO REGULADOR	SCREW, VALVE ADJUSTING	VITE REGOLATORE	VIS POINTEAU	6
32	PAF15-07040304	826150	TUERCA	LOCK NUT	DADO	ÉCROU	6
33	PAF25-05050300		BALANCÍN COMPLETO	ROCKER ASSY	BILANCIERE COMPLETO	CULBUTEUR	6
34	PAF25-05050009	893560	PLACA, TOPE DE PERNO	PLATE, BOLT STOPPER	PIASTRA DE VITE	PLAQUE DE FIXATION	1
35	PAF25-05050011	893562	RESORTE	SPRING	MOLLA	RESSORT	1
36	PAF40-05040003	893561	PLACA EJE DE BALANCINES	FIXED PLATE B, ROCKER SHAFT	PIASTRA, ASSE BILANCIERE	PLAQUE ARBRE DES CULBUTEUR	1
37	PAF40-05040004	854713	RESORTE	SPRING	MOLLA	RESSORT	1
38	PAF40-05040002	893563	RESORTE	SPRING	MOLLA	RESSORT	1
39	PAF40-05040001	834780T1	EJE BALANCINES	SHAFT ROCKER	ASSE BILANCIERE	AXE DE CULBUTEUR	1

4T 30, 40, 50, 60 HP (4 CYL)
STROKES

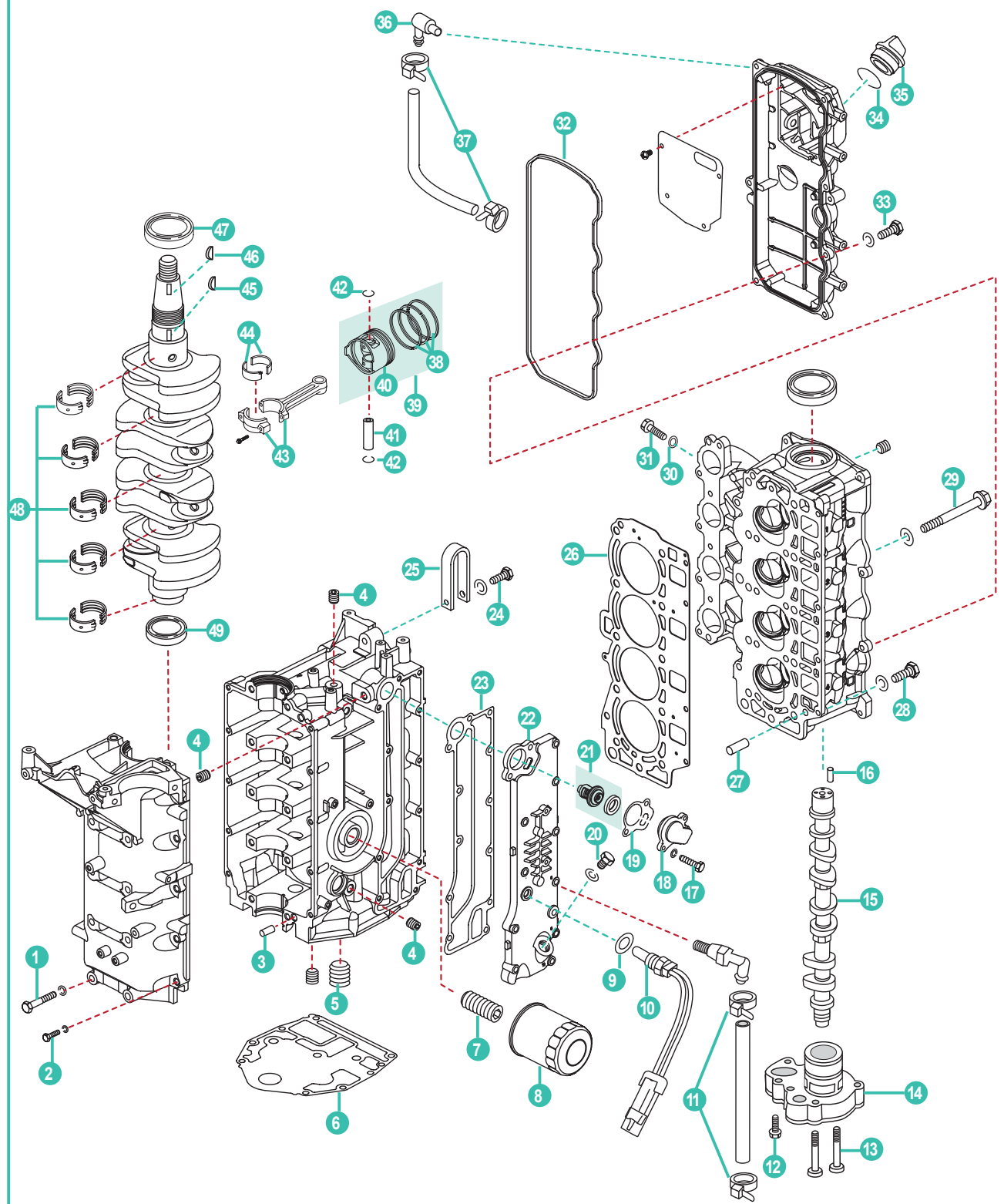

REC10W30U3
REC10W30U6
REC25W40U3

	REF	OEM				UN.	
1	PAF25-05000035	893541082	TORNILLO M8X80	BOLT M8X80	BULLONE M8X80	BOULON M8X80	10
2	PAF15-07000030	88348935	TORNILLO M6X35	BOLT M6X35	BULLONE M6X35	BOULON M6X35	10
3	PAF25-00000014	825010	PIN CENTRADOR	PIN, DOWEL	PIN, CENTRAGGIO	GOUPILLE FENDUE	2
4	PAF15-07010004	479452	TAPÓN 1/8"	JAM 1/8"	TAPPO 1/8"	BOUHN 1/8"	1
5	REC22-41622	416223	TAPÓN CODO	PLUG PIPE	TAPPO GOMITO	BOUCHON DE COUDE	1
6	REC67C-11351-00	892319001	JUNTA BASE MOTOR	BASE GASKET	GUARNIZIONE COPPA DELL'OLIO	JOINT DE CARTER	1
7	PAF15-07010003	822625	TORNILLO, UNIÓN	BOLT, UNION	VITE, UNIONE	VIS UNION	1
8	REC35-822626Q04	8M0065104	FILTRO ACEITE	OIL FILTER	FILTRO OLIO	FILTRE À HUILE	1
9	REC25-62702	627021	ARO TÓRICO	O-RING	O-RING	JOINT TORIQUE	1
10	PAF40-05000400	889575	SENSOR DE TEMPERATURA	SENSOR ASSY TEMPERATURE	SENSORE DE TEMPERATURA	SONDE DE TEMPERATURE	1
11	PAHT-2.5X60	816311T	BRIDA	CLAMP	FASCETTA	COLLIER	2
12	PAGB/T5783-M6X16	875206	TORNILLO M6X16	SCREW M6X16	VITE M6X16	VIS M6X16	2
13	PAGB/T5783-M6X40	4000333	TORNILLO M6X16	SCREW M6X40	VITE M6X40	VIS M6X140	4
14	PAF40-05040400	857078T1	BOMBA ACEITE	OIL PUMP	POMPA OLIO	POMPE À HUILE	1
15	PAF60-05020200	893565	ÁRBOL DE LEVAS	CAMSHAFT	ALBERO A CAMME	ARBRE À CAMES	1
16	PAF25-05050016	878183	PIN CENTRADOR	PIN DOWEL	SPINOTTO DI CENTRAGGIO	PIN DE CENTRAGE	1
17	PAGB/T5782-M6X35	88348935	TORNILLO M6X35	BOLT M6X35	BULLONE M6X35	BOULON M6X35	12
18	PAF15-07010021		TAPA TERMOSTATO	COVER, THERMOSTAT	COPERCHIO TERMOSTATO	COUVERCLE DE THERMOSTAT	1
19	PAF15-07010022	824853	JUNTA TAPA TERMOSTATO	GASKET, THERMOSTAT	GUARNIZIONE, TERMOSTATO	JOINT THERMOSTAT	1
20	PAF15-07010004	479452	TAPÓN	PLUG	TAPPO	BOUCHON	1
21	PAF15-07000031	8M0117413	TERMOSTATO	THERMOSTAT	TERMOSTATO	THERMOSTAT	1
22	PAF60-05000005	8M0118194	TAPA ESCAPE	COVER EXHAUST	COPERCHIO SCARICO	COUVERCLE D'ÉCHAPPEMENT	1
23	PAF60-05000004	857078	JUNTA TAPA ESCAPE	COVER EXHAUST, GASKET	GUARNIZIONE COPERCHIO SCARICO	JOINT DE COUVERCLE D'ÉCHAPPEMENT	1
24	PAGB/T5782-M8X35	857139	TORNILLO M8X35	BOLT M8X35	BULLONE M8X35	BOULON M8X35	1
25	PAF40-05000011	893697	SOPORTE	POTHOOK, ENGINE	SUPPORTO	CROCHET DE LEVAGE MOTEUR	1
26	REC8M0045278	8M0118179	JUNTA DE CULATA	HEAD GASKET	GUARNIZIONE TESTA	JOINT DE CULASSE	1
27	PAF25-00000014	825010	PIN CENTRADOR	PIN DOWEL	PIN, CENTRAGGIO	GOUPILLE FENDUE	2
28	PAGB/T5783-M6X25	82500925	TORNILLO M6X25	BOLT M6X25	BULLONE M6X25	BOULON M6X25	5
29	PAF25-05000002	82503395	TORNILLO M9X95	BOLT M9X95	BULLONE M9X95	BOULON M9X95	10
30	PAGB/T848-6	859768	ARANDELA	WASHER	RONDELLA	RONDELLE	4
31	PAGB/T5783-M6X8	4000325	TORNILLO M6X8	BOLT M6X8	BULLONE M6X8	BOULON M6X8	4
32	PAF60-05000003	8M0011870	RETÉN	SEAL	PARAOLIO	JOINT SPI	2
33	PAGB/T5783-M6X20	8M4503518	TORNILLO M6X20	BOLT M6X20	BULLONE M6X20	BOULON M6X20	7
34	PAJASOF404-35-025	90196	ARO TÓRICO	O-RING	O-RING	JOINT TORIQUE	1
35	PAF15-07050004	859578A1	TAPÓN ACEITE	OIL PLUG	TAPPO OLIO	BOUCHON D'HUILE	1
36	PAF25-02010003	629101	CODO 90°	FITTING ELBOW 90°	RACCORDO BENZINA 90°	RACCORD ESSENCE COUDE	1
37	REC54-816311T	816311T	BRIDA	TIE STRAP	FASCETTA	COLLIER	2
38	REC67C-11603-00	893525A01	KIT AROS PISTÓN	PISTON RING ASSY	KIT FASCETTE PISTONE	KIT SEGMENTS	4
39	PAF40-05020100		PISTÓN COMPLETO	PISTON ASSY	PISTONE COMPLETO	KIT PISTON	4
40	PAF40-05020101	893524T08	PISTÓN STD	PISTON STD	PISTONE STD	PISTON STD	4
41	PAF25-05020105	893863	PIN PISTÓN	PIN, PISTON	PIN, PISTONE	AXE DE PISTON	4
42	PAF25-05020106	893529	CIRCLIP	CIRCLIP	CIRCLIP	CIRCLIP	8
43	PAF25-05020200	893530T01	BIELA	CONNECTING ROD	BIELLA	BIELLE	4
44	PAF25-05010302-1	893630001	COJINETE DE BIELA BROWN	BEARING, CONNECTING ROD BROWN	CUSCINETTO BIELLA BROWN	PALIER DE BIELLE MARRON	8
	PAF25-05010302-2	893630	COJINETE DE BIELA BLACK	BEARING, CONNECTING ROD BLACK	CUSCINETTO BIELLA BLACK	PALIER DE BIELLE NOIR	8
45	PAF4-04000019	18856M	CHAVETA	KEY	CIAVETTA	CLAVETTE	1
46	PAF25-05000024	91800	CHAVETA	KEY	CIAVETTA	CLAVETTE	1
47	PAF25-05020003	893949	RETÉN ACEITE	SEAL OIL	PARAOLIO	JOINT SPI	1
48	PAF25-05010302-1	893631001	COJINETE BANCADA BROWN	MAIN BEARING BROWN	CUSCINETTO BROWN	PALIER DE VILEBREQUIN MARRON	10
	PAF25-05010302-2	893631	COJINETE BANCADA BLACK	MAIN BEARING BLACK	CUSCINETTO BLACK	PALIER DE VILEBREQUIN NOIR	10
49	PAF25-05020002	893948	RETÉN ACEITE	SEAL OIL	PARAOLIO	JOINT SPI	1

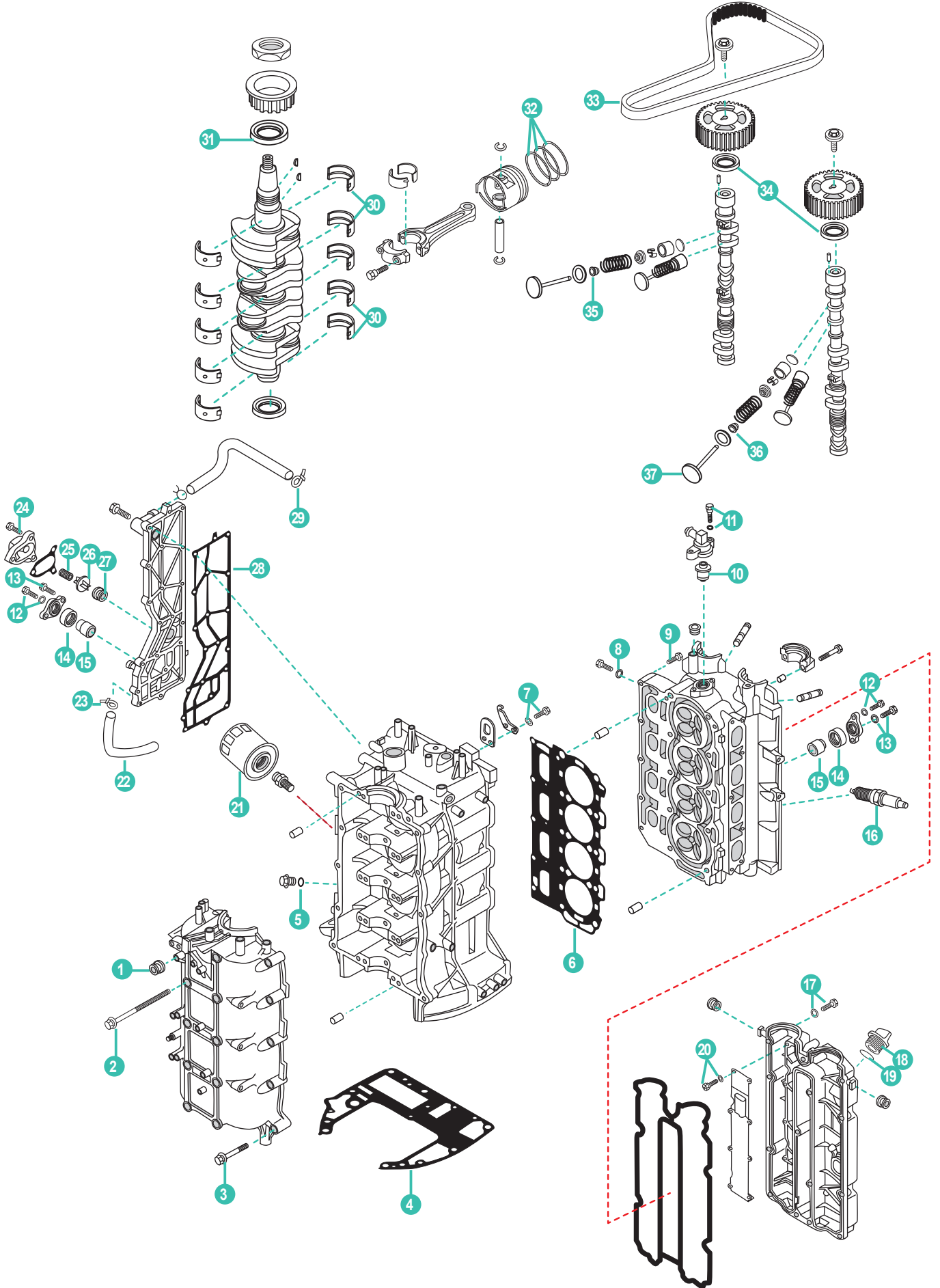

	REF	OEM				UN.	
1	PAF15-07010027	855690	GOMA	GROMMET	TAPPO	BOUCHON	1
2	PAF25-00000006	804072	TORNILLO M10X120	BOLT M10X120	VITE M10X120	VIS M10X120	10
3	PAGB/T5783-M8X55	41884M	TORNILLO M8X55	BOLT M8X55	VITE M8X55	VIS M8X55	10
4	REC68V-11351-00	8587321	JUNTA	GASKET	GUARNIZIONE	JOINT DE TETE MOTRICE	1
5	PAF15-04000003	81990M	JUNTA	GASKET	GUARNIZIONE	JOINT	1
6	REC67F-11181-03	8041151	JUNTA CULATA	HEAD GASKET	GUARNIZIONE TESTA	JOINT DE CULASSE	1
7	PAGB/T5783-M6X20	8257021	TORNILLO M6X20	BOLT M6X20	VITE M6X20	VIS M6X20	4
8	PAF4-04000006	831246	ARANDELA	WASHER	RONDELLA	RONDELLE	4
9	PAGB/T5783-M8X55	881312	TORNILLO M8X55	BOLT M8X55	VITE M8X55	VIS M8X55	5
10	REC67F-12411-01	8556761	TERMOSTATO 60°	THERMOSTAT 60°	TERMOSTATO 60°	THERMOSTAT 60°	1
11	PAGB/T5782-M6X25	8248326	TORNILLO M6X25	BOLT M6X25	VITE M6X25	VIS M6X25	4
12	PAGB/T5783-M8X25	827207	TORNILLO M8X25	BOLT M8X25	VITE M8X25	VIS M8X25	4
13	PAGB/T5783-M6X20	8524741	TORNILLO M6X20	BOLT M6X20	VITE M6X20	VIS M6X20	3
14	REC67F-11328-00	804086	TAPÓN	CAP	TAPPO	BOUCHON	3
15	REC68V-11325-01AL		ÁNODO	ANODE	ANOD	ANODE	3
16	NGKFR5A-11	859495	BUJÍA	SPARK PLUG	CANDELA	BOUGIE	4
17	PAGB/T5787-M6x30	858530	TORNILLO M6X30	BOLT M6X30	VITE M6X30	VIS M6X30	14
18	PAF15-07050004	859578A1	TAPÓN ACEITE	OIL CAP	TAPPO OLIO	BOUCHON À HUILE	1
19	PAJASOF40431-025		ARO TÓRICO	O-RING	O-RING	JOINT TORIQUE	1
20	PAGB/T818-M4X8	804120	TORNILLO M4X8	BOLT M4X8	VITE M4X8	VIS M4X8	8
21	REC35-822626Q04	822626Q2	FILTRO ACEITE	OIL FILTER	FILTRO OLIO	FILTRE À HUILE	1
22	PAF40-05000053	804078	TUBO	HOSE	TUBO	TUYAU	1
23	REC54-816311T	816311T	BRIDA	CAMP	FASCETTA	COLLIER	2
24	PAGB/T5783-M6X16	881428	TORNILLO M6X16	BOLT M6X16	VITE M6X16	VIS M6X16	3
25	REC90501-16M11	804081	MUELLE	SPRING	MOLLA	RESSORT	1
26	REC60H-12416-00	804080	VALVULA ANTIPRESION	VALVE PRESSURE CONTROL	VALVOLA ANTIPRESSIONE	SOUPAPE DE DEPRESSION	1
27	REC90480-20M05	804082	GOMA	GROMMET	TAPPO	BOUCHON	1
28	REC67F-41114-A2	804076	JUNTA	GASKET	GUARNIZIONE	JOINT	1
29	PAHT-2.5X60	816311T	BRIDA	CAMP	FASCETTA	COLLIER	1
	REC67F-11416-00	804101T	COJINETE BANCADA GREEN	MAIN BEARING GREEN	CUSCINETTO GREEN	PALIER DE VILEBREQUIN GREEN	4
30	REC67F-11416-10	804101T10	COJINETE BANCADA BLUE	MAIN BEARING BLUE	CUSCINETTO BLUE	PALIER DE VILEBREQUIN BLUE	4
	REC67F-11416-20	804101T20	COJINETE BANCADA RED	MAIN BEARING RED	CUSCINETTO RED	PALIER DE VILEBREQUIN RED	4
31	REC93102-48009	8040992	RETÉN	SEAL OIL	PARAOLIO	JOINT SPI	1
32	REC6D8-11603-10	804107T1	KIT AROS PISTÓN STD	PISTON RING ASSY STD	KIT FASCETTE PISTONE STD	KIT SEGMENTS STD	4
	REC6D8-11604-10	804108T1	KIT AROS PISTÓN 0.25	PISTON RING ASSY 0.25	KIT FASCETTE PISTONE 0.25	KIT SEGMENTS 0.25	4
33	REC67F-46241-00	804145	CORREA	BELT PULLEY	CINGHIA	COURROIE	1
34	REC93102-38008	804144	RETÉN ACEITE	SEAL OIL	PARAOLIO	JOINT SPI	2
35	RECK0A-A3722-00	804137	RETEN VALVULA	SEAL VALVE SYSTEM	PARAOLIO VALVOLA	JOINT DE QUEUE DE SOUPAPE	8
36	RECK0A-A3721-00	804136	RETEN VALVULA	SEAL VALVE SYSTEM	PARAOLIO VALVOLA	JOINT DE QUEUE DE SOUPAPE	8
37	REC68V-12111-00	804128T	VÁLVULA ADMISIÓN	VALVE INTAKE	VALVOLA ASPIRAZIONE	SOUPAPE ADMISSION	8

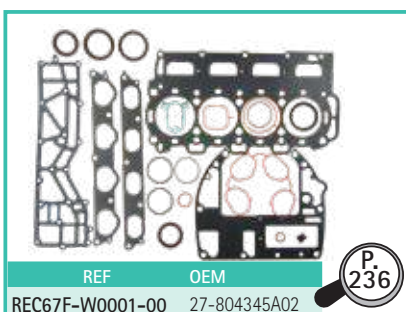

4T 75, 80, 90, 110, 115 HP EFI STROKES

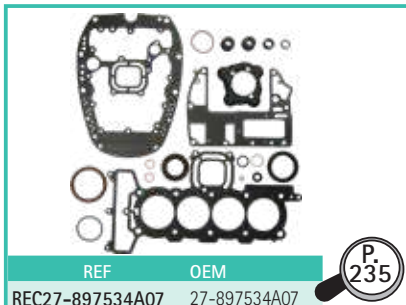
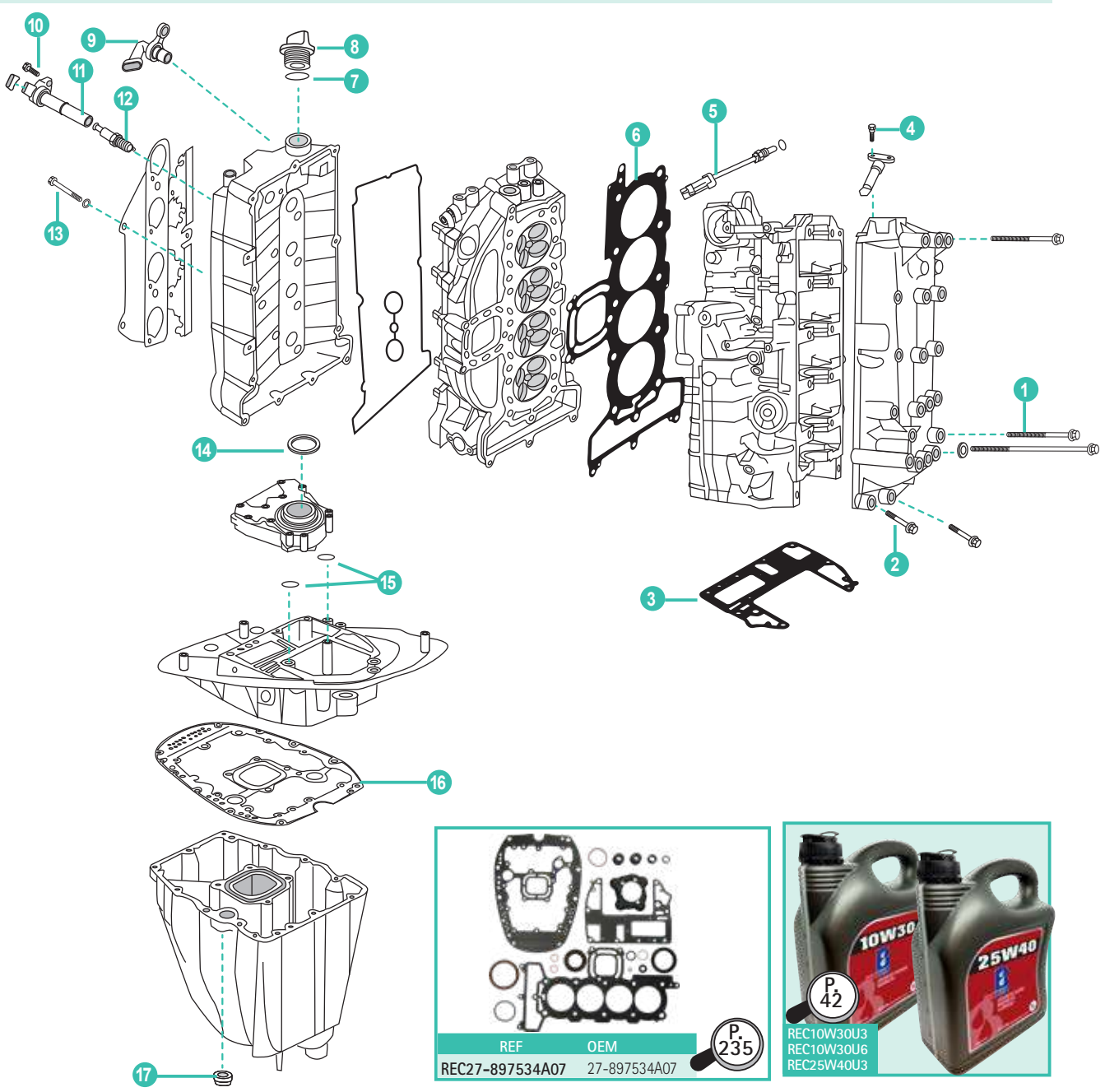

	REF	OEM					UN.
1	PAF25-0000006	892086120	TORNILLO M10X120	BOLT M10-X120	VITE M10X120	VIS M10X120	2
2	PAGB/T5787-1986	895810050	TORNILLO M8X50	BOLT M8X50	VITE M8X50	VIS M8X50	2
3	REC27-8M0024563	8M0024563	JUNTA BASE MOTOR	GASKET ENGINE	GUARNIZIONE BASE MOTORE	JOINT DE TETE MOTRICE	1
4	PAGB/T5783-M5X14	40011106	TORNILLO M5X13	BOLT M5X13	VITE M5X13	VIS M5X13	2
5	REC8M0148668	885342002	SENSOR TEMPERATURA	TEMPERATURE SENSOR	SENSORE TEMPERATURA	SONDE DE TEMPERATURE	1
6	RM27-8M0024565	8M0024565	JUNTA CULATA	GASKET CYLINDER HEAT	GUARNIZIONE TESTATA	JOINT DE CULASSE	1
7	PAJASOF404-35-025	90196	ARO TÓRICO	O-RING	O-RING	JOINT TORIQUE	1
8	PAF15-07050004	859578A1	TAPÓN ACEITE	OIL CUP	TAPPO OLIO	BOUCHON D'HUILE	1
9	REC8M0011987	880609	SENSOR ARBOL LEVAS	CAMSHAFT SENSOR	SENSORE ALBERO A CAMME	CAPTEUR ARBRE À CAMES	1
10	PAGB/T5783-M6X25	88552525	TORNILLO M6X25	BOLT M6X25	VITE M6X25	VIS M6X25	4
11	REC339-880615T01	880615T01	BOBINA COMPLETA	COIL ASSY	BOBINA ASCENSIONE	BOBINE D'ALLUMAGE	4
12	NGKFR4AE	898829001	BUJÍA	SPARK PLUG	CANDELA	BOUGIE	4
13	PAGB/T5782-M6X90	8M0008535	TORNILLO M6X90	BOLT M6X90	VITE M6X90	VIS M6X90	2
14	REC26-8M0036343	26-804349004	RETÉN	OIL SEAL	PARAOLIO	JOINT SPI	1
15	REC25-62705001	25-6270501	TÓRICA	O-RING	O-RING	JOINT TORIQUE	2
16	REC8M0005405	8M0005405	JUNTA ADAPTADOR	GASKET	GUARNIZIONE	JOINT PLAQUE ADAPT	1
17	REC814080001	814080001	RETÉN	OIL SEAL	PARAOLIO	JOINT SPI	1

4T 135, 150 HP SEAPRO, PRO XS
STROKES

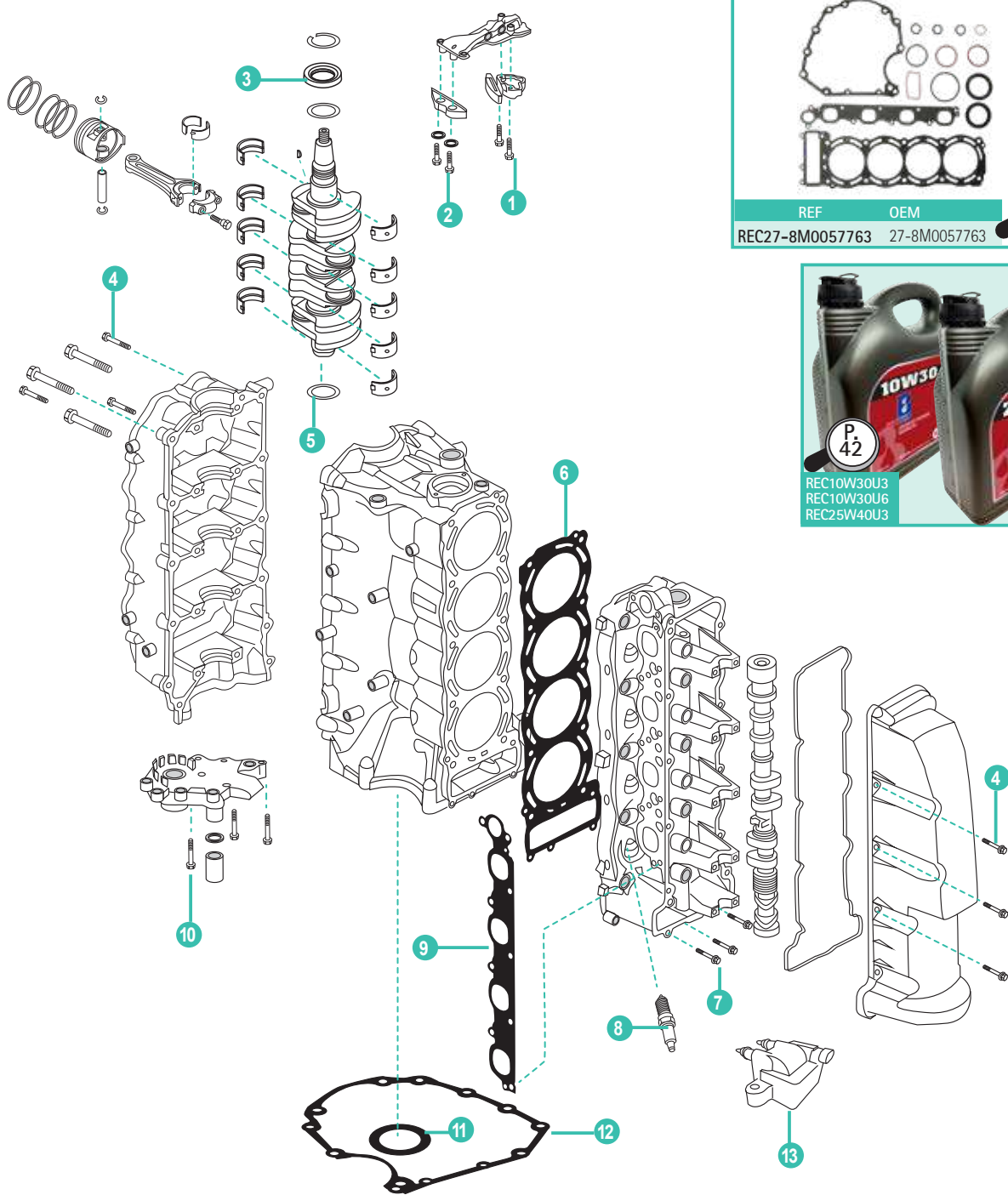

REF	OEM
REC27-8M0057763	27-8M0057763

P. 236

REF	OEM
REC10W30U3	
REC10W30U6	
REC25W40U3	

P. 42

MERCURY

RECAMBIO
MARINOS

	REF	OEM					UN.
1	PAGB/T5783-M6X30	88552530	TORNILLO M6X30	BOLT M6X30	VITE M6X30	VIS M6X30	2
2	PAGB/T5783-M6X20	88552520	TORNILLO M6X20	BOLT M6X20	VITE M6X20	VIS M6X20	2
3	REC26-8M0035127	8M0035127	RETÉN	SEAL	PARAOILIO	JOINT SPI	1
4	PAGB/T5783-M6X25	88552525	TORNILLO M6X25	BOLTM6X25	VITE M6X25	VIS M6X25	12
5	REC25-8M0034912	8M0034912	ARO TÓRICO	O-RING	O-RING	JOINT TORIQUE	1
6	REC27-8M6000366	8M6000366	JUNTA CULATA	GASKET CYLINDER HEAT	GUARNIZIONE TESTATA	JOINT DE CULASSE	1
7	PAGB/T5783-M6X40	88552540	TORNILLO M6X40	BOLT M6X40	VITE M6X40	VIS M6X40	3
8	NGKZFR5F	33-8M0057936	BUJÍA	SPARK PLUG	CANDELA	BOUGIE	4
9	REC27-8M6000365	27-8M6000365	JUNTA ESCAPE	EXHAUST GASKET	GUARNIZIONE SCARICO	JOINT D'ÉCHAPPEMENT	1
10	PAGB/T5783-M6X35	88552545	TORNILLO M6X35	BOLT M6X35	VITE M6X35	VIS M6X35	4
11	REC25-8M0056667	8M0056667	RETÉN	OIL SEAL	PARAOILIO	JOINT D'HUILE	1
12	REC27-8M0057703	8M0057703	JUNTA BASE MOTOR	GASKET ENGINE	GUARNIZIONE BASE MOTORE	JOINT DE TÊTE MOTRICE	1
13	REC300-8M0044991	300-8M0044991	BOBINA	COIL	BOBINA	BOBINE	2

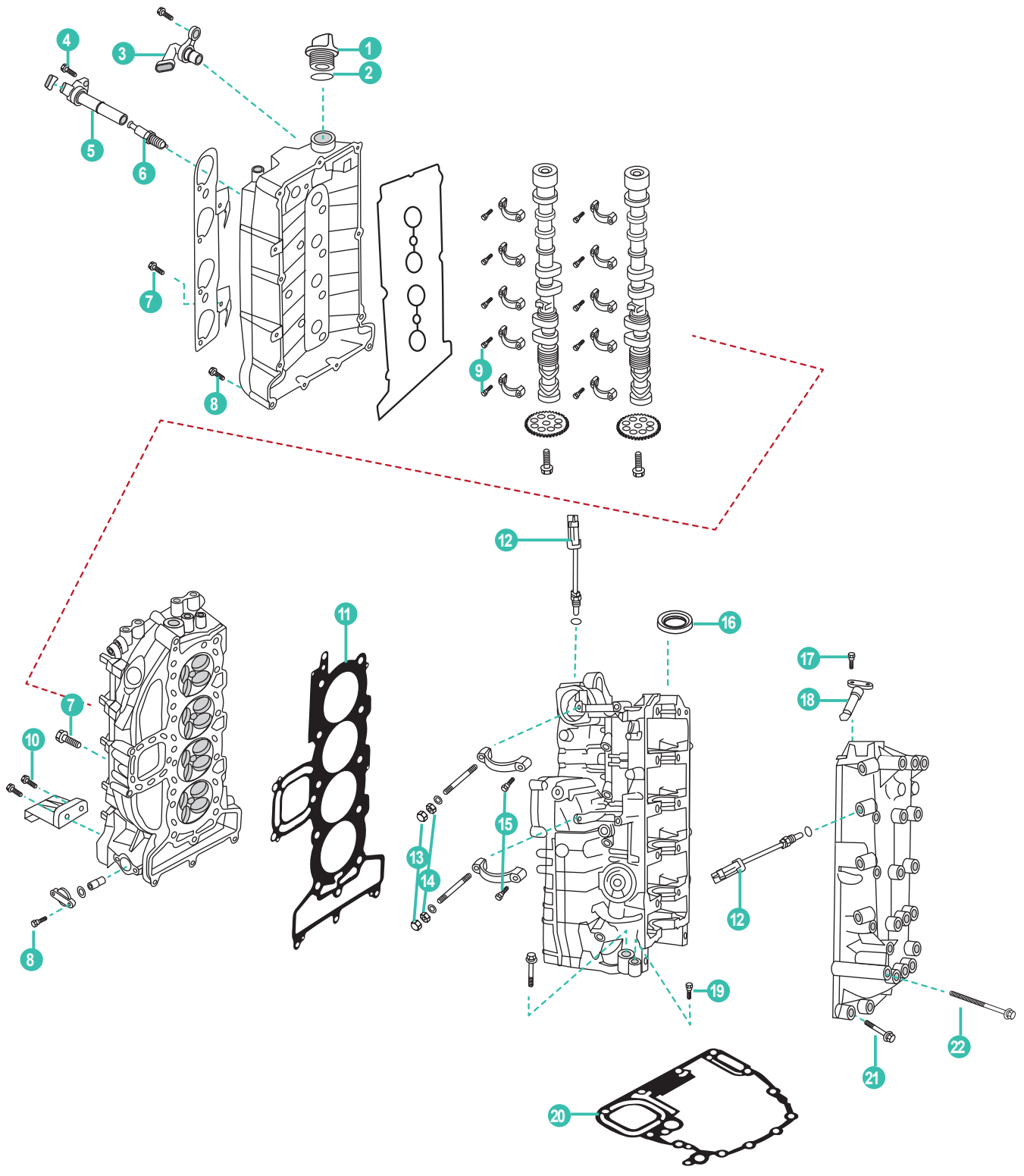

	REF	OEM				UN.	
1	PAF15-07050004	859578A1	TAPÓN ACEITE	OIL PLUG	TAPPO OLIO	BOUCHON D'HUILE	1
2	PAJASOF404-35-025	90196	ARO TÓRICO	O-RING	O-RING	JOINT TORIQUE	1
3	REC8M0011987	880609	SENSOR ARBOL LEVAS	CAMSHAFT SENSOR	SENSORE ALBERO A CAMME	CAPTEUR D'ARBRE À CAMES	1
4	PAF8-05000022	88552525	TORNILLO M6X25	BOLT M6X25	VITE M6X25	VIS M6X25	4
5	REC339-880615T01	880615T014	BOBINA COMPLETA	COIL ASSY	BOBINA ASCENSIONE	BOBINE D'ALLUMAGE	4
6	NGKILFR6G-E	889680001	BUJÍA	SPARK PLUG	CANDELA	BOUGIE	4
7	PAGB/T5783-M6X12	88552512	TORNILLO M6X12	BOLT M6X12	VITE M6X12	VIS M6X12	4
8	PAGB/T5783-M6X25	88552525	TORNILLO M6X25	BOLT M6X25	VITE M6X25	VIS M6X25	15
9	PAF15-07000030	892454035	TORNILLO M6X36	BOLT M6X36	VITE M6X36	VIS M6X36	20
10	PAGB/T5787-M6X30	892454030	TORNILLO M6X30	BOLT M6X30	VITE M6X30	VIS M6X30	2
11	RM27-8M0024565	896277006	JUNTA CULATA	GASKET CYLINDER HEAD	GUARNIZIONE TESTATA	JOINT DE CULASSE	1
12	REC8M0148668	885342001	SENSOR TEMPERATURA	TEMPERATURE SENSOR	SENSORE TEMPERATURA	SONDE DE TEMPERATURE	2
13	PAGB/T6182-2000	401388	TUERCA DE CIERRE M8	LOCKNUT M8	DADO CHIUSURA M8	ECROU FREIN M8	2
14	PAGB/T6170-85	400213	TUERCA	NUT	DADO	ÉCROU	2
15	PAGB/T5782-M8X40	88552640	TORNILLO M8X40	BOLT M8X40	VITE M8X40	VIS M8X40	4
16	REC26-8M0032912	26-8M0032912	RETÉN CIGUEÑAL	OIL SEAL	PARAOLIO	JOINT SPI VILEBREQUIN	1
17	PAGB/T5783-M5X16	40011107	TORNILLO M5X16	BOLT M5X16	VITE M5X16	VIS M5X16	2
18	REC8M0082988	8283582	SENSOR POSICION CIGÜENAL	SENSOR CRANSHAFT POSITION	SENSORE POSIZIONE ALBERO MOTORE	SONDE DE POSITION VILEREQUIN	1
19	PAF8-00000003	88552635	TORNILLO M8X35	BOLT M8X35	VITE M8X35	VIS M8X35	1
20	REC27-896142	896142	JUNTA BASE MOTOR	GASKET ENGINE	GUARNIZIONE BASE MOTORE	JOINT DE TETE MOTICE	1
21	PAGB/T5787-1986	895810050	TORNILLO M8X50	BOLT M8X50	VITE M8X50	VIS M8X50	2
22	PAF25-00000006	892086120	TORNILLO M10X120	BOLT M10X120	VITE M10X120	VIS M10X120	2

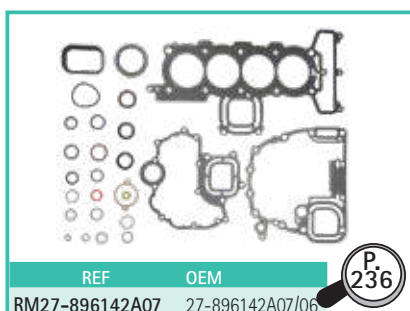

4T 200, 225, 250, 275, 300 HP VERADO (6 CYL)
STROKES

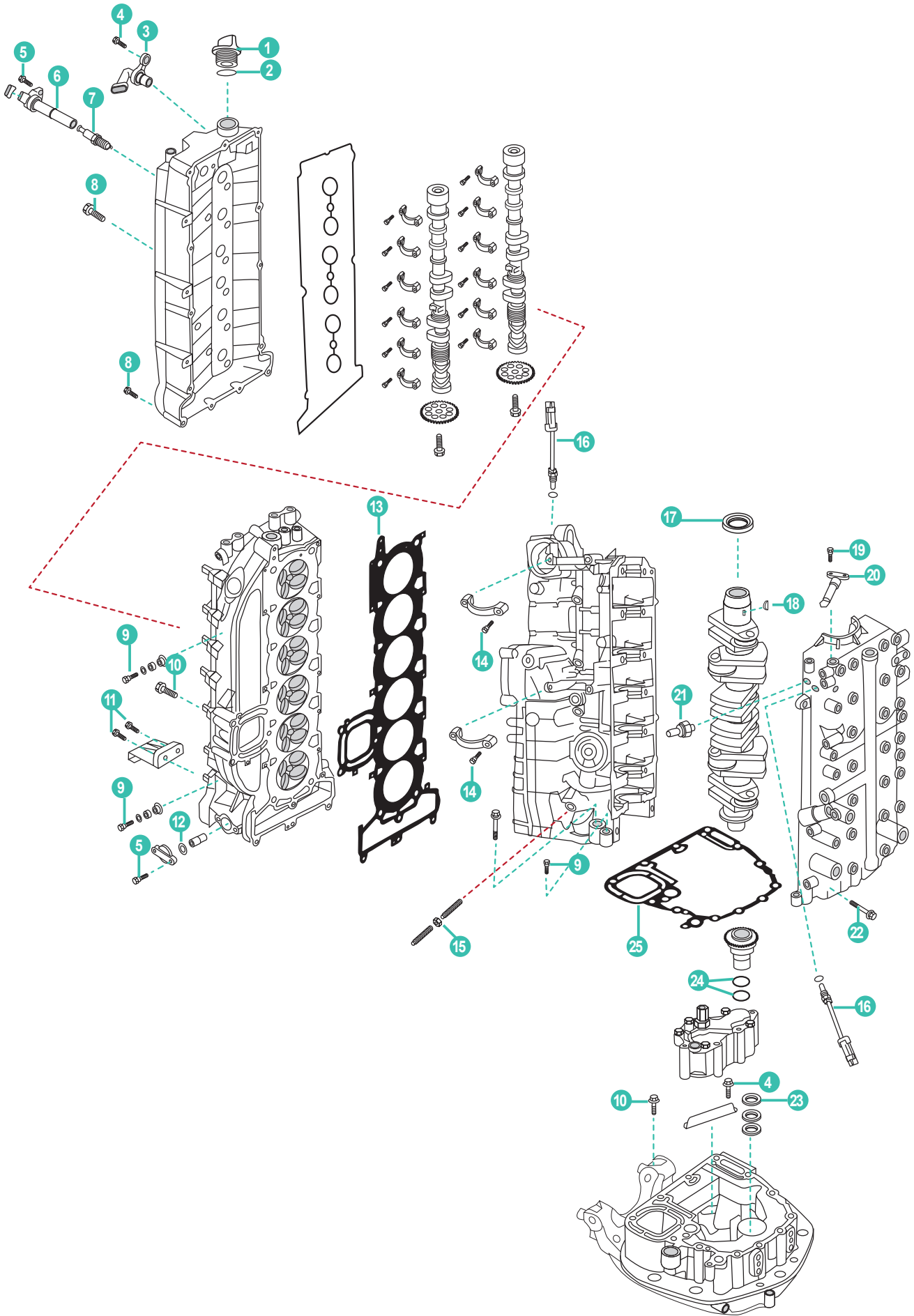

MERCURY MARINER

RECAMBIOS MARINOS

	REF	OEM				UN.	
1	PAF15-07050004	859578A1	TAPÓN ACEITE	OIL CUP	TAPPO OLIO	BOUCHON D'HUILE	1
2	PAJASOF404-35-025	90196	ARO TÓRICO	O-RING	O-RING	JOINT TORIQUE	1
3	REC8M0011987	8M0011987	SENSOR ARBOL LEVAS	CAMSHAFT SENSOR	SENSORE ALBERO A CAMME	CAPTEUR D'ARBRE À CAMES	1
4	PAGB/T5783-M6X16	88552516	TORNILLO M6X16	BOLT M6X16	VITE M6X16	VIS M6X16	1
5	PAF8-05000022	88552525	TORNILLO M6X25	BOLT M6X25	VITE M6X25	VIS M6X25	6
6	REC339-880615T01	880615T01	BOBINA COMPLETA	COIL ASSY	BOBINA ASCENSIONE	BOBINE D'ALLUMAGE	6
7	NGKILFR6G-E	889246Q39	BUJÍA	SPARK PLUG	CANDELA	BOUGIE	6
8	PAGB/T5783-M6X25	88552525	TORNILLO M6X25	BOLT M6X25	VITE M6X25	VIS M6X25	3
9	PAGB/T5783-M8X35	88552635	TORNILLO M8X35	BOLT M8X35	VITE M8X35	VIS M8X35	2
10	PAGB/T5783-M6X12	88552512	TORNILLO M6X12	BOLT M6X12	VITE M6X12	VIS M6X12	3
11	PAGB/T5783-M6X30	892454030	TORNILLO M6X30	BOLT M6X30	VITE M6X30	VIS M6X30	2
12	REC25-898836	898836	ARO TÓRICO	O-RING	O-RING	JOINT TORIQUE	1
13	RM27-8M0033476	8M0024564	JUNTA CULATA	GASKET CYLINDER HEAT	GUARNIZIONE TESTATA	JOINT DE CULASSE	1
14	PAGB/T5782-M8X40	88552640	TORNILLO M8X40	BOLT M8X40	VITE M8X40	VIS M8X40	4
15	PAGB/T6182-2000	401388	TUERCA	NUT	DADO	ÉCROU	1
16	REC8M0142542	8M0010146	SENSOR TEMPERATURA	TEMPERATURE SENSOR	SENSORE TEMPERATURA	SONDE DE TEMPERATURE	1
17	REC26-8M0032912	8M0032912	RETÉN CIGÜEÑAL	OIL SEAL	PARAOLIO	JOINT SPI VILEBREQUIN	1
18	PAF25-05000024	91800	CHAVETA VOLANTE	KEY SEMISIRCLE FLYWHEEL	CIAVETTA VOLANTE	CLAVETTE VOLANT MOTEUR	1
19	PAGB/T5783-M5X16	40011107	TORNILLO M5X16	BOLT M5X16	VITE M5X16	VIS M5X16	2
20	REC8M0082988	8283582	SENSOR POSICION CIGÜEÑAL	SENSOR CRANSHAFT POSITION	SENSORE POSIZIONE ALBERO MOTORE	SONDE DE POSITION VILEREQUIN	1
21	REC8M6000634	889659002	SENSOR PRESION DE ACEITE	OIL PRESSURE SENSOR	SENSORE PRESSIONE OILIO	SONDE PRESSION D'HUILE	1
22	PAGB/T5783-M8X50	985810050	TORNILLO M8X50	BOLT M8X50	VITE M8X50	VIS M8X50	2
23	REC26-8M0033928	884461	RETÉN ACEITE	OIL SEAL	PARAOLIO	JOINT SPI	1
24	REC25-8M0034912	895791	ARO TÓRICO	O-RING	O-RING	JOINT TORIQUE	2
25	REC27-880624003	880624003	JUNTA BASE MOTOR	GASKET	GUARNIZIONE MOTORE	JOINT DE TETE MOTRICE	1

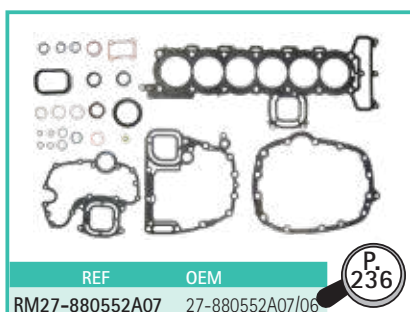

4T 225 EFI V6 (OT653945+)

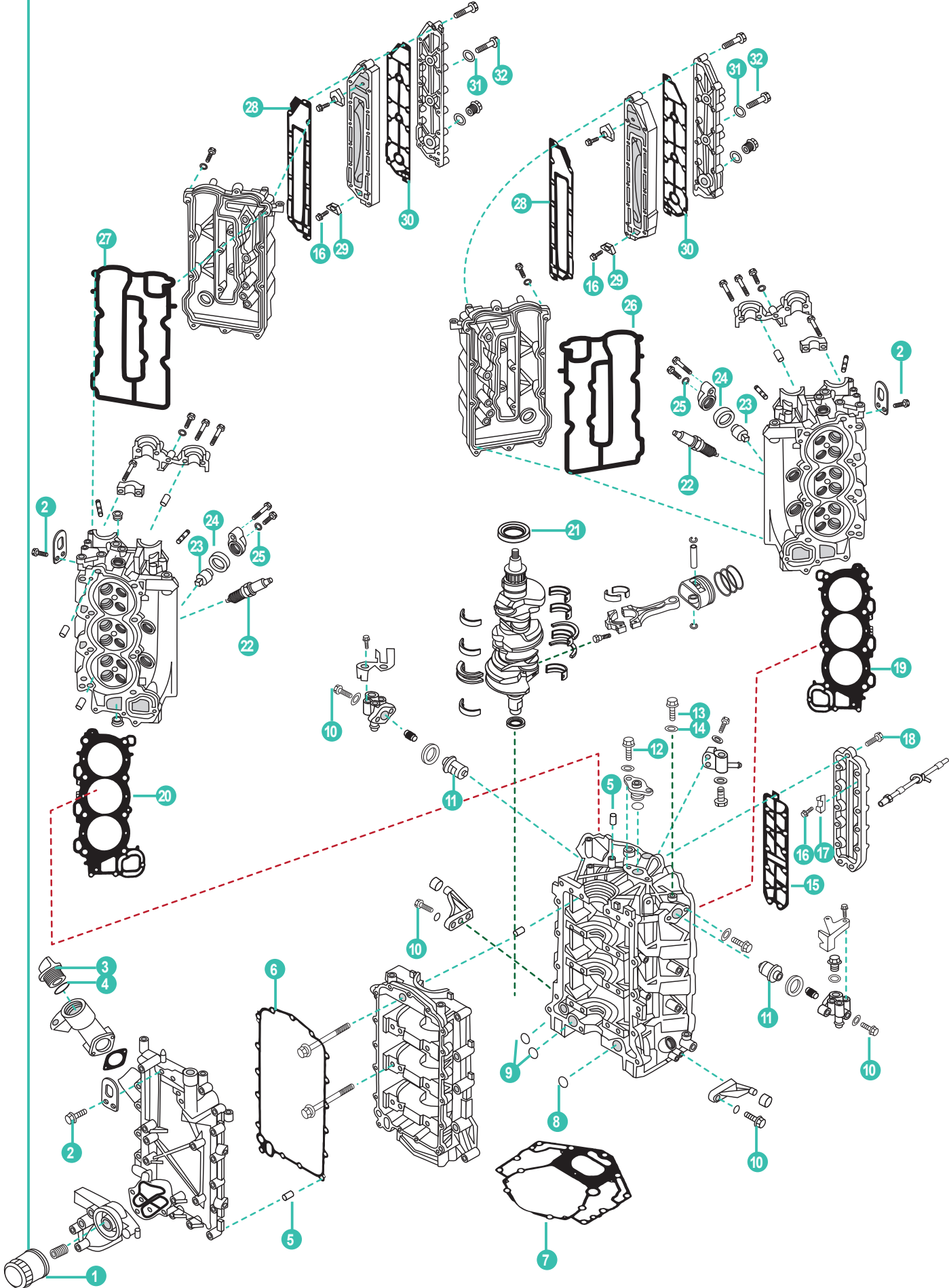

	REF	OEM				UN.	
1	REC35-822626Q15	822626T7	FILTRO ACEITE	OIL FILTER	FILTRO DELL'OLIO	FILTRE À HUILE	1
2	PAGB/T5783-M6X16	881428	TORNILLO M6X16	BOLT M6X16	VITE M6X16	VIS M6X16	6
3	PAF15-07050004	859578A1	TAPÓN ACEITE	PLUG, OIL	TAPPO OLIO	BOUCHON REMPLISSAGE D'HUILE	1
4	PAJASOF40431-025	90196	TÓRICA	O-RING	O-RING	JOINT TORIQUE	1
5	REC93606-12019	82364M	PIN CENTRADOR	PIN DOWEL	SPINOTTO DI CENTRAGGIO	PIN DE CENTRAGE	3
6	REC69J-15451-00	887825	JUNTA	GASKET	GUARNIZIONE	JOINT	1
7	REC69J-11351-11	887810010	JUNTA BASE MOTOR	GASKET ENGINE	GUARNIZIONE BASE MOTORE	JOINT DE TETE MOTRICE	1
8	REC93210-25552	887812	TÓRICA	O-RING	O-RING	JOINT TORIQUE	1
9	REC93210-19MJ1	858581	TÓRICA	O-RING	O-RING	JOINT TORIQUE	2
10	PAGB/T5782-M6X25	8248326	TORNILLO M6X25	BOLT M6X25	VITE M6X25	VIS M6X25	8
11	REC67F-12411-01	8556761	TERMOSTATO	THERMOSTAT	TERMOSTATO	THERMOSTAT	2
12	PAGB/T5783-M6X20	8257021	TORNILLO M6X20	BOLT M6X20	VITE M6X20	VIS M6X20	2
13	PAF15-04000002	825953	TORNILLO DRENAJE ACEITE	BOLT, OIL DRAIN	VITE DRENAGGIO OLIO	VIS DE VIDANGE	1
14	PAF15-04000003	81990M	JUNTA	GASKET	GUARNIZIONE	JOINT	1
15	REC6P2-1131B-00	887805	JUNTA	GASKET	GUARNIZIONE	JOINT	1
16	PAGB/T820-M4X12	827443001	TORNILLO M4X12	BOLT M4X12	VITE M4X12	VIS M4X12	6
17	CM15026A	11761001	ÁNODO	ANODE	ANODO	ANODE	4
18	PAGB/T5783-M6X30	881427	TORNILLO M6X30	SCREW M6X30	VITE M6X30	VIS M6X30	13
19	REC69J-11182-03	8878481	JUNTA CULATA BABOR	GASKET, CYLINDER HEAD PORT	GUARNIZIONE TESTATA BABORDO	JOINT DE CULASSE BABORD	1
20	REC69J-11181-03	887848	JUNTA CULATA ESTRIBOR	GASKET, CYLINDER HEAD STB	GUARNIZIONE TESTATA TRIBORDO	JOINT DE CULASSE TRIBORD	1
21	REC93102-63004	887830	RETÉN DE ACEITE	OIL SEAL	PARAOLIO	JOINT SPI	1
22	NGKFR5A-11	859495	BUJÍA	SPARK PLUG	CANDELA	BOUGIE	6
23	CM67F-11325-00	804079	ÁNODO	ANODE	ANODO	ANODE	4
24	REC67F-11328-00	804086	TAPÓN ÁNODO	GROMMET	TAPO ANODO	BOUCHON D'ANODE	4
25	REC90430-06M03	95610	JUNTA	GASKET	GUARNIZIONE	JOINT	2
26	REC6P2-11194-00	887855	JUNTA TAPA DE CULATA BABOR	GASKET, CYLINDER HEAD COVER PORT	GUARNIZIONE, COPERCHIO TESTATA BABORDO	JOINT DE CACHE CULBUTEUR BABORD	1
27	REC6P2-11193-00	887853	JUNTA TAPA DE CULATA ESTRIBOR	GASKET, CYLINDER HEAD COVER STB	GUARNIZIONE, COPERCHIO TESTATA TRIBORDO	JOINT DE CACHE CULBUTEUR TRIBORD	1
28	REC6P2-41122-00	887861 887861001	JUNTA ESCAPE	EXHAUST GASKET	GUARNIZIONE SCARICO	JOINT D'ECHAPPEMENT	2
29	CM689-11325-00A	11761001	ÁNODO	ANODE	ANODO	ANODE	2
30	REC6P2-41114-00	887862 887862001	JUNTA ESCAPE	EXHAUST GASKET	GUARNIZIONE SCARICO	JOINT D'ECHAPPEMENT	2
31	PAF4-04000006	831246	ARANDELA	WASHER	RONDELLA	RONDELLE	4
32	PAGB/T5783-M8X14	83124714	TORNILLO M8X14	BOLT M8X14	VITE M8X14	VIS M8X14	4
33	REC69J-12119-00	887870	RETÉN	SEAL	PARAOLIO	JOINT SPI	24
34	REC93102-38008	884144	RETÉN DE ACEITE	OIL SEAL	PARAOLIO	JOINT SPI	4
35	REC69J-46241-00	887883	CORREA DISTRIBUCIÓN	BELT, TIMING	CINGHIA DISTRIBUZIONE	COURROIE DISTRIBUTION	1

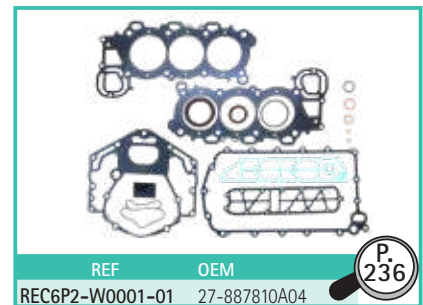
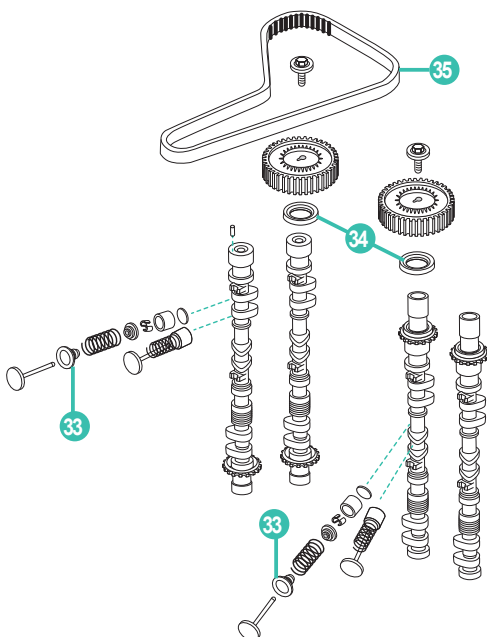

JUNTAS DE MOTOR
4 TIEMPOS

ENGINE GASKET
4 STROKES

GUARNIZIONI DE MO-
TORE 4 TEMPI

JOINTS DE MOTEUR
4 TEMPS

4T
STROKES

JUNTAS DE CULATA

CYLINDER HEAD GASKET

GUARNIZIONE DE TESTATA

JOINTS DE CULASSE

REF	OEM		
REC27-803508	27-803508	4, 5, 6 HP (1 cyl)	

P. 204

REF	OEM		
REC6G8-11181-A1	27-8254821	4, 5, 68 HP (232cc) 9.9HP (2 cyl)	

P. 205

REF	OEM		
PAF15-07000100	27-850836	8 HP (232cc) 9.9HP (323cc) 13.5, 15HP (2 cyl)	

P. 210

REF	OEM		
PAF8-05000100	27-850836001	8, 9.9 HP (209cc)	

P. 206

REF	OEM		
PAF25-05040000	8M0049885 27-830270	25 HP	

P. 214

REF	OEM		
REC67C-11181-01	27-834777 27-8M0118180	30, 30EFI, 40, 40EFI HP (3cyl)	

P. 218

REF	OEM		
REC8M0045278	27-8M0045278, 27-857081	40, 40EFI, 50, 50EFI, 60, 60EFI HP (L4-cyl)	

P. 222

REF	OEM		
REC27-825032	27-825032	40, 45, 50 HP	

REF	OEM		
REC67F-11181-03	27-8041151	75, 80, 90, 115EFI HP (L4-cyl)	

P. 224

REF	OEM		
RM27-8M0024565	27-8M0024565	Verado (4 cyl) 75, 80, 90, 100, 115 EFI	

P. 226
P. 228

REF	OEM		
REC27-8M6000366	27-8M6000366	150PRO XS (2B550139+) 150 SEAPRO (2B139139+) 150 (1B905505+) 135 (2B131942+)	

P. 227

new

REF	OEM	
RM27-8M0033476	27-895374006 8M0024564	Verado 6 Cyl

P. 230

REF	OEM		
REC69J-11182-03	27-887848-1	225 HP EFI	BABOR PORT BABORDO GAUCHE
REC69J-11181-03	27-887848		ESTRIBOR STD TRIBORDO DROIT

P. 232

REC69J-11182-03

REC69J-11181-03

4T
STROKES

KITS JUNTAS DE CULATA **CYLINDER HEAD GASKET KIT**

REF	OEM	
REC6G8-W0001-A3	27-825847A95	8 Bodensee (Inter.) 9.9 HP (232 cc)

KIT GUARNIZIONE TESTATA **KITS JOINTS DE CULASSE**

REF	OEM	
REC65W-W0001-00	27-830270A98	25 HP

REF	OEM	
REC3V1-87121-0	27-835427A04	8, 9,9 HP (209 cc)

REF	OEM	
REC67C-W0001-01	27-859352A02	30, 40 HP (3CYL) EFI

REF	OEM	
REC66M-W0001-01	27-835427A00	8, 9,9, 15HP 323 CC)

new

REF	OEM	
REC27-897534A07	27-897534A07	75, 80, 90, 100, 115 HP

new

MERCURY

RECAMBIO
MARINOS

new

REF	OEM	
REC67F-W0001-00	27-804345A02 27-858732T01 27-858732T02	75, 90 HP (0G960500-1B226999) 115EFI (1.741cc)

REF	OEM	
REC6P2-W0001-01	27-887810A04	225 EFI (0T807876 - 1B055687)

new

REF	OEM	
REC27-8M0057763	27-8M0057763	135, 150 HP PROXS, SEAPRO

REF	OEM	
RM27-896142A07	27-896142A06, A07	VERADO 4 CYL

REF	OEM	
RM27-880552A07	27-880552A07, A06	VERADO 6CYL

4T
STROKES

JUNTAS BASE DE MOTOR CYLINDER GASKET

REF	OEM	
PAF8-00000004	27-835427003	8, 9,9 HP (209CC)

GUARNIZIONE BASE MOTORE JOINTS DE TÊTE MOTRICE

REF	OEM	
REC6G8-11351-A0	27-825847	8 BODENSEE INTER. 9.9 HP (232CC)

REF	OEM	
PAF15-00000014	27-8354272	8 (Bondensee) Inter. 9.9 (323 cc) 13.5 Inter. 15

REF	OEM	
PAF25-00000013	27-8M0069692 8252312	25HP

REF	OEM	
REC67C-11351-00	892319001 27-859352	30 - 60 HP (Carb) EFI



REF	OEM	
REC27-8M0057703	27-8M0057703	135, 150 HP

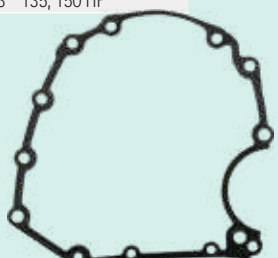

new

REF	OEM	
REC68V-11351-00	27-8587321	75 (Bodensee) 90 115 EFI



REF	OEM	
REC27-896142	27-896142	135-200 HP VERDADO (4CYL)

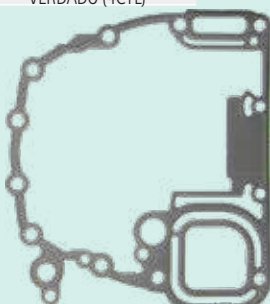

new

REF	OEM	
REC27-8M0024563	27-8M0024563 27-897534	75, 80, 90, 100, 115 EFI



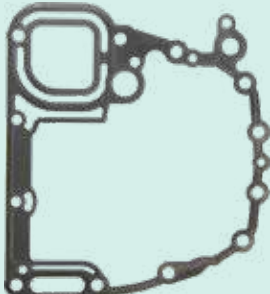

new

REF	OEM	
REC27-880624003	27-880624003	200-400 HP VERDADO 6CYL



new

REF	OEM	
REC69J-11351-11	27-887810011	225 EFI (2003-06)



4T
STROKES

GUÍA JUNTAS DE MOTOR	ENGINE GASKET GUIDE	GUIDA GUARNIZIONE MOTORE	GUIDE JOINTS DE MOTEURS
	CYL	JUNTA CULATA CYLINDER HEAD GASKET GUARNIZIONE TESTATA JOINT DE CULASSE	JUNTA BASE MOTOR CYLINDER GASKET GUARNIZIONE BASE MOTORE JOINT DE TETE MOTRICE
		KIT SUPERIOR TOP KIT KIT SUPERIORE KIT SUPERIEUR	
4HP	OP037456 +	1 REC27-803508	
5HP	OP037456 +	1 REC27-803508	
6HP	OP037456 +	1 REC27-803508	
8HP (209cc)	OP325500 +	2 PAF8-05000100	REC6G8-11351-A0
8HP (Bodensee) USA(232 cc)	OH000058 +	2 REC6G8-11181-A1	PAF8-00000004
8HP (Bodensee)	OP086824 - OP400999	2 PAF15-07000100	PAF15-00000014
8HP (Bodensee) USA(232 cc)	OH000058 +	2 REC6G8-11181-A1	PAF15-00000014
9.9HP (209cc)	OP325500 +	2 PAF8-05000100	PAF15-00000014
9.9HP (323cc)	OP075166 - OP400999	2 PAF15-07000100	PAF25-00000013
13.5HP (International)	OP134638 +	2 PAF15-07000100	REC67C-11351-00
15HP	OP9973100 +	2 PAF15-07000100	REC67C-11351-00
25HP	OP9973100 +	2 PAF25-05040000	REC67C-11351-00
30HP	OP017000 +	3 REC67C-11181-01	REC67C-11351-00
30HP (Carb) Et (EFI)	OP153500 - OP400999	3 REC67C-11181-01	REC67C-11351-00
40HP	OP0170000 - OP153499	3 REC67C-11181-01	REC67C-11351-00
40HP (Carb)	OP153500 +	3 REC67C-11181-01	REC67C-11351-00
40HP (EFI)	OP401000 +	3 REC67C-11181-01	REC67C-11351-00
40HP (EFI)	OP153500 +	4 REC8M0045278	REC67C-11351-00

		CYL	JUNTA CULATA CYLINDER HEAD GASKET GUARNIZIONE TESTATA JOINT DE CULASSE	JUNTA BASE MOTOR CYLINDER GASKET GUARNIZIONE BASE MOTORE JOINT DE TETE MOTRICE	KIT SUPERIOR TOP KIT KIT SUPERIORE KIT SUPERIEUR
40HP	9944807 - OP016999	4	REC27-825032	REC67C-11351-00	
40HP	OP094500 - OP206999	4	REC8M0045278	REC67C-11351-00	
40HP (Italy)	OP017000 - OP094499	4	REC27-825032	REC67C-11351-00	
45HP (Bodensee)	OP017000 +	4	REC27-825032	REC67C-11351-00	
50HP (Bigfoot)	OP9944807 +	4	REC27-825032	REC67C-11351-00	
50HP (EFI)	OP153500 +	4	REC8M0045278	REC67C-11351-00	
50HP	OP094500 - OP206999	4	REC8M0045278	REC68V-11351-00	RM858732T02
60HP (EFI)	OP153500 +	4	REC8M0045278	REC68V-11351-00	RM858732T02
60HP	OP094500 - OP206999	4	REC8M0045278	REC68V-11351-00	RM858732T02
75HP (Bodensee)	OG960500 +	4	REC67F-11181-03	REC68V-11351-00	RM858732T02
75HP (EFI)	1B172291 - 1B366822	4	REC67F-11181-03	REC68V-11351-00	RM858732T02
80HP (EFI)	1B227000 - 1B366822	4	REC67F-11181-03	REC68V-11351-00	RM858732T02
90HP (4 Stroke)	OG960500 +	4	REC67F-11181-03	REC68V-11351-00	RM858732T02
90HP (EFI)	1B172291 - 1B366822	4	REC67F-11181-03		
100HP (EFI)	1B227000 - 1B366822	4	REC67F-11181-03		RM27-896142A07
115HP (EFI)	OT178500 - 1B366822	4	REC67F-11181-03		RM27-896142A07
75/80/90/100 Et 115 (EFI)	1B494360 +	4	RM27-8M0024565		RM27-896142A07
135 (VERADO)	OP419487 +	4	RM27-8M0024565		RM27-896142A07
150 (VERADO)	OP419487 +	4	RM27-8M0024565		RM27-880552A07
175 (VERADO)	OP419487 +	4	RM27-8M0024565		RM27-880552A07
200 (VERADO)	OP514869 +	4	RM27-8M0024565	REC69J-11351-11	REC6P2-W0001-01
200HP (VERADO)	OP520553 +	6	RM27-8M0033476		RM27-880552A07
225SHP (VERADO)	OP409357 +	6	RM27-8M0033476		RM27-880552A07
225SHP (EFI)	OT653945 +	V6	REC69J-11181-03 REC69J-11182-03		RM27-880552A07
250HP (VERADO)	OP409357 +	6	RM27-8M0033476		RM27-880552A07
275SHP (VERADO)	OP464488 +	6	RM27-8M0033476		RM27-880552A07
300HP (VERADO)	OP520553 +	6	RM27-8M0033476		
350HP (VERADO)	2B141617 +	6	RM27-8M0033476		
400HP (VERADO)	2B141124 +	6	RM27-8M0033476		

4T
STROKES

RETENES ACEITE		OIL SEALS		PARAOLIO		JOINT SPI	
REF	RO OEM	EJE SHAFTT ASSE AXE	CALIBRE BORET GUE JOIE	REF	RO OEM	EJE SHAFTT ASSE AXE	CALIBRE BORET GUE JOIE
REC26-12709	26-12709	0.5000	0.6875	REC26-70081	26-70081	1.1875	1.7500
REC26-76868	26-14077	2.0000	2.6875	REC26-72785	26-72785	0.8125	1.8750
REC26-14240	26-14240	3.7500	4.5000	REC26-76868	26-76868	1.1875	1.6875
REC26-16977	26-16977	0.8750	1.2500	REC26-79831	26-79831	0.7500	0.7500
REC26-807006	26-18816	1.6750	2.2500	REC26-8164641	26-816464	0.3750	2.2500
REC908855	26-20070	0.6250	1.0000	REC26-821092	26-821092	1.5000	0.7500
REC26-24590	26-24590	0.4062	0.5625	REC26-00173	26-85107		
REC26-30913	26-30913	0.5000	0.8750	REC26-70080	26-89236	0.3750	1.5000
REC26-32511	26-32511	1.2500	2.0000	REC26-89238	26-89238	0.8750	1.2500
REC26-55682	26-32911	1.0000	1.2500	REC26-90562	26-90562	0.7500	1.5000
REC26-33467	26-33467	0.6250	1.1250	REC26-94038	26-94038	1.0000	0.8750
REC26-419533	26-41953	1.1875	1.8750	REC26-897153	26-90063	0.4375	1.3750
REC26-43036	26-43036	1.0469	1.4688	REC26-90562	26-90562		
REC26-43993	26-43943						
REC26-45587	26-45587	0.3906	0.6250				
REC26-55682	26-55682	1.0000	1.2500				
REC26-56397	26-56397	0.7500	1.1250				
REC320961	26-56788	0.8750	1.2500				
REC26-62818	26-62818	1.6250	2.2500				
REC26-823894	26-68493	2.2500	3.0000				
REC26-69188	26-69188	0.8750	1.2500				
REC26-69189	26-69189	0.8750	1.3125				



4T
STROKES

AROS TÓRICOS CULATA		CYLINDER HEAD O-RINGS		O-RINGS TESTAT		JOINT TORIQUE DE CULASSE	
REF	OEM			REF	OEM		
REC25-818573	25-818573	3.0L		REC93210-25552	25-887812	225 EFI V6 OT653945+	new
REC8597721	859772-1	V6 2.5L					
REC67C-11356-00	25-854341	30 -40 HP CARB Et EFI					



RETENES TAPA CULATA

GASKET CYLINDER SEALS

**PARAOILIO COPERCHIO
TESTATA**

**JOINT COUVERCLE DE
CULASSE**

REF	OEM	
PAF8-05000002	27-803508017	8, 9,9HP (209cc)



REF	OEM	
PAF15-07050002	850837	8 Bodensee 9.9 HP 13.5 HP 15 HP

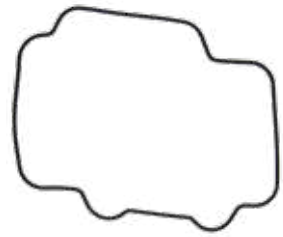

REF	OEM	
PAF25-05000004	25-833103	25HP

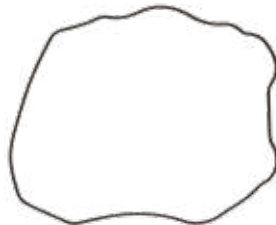



**GUÍA JUNTAS
EFI**

**ENGINE GASKET
EFI**

**GUIDA GUARNIZIONE
MOTORE EFI**

**GUIDE DES JOINTS MOTEUR
EFI**

			CYL			1	2
30 EFI	OP153500 - OP400999		3	REC67C-11351-00	REC67C-11181-01	PAF25-05020003	PAF25-05020002
30 EFI	OT409000 - 1B226999		3	REC67C-11351-00	REC67C-11181-01	PAF25-05020003	PAF25-05020002
30 EFI	1C109093 - 1C456299		3	REC67C-11351-00	REC67C-11181-01	PAF25-05020003	PAF25-05020002
30 EFI	1C456300 +		3	REC67C-11351-00		PAF25-05020003	PAF25-05020002
40 EFI	OP153500 - OP400999	BEL	3	REC67C-11351-00	REC67C-11181-01	PAF25-05020003	PAF25-05020002
40 EFI	OP401000 - OP515896	BEL	3	REC67C-11351-00	REC67C-11181-01	PAF25-05020003	PAF25-05020002
40 EFI	OP409000 - 1B226999	USA	3	REC67C-11351-00	REC67C-11181-01	PAF25-05020003	PAF25-05020002
40 EFI	1B227000 - 1B355027	USA	3	REC67C-11351-00	REC67C-11181-01	PAF25-05020003	PAF25-05020002
40 EFI	1C000001 - 1C043416		3	REC67C-11351-00	REC67C-11181-01	PAF25-05020003	PAF25-05020002
40 EFI	1C043417 - 1C456299		3	REC67C-11351-00	REC67C-11181-01	PAF25-05020003	PAF25-05020002
40 EFI	1C456300 +		3	REC67C-11351-00	REC67C-11181-01	PAF25-05020003	PAF25-05020002
40 EFI	OP153500 - OP400999	BEL	4	REC67C-11351-00	REC8M0045278	PAF25-05020003	PAF25-05020002
40 EFI	OP401000 - OP515896	BEL	4	REC67C-11351-00	REC8M0045278	PAF25-05020003	PAF25-05020002
40 EFI	OP515897 - OP580772	BEL	4	REC67C-11351-00	REC8M0045278	PAF25-05020003	PAF25-05020002
40 EFI	OT409000 - 1B355222	USA	4	REC67C-11351-00	REC8M0045278	PAF25-05020003	PAF25-05020002
40 EFI	1C000001 - 1C050251	USA	4	REC67C-11351-00	REC8M0045278	PAF25-05020003	PAF25-05020002
40 EFI	1C050252 - 1C453839	USA	4	REC67C-11351-00	REC8M0045278	PAF25-05020003	PAF25-05020002
40 EFI & SEAPRO	1C453840 +	USA	4	REC67C-11351-00	REC8M0045278	PAF25-05020003	PAF25-05020002
50 EFI	OP153500 - OP400999	BEL	4	REC67C-11351-00	REC8M0045278	PAF25-05020003	PAF25-05020002
50 EFI	OP401000 - OP515896	BEL	4	REC67C-11351-00	REC8M0045278	PAF25-05020003	PAF25-05020002
50 EFI	OP515897 - OP580772	BEL	4	REC67C-11351-00	REC8M0045278	PAF25-05020003	PAF25-05020002
50 EFI	OT409000 - 1B355222	USA	4	REC67C-11351-00	REC8M0045278	PAF25-05020003	PAF25-05020002
50 EFI	1C000001 - 1C050251	USA	4	REC67C-11351-00	REC8M0045278	PAF25-05020003	PAF25-05020002
50 EFI	1C050252 - 1C453839	USA	4	REC67C-11351-00	REC8M0045278	PAF25-05020003	PAF25-05020002
50 EFI	1C453840 +	USA	4	REC67C-11351-00	REC8M0045278	PAF25-05020003	PAF25-05020002
60 EFI	OP153500 - OP400999	BEL	4	REC67C-11351-00	REC8M0045278	PAF25-05020003	PAF25-05020002
60 EFI	OP401000 - OP515896	BEL	4	REC67C-11351-00	REC8M0045278	PAF25-05020003	PAF25-05020002
60 EFI	OP515897 - OP580772	BEL	4	REC67C-11351-00	REC8M0045278	PAF25-05020003	PAF25-05020002
60 EFI	OT409000 - 1B355222	USA	4	REC67C-11351-00	REC8M0045278	PAF25-05020003	PAF25-05020002
60 EFI	1C000001 - 1C050251	USA	4	REC67C-11351-00	REC8M0045278	PAF25-05020003	PAF25-05020002
60 EFI	1C050252 - 1C453839	USA	4	REC67C-11351-00	REC8M0045278	PAF25-05020003	PAF25-05020002
60 EFI & SEAPRO	1C453840 +	USA	4	REC67C-11351-00	REC8M0045278	PAF25-05020003	PAF25-05020002
75 EFI	1B172291 - 1B366822	USA	4	REC68V-11351-00	REC67F-11181-03		
75 EFI	1B366823 - 2B094995	USA	4	REC27-8M0024563	RM27-8M0024565	REC26-8M0032912	REC26-897540
80 EFI	OP459572 - 2B094995	BEL	4	REC27-8M0024563	RM27-8M0024565	REC26-8M0032912	REC26-897540
80 EFI	1B227000 - 1B366822	USA	4	REC68V-11351-00	REC67F-11181-03		
80 EFI	1B366823 - 2B094995	USA	4	REC27-8M0024563	RM27-8M0024565	REC26-8M0032912	REC26-897540
90 EFI	1B172291 - 1B366822	USA	4	REC68V-11351-00	REC67F-11181-03		
90 EFI	1B366823 - 2B094995	USA	4	REC27-8M0024563	RM27-8M0024565	REC26-8M0032912	REC26-897540
100 EFI	OP459572 - 2B094995	BEL	4	REC27-8M0024563	RM27-8M0024565	REC26-8M0032912	REC26-897540
100 EFI	1B227000 - 1B366822	USA	4	REC68V-11351-00	REC67F-11181-03		
100 EFI	1B366823 - 2B094995	USA	4	REC27-8M0024563	RM27-8M0024565	REC26-8M0032912	REC26-897540
115 EFI	OT178500 - OT800999	USA	4	REC68V-11351-00	REC67F-11181-03	REC93102-48009	
115 EFI	OT801000 - 1B226999	USA	4	REC68V-11351-00	REC67F-11181-03	REC93102-48009	
115 EFI	1B227000 - 1B366822	USA	4	REC68V-11351-00	REC67F-11181-03	REC93102-48009	
115 EFI	1B366823 - 2B094995	USA	4	REC27-8M0024563	RM27-8M0024565	REC26-8M0032912	REC26-897540
135	2B131942 +		4	REC27-8M0057703	REC27-8M6000366	REC26-8M0035127	
135 VERADO	OP419487 - OP464487	BEL	4	REC27-896142	RM27-8M0024565	REC26-8M0032912	

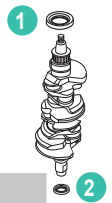

					 CYL	 1	 2
135 VERADO	OP464488 - OP514868	BEL	4	REC27-896142	RM27-8M0024565	REC26-8M0032912	
135 VERADO	OP514869 - OP593020	BEL	4	REC27-896142	RM27-8M0024565	REC26-8M0032912	
135 VERADO	1B227000 - 1B381711	USA	4	REC27-896142	RM27-8M0024565	REC26-8M0032912	
135 VERADO	1B381712 - 1B517158	USA	4	REC27-896142	RM27-8M0024565	REC26-8M0032912	
135 VERADO	1B517159 - 2B576734	USA	4	REC27-896142	RM27-8M0024565	REC26-8M0032912	
150	1B905505 +		4	REC27-8M0057703	REC27-8M6000366	REC26-8M0035127	
150 SEAPRO	2B139139 +		4	REC27-8M0057703	REC27-8M6000366	REC26-8M0035127	
150 Pro XS	2B550139 +		4	REC27-8M0057703	REC27-8M6000366	REC26-8M0035127	
150 VERADO	OP419487 - OP464487	BEL	4	REC27-896142	RM27-8M0024565	REC26-8M0032912	
150 VERADO	OP464488 - OP514868	BEL	4	REC27-896142	RM27-8M0024565	REC26-8M0032912	
150 VERADO	OP514869 - OP593020	BEL	4	REC27-896142	RM27-8M0024565	REC26-8M0032912	
150 VERADO	1B227000 - 1B381711	USA	4	REC27-896142	RM27-8M0024565	REC26-8M0032912	
150 VERADO	1B381712 - 1B517158	USA	4	REC27-896142	RM27-8M0024565	REC26-8M0032912	
150 VERADO	1B517159 - 2B576734	USA	4	REC27-896142	RM27-8M0024565	REC26-8M0032912	
175 VERADO	OP419487 - OP464487	BEL	4	REC27-896142	RM27-8M0024565	REC26-8M0032912	
175 VERADO	OP464488 - OP514868	BEL	4	REC27-896142	RM27-8M0024565	REC26-8M0032912	
175 VERADO	OP514869 - OP593020	BEL	4	REC27-896142	RM27-8M0024565	REC26-8M0032912	
175 VERADO	1B227000 - 1B381711	USA	4	REC27-896142	RM27-8M0024565	REC26-8M0032912	
175 VERADO	1B381712 - 1B517158	USA	4	REC27-896142	RM27-8M0024565	REC26-8M0032912	
175 VERADO	1B517159 - 2B576734	USA	4	REC27-896142	RM27-8M0024565	REC26-8M0032912	
200 VERADO	OP514869 - OP593020	BEL	4	REC27-896142	RM27-8M0024565	REC26-8M0032912	
200 VERADO	1B517159 - 2B576734	USA	4	REC27-896142	RM27-8M0024565	REC26-8M0032912	
200 VERADO	OP409357 - OP464487	BEL	6	REC27-880624003	RM27-8M0033476	REC26-8M0032912	
200 VERADO	OP464488 - OP520552	BEL	6	REC27-880624003	RM27-8M0033476	REC26-8M0032912	
200 VERADO	OP520553 - 2B144122	BEL	6	REC27-880624003	RM27-8M0033476	REC26-8M0032912	
200 VERADO	OT980000 - 1B226999	USA	6	REC27-880624003	RM27-8M0033476	REC26-8M0032912	
200 VERADO	1B227000 - 1B381711	USA	6	REC27-880624003	RM27-8M0033476	REC26-8M0032912	
200 VERADO	1B381712 - 1B517433	USA	6	REC27-880624003	RM27-8M0033476	REC26-8M0032912	
200 VERADO	1B517434 - 2B144122	USA	6	REC27-880624003	RM27-8M0033476	REC26-8M0032912	
200 VERADO	2B144123 - 2B578935	USA	6	REC27-880624003	RM27-8M0033476	REC26-8M0032912	
200 Pro VERADO	2B034840 - 2B144122		6	REC27-880624003	RM27-8M0033476	REC26-8M0032912	
200 Pro VERADO	2B144123 - 2B577715		6	REC27-880624003	RM27-8M0033476	REC26-8M0032912	
225 EFI	OT653945 +	USA	6	REC69J-11351-11	REC69J-11181-03 REC69J-11182-03	REC93102-63004	
225 VERADO	OP409357 - OP464487	BEL	6	REC27-880624003	RM27-8M0033476	REC26-8M0032912	
225 VERADO	OP464488 - OP520552	BEL	6	REC27-880624003	RM27-8M0033476	REC26-8M0032912	
225 VERADO	OP520553 - 2B144122	BEL	6	REC27-880624003	RM27-8M0033476	REC26-8M0032912	
225 VERADO	OT980000 - 1B226999	USA	6	REC27-880624003	RM27-8M0033476	REC26-8M0032912	
225 VERADO	1B227000 - 1B381711	USA	6	REC27-880624003	RM27-8M0033476	REC26-8M0032912	
225 VERADO	1B381712 - 1B517433	USA	6	REC27-880624003	RM27-8M0033476	REC26-8M0032912	
225 VERADO	1B517434 - 2B144122	USA	6	REC27-880624003	RM27-8M0033476	REC26-8M0032912	
225 VERADO	2B144123 - 2B578935	USA	6	REC27-880624003	RM27-8M0033476	REC26-8M0032912	
250 VERADO	OP409357 - OP464487	BEL	6	REC27-880624003	RM27-8M0033476	REC26-8M0032912	
250 VERADO	OP464488 - OP520552	BEL	6	REC27-880624003	RM27-8M0033476	REC26-8M0032912	
250 VERADO	OP520553 - 2B144122	BEL	6	REC27-880624003	RM27-8M0033476	REC26-8M0032912	
250 VERADO	OT980000 - 1B226999	USA	6	REC27-880624003	RM27-8M0033476	REC26-8M0032912	
250 VERADO	1B227000 - 1B381711	USA	6	REC27-880624003	RM27-8M0033476	REC26-8M0032912	
250 VERADO	1B381712 - 1B517433	USA	6	REC27-880624003	RM27-8M0033476	REC26-8M0032912	
250 VERADO	1B517434 - 2B144122	USA	6	REC27-880624003	RM27-8M0033476	REC26-8M0032912	
250 VERADO	2B144123 - 2B578935	USA	6	REC27-880624003	RM27-8M0033476	REC26-8M0032912	
250 PRO VERADO	1B830170 - 2B144122		6	REC27-880624003	RM27-8M0033476	REC26-8M0032912	
250 PRO VERADO	2B144123 - 2B577715	USA	6	REC27-880624003	RM27-8M0033476	REC26-8M0032912	
275 VERADO	OP409357 - OP464487	BEL	6	REC27-880624003	RM27-8M0033476	REC26-8M0032912	
275 VERADO	OP464488 - OP520552	BEL	6	REC27-880624003	RM27-8M0033476	REC26-8M0032912	
275 VERADO	OP520553 - 2B144122	BEL	6	REC27-880624003	RM27-8M0033476	REC26-8M0032912	
275 VERADO	OT980000 - 1B226999	USA	6	REC27-880624003	RM27-8M0033476	REC26-8M0032912	
275 VERADO	1B227000 - 1B381711	USA	6	REC27-880624003	RM27-8M0033476	REC26-8M0032912	
275 VERADO	1B381712 - 1B517433	USA	6	REC27-880624003	RM27-8M0033476	REC26-8M0032912	
275 VERADO	1B517434 - 2B144122	USA	6	REC27-880624003	RM27-8M0033476	REC26-8M0032912	
275 VERADO	2B144123 - 2B578935	USA	6	REC27-880624003	RM27-8M0033476	REC26-8M0032912	
300 VERADO	OP520553 - 2B144122	BEL	6	REC27-880624003	RM27-8M0033476	REC26-8M0032912	
300 VERADO	1B517434 - 2B144122	USA	6	REC27-880624003	RM27-8M0033476	REC26-8M0032912	
300 VERADO	2B144123 - 2B578935	USA	6	REC27-880624003	RM27-8M0033476	REC26-8M0032912	
300 PRO VERADO	1B830170 - 2B144122		6	REC27-880624003	RM27-8M0033476	REC26-8M0032912	
300 PRO VERADO	2B144123 - 2B577715	USA	6	REC27-880624003	RM27-8M0033476	REC26-8M0032912	
350SCi VERADO	1B716557 - 2B143542		6	REC27-880624003		REC26-8M0032912	
350 2.6L L6 VERADO	2B141617 +	USA	6	REC27-880624003		REC26-8M0032912	
350 2.6L L6 PRO VERADO	2B141124 +	USA	6	REC27-880624003		REC26-8M0032912	
400 2.6L L6 VERADO	2B618256 +	USA	6	REC27-880624003		REC26-8M0032912	
400R 2.6L L6 RACING	2B141124 +	USA	6	REC27-880624003		REC26-8M0032912	

BOMBA DE ACEITE

OIL PUMP

POMPA OLIO

POMPE À HUILE



4T
STROKES

BOMBA Y JUNTAS



GASKET & PUMPS

POMPE E GUARNIZIONE

POMPE ET JOINTS

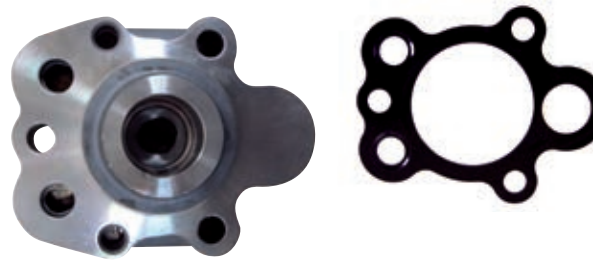
REF	OEM			OEM
PAF8-05030300	834967T03	8, 9.9 HP (209 cc)	PAF8-05030012	27-853523001



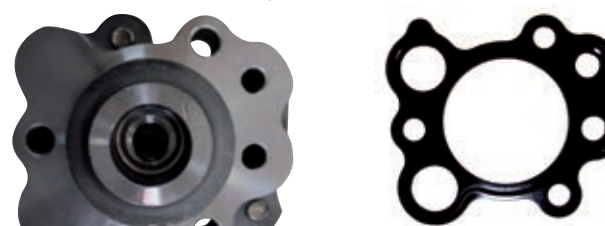

REF	OEM			OEM
PAF15-07040500	834967A1	8 HP (Bodensee) (inter.) 9.9 HP (323cc) 13.5 HP (inter.) 15 HP	PAF15-07040016	27-853523



REF	OEM	
PAF25-05050400	852388T1	25 HP



REF	OEM			OEM
PAF40-05040400	857087T1	30, 40, 50, 60 HP	PAF40-05040407	



new

CIGÜEÑAL

CRANKSHAFT

ALBERO MOTORE

VILEBREQUIN

4T
STROKES

GUÍA CIGÜEÑAL COMPLETO

GUIDE CRANKSHAFT ASSY

GUIDA ALBERO MOTORE COMPLETO

GUIDE VILEBREQUIN COMPLET

	cyl	BEL SERIE	1	2	3
2.5HP, 3.5HP		OR131842+			REC30-16049
4 HP		OP401000+	REC26-803514	REC26-8537077	
5 HP		OP073456+	REC26-803514	REC26-8537077	
5 HP		OP073456+	REC26-803514	REC26-8537077	
8HP (209cc)		OP325500+	PAF8-05020001	PAF8-05020001	
8 HP Bodensee		OP086824 - OP400999	PAF15-07030006	PAF15-07030007	
9.9HP (209cc)		OP325500+	PAF8-05020001	PAF8-05020001	
9.9HP (323cc)		OP075166 - OP400999	PAF15-07030006	PAF15-07030007	
13.5HP (Intern.)		OP401000+	PAF15-07030006	PAF15-07030007	
15HP		9973100	PAF15-07030006	PAF15-07030007	
25HP		9973100	PAF25-05020003	PAF25-05020002	
30HP		OP017000+	PAF25-05020003	PAF25-05020002	
30HP Carb	3	OP153500 - OP400999	PAF25-05020003	PAF25-05020002	
30HP EFI	3	OP153500 - OP400999	PAF25-05020003	PAF25-05020002	
40HP		9944807	PAF25-05020003	PAF25-05020002	
40HP Carb	3	OP153500+	PAF25-05020003	PAF25-05020002	
40HP	4	OP094500 - OP206999	PAF25-05020003	PAF25-05020002	
40HP EFI	3	OP401000+	PAF25-05020003	PAF25-05020002	
40HP EFI	4	OP153500	PAF25-05020003	PAF25-05020002	
40HP ITALY	4	OP017000 - OP094499	PAF25-05020003	PAF25-05020002	
45HP Bodensee		OP017000+	PAF25-05020003	PAF25-05020002	
50HP		9944807	PAF25-05020003	PAF25-05020002	
50HP BIGFOOT		OP017000+	PAF25-05020003	PAF25-05020002	
50HP EFI	4	OP153500+	PAF25-05020003	PAF25-05020002	
50HP	4	OP094500 - OP206999	PAF25-05020003	PAF25-05020002	
60HP	4	OP094500 - OP206999	PAF25-05020003	PAF25-05020002	
60HP EFI	4	OP153500+	PAF25-05020003	PAF25-05020002	

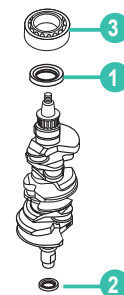

MERCURY

RECAMBIOS MARINOS

4T
STROKES

COJINETES

BEARING

CUSCINETTO

ROULEMENT

REF	OEM	
REC30-16049	30-16049	4, 5, 6, 8, 9, 8 HP



REF	OEM	
REC30-72961	31-72961	3,6, 7,5, 9,8 HP 4, 4,5 HP



new

PISTONES

PISTONS

PISTONI

PISTONS

4T
STROKES

KITS DE PISTONES





PISTON KITS

KIT PISTONE

KIT PISTON

	STD	OEM	
	REF		
	PAF8-05020101	700-834963A02	
	REC39-8M0055809	39-8M0055809	8 HP (209 cc) 9.9 HP (209 cc)
	PAF8-05020105	41-825713001	
	PAF15-07020005	53-16057	



	STD	OEM	
	REF		
	PAF15-07020001	700-834963	8 HP (Bodensee) (inter.) 9.9 HP (323cc) 13.5 HP (inter.) 15 HP
	REC66N-11603-00		
	PAF15-07020006	41-825713	
	PAF15-07020005	53-82345M	



	STD	OEM	
	REF		
	PAF40-05020101	700-893524T08	
	REC67C-11603-00	39-893525A01	25, 30, 40, 50, 60 HP CARB & EFI
	PAF25-05020105	41-893863	
	PAF25-05020106	40-893529	



new



4T
STROKES

GUÍA CIGÜEÑAL, BIELAS Y PISTON

GUIDE CONNECTING ROD, CRANKSHAFT & PISTON

GUIDA ALBERO MOTORE, BIELLE E PISTONE

GUIDE VILEBREQUIN, BIELLES ET PISTONES

	BEL SERIE			
8 Bodensee (Inter.)	OP086824 - OP4000999	PAF15-07020100	PAF15-07030000	PAF15-07020001
8 & 9.9 (209cc)	OP325500 +	PAF8-05020200	PAF8-05020001	PAF8-05020101
9.9 (323cc)	OP075166 - OP400999	PAF15-07020100	PAF15-07030000	PAF15-07020001
13.5 (Inter.)	OP134638 +	PAF15-07020100	PAF15-07030000	PAF15-07020001
15.	9973100	PAF15-07020100	PAF15-07030000	PAF15-07020001
25.	9973100	PAF25-05020200	PAF25-05020001	PAF25-05020100
30, 40, 50, 60		PAF25-05020200	PAF40-05000001	PAF40-05020101

DESPIECE MOTOR DE 2
TIEMPOS

ENGINE PARTS
2 STROKES

PARTI DEL MOTORE
2 TEMPI

PIECES MOTEUR
2 TEMPS

2T MARINER 4A
STROKES (6E0-001011+ (M), (6E0-300101+ (ML)

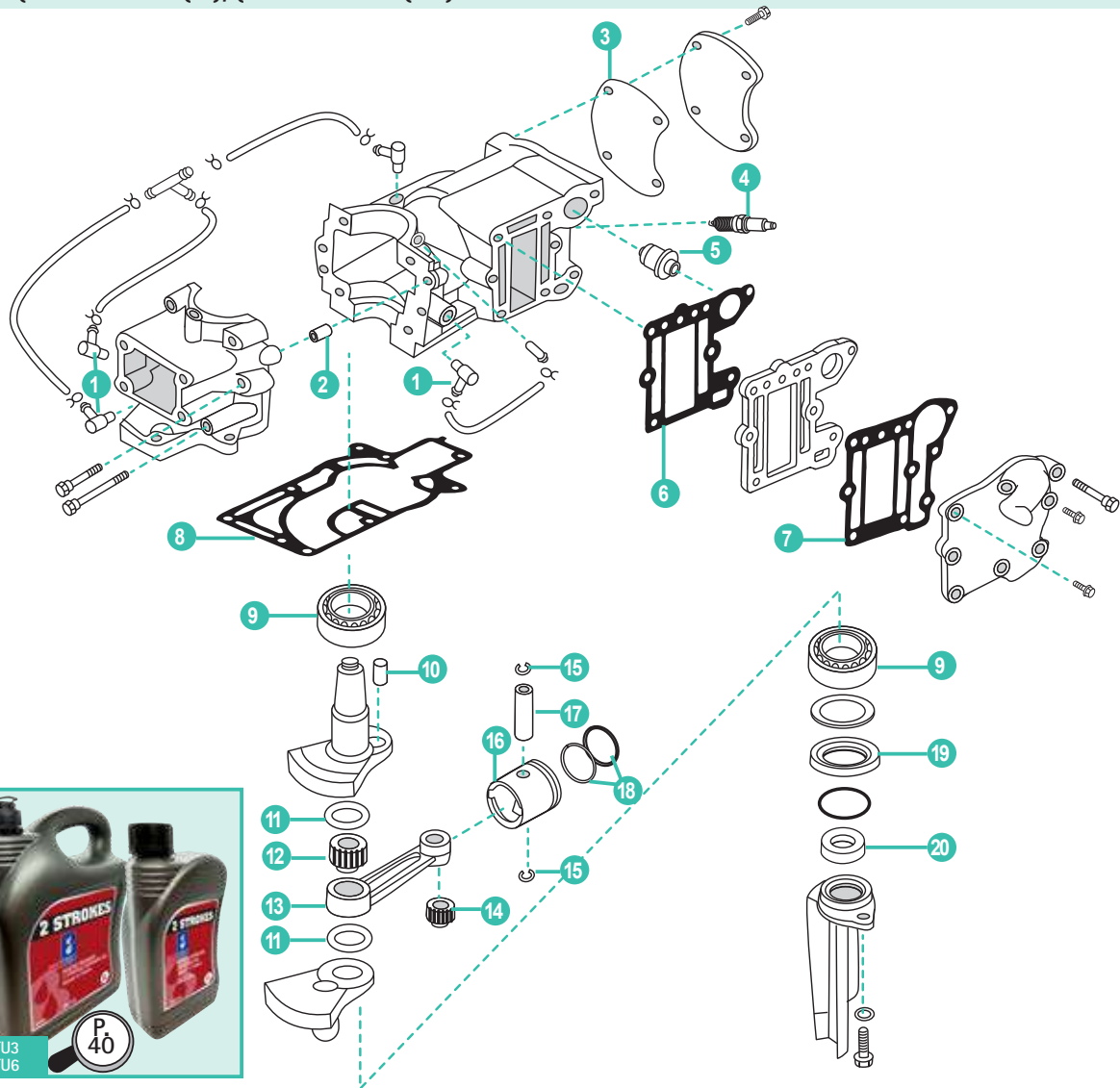

	REF	OEM				UN.	
1	REC650-11370-00	21-80727M	VÁLVULA	CHECK VALVE ASSY	VALVOLA	VALVE	3
2	REC93606-12019	18842M	PIN	PIN	SPINOTTO	LEVIER	2
3	REC6E0-11193-A1	27-9991M	JUNTA TAPA	COVER GASKET	GUARNIZIONE COPERCHIO	JOINT DE COUVERCLE	1
4	NGKBR7HS	33-53098	BUJÍA	SPARK PLUG	CANDELA	BOUGIE	1
5	REC6E5-12411-02	83282M	TERMOSTATO	THERMOSTAT	TERMOSTATO	THERMOSTAT	1
6	REC6E0-41112-A1	27-99995M	JUNTA ESCAPE	EXHAUST GASKET	GUARNIZIONE SCARCIO	JOINT D'ÉCHAPPEMENT	1
7	REC6E0-41114-A1	27-99993M	JUNTA ESCAPE	EXHAUST GASKET	GUARNIZIONE SCARCIO	JOINT D'ÉCHAPPEMENT	1
8	REC6E0-45113-A1	27-91780	JUNTA BASE	ENGINE GASKET	GUARNIZIONE MOTORE	JOINT DE TÊTE MOTRICE	1
9	REC93306-204U0	30-18859M	RODAMIENTO	BEARING	CUSCINETTO	ROULEMENT	2
10	REC6G1-11681-00		PASADOR	PIN	FERMO	GOUPILLE	1
11	REC90209-18112		ARANDELA	WASHER	RONDELLA	RONDELLE	1
12	REC93310-418V1		RODAMIENTO	BEARING	CUSCINETTO	ROULEMENT	1
13	REC6E0-11651-01		BIELA	CONNECTING ROD	BIELLA	BIELLE	2
14	REC93310-112V0	31-91721M	RODAMIENTO	BEARING	CUSCINETTO	ROULEMENT	1
15	REC93450-13022	53-82342M	CIRCLIP	CIRCLIP	CIRCLIP	CIRCLIP	2
16	REC6E0-11631-00-98K	761-8256M	PISTON	PISTON	PISTONE	PISTON	1
17	REC6G1-11633-00	41-95601M	BULÓN	PIN, PISTON	BULLONE	AXE DE PISTON	1
18	REC6G1-11610-00	39-11462M	KIT AROS PISTON	PISTON RING	FASCE PISTONI	KIT SEGMENTS	1
	REC6J1-11610-00	39-14197M	KIT AROS PISTON (5C)	PISTON RING (5C)	FASCE PISTONI (5C)	KIT SEGMENTS (5C)	1
19	REC93101-20M29	26-18843M	RETÉN	SEAL OIL	PARAOILIO	JOINT SPI	1
20	REC93101-10M25	26-95472M	RETÉN	SEAL OIL	PARAOILIO	JOINT SPI	1

2T 4 HP • 5 HP
STROKES

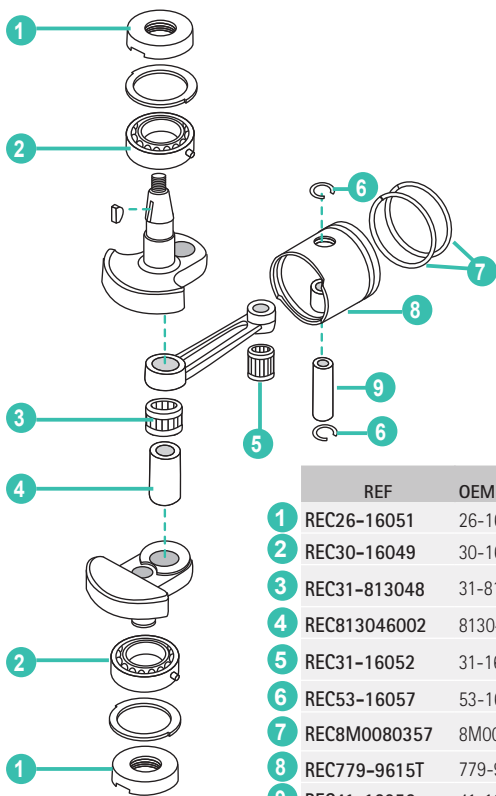

	REF	OEM					UN.
1	REC26-16051	26-16051	RETÉN ACEITE	OIL SEAL	PARAOLIO	JOINT SPI	2
2	REC30-16049	30-16049	RODAMIENTO	BEARING	CUSCINETTO	ROULEMENT	2
3	REC31-813048	31-813048	COJINETE DE AGUJA	BEARING	CUSCINETTO	ROULEMENT À AIGUILLE	1
4	REC813046002	813046002	PIN CENTRADOR	PIN DOWEL	SPINOTTO DI CENTRAGGIO	PIN DE CENTRAGE	1
5	REC31-16052	31-16052	COJINETE ADE AGUJA	BEARING	CUSCINETTO	ROULEMENT À AIGUILLE	1
6	REC53-16057	53-16057	CIRCLIP	CIRCLIP	CIRCLIP	CIRCLIP	2
7	REC8M0080357	8M0080357	KIT SEGMENTOS DE PISTÓN	PISTON RING KIT	KIT FASCIA PISTONE	KIT SEGMENTS	2
8	REC779-9615T	779-9615T	PISTÓN STD	PISTON STD	PISTONE STD	PISTON STD	1
9	REC41-16056	41-16041	PIN, PISTÓN	PIN, PISTON	SPINOTTO PISTONE	AXE DE PISTON	1



2T 6, 8, 9.8 HP (2 CYL) INT.
STROKES

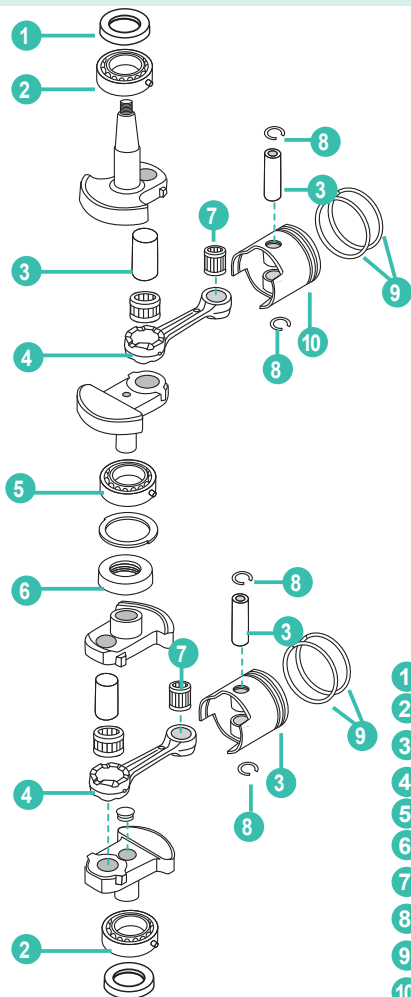

	REF	OEM					UN.
1	REC26-803514	25-803514	RETÉN ACEITE	OIL SEAL	PARAOLIO	JOINT SPI	1
2	REC30-16049	30-16049	RODAMIENTO	BEARING	CUSCINETTO	ROULEMENT	2
3	REC41-8036801	41-8036801	PIN CENTRADOR	PIN DOWEL	SPINOTTO DI CENTRAGGIO	PIN DE CENTRAGE	2
4	REC629-8036741	629-8036741	BIELA	CONNECTING ROD	BIELLA	BIELLE	2
5	REC30-16049	30-16049	RODAMIENTO	BEARING	CUSCINETTO	ROULEMENT	1
6	REC26-85370711	26-85370711	RETÉN ACEITE	OIL SEAL	PARAOLIO	JOINT SPI	1
7	REC31-8036752	31-8036752	COJINETE ADE AGUJA	BEARING	CUSCINETTO	ROULEMENT À AIGUILLE	2
8	REC53-16057	53-16057	CIRCLIP	CIRCLIP	CIRCLIP	CIRCLIP	2
9	REC39-803678A3	39-803678A3	KIT SEGMENTOS DE PISTÓN	PISTON RING KIT	KIT FASCIA PISTONE	KIT SEGMENTS	4
10	REC779-804886	779-804886	PISTÓN STD	PISTON STD	PISTONE STD	PISTON STD	2



2T MARINER 6C/D, 8C
STROKES

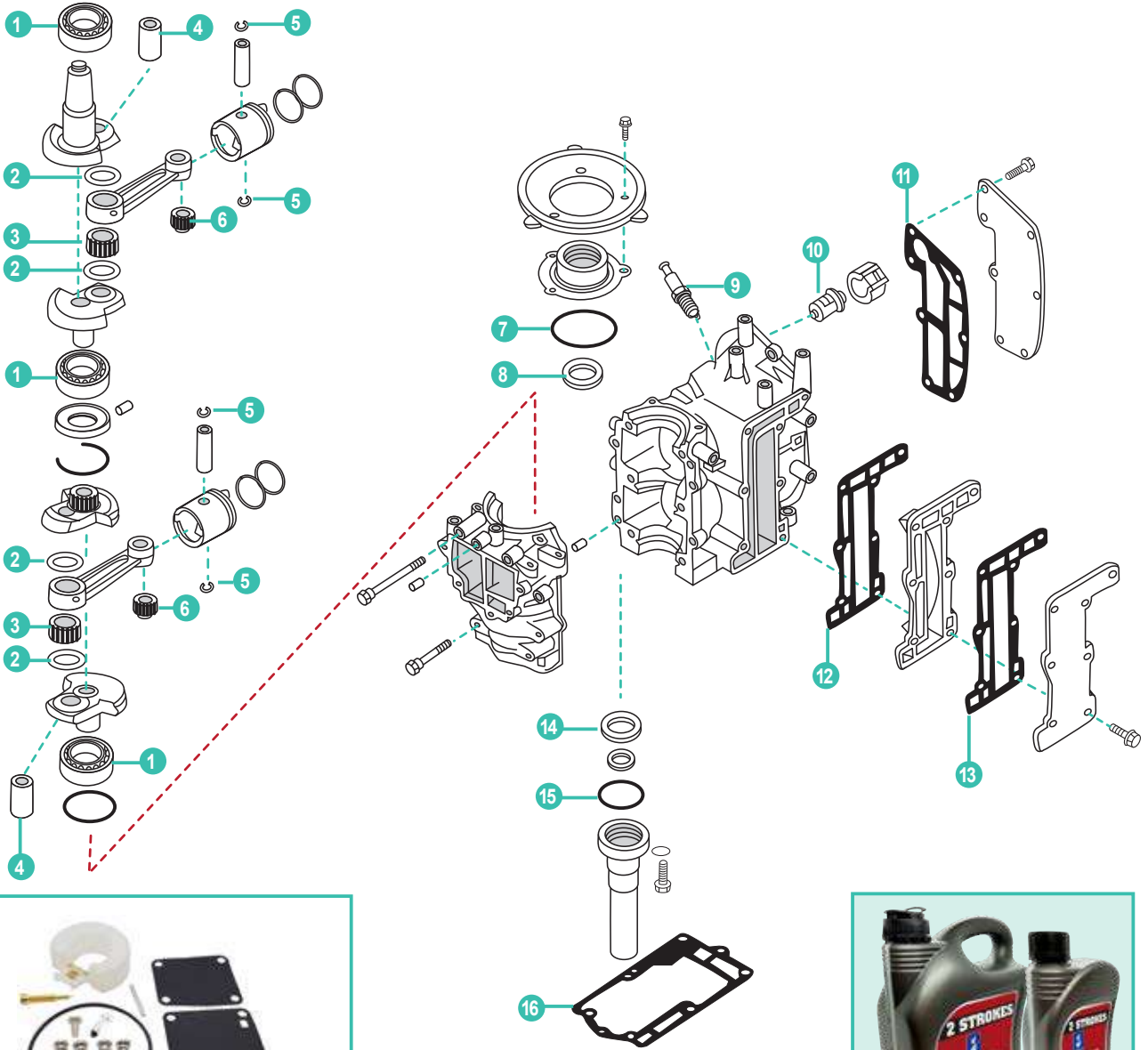

REF	OEM
REC6G1-W0093-00	11502M

	REF	OEM					UN.
1	REC93306-204U0	30-82299M	RODAMIENTO	BEARING	CUSCINETTO	ROULEMENT	3
2	REC90209-18112		ARANDELA	WASHER	RONDELLA	RONDELLE	4
3	REC93310-418V1		RODAMIENTO	BEARING	CUSCINETTO	ROULEMENT	2
4	REC6G1-11681-00		PIN CENTRADOR	PIN DOWEL	SPINOTTO DI CENTRAGGIO	PIN DE CENTRAGE	2
5	REC93450-13022	53-82342M	CIRCLIP	CIRCLIP	CIRCLIP	CIRCLIP	4
6	REC93310-112V0	31-91721M	RODAMIENTO	BEARING	CUSCINETTO	ROULEMENT	2
7	REC93210-54M54	25-11451M	ARO TÓRICO	O-RING	O-RING	JOINT TORIQUE	1
8	REC93102-20M25	26-14195M	RETÉN ACEITE	OIL SEAL	PARAOLIO	JOINT SPI	1
9	NGKBR7HS-10	33-41263M	BUJÍA	SPARK PLUG	CANDELA	BOUGIE	2
9	NGKBR6HS-10	33-11458M	BUJÍA	SPARK PLUG	CANDELA	BOUGIE	2
10	REC6E5-12411-02	11919M	TERMOSTATO	THERMOSTAT	TERMOSTATO	THERMOSTAT	1
11	REC6G1-11193-A1	27-11454M	JUNTA TAPA TERMOSTATO	GASKET VALVE COVER	GUARNIZIONE COPERCHIO VALVOLA	JOINT DE COUVERCLE	1
12	REC6G1-41112-A1	27-11456M	JUNTA ESCAPE	EXHAUST GASKET	GUARNIZIONE SCARICO	JOINT D'ECHAPPEMENT	1
13	REC6G1-41114-A0	27-11456M	JUNTA ESCAPE	EXHAUST GASKET	GUARNIZIONE SCARICO	JOINT D'ECHAPPEMENT	1
14	REC93101-20M34	23-81841M	RETÉN ACEITE	OIL SEAL	PARAOLIO	JOINT SPI	1
15	REC93210-42159	26-94663M	ARO TÓRICO	O-RING	O-RING	JOINT TORIQUE	1
16	REC6G1-45113-A1	27-11560M	JUNTA BASE	ENGINE GASKET	GUARNIZIONE MOTORE	JOINT DE TETE MOTRICE	1

2T 8K (K-LONG / K-SHORT)
W8 (W/MARATHON)

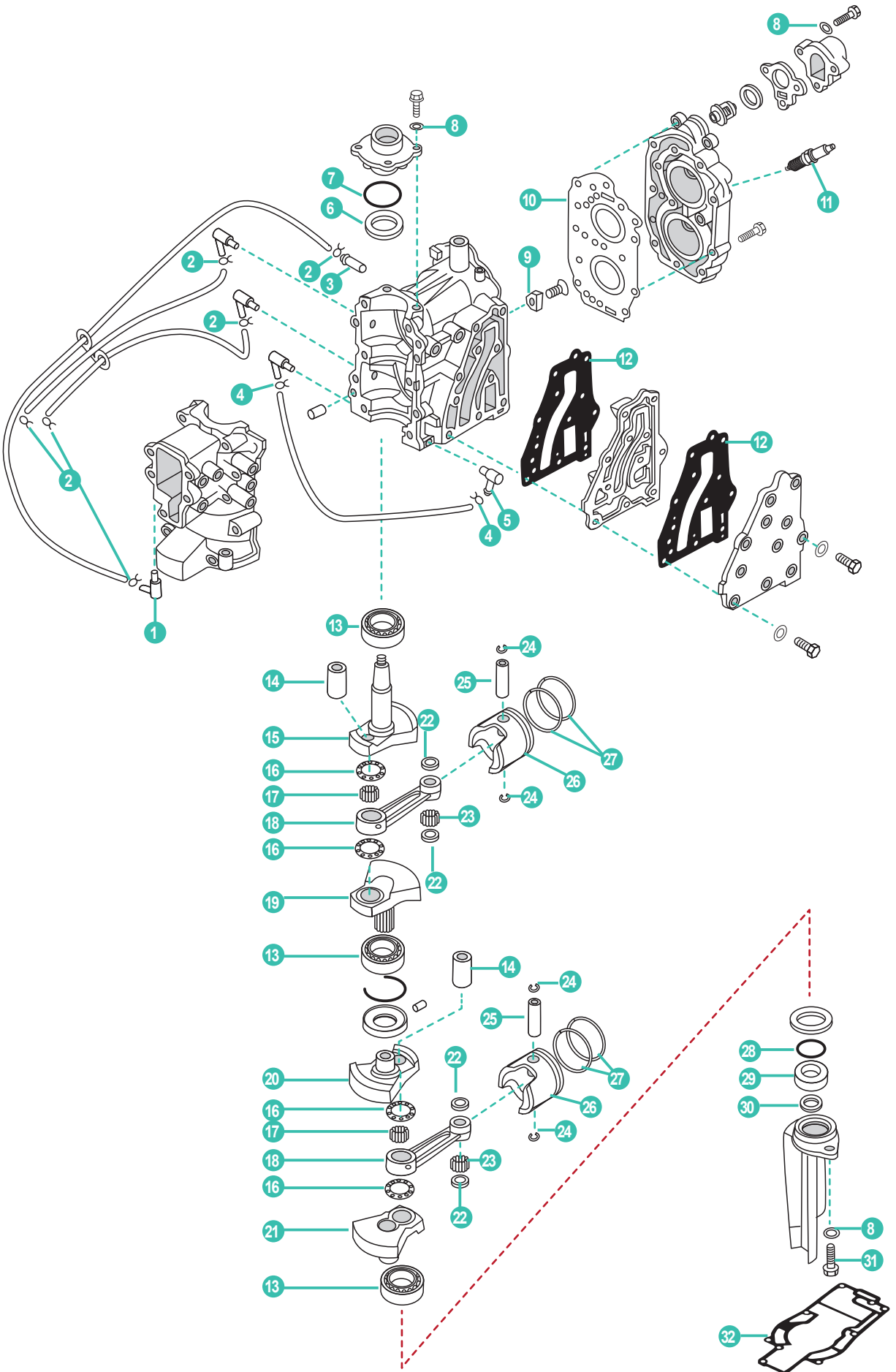

MERCURY MARINER

RECAMBIOS
MARINOS

	REF	OEM				UN.	
1	REC650-11370-00	21-80727M	NIPLE DE MANGUERA	NIPPLE	TUBO	RACCORD D'EAU	1
2	PAHT-2.5X60		PRESILLA	CLIP	CLIP	CLIPS	6
3	REC624-14485-00		PIPA DE AGUA	PIPE, WATER	TUBO	RACCORD TUYAU D'EAU	1
4	PAF4-04000030		PRESILLA	CLIP	CLIP	CLIPS	2
5	PAF15-04000005		NIPLE DE MANGUERA	NIPPLE	TUBO	RACCORD D'EAU	1
6	REC93102-20M25	26-14195M	RETÉN DE ACEITE	OIL SEAL	PARAOLIO	JOINT SPI	1
7	REC93210-42159	25-82276M	TÓRICA	O-RING	O-RING	JOINT TORIQUE	1
8	PAGB/T97.1-6		ARANDELA	WASHER	RONDELLA	RONDELLE	6
9	TEN01121	84732M	ÁNODO	ANODE	ANODO	ANODE	1
10	REC677-11181-A0	27-95595M	JUNTA CULATA	GASKET, CYLINDER HEAD	GUARNIZIONE TESTATA	JOINT DE CULASSE	1
11	NGKB7HS-10	33-82370M	BUJÍA	SPARK PLUG	CANDELA	BOUGIE	2
12	REC677-41112-A0	27-95597M	JUNTA DE ESCAPE	EXHAUST GASKET	GUARNIZIONE DI SCARICO	JOINT D'ECHAPPEMENT	2
13	REC93306-204U0	30-18859M	RODAMIENTO	BALL BEARING	CUSCINETTO	ROULEMENT À BILLE	3
14	REC6G1-11681-00	17-14193M	PIN	PIN	SPINOTTO	LEVIER D'ENTRAINEMENT	2
15	REC677-11412-02		CIGÜEÑAL 1	CRANK 1	ALBERO MOTORE 1	VILEBREQUIN 1	1
16	REC90209-18112	12-84620M	ARANDELA	WASHER	RONDELLA	RONDELLE	4
17	REC93310-418U0	31-94769M	COJINETE DE BIELA	BEARING, CONNECTING ROD	CUSCINETTO BIELLA	PALIER DE BIELLE	2
18	REC6E0-11651-01	629-9492M	BIELA	CONNECTING ROD	BIELLA	BIELLE	2
19	REC677-11422-02		CIGÜEÑAL 2	CRANK 2	ALBERO MOTORE 2	VILEBREQUIN 2	1
20	REC677-11432-02		CIGÜEÑAL 3	CRANK 3	ALBERO MOTORE 3	VILEBREQUIN 3	1
21	REC677-11442-02		CIGÜEÑAL 4	CRANK 4	ALBERO MOTORE 4	VILEBREQUIN 4	1
22	REC90201-12565	12-81816M	ARANDELA PLANA	WASHER PLATE	RONDELLA PIANA	RONDELLE	4
23	REC93602-14118	29-82350M	COJINETE DE BIELA	BEARING, CONNECTING ROD	CUSCINETTO BIELLA	PALIER DE BIELLE	56
24	REC93450-13022	53-82342M	CIRCLIP	CIRCLIP	CIRCLIP	CIRCLIP	4
25	REC6G1-11633-00	41-95601M	PIN, PISTÓN	PIN, PISTON	SPINOTTO PISTONE	AXE DE PISTON	2
	REC677-11631-00K	761-8224M	PISTÓN STD	PISTON STD	PISTONE STD	PISTON STD	
26	REC677-11635-00K	761-8225M	PISTÓN 0.25mm O/S	PISTON 0.25mm O/S	PISTONE 0.25mm O/S	PISTON 0.25mm O/S	2
	REC677-11636-00K	761-8226M	PISTÓN 0.50mm O/S	PISTON 0.50mm O/S	PISTONE 0.50mm O/S	PISTON 0.50mm O/S	
	REC647-11610-00	39-80422M	KIT SEGMENTOS STD	PISTON RING SET STD	KIT FASCE STD	KIT SEGMENTS STD	
27	REC647-11610-10	39-80423M	KIT SEGMENTOS 0.25mm O/S	PISTON RING SET 0.25mm O/S	KIT FASCE 0.25mm O/S	KIT SEGMENTS 0.25mm O/S	2
	REC647-11610-20	39-80424M	KIT SEGMENTOS 0.50mm O/S	PISTON RING SET 0.50mm O/S	KIT FASCE 0.50mm O/S	KIT SEGMENTS 0.50mm O/S	
28	REC93210-42M70	25-95602M	TÓRICA	O-RING	O-RING	JOINT TORIQUE	1
29	REC93101-20M29	26-18843M	RETÉN DE ACEITE	OIL SEAL	PARAOLIO	JOINT SPI	1
30	REC93101-14M01	26-82165M	RETÉN DE ACEITE	OIL SEAL	PARAOLIO	JOINT SPI	1
31	PAGB/T5783-M6X16		PERNO	STUD	BULLONE	BOULON	2
32	REC677-45113-A0		JUNTA BASE MOTOR	GASKET ENGINE	GUARNIZIONE BASE MOTORE	JOINT DE TETE MOTRICE	1



2T
STROKES

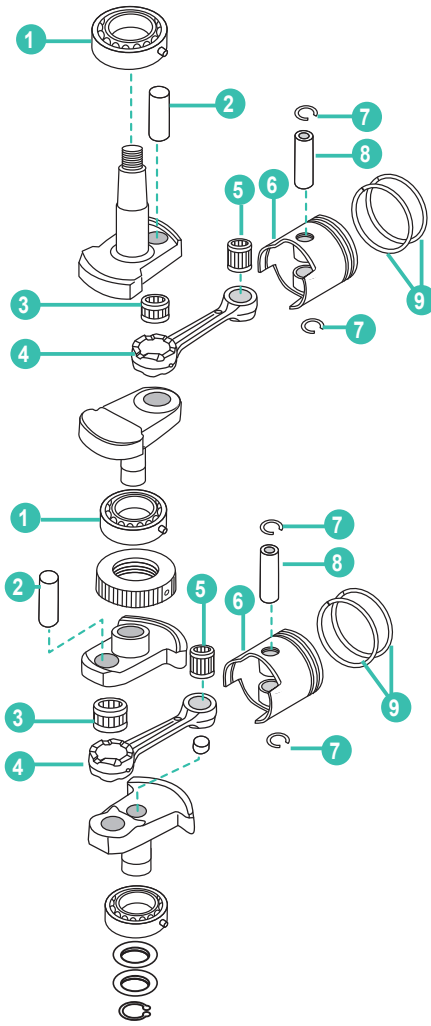

REC2TU3
REC2TU6

2T 9.9, 15, 18 HP (2 CYL) INTER.
STROKES

	REF	OEM					UN.
1	REC30-160494	30-160494	RODAMIENTO	BEARING	CUSCINETTO	ROULEMENT	3
2	REC803673	803673	PIN	PIN	SPINOTTO	LEVIER	2
5	REC31-16052	31-16052	COJINETE DE BIELA	BEARING, CONNECTING ROD	CUSCINETTO BIELLA	PALIER DE BIELLE	1
4	REC629-803674	629-803674	BIELA	CONNECTING ROD	BIELLA	BIELLE	2
6	REC779-803677	779-803677	PISTON STD 18 HP	PISTON STD 18 HP	PISTONE STD 18 HP	PISTON STD 18 HP	2
6	REC779-803677T02	779-803677T02	PISTON STD 9.9, 15 HP	PISTON STD 9.9, 15 HP	PISTONE STD 9.9, 15 HP	PISTON STD 9.9, 15 HP	2
6	REC41-803680002	41-803680002	PIN, PISTÓN 18 HP	PIN, PISTON 18 HP	SPINOTTO PISTONE 18 HP	AXE DE PISTON 18 HP	2
6	REC41-825713002	41-825713002	PIN, PISTÓN 9.9, 15 HP	PIN, PISTON 9.9, 15 HP	SPINOTTO PISTONE 9.9, 15 HP	AXE DE PISTON 9.9, 15 HP	2
7	REC53-16057	53-16057	CIRCLIP	CIRCLIP	CIRCLIP	CIRCLIP	4
9	REC39-803678A1	8M0080357	KIT SEGMENTOS 18 HP	PISTON RING SET 18 HP	KIT FASCE 18 HP	KIT SEGMENTS 18 HP	2
9	REC8M0080357	8M0080357	KIT SEGMENTOS 9.9, 15 HP	PISTON RING SET 9.9, 15 HP	KIT FASCE 9.9, 15 HP	KIT SEGMENTS 9.9, 15 HP	2

2T 25, 30 HP (2 CYL) INTER.
STROKES

	REF	OEM					UN.
1	REC30-16049T01	30-16049T01	RODAMIENTO	BEARING	CUSCINETTO	ROULEMENT	1
2	REC8130461	8130461	PIN	PIN	SPINOTTO	LEVIER	2
3	REC31-8130482	31-8130482	COJINETE DE BIELA	BEARING, CONNECTING ROD	CUSCINETTO BIELLA	PALIER DE BIELLE	2
4	REC629-813047T01	629-813047T01	BIELA	CONNECTING ROD	BIELLA	BIELLE	2
5	REC345-00042-0	345-00042-0	COJINETE DE BIELA	BEARING, CONNECTING ROD	CUSCINETTO BIELLA	PALIER DE BIELLE	2
6	REC779-879194T01	779-879194T01	PISTÓN STD	PISTON STD	PISTONE STD	PISTON STD	2
7	REC53-16057	53-16057	CIRCLIP	CIRCLIP	CIRCLIP	CIRCLIP	4
8	REC41-803680003	41-803680003	PIN, PISTÓN	PIN, PISTON	SPINOTTO PISTONE	AXE DE PISTON	2
9	REC39-16054A5	39-16054A5	KIT SEGMENTOS	PISTON RING SET	KIT FASCE	KIT SEGMENTS	4

2T 40HP LIGHTNING / XR / MXL MARATHON (INTER.) 50HP MH
STROKES

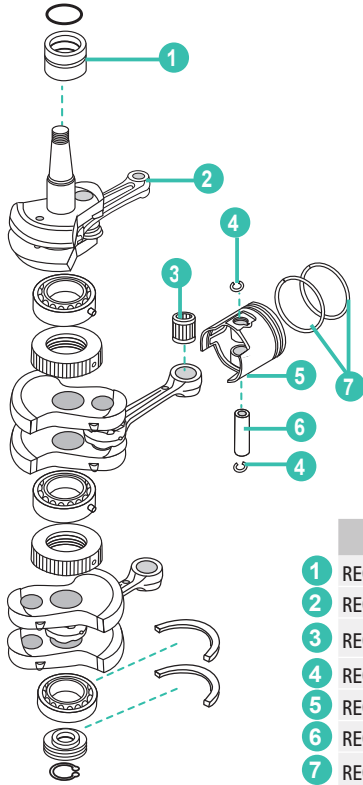

	REF	OEM				UN.	
1	REC31-855553	31-855553	RODAMIENTO	BEARING	CUSCINETTO	ROULEMENT	1
2	REC629-880855	629-880855	BIELA	CONNECTING ROD	BIELLA	BIELLE	3
3	REC345-00042-0	345-00042-0	COJINETE DE BIELA	BEARING, CONNECTING ROD	CUSCINETTO BIELLA	PALIER DE BIELLE	3
4	REC53-16057	53-16057	CIRCLIP	CIRCLIP	CIRCLIP	CIRCLIP	6
5	REC779-96152	779-96152	PISTÓN STD	PISTON STD	PISTONE STD	PISTON STD	3
6	REC41-16056	41-80368003	PIN, PISTÓN	PIN, PISTON	SPINOTTO PISTONE	AXE DE PISTON	3
7	REC8M0080349	8M0080349	KIT SEGMENTOS	PISTON RING SET	KIT FASCE	KIT SEGMENTS	3

2T 40 JET (OP094500+) • 45 JET (9973100-OP094499) • 50/60 JET 40/45 (3 CYL)
STROKES 55HP (3CYL) (9973100+) • 60HP (3 CYL) (9973100+) • 60HP (3 CYL) BIGFOOT (9973100-OP325499)

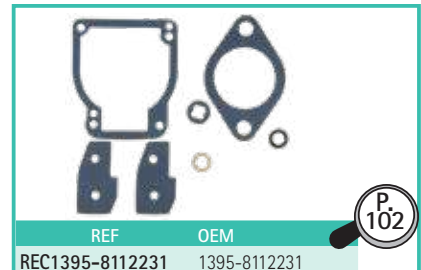
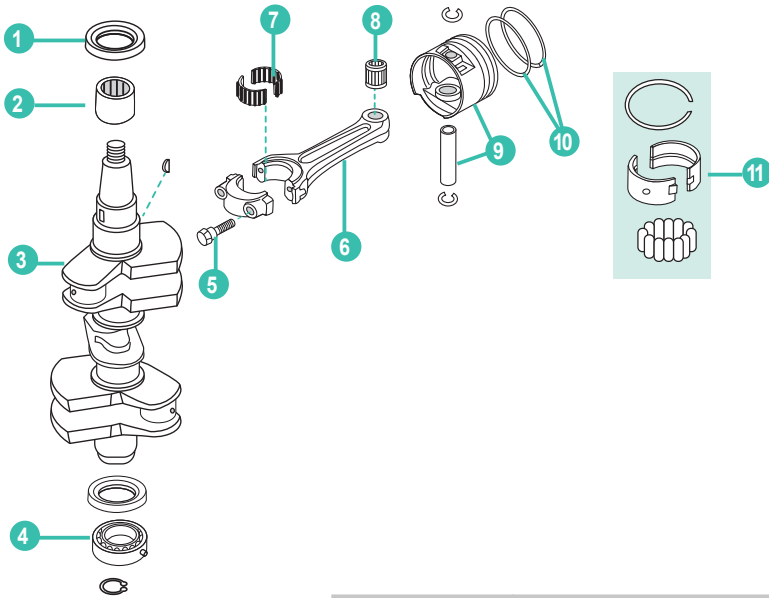

REF	OEM
REC1395-8112231	1395-8112231

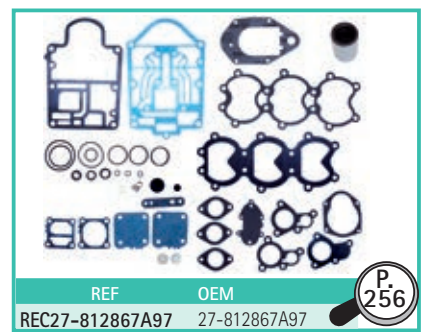

REF	OEM
REC27-812867A97	27-812867A97

	REF	OEM				UN.	
1	REC26-8173971	817397 1	RETÉN ACEITE	SEAL OIL	PARAOILIO	JOINT SPI	1
2	REC31-818889A1	31-818889A1	RODAMIENTO	BEARING	CUSCINETTO	ROULEMENT	1
3	REC2411-827954T2	827954T	CIGÜEÑAL	CRANKSHAFT	ALBERO MOTORE	VILEBREQUIN	1
4	REC377139	63742T	RODAMIENTO	BEARING	CUSCINETTO	ROULEMENT	1
5	REC10-91012	91012	TORNILLO	BOLT	VITE	VIS	6
6	REC640-9612A7	9612A 6	BIELA	CONNECTING ROD	BIELLA	BIELLE	3
7	REC31-17514A2	17514A1	RODAMIENTO	BEARING	CUSCINETTO	ROULEMENT	3
8	REC29-47270	47270	AGUJAS	NEEDLE PIN	SPILLO	CLAVETTE	87
9	REC705-850026T1K	850026T 1	PISTON	PISTON	PISTONE	PISTON	3
10	REC39-831255A6	831255A 6	KIT SEGMENTOS	PISTON RING SET	KIT FASCE	KIT SEGMENTS	3
11	REC827955A2	827955A 2	KIT COJINETE	BEARING KIT	KIT CUSCINETTO	KIT ROULEMENT	2



2T
STROKES

40K W40 (W MARATHON)

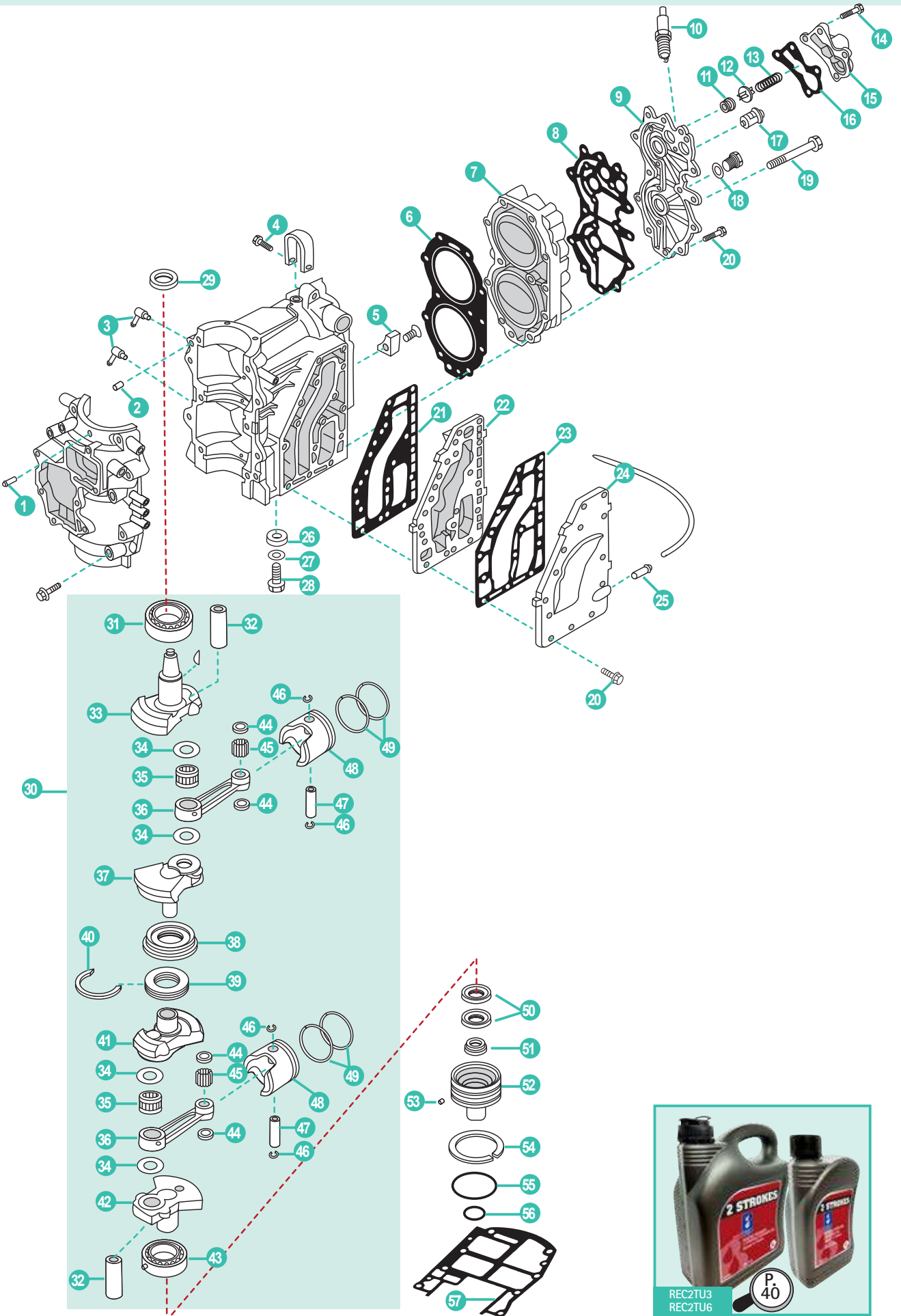

	REF	OEM					UN.
1	PAT15-04010202	22-80122M	PIPA DE AGUA	PIPE, WATER	TUBO	RACCORD TUYAU D'EAU	1
2	PAF25-00000014	17-82368M	PIN CENTRADOR	HOLLOW PIN	SPINOTTO DI CENTRAGGIO	PIN DE CENTRAGE	2
3	REC650-11370-00	21-80727M	NIPLE DE MANGUERA	NIPPLE	TUBO	RACCORD D'EAU	2
4	PAGB/T5783-M8X35	10-82442M	TORNILLO	BOLT	VITE	VIS	1
5	TEN01166	83330M	ÁNODO	ANODO	ANODO	ANODE	1
6	REC6F5-11181-A2	27-11745M	JUNTA CULATA	GASKET, CYLINDER HEAD	GUARNIZIONE TESTATA	JOINT DE CULASSE	1
7	REC6F6-11111-00-1S	968-9325M	CULATA DE CILINDRO	CYLINDER HEAD	TESTA CILINDRO	CULASSE	1
8	REC6F6-11193-A1	27-114749M	JUNTA TAPA	GASKET, COVER	GUARNIZIONE COPERCHIO	JOINT DE COUVRE CULASSE	1
9	REC6F6-11191-00-1S	11747M	TAPA CULATA DE CILINDRO	HEAD CYLINDER COVER	COPERCHIO TESTATA CILINDRO	CUVERCLE DE CULASSE	1
10	NGKB7HS	33-82371M	BUJÍA	SPARK PLUG	CANDELA	BOUGIE	2
11	REC90480-18065		TAPÓN	PLUG	TAPPO	BOUCHON	1
12	REC663-12416-00		VÁLVULA DE PRESIÓN	VALVE, PRESS CONTROL	VALVOLA DI PRESSIONE	SOUPAPE DE PRESSION	1
13	REC90501-14M02		RESORTE DE COMPRESIÓN	SPRING COMPRESSION	MOLLA DI COMPRESIONE	RESSORT	1
14	PAGB/T5783-M6X30	10-8257021	TORNILLO CON ARANDELA	BOLT, FLANGE	VITE CON RONDELLA	VIS DE BRIDE	4
15	REC6E9-12413-00-1S	19255M	TAPA TERMOSTATO	COVER, THERMOSTAT	COPERCHIO TERMOSTATO	COUVERCLE THERMOSTAT	1
16	REC6E9-12414-A1	27-97706M	JUNTA TAPA TERMOSTATO	GASKET, THERMOSTAT COVER	GUARNIZIONE COPERCHIO TERMOSTATO	JOINT COUVERCLE DE THERMOSTAT	1
17	REC6F5-12411-03	814554T01	TERMOSTATO	THERMOSTAT	TERMOSTATO	THERMOSTAT	1
18	PAF15-04000003	27-11754M	JUNTA	GASKET	GUARNIZIONE	JOINT	1
19	PAGB/T5783-M6X25	10-11746M	TORNILLO	BOLT	VITE	VIS	11
20	PAGB/T5783-M6X25	10-2405M	TORNILLO	BOLT	VITE	VIS	20
21	REC6F5-41112-A0	27-11754	JUNTA DE ESCAPE	EXHAUST GASKET	GUARNIZIONE DI SCARICO	JOINT D'ECHAPPEMENT	1
22	REC6F5-41111-01-1S	11753M	CUBIERTA INTERIOR ESCAPE	INNER EXHAUST COVER	COPERCHIO INTERIORE SCARICO	COUVERCLE INTERIEUR D'ECHAPPEMENT	1
23	REC6F5-41114-A0	27-11756	JUNTA EXTERIOR, TAPA ESCAPE	GASKET, EXHAUST OUTER COVER	GUARNIZIONE ESTERIORE, COPERCHIO SCARICO	JOINT DE COUVERCLE EXT. ECHAPPEMENT	1
24	REC6F5-41113-A0-1S	11755M	CUBIERTA EXTERIOR ESCAPE	OUTTER EXHAUST COVER	COPERCHIO ESTERNO SCARICO	COUVERCLE EXTERIEUR D'ECHAPPEMENT	1
25	PAF4-04010102	22-94716M	PIPA DE AGUA	PIPE, WATER	TUBO	RACCORD TUYAU D'EAU	1
26	TEN01127	83394M	ÁNODO	ANODE	ANODO	ANODE	1
27	PAGB/T97.1-6	12-881379	ARANDELA	WASHER	RONDELLA	RONDELLE	1
28	PAGB/T5783-M6X16	10-826957M	TORNILLO	BOLT	VITE	VIS	1
29	REC93102-35M18	26-11731M	RETÉN DE ACEITE	OIL SEAL	PARAOILIO	JOINT SPI	1
30	REC6F6-11400-02	463-9327M	CIGÜEÑAL COMPLETO	CRANK ASSY	ALBERO MOTORE COMPLETO	VILEBREQUIN COMPLET	1
31	REC93306-307U0	30-11766T	RODAMIENTO	BALL BEARING	CUSCINETTO	ROULEMENT À BILLE	1
32	REC6F5-11681-00	17-13302T	PIN	PIN	SPINOTTO	PIN D'ENTRAÎNEMENT	2
33	REC6F5-11412-11	851997M	CIGÜEÑAL PARTE 1	CRANK 1	ALBERO MOTORE 1	VILEBREQUIN 1	1
34	REC90209-27M07	12-13305M	ARANDELA DE SEPARACIÓN	WASHER	RONDELLA DISTANZIALE	RONDELLE	14
35	REC93310-727V7	29-13304M	COJINETE DE BIELA	BEARING, CONNECTING ROD	CUSCINETTO BIELLA	PALIER DE BIELLE	2
36	REC6F5-11651-00	629-9486T	BIELA	ROD, CONNECTING	BIELLA	BIELLE	2
37	REC6F5-11422-11	827142M	CIGÜEÑAL PARTE 2	CRANK 2	ALBERO MOTORE 2	VILEBREQUIN 2	1
38	REC93332-000UE	31-13300T	COJINETE	BEARING	CUSCINETTO	PALIER	1
39	REC6F5-11515-00	13301M	SELLO LABERINTO	LABERINTH SEAL	GUARNIZIONE SIGILLATA	JOINT	1
40	REC93440-68M03	53-11760M	CIRCLIP	CIRCLIP	CIRCLIP	CIRCLIP	1
41	REC6F5-11432-11	827143M	CIGÜEÑAL PARTE 3	CRANK 3	ALBERO MOTORE 3	VILEBREQUIN 3	1
42	REC6F5-11442-11	827144M	CIGÜEÑAL PARTE 4	CRANK 4	ALBERO MOTORE 4	VILEBREQUIN 4	1
43	REC93306-306V1	30-11767T	COJINETE	BEARING	CUSCINETTO	PALIER	1
44	REC90201-20417	12-81831M	ARANDELA PLANA	FLAT WASHER	RONDELLA PIANA	RONDELLE	4
45	REC93603-21111	29-82353M	AGUJA PASADOR	NEEDLE PIN	SPILLO	CLAVETTE	56
46	REC663-11634-00	53-81264M	CIRCLIP	CIRCLIP	CIRCLIP	CIRCLIP	4
47	REC6F5-11633-00	41-11771T	PIN, PISTÓN	PIN, PISTON	SPINOTTO PISTONE	AXE DE PISTON	2
48	REC6F6-11631-00K	761-9329T	PISTÓN STD	PISTON STD	PISTONE STD	PISTON STD	2
	REC6F6-11635-00K		PISTÓN 0.25mm O/S	PISTON 0.25mm O/S	PISTONE 0.25mm O/S	PISTON 0.25mm O/S	
	REC6F6-11636-00K	761-9331T	PISTÓN 0.50mm O/S	PISTON 0.50mm O/S	PISTONE 0.50mm O/S	PISTON 0.50mm O/S	
	REC6F5-11610-00	39-11768T	KIT SEGMENTOS STD	PISTON RING SET STD	KIT FASCE STD	KIT SEGMENTS STD	
49	REC6F5-11610-10	39-11769M	KIT SEGMENTOS 0.25mm O/S	PISTON RING SET 0.25mm O/S	KIT FASCE 0.25mm O/S	KIT SEGMENTS 0.25mm O/S	2
	REC6F5-11610-20	39-11770T	KIT SEGMENTOS 0.50mm O/S	PISTON RING SET 0.50mm O/S	KIT FASCE 0.50mm O/S	KIT SEGMENTS 0.50mm O/S	
50	REC93101-30M33	26-11758M	RETÉN DE ACEITE	OIL SEAL	PARAOILIO	JOINT SPI	2
51	REC93104-16M01	26-189721	RETÉN DE ACEITE	OIL SEAL	PARAOILIO	JOINT SPI	1
52	REC6F5-15396-01-5B	815118M	CUERPO DEL RETÉN	SHELL, OIL SEAL	GUARNIZIONE CORPO	LOGEMENT JOINT SPI	1
53	PAGB/T879.4-3X20	17-82145M	PASADOR DE RESORTE	PIN, SPRING	SPINOTO DI RITORNO	GOUPILLE FENDUE	1
54	REC93440-68M03	53-11760M	CIRCLIP	CIRCLIP	CIRCLIP	CIRCLIP	1
55	REC93210-65M50	25-11759M	TÓRICA	O-RING	O-RING	JOINT TORIQUE	1
56	REC93210-22M02	25-83348M	TÓRICA	O-RING	O-RING	JOINT TORIQUE	1
57	REC6F5-45113-A0	27-11885	JUNTA BASE MOTOR	GASKET ENGINE	GUARNIZIONE BASE MOTORE	JOINT DE TETE MOTRICE	1

2T
STROKES

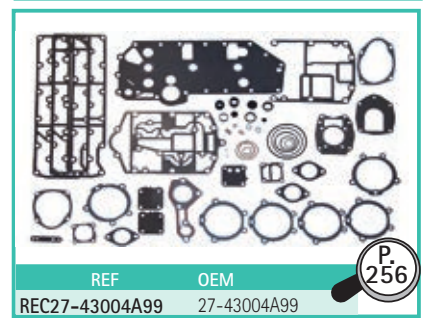
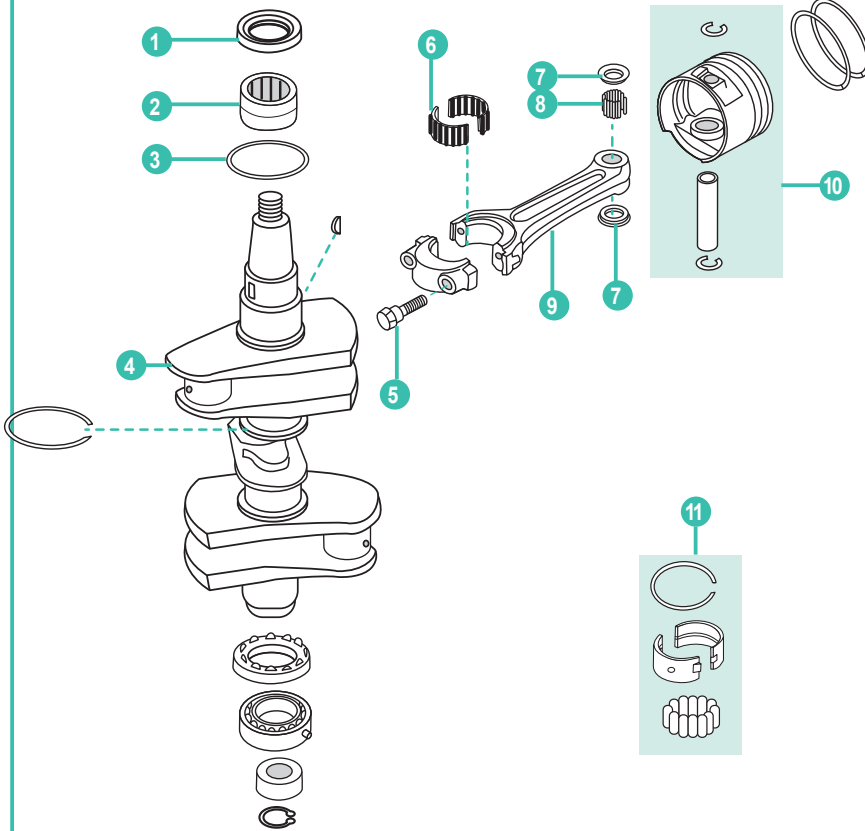

2T
STROKES

65 JET • 75HP • 90 HP (3CYL)

	REF	OEM					UN.
1	REC26-43993	26-43993	RETÉN ACEITE	SEAL OIL	PARAOLIO	JOINT SPI	1
2	REC31-43013T3	43013T 3	RODAMIENTO	BEARING	CUSCINETTO	ROULEMENT	1
3	REC25-823683	823683	ARO TÓRICO	O-RING	O-RING	JOINT TORIQUE	1
4	REC493-827616T1	827616T 1	CIGÜEÑAL	CRANKSHAFT	ALBERO MOTORE	VILEBREQUIN	1
5	REC10-94320	94320	TORNILLO	BOLT	VITE	VIS	6
6	REC31-43012A1	43012A 1	RODAMIENTO	BEARING	CUSCINETTO	ROULEMENT	3
7	REC12-8M0012298	812876	ARANDELA	WASHER	RONDELLA	RONDELLE	6
8	REC29-818391001	818391	RODAMIENTO	BEARING	CUSCINETTO	ROULEMENT	5
9	REC646-818845T6	818846T 6	BIELA	CONNECTING ROD	BIELLA	BIELLE	3
10	REC2704-826191T4K	826191T 4	KIT PISTON	PISTON KIT	KIT PISTONE	KIT PISTON	3
11	REC42943A1	42943A 1	KIT COJINETE	BEARING KIT	KIT CUSCINETTO	KIT ROULEMENT	2

2T
STROKES

70 HP (9506481 - 9589038) • 75 HP (9506481 - 9793576) (3 CYL)
80 HP (9506481 - 9589038) • 90 HP (9506481 - 9793576) (3CYL)

	REF	OEM					UN.
1	REC26-43993	26-43993	RETÉN ACEITE	SEAL OIL	PARAOLIO	JOINT SPI	1
2	REC31-43013T3	43013T 3	RODAMIENTO	BEARING	CUSCINETTO	ROULEMENT	1
3	REC25-823683	823683	ARO TÓRICO	O-RING	O-RING	JOINT TORIQUE	1
5	REC10-94320	10-94320	TORNILLO	BOLT	VITE	VIS	6
6	REC31-43012A1	43012A 1	RODAMIENTO	BEARING	CUSCINETTO	ROULEMENT	3
8	REC29-88258	29-88258	AGUJAS	NEEDLE PIN	SPILLO	CLAVETTE	87
9	REC638-9002A6	838-9002A6	BIELA	CONNECTING ROD	BIELLA	BIELLE	3
10	REC777-9009T13 REC774-9137A11	774-9009A13 774-9317A11	KIT PISTON STD KIT PISTON 0.30	PISTON SET STD PISTON SET 0.30	KIT PISTONE STD KIT PISTONE 0.30	KIT PISTON STD KIT PISTON 0.30	3
11	REC42943A1	42943A 1	KIT COJINETE	BEARING KIT	KIT CUSCINETTO	KIT ROULEMENT	2

2T
STROKES

75 HP (9793577+) • 90 HP (9793577+) • 65 JET (9793577+)
(3 CYL)

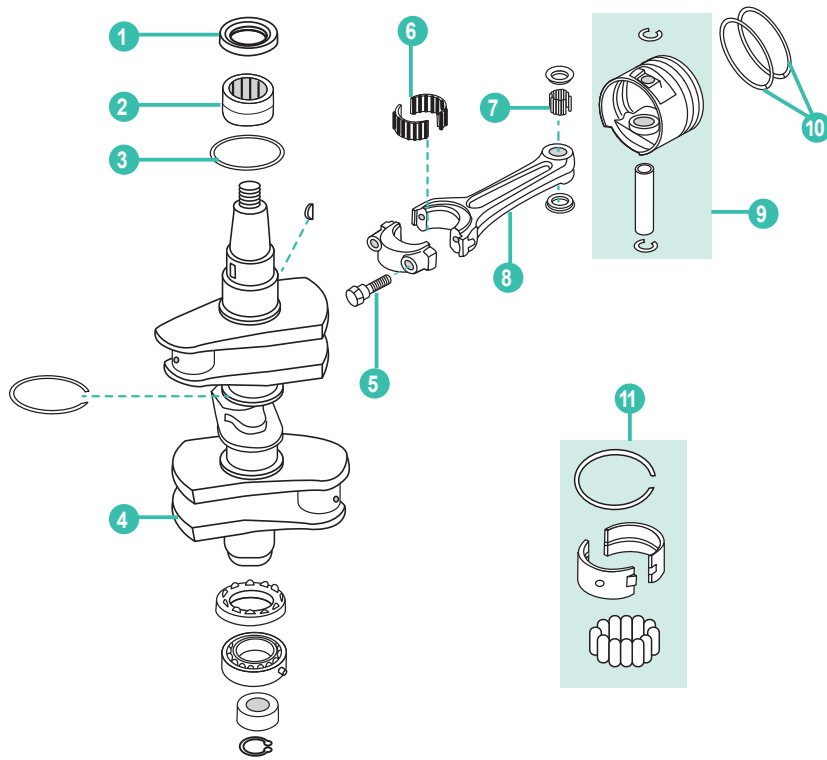

REC2TU3
REC2TU6

P. 40

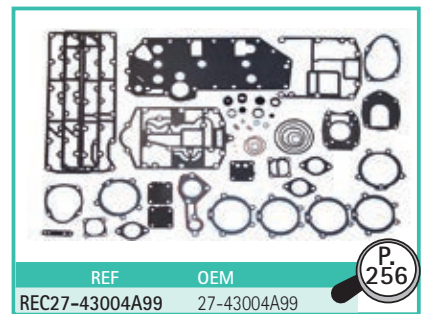

REC27-43004A99

REC27-43004A99

P. 256

	REF	OEM					UN.
1	REC26-43993	43993	RETÉN ACEITE	SEAL OIL	PARAOLIO	JOINT SPI	1
2	REC31-43013T3	43013T 3	RODAMIENTO	BEARING	CUSCINETTO	ROULEMENT	1
3	REC25-823683	823683	ARO TÓRICO	O-RING	O-RING	JOINT TORIQUE	1
4	REC493-827616T1	827616T 1	CIGÜEÑAL	CRANKSHAFT	ALBERO MOTORE	VILEBREQUIN	1
5	REC10-94320	94320	TORNILLO	BOLT	VITE	VIS	6
6	REC31-43012A1	43012A 1	KIT COJINETE	BEARING KIT	KIT CUSCINETTO	KIT ROULEMENT	3
7	REC29-818391001	818391001	RODAMIENTO	BEARING	CUSCINETTO	ROULEMENT	87
8	REC646-818845T6	818846T 6	BIELA	CONNECTING ROD	BIELLA	BIELLE	3
9	REC2704-826191T4K	826191T 4	KIT PISTON STD	PISTON SET STD	KIT PISTONE STD	KIT PISTON STD	3
	REC2704-821896A4	821896A 4	KIT PISTON 0.30	PISTON SET 0.30	KIT PISTONE 0.30	KIT PISTON 0.30	3
10	REC39-822321A2	822321A 2	KIT SEGMENTOS 0.30 mm	PISTON RING SET 0.30 mm	KIT FASCE 0.30 mm	KIT SEGMENTS 0.30 mm	3
11	REC42943A1	42943A 1	KIT COJINETE	BEARING KIT	KIT CUSCINETTO	KIT ROULEMENT	2

MERCURY

RECAMBIOS
MARINOS

JUNTAS DE MOTOR
2 TIEMPOS

ENGINE GASKET
2 STROKES

GUARNIZIONI
MOTORE 2 TEMPI

JOINTS DE MOTEUR
2 TEMPS



2T
STROKES



JUNTAS DE CULATA

CYLINDER HEAD GASKET

GUARNIZIONE DE TESTATA



JOINT DE CULASSE

REF	OEM		
REC309-01005-2	27-95299001	2.5 HP 3.3 & 3 HP 2 & 2.2M	



REF	OEM		
REC350-01005-0	27-803663	15, 18 HP (2 Cyl International)	

REF	OEM		
REC3B2-01005-0	27-803663021	6, 8, 9.8 HP (2 Cyl International)	

REF	OEM		
REC346-01005-0	27-8129391	25, 30 HP (2 Cyl International)	

REF	OEM		
REC677-11181-A0	27-95595M	8K / W8	















REF	OEM		
REC689-11181-00	27-19138M	30A / W30	







REF	OEM		
REC351-01005-0	27-803663018	9.9 HP (2 Cyl International)	





REF	OEM		
REC3C8-01005-4	27-8M0062091 27-81293910	40 (International) 40 (MXL SEAPRO)	

REF	OEM		
REC6E7-11181-00	27-18937M	15C-K, W15, 9.9C	

REF	OEM						
REC27-96542-1	27-96542-1 27-96281T01	V6 2.0L (1976-90) Loopcharged	14-3/4" x 4-5/8"	3-1/4"	3.125"	636-8118	

REF	OEM						
REC27-18785T	27-18785T	V6 2.0L (1992-00) Loopcharged	14-3/4" x 4-7/8"	3-1/4"	3.125"	644-818141	



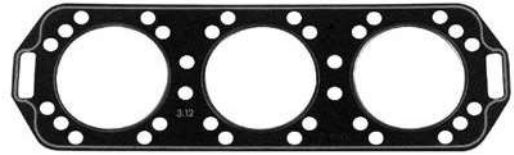

REF	OEM						
REC27-822844T04	27-822844T04	V6 2.0L (1978-00) Loopcharged	14-3/4" x 4-15/16"	3-1/2"	3.501"		

REF	OEM				
REC27-79583-1	27-79583-1	V6 2.0L (1976-98) Loopcharged	14-5/8" x 4-5/8"	3-3/16"	3.125"







REF	OEM				
REC27-41246-1	27-41246-1	V6 2.4L (1978-98) Loopcharged	14-3/4" x 4-11/16"	3-1/2"	3.375"



REF	OEM					
REC27-418786T	27-18786T	V6 2.4L (1978-98) Loopcharged	14-3/4" x 4-7/8"	3-1/2"	3.375"	XR4 Magnum II 175



REF	OEM					
REC27-41245-1	27-41245-1	V6 2.4L (1978-88) Loopcharged	14-3/4" x 4-3/4"	3-1/2"	3.375"	200 2000

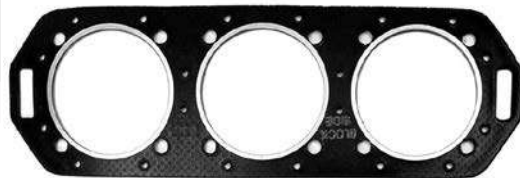

2T
STROKES

**KITS
JUNTAS DE CULATA**

**CYLINDER HEAD GASKET
KIT**

**KIT
GUARNIZIONE TESTATA**

**KITS
JOINT DE CULASSE**

REF	OEM	
REC27-42364A92	27-42364A92	6 / 8 / 9.9 HP XR10 10 VIKING / SEAPRO 15, 15 SEAPRO / VIKING 10 MAGNUM

REF	OEM	
REC27-41499A87	27-41499A87	15 SEAPRO (XD) 18 XD / 20 XD (2 cyl) 20 JET / 20 (2 cyl) 25, 25 SEAPRO, 25 XD SUPER 15 (2 cyl) 15 Marathon XD

REF	OEM	
REC27-85491A90	27-85491A90	30 JET 40 (4 cyl)

REF	OEM	
REC27-822420A94	27-822420A94	30 / 40 (2 Cyl) 30 (9854537+) 40 (985437+)

REF	OEM	
REC27-82853A97	27-82853A97	30 JET (3 cyl) 40 / 50 (3 cyl)

REF	OEM	
REC27-88449A32	27-88449A32	50, 60, 70 (3 cyl)

REF	OEM	
REC27-78028A78	27-78028A78	35 HP (2 Cyl) 402, 40 HP (2 cyl)

REF	OEM	
REC27-43779A87	27-43779A87	50, 60 (3 cyl)

REF	OEM	
REC27-81286A97	27-81286A97	40/45 JET 50/55 (3 cyl) 60 (3 cyl) Bigfoot

REF	OEM	
REC27-43004A99	27-43004A99	65 JET 65 JET (3 cyl) 75, 90 (3 cyl)

REF	OEM	
REC27-72486A32	27-72486A32	45 / 50 HP (4 Cyl)

REF	OEM	
REC27-13461A99	27-13461A99	65, 80 HP JET 75, 90 HP (3 cyl) 100, 115, 125 HP (4 cyl)

REF	OEM	
REC27-85653A87	27-85653A87	90, 115 (6 Cyl. L)

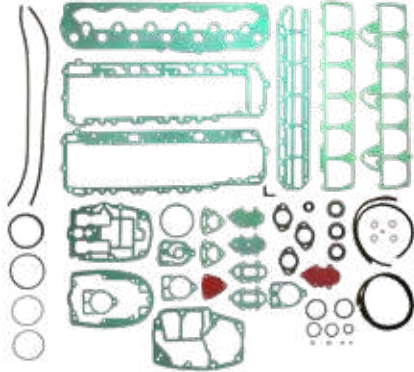

REF	OEM	
REC27-14697A87	27-14697A87	V-175 (SKI) V-200 (EFI) V-220

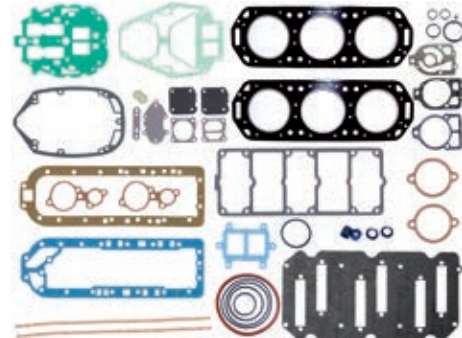

REF	OEM	
REC27-815791A92	27-815791A92	105, 140 JET V-135 V-150, V-175, v-200 (XR/EFI) XR-6

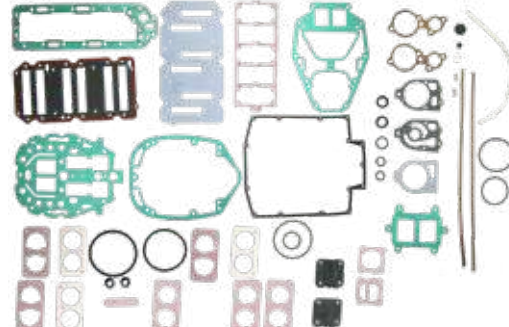

REF	OEM	
REC27-11338A88	27-11338A88	V-175 XR-4 Magnum II

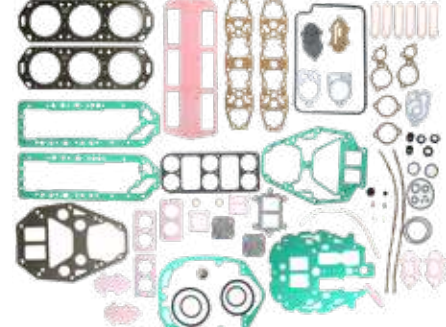

REF	OEM		
REC27-814754A00	27-814754A00	110 JET 150, 175 PROXS V-135, V-150 (DFI) V-175 (DFI) 2.5L	No incluye JUNTA CULATA. HEAD GASKET not included. Non include GUARNIZIONE TESTATA. Sans joint de culasse

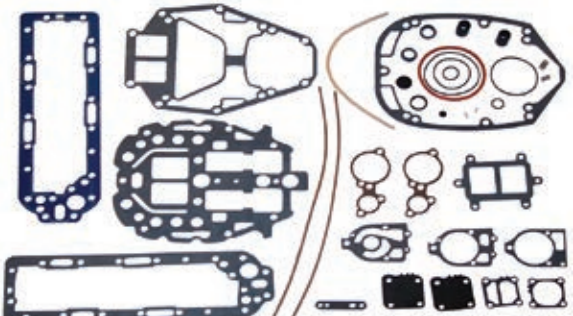

REF	OEM		
REC27-832934A00	27-832934A00	200 (DFI / EFI) 200 PRO XS 225 (EFI/DFI) 225 SEAPRO 250 (DFI/EFI) 3.0L	No incluye ARO de junta de culata. Cylinder head O-RING not included. Non include O-RING guarnizione testata. Sans joint de culasse

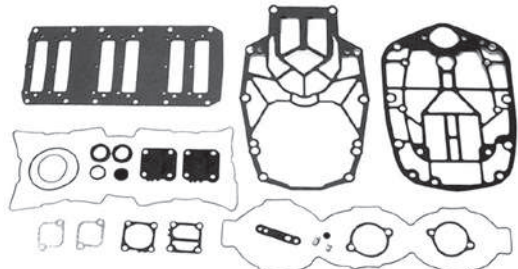

REF	OEM	
REC27-90484A88	27-90484A88	V-135 V-150 (Mag / Marathon Work / XR-2) V-1500

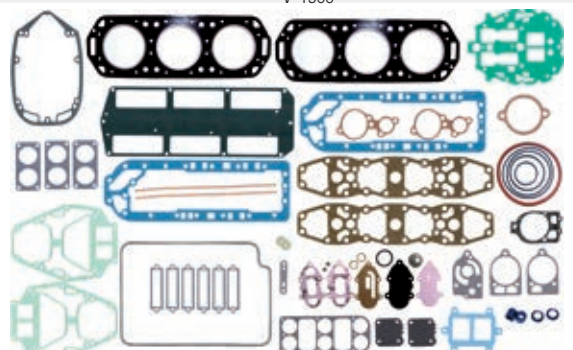

REF	OEM	
REC27-89221A88	27-89221A88	V-220

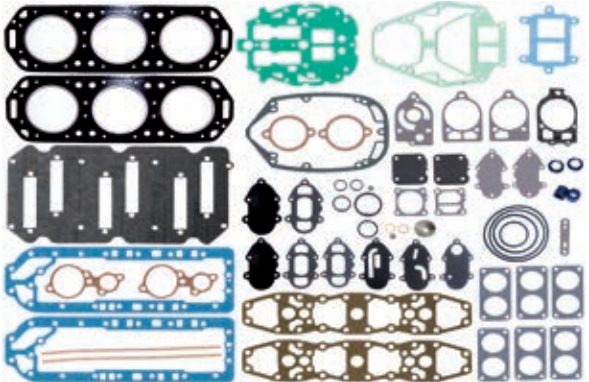

REF	OEM	Icon	Notes
REC27-79583A81	27-79583A81		No incluye JUNTA CULATA. HEAD GASKET not included. Non include GUARNIZIONE TESTATA. Sans joint de culasse

V-1500 / V-150 (Mag / Marathon Work / XR-2) / V-175

2T STROKES

JUNTAS BASE DE MOTOR **CYLINDER GASKET**

REF	OEM	Icon	Notes
REC6E0-45113-A1	27-91780M		4A, 5C (1977-89)

REF	OEM	Icon	Notes
REC27-89937	27-89937		4.5, 9.8 HP (1970-86)

REF	OEM	Icon	Notes
REC6G1-45113-A1	11560M		6C 8C (1978-86)

REF	OEM	Icon	Notes
REC682-11351-A0	27-96602M		9.9C 15C, K, W15 (1979-86)

REF	OEM	Icon	Notes
REC27-41670006	27-41670-3		20 Jet 20, 25 (2 cyl) (2005-06)

GUARNIZIONE BASE MOTORE **JOINTS DE TETE MOTRICE**

REF	OEM	Icon	Notes
REC27-796501	27-79650-1		30 Jet 40, 45 HP (4 cyl)

REF	OEM	Icon	Notes
REC8M0000822	828553		30, 40 HP (2cyl) 30, 40, 45 Jet 40, 50, 60 (3 cyl) (1994-10)

REF	OEM	Icon	Notes
REC27-628601	27-62860-1		35, 40, 402 (2 cyl) (1972-89)

REF	OEM	Icon	Notes
REC6F5-45113-A0	27-11885		K40 HP W40 (w/Marathon) (1989-98)

REF	OEM	Icon	Notes
REC27-884511	27-88451-1		50/60/70 HP (3cyl) (1980-90)

REF	OEM	
REC61T-45113-A0	27-84775	20C, 25C (Thru prop) 25K 30a W30 (w/Marathon) (1977-98)



REF	OEM	
REC27-991772	27-99177-2	135-200 HP (V-Models) XR-4 (1976-90)

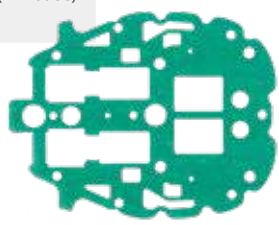

REF	OEM	
REC696-45113-00	27-16717M	55, W55 (1984-89)



REF	OEM	
REC27-997761	27-99776-1	135-175 HP (V-Models) (1976-93)

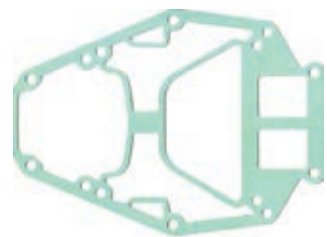

REF	OEM	
REC27-430075	27-43007-3	65, 80 Jet 100, 115, 125 (4 cyl) 75, 90 (3 cyl) 75, 90, 115 DFI (3 cyl) (1.5 L)

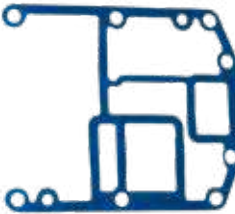

REF	OEM	
REC27-8231422	27-78069	150-225 HP (V-Models) (1978-88)

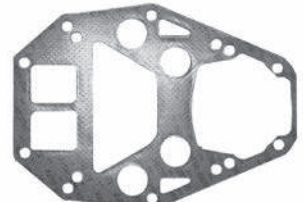

REF	OEM	
REC826549	27-826549	75-120 HP (1995-99)

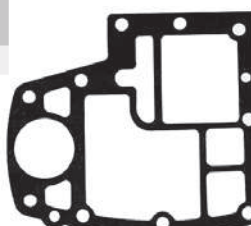

REF	OEM	
REC27-75909	27-75909	V-175 (1976-88) Merc Formula (2 L EFI / CARB)

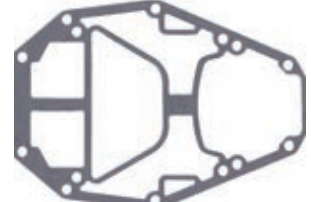

REF	OEM	
REC823700	27-823700-2	90-120 HP Jet Drive (1993-00)

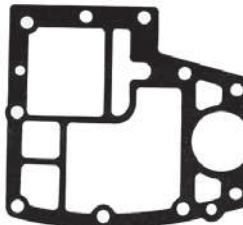

REF	OEM	
REC813932	27-813932-2	200-250 HP (3.0L) (DFI, CARB, EFI) (1994-98)

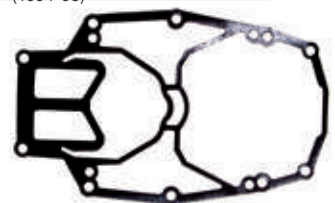

REF	OEM	
REC27-991764	27-99176-3	110, 140 Jet (2.5L) 150, 175 Pro X5 (2.5L) 135-200 HP (V-Models) (1976-10)



REF	OEM	
REC27-39401	27-39401	200 / 20 HP (1970-80)





KIT JOINTS

JUNTA CULATA
CYLINDER HEAD GASKET
GUARNIZIONE TESTAT
JOINT DE CULASSE

6	1986-93	USA	0A197112-0T800749	REC27-42364A92
6	1986-93	BEL	9461526	REC27-42364A92
8	1986-93	USA	0A197112+	REC27-42364A92
8	1986-93	BEL	9461526	REC27-42364A92
9.9	1986-93	USA	0A197112+	REC27-42364A92
9.9	1986-93	BEL	9461526	REC27-42364A92
10 Marathon XR10, Sea Pro	1990-93	USA	0D038000+	REC27-42364A92
10 Marathon XR10, Sea Pro	1990-93	BEL	9596000	REC27-42364A92
10 Magnum / Marathon	1990-98	USA	0D038000+	REC27-42364A92
10 Magnum / Marathon	1990-98	BEL	9596000	REC27-42364A92
15	1988-93	USA	0B292414+	REC27-42364A92
15	1988-93	BEL	9542620	REC27-42364A92
15 XD Sea Pro / Marathon	1997-98	BEL	9927000	REC27-41499A87
15 (Super)	1994-98	USA	0B238464+	REC27-41499A87
15 (Super)	1994-98	BEL	9507381	REC27-41499A87
15 (Super)	1994-98	CAN	0A730007+	REC27-41499A87
18 (18 XD)	1983 1/2	USA	6416713-6443972	REC27-41499A87
18 (18 XD)	1983 1/3	BEL	9378116-7209532	REC27-41499A87
18 (18 XD)	1984-85	CAN	7207858-7209532	REC27-41499A87
20 (20, 20XD, 200)	1986-87	USA	6443973	REC27-41499A87
20 (20, 20XD, 200)	1986-87	BEL	9415101	REC27-41499A87
20 (20, 20XD, 200)	1986-87	CAN	7209533	REC27-41499A87
20 Jet	1994-98	USA	0G044027+	REC27-41499A87
20 Jet	1994-98	BEL	9807909	REC27-41499A87
25 (25, 25XD)	1984-87	USA	6416713-0T979999	REC27-41499A87
25 (25, 25XD)	1983 1/2	BEL	9378116-0P325499	REC27-41499A87
25 (25, 25XD)	1983 1/2	CAN	7207858	REC27-41499A87
30 Jet (40HP) (4-Cyl.)	1994-97	USA	0C159200+	REC27-85491A90
30 Jet (40HP) (4-Cyl.)	1998	BEL	9570790	REC27-85491A90
35 (2-Cyl.)	1984-86	USA	6445653-0B110788	REC27-78028A78
35 (2-Cyl.)	1984-86	BEL	9384476-9466646	REC27-78028A78
35 (2-Cyl.)	1984-86	CAN	7209608	REC27-78028A78
40 (40, 402) (2-Cyl.)	1972-74	USA	3336258-0G053313	REC27-78028A78
40 (40, 402) (2-Cyl.)	1972-74	AUS	8002335	REC27-78028A78
40 (40, 402) (2-Cyl.)	1972-74	BEL	3339688	REC27-78028A78
40 (2-Cyl.)	1972-74	CAN	3340783	REC27-78028A78
40 (4-Cyl.)	1989	USA	0C159200+	REC27-85491A90
40 (4-Cyl.)	1989	BEL	9570790	REC27-85491A90
45 (4-Cyl.)	1986	USA	5531630-0B110788	REC27-72486A32
45 (4-Cyl.)	1986	AUS	8063985	REC27-72486A32
45 (4-Cyl.)	1986	BEL	9248006-9466691	REC27-72486A32
45 (4-Cyl.)	1986	CAN	7143688-0A719280	REC27-72486A32
45 (4-Cyl.)	1987-89	USA	0B110789+	REC27-85491A90
45 (4-Cyl.)	1987-89	BEL	9466692	REC27-85491A90
45 (4-Cyl.)	1987-89	CAN	0A719281+	REC27-85491A90
50 (500) (4-Cyl.)	1965-67	USA	2116318	REC27-72486A32
50 (500) (4-Cyl.)	1965-67	CAN	2097445	REC27-72486A32
50 (500) (4-Cyl.)	1965-67	AUS	2863739	REC27-72486A32
50 (500) (4-Cyl.)	1965-67	BEL	9001581	REC27-72486A32
50 (3-Cyl.)	1986-87	USA	6428681-0B122929	REC27-88449A32
50 (3-Cyl.)	1986-87	BEL	9385911-9469199	REC27-88449A32
50 (3-Cyl.)	1986-87	CAN	7208333-0A721307	REC27-88449A32
50 (3-Cyl.)	1986-87	USA	0B122930-0D000749	REC27-43779A87
50 (3-Cyl.)	1986-87	BEL	9469200-9683054	REC27-43779A87
50 (3-Cyl.)	1986-87	CAN	0A721308+	REC27-43779A87
55 (3-Cyl.)	1984-87	USA	6428681-0B122929	REC27-88449A32
55 (3-Cyl.)	1984-87	BEL	9385911-9469199	REC27-88449A32
55 (3-Cyl.)	1984-87	CAN	7208333-0A721307	REC27-88449A32
55 (3-Cyl.)	1988-90	USA	0B122930-0D000749	REC27-43779A87
55 (3-Cyl.)	1988-90	BEL	9469200-9683054	REC27-43779A87
55 (3-Cyl.)	1988-90	CAN	0A721308+	REC27-43779A87
60 (3-Cyl.)	1984-87	USA	6428681-0B122929	REC27-88449A32
60 (3-Cyl.)	1984-87	BEL	9385911-9469199	REC27-88449A32
60 (3-Cyl.)	1984-87	CAN	7208333-0A721307	REC27-88449A32
60 (3-Cyl.)	1988-90	USA	0B122930-0D000749	REC27-43779A87
60 (3-Cyl.)	1988-90	BEL	9469200-9683054	REC27-43779A87
60 (3-Cyl.)	1988-90	CAN	0A721308+	REC27-43779A87
65 (650) (3-Cyl.)	1976	USA	4382057-4571651	REC27-88449A32
65 (650) (3-Cyl.)	1976	BEL	9112989-9135824	REC27-88449A32
65 (650) (3-Cyl.)	1976	CAN	7073473-7087822	REC27-88449A32
70 (3-Cyl.)	1977-79	USA	4571652-0A996141	REC27-88449A32
70 (3-Cyl.)	1977-79	AUS	8042350	REC27-88449A32
70 (3-Cyl.)	1977-79	BEL	9135825-9385910	REC27-88449A32
70 (3-Cyl.)	1977-79	CAN	7087823-7208332	REC27-88449A32
70 (3-Cyl.)	1987	USA	0A996142+	REC27-43004A99
70 (3-Cyl.)	1987	BEL	9483121	REC27-43004A99
75 (4-Cyl.)	1984-88	USA	6432901	
75 (4-Cyl.)	1984-88	BEL	9393856	
75 (4-Cyl.)	1984-88	CAN	7208573	
80 (80, 800) (4-Cyl.)	1978-79	USA	4831999-6432900	
80 (80, 800) (4-Cyl.)	1978-79	AUS	8050200	



JUNTA CULATA
CYLINDER HEAD GASKET
GUARNIZIONE TESTATA
JOINT DE CULASSE

KIT JOINTS

80 (80, 800) (4-Cyl.)	1978-79	BEL	9177626-9393855		
80 (80, 800) (4-Cyl.)	1978-79	CAN	7110998-7208572		
80 (3-Cyl.)	1987	USA	0A996142+	REC27-43004A99	
80 (3-Cyl.)	1987	BEL	9483121	REC27-43004A99	
80 Jet (4-Cyl.)	1994-98	USA	0D283222+	REC27-13461A99	
80 Jet (4-Cyl.)	1994-98	BEL	9793577	REC27-13461A99	
90 (90, 900) (6-Cyl.)	1978-79	USA	4845301	REC27-85653A87	
90 (90, 900) (6-Cyl.)	1978-79	CAN	7111698	REC27-85653A87	
90 (90) (6-Cyl.)	1980-83	AUS	8060545	REC27-85653A87	
90 (3-Cyl.)	1987	USA	0A996142+	REC27-43004A99	
90 (3-Cyl.)	1987	BEL	9483121	REC27-43004A99	
100 (4-Cyl.)	1988-98	USA	0B209468+	REC27-13461A99	
100 (4-Cyl.)	1988-98	BEL	9523034	REC27-13461A99	
105 Jet (V6)	1996	USA	0D082000+	REC27-815791A92	REC27-18785T
115 (1150, 115) (6-Cyl.)	1973-79	USA	3525441	REC27-85653A87	
115 (1150, 115) (6-Cyl.)	1973-79	AUS	8008665	REC27-85653A87	
115 (1150, 115)	1978-79	CAN	7112248	REC27-85653A87	
115 (4-Cyl.)	1988-93	USA	0C100000+	REC27-13461A99	
115 (4-Cyl.)	1988-93	BEL	9559771	REC27-13461A99	
125 (4-Cyl.)	1994-98	USA	0D283222+	REC27-13461A99	
125 (4-Cyl.)	1994-98	BEL	9793577	REC27-13461A99	
140 (140, 1400) (6-Cyl.)	1972	USA	3293234-3502805	REC27-85653A87	
140 (140, 1400) (6-Cyl.)	1978-79	USA	4865678	REC27-85653A87	
140 (140, 1400) (6-Cyl.)	1978-79	AUS	8052650	REC27-85653A87	
140 (140, 1400) (6-Cyl.)	1978-79	CAN	7112773	REC27-85653A87	
150 (1500) (6-Cyl.)	1973-78	USA	3502806-5327662	REC27-85653A87	
150 (1500) (6-Cyl.)	1973-78	AUS	8005615-8052649	REC27-85653A87	
150 (1500) (6-Cyl.)	1973-77	CAN	7010533-7112772	REC27-85653A87	
V-135	1986-88	USA	0A904646-0C239552	REC27-90484A88	REC27-96542-1
V-135	1991	USA	0C239553-0G960499	REC27-815791A92	REC27-18785T
V-135	1996-98	USA	0G960500-0T178499		REC27-18785T
V-135 DFI	1992-95	USA	0C590000-0G960499	REC27-814754A00	
V-135 DFI	1998	USA	0G960500+	REC27-814754A00	
V-140 Jet	1996-98	USA	0D082000-0G960499	REC27-815791A92	REC27-822844T04
V-150 (150, 1500)	1973-77	USA	4868998-6042945	REC27-79583A81	REC27-79583-1
V-150	1982-90	USA	6042946-0C239552	REC27-90484A88	REC27-96542-1
V-150	1988-91	USA	0C239553-0G960499	REC27-815791A92	REC27-18785T
V-150	1996-98	USA	0G960500+	REC27-814754A00	
V-150 (XR4 / Magnum II)	1988	USA	0B242885-0C239552	REC27-11338A88	REC27-41246-1
V-150 (XR4)	1991	USA	0C239553-0D081999	REC27-815791A92	REC27-418786T
V-150 (XR6 / Magnum III)	1992-95	USA	0D082000-0G960499	REC27-815791A92	REC27-822844T04
V-150 (XR6 / Magnum III)	1996-98	USA	0G960500+	REC27-814754A00	
V-150 EFI	1993-98	USA	0D082000-0G960499	REC27-815791A92	REC27-822844T04
V-150 DFI	1998	USA	0D590000-0G960499	REC27-814754A00	
V-150 DFI	1998	USA	0G960500+	REC27-814754A00	
V-175 (175, 1750)	1976-81	USA	4301235-6618750	REC27-79583A81	REC27-79583-1
V-175 (175, 1750)	1976-79	AUS	8058870	REC27-79583A81	REC27-79583-1
V-175	1985-88	USA	6618751-0C239552	REC27-11338A88	REC27-41246-1
V-175	1991	USA	0C239553-0D081999	REC27-815791A92	REC27-418786T
V-175	1992-95	USA	0D082000-0G960499	REC27-815791A92	REC27-822844T04
V-175 EFI	1992-95	USA	0D000750-0D081999	REC27-815791A92	REC27-418786T
V-175 EFI	1992-95	USA	0D082000-0G960499	REC27-815791A92	REC27-822844T04
V-175 EFI	1992-98	USA	0T178500+	REC27-814754A00	
V-200 (200, 2000)	1978-79	USA	4839034-6073191		REC27-41245-1
V-200 (200, 2000)	1980-81	AUS	8061595-8065672		REC27-41245-1
V-200	1982	USA	6073192-6203990		REC27-41245-1
V-200	1983	USA	6203991-0C291519	REC27-89221A88	REC27-41246-1
V-200	1991	USA	0C291520-0D081999	REC27-815791A92	REC27-822844T04
V-200	1992-95	USA	0D082000 +	REC27-815791A92	REC27-822844T04
V-200 EFI	1989-90	USA	0C100861-0C291519	REC27-14697A87	REC27-41246-1
V-200 EFI	1991	USA	0C291520-0G960499	REC27-815791A92	REC27-822844T04
V-220	1987-88	USA	0B117316+	REC27-14697A87	REC27-41246-1
V-225	1980-81	USA	5628028		REC27-41245-1
V-225 EFI (3.0L) (1)	1995-98	USA	0G129222-0T408999		REC69J-11181-03
V-225 EFI (3.0L) (1)	1995-98	USA	0T409000-0T598999		REC69J-11181-03
V-225 EFI (3.0L) (1)	1995-98	USA	0T599000+		REC69J-11181-03

MERCURY

RECAMBIO
MARINOS

RETENES TAPA CULATA

GASKET CYLINDER SEALS

PARAOILIO COPERCHIO
TESTATA

JOINT COUVERCLE DE
CULASSE

REF	OEM	
REC81554	858452-1	V6 2.5L (1998+)

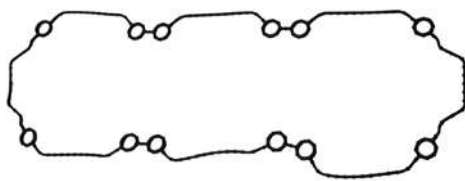

REF	OEM	
REC818574	818574	V6 3.0L (1998+)

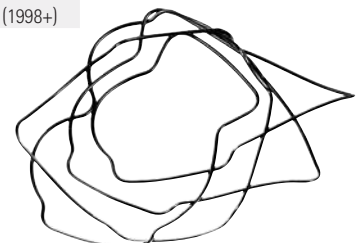

2T
STROKES

JUNTAS DE CULATÍN GASKET, HEAD COVER

REF	OEM	Icon
REC27-78410	27-78410	20 HP (1978-80)

REF	OEM	Icon
REC27-43772	27-43772-2	30 Jet 40-50 HP (4 cyl) (1980-97)

REF	OEM	Icon
REC27-856729	27-85490-2	35/40 (2 cyl) (1980-89)

REF	OEM	Icon
REC6E9-11193-A0	27-97704M	40C, 40 Twin Carb

REF	OEM	Icon
REC663-11193-00	27-81254M	48, 55, N48 60 (2 cyl)

GUARNIZIONI COPERCHIO TESTATA JOINT DE COUVRE CULASSE

REF	OEM	Icon
REC27-85487	27-85487	45, 50 HP (4 cyl) (1980-86)

REF	OEM	Icon
REC27-437792	27-43779-2	50-60 HP (3 cyl) (1984-90)

REF	OEM	Icon
REC27-88449	27-88449	50-70 HP (3 cyl) (1980-90)

REF	OEM	Icon
REC27-96278	27-96278	135-200 HP (V-Models) (1976-88)

REF	OEM	Icon
REC951853	27-98185 27-981853	90, 115 HP (6 cyl in line)

CIGÜEÑAL

CRANKSHAFT

ALBERO MOTORE

VILEBREQUIN

2T
STROKES

RETENES

OIL SEALS

PARAOLIO

JOINT SPI

REF	OEM
REC26-16977	26-16977
REC26-419533	26-41953 3
REC26-43993	26-43993
REC26-66301	26-66301
REC26-56397	26-56397
REC26-66302	26-66302
REC26-859093	26-815449
REC26-830898	26-830898



REC26-859093



REC26-16977



REC26-43993



REC26-66301



REC26-56397



REC26-66302



REC26-830898



REC26-419533

2T
STROKES

AROS TÓRICOS

O-RINGS

O-RING

JOINT TORIQUE

REF	OEM
REC25-20081	25-20081
REC308627	25-20826
REC25-80863	25-20863
REC553126	25-31305
REC25-33465	25-54029
REC25-823683	25-823683
REC25-32546	25-32546

REF	OEM
REC25-62700	25-62700
REC25-62706	25-67207
REC335523	25-88955
REC25-90011	25-90011
REC25-89497	25-89497
REC310414	25-47254

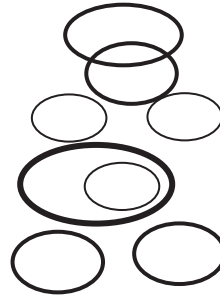

2T
STROKES

COJINETE

BEARING

CUSCINETTO

ROULEMENT

REF	OEM	DESCRIPTION
REC31-16756A6	31-16756A6	V135 - V200 XR6
REC30-160494	30-160494	9.9, 15, 18 HP International
REC30-16049	30-16049	2, 2.5, 3.5 HP
REC31-816773A2	31-816773A1	20, 225, 250 (3.0L) EFI / DFI
REC377139	30-63742T 30-63742	35 - 115 HP
REC30-67923T	30-67923T 30-67923	V135 - 300 HP
REC30-64424T	30-64424T 30-64424	50, 60, 70 HP 3 CYL
REC30-62567T	30-62567T	75, 80, 90, 115 HP 4 CYL
REC31-812873A1	31-812873A1	45 JET, 502, 55, 60 (3 Cyl)



REC31-16756A6



REC31-816773A2



REC30-67923T



REC30-62567T



REC30-16049
REC30-160494



REC30-64424T



REC377139



REC31-812873A1

MERCURY

RECAMBIOS
MARINOS

GUÍA COJINETES, RETENES Y AROS TORICOS

BEARINGS, OIL SEALS & O-RINGS GUIDE

GUIDA CUSCINETTO, TENUTE E FASCE

GUIDE DE ROULEMENTS, JOINTS ET TORIQUES

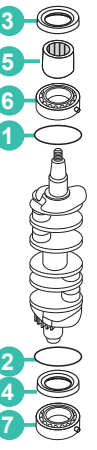

Stroke	Qty	Year	Model	Bearing/Seal		Cushioning		Roller/Joint/Torque		
				1	2	3	4	5	6	7
3.6		1980-82	BEL 9252831	REC25-80863			REC26-56397			
4 (40)	1	1972-74	BEL 9000306-9072178	REC25-80863			REC26-56397		REC30-16049	
4	1	1982-86	BEL 9258281	REC25-80863			REC26-56397		REC30-16049	
4	1	1987-88	BEL 9477830						REC30-16049	
4 (40) (Gnat)	2	1976-79	BEL 9075839-9256980		REC25-62706					
4 (40)	2	1980-81	BEL 9256981		REC25-62706					
4.5 (4.5, 45)	1	1975-79	BEL 9072179-9258280	REC25-80863			REC26-56397			
4.5	1	1980-85	BEL 9258281	REC25-80863			REC26-56397			
5	1	1987-89	BEL 9477830						REC30-16049	
6		1986-93	BEL 9461526							
7.5 (7.5, 75)		1974-77	BEL 9043194	REC25-80863						
8		1986-93	BEL 9461526							
9.8 (9.8) (110)		1974-77	BEL 9041439	REC25-80863						
9.9		1986-93	BEL 9461526							
10 (XR10)		1990-93	BEL 9596000							
10 (Magnum, Sea Pro, Marathon)		1990-93	BEL 9596000							
15		1988-93	BEL 9542620							
15 (Sea Pro, XD, Marathon)		1997-98	BEL 9927000							
15 (Super)		1994-98	BEL 9507381							
18 (18, 18 XD)		1980-83	BEL 9308306							
20 (200, 20)		1973-77	BEL 9016254-9415100				REC26-66302		REC30-63326T	REC30-63326T
20 (20, 20XD)		1986-87	BEL 9415101							
25 (25, 25XD)	2	1980-83	BEL 9315316							
40 (402)	2	1972-74	BEL 3339688-9076838	REC310414			REC26-419533	REC26-419533		REC377139
40 (402, 40)	2	1975-77	BEL 9076839	REC310414	REC25-823683		REC26-419533	REC26-419533		REC377139
40	4	1989	BEL 9570790-9793444		REC25-32546		REC26-66301	REC26-419533		REC377139
40	4	1989	BEL 9793445		REC25-32546		REC26-419533	REC26-419533		REC377139
40	3	1997-98	BEL 9973100		REC25-896523		REC26-419533	REC26-419533		REC377139
45	4	1986	BEL 9248006				REC26-419533	REC26-419533		REC377139
50 (50, 500)	4	1971-74	BEL 9001581				REC26-419533	REC26-419533		REC377139
50	3	1986-87	BEL 9385911-9683054		REC25-32546		REC26-419533	REC26-419533	REC30-64424T	REC30-64424T
50	3	1991-95	BEL 9683055-9973099		REC25-896523		REC26-419533	REC26-419533	REC31-812873A1	REC377139
50	3	1998	BEL 9973100		REC25-896523		REC26-419533	REC26-419533		REC377139
55	3	1996	BEL 9683055-9973099		REC25-896523		REC26-419533	REC26-419533	REC31-812873A1	REC377139
55	3	1998	BEL 9973100		REC25-896523		REC26-419533	REC26-419533		REC377139
60	3	1984-87	BEL 9385911-9683054		REC25-32546		REC26-419533	REC26-419533	REC30-64424T	REC30-64424T
60	3	1991-95	BEL 9683055-9973099		REC25-896523		REC26-66301	REC26-419533	REC31-812873A1	REC377139
65 (650)	3	1973-76	BEL 9020074-9135824	REC310414	REC25-32546		REC26-419533	REC26-419533		REC30-64424T
70	3	1977-83	BEL 9135825-9385910		REC25-32546		REC26-419533	REC26-419533		REC30-64424T
70	3	1987	BEL 9483121-9506480	REC25-823683			REC26-419533	REC26-419533	REC31-43013T3	
70	3	1988-89	BEL 9506481	REC25-823683	REC25-33465		REC26-419533	REC26-419533	REC31-43013T3	
75	4	1984-88	BEL 9393856	REC310414	REC25-32546		REC26-419533	REC26-419533		REC30-62567T
75	3	1990-93	BEL 9589039	REC25-823683			REC26-419533	REC26-419533	REC31-43013T3	REC377139
80 (80, 800)	4	1978-79	BEL 9177626-9393855	REC310414	REC25-32546		REC26-419533	REC26-419533		REC30-62567T
80	3	1987	BEL 9483121-9506480	REC25-823683			REC26-419533	REC26-419533	REC31-43013T3	
80	3	1987	BEL 9506481	REC25-823683	REC25-33465		REC26-419533	REC26-419533	REC31-43013T3	
85 (850)	4	1973-77	BEL 9011604-9177625	REC310414	REC25-32546		REC26-419533	REC26-419533		REC377139
90	3	1987	BEL 9483121	REC25-823683			REC26-419533	REC26-419533	REC31-43013T3	
100	4	1988-93	BEL 9523034-0P016999	REC25-823683			REC26-419533	REC26-419533	REC31-43013T3	
100	4	1994-98	BEL 0P017000 +	REC25-823683			REC26-419533	REC26-419533	REC31-43013T3	
100	4	1994-98	BEL 0P017000 +				REC26-419533	REC26-419533	REC31-43013T3	
115	4	1988-93	BEL 9559771-0P016999	REC25-823683			REC26-419533	REC26-419533	REC31-43013T3	
115	4	1988-93	BEL 0P017000 +	REC25-823683			REC26-419533	REC26-419533	REC31-43013T3	

2T
STROKESGUÍA
RODAMIENTOSGUIDE
ENGINE BEARINGGUIDA
CUSCINETTIGUIDE
ROULEMENTS

1

2

3

15 (Marathon Sea Pro)	1997-98	9927000			REC31-879877A1	
15 (Super)	1994-98	9507381-9855586			REC31-879877A1	
15 (Super)	1994-98	9855587			REC31-879877A1	
18	1980-83	9308306-9378115			REC31-879877A1	
18	1980-83	7200763-7207856			REC31-879877A1	
18	1983 1/3	9378115-9415100			REC31-879877A1	
18 (18XD)	1984-85	9378151-9467987			REC31-879877A1	
18 XD	1984-85	9467988			REC31-879877A1	
20 (20XD) (2-Cyl.)	1986-87	9415101-9467987			REC31-879877A1	
20 (20XD) (2-Cyl.)	1986-87	9467988			REC31-879877A1	
20 (20)	1988-94	9507381			REC31-879877A1	
20 (20, 20 Jet) (2-Cyl.)	1994-98	9807909-9855586			REC31-879877A1	
20 (20, 20 Jet) (2-Cyl.)	1994-98	9855587			REC31-879877A1	
25	1980-83	9315316-9369470			REC31-879877A1	
25 (2-Cyl.)	1983 1/2	9369471-9415100			REC31-879877A1	
25 (XD)	1984-87	9415101-9467987			REC31-879877A1	
25 (XD)	1988-94	9467988			REC31-879877A1	
25 (25, 25 Sea Pro, 25 Marathon)	1988-94	9507381-9855586			REC31-879877A1	
25 (25, 25 Sea Pro, 25 Marathon)	1994-98	9855587			REC31-879877A1	
35 (2-Cyl.)	1984-86	9384476		REC29-47270	REC31-62596A1	
40 (402)	1972-74	3339688-9076838		REC29-47270	REC31-62596A1	
40 (402, 40)	1975-77	9076839-9251455		REC29-47270	REC31-62596A1	
40 (2-Cyl.)	1980-83	9251456		REC29-47270	REC31-62596A1	
40 (3-Cyl.)	1997-98	9973100		REC29-47270	REC31-17514A2	
40 (4-Cyl.)	1989	9570790	REC29-71422-1			
45 (4-Cyl.)	1986	9248006	REC29-71422-1			
50	1976-79	9217256-9248005	REC29-71422-1			
50 (4-Cyl.)	1980-85	9248006	REC29-71422-1			
50 (3-Cyl.)	1991-95	9683055-9973099		REC29-47270	REC31-17514A2	
50 (3-Cyl.)	1998	9973100		REC29-47270	REC31-17514A2	
50 (3-Cyl.)	1986-87	9385911-9683054	REC29-71422-1	REC29-47270	REC31-62596A1	
55 (3-Cyl.)	1996	9741042-9973099		REC29-47270	REC31-17514A2	
55 (3-Cyl.)	1998	9973100		REC29-47270	REC31-17514A2	
60 (3-Cyl.)	1984-87	9385911-9683054	REC29-71422-1	REC29-47270	REC31-62596A1	
60 (3-Cyl.)	1991-95	9683055-9973099		REC29-47270	REC31-17514A2	
60 (59 CID) (3-Cyl.)	1998	9973100		REC29-47270	REC31-17514A2	
65 Jet	1994-98	9793577		REC29-818391001	REC31-43012A1	
70 (3-Cyl.)	1977-79	9135825-9255130	REC29-71422-1	REC29-47270	REC31-62596A1	
70 (3-Cyl.)	1980-83	9255131-9385910	REC29-71422-1	REC29-47270	REC31-62596A1	
70 (3-Cyl.)	1987	9483121		REC29-88258	REC31-43012A1	938-8532-1
70 (3-Cyl.)	1987	9483121		REC29-818391001	REC31-43012A1	638-818846
75 (4-Cyl.)	1984-88	9393856	REC29-71422-1	REC29-47270	REC31-62596A1	
75 (3-Cyl.)	1990-93	9589039-9793576		REC29-88258	REC31-43012A1	638-8532-1
75 (3-Cyl.)	1990-93	9589039-9793576		REC29-818391001	REC31-43012A1	638-818846
75 (3-Cyl.)	1994-98	9793577		REC29-818391001	REC31-43012A1	
80 (80, 800) (4-Cyl.)	1978-79	9177626-9256130	REC29-71422-1	REC29-47270	REC31-62596A1	
80 (80) (4-Cyl.)	1980-83	9256131-9393855	REC29-71422-1	REC29-47270	REC31-62596A1	
80 (3-Cyl.)	1987	9483121-9589038		REC29-88258	REC31-43012A1	638-8532-1
80 (3-Cyl.)	1987	9483121-9589038		REC29-818391001	REC31-43012A1	646-818846
80 Jet	1994-98	9793577		REC29-818391001	REC31-43012A1	
85 (850) (4-Cyl.)	1973-77	9011604-9053363	REC29-71422-1	REC29-47270	REC31-62596A1	
85 (850) (4-Cyl.)	1973-77	9053364-9177625	REC29-71422-1	REC29-47270	REC31-62596A1	
90 (3-Cyl.)	1987	9483121-9793576		REC29-88258	REC31-43012A1	638-8532-1
90 (3-Cyl.)	1987	9483121-9793576		REC29-818391001	REC31-43012A1	646-818846
90 (90) (3-Cyl.)	1994-98	9793577		REC29-818391001	REC31-43012A1	
115 (4-Cyl.)	1988-93	9559771		REC29-88258	REC31-43012A1	638-8532-1
115 (4-Cyl.)	1989-93	9559771		REC29-818391001	REC31-43012A1	646-818846
115 (4-Cyl.)	1994-98	9793577		REC29-818391001	REC31-43012A1	
125 (4-Cyl.)	1994-98	9793577		REC29-818391001	REC31-43012A1	

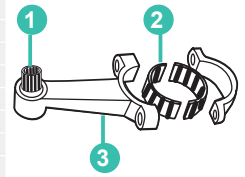
2T
STROKES

AGUJA DE COJINETE

NEEDLE BEARING

AGHI CUSCINETTO

AGUILLE DE PALIER

REF	OEM	L +0 -0.008	D Ø +0 -0.002
REC29-47270	29-47270	41/64"	3/32"
REC29-67483	29-67483	51/64"	3/32"
REC29-71422-1	29-71422-1	39/64"	5/32"
REC29-818391001	29-818391 818391001	59/64"	3/32"
REC29-822553	29-822553	45/64"	3/32"
REC29-88258	29-88258	1-1/32"	3/32"

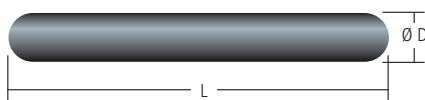

2T
STROKES

COJINETE DE BIELA

CONNECTING ROD BEARING

CUSCINETTO BIELLA

ROULEMENT DE BIELLE

REF	OEM	
REC31-16052	31-16052	4 - 18 HP



REF	OEM	
REC31-8130482	31-813048 2	25 / 30 / 40 HP (Inter.)







REF	OEM	
REC31-813048	31-813048	4, 5 HP



REF	OEM	
REC31-16756A4	31-16756A4	
REC31-43013T3	31-43012T3	75 - 125 HP
REC31-74248T	31-74248T	



REF	OEM		\emptyset		
REC31-43012A1	31-43012A1, A2	60 - 250HP	1.4063"	16	METAL METALLO





OEM	RO OEM	\emptyset		
REC31-17514A2	31-17514A1, A2	1.1825" / 30 mm	16	METAL METALLO



OEM	RO OEM
REC31-8036752	31-803675 2



REF	OEM	
REC31-17514A2	8M0045428	30 - 60 HP V-135 - V200 / XR-6



REF	OEM	
REC827955A2	827955A2	30 - 60 HP



REF	OEM	
REC42943A1	42943A1	70 - 115 HP



OEM	RO OEM	\emptyset		
REC31-879877A1	31-879877A1	0.875"	16	METAL METALLO
REC31-62596A1	31-62596A1	1.125"	16	METAL METALLO



OEM	RO OEM	\emptyset		
REC378252	31-67445	1.375"	16	METAL METALLO



OEM	RO OEM	\emptyset		
REC5007190	31-88269T	2.1875"	16	Plástico Plastic Plastica Plastique



MERCURY

RECAMBIO
MARINOS

PISTONES

PISTON

PISTONE

PISTONS

2T
STROKES

KITS DE PISTONES

La gama de pistones RECMAR®, se suministrará siempre como kit, compuesto por pistón, aros, bulón y clips. Eventualmente las referencias antiguas sufren cambios de numeración. En caso de duda contacten con nuestros técnicos comerciales.

PISTON KITS



The RECMAR® piston assortment is always supplied as a set (piston, rings, pins and bearings). Old references may change. In case of any doubt contact our technicians.

KIT PISTONE



La gamma dei pistoni RECMAR®, si vende sempre come kit, composto da pistoni, fasce, bulloni e clips. Le referenze vecchie avranno un cambio di numerazione. In caso di dubbi contattare i nostri tecnici commerciali.

KIT PISTON

La gamme de pistons RECMAR® sera toujours fournie en kit, comprenant piston, segments, axe et clips. Les anciennes références subissent des modifications de numérotation. En cas de doute, contactez nos technico commerciaux

STD Ø 65mm 2.562"		REF		OEM		
	REC780-9229A7	780-9229A7	Crossflow			
	REC39-18653A12	39-18653A12	4 cyl IN LINE 30 JET (1998-02) 40 HP (1990-97) 45 HP (1985-89) 50 HP (1970-85)			







STD		REF		OEM		
	PORT REC2720-881054T10K	2720-881054T3	200 / 225 HP 3.0L DFI-DTS			
	STB REC2720-881055T10K	2720-881055T3				
	REC29-88258	29-88258001				



STD Ø 76 mm 2.993"		REF		OEM		
	REC705-850026T1K	705-850026A3	0.30			
	REC39-821695A4	39-821695A4	2 cyl 30 HP (1994-02) 30 JET (1998-02)			
	REC29-47270	29-47270	REC29-47270	29-47270	3 cyl 40 HP (1997-02) 50 HP (1998-02) 55 HP (1998-02) 60 HP (1998-02)	



STD Ø 76 mm 2.993"		REF		OEM		
	REC783-9613A1K	783-9613T1	REC783-9613T3	783-9613T3	0.30	
	REC39-19721A6	39-19721A6	Crossflow			
	REC29-47270	29-47270	REC29-47270	29-47270	3 cyl 45 JET (1984-90) 50 HP / 55 HP / 60 HP (1998-02)	











STD Ø 79 mm 3.125"		REF		OEM		
	PORT REC765-7442T36	765-7442T36	REC765-7446T12	765-7446T12	0.30	
	STB REC765-7441T36	765-7441T36	REC765-7445A12	765-7445A12	LoopCharge V-6 60°	
	REC29-67483	29-67483	REC29-67483	29-67483	6 cyl V135 (0A904646-0D081999) (636-8118) V150 (4868998-0D081999) (636-8118) V150 XR2 (468998-0A904645) V175 (4301235-6618750)	













STD Ø 79 mm 3.125"		REF		OEM		
	PORT REC765-7442T32	765-7442T32	REC765-7446A11	765-7446A11	0.30	
	STB REC765-7441T32	765-7441T32	REC765-7445T11	765-7445T11	LoopCharge V-6 60°	
	REC29-822553	29-822553	REC29-822553	29-822553	6 cyl V150 Jet (0G760299) V135 (0C239553-0T178499) (644-818141) V135 (0C239553-0T178499) (644-818141) V140 Jet (0G760299+) V150 (0C239553-0G760299) (644-818141)	











	STD Ø 85 mm 3.375"		0.30		LoopCharge		
	REF	OEM	REF	OEM			
	REC777-9009T13	777-9009T13	REC777-9009A7	777-9009A7	3 cyl 70 HP (1987-89) 75 HP (1990-93) 80 HP (1987-89) 90 HP (1987-93)		
	REC29-88258	29-88258	REC29-88258	29-88258	4 cyl 100 HP (1989-93) 115 HP (1989-93)		

	STD Ø 85 mm 3.375"		0.30		LoopCharge	 	
	REF	OEM	REF	OEM			
	REC777-815965A4	777-815965A4	REC777-815965A6	777-815965A6	3 cyl 70 HP (1987-89) 75 HP (1990-93) 80 HP (1987-89) 90 HP (1987-93)	646-818846.	
	REC29-818391001	29-818391	REC29-818391001	29-818391	4 cyl 100 HP (1989-93) 115 HP (1989-93)		

	STD Ø 85 mm 3.375"		0.30		LoopCharge		
	REF	OEM	REF	OEM			
	PORT REC766-8667T41	766-8667T41	REC14355		V-6, XR4, MAG II		
	STB REC766-8666T41	766-8666T41	REC14365				
	REC39-813011A12	39-813011A12			V175 (6618751 - 0C239552) V100 (5624878 - 0C219519) V200 EFI (9C100861 - 0C999999)		
	REC29-67483	29-67483	REC29-67483	29-67483	V220 (0B117316+) V225 (5628028+)		

	STD Ø 88.9 mm 3.500"		0.30		LoopCharge		
	REF	OEM	REF	OEM			
	REC2704-826191T4K	2704-826191A4	REC2704-821896A4	2704-821896A4	3 cyl 65 / 80 JET (1994-98) 75 / 90 HP (1994-04)		
			REC39-822321A2	39-822321A2			
	REC29-818391001	29-818391	REC29-818391001	29-818391	4 cyl 100 HP (1994-01) 115 HP (1994-04) 125 HP (1994-04)		

	STD Ø 88.9 mm 3.500"		0.30 3.375"		LoopCharge		
	REF	OEM	REF	OEM			
	PORT REC785-9737T9	785-9737T9	REC14450		V-6 60°		
	STB REC785-9738T9	785-9738T9	REC14460		6 cyl V140 Jet (0G760300-0T178499) XR6, MAGIII (0D082000-1B226999) 150 XRI (0D082000-0G303045) 175 XRI (0D000750-0G303045) V175 2.5L (0D082000-0G960499) 200 XRI (0C291520-0G303045) V200 2.5L (0D082000-1B226999) V200 2.5L (0C291520-0D081999) V200 EFI (0G303046-0T408999)	644-818141) 644-818141)	
	2 mm REC39-822321A2	39-822321A12	REC39-822321A2	39-822321A12			

	STD Ø 73 mm 2.875"		0.30		Crossflow		
	REF	OEM	REF	OEM			
			REC774-9137A11	774-9137A11	4 cyl Inline 75 HP (1984-86) 80 HP (1978-83) 85 HP (1973-77)		
	REC39-817096A6	39-817096A6			3 cyl 40 HP (1990-97) 50 JET (1984-90) 50 HP / 60 HP (1984-90) 70 HP (1977-83)		
					6 cyl Inline 90 HP (1978-86) 115 HP (1984-88) 135 HP (1970-71) 140 HP (1978-80) 150 HP (1973-78)		





2T
STROKES

GUÍA BIELAS, CIGÜEÑAL Y PISTÓN

CONNECTING ROD, CRANKSHAFT & PISTON GUIDE

GUIDA BIELLE, ALBERO MOTORE E PISTONE

GUIDE BIELLE, VILEBREQUIN PISTON

				
4A	6E0-001011 +	REC6E0-11651-01		REC6E0-11631-00-98K
04/05/21	OP017000 +			REC779-9615T
4/5 (1 Cyl, JAPAN)	477830 - 9589153			REC779-9615T
6 & 8 (2 Cyl) (INTER.)	ON027903 +	REC629-8036741		REC779-804886
6 & 8 (2 Cyl) (INTER.)	ON055110 +	REC629-8036741		REC779-804886
8 SEAPRO (2 Cyl) (INTER.)	ON14717 +	REC629-8036741		REC779-804886
9.8 (2 Cyl) (INTER.)	ON007788 - ON055109	REC629-8036741		REC779-804886
9.8 SEAPRO (2 Cyl) (INTER.)	ON055110 +	REC629-8036741		REC779-804886
9.9 (2 Cyl) (INTER.)	ON059858 +	REC629-803674		REC779-803677T02
15 (2 Cyl) (INTER.)	ON001590 +	REC629-803674		REC779-803677
18 (2 Cyl) (INTER.)	ON001590 +	REC629-803674		REC779-803677
25 JET (2 Cyl) (INTER.)	ON088578 +	REC629-813047T01		REC779-879194T01
25 & 30 (2 Cyl) (INTER.)	ON055505 +	REC629-813047T01		REC779-879194T01
30 JET (3 Cyl)	9973100	REC640-9612A7		REC705-850026T1K
40 (INTER.)	ON056265 +	REC629-880855		REC779-96152
40 LIGHTNING (INTER.)	ON000001- ON056164	REC629-880855		REC779-96152
40 LIGHTNING XR (INTER.)	ON000513 +	REC629-880855		REC779-96152
40MXL SEAPRO	ON037781 - ON056164	REC629-880855		REC779-96152
40 (3 Cyl)	9973100	REC640-9612A7		REC705-850026T1K
40 JET	OP094500 +	REC640-9612A7	REC2411-827954T2	REC705-850026T1K
45 JET	9973100 - OP094499	REC640-9612A7	REC2411-827954T2	REC705-850026T1K
50MH	ON056165 +	REC629-880855		REC779-96152
50 (3 Cyl)	9683055 - 9973099	REC640-9612A7		REC783-9613A1K
50 (3 Cyl)	9973100	REC640-9612A7		REC783-9613A1K
55 & 60 (3 Cyl)	9973100	REC640-9612A7	REC2411-827954T2	REC705-850026T1K
60 BIGFOOT (3 Cyl)	9973100	REC640-9612A7	REC2411-827954T2	REC705-850026T1K
65 & 80 JET	9793577	REC646-818845T6	REC493-827616T1 (NOT 80HP)	REC2704-826191T4K
75 & 90 (3 Cyl)	9483121 - 9793576 (638-8532-1)	REC638-9002A6		REC777-9009T13
75 & 90 (3 Cyl)	9483121 - 9793576 (646-818846)	REC646-818845T6		REC777-815965A4
75 & 90 (3 Cyl)	9793577	REC646-818845T6	REC493-827616T1	REC2704-826191T4K
100 & 115 (4 Cyl)	9523034 - 9793576 (638-8532-1)	REC638-9002A6		REC777-9009T13
100 & 115 (4 Cyl)	9523034 - 9793576 (646-818846)	REC646-818845T6		REC777-815965A4
100 (4 Cyl)	9793577 - OP058999	REC646-818845T6		REC2704-826191T4K
115 & 125 (4 Cyl)	9793577	REC646-818845T6		REC2704-826191T4K





2T
STROKES

GUÍA PISTÓN USA

PISTON GUIDE USA

GUIDA PISTONE USA

GUIDE PISTON USA

								
			STD	0.30	STD	0.30	STD	0.30
V-105 Jet	OD082000+		REC765-7442T32	REC765-7446A11	REC765-7441T32	REC765-7445T11	REC39-93481A12	
V-135	OA904646 - OD081999	636-8118	REC785-9737T9	REC765-7446T12	REC765-7441T36	REC765-7445A12	REC39-93481A12	
V-135	OA904646 - OD081999	644-818141	REC765-7442T32	REC765-7446A11	REC765-7441T32	REC765-7445T11	REC39-93481A12	
V-135	OD082000+		REC765-7442T32	REC765-7446A11	REC765-7441T32	REC765-7445T11	REC39-93481A12	
V-140 Jet	OD082000+		REC785-9737T9	REC14450	REC785-9738T9	REC14460		
V-150	OA904646 - OD081999	636-8118	REC785-9737T9	REC765-7446T12	REC765-7441T36	REC765-7445A12	REC39-93481A12	
V-150	OA904646 - OD081999	644-818141	REC765-7442T32	REC765-7446A11	REC765-7441T32	REC765-7445T11	REC39-93481A12	
V-150	OD082000+		REC765-7442T32	REC765-7446A11	REC765-7441T32	REC765-7445T11	REC39-93481A12	
XR6/ MAGIII	OD082000+		REC785-9737T9	REC14450	REC785-9738T9	REC14460		
V-175	6618751 - OC239552		REC766-8667T41	REC14355	REC766-8666741	REC14365	REC39-813011A12	
V-175	4301235		REC765-7442T36	REC765-7446T12	REC765-7441T36	REC765-7445A12	REC39-93481A12	
V-175	OD082000+		REC785-9737T9	REC14450	REC785-9738T9	REC14460		
V-200	4839034 - OC291519		REC766-8667T41	REC14355	REC766-8666741	REC14365	REC39-813011A12	
V-200	OC291520 - OD081999	644-818141	REC785-9737T9	REC14450	REC785-9738T9	REC14460		
V-200	OD082000+		REC785-9737T9	REC14450	REC785-9738T9	REC14460		
V-220 Laser	OB117316+		REC766-8667T41	REC14355	REC766-8666741	REC14365	REC39-813011A12	
V-225 (2.4L)	5628028		REC766-8667T41	REC14355	REC766-8666741	REC14365	REC39-813011A12	

GUÍA PISTÓN EUROPA		PISTON GUIDE EUROPE			GUIDA PISTONE EUROPA			GUIDE EUROPE				
CYL	STD	OEM STD	0.30	STD	OEM STD	0.30	REF	OEM	REF	OEM	REF	OEM
4 / 5 HP (0P017000)	1	REC779-9615T	779-9615T		REC8M0080357	8M0080357			REC53-16057	REC31-16052		REC31-813048
6 / 8 / 9.8 HP (Inter.)	2	REC779-804886	779-804886		REC39-803678A3	39-803678A3			REC41-8036801	REC31-8036752	REC629-8036741	
9.9 / 15 HP (Inter.)	2	REC779-803677T02	779-803677T02		REC8M0080357	8M0080357			REC53-16057	REC31-16052	REC629-803674	
9.9 / 15C	2	REC6E7-11631-00K	761-7982M-T		REC682-11610-01	39-15320M			REC93450-15023	REC93602-14104		
15 SEA PRO XD SUPER 15 (9855587)	2		767-879878T5			39-827491A12						REC31-879877A1
18HP (Inter.)	2	REC779-803677	779-803677		REC39-803678A1	39-803678A1			REC53-16057	REC31-16052	REC629-803674	
20 JET (9855587)	2		767-879878T5			39-827491A12						REC31-879877A1
25 SEA PRO MARATHON (9855587)	2		767-879878T5			39-827491A12						REC31-879877A1
25 / 30 HP (Inter.) (62931)	2	REC779-879194T01	779-879194T01		REC39-16054A5	39-16054A5			REC53-16057	REC345-00042-0	REC629-813047T01	REC31-8130482
30A	2	REC689-11631-00K	761-8484M		REC689-11610-00	39-14235M			REC663-11634-00	REC93602-20M02	REC689-11651-00	REC93310-624U5
30, 40HP (9973100)	2	REC705-850026T3	705-850026A3		REC39-821695A4	39-821695A4				REC29-47270		REC31-17514A2
35 (9384476)	2		774-9137A9	REC774-9137A11	REC39-817096A6	39-817096A6				REC29-47270		
40 Lightning XR/ MXL (Inter.) (3339688)	3	REC779-96152	779-96152		REC8M0080349	8M0080349			REC53-16057	REC345-00042-0		
40 (40,402) (3339688)	2		774-9137A9	REC774-9137A11	REC39-817096A6	39-817096A6				REC29-47270		
40 (9973100)	3	REC705-850026T3	705-850026A3		REC39-821695A4	39-821695A4				REC29-47270	REC640-9612A7	REC31-17514A2
40 (9670790)	4	REC780-9229A7	780-9229A7		REC39-18653A12	39-18653A12						
45 (9248006)	4	REC780-9229A7	780-9229A7		REC39-18653A12	39-18653A12						
50 (500) (9901581)	4	REC780-9229A7	780-9229A7		REC39-18653A12	39-18653A12						
50 (9385111-9683054)	3			REC774-9137A11	REC39-817096A6	39-817096A6				REC29-47270		
50 (9683055 - 9973099)	3	REC783-9613A1K	783-9613A1	REC783-9613T3	REC39-19721A6	39-19721A6				REC29-47270		REC31-17514A2
50 (9973100)	3	REC705-850026T3	705-850026A3		REC39-821695A4	39-821695A4				REC29-47270		REC31-17514A2
55 (9683055 - 9973099)	3	REC783-9613A1K	783-9613T1	REC783-9613T3	REC39-19721A6	39-19721A6				REC29-47270	REC640-9612A7	REC31-17514A2
55 (9973100)	3	REC705-850026T3	705-850026A3		REC39-821695A4	39-821695A4				REC29-47270		REC31-17514A2
60 (9385911 - 9683054)	3		774-9137A9	REC774-9137A11	REC39-817096A6	39-817096A6				REC29-47270		
60 (9683055 - 9973099)	3	REC783-9613A1K	783-9613T1	REC783-9613T3	REC39-19721A6	39-19721A6				REC29-47270	REC640-9612A7	REC31-17514A2
60 (9973100)	3	REC705-850026T3	705-850026A3		REC39-821695A4	39-821695A4				REC29-47270	REC640-9612A7	REC31-17514A2
65 (9020074 - 9135824)	3			REC774-9137A11	REC39-817096A6	39-817096A6				REC29-47270		REC31-62596A1
70 (9135825 - 9385910)	3			REC774-9137A11	REC39-817096A6	39-817096A6				REC29-47270		REC31-62596A1
70 (9483121)	3	REC777-9009T13	777-9009T13	REC777-9009A7	REC39-96170A12	39-96170A12				REC29-88258		REC31-43012A1
75 (9393856)	4	REC777-815965A4	777-815965A4	REC777-815965A6	REC39-96170A12	39-96170A12				REC29-818391001	REC646-818845T6	646-8188461
75 (9589039 - 9793576)	3	REC777-9009T13	777-9009T13	REC777-9009A7	REC39-96170A12	39-96170A12				REC29-88258		638-8532-1
75 (9793577)	3	REC777-815965A4	777-815965A4	REC777-815965A6	REC39-96170A12	39-96170A12				REC29-818391001	REC646-818845T6	646-818846
80 (800) (9177626 - 93933855)	4	REC2704-826191T4K	2704-826191A4	REC2704-821896A4	REC39-822321A12	REC39-822321A2				REC29-818391001	REC646-818845T6	REC31-43012A1
85 (850) (9011804 - 9177625)	4		774-9137A9	REC774-9137A11	REC39-817096A6	39-817096A6				REC29-47270		REC31-62596A1
90 (9483121 - 9793576)	3	REC777-9009T13	777-9009T13	REC777-9009A7	REC39-96170A12	39-96170A12				REC29-88258		638-8532-1
90 (9793577)	3	REC777-815965A4	777-815965A4	REC777-815965A6	REC39-96170A12	39-96170A12				REC29-818391001	REC646-818845T6	646-818846
100 (9523034 - 9793576)	4	REC2704-826191T4K	2704-826191A4	REC2704-821896A4	REC39-822321A12	REC39-822321A2				REC29-818391001	REC646-818845T6	REC31-43012A1
100 (9793577)	4	REC777-9009T13	777-9009T13	REC777-9009A7	REC39-96170A12	39-96170A12				REC29-88258		638-8532-1
115 (9559771 - 9793576)	4	REC777-815965A4	777-815965A4	REC777-815965A6	REC39-96170A12	39-96170A12				REC29-818391001	REC646-818845T6	646-818846
115 (9793577)	4	REC2704-826191T4K	2704-826191A4	REC2704-821896A4	REC39-822321A12	REC39-822321A2				REC29-818391001	REC646-818845T6	REC31-43012A1
125 (0P017000+)	4	REC2704-826191T4K	2704-826191A4	REC2704-821896A4	REC39-822321A12	REC39-822321A2				REC29-818391001	REC646-818845T6	REC31-43012A1
125 (1250)	6		774-9137A9	REC774-9137A11	REC39-817096A6	39-817096A6				REC29-47270		REC31-62596A1
135 (1350)	6		774-9137A9	REC774-9137A11	REC39-817096A6	39-817096A6				REC29-47270		REC31-62596A1
140 (1400)	6		774-9137A9	REC774-9137A11	REC39-817096A6	39-817096A6				REC29-47270		REC31-62596A1
150 (1500)	6		774-9137A9	REC774-9137A11	REC39-817096A6	39-817096A6				REC29-822559	REC644-818141A2	REC31-16756A6
200 EL 225 (3.0L) DFI-DIS PORT PISTON	6	REC2720-881054T10K	2720-881054T10							REC29-88258	REC647-822373A09	REC31-43012A1
200 EL 225 (3.0L) DFI-DIS STB PISTON	6	REC2720-881055T10K	2720-881055T10							REC29-88258	REC647-822373A09	REC31-43012A1

2T
STROKESAROS ESTANDAR PARA
PISTONES

STANDARD PISTON RINGS

FASCE STANDARD PER
PISTONI



SEGMENTS STANDARD

				OEM					OEM	
30 JET	9570790+			RM39-27841A12	39-2784112	115 4 cyl	9793577+		39-822321A12	
35	938476+			REC39-817096A6	39-817096A6	125	-43253111	REC39-817096A6	39-817096A6	
40	9570790+			RM39-27841A12	39-2784112	135	-3293233	REC39-817096A6	39-817096A6	
40	-9973099			REC39-817096A6	39-817096A6	140	4865678-350805	REC39-817096A6	39-817096A6	
45	9248006-9466692			RM39-27841A12	39-2784112	150	-5327662	REC39-817096A6	39-817096A6	
50	9248006			RM39-27841A12	39-2784112	V135	0A904646-0D819999	636-8118 644-818141	REC39-93481A12	39-93481A12
50	-9683054			REC39-817096A6	39-817096A6	V135	0D820000+		REC39-93481A12	39-93481A12
60	-9683054			REC39-817096A6	39-817096A6	V150	0A904646-0D819999	636-8118, 644-818141	REC39-93481A12	39-93481A12
65	-9135824			REC39-817096A6	39-817096A6	XR4, MAGII	0C239553-0D081999			39-18487A12
70	-9385910			REC39-817096A6	39-817096A6	V150	0D820000+		REC39-93481A12	39-93481A12
70	9483121+	638-8532-1 646-818846			39-96170A12	V175	4301235-6618750		REC39-93481A12	39-93481A12
75	9589039-9793576	638-8532-1 646-818846			39-96170A12	V175	805887+		REC39-93481A12	39-93481A12
75 3 cyl	9793577+				39-822321A12	V175	6618751-0C239552		REC39-813011A12	39-813011A12
80	-9393855			REC39-817096A6	39-817096A6	V175	0C239553-0D081999			39-18487A12
85	-9177625			REC39-817096A6	39-817096A6	V200	4839034-6073191		REC39-813011A12	39-813011A12
90	9483121-9793576	638-8532-1 646-818846			39-96170A12	V200	8061595-8065672		REC39-813011A12	39-813011A12
90 3 cyl	9793577+				39-822321A12	V200	6073197-0C291519		REC39-813011A12	39-813011A12
100	953034-9793576	638-8532-1 646-818846			39-96170A12	V200 LASER	0B117316		REC39-813011A12	39-813011A12
105 JET	0D082000+			REC39-93481A12	39-93481A12	V225 2.4L	5628028		REC39-813011A12	39-813011A12
115	5829464-5829463			REC39-817096A6	39-817096A6					
115	9559771-9793576	638-8532-1 646-818846			39-96170A12					

CORREAS DE
DISTRIBUCION

TIMING BELT

CINGHIE
DISTRIBUZIONECOURROIES DE
DISTRIBUTION

REF	OEM			4T STROKES	2T STROKES
REC57-8M0072670	57-8M0072670	25, 30 EFI (3CYL) (OR10699+)			✓
		25JET EFI (3CYL) (OR165086+)			
REC66M-46241-00	835392 57-835392Q	9.9, 13.5, 15 HP (INT)	68		✓
REC57-8M0135591	57-8M0135591	9.9, 15, 15, 20 EFI			✓



new

REF	OEM		4T STROKES	2T STROKES
REC66M-46241-00	57-835392Q	8 HP (Bodensee) (inter.) 9.9 HP (323 cc) 13.5 HP i (inter.) 15 HP		✓
REC65W-46241-00	831294 57-8M0065179	25 - 60 HP		✓
PAF8-05000004	57-895120	8 HP (OR042475+) 9.9 HP (OR042475+)		✓



GUÍA CORREAS

PROPETS

GUIDHE

GUIDE DES COURROIES

		DISTRIBUCIÓN TIMMING BELT / DISTRIBUZIONE / DISTRIBUTION		ALTERNADOR / ALTERNATOR / ALTERNATEUR			DISTRIBUCIÓN TIMMING BELT / DISTRIBUZIONE / DISTRIBUTION		ALTERNADOR / ALTERNATOR / ALTERNATEUR
		CYL					CYL		
10 EFI									
15 EFI									
15EFI SEAPRO	OR832820 +	2	REC57-8M0135591		175 VERADO				REC57-880566Q14
20EFI									REC57-880566Q14
25 EFI	OR106966 +	3	REC57-8M0072670						REC57-880566Q14
	OP153500 -OP400999	3	REC65W-46241-00						REC57-880566Q14
	OR106999 +	3	REC57-8M0072670						REC57-880566Q14
30 EFI	OT409000 - 1B226999	3	REC65W-46241-00		175 (3.4L) V6 Et Pro XS				REC57-880566Q14
	1C109093 - 1C456299	3	REC65W-46241-00						REC57-880566Q14
	1C456300 +	3	REC65W-46241-00						REC57-880566Q14
	OP153500 -OP400999	BEL 3	REC65W-46241-00						REC57-880566Q14
	OP401000 - OP515896	BEL 3	REC65W-46241-00						REC57-880566Q14
	OP409000 - 1B226999	USA 3	REC65W-46241-00						REC57-880566Q14
	1B227000 - 1B355027	USA 3	REC65W-46241-00						REC57-880566Q14
	1C000001 - 1C043416	3	REC65W-46241-00						REC57-880566Q14
	1C043417 - 1C456299	3	REC65W-46241-00						REC57-880566Q14
	1C456300 +	3	REC65W-46241-00						REC57-880566Q14
40 EFI	OP153500 - OP400999	BEL 4	REC65W-46241-00						REC57-880566Q14
	OP401000 - OP515896	BEL 4	REC65W-46241-00						REC57-880566Q14
	OP515897 - OP580772	BEL 4	REC65W-46241-00						REC57-880566Q14
	OT409000 - 1B355222	USA 4	REC65W-46241-00						REC57-880566Q14
	1C000001 - 1C050251	USA 4	REC65W-46241-00						REC57-880566Q14
	1C050252 - 1C453839	USA 4	REC65W-46241-00						REC57-880566Q14
40 EFI Et SEAPRO	1C453840 +	USA 4	REC65W-46241-00						REC57-880566Q14
	OP153500 - OP400999	BEL 4	REC65W-46241-00						REC57-880566Q14
	OP401000 - OP515896	BEL 4	REC65W-46241-00						REC57-880566Q14
	OP515897 - OP580772	BEL 4	REC65W-46241-00						REC57-880566Q14
50 EFI	OT409000 - 1B355222	USA 4	REC65W-46241-00						REC57-880566Q14
	1C000001 - 1C050251	USA 4	REC65W-46241-00						REC57-880566Q14
	1C050252 - 1C453839	USA 4	REC65W-46241-00						REC57-880566Q14
	1C453840 +	USA 4	REC65W-46241-00						REC57-880566Q14
	OP153500 - OP400999	BEL 4	REC65W-46241-00						REC57-880566Q14
	OP401000 - OP515896	BEL 4	REC65W-46241-00						REC57-880566Q14
	OP515897 - OP580772	BEL 4	REC65W-46241-00						REC57-880566Q14
60 EFI	OT409000 - 1B355222	USA 4	REC65W-46241-00						REC57-880566Q14
	1C000001 - 1C050251	USA 4	REC65W-46241-00						REC57-880566Q14
	1C050252 - 1C453839	USA 4	REC65W-46241-00						REC57-880566Q14
60 EFI Et SEAPRO	1C453840 +	USA 4	REC65W-46241-00						REC57-880566Q14
75 EFI	1B172291 - 1B366822	USA 4	REC67F-46241-00						REC57-880566Q14
	1B366823 - 2B094995	USA 4		REC57-897574Q01					REC57-880566Q14
75 EFI Et SEAPRO	2B095049 +	4							REC57-880566Q14
	OP459572 - 2B094995	BEL 4		REC57-897574Q01					REC57-880566Q14
80 EFI	1B227000 - 1B366822	USA 4	REC67F-46241-00						REC57-880566Q14
	1B366823 - 2B094995	USA 4		REC57-897574Q01					REC57-880566Q14
	2B095049 +	4		REC57-897574Q01					REC57-880566Q14
	1B172291 - 1B366822	USA 4	REC67F-46241-00						REC57-880566Q14
	1B366823 - 2B094995	USA 4		REC57-897574Q01					REC57-880566Q14
90 EFI	2B095049 +	USA 4							REC57-880566Q14
90 EFI Et SEAPRO	2B095049 +	USA 4							REC57-880566Q14
	OP459572 - 2B094995	BEL 4		REC57-897574Q01					REC57-880566Q14
	1B227000 - 1B366822	USA 4	REC67F-46241-00						REC57-880566Q14
	1B366823 - 2B094995	USA 4		REC57-897574Q01					REC57-880566Q14
	2B095049 +	USA 4							REC57-880566Q14
100 EFI	OT178500 - OT800999	USA 4	REC67F-46241-00						REC57-880566Q14
	OT801000 - 1B226999	USA 4	REC67F-46241-00						REC57-880566Q14
	1B227000 - 1B366822	USA 4	REC67F-46241-00						REC57-880566Q14
	1B366823 - 2B094995	USA 4		REC57-897574Q01					REC57-880566Q14
115 EFI	2B095049 +	4							REC57-880566Q14
115 EFI Et SEAPRO (XS)	2B095049 +	4							REC57-880566Q14
135	2B131942 +	4		REC57-8M0031641					REC57-880566Q14
	OP419487 - OP464487	BEL 4		REC57-880566Q14					REC57-880566Q14
	OP464488 - OP514868	BEL 4		REC57-880566Q14					REC57-880566Q14
135 VERADO	OP514869 - OP593020	BEL 4		REC57-880566Q14					REC57-880566Q14
	1B227000 - 1B381711	USA 4		REC57-880566Q14					REC57-880566Q14
	1B381712 - 1B517158	USA 4		REC57-880566Q14					REC57-880566Q14
	1B517159 - 2B576734	USA 4		REC57-880566Q14					REC57-880566Q14
150	1B905505 +	4		REC57-8M0031641					REC57-880566Q14
150 SEAPRO	2B139139 +	4		REC57-8M0031641					REC57-880566Q14
150 Pro XS	2B550139 +	4		REC57-8M0031641					REC57-880566Q14
	OP419487 - OP464487	BEL 4		REC57-880566Q14					REC57-880566Q14
	OP464488 - OP514868	BEL 4		REC57-880566Q14					REC57-880566Q14
150 VERADO	OP514869 - OP593020	BEL 4		REC57-880566Q14					REC57-880566Q14
	1B227000 - 1B381711	USA 4		REC57-880566Q14					REC57-880566Q14
	1B381712 - 1B517158	USA 4		REC57-880566Q14					REC57-880566Q14
	1B517159 - 2B576734	USA 4		REC57-880566Q14					REC57-880566Q14

SISTEMA DE ESCAPE Y ADMISIÓN EXHAUST & INTAKE SYSTEM

SISTEMA DI SCARICO E ASPIRAZIONE SYSTEME D'ECHAPPEMENT ET D'ADMISSION

SISTEMA DE ESCAPE

EXHAUST SYSTEM

SISTEMA SCARICO

SYSTÈME D'ECHAPPEMENT

4T
STROKES

JUNTAS ESCAPE

GASKETS, EXHAUST

GUARNIZIONE SCARICO

JOINT D'ECHAPPEMENT

REF	OEM	
REC892320	27-892320	25-60 HP (Carb & EFI)



REF	OEM	
REC27-889618001	27-889618001	VERADO 6 CYL

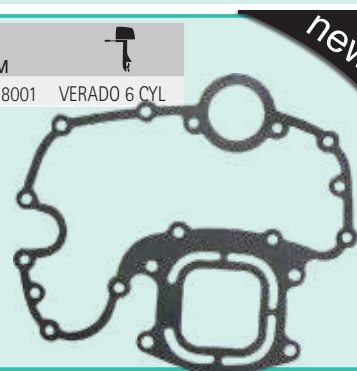

new

REF	OEM	
REC27-895822	27-895822	VERADO 4 CYL



new

REF	OEM	
REC27-889561	27-889561	VERADO 4 & 6 CYL
REC26-880629	26-880629	



REC27-889561



REC26-880629

new

2T
STROKES

JUNTAS ESCAPE

GASKETS, EXHAUST

GUARNIZIONE SCARICO

JOINT D'ECHAPPEMENT

REF	OEM	
REC6G1-41133-A0	27-11568M	6C/D 8C



REF	OEM	
REC414991	27-414991	15 Sea Pro 18, 18XD 20, 20XD 25 XD, Sea Pro (1977-06)





REF	OEM	
REC682-41133-A0	27-83955M	9.9C 15C/K W15

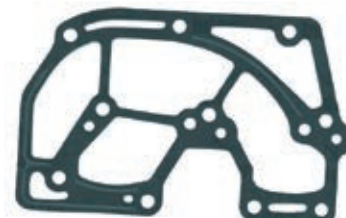

REF	OEM	
REC414758	27-41475-8	15 Sea Pro / Marathon 18, 20 XD 25, Marathon. Sea Pro, Xd, Xs Super 15 (1977-04)





REF	OEM	
REC27-433374	27-43337-4	15 Sea Pro / Marathon 18 HP 20 (2 cyl) Jet 25 Sea Pro / Marathon



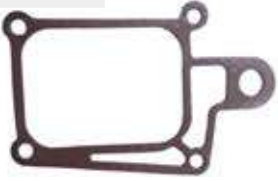

REF	OEM	
REC676-41133-A0	27-83383M	40, A, B, C (Twin Carb) K40, W40



REF	OEM	
REC327674	27-327674	20, 25, 25C, 30, 35 HP



REF	OEM	
REC676-45128-00	83386M	40, A, B, C (Twin Carb)





REF	OEM	
REC664-41134-A0	27-826991M	25K





REF	OEM	
REC676-45127-00	83384M	40, A, B, C (Twin Carb) K40, W40



REF	OEM	
REC27-385011	27-38501-1	30 Jet 35 40, 45 (4cyl) 50, 60 (3cyl) (1970-97)





REF	OEM	
REC688-45123-00	27-81440M	48 / W-48 55 60 (2 cyl)



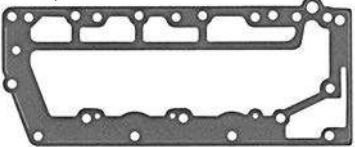

REF	OEM	
REC27-854924	27-85492-2	30 Jet 40-45 Hp (2 cyl) (1980-97)



REF	OEM	
REC663-45123-00	27-81440M	48, 55 W-48, W-55 60 (2 cyl)



REF	OEM	
REC27-66847	27-66847	35-40 HP (2 cyl) (1972-89)



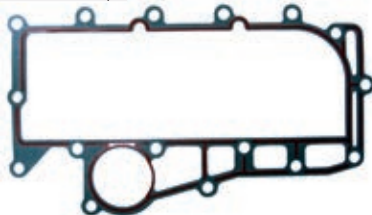

REF	OEM	
REC27-695242	27-69524-2	50-60 HP (3 cyl)

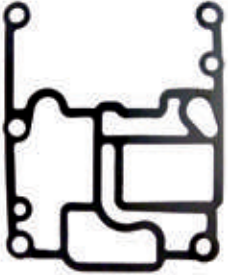

REF	OEM	
REC826738	27-826738	40 - 50HP (1995-97)



REF	OEM	
REC27-703351	27-70335-1	50-70 HP(3cyl) (1973-90)



REF	OEM	
REC27-695252	27-69525-2	50-70 HP(3 cyl) (1973-90)

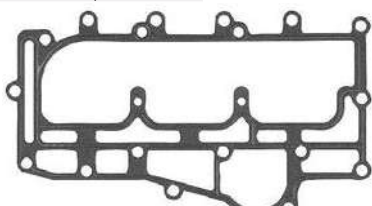

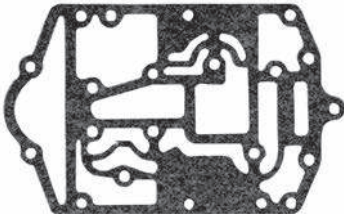

REF	OEM	
REC27-430086	27-43008	65, 80 Jet 75, 90 (3 cyl) 100, 115, 125 (4 cyl) 75, 90, 115 DFI (3cyl) 1.5L (1987-10)



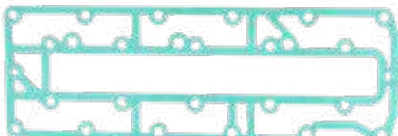

REF	OEM	
REC27-43004009	27-43004-1	65-90 HP (3 cyl) (1987-10)





REF	OEM	
REC27-8127755	27-812775-5	80 Jet 100-125 (4 cyl) (1994-98)





REF	OEM	
REC27-139581	27-13958-1	80 Jet 100-125 HP (4 cyl) (1988-06)





REF	OEM	
REC27-812775A01	27-812775-4	80 Jet 100-125 (4 cyl) (1994-98)



REF	OEM	
REC27-692381	27-69238-1	90-115 HP (6 cyl) (1980-88)



REF	OEM	
REC27-856730	27-85653-1	90-115 HP (6 cyl) (1973-88)



REF	OEM	
REC27-991734	27-99173-2	115-200 HP (V-Models) XR-4, XR-6 105-140 Jet 150-175 Prox5 (1976-10)

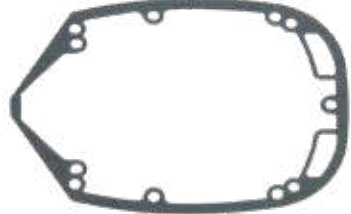

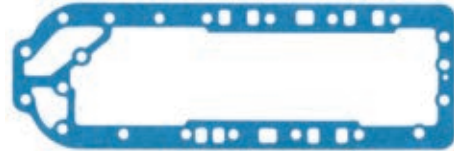

REF	OEM	
REC27-904841	27-90484-1	135-225 (V-Models) XR-4 (1976-90)



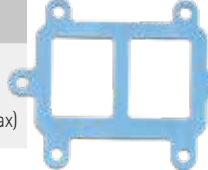

REF	OEM	
REC27-782461	27-78246	135-225 HP (V-Models) XR-4 / XR-6 105-140 HP Jet 150-225 HP (Pro Xs, Pro max) (1978-10)





REF	OEM	
REC27-78409	27-78409	200, 20 (1978-80)



REF	OEM	
REC27-78411	27-78411	200/20 HP (1978-80)





REF	OEM	
REC27-39402	27-39402	200-20 HP (1970-80)

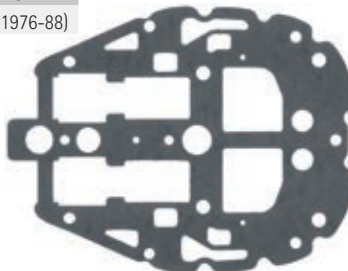

REF	OEM	
REC27-75786	27-75786	V-175 (1976-88)



REF	OEM	
REC27-48801	27-48801	1150, 1250, 1350 80, 650, 800 (4cyl) (1970-72)



4T
STROKES

JUNTAS COLECTOR
ESCAPE

GASKETS, MANIFOLD

GUARNIZIONE COLLETORE
SCARICO

JOINT COLLECTEUR
ECHAPPEMENT

REF	OEM	
REC69J-41134-A0	27-888658	225 EFI V6 (OT653945+)

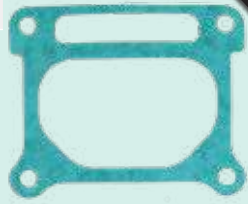

new

REF	OEM	
REC69J-41138-00	26-888660	225 EFI V6 (OT653945+)



new

2T
STROKES

JUNTAS COLECTOR
ESCAPE

GASKETS, MANIFOLD

GUARNIZIONE COLLETORE
SCARICO

JOINT COLLECTEUR
ECHAPPEMENT

REF	OEM	
REC646-14623-A1	27-43004-1	2B, A

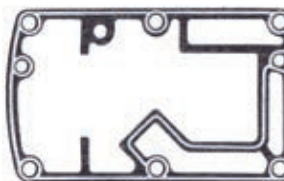

REF	OEM	
REC682-45113-A0	27-96618	9.9C, 15C 15K W15



REF	OEM	
REC676-45114-A1	27-19175	K 40HP W40 40/40C Twin Carb



REF	OEM	
REC697-45114-00	7-98952M	55, W-55 W-40



4T
STROKES

JUNTAS CARTER

GASKETS, OIL PAN

GUARNIZIONE CARTER

JOINT DE CARTER D'HUILE

REF	OEM	
REC27-889617001	889617001	VERADO 6 CYL

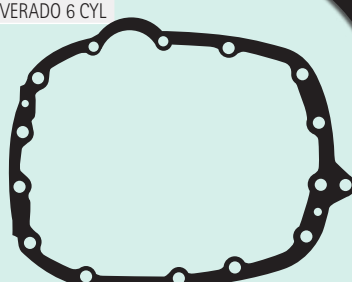

new

SISTEMA DE ADMISIÓN INTAKE SYSTEM

SISTEMA ASPIRAZIONE SYSTEME D'ADMISSION



4T
STROKES



JUNTAS ADMISIÓN

GASKETS, INTAKE



ASPIRAZIONE



JOINT D'ADMISSION



REF	OEM		
PAGB/T3452.1-35.5x1.	25-825057003	2.5 / 3.5 HP 8 HP (209cc) 9.9 HP (209cc)	



REF	OEM		
PAGB3452.1-82	25-8250572	8-60 HP	



REF	OEM		
PAF15-07000017	27-835383001	8 & 9.9 HP (209cc)	

REF	OEM		
PAF15-07000007	25-853525	8 HP Bodensee 9.9 HP (323cc) 13.5 HP (Int.) 15 HP	

REF	OEM		
PAF8-05000009	27-853525001	8 & 9.9 HP (209cc)	

REF	OEM		
PAF25-05060002	855219	25 HP	

REF	OEM		
PAF25-05080004	855837	25 HP	

REF	OEM		
PAF25-05060003	878431	25 HP	



2T
STROKES



JUNTAS ADMISIÓN



GASKETS, INTAKE

ASPIRAZIONE



JOINT D'ADMISSION

REF	OEM		
REC27-31402	27-31402	10-95 HP (1970-75)	

REF	OEM		
REC1399-99	1399-99	10-95 HP	

REF	OEM		
REC414172	27-41417-2	15-25 HP (1977-06)	

REF	OEM		
REC414181	27-41418-1	15-25 HP (1977-06)	

REF	OEM		
REC27-757911	27-75791	20-80 HP (1976-97)	

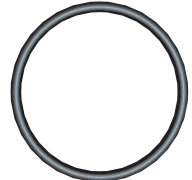
REF	OEM		
PAF25-05000011	25-33466	25-220 HP	

REF	OEM	
REC27-279361	27-27936-1	30 Jet 40, 45 (4 cyl) (1970-97)





REF	OEM	
REC27-987691	27-98769-1	30-250 HP (1976-10)

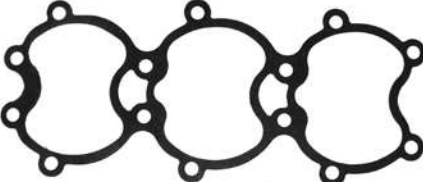

REF	OEM	
REC27-812868	27-812868	30, 40, 45 Jet 40, 50, 55, 60 (3 cyl)





REF	OEM	
REC27-812869	27-812869	30-60 HP (1991-10)

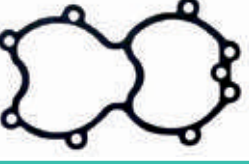

REF	OEM	
REC27-821370	27-812370	30-40 HP (2 cyl)





REF	OEM	
REC27-481641	27-48164-1	35 - 150HP (1970-89)



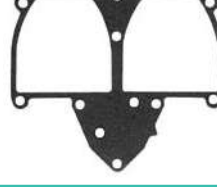

REF	OEM	
REC27-552791	27-55279-1	35 - 40HP (1970-89)



REF	OEM	
REC27-733771	27-733771	50-60 Hp (3 cyl)





REF	OEM	
REC27-151724	27-15172-3	65, 80 Jet 75, 90 (3 cyl) 100, 115, 125 (4 cyl) (1988-98)



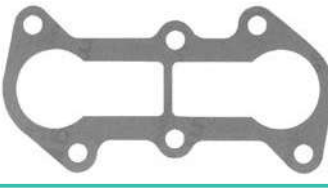

REF	OEM	
REC27-134612	27-134612	65/85 Jet 75-90 HP (3 cyl) 100-125 HP (4 cyl) (1988-10)





REF	OEM	
REC27-139376	27-13937-6	65-125 HP (1988-10)





REF	OEM	
REC27-76952	27-76952	70-85 HP (1976-86)



REF	OEM	
REC819113	27-819113	70-75 HP (1991-98)





REF	OEM	
REC819114	27-819114	70-75 HP (1991-98)



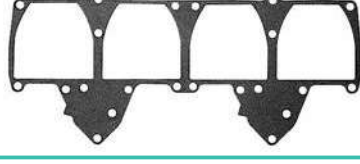

REF	OEM	
REC27-62107	27-62107	80-85 HP (1970-75)



REF	OEM	
REC27-892211	27-89221-1	100-225 HP (1978-05)





REF	OEM	
REC27-677511	27-67751-1	V6 100-225 HP (1976-98)

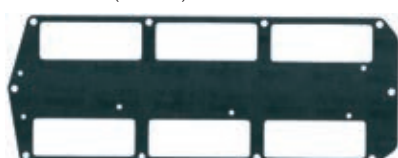

REF	OEM	
REC27-935361	27-93536-1	V6 135-200 HP (1976-90)





REF	OEM	
REC847525	27-847525-1	150-300 HP (1990-05)





REF	OEM	
REC27-78690002	27-78690	V6 110-200 HP (2000-10)





REF	OEM	
REC27-657443	27-65744-2	175-250 HP (1976-94)





REF	OEM	
REC27-883775	27-813859	135-240 HP (1990-00)





REF	OEM	
REC27-8141951	27-814195-1	200-250 HP (1994-02)





REF	OEM	
REC27-904301	27-90430-1	135-200 HP (1976-90)





REF	OEM	
REC27-877361	27-87736-1	V-200





REF	OEM	
REC856542	27-856542-1	135-225 HP (1998-99) V 135-150 HP 200-225 (DFI)





REF	OEM	
REC27-967611	27-96761-1	V-200 (1978-90)





REF	OEM	
REC27-672751	27-67275-1	135-200 HP V-Models (1976-90)





REF	OEM	
REC27-850283	27-850283	200-225 DFI (1998-99)



REF	OEM	
REC27-76636	27-76636	V6 150-200 HP (1976-88)



REF	OEM	
REC27-993163	27-993163	280-300 HP Racing (1991-05)



UNIDADES DE TRANSMISIÓN UNIT DRIVES & COMPONENTS

UNITÀ DI TRASMISSIONE EMBASES ET PIECES

COLA COMPLETA COMPLETE GEARCASE ASSY PIEDI COMPLETI EMBASE COMPLETE

COLAS COMPLETAS COMPLETE GEARCASE ASSEMBLY PIEDI COMPLETI EMBASES COMPLÈTES

REF	OEM	REDUCCIÓN GEAR RATIO RIDUZIONE REDUCTION	4T STROKES	2T STROKES
REC1647-9148T84	1647-9148T84	20" RH 15 1.87:1		
REC1647-9148T85	1647-9148T85	25" RH 15 1.87:1	2.0 / 2.4 / 2.5 L V6 V115 - V-200 (DFI)	✓
REC1647-9148T81	1647-9148T81	20" RH 14 2:1	XR-6	
REC1647-9148T82	1647-9148T82	25" RH 14 2:1	110, 140 JET (2.5L)	



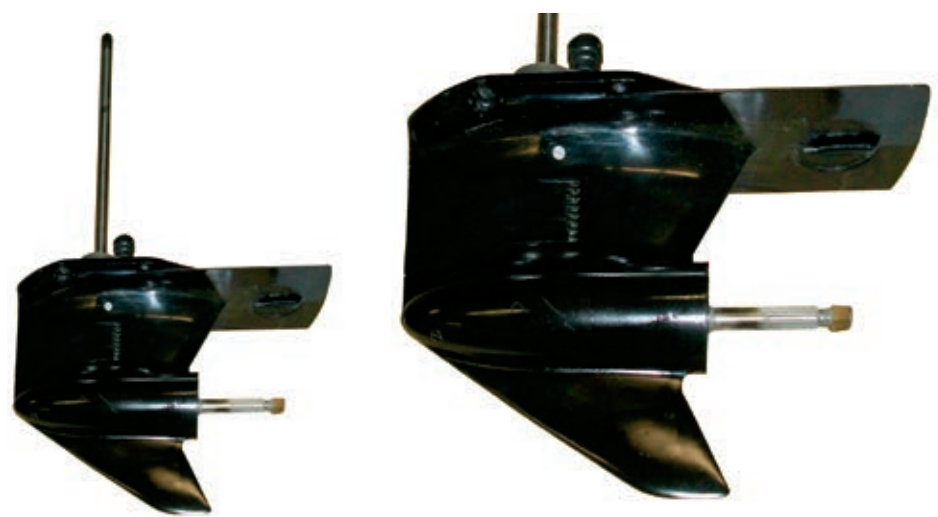

REF	OEM	REDUCCIÓN GEAR RATIO RIDUZIONE REDUCTION	4T STROKES	2T STROKES
REC1623-859399T13	1623-859399T13	20" RH 12 1.75:1	13	3.0L
REC1623-859399T14	1623-859399T14	25" RH 12 1.75:1	13	200 - 250 HP
REC1623-822442A19	1623-822442A19	20" RH 1.64:1	8	3.0 (EFI, DFI) OPTIMAX (1B504988-)
REC1623-822442A20	1623-822442A20	25" RH 1.64:1	8	





MERCURY



RECAMBIOS MARINOS

REF	OEM		REDUCCIÓN GEAR RATIO RIDUZIONE REDUCTION			4T STROKES	2T STROKES
REC1667-9011R6	1667-901167, 78	20"	14	2.07:1	6		✓
	1667-901110, 11						
	1667-9011G51						
	1667-9011J6						
	1667-9011R6					✓	

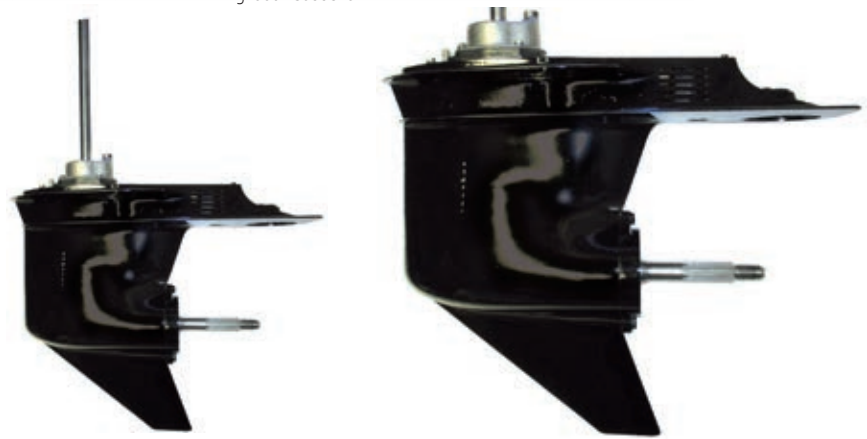

REF	OEM		REDUCCIÓN GEAR RATIO RIDUZIONE REDUCTION			4T STROKES	2T STROKES
REC1667-9011G90	1667-9011G90	20"	12	2.33:1	4.25" 107.95 mm		✓
	1667-9011G70						
	40 HP (4 cyl) OP094500 - OP206999						
	40 EFI (4 cyl) OP153500 - OP515896						
	50 HP (4 cyl) OP094500 - OP206999						
	50 EFI (4 cyl) OP153500 - OP515896						
	60 HP (4 cyl) OP094500 - OP206999						
	60 EFI (4 cyl) OP153500 - OP515896						
	BigFoot 1C033810-						



REF	OEM		REDUCCIÓN GEAR RATIO RIDUZIONE REDUCTION			4T STROKES	2T STROKES
REC1667-9011J41	1667-9011J41	25"	2.33:1	4.25" 107.95 mm		✓	
	40 EFI (4 cyl) OP216185+						
	50 EFI (4 cyl) OP216185+						
	60 EFI (4 cyl) OP216185+						
	BigFoot						

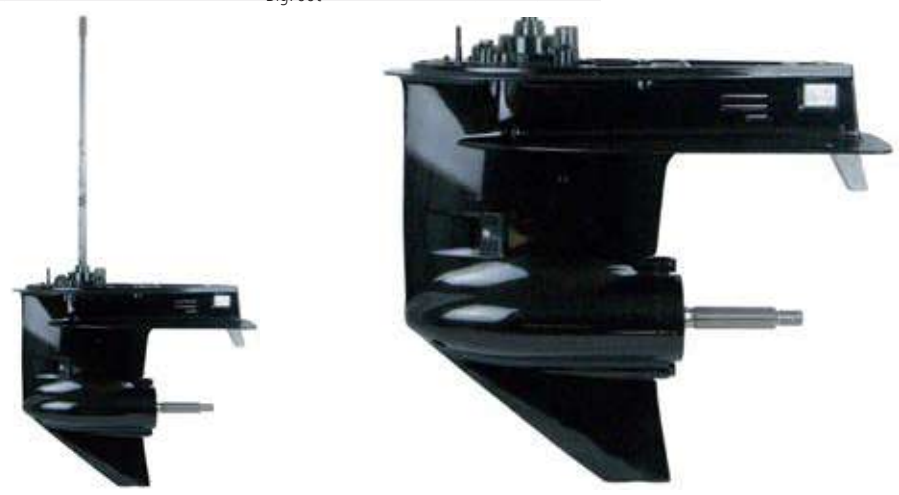

REF	OEM		REDUCCIÓN GEAR RATIO RIDUZIONE REDUCTION	4T 2T STROKESSTROKES
REC421-B25F	1623-888680T06	25° V6 76°	RH 2.0:1	✓
REC421-B30F	1623-888680T07	30° V6 76°	RH 2.0:1	225 EFI ✓ (0T653945+)
REC428-B25F	1623-888680T08	25° V6 90°	CCW 2.0:1	✓
REC428-B30F	1623-888680T09	30° V6	CCW 2.0:1	✓

HERRAMIENTAS TOOLS ATTREZZI OUTILS

EXTRACTOR COJINETES Y HÉLICES PROP AND BEARING PULLER ESTRATTORE CUSCINETTI E ELICHE EXTRACTEUR DE ROUEMENTS D'HELICE

Extractor de cojinetes y hélices, con patas. Para todos los cojinetes Mercruiser y la mayoría de las hélices.

Prop and bearing carrier puller. Capacity: 5 Tons (Min). For Mercruiser All Style Bearing Carrier and Most Props.

Estrattore cuscinetti e eliche. Per tutti i cuscinetti Mercruiser e la maggior parte delle eliche.

Extracteur de roulement et d'hélice. Pour tous les roulements Mercruiser et la plupart des hélices.

REF
REC90095
RECMAR



Para hélices y cojinetes antiguos. For prop and old style bearing carrier. Per eliche e cuscinetti vecchi. Pour hélices et roulements anciens



Para cojinetes modernos. For new style bearing carrier. Per cuscinetti moderni. Pour roulements récents.



EXTRACTOR COJINETES BEARING PULLER ESTRATTORE CUSCINETTI EXTRACTEUR DE ROUEMENTS

REF	OEM
REC91-34569A1	91-34569A1



RECMAR

REF	OEM
REC91-36569T	91-36569T

RECMAR



Para utilizar con las herramientas REC91-43579 y REC91-36569T para instalar y desmontar el cojinete

Used with REC91-43579 & REC91-36569T tools to install & remove pinion bearing.

Da utilizzare con gli strumenti REC91-43579 e REC91-36569T per installare e smontare il cuscinetto.

A utiliser avec les outils REC91-43579 et REC91-36569T pour installer et retirer le roulement

REF	OEM
REC91-31229	91-31229



RECMAR

EXTRACTOR PIÑONES Y COJINETES

UNIVERSAL PULLER PLATE

ESTRATTORE PIGNONE E CUSCINETTI

EXTRACTEUR PIGNONS ET ROUEMENTS

REF	PIÑONES BEARINGS PIGNONE PIGNONS
REC91-00001	30-50 mm / 1 ^{1/4} " - 2 ^{1/4} "
REC91-00002	50-75 mm / 2 ^{1/4} " - 3 ^{1/2} "
REC91-37241	75-105 mm / 3" - 4 ^{1/2} "



KIT HERRAMIENTAS PARA COLAS

GEAR CASE TOOL KIT

KIT ATTREZZI PIEDI

KIT OUTILS POUR EMBASES

Kit de montaje y desmontaje de los retenes y cojinetes de las colas Alpha, Alpha Gene II y Bravo.

Removes and installs bearings in MC-I, R-MR, Alpha One, Alpha One Gen Two and Bravo.

Kit di montaggio e smontaggio delle guarnizioni di tenuta e dei cuscinetti del piede.

Kit de montage et démontage des joints spi et roulements des embases ALPHA ONE GEN I et II et BRAVO

REF	OEM
RM91-31229A7	91-31229A7

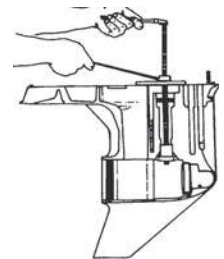

KIT LLAVE HÉLICE

PROP WRENCH KIT

KIT CHIAVE ELICHA

CLE POUR ECROU D'HELICE

REF	R.O. OEM		
REC91-859046Q4	91-821887T1	1 1/16"	75 - 300 HP



new

REF	R.O. OEM		
REC91-859046Q3	91-859046Q3	15/16"	30, 40, 50 Et 60 HP



LLAVE CABLE CAMBIO

SHIFT CABLE TOOL

CHIAVE PER CAVO CAMBIO

CLE POUR CÂBLE

Para montaje y desmontaje de los cables de cambio en las colas MC-I, R-MR, Alpha One, Gene II.

Installs and removes drive shaft bearing retainer on MC-1, R-MR, Blackhawk, all Bravo, and all Alpha drive units.

Per il montaggio e lo smontaggio dei cavi di innesto nel piede MC-I, R-MR, Alpha One, Gen II.

Pour le montage et le démontage des câbles d'engrenage sur les embases MC-I, R-MR, Alpha One, Gene II.

REF	R.O. OEM
REC91-12037	91-12037



LLAVE TUERCA VARILLA CAMBIO

SHIFT SHAFT BUSHING TOOL

CHIAVE DADO LEVA CAMBIO

CLE POUR ARBRE DE SELECTION

Para montaje y desmontaje de las tuercas de la varilla cambio en las colas MC-I, R-MR, Alpha One.

Removes and installs the shift shaft bushing in the gear case of MC-I, R-MR, and Alpha One, drive units.

Per il montaggio e lo smontaggio dei dadi sull'asta cambiare nel piede MC-1, R-MR, Alpha One.

Pour le montage et le démontage des écrous de tige de sélection sur les embases MC-I, R-MR, Alpha One

REF	R.O. OEM
REC91-31107T	91-31107T



LLAVE TUERCA EJE VERTICAL

Para montaje y desmontaje del retenedor de cojinete superior en colas.

PINION NUT ADAPTOR KIT

Removes and installs threaded bearing retainer on stern drives.

CHIAVE DADO ASSE VERTICALE

Per il montaggio e lo smontaggio del fermo di ritengo e del cuscinetto superiore dei piedi.

CLE POUR ARBRE VERTICAL

Pour le montage et le démontage de la retenue et du palier supérieur dans les embases

REF	R.O. OEM
REC91-43506T	91-43506T



Incluye un adaptador eje. Sostiene la tuerca del piñón cuando se está sacando el piñón y el eje en las colas MC-I, R-MR, Alpha One.

Holds pinion nut when removing pinion gear and drive shaft on MC-I, R-MR, and Alpha One drive units. Comes with drive shaft adaptor.

Incluye un adattatore albero. Tenendo il dado del pignone quando si rimuove la ruota dentata e l'albero nel piede.

Inclus un adaptateur d'arbre. Maintient l'écrou de pignon lors de la dépose du pignon et de l'axe sur les embases MC-I, R-MR, Alpha One.

REF	R.O. OEM
REC91-61067A04	91-61067A04



LLAVE ESTRIDADO EJE

Da una superficie de llave para girar el eje de la hélice en las colas MC-I, R-MR, TRS, Alpha One y Gene II.

PROP SHAFT ADAPTOR

Provides a wrench surface to turn the propeller shaft on MC-I; R-MR; Alpha One; Alpha One, Gen Two; and TRS drive units.

CHIAVE ASSE STRIATO

Fornisce una superficie di chiave per ruotare l'asse del propulsore nel piede MCI, R-MR, TRS, Alpha One e Gen II.

CLE POUR ARBRE D'HELICE

Fournit une surface de clé pour faire tourner l'arbre d'hélice sur les embases MC-I, R-MR, TRS, Alpha One et Gene II.

REF	R.O. OEM
REC91-56775T	91-56775T
REC91-61077T	91-61077T



REC91-61077T



REC91-56775T

LLAVE TUERCA DIÁBOLO

Instala y desinstala las tuercas del diábolo en las colas MC-I, R-MR, TRS, Alpha One y Gene II y Bravo I y II

BEARING CARRIER RETAINER WRENCH

Removes and installs bearing carrier retainer nuts on Bravo One and Two; MC-I; R-MR; and Alpha One, Gen. Two; and TRS; drive units.

CHIAVE PER CUSCINETTO

Installa e Disinstalla i dadi di fissaggio dell'asse nel piede MC-I, R-MR, TRS, Alpha One, Gen II, Bravo I, III.

CLE POUR ECROU DE DIABOLO

Installez et désinstallez les écrous diabolos sur les embases MC-I, R-MR, TRS, Alpha One et Gene II et Bravo I et II

REF	R.O. OEM
REC91-61069T	91-61069T

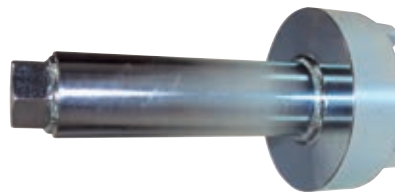

LLAVE GALGADO PIÑONES

Mide la altura del piñón en las colas MC-I, R-MR, Alpha One y Gene II

PINION GEAR SHIMMING TOOL

Measures pinion height of MC-I; R-MR; Alpha One; and Alpha One, Gen Two drive units.

CHIAVE PER PIGNONI

Misurare l'altezza del pignone nel piede MC-I, R-MR, Alpha One e Gen II.

CLE POUR PIGNONS

Mesure la hauteur du pignon sur les queues MC-I, R-MR, Alpha One et Gene II

REF	R.O. OEM
REC91-56048001	91-56048001
REC91-60523	91-60523
REC91-60526T	91-60526T



REC91-56048001



REC91-60526T



REC91-60523

VACUÓMETRO DOBLE FUNCIÓN

Presión y vacío. Ideal para comprobar las colas.

PRESSURE / VACUUM TESTER

Combination unit that does pressure and vacuum testing in one units. Recommended to test drives.

VACUOMETRO DOPPIA FUNZIONE

Pressione e sottovuoto. Ideale per il controllo dei piedi.

VACUOMETRE DOUBLE FONCTION

Unité combinée qui effectue des tests de pression et de vide. Recommandé pour tester les embases.

REF
REC55134
RECMAR



PISTOLA DE ACEITE

Pistola para acoplar en los envases de botella de 1 L LUB11552 y LUB11564. Se suministra con kit de adaptación con válvula anti-retorno.

BOTTLE GREASE PUMP

Lower unit quart pump. Complete with metal threaded filler fitting.

PISTOLA OLIO

Pistola da accoppiare a bottiglie da 1 L LUB11552 e LUB11564. Si vende con kit di accoppiamento con valvola anti-ritorno.

PISTOLET POUR HUILE D'EMBASE

Pistolet pour les bidons d'huile de 1 L LUB11552 et LUB11564. Vendu avec kit de couplage avec clapet anti-retour.

REF OEM
REC55005 91-8M0072133
RECMAR



HERRAMIENTAS VOLANTE MOTOR

FLYWHEEL PULLER

ESTRATTORE VOLANO

EXTRACTEUR DE VOLANT

REF	R.O. OEM	2T STROKES	4T STROKES
REC90890-06820	90890-06820 91-83164M	40, 45, 50, 60HP (4 CYL) 75, 90, 115 (-1B366822)	✓

REF	R.O. OEM	2T STROKES	4T STROKES
REC91-895343T02	91-895343T02 91-895343T01	75-115HP (1B366823+) VERADO 135 - 300HP 150EFI	✓

new



	R.O. OEM				
1	91-904551	Adaptador universal de elevación para motores	Universal lift adapter for motors	Adattatore di sollevamento universale per motori	Adaptateur de levage universel pour moteurs 1.5"
2	91-849154T1	Extractor de volante	Flywheel puller	Estrattore volano	Extracteur de volant
3		Se adapta directamente en volantes Yamaha y Mercury que no contienen anillos de elevación integrados. (Se suministra con tornillos)	Fits directly on Yamaha and Mercury flywheels that do not contain integrated lift rings. (Supplied with screws)	Si adatta direttamente ai volani Yamaha e Mercury che non contengono anelli di sollevamento integrati. (Fornito con viti)	S'adapte directement sur les volants d'inertie Yamaha et Mercury qui ne contiennent pas d'anneaux de levage intégrés. (Fourni avec des vis)
4					

DESPIECE COLAS
4 TIEMPOS

GEAR CASE PARTS
4 STROKES

PARTI PIEDI
DE 4 TEMPI

PIECES D'EMBASES DE 4
TEMPS

4T 2T 2, 2.5, 3.5 HP
STROKES STROKES

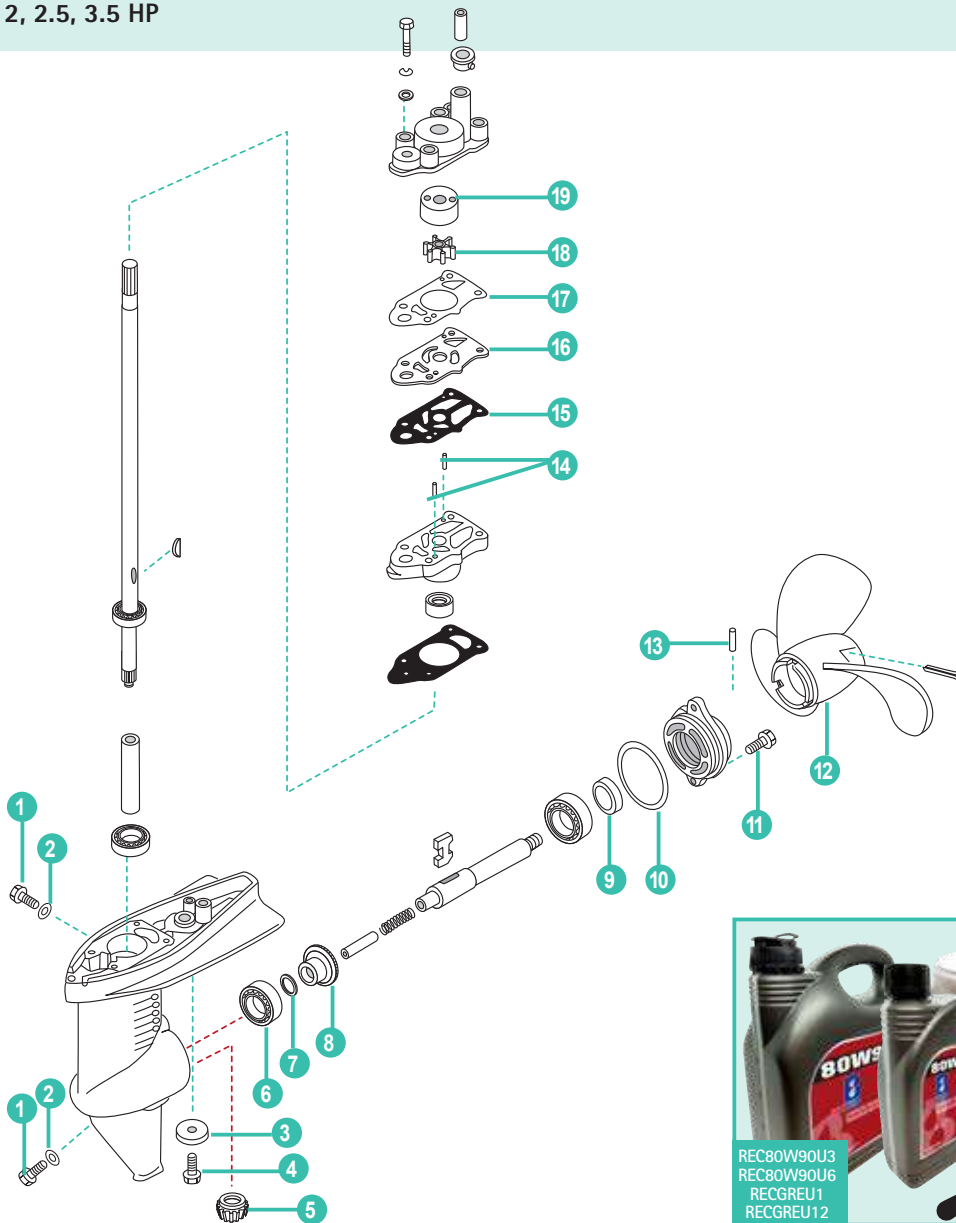

	REF	OEM				
1	REC90340-08002	953683	TAPÓN ACEITE	PLUG STRAIGHT SCREW	TAPPO OLIO	BOUCHON DE VIDANGE
2	REC90430-08020	95220	JUNTA	GASKET	GUARNIZIONE	JOINT
3	TEN00824	823913Q	ÁNODO	ANODO	ANODO	ANODE
4	PAGB/T5783-M6X16	16832	TORNILLO M6X16	BOLT M6X16	VITE M6X16	VIS M6X16
5	REC43-16138	16138	PIÑÓN ATAQUE	INITIATIVE GEAR	MARCIA INIZIATIVA	PIGNON D'ATTAQUE
6	PAGB/T276-6004	16128	COJINETE	BEARING	CUSCINETTO	ROULEMENT
7	PAF8-04000012-1	16141	GRUESO (0.1 mm)	SHIM (0.1 mm)	SPESSORE (0.1 mm)	CALE (0.1 mm)
	PAF8-04000012-2	813277	GRUESO (0.15 mm)	SHIM (0.15 mm)	SPESSORE (0.15 mm)	CALE (0.15 mm)
8	REC43-812944	812944	PIÑÓN MARCHA AVANTE	POSITIVE GEAR	PIGNONE MARCIA AVANTE	PIGNON DE MARCHÉ AVANT
9	PAF8-04000101	95348	RETÉN	SEAL OIL	PARAOILIO	JOINT SPI
10	PAF8-04040002	16131	TÓRICA	O-RING	O-RING	TORIQUE
11	PAGB/T5787-M6X20	167051	TORNILLO M6X20	BOLT M6X20	VITE M6X20	VIS M6X20
12	SOL0001-073-06P	815083A01	HÉLICE 3X7.4X6	PROPELLER 3X7.4X6	ELICA 3X7.4X6	HÉLICE 3X7.4X6
13	REC17-81511Q02	815111	PIN	PIN	SPINOTTO	PIN
14	PAF8-04000021	9521811	PIN	PIN	SPINOTTO	PIN
15	REC3F0-65029-0	898101332	JUNTA	GASKET	GUARNIZIONE	JOINT
16	REC898101371	898101371	PLACA BOMBA AGUA	PLATE WATER PUMP	PIASTRA POMPA	PLAQUE DE POMPE À EAU
17	REC27-898101331	898101331	JUNTA BOMBA AGUA	GASKET WATER PUMP	GUARNIZIONE POMPA ACQUA	JOINT DE POMPE À EAU
18	REC47-161543	161543	IMPULSOR	IMPELLER	GIRANTE	TURBINE
19	REC161571	161571	CASQUILLO	BUSH	GHIERA	BAGUE

4T 2T 4, 5, 6 HP
STROKES STROKES

MERCURY MARINER

RECAMBIOS
MARINOS

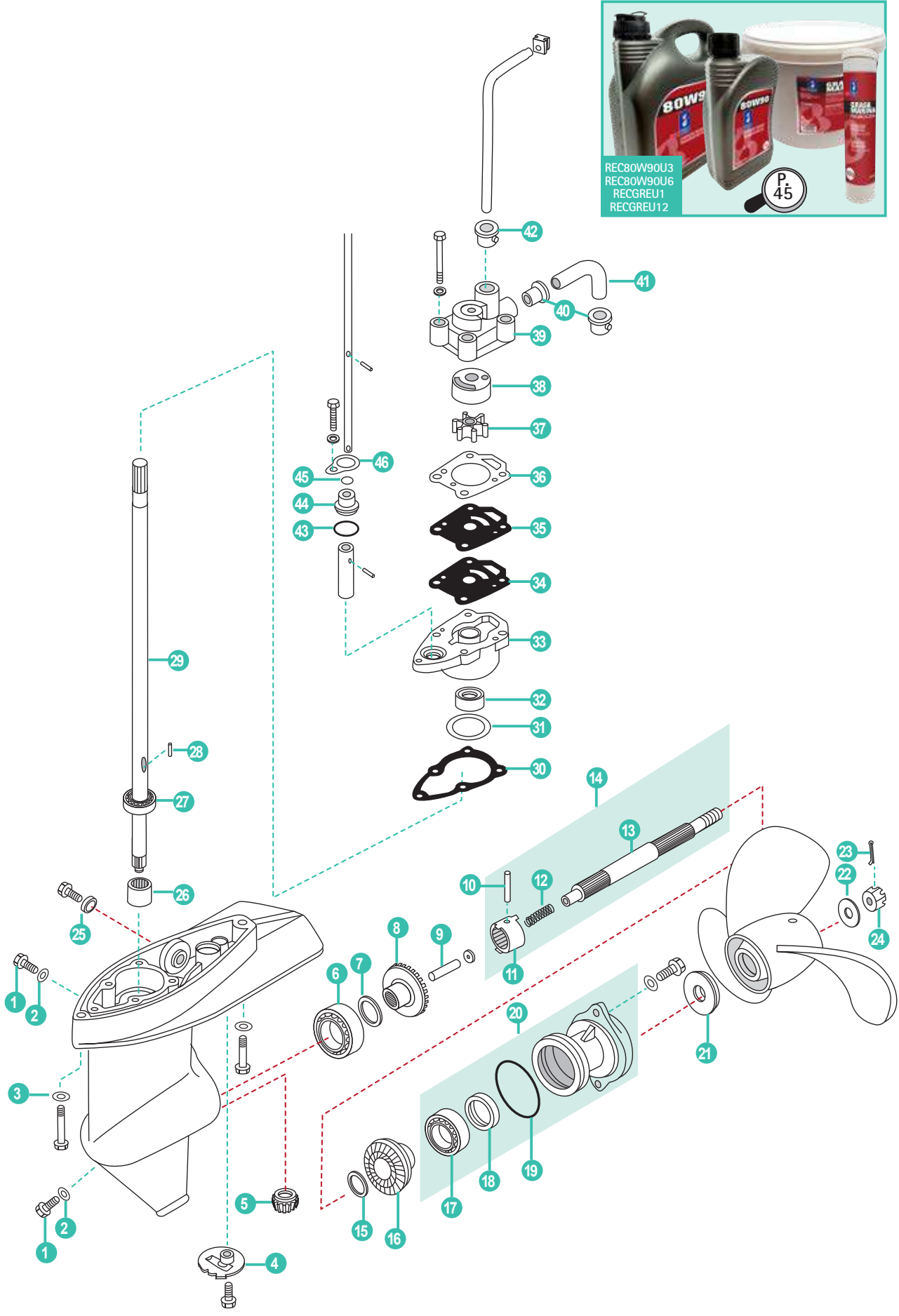

	REF	OEM				
1	REC90340-08002	22-95368 3	TAPÓN ACEITE	PLUG STRAIGHT SCREW	TAPPO OLIO	BOUCHON DE VIDANGE
2	REC90430-08020	27-95220	JUNTA	GASKET	GUARNIZIONE	JOINT
3	PAGB/T97.1-6	12-16826	ARANDELA	WASHER	RONDELLA	RONDELLE
4	PAT5-03000016	16133	ÁNODO	ANODO	ANODO	ANODE
5	REC43-16138	43-16138	PIÑÓN ATAQUE	INITIATIVE GEAR	MARCIA INIZIATIVA	PIGNON D'ATTAQUE
6	PAGB/T276-6004	30-1628	RODAMIENTO	BEARING	CUSCINETTO	ROULEMENT
7	PAF8-04000002-1	15-16141	GRUESO (0.1 mm)	SHIM (0.1 mm)	SPESSORE (0.1 mm)	CALE (0.1 mm)
	PAF8-04000002-2	15-813277	GRUESO (0.15 mm)	SHIM (0.15 mm)	SPESSORE (0.15 mm)	CALE (0.15 mm)
8	REC43-812944	812944	PIÑÓN MARCHA AVANTE	POSITIVE GEAR	PIGNONE MARCIA AVANTE	PIGNON DE MARCHÉ AVANT
9	PAT5-03000404	16152	ÉMBOLO DE CAMBIO	PLUNGER SHIFT	CAMBIO PISTONE	PISTON
10	PAGB/T879.1-3.5X28	17-16150	PIN	PIN	SPINOTTO	PIN
11	PAT5-03000403	52-812946	SELECTOR	CLUTCH, DOG	SELETTORE	CRABOT
12	PAT5-03000402	24-17667	MUELLE	SPRING	MOLLA	RESSORT
13	REC44-195133	19513 3	EJE HÉLICE	SHAFT PROPELLER	ASSE ELICA	ARBRE D'HÉLICE
14	PAT5-03000400	44-195133	KIT EJE DE HÉLICE	SHAFT PROPELLER, KIT	KIT ASSE ELICA	KIT ARBRE D'HÉLICE
15	PAT5-03000015	12-16140	ARANDELA	WASHER	RONDELLA	RONDELLE
16	REC43-8129451	812945 1	PIÑÓN MARCHA ATRÁS	REVERSER GEAR	PIGNONE MARCIA INDIETRO	PIGNON MARCHÉ ARRIÈRE
17	PAGB/T276-6002	30-16132	RODAMIENTO	BEARING	CUSCINETTO	ROULEMENT
18	REC26-16130	16130	RETÉN ACEITE	OIL SEAL	PARAOLIO	JOINT SPI
19	PAJASOF40431-050	25-16131	TÓRICA	O-RING	O-RING	TORIQUE
20	PAT5-03000500	825118T	FUNDA INFERIOR COMPLETA	COVER ASSY LOWER CASING	COPERCHIO CARTER INFERIORE COMPLETA	DIABOLO COMPLET
21	PAT5-03000800	161451	ESPACIADOR	CUSHION ASSY PROPELLER SHAFT	CUSCINO ALBERO TRASMISSIONE COMPLETO	ENTRETOISE D'HELICE
22	PAGB/T96-10	12-16146	ARANDELA	WASHER	RONDELLA	RONDELLE
23	PAGB/T91-3.2X18	18-815026	PASADOR ALETAS	PIN COTTER	COPPIGLIA	GOUPILLE FENDUE
24	REC11-16147Q	16147	TUERCA HÉLICE	PORPELLER NUT	DADO ELICA	ÉCROU D'HÉLICE
25	TEN00823	823912	ÁNODO REDONDO	ROUND ANODE	ANODO TONDO	ANODE RONDE
	CM3H6-60218-000	875208	ÁNODO CUADRADO	SQUARE ANODE	ANODO QUADRATO	ANODE CARRÉE
26	PATLA1412Z	23-16124	RODAMIENTO	BEARING	CUSCINETTO	ROULEMENT
27	REC30-95347	30-95347	RODAMIENTO	BEARING	CUSCINETTO	ROULEMENT
28	PAT5-03000009	28-16155	PIN	PIN	SPINOTTO	PIN
29	REC45-161351	45-16135 1	EJE S	SHAFT S	ASSE S	ARBRE S
	REC45-8M0076368	45-16136 1	EJE L	SHAFT L	ASSE L	ARBRE L
30	PAT5-03000005	27-16164	JUNTA	GASKET	GUARNIZIONE	JOINT
31	PAT5-03000004-1	15-161631	GRUESO (0.1 mm)	SHIM (0.1 mm)	SPESSORE (0.1 mm)	CALE (0.1 mm)
	PAT5-03000004-2	15-8132761	GRUESO (0.15 mm)	SHIM (0.15 mm)	SPESSORE (0.15 mm)	CALE (0.15 mm)
32	REC26-16162	26-16162	RETÉN ACEITE	OIL SEAL	PARAOLIO	JOINT SPI
33	PAT5-03000201	46-826053T	BASE BOMBA AGUA	WATER PUMP SEAT	SEDE POMPA ACQUA	BASE DE POMPE À EAU
34	PAT5-03000006	27-16160	JUNTA PLACA DE LA BOMBA	LOWER GASKET OUTER PLATE	GUARNIZIONE INFERIORE PIASTRA ESTERNA	JOINT DE PLAQUE
35	REC16159	16159	PLACA BOMBA AGUA	PLATE WATER PUMP	PIASTRA POMPA	PLAQUE DE POMPE À EAU
36	PAF6-03000003	27-16158	JUNTA BOMBA AGUA	GASKET WATER PUMP	GUARNIZIONE POMPA ACQUA	JOINT DE POMPE À EAU
37	REC47-161543	47-16154 3	IMPULSOR	IMPELLER	GIRANTE	TURBINE
38	PAF6-03000002	16157	CASQUILLO	BUSH	GHIERA	BAGUE
39	PAF6-03000001	46-16156	CUERPO BOMBA DE AGUA	WATER PUMP, HOUSING	CORPO POMPA ACQUA	CORPS DE POMPE D'EAU
40	PAT5-03000013	26-16168	CASQUILLO DE GOMA	DAMPER, WATER PUMP	GHIERA GOMA	BAGUE
41	PAT5-03000012	32-16167	TUBO	TUBE	TUBO	DURITE
42	PAT5-03000014	26-16171	CASQUILLO DE GOMA	DAMPER, WATER PUMP	GHIERA GOMA	BAGUE
43	PAJISB2401P16	25-16178	TÓRICA	O-RING	O-RING	TORIQUE
44	PAT5-03000020	23-16176	CASQUILLO EJE DE CAMBIO	ORIENTED BUSHING SHIFT ROD	BOCCOLA ASTA CAMBIO	BAGUE DE TIGE DE CHANGEMENT
45	PAT5-03000022	25-161771	TÓRICA	O-RING	O-RING	JOINT TORIQUE
46	PAT5-03000023	16165	PLACA BUJE	PLATE ORIENTED BUSHING	PIASTRA BOCCOLA	PLAQUE

4T 8, 9.9 HP (209CC)
STROKES

2T 6, 8 (2CYL) INTERN.
STROKES 8, 9.8 SEAPRO (2 CYL) INTERN.

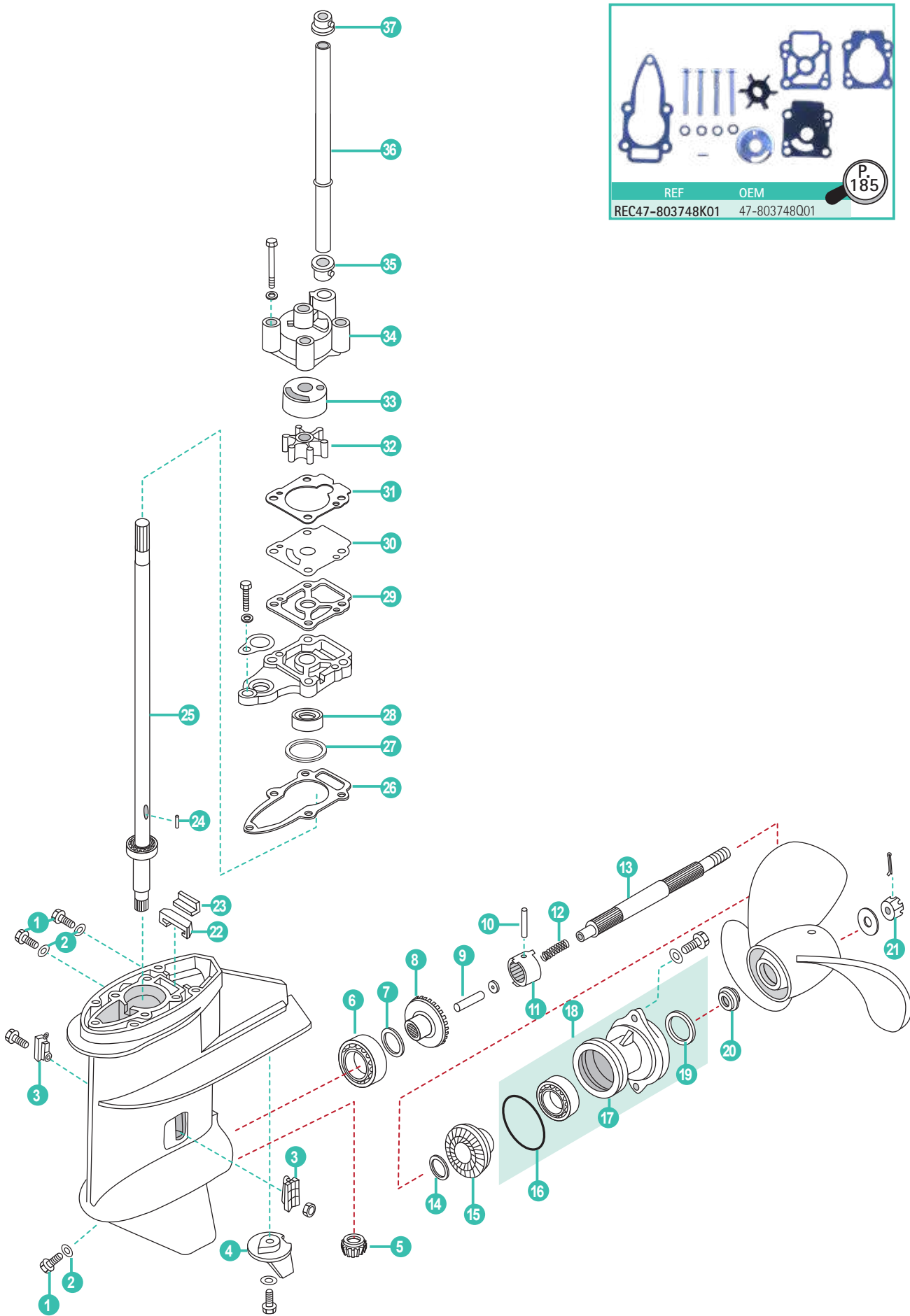

	REF	OEM				
1	REC90340-08002	95368 3	TAPÓN ACEITE	PLUG STRAIGHT SCREW	TAPPO OLIO	BOUCHON DE VIDANGE
2	REC90430-08020	95220	JUNTA	GASKET	GUARNIZIONE	JOINT
3	PAF8-04000017	803730001	FILTRO ENTRADA	WATER INLET	COPERCHIO ACQUA	ENTREE D'EAU
4	CM3V1-60217-0	853762T01	ÁNODO	ANODO	ANODO	ANODE
5	PAF8-04000003	803740 1	PIÑÓN ATAQUE	INITIATIVE GEAR	MARCIA INIZIATIVA	PIGNON D'ATTAQUE
6	PAGB/T276-6204	30-8037331	RODAMIENTO	BEARING	CUSCINETTO	ROULEMENT
7	PAF8-04000012-1	16141	GRUESO (0.1 mm)	SHIM (0.1 mm)	SPESSORE (0.1 mm)	CALE (0.1 mm)
	PAF8-04000012-2	813277	GRUESO (0.15 mm)	SHIM (0.15 mm)	SPESSORE (0.15 mm)	CALE (0.15 mm)
8	PAF8-04010000	8037391	PIÑÓN MARCHA AVANTE	POSITIVE GEAR	PIGNONE MARCIA AVANTE	PIGNON DE MARCHE AVANT
9	PAF8-04000305	16152	ÉMBOLO DE CAMBIO	PLUNGER SHIFT	CAMBIO PISTONE	PISTON
10	PAF8-04010000	16150	PIN	PIN	SPINOTTO	PIN
11	PAF8-04000303	803745 1	SELECTOR	CLUTCH, DOG	SELETTORE	CRABOT
12	PAF8-04000302	892777002	MUELLE	SPRING	MOLLA	RESSORT
13	PAF8-04000301	803744002	EJE HÉLICE	SHAFT PROPELLER	ASSE ELICA	ARBRE D'HÉLICE
14	PAF8-04000012	16140	ARANDELA	WASHER	RONDELLA	RONDELLE
15	PAF8-04000014	803741 1	PIÑÓN MARCHA ATRÁS	REVERSER GEAR	PIGNONE MARCIA INDIETRO	PIGNON MARCHE ARRIÈRE
16	PAF8-04040002	16131	TÓRICA	O-RING	O-RING	JOINT TORIQUE
17	PAF8-04040001	8037632T03	COJINETE DIÁBOLO	COVER LOWER CASING	COPERCHIO CARTER INFERIORE	DIABOLO
18	PAF8-04040000		DIÁBOLO COMPLETO	COVER LOWER CASING ASSY	COPERCHIO CARTER INFERIORE COMPLETO	DIABOLO COMPLET
19	PAF8-04040004	16130	RETÉN ACEITE	OIL SEAL	PARAOLIO	JOINT SPI
20	PAF8-04000019	803743002	ESPACIADOR DE HÉLICE	CUSHION PROPELLER	DISTANZIALE ELICA	ENTRETOISE D'HELICE
21	PAF15-06000016	16147	TUERCA HÉLICE	NUT, PROPELLER	DADO ELICA	ECROU D'HÉLICE
22	PAF8-04000016	895155	RETÉN	SEAL	PARAOLIO	TAMPON
23	PAF8-04000015	895156	RETÉN DE AGUA	WATER SEAL	TENUTA ACQUA	JOINT D'EAU
24	PAF8-04000021	95218 11	PIN, ACERO INOX.	PIN, DOWEL	SPINOTTO	CLAVETTE ARBRE DE TRANSMISSION
25	PAF8-04020001S	803738004	EJE S	SHAFT S	ASSE S	ARBRE S
	PAF8-04020001L	803738005	EJE L	SHAFT L	ASSE L	ARBRE L
26	PAF8-04000005	16158 7	JUNTA	GASKET	GUARNIZIONE	JOINT
27	PAF8-04000004-1	853795 5	GRUESO	SHIM	SPESSORE	CALE
28	PAF8-04000101	95348	RETÉN ACEITE	OIL SEAL	PARAOLIO	JOINT SPI
29	PAF8-04000006	16158 6	JUNTA	GASKET	GUARNIZIONE	JOINT
30	PAF8-04000007	803753 1	PLACA BOMBA AGUA	PLATE WATER PUMP	PIASTRA POMPA	PLAQUE DE POMPE À EAU
31	PAF8-04000008	16158 5	JUNTA BOMBA AGUA	GASKET WATER PUMP	GUARNIZIONE POMPA ACQUA	JOINT DE POMPE À EAU
32	PAF8-04000200	803748 1	IMPULSOR	IMPELLER	GIRANTE	TURBINE
33	PAF8-04000010	803751 1	TAPA BOMBA	PUMP CAP	COPERCHIO POMPA	COUVERCLE POMPE
34	PAF8-04000009	803750A02	CUERPO BOMBA DE AGUA	WATER PUMP, HOUSING	CORPO POMPA ACQUA	CORPS DE POMPE A EAU
35	PAF8-04000013	804903	CASQUILLO DE GOMA	DAMPER, WATER PUMP	GHIERA GOMA	BAGUE
36	PAF8-02000006S	803755004	TUBO AGUA S	WATER TUBE S	TUBO ACQUA S	TUYAU D'EAU S
	PAF8-02000006L	803755005	TUBO AGUA L	WATER TUBE L	TUBO ACQUA L	TUYAU D'EAU L
37	PAF8-02000007	804899002	RETÉN TUBO DE AGUA	UPPER SEAL, WATER PIPE	TENUTA, TUBO ACQUA	JOINT SUPERIEUR TUBE D'EAU



REC80W90U3
REC80W90U6
RECGREU1
RECGREU12

P. 45

4T 8 HP BODENSEE (INTER.) • 9.9 HP (232 CC) • 13.5 HP (INTER.) • 15 HP 2T 6, 8, 9.9, 13.5, 15 HP (1986+)
 STROKES RATIO 2.00:1 • Ø TORPEDO 102 mm STROKES

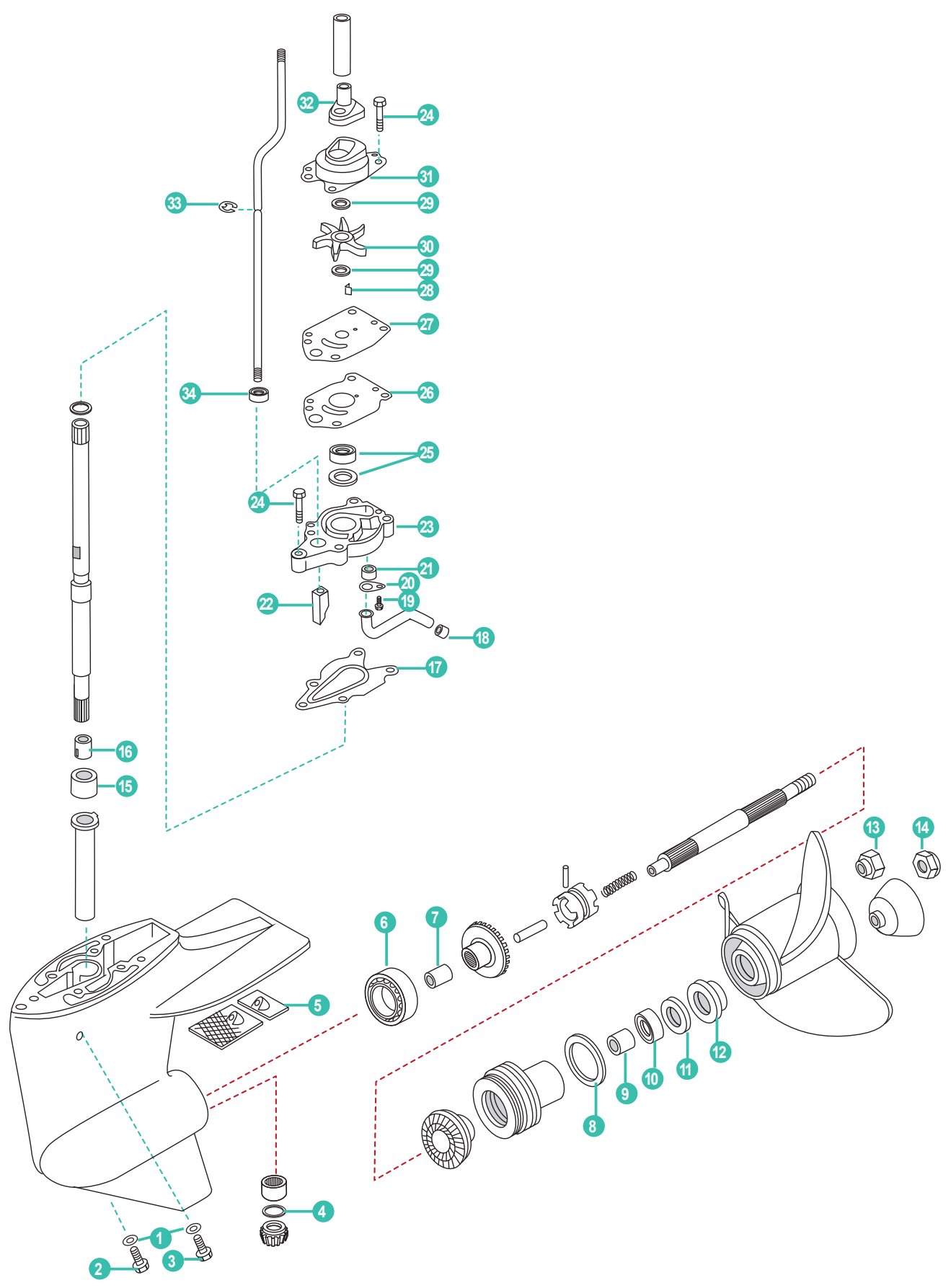

	REF	OEM				
1	REC12-191833	12-19183-3	JUNTA	GASKET	GUARNIZIONE	JOINT SPI
2	REC22-67892A05	22-67892A1	TORNILLO DRENAJE	DRAINING SCREW	VITI DRENAGGIO	VIS DE VIDANGE
3	REC10-79953Q04	10-79953Q2	TORNILLO	SCREW	VITI	VIS
4	REC12-41369	12-41369	ARANDELA	WASHER	RONDELLA	RONDELLE
5	CM42121A2	42121A2	ANODO ALUMINIO	ANODE ALUMINIUM	ANODO ALLUMINIO	ANODE ALUMINIUM
	CM42121	42121A2	ANODO ZINC	ANODE ZINC	ANODO ZINCO	ANODE ZINC
6	REC31-821321A1	31-821321A1	RODAMIENTO	BEARING	CUSCINETTO	ROULEMENT
7	REC23-41367	23-41367	CASQUILLO	BUSHING	BOCCOLA	BAGUE
8	REC25-33145	25-33145	ARO TÓRICO	O-RING	O-RING	TORIQUE
9	REC23-821927	23-821927	CASQUILLO	BUSHING	BOCCOLA	BAGUE
10	REC26-66022	26-66022	RETÉN ACEITE (DESIGN I)	OIL SEAL (DESIGN I)	PARAOILIO (DESIGN I)	JOINT SPI (DESIGN I)
	REC26-99325	26-99325	RETÉN ACEITE (DESIGN II)	OIL SEAL (DESIGN II)	PARAOILIO (DESIGN II)	JOINT SPI (DESIGN II)
11	REC26-821928	26-821928	RETÉN ACEITE (DESIGN III)	OIL SEAL (DESIGN III)	PARAOILIO (DESIGN III)	JOINT SPI (DESIGN III)
12	REC8219321	821932-1	CIERRE HÉLICE	THRUST HUB	CHIUSURA ELICA	RONDELLE D'HELICE
13	REC23-420911	23-42091-1	ESPACIADOR DE HÉLICE	CUSHION PROPELLER	DISTANZIALE ELICA	ENTRETOISE D'HELICE
14	REC11-40140	11-40140	TUERCA HÉLICE	NUT, PROPELLER	DADO ELICA	ECROU D'HELICE
15	REC23-823944	23-823944	CASQUILLO	SLEEVE	BOCCOLA	BAGUE
16	REC23-823943	23-823943	CASQUILLO	BUSHING	BOCCOLA	BAGUE
17	REC27-192043	27-19204-3	JUNTA	GASKET	GUARNIZIONE	JOINT
18	REC26-33613	26-33613	RETÉN	SEAL	PARAOILIO	JOINT
19	REC10-48408	10-48408	TORNILLO	SCREW	VITE	VIS
20	REC42375	42375	RETENEDOR	RETAINER	RITENITORE	RETENUE
21	REC26-42133	26-42133	RETÉN	SEAL	TENUTA	JOINT
22	REC42039	42039	LEVA CAMBIO	SHIFT CAM	ASSE CAMBIO	LEVIER DE CHANGEMENT
23	REC46-42040T5	46-42040T5	BASE BOMBA	PUMP BASE ASSEMBLY	BASE POMPA	BASE DE POMPE A EAU
24	REC10-82684430	10-826844-30	TORNILLO	SCREW	VITE	VIS
25	REC26-413651	26-41365-1	RETÉN ACEITE	OIL SEAL	PARAOILIO	JOINT SPI
26	REC27-19202001	27-19202	JUNTA	GASKET	GUARNIZIONE	JOINT
27	REC42200	42200	TAPA BOMBA	WEAR PLATE	COPERCHIO POMPA	PLAQUE DE POMPE A EAU
28	REC28-42376A2	28-42376A2	CHAVETA	KEY	CHIAVETTA	CLAVETTE
29	REC12-16448	12-16448	ARANDELA	WASHER	RONDELLA	RONDELLE
30	REC47-420382	47-42038-2	IMPULSOR	IMPELLER	GIRANTE	TURBINE
31	REC46-42089A2	46-42089A2	CUERPO BOMBA DE AGUA	WATER PUMP, HOUSING	CORPO POMPA ACQUA	CORS DE POMPE A EAU
32	REC26-421021	26-42102-1	GRUESO	GROMMET	SPESSORE	ENTRETOISE
33	REC52-42389	52-42389	CLIP	CLIP	CLIP	CLIP
34	REC25-822236	25-822236	ARO	QUAD RING	O-RING	JOINT



REC80W90U3
REC80W90U6
RECGREU1
RECGREU2



REF OEM
REC26-41365A3 26-41365A3



REF OEM
REC47-42038Q3 47-42038Q3



REF OEM
REC46-42089A5 46-42089A5

4T 8 HP BODENSEE (INTER.) • 9.9 HP (232 CC) • 13.5 HP (INTER.) • 15 HP
 STROKES RATIO 2.42:1 • Ø TORPEDO 130 mm

2T 18XD, 20, 25 HP (1984+)
 STROKES

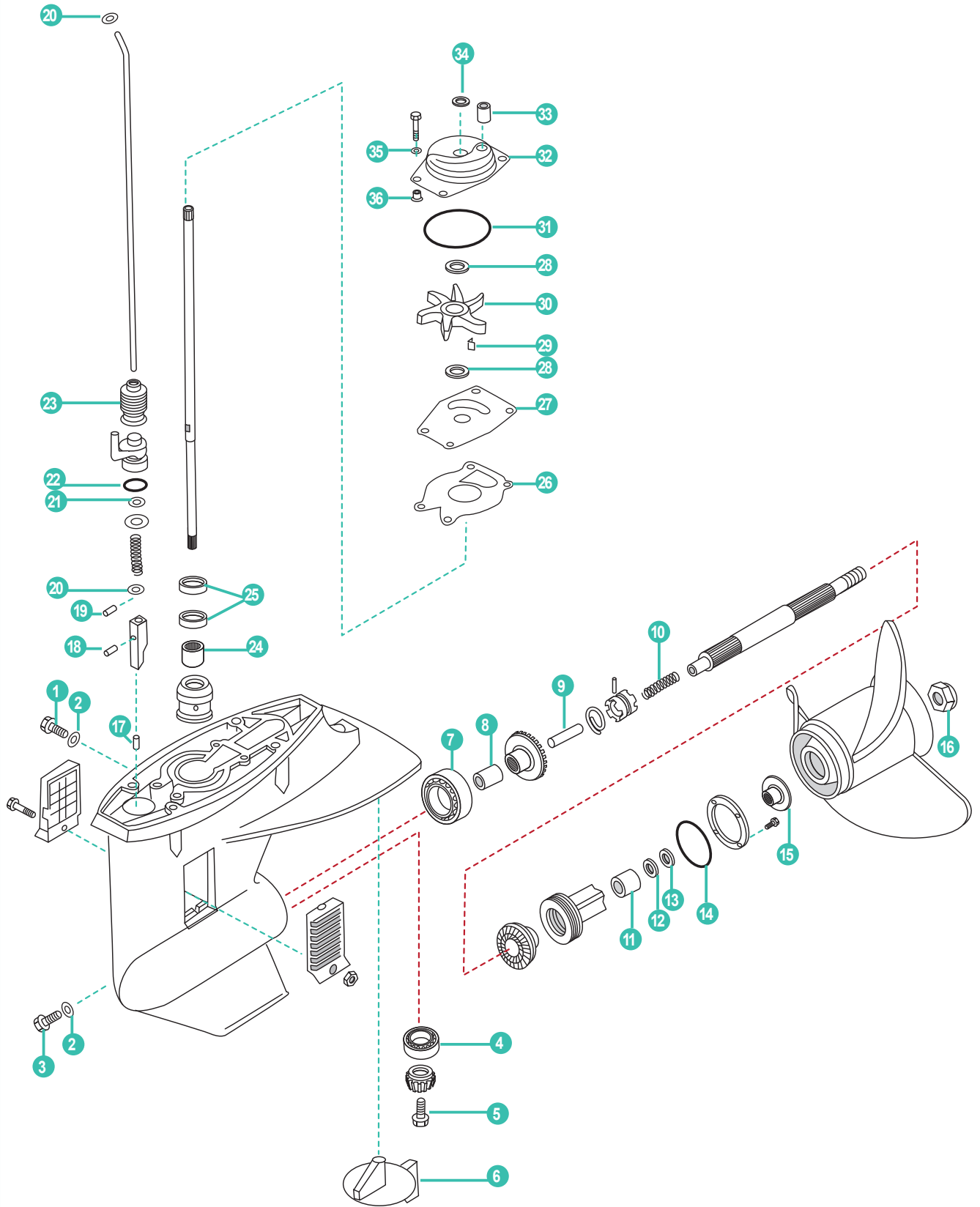

	REF	OEM				
1	REC10-79953Q04	10-79953Q2	TORNILLO	BOLT	VITE	VIS
2	REC12-191833	12-19183-3	JUNTA	GASKET	GUARNIZIONE	JOINT
3	REC22-67892A05	22-67892A1	TORNILLO DRENAJE	DRAINING SCREW	VITI DRENAGGIO	VIS DE VIDANGE
4	REC31-98294A1	31-98294A1	RODAMIENTO	BEARING	CUSCINETTO	ROULEMENT
5	REC10-49908	10-49908	TORNILLO	BOLT	VITE	VIS
6	TEN00812	98432T6	ANODO ZINC	TRIM TAB ZINC	ANODO ZINCO	ANODE ZINC
	CM984325A	98432T6	ANODO ALUMINIO	TRIM TAB ALUMINUM	ANODO ALLUMINIO	ANODE ALUMINIUM
7	REC31-66668A1	31-99328A1	RODAMIENTO	BEARING	CUSCINETTO	ROULEMENT
8	REC23-85557	23-85557	CASQUILLO	BUSHING	BOCCOLA	BAGUE
9	REC85094	85094	ÉMBOLO DE CAMBIO	PLUNGER SHIFT	CAMBIO PISTONE	PISTON
10	REC24-88680	24-88680	MUELLE	SPRING	MOLLA	RESSORT
11	REC31-21739	31-21739	RODAMIENTO AGUJAS	BEARING, NEEDLE	CUSCINETTO	ROULEMENT
12	REC26-41132	26-41132	RETÉN ACEITE	OIL SEAL	PARAOLIO	JOINT SPI
13	REC26-76127	26-41131	RETÉN ACEITE	OIL SEAL	PARAOLIO	JOINT SPI
14	REC25-85549	25-85549	ARO TÓRICO	O-RING	O-RING	JOINT TORIQUE
15	REC858498	858498	TOPE HÉLICE	THRUST WASHER	CHIUSURA ELICA	RONDELLE D'HELICE
16	REC11-88228	11-88228	TUERCA HÉLICE (PLÁSTICO)	PROP NUT (PLASTIC)	DADO ELICA (PLASTICA)	ECROU D'HELICE (PLASTIQUE)
	REC11-4011912	11-40119-12	TUERCA HÉLICE	PROP NUT	DADO ELICA	ECROU D'HELICE
17	REC17-85500	17-85500	PIN	PIN	SPINOTTO	PIN
18	REC17-85096	17-85096	PASADOR	DRIVE PIN	FERNO	GOUPILLE
19	REC17-85593	17-85593	PASADOR	ROLL PIN	FERNO	GOUPILLE
20	REC12-29245	12-29245	ARANDELA	WASHER	RONDELLA	RONDELLE
21	REC301877	25-85594	ARO TÓRICO	O-RING	O-RING	JOINT TORIQUE
22	REC310584	25-35276	ARO TÓRICO	O-RING	O-RING	JOINT TORIQUE
23	REC85552001	85552001	LEVA FUELLE	SHIFT BOOT	CUFFIA DEL CAMBIO	SOUFFLET
24	REC31-41326	31-41326	RODAMIENTO	BEARING	CUSCINETTO	ROULEMENT
25	REC26-99325	26-99325	RETÉN	OIL SEAL	PARAOLIO	JOINT SPI
26	REC27-993261	27-99326-1	JUNTA	GASKET	GUARNIZIONE	JOINT
27	REC85083	85083	TAPA BOMBA	WEAR PLATE	COPERCHIO POMPA	COUVERCLE POMPE
28	REC12-86645	12-86645-1	ARANDELA	WASHER	RONDELLA	RONDELLE
29	REC28-8M0032838	28-8M0032838	CHAVETA	KEY	CHIAVETTA	CLAVETTE
30	REC47-8508910	47-85089-10	IMPULSOR	IMPELLER	GIRANTE	TURBINE
31	REC25-67202	25-69202	ARO TÓRICO	O-RING	O-RING	JOINT TORIQUE
32	REC46-99157A02	46-99157A02	CUERPO BOMBA	PUMP HOUSING	CORPO POMPA	CORPS DE POMPE A EAU
33	REC26-85090001	26-85090	GRUESO	GROMMET	SPESSORE	ENTRETOISE
34	REC25-86203	25-86203	CASQUILLO BOMBA	SLINGER	GHIERA POMPA	BAGUE DE POMPE
35	REC12-29245	12-89302	ARANDELA	WASHER	RONDELLA	RONDELLE
36	REC23-85095	23-85095	CIERRE	INSULATOR	CHIUSURA	ISOLANT

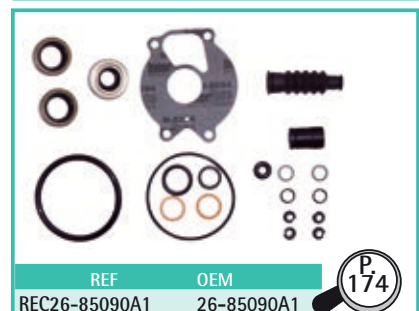
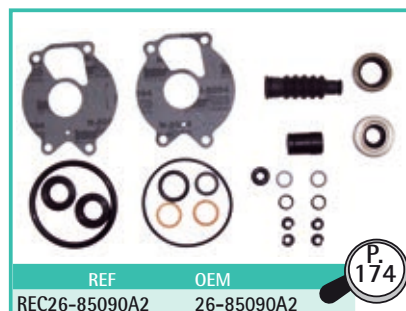

4T 8, 9.9, 10, 15, 20 HP
STROKES COMMAND THRUST

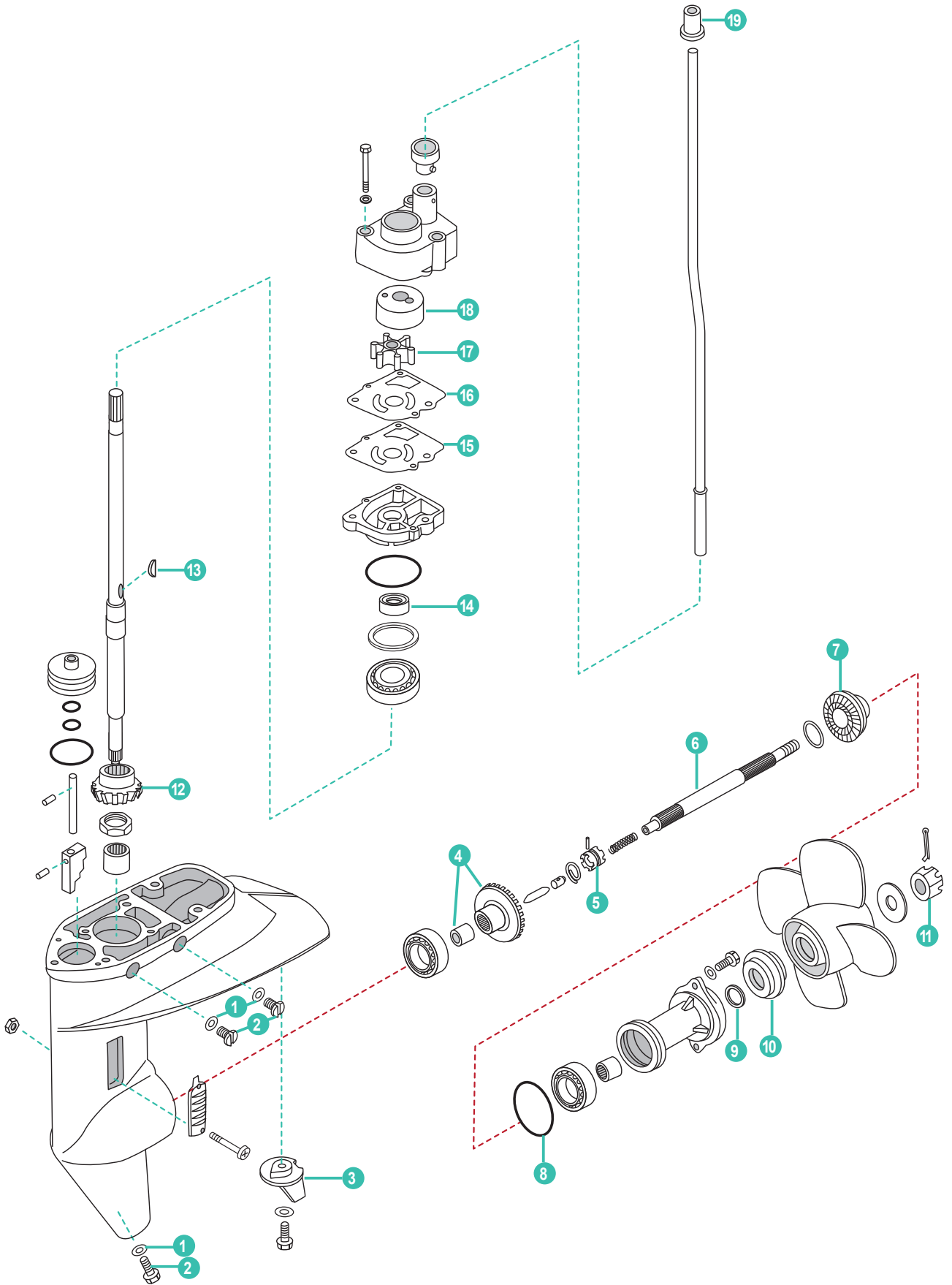

	REF	OEM				
1	REC90430-08020	95220	JUNTA	GASKET	GUARNIZIONE	JOINT
2	REC90340-08002	953683	TORNILLO DRENAJE	DRAINING SCREW	VITI DRENAGGIO	VIS DE VIDANGE
3	CM3V1-60217-0	853762T01	ÁNODO	ANODE	ANODO	ANODE
4	REC43-803739T03	803739T02	PIÑÓN MARCHA AVANTE	POSITIVE GEAR	PIGNONE MARCIA AVANTE	PIGNON DE MARCHE AVANT
5	REC52-803745	803745	SELECTOR	CLUTCH, DOG	SELETTORE	CRABOT
6	REC879147T96	803744T03	EJE HÉLICE	SHAFT PROPELLER	ASSE ELICA	ARBRE D'HÉLICE
7	REC43-803741T03	803741T02	PIÑÓN MARCHA ATRÁS	REVERSER GEAR	PIGNONE MARCIA INDIETRO	PIGNON MARCHE ARRIÈRE
8	REC25-8M0087846	803735	TÓRICA	O-RING	O-RING	JOINT TORIQUE
9	REC26-161622	161622	RETÉN ACEITE	OIL SEAL	PARAOLIO	JOINT SPI
10	PAF8-04000019	803743	ESPACIADOR DE HÉLICE	CUSHION PROPELLER	DISTANZIALE ELICA	ENTRETOISE D'HELICE
11	REC11-161471	161471	TUERCA HÉLICE	NUT, PROPELLER	DADO ELICA	ECROU D'HÉLICE
12	REC43-803740T02	803740T02	PIÑÓN ATAQUE	INITIATIVE GEAR	MARCIA INIZIATIVA	PIGNON D'ATTAQUE
13	REC28-803749	803749	CHAVETA	KEY, WOODRUFF	CIAVETTA	CLAVETTE
14	REC26-803752	803752	RETÉN ACEITE	OIL SEAL	PARAOLIO	JOINT SPI
15	REC27-8M0075040	8M0075040	JUNTA	GASKET	GUARNIZIONE	JOINT
16	REC803753	803753	TAPA BOMBA	OUTER PLATE	COPERCHIO POMPA	PLAQUE DE POMPE A EAU
17	REC334-65021-1	803748	IMPULSOR	IMPELLER	GIRANTE	TURBINE
18	REC803751	803751	CASQUILLO	INSERT	GHIERA	INSERT
19	PAF8-02000007	804899002	RETÉN	SEAL	PARAOLIO	JOINT SPI



4T 9.9, 10, 15, 20 HP
STROKES

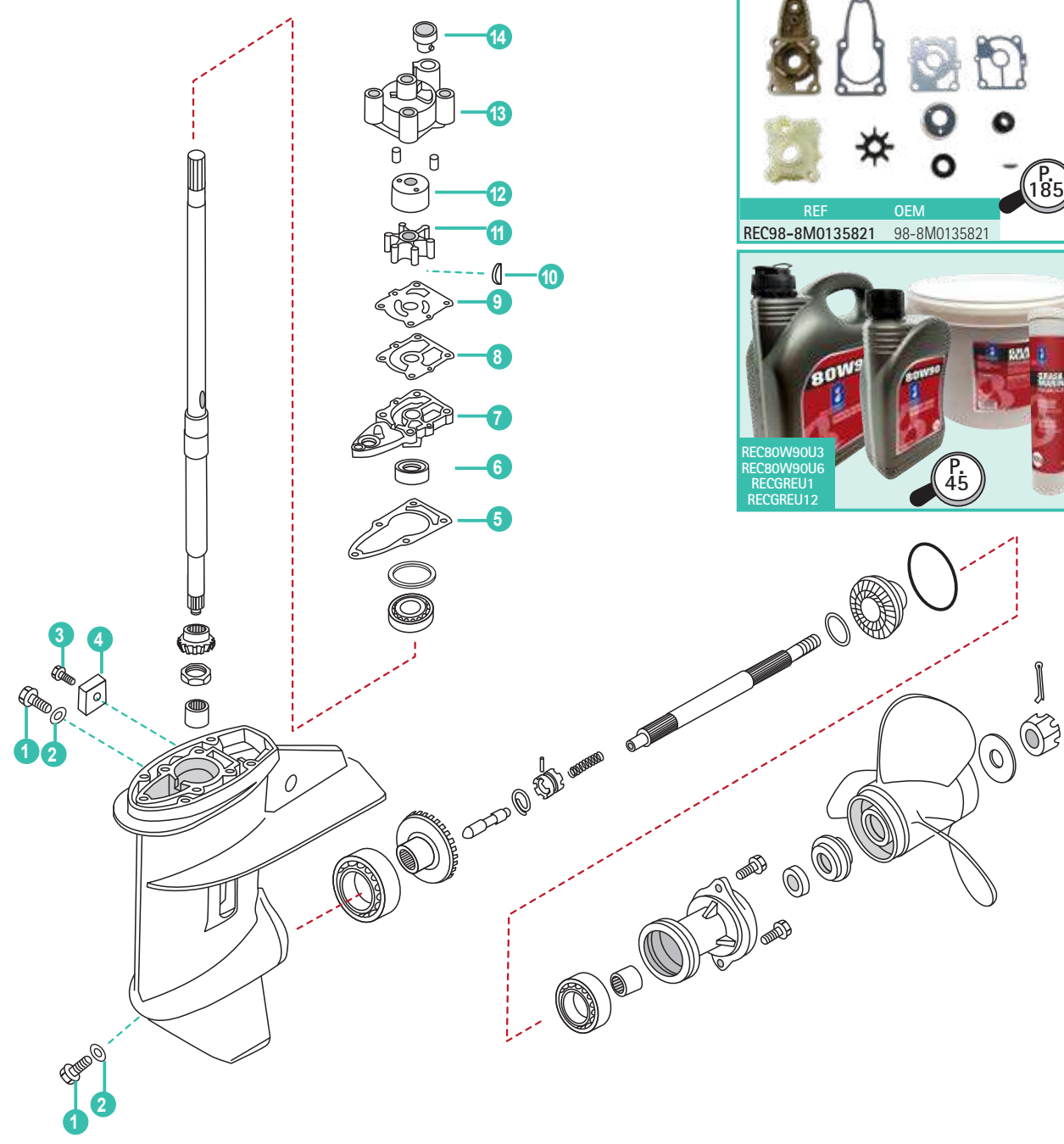

	REF	OEM				
1	REC90340-08002	953683	TORNILLO DRENAJE	DRAINING SCREW	VITI DRENAGGIO	VIS DE VIDANGE
2	REC09168-10022	8M0082880	JUNTA	GASKET	GUARNIZIONE	JOINT DE VIDANGE
3	PAGB/T5787-M6X20	167051	TORNILLO	BOLT	VITE	VIS
4	REC41106-ZW9-000AL	8M0137344	ÁNODO	ANODE	ANODO	ANODE
5	REC27-8M0135804	8M0135804	JUNTA	GASKET	GUARNIZIONE	JOINT
6	REC26-803752	803752	RETÉN ACEITE	OIL SEAL	PARAOLIO	JOINT SPI
7	REC8M0134493	8M0134493	CUERPO BOMBA	PUMP HOUSING	CORPO POMPA	CORPS DE POMPE A EAU
8	REC27-8M0135806	8M0135806	JUNTA	GASKET	GUARNIZIONE	JOINT DE POMPE A EAU
9	REC8M0135805	8M0135805	TAPA BOMBA	OUTER PLATE	COPERCHIO POMPA	PLAQUE DE POMPE
10	REC28-8M0137347	8M0137347	CHAVETA	KEY, WOODRUFF	CIAVETTA	CLAVETTE
11	REC334-65021-1	8M0135803	IMPULSOR	IMPELLER	GIRANTE	TURBINE
12	REC803751	803751	CASQUILLO	INSERT	GHIERA	INSERT
13	REC8M0134492	8M0134492	CUERPO BOMBA	PUMP HOUSING	CORPO POMPA	CORPS DE POMPE A EAU
14	REC26-8036674	8036674	CASQUILLO DE GOMA	DAMPER, WATER PUMP	GHIERA GOMA	BAGUE

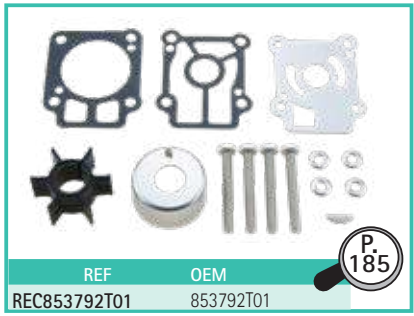
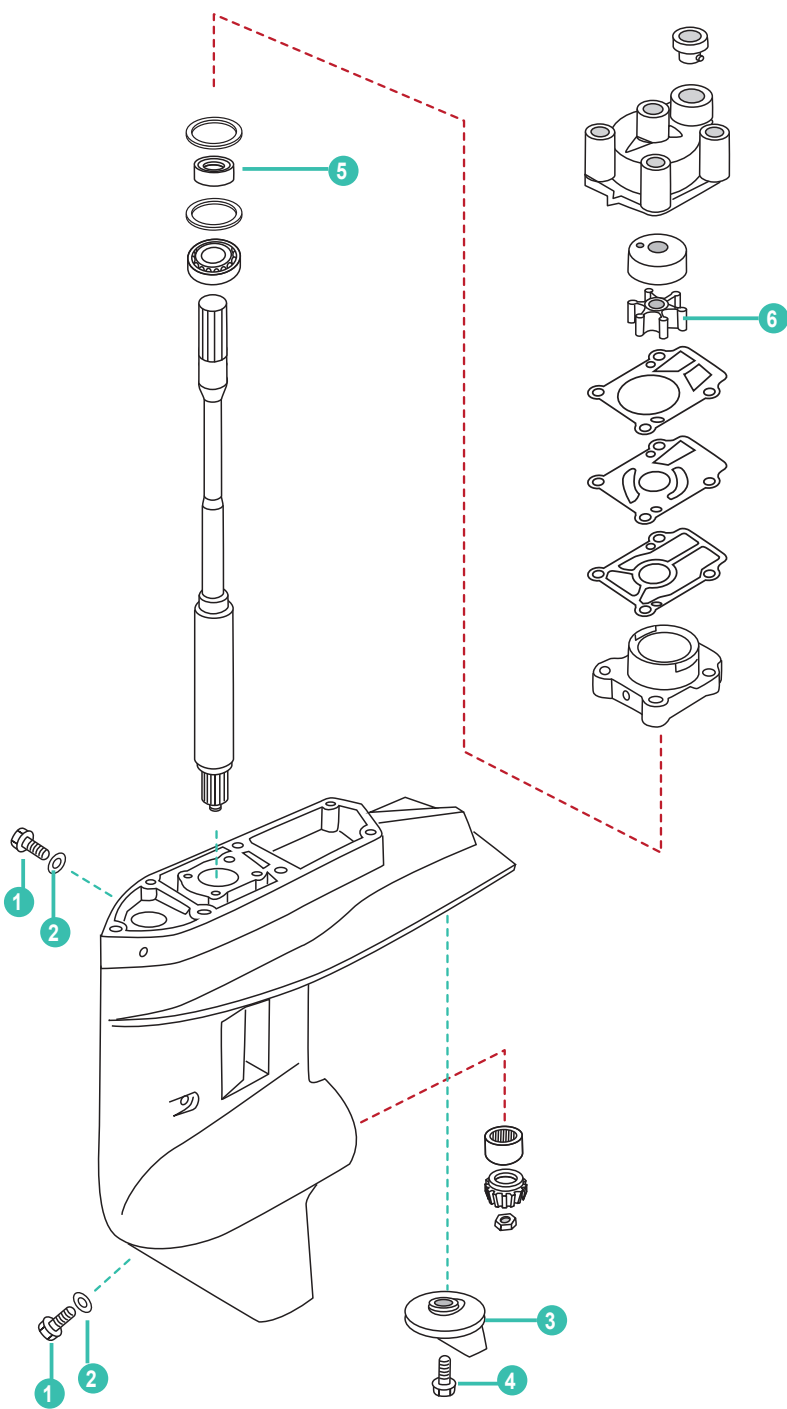

	REF	OEM				
1	REC90340-08002	953683	TORNILLO DRENAJE	DRAINING SCREW	VITI DRENAGGIO	VIS DE VIDANGE
2	REC90430-08020	95220	JUNTA	GASKET	GUARNIZIONE	JOINT DE VIDANGE
3	REC853762	853762	ÁNODO	ANODE	ANODO	ANODE
4	PAGB/T5787-M6X20	167051	TORNILLO M6X20	BOLT M6X20	VITE M6X20	VIS M6X20
5	REC26-161622	161622	RETÉN ACEITE	OIL SEAL	PARAOILIO	JOINT SPI
6	REC345-65021-0	161541	IMPULSOR	IMPELLER	GIRANTE	TURBINE

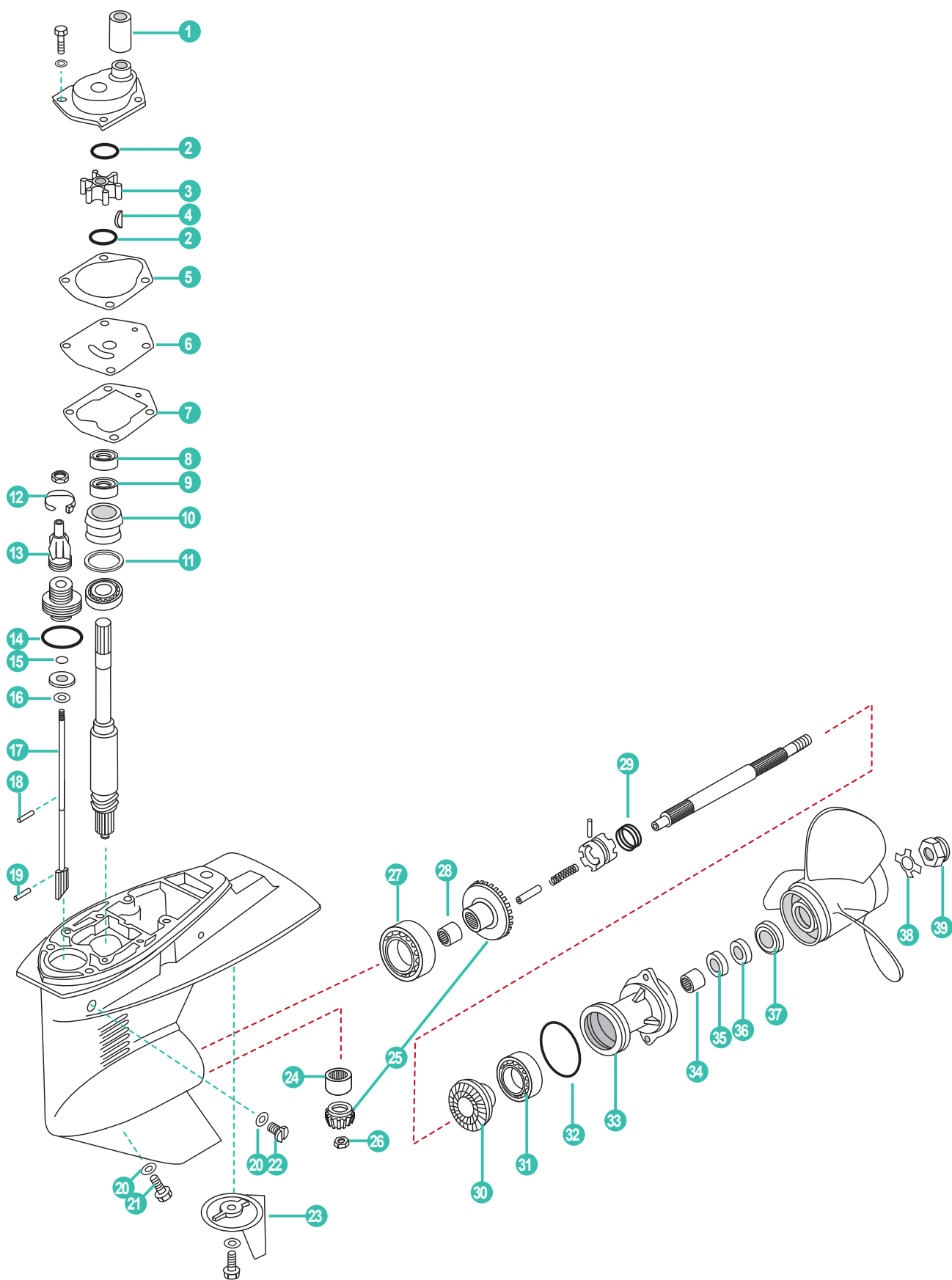

	REF	OEM				
1	REC8235471	823547-1	TUBO AGUA 2 ^{1/4"}	WATER TUBE	TUBO ACQUA	TUBE D'EAU
	REC43023	43023	TUBO AGUA 1 ^{3/4"}	WATER TUBE	TUBO ACQUA	TUBE D'EAU
2	REC12-86645	12-86645-1	ARANDELA	WASHER	RONDELLA	RONDELLE
3	REC47-8508910	47-85089-3	IMPULSOR	IMPELLER	GIRANTE	TURBINE
4	REC28-8M0032838	28-8M0032838	CHAVETA	KEY	CHIAVETTA	CLAVETTE
5	REC27-822189	27-822189	JUNTA	GASKET	GUARNIZIONE	JOINT
6	REC8213542	821354-2	TAPA BOMBA	OUTER PLATE	COPERCHIO POMPA	PLAQUE DE POMPE
7	REC27-822217	27-822217	JUNTA	GASKET	GUARNIZIONE	JOINT
8	REC26-821309	26-821309	RETÉN ACEITE	OIL SEAL	PARAOLIO	JOINT SPI
9	REC26-821310	26-821310	RETÉN ACEITE	OIL SEAL	PARAOLIO	JOINT SPI
10	REC46-821307A2	46-821307A2	BASE BOMBA	PUMP BASE	BASE POMPA	BASE POMPE À EAU
11	REC25-821308	25-821308	ARO TÓRICO	O-RING	O-RING	JOINT TORIQUE
12	REC54-8M0064024	823548	ABRAZADERA	CABLE TIE	FASCETTA	COLLIER
13	REC822158	822158	PROTECTOR GOMA	BOOT	PROTETTORE GOMMA	PROTECTION CAOUTCHOUC
14	REC3852928	25-26855	ARO TÓRICO	O-RING	O-RING	JOINT TORIQUE
15	REC301877	25-85594	ARO TÓRICO	O-RING	O-RING	JOINT TORIQUE
16	REC12-29245	12-29245	ARANDELA	WASHER	RONDELLA	RONDELLE
17	REC8213161	8213161	LEVA CAMBIO	SHIFT CAM	ALBERO CAMBIO	LEVIER DE CHANGEMENT
18	REC17-85593	17-85593	PIN	PIN	SPINOTTO	PIN
19	REC17-822369	17-822369	PIN	PIN	SPINOTTO	PIN
20	REC12-191833	12-19183-3	JUNTA	GASKET	GUARNIZIONE	JOINT
21	REC22-67892A05	22-67892A1	TORNILLO DRENAJE	DRAINING SCREW	VITE DRENAGGIO	VIS DE VIDANGE
22	REC10-79953Q04	10-79953Q2	TAPÓN	SCREW SET	TAPPO	BOUCHON
23	TEN00829AL	822157T2	ÁNODO ALUMINIO	ANODE ALUMINUM	ANODO ALLUMINIO	ANODE ALUMINIUM
	CM822157T2	822157T2	ÁNODO ZINC	ANODE ZINC	ANODO ZINCO	ANODE ZINC
24	REC31-821321A1	31-821321A1	RODAMIENTO	BEARING	CUSCINETTO	ROULEMENT
25	REC43-803498T1	43-803498T1	KIT PIÑONES MARCHA AVANTE	P/FORWARD GEAR SET	KIT PIGNONE MARCIA AVANTI	KIT PIGNON MARCHE AVANT
26	REC3133339	11-55910	TUERCA PIÑÓN	PINION NUT	DADO PIGNONE	ÉCROU PIGNON
27	REC31-66668A1	31-99328A1	COJINETE	BEARING	CUSCINETTO	ROULEMENT
28	REC31-41326	31-41326	COJINETE	BEARING	CUSCINETTO	ROULEMENT
29	REC24-38114	24-38114	MUELLE	SPRING	MOLLA	RESSORT
30	REC43-822163T1	43-822163T1	PIÑÓN MARCHA ATRÁS	REVERSE GEAR	PIGNONE MARCIA INDIETRO	PIGNON MARCHE ARRIÈRE
31	REC30-20839T	30-20839T	COJINETE	BEARING	CUSCINETTO	ROULEMENT
32	REC25-80863	25-815460	ARO TÓRICO	O-RING	O-RING	JOINT TORIQUE
33	REC19291A3	19291A3	COJINETE DIABOLO	BEARING CARRIER	DIABOLO	DIABOLO
34	REC31-21700	31-21700	COJINETE	BEARING	CUSCINETTO	ROULEMENT
35	REC26-69188	26-69188	RETÉN ACEITE	OIL SEAL	PARAOLIO	JOINT SPI
36	REC26-69189	26-69189	RETÉN ACEITE	OIL SEAL	PARAOLIO	JOINT SPI
37	REC73345A1	73345A1	CIERRE HÉLICE	THRUST HUB	FERMO PER ELICA	RONDELLE BUTÉE D'HELICE
38	REC14-76281Q	14-76281	ARANDELA	TAB WASHER	RONDELLA	RONDELLE
39	REC11-69578Q1	11-69578A1	TUERCA HÉLICE	PROP NUT	DADO ELICA	ÉCROU D'HELICE

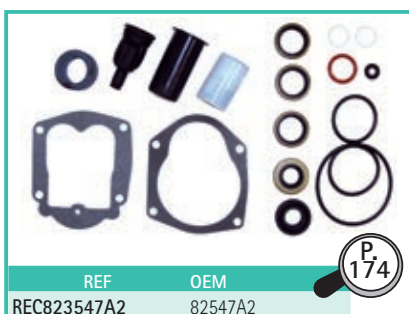

4T 30, 40, 50, 60 HP (4 CYL) EFI • 40 CARB (3CYL)
 STROKES Ø TORPEDO 87.38 mm = 3.44"

2T 50, 55, 60 HP (3 CYL)
 STROKES

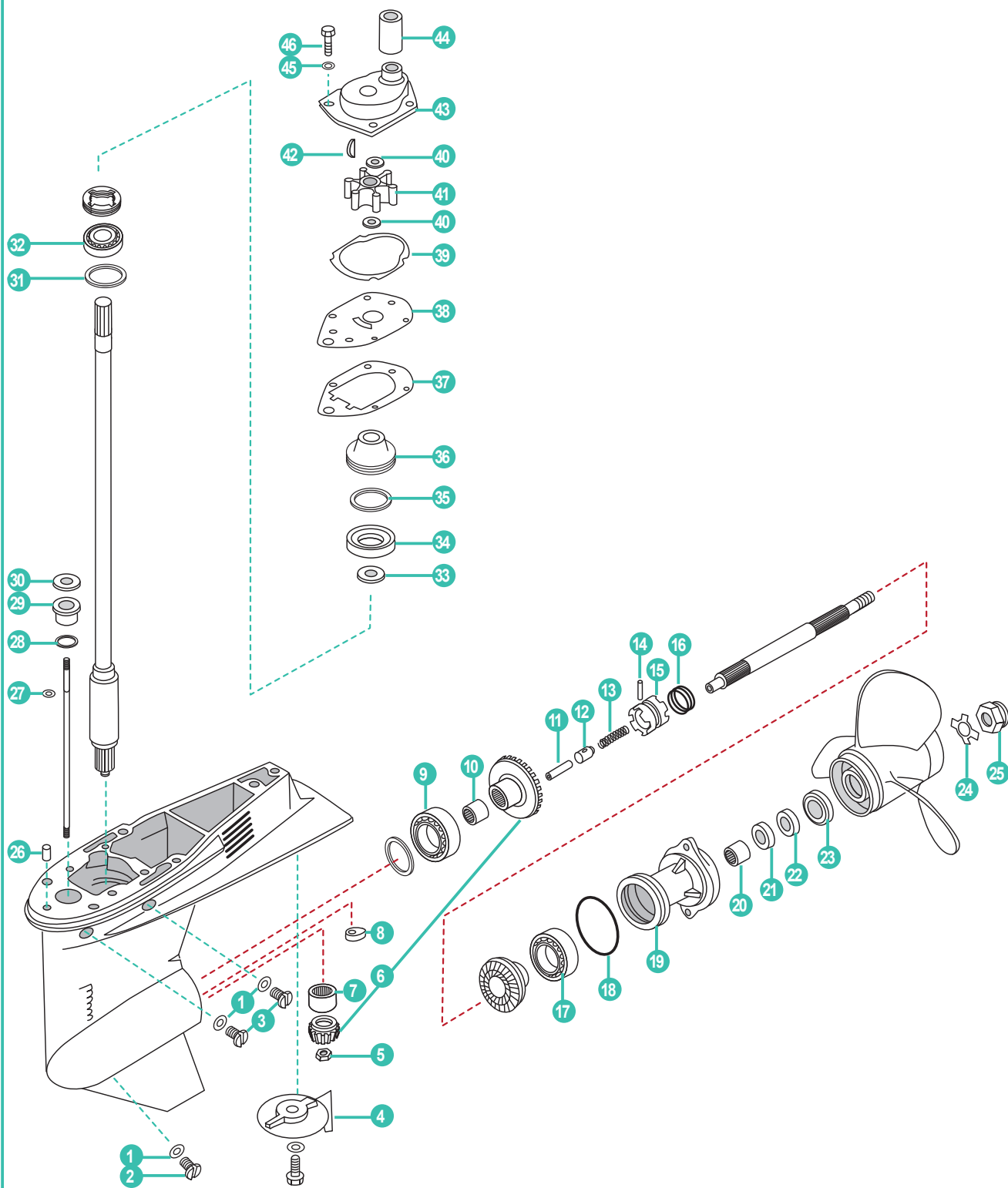

REF	OEM
REC26-814669A2	26-814669A2

P. 174

REF	OEM
REC46-812966A12	46-812966A12

P. 186

REF	OEM
REC46-812966A12	46-812966A11

P. 186

	REF	OEM				
1	REC12-191833	12-19183-3	JUNTA	GASKET	GUARNIZIONE	JOINT DE VIDANGE
2	REC22-67892A05	22-67892A1	TORNILLO DRENAJE	DRAINING SCREW	VITE DRENAGGIO	VIS DE VIDANGE
3	REC10-79953Q04	10-79953Q2	JUEGO TORNILLOS	SCREW KIT	KIT VITE	KIT VIS
4	TEN00827	17264T2	ÁNODO ZINC	TRIM TAB ZINC	ANODO ZINCO	ANODE ZINC
5	REC313339	11-55910	TUERCA PIÑÓN	PINION NUT	DADO PIGNONE	ÉCROU PIGNON
6	REC43-803499T1	43-803499T1	KIT PIÑONES MARCHA AVANTE (1.64:1)	FORWARD GEAR SET (1.64:1)	KIT PIGNONE MARCIA AVANTI (1.64:1)	KIT PIGNON MARCHE AVANT (1.64:1)
7	REC31-812768	31-812768	RODAMIENTO	BEARING	CUSCINETTO	ROULEMENT
8	REC76039-4	76039-4	LEVA	SHIFT CAM	LEVA	CAME
9	REC983892	31-812767A1	COJINETE	BEARING	CUSCINETTO	ROULEMENT
10	REC31-21739	31-21739	COJINETE	BEARING	CUSCINETTO	ROULEMENT
11	REC812929-1	812929-1	PASADOR	CAM FOLLOWER	CHIAVISTELLO	GOUPILLE
12	REC20843	20843	ACOPLE	SLIDE	ACCOPPIO	INSERT
13	REC24-815418	24-815418	MUELLE	SPRING	MOLLA	RESSORT
14	REC17-8M0020942	17-38113	PASADOR	CROSS PIN	SPINOTTO	PIN
15	REC52-850048T	52-850048T	SELECTOR	CLUTCH DOG	SELETTORE	CRABOT
16	REC24-30893	24-30893	MUELLE	SPRING	MOLLA	RESSORT
17	REC30-20839T	30-20839T	COJINETE	BEARING	CUSCINETTO	ROULEMENT
18	REC25-815460	25-815460	ARO TÓRICO	O-RING	O-RING	JOINT TORIQUE
19	REC19291A3	19291A3	COJINETE DIÁBOLO	BEARING CARRIER	CUSCINETTO	DIABOLO
20	REC31-21700	31-21700	COJINETE	BEARING	CUSCINETTO	ROULEMENT
21	REC26-69188	26-69188	RETÉN ACEITE	OIL SEAL	PARAOLIO	JOINT SPI
22	REC26-69189	26-69189	RETÉN ACEITE	OIL SEAL	PARAOLIO	JOINT SPI
23	REC73345A1	73345A1	TOPE HÉLICE	THRUST HUB	FERMO PER ELICA	RONDELLE BUTÉE D'HÉLICE
24	REC14-76281Q	14-76281	CIERRE HÉLICE	TAB WASHER	CHIUSURA ELICA	RONDELLE FREIN
25	REC11-69578Q1	11-69578A1	TUERCA HÉLICE	PROP NUT	DADO ELICA	ÉCROU D'HÉLICE
26	REC17-43043	17-43043	PASADOR	PIN	SPINOTTO	PIN
27	REC53-29641	53-29641	ARO RETENEDOR	RETAINING RING	CLIP	CLIPS
28	REC25-45258	25-45258	ARO TÓRICO	O-RING	O-RING	JOINT TORIQUE
29	REC23-813696A2	23-813696A2	CUERPO VARILLA CAMBIO	BUSHING ASSEMBLY	CORPO BACCHETTA CAMBIO	BAGUE ARBRE DE CHANGEMENT
30	REC26-8164641	26-816464-1	RETÉN ACEITE	OIL SEAL	PARAOLIO	JOINT SPI
31	REC15-812770A1	15-812770A1	KIT SUPLEMENTOS	SHIM SET	KIT SPESSORI	KIT ENTRETOISES
32	REC31-77420A1	31-77420A1	COJINETE	BEARING	CUSCINETTO	ROULEMENT
33	REC26-814669	26-814669	RETÉN ACEITE	OIL SEAL	PARAOLIO	JOINT SPI
34	REC26-814670	26-814670	RETÉN ACEITE	OIL SEAL	PARAOLIO	JOINT SPI
35	REC25-30224	25-30224	ARO TÓRICO	O-RING	O-RING	TORIQUE
36	REC46-812966A7	46-812966A7	BASE BOMBA	PUMP BASE	BASE POMPA	BASE POMPE À EAU
37	REC27-8M4502052	27-19701	JUNTA	GASKET	GUARNIZIONE	JOINT
38	REC19700A2	19700A2	TAPA BOMBA	OUTER PLATE	COPERCHIO POMPA	PLAQUE DE POMPE A EAU
39	REC27-822189	27-822189	JUNTA	GASKET	GUARNIZIONE	JOINT
40	REC8M0005777	12-858234	ARANDELA PLÁSTICO	WASHER-PLASTIC	RONDELLA PLASTICA	RONDELLE DE PLASTIQUE
41	REC47-19453T	47-19453T	IMPULSOR	IMPELLER	GIRANTE	TURBINE
42	REC28-8M0032831	28-8M0032831	CHAVETA	KEY	CHIAVETTA	CLAVETTE
43	REC14334A3	14334A3	CUERPO BOMBA	PUMP HOUSING	CORPO POMPA	CORPS DE POMPE A EAU
44	REC43023 REC893857	43023 859770-1	TUBO AGUA TUBO AGUA (4 TIEMPOS)	TUBE SEAL TUBE SEAL (FOR 4-STROKE)	TUBO ACQUA TUBO ACQUA (4 TEMPI)	TUBE D'EAU TUBE D'EAU (4 TEMPS)
45	REC23-43045	23-43045	CASQUILLO	INSULATOR	GHIERA	BAGUE
46	PAGB/T5783-M6X16	10-8248324	TORNILLO M6X16	BOLT M6X16	VITE M6X16	VIS M6X16



REF OEM

REC22-67892A05 22-67892A05

P. 345



VERSIONES MODERNAS
NEW VERSIONS
VERSIONE MODERNA
VERSION MODERNE

REF OEM

REC826134QAL 826134Q

P. 199



REF

REC80W90U3
REC80W90U6
RECGREU1
RECGREU12

P. 45

	REF	OEM				
1	REC12-191833	12-19183-3	JUNTA	GASKET	GUARNIZIONE	JOINT
2	REC10-79953Q04	10-79953Q2	JUEGO TORNILLOS	SCREW KIT	KIT VITE	KIT DE VIS
3	REC22-67892A05	22-67892A1	TORNILLO DRENAJE	DRAINING SCREW	VITE DRENAGGIO	VIS DE VIDANGE
4	CM31640	31640Q4	ÁNODO ZINC	TRIM TAB ZINC	ANODO ZINCO	ANODE ZINC
	CM31640A	31640Q4	ÁNODO ALUMINIO	TRIM TAB ALUMINUM	ANODO ALLUMINIO	ANODE ALUMINIUM
5	REC11-35921	11-35921	TUERCA PIÑÓN	PINION NUT	DADO PIGNONE	ÉCROU PIGNON
6	REC76039-4	76039-4	LEVA (3 DIENTES)	SHIFT CAM (3 JAW)	LEVA (3 DENTI)	CAME 3 DENTS
	REC850307	850307	LEVA (6 DIENTES)	SHIFT CAM (6 JAW)	LEVA (6 DENTI)	CAME 6 DENTS
7	CM826134	826134Q	ÁNODO ZINC	ANODE ZINC	ANODO ZINCO	ANODE ZINC
	CM826134A	826134Q	ÁNODO ALUMINIO	ANODE ALUMINUM	ANODO ALLUMINIO	ANODE ALUMINIUM
8	REC12-45176	12-45176	ARANDELA	WASHER	RONDELLA	RONDELLE
9	REC853906A1	853906A1	EJE CAMBIO 20"	SHIFT SHAFT 20"	ASSE CAMBIO 20"	ARBRE CHANGEMENT 20"
	REC853908A1	853908A1	EJE CAMBIO 25"	SHIFT SHAFT 25"	ASSE CAMBIO 25"	ARBRE CHANGEMENT 25"
10	REC53-29641	53-29641	ARO RETENEDOR	RETAINING RING	O-RING	CLIPS
11	REC25-457101	25-45710	ARO TÓRICO	O-RING	O-RING	JOINT TORIQUE
12	REC23-43052A4	23-43052A4	CASQUILLO	BUSHING ASSEMBLY	GHIERA	BAGUE
13	REC26-8164641	26-816464-1	RETÉN ACEITE	OIL SEAL	PARAOLIO	JOINT SPI
14	REC43046	43046	MANGUITO ACEITE	OILER TUBE	TUBO OLIO	TUYAU D'HUILE
15	REC31-42677A1	31-42677A1	COJINETE	BEARING	CUSCINETTO	ROULEMENT
16	REC15-8M0063265	15-44492A1	KIT SUPLEMENTOS	SHIM SET	KIT SUPPLEMENTI	KIT ENTRETOISES
	REC45-858765T1	45-858765T1	EJE TRANSMISIÓN (20" 70-115 HP)	DRIVE SHAFT (20" 70-115 HP)	ASSE TRASMISSIONE (20" 70-115 HP)	ARBRE TRANSMISION (20" 70-115 HP)
	REC45-878575T1	45-878575T1	EJE TRANSMISIÓN (25" 70-115 HP)	DRIVE SHAFT (25" 70-115 HP)	ASSE TRASMISSIONE (25" 70-115 HP)	ARBRE TRANSMISION (25" 70-115 HP)
17	REC45-854808A1	45-854808A1	EJE TRANSMISIÓN (20" 30-50 HP)	DRIVE SHAFT (20" 30-50 HP)	ASSE TRASMISSIONE (20" 30-50 HP)	ARBRE TRANSMISION (20" 30-50 HP)
	REC45-859105A1	45-859105A1	EJE TRANSMISIÓN (20" 40-60 HP)	DRIVE SHAFT (20" 40-60 HP)	ASSE TRASMISSIONE (20" 40-60 HP)	ARBRE TRANSMISION (20" 40-60 HP)
	REC45-875222A1	45-875222A1	EJE TRANSMISIÓN (25" 40-60 HP)	DRIVE SHAFT (25" 40-60 HP)	ASSE TRASMISSIONE (25" 40-60 HP)	ARBRE TRANSMISION (25" 40-60 HP)
18	REC42461A1	42461A1	CASQUILLO	SLEEVE / RING KIT	GHIERA	BAGUE
19	REC26-43035	26-43035	RETÉN INFERIOR	SEAL LOWER	TENUTA INFERIORE	JOINT SPI INFERIEUR
20	REC26-43036	26-43036	RETÉN SUPERIOR	SEAL UPPER	TENUTA SUPERIORE	JOINT SPI SUPÉRIEUR
21	REC27-430472	27-43047-2	JUNTA	GASKET	GUARNIZIONE	JOINT
22	REC26-43035	26-43035	RETÉN ACEITE	OIL SEAL	PARAOLIO	JOINT SPI
23	REC26-43036	26-43036	RETÉN ACEITE	OIL SEAL	PARAOLIO	JOINT SPI
24	REC43055A4	43055A4	BASE BOMBA	PUMP BASE	BASE POMPA	BASE POMPE À EAU
25	REC27-430331	27-43033-1	JUNTA	GASKET	GUARNIZIONE	JOINT
26	REC8172761	817276-1	TAPA BOMBA	OUTER PLATE	COPERCHIO POMPA	PLAQUE DE POMPE A EAU
27	REC27-8172771	27-817277-1	JUNTA	GASKET	GUARNIZIONE	JOINT
28	REC28-8M0032833	28-43037	CHAVETA	KEY	CHIAVETTA	CLAVETTE
29	REC47-43026Q02	47-43026T2	IMPULSOR	IMPELLER	GIRANTE	TURBINE
30	REC817275A2	817275A2	BOMBA AGUA	WATER PUMP ASSEMBLY	POMPA ACQUA	POMPE D'EAU
31	REC43023	43023	TUBO AGUA (BLANCO)	WATER TUBE SEAL (WHITE)	TUBO ACQUA (BIANCO)	TUBE D'EAU (BLANCHE)
	REC43023-2	43023-2	TUBO AGUA (NEGRO)	WATER TUBE SEAL (BLACK)	TUBO ACQUA (NERO)	TUBE D'EAU (NOIR)
32	REC10-82684430	10-826844-30	TORNILLO	SCREW	VITE	VIS
33	REC15-44491A1	15-44491A1	KIT SUPLEMENTOS	SHIM SET	KIT SUPPLEMENTI	KIT ENTRETOISES
34	REC31-30894A1	31-30894A1	COJINETE	BEARING	CUSCINETTO	ROULEMENT
35	REC31-30895T	31-30895	COJINETE	BEARING	CUSCINETTO	ROULEMENT
36	REC850315A1	850315A1	KIT MUELLE BULON	SPRING PENCIL KIT	KIT MOLLE BULLONI	KIT BOULON DE RESSORT
37	REC52-850048T	52-850048T	SELECTOR (6 DIENTES)	CLUTCH DOG (6 JAW)	SELETTORE (6 DENTI)	CRABOT (6 DENTS)
38	REC17-8M0084681	17-30632	PASADOR	CROSS PIN	CHIAVETTA	PIN
39	REC24-30893	24-30893	MUELLE	SPRING	MOLLA	RESSORT
40	REC44-12238T	44-12238T	EJE HÉLICE (3 DIENTES)	PROP SHAFT (3 JAW)	ASSE ELICA (3 DENTI)	ARBRE D'HÉLICE (3 DENTS)
	REC44-850308	44-850308	EJE HÉLICE (6 DIENTES)	PROP SHAFT (6 JAW)	ASSE ELICA (6 DENTI)	ARBRE D'HÉLICE (6 DENTS)
41	REC310414	25-97386	ARO TÓRICO	O-RING	O-RING	TORIQUE
42	REC31-12576	31-12576	COJINETE	THRUST BEARING	CUSCINETTO	ROULEMENT
43	REC12-12577	12-12577	ARANDELA	THRUST WASHER	RONDELLA	RONDELLE
44	REC31-12578T	31-12578T	COJINETE	BEARING	CUSCINETTO	ROULEMENT
45	REC12596T2	12596T2	COJINETE DIÁBOLO	BEARING CARRIER	CUSCINETTO	DIABOLO
46	REC387247	31-30956	COJINETE	BEARING	CUSCINETTO	ROULEMENT
47	REC26-76868	26-76868	RETÉN ACEITE	OIL SEAL	PARAOLIO	JOINT SPI
48	REC12-855941	12-855941	ARANDELA	WASHER	RONDELLA	RONDELLE
49	REC11-401378	11-401378	TUERCA	NUT	DADO	ÉCROU
50	REC26-70081	26-70081	RETÉN ACEITE	OIL SEAL	PARAOLIO	JOINT SPI
51	REC13191Q01	13191A1	TOPE HÉLICE	THRUST HUB	FERMO PER ELICA	RONDELLE BUTÉE D'HÉLICE
52	REC90508-ZW1-003	14-816629Q	CIERRE HÉLICE	TAB WASHER	CHIUSURA ELICA	RONDELLE FREIN
53	REC90301-ZW1-003	11-52407Q1	TUERCA HÉLICE	PROP NUT	DADO ELICA	ÉCROU D'HÉLICE
			CONTRA ROTACIÓN	COUNTER ROTATION	CONTRO ROTANTE	CONTRE ROTATION
54	REC12-815481	815481	COJINETE	BEARING	CUSCINETTO	ROULEMENT
55	REC26-888483	888483	RETÉN	OIL SEAL	PARAOLIO	JOINT SPI

4T 135-300 HP VERADO 4 et 6 CYL 2006+
STROKES

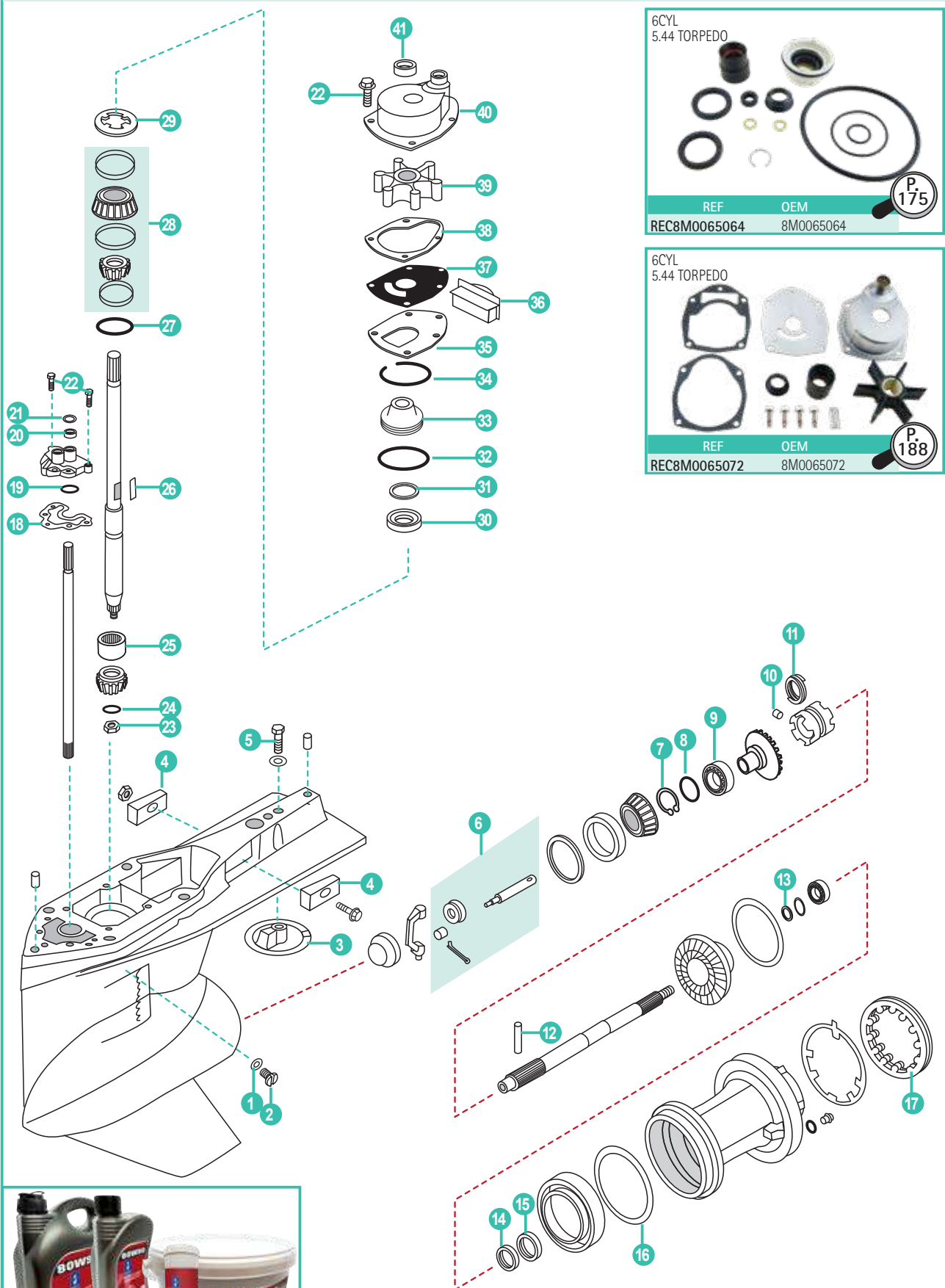

	REF	OEM				
1	REC26-830749	26-830749	JUNTA	GASKET	GUARNIZIONE	JOINT DE VIDANGE
2	REC10-79953Q04	10-79953Q04	TORNILLO	BOLT	VITE	VIS DE VIDANGE
3	CM76214	76214Q5	ÁNODO	ANODIC PLATE	ANODO	ANODE
	CM762145A	76214Q5	ÁNODO ALUMINIO	ANODIC PLATE ALUMINUM	ANODO ALLUMINIO	ANODE ALUMINIUM
4	CM826134A	826134Q	ÁNODO ALUMINIO	ANODE ALUMINUM	ANODO ALLUMINIO	ANODE ALUMINIUM
	CM826134	826134Q	ÁNODO	ANODE	ANODO	ANODE
5	REC10-806327	10-806327	TORNILLO	SCREW	VITE	VIS
6	REC19755T7	19755T7	EJE KIT	SHIFT SPOOL	KIT ASSE	KTI ARBRE
7	REC53-8M0051043	53-8M0051043	CLIP	CLIP	CLIP	CLIP
8	REC8M0053823	8M0053823	ARANDELA	WASHER	RONDELLA	RONDELLE
9	REC31-884325T01	31-884325T01	RODAMIENTO	BEARING	CUSCINETTO	ROULEMENT
10	REC17-828356	17-828356	PASADOR	DETENT PIN	CHIAVETTA	PIN
11	REC24-30893	24-30893	MUELLE	SPRING	PERNO DI FERMO	RESSORT
12	REC17-8M0084681	17-30632	PASADOR	CROSS PIN	SPINOTTO	PIN
13	REC23-891919001	23-891919001	ESPACIADOR	SPACER	SPESSORE	ENTRETOISE
14	REC26-888483	26-888906	RETÉN ACEITE	OIL SEAL	PARAOLIO	JOINT SPI
15	REC26-888483	26-888483	RETÉN ACEITE	OIL SEAL	PARAOLIO	JOINT SPI
16	REC25-31534	26-896524	ARO TÓRICO	O-RING	O-RING	JOINT TORIQUE
17	REC8M2011027	79448	TUERCA CIERRE COLA	COVER NUT	RONDELLA CHIUSURA PIEDE	ÉCROU À CRENAUX POUR EMBASE
18	REC27-880729	27-880729	JUNTA	GASKET	GUARNIZIONE	JOINT
19	REC25-36318	25-896322	ARO TÓRICO	O-RING	O-RING	JOINT TORIQUE
20	REC26-8164641	26-816464-1	RETÉN ACEITE	OIL SEAL	PARAOLIO	JOINT SPI
21	REC12-77674	12-77674	ARANDELA	WASHER	RONDELLA	RONDELLE
22	REC10-816928	10-816928	TORNILLO M6X16	SCREW M6X16	VITE M6X16	VIS M6X16
23	REC11-35921	11-35921	TUERCA	NUT	DADO	ÉCROU
24	REC350038	12-92721	ARANDELA	WASHER	RONDELLA	RONDELLE
25	REC387817	31-42647A1	COJINETE	BEARING	CUSCINETTO	ROULEMENT
26	REC28-8M0032833	28-43037	CHAVETA	KEY	CHIAVETTA	CLAVETTE
27	REC15-38657A1	15-38657A1	SUPLEMENTOS	SHIM KIT	KIT SUPPLEMENTI	KIT ENTRETOISE
28	REC15-884327A02	15-884327A01	KIT RODAMIENTOS	BEARING KIT	KIT CUSCINETTO	KIT ROULEMENT
29	REC8245191	824519-1	RETENEDOR	RETAINER	RITENITORE	RETENUE
30	REC26-888921	26-888921	RETÉN ACEITE	OIL SEAL	PARAOLIO	JOINT SPI
31	REC26-888920	26-888920	RETÉN ACEITE	OIL SEAL	PARAOLIO	JOINT SPI
32	REC25-896523	25-896523	ARO TÓRICO	O-RING	O-RING	JOINT TORIQUE
33	REC8M0007131	888909A1	BASE BOMBA	PUMP BASE	BASE POMPA	BASE DE POMPE EAU
34	REC53-880719	53-880719	ARO RETENEDOR	RETAINING RING	FASCIA RITENITORA	CLIPS
35	REC27-430331	27-43033-1	JUNTA	GASKET	GUARNIZIONE	JOINT
36	REC821526001	821526001	RETEN DE GOMA	FILLER BLOCK	PARAOLIO GOMA	PROTECTION CAOUTCHOUC
37	REC8172761	817276-1	TAPA BOMBA	WEAR PLATE	COPERCHIO POMPA	PLAQUE DE POMPE
38	REC27-8172771	27-817277-1	JUNTA	GASKET	GUARNIZIONE	JOINT
39	REC47-43026Q02	47-43026T2	IMPULSOR	IMPELLER	GIRANTE	TURBINE
40	REC817275A1	817275A1	CUERPO BOMBA	PUMP HOUSING	CORPO POMPA	CORPS DE POMPE A EAU
41	REC26-816575A2	26-816575A2	RETÉN	OIL SEAL	PARAOLIO	JOINT SPI

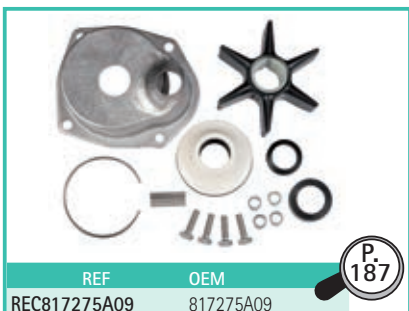

4T 175, 200, 225 HP (3.4L) V6 V8 NEW MODELS
 STROKES Ø TORPEDO 5.44

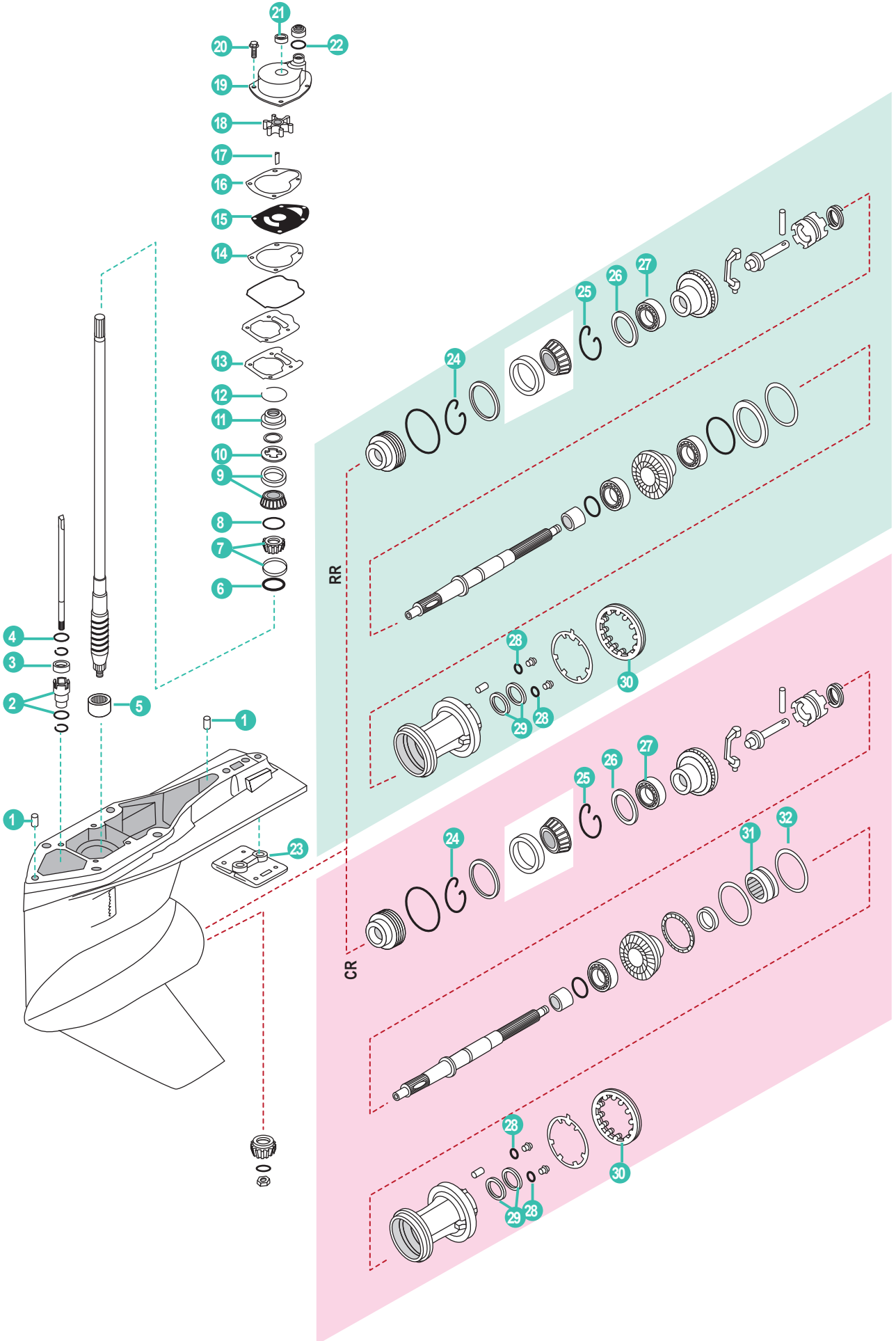

	REF	OEM				
1	REC17-43043	8M0084244	PIN	PIN	SPINOTTO	PIN
2	REC23-8M0142859	23-8M0142859	BUJE DESIGN I	BUSH DESIGN I	BOCCOLA DESIGN I	BAGUE DESIGN I
	REC23-8M0164967	23-8M0164967	BUJE DESIGN II	BUSH DESIGN II	BOCCOLA DESIGN II	BAGUE DESIGN II
3	REC26-8164641	8164641	RETÉN ACEITE	OIL SEAL	PARAOLIO	JOINT SPI
4	REC12-77674	77674	ARANDELA	WASHER	RONDELLA	RONDELLE
5	REC387247	42647A1	COJINETE	BEARING	CUSCINETTO	ROULEMENT
6	REC15-38657A1	8M0063268	GRUESO	SHIM	SPESSORE	CALE
7	REC31-77420A1	8M0146553	COJINETE	BEARING	CUSCINETTO	ROULEMENT
8	REC15-42637A1	8M0063267	GRUESO	SHIM	SPESSORE	CALE
9	REC31-36387A1	8M0146566	COJINETE	BEARING	CUSCINETTO	ROULEMENT
10	REC8245191	8245191	RETENEDOR	RETAINER	RITENITORE	RETENUE
11	REC8M0046297	8M0046297	BASE BOMBA AGUA	WATER PUMP BASE	BASE POMPA ACQUA	BASE DE POMPE A EAU
12	REC53-880719	880719	ARO RETENEDOR	RETAINING RING	FASCIA RITENITORA	CLIPS
13	REC27-8M0146938	8M0146938	JUNTA BASE BOMBA	PUMP BASE, GASKET	GUARNIZIONE BASE POMPA	JOINT BASE DE POMPE
14	REC27-8M0142616	8M0112903	JUNTA	GASKET	GUARNIZIONE	JOINT
15	REC8172761	8172761	PLACA	PLATE	PIASTRA	PLAQUE
16	REC27-8172771	8172771	JUNTA	GASKET	GUARNIZIONE	JOINT
17	REC28-8M0032833	8M0032833	CHAVETA	KEY	CHIAVETTA	CLAVETTE
18	REC47-43026Q02	43026T2	IMPULSOR	IMPELLER	GIRANTE	TURBINE
19	REC817275A1	817275A1	KIT BOMBA	WATER PUMP KIT	KIT POMPA ACQUA	KIT POMPE À EAU
20	PAGB/T5787-M6X20	1993720	TORNILLO M6X20	BOLT M6X20	VITE M6X20	VIS M6X20
21	REC26-8M0142851	26-8M0142851	RETÉN	RETAINER	RITENITORE	RETENUE
22	REC25-21836	21836	TÓRICA	O-RING	O-RING	JOINT TORIQUE
23	REC97-8M0137814AL	97-8M0137814	ÁNODO	ANODE	ANODO	ANODE
24	REC53-880719	880719	RETENEDOR	RETAINER	RITENITORE	RETENUE
25	REC53-8M0051043	8M0051043	RETENEDOR	RETAINER	RITENITORE	RETENUE
26	REC8M0053823	8M0053823	ARANDELA	WASHER	RONDELLA	RONDELL
27	REC31-884325T01	8M0142835	COJINETE	BEARING	CUSCINETTO	ROULEMENT
28	REC26-830749	830749	RETENEDOR	RETAINER	RITENITORE	RETENUE
29	REC26-888483	888483	RETÉN ACEITE	OIL SEAL	PARAOLIO	JOINT SPI
30	REC8M2011027	8M2000347	RETENEDOR	RETAINER	RITENITORE	RETENUE

			CONTRA ROTACIÓN	COUNTER ROTATION	CONTRO ROTANTE	CONTRE ROTATION
31	REC31-814653T	814653T	COJINETE	BEARING	CUSCINETTO	ROULEMENT
32	REC25-8M0142840	25-8M0142840	TÓRICA (TORPEDO 4.80)	O-RING (TORPEDO 4.80)	O-RING (TORPEDO 4.80)	TORIQUE (TORPEDO 4.80)
	REC25-8M0000190	25-8M0000190	TÓRICA (TORPEDO 5.44)	O-RING (TORPEDO 5.44)	O-RING (TORPEDO 5.44)	TORIQUE (TORPEDO 5.44)



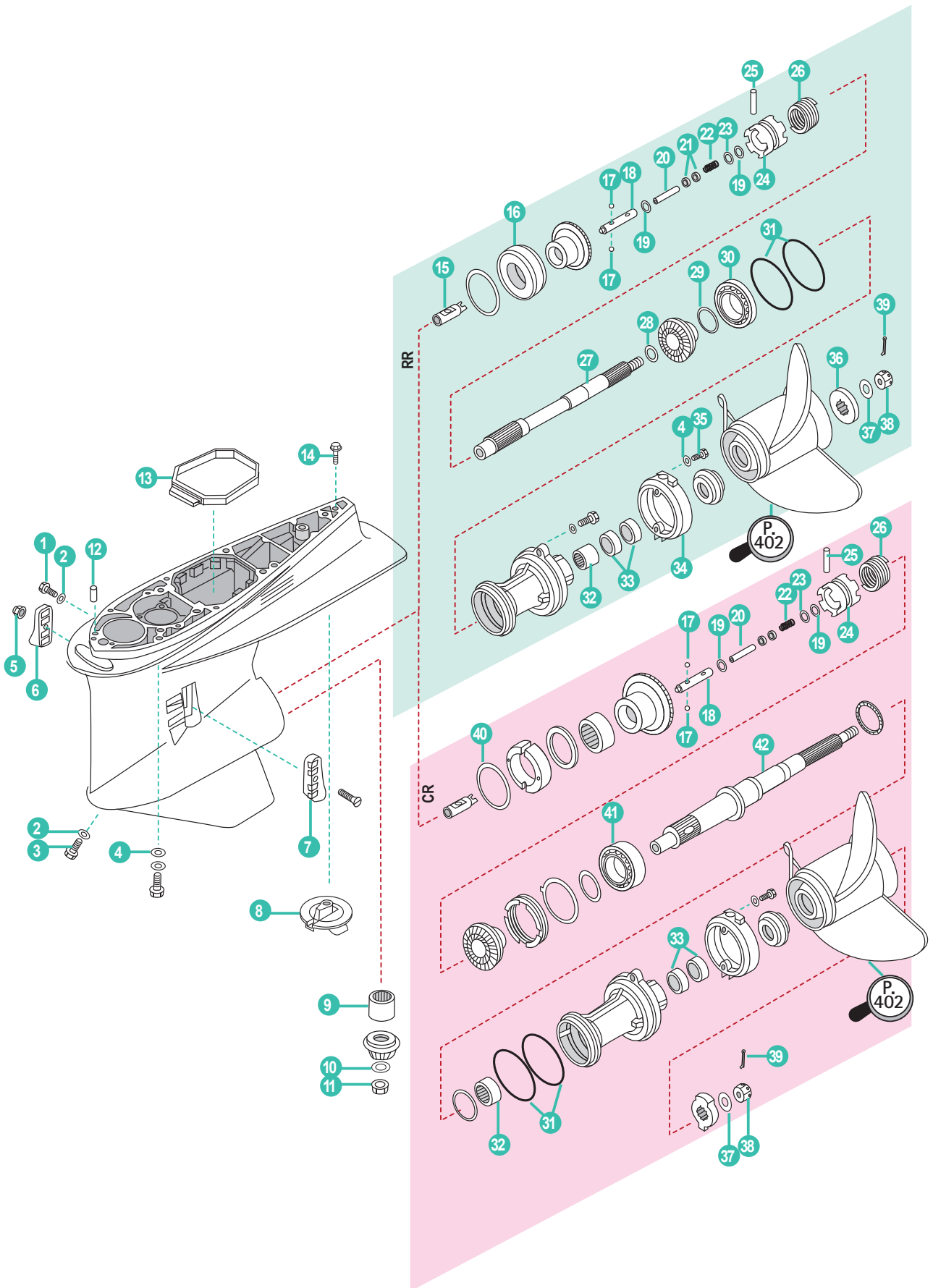

	REF	OEM				
	REC421-B25F	1623-888680T06	CONJUNTO INFERIOR RR (X)	COMPLETE GEARCASE RR (X)	PIEDE COMPLETO RR (X)	EMBASE COMPLETE (X)
	REC421-B30F	1623-888680T07	CONJUNTO INFERIOR RR (XL)	COMPLETE GEARCASE RR (XL)	PIEDE COMPLETO RR (XL)	EMBASE COMPLETE (XL)
	REC428-B25F	1623-888680T08	CONJUNTO INFERIOR CR (L)	COMPLETE GEARCASE CR (L)	PIEDE COMPLETO CR (L)	EMBASE COMPLETE CR (L)
	REC428-B30F	1623-888680T09	CONJUNTO INFERIOR CR (XL)	COMPLETE GEARCASE CR (XL)	PIEDE COMPLETO CR (XL)	EMBASE COMPLETE CR (XL)
1	REC90340-08002	81924M	TORNILLO DRENAJE	BOLT, DISCHARGING OIL	VITE DRENAGGIO	BOUCHON DE VIDANGE
2	REC90430-08020	81987	JUNTA	GASKET	GUARNIZIONE	JOINT
3	REC688-45341-00	95632M	TORNILLO DRENAJE	BOLT, DISCHARGING OIL	VITE DRENAGGIO	BOUCHON DE VIDANGE
4	PAGB/T97.1-8	814576M	ARANDELA	WASHER	RONDELLA	RONDELLE
5	PAGB/T6182-M5	8528165	TUERCA	LOCK NUT	DADO	ÉCROU
6	REC61A-45215-10	8887101	REJILLA TOMA AGUA ESTRIBOR	WATER SCREEN STARBOARD	GRIGLIA PRESA ACQUA TRIBORDO	GRILLE D'ENTREE D'EAU TRIBORD
7	REC61A-45214-10	888710	REJILLA TOMA AGUA BABOR	WATER SCREEN PORT	GRIGLIA PRESA ACQUA BABORDO	GRILLE D'ENTREE D'EAU BABORD
8	CM61A-45371-00A	888712	ÁNODO	ANODE	ANODO	ANODE
9	REC93311-83280	888681	COJINETE	BEARING	CUSCINETTO	ROULEMENT
10	REC90201-16M00	88838012	ARANDELA	WASHER	RONDELLA	RONDELLE
11	REC90170-16M19	8813141	TUERCA	LOCK NUT	DADO	ÉCROU
12	REC93608-12M05	8886631	PASADOR	PIN	SPINOTTO	PIN
13	REC69J-45375-00	8886653	GOMA ESCAPE COLA	EXHAUST DAMPER	GOMMA SCARICO	JOINT D'ÉCHAPPEMENT
14	PAT85-00000012	82801M	TORNILLO	SCREW	VITE	VIS
15	REC61A-45641-02	888700	CAMBIO	SHIFTER	CAMBIO	SHIFTER
16	REC93332-000W1	8886811	COJINETE	BEARING	CUSCINETTO	ROULEMENT
17	REC93501-04011	82346M	ESFERA	BALL	SFERA	BILLE
18	REC61A-45634-01	888701	PASADOR DESPLAZABLE	SLIDE SHIFT	SPINOTTO SCORREVOLE	PIN REGLABLE
19	REC90183-02M03	8813142	TUERCA DE RESORTE	SPRING NUT	DADO MOLLA	RONDELLE FREIN
20	REC6H1-45668-00	888704	EJE	FREE SHAFT	ASSE	ARBRE
21	REC61A-45635-00	888705	ÉMBOLO DE CAMBIO	SHIFT PLUNGER	GOMMINI	SHIFT
22	REC90501-10M77	8887031	RESORTE DE COMPRESIÓN	SPRING	MOLLA	RESSORT
23	REC90201-02M00	8043051	ARANDELA PLANA	WASHER	RONDELLA	RONDELLE
24	REC69J-45631-00	888702	EMBRAGUE DE GARRA	CLUTH	SELETORE	CRABOT
25	REC61A-45632-00	8886331	PASADOR	PIN	SPINOTTO	LEVIER
26	REC61A-45633-00	888703	ANILLO DEL PASADOR	ANNULAR SPRING, CLUTCH	ANELLO	RESSORT
27	REC69J-45611-00	888699	EJE	SHAFT	ASSE	ARBRE D'HELICE
28	REC90201-31M00	8043052	ARANDELA PLANA	WASHER	RONDELLA	RONDELLE
29	REC61A-45577-00/60-0	888714A1	KIT GRUESOS (0.10-0.50 mm)	KIT SHIM (0.10-0.50 mm)	KIT SPESSORE (0.10-0.50 mm)	KIT CALES (0.10 - 0.50 mm)
30	REC93306-210U0	8886814	COJINETE	BEARING	CUSCINETTO	ROULEMENT
31	REC93211-04384	8814373	TÓRICA	O-RING	O-RING	JOINT TORIQUE
32	REC93315-43061	8886815	COJINETE	BEARING	CUSCINETTO	ROULEMENT
33	REC93101-30M17	8886941	RETÉN DE ACEITE	OIL SEAL	PARAOILIO	JOINT SPI
34	REC69J-45361-00-8D	888708	FUNDA INFERIOR	CAO LOWER CASING	COVER INFERIORE	COUVERCLE INFERIEUR
35	PAF4-04000001	881816	PERNO	STUD	BULLONE	BOULON
36	REC688-45997-00	8539481	ESPACIADOR AP	DISTANCE WASHER	DISTANZIALE	BRIDE
37	REC92990-18200	887972	ARANDELA PLANA	WASHER	RONDELLA	RONDELLE
38	REC90171-18M04	887973	TUERCA	LOCK NUT	DADO	ÉCROU
39	REC91490-30025	887974	PASADOR	PIN	SPINOTTO	CLAVETTE

			CONTRA ROTACIÓN	COUNTER ROTATION	CONTRO ROTANTE	CONTRE ROTATION
40	REC61A-45567-00/60-0	888713A1	KIT GRUESOS (0.10-0.50 mm)	KIT SHIM (0.10-0.50 mm)	KIT SPESSORE (0.10-0.50 mm)	KIT CALES (0.10 - 0.50 mm)
41	REC93332-00048	8886819	COJINETE	BEARING	CUSCINETTO	ROULEMENT
42	REC69K-45611-00	88869910	EJE	SHAFT	ASSE	ARBRE D'HELICE

4T 225 EFI (0T653945+)
STROKES

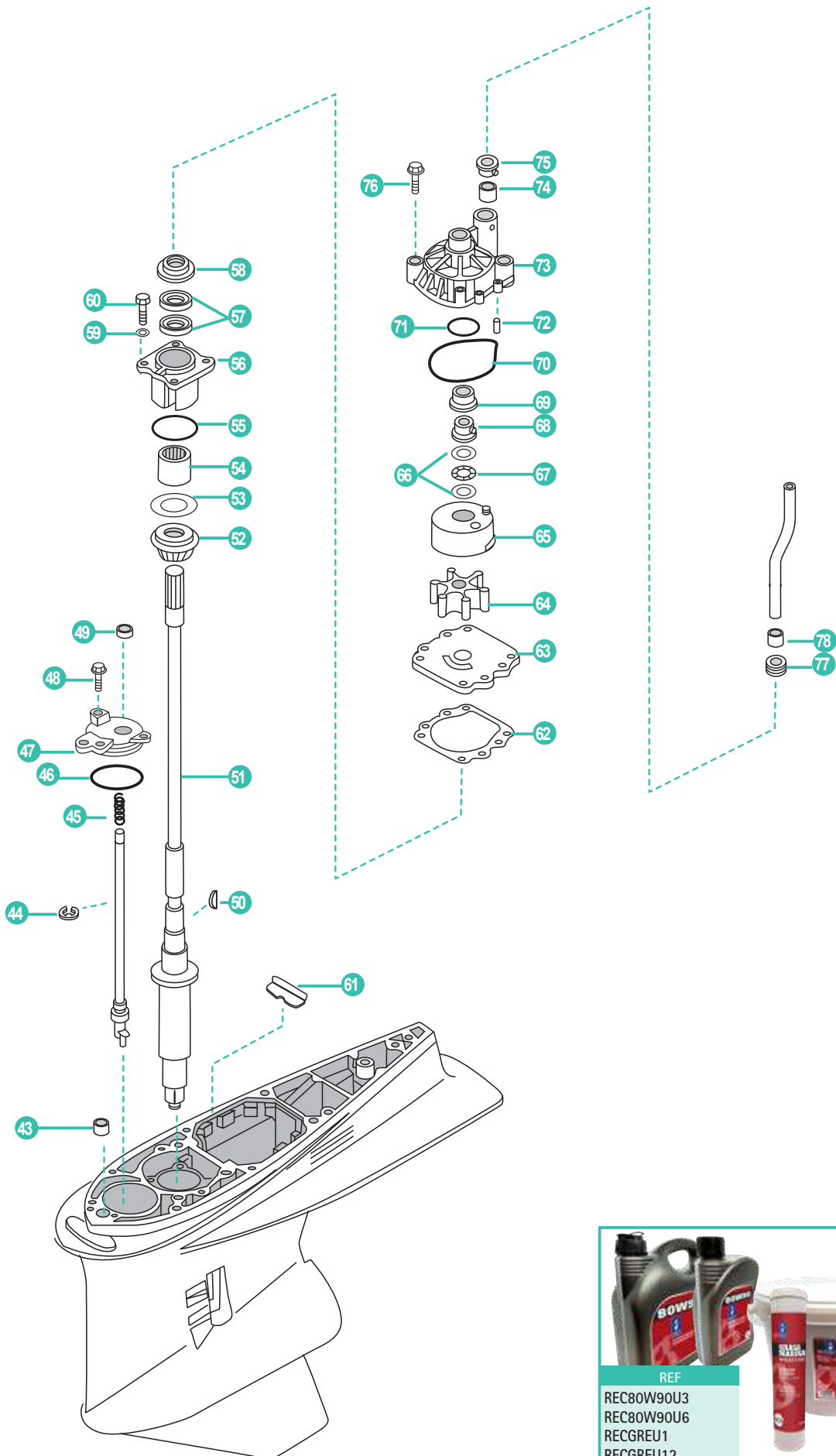

	REF	OEM				
43	REC663-44366-00	81426M	RETEN TUBO AGUA	DAMPER, WATER SEAL	GHIERA	JOINT DE TUBE D'EAU
44	REC99001-08600-00	82334M	CLIP	CLIP	CLIP	CLIP
45	REC90501-11M10-00	8266901	RESORTE DE COMPRESIÓN	SPRING	MOLLA	RESSORT
46	REC93210-65752-00	8255791	TÓRICA	O-RING	O-RING	JOINT TORIQUE
47	REC61A-45321-01	888683	TAPA CAMBIO	SHIFT SHAFT COVER	SHIFT SHAFT COVER	COUVERCLE ARBRE DE TRANSMISSION
48	REC90119-06M10	85277616	TORNILLO CON ARANDELA	SCREW WITH WASHER	VITE CON RONDELLA	VIS AVEC RONDELLE
49	REC93106-09014	82257M	RETÉN DE ACEITE	OIL SEAL	PARAOLIO	ROULEMENT
50	REC90280-04M05	8813421	CUÑA	KEY WOODRUFF	CHIAVETTA	CLAVETTE
51	REC63P-45501-00	888696	EJE TRASMISION 20"	DRIVE SHAFT 20"	ALBERO DI TRASMISSIONE 20"	ARBRE TRASMISION 20"
	REC63P-45501-10	8886961	EJE TRASMISION 25"	DRIVE SHAFT 25"	ALBERO DI TRASMISSIONE 25"	ARBRE TRASMISION 25"
52	REC93341-93020	8886813	COJINETE	BEARING	CUSCINETTO	CLAVETTE
53	REC61A-45587-00/60-0	888715A1	KIT GRUESOS (0.10-0.50 mm)	KIT SHIM (0.10-0.50 mm)	KIT SPESSORE (0.10-0.50 mm)	KIT CALES (0.10 - 0.50 mm)
54	REC93317-330U2	8886812	COJINETE	BEARING	CUSCINETTO	ROULEMENT
55	REC93210-54534	8814372	TÓRICA	O-RING	O-RING	JOINT TORIQUE
56	REC61A-45331-00-94	888693	DIÁBOLO	GEAR HOUSING	DIABOLO	DIABOLO
57	REC93101-28M16	888694	RETÉN DE ACEITE	OIL SEAL	PARAOLIO	JOINT SPI
58	REC6E5-45344-00	888695	CUBIERTA SELLO DE ACEITE	RETAINER	COPERCHIO PARAOLIO	RETENUE
59	PAGB/T97.1-8		ARANDELA	WASHER	RONDELLA	RONDELLE
60	PAGB/T5783-M8X25	8878272	PERNO	STUD	BULLONE	BOULON
61	REC61A-45376-00-94	888682	GUÍA SELLO DE GOMA	GUIDE	GUIDE	GUIDE
62	REC6E5-44315-A0	888692	JUNTA	GASKET	GUARNIZIONE	JOINT
63	REC6G5-44323-00	888691	TAPA BOMBA	OUTER PLATE	COPERCHIO POMPA	PLAQUE DE POMPE À EAU
64	REC6E5-44352-01	888689	TURBINA	IMPELLER	GIRANTE	TURBINE
65	REC61A-44322-02	888687	TAPA, BOMBA AGUA	COVER, INNER WATER PUMP	COPERCHIO, POMPE ACQUA	INSERT DE POMPE À EAU
66	REC90201-22M01	8883632	ARANDELA	WASHER	RONDELLA	RONDELLE
67	REC90206-22M19	8556822	ARANDELA ONDULADA	WAVE WASHER	RONDELLA ONDULATA	RONDELLE
68	REC61A-45538-00	888690	ESPACIADOR	SPACER	SPESSORE	ENTRETOISE
69	REC61A-45527-00	8886901	CASQUILLO CUERPO BOMBA	COLLAR	BOCCOLA CORPO POMPA	BAGUE POMPE À EAU
70	REC93210-86M38	8255792	TÓRICA	O-RING	O-RING	JOINT TORIQUE
71	REC93210-37160	8814371	TÓRICA	O-RING	O-RING	JOINT TORIQUE
72	REC93606-12019	82364M	PASADOR	PIN	SPINOTTO	PIN
73	REC61A-44311-00	888686T	CUERPO BOMBA AGUA	HOUSING, WATER PUMP	CORPO POMPA	CORPS DE POMPE À EAU
74	REC6E5-44365-00	8886652	GOMA DEL SELLO DE AGUA	DAMPER WATER TUBE	GUARNIZIONE	BAGUE DE TUBE D'EAU
75	REC6E5-44312-00	888688	CUBIERTA CAJA DE BOMBA DE AGUA	WATER PUMP COVER	COPERCHIO POMPA ACQUA	BAGUE DE POMPE À EAU
76	REC90119-08M14	8814231	TORNILLO CON ARANDELA	SCREW WITH WASHER	VITE CON RONDELLA	VIS AVEC RONDELLE
77	REC6E5-44366-00	8886651	GOMA DEL SELLO DE AGUA	DAMPER WATER TUBE	GUARNIZIONE	BAGUE DE TUBE D'EAU
78	REC6E5-44365-00	8886652	GOMA TUBO AGUA	DAMPER WATER TUBE	GOMMA TUBO ACQUA	BAGUE DE TUBE D'EAU



DESPIECE COLAS
2 TIEMPOS

GEAR CASE PARTS
2 STROKES

PARTI PIEDI
DE 2 TEMPI

PIECES D'EMBASES DE 2
TEMPS

2T 2 HP
STROKES 2B - (6A1-000101+)

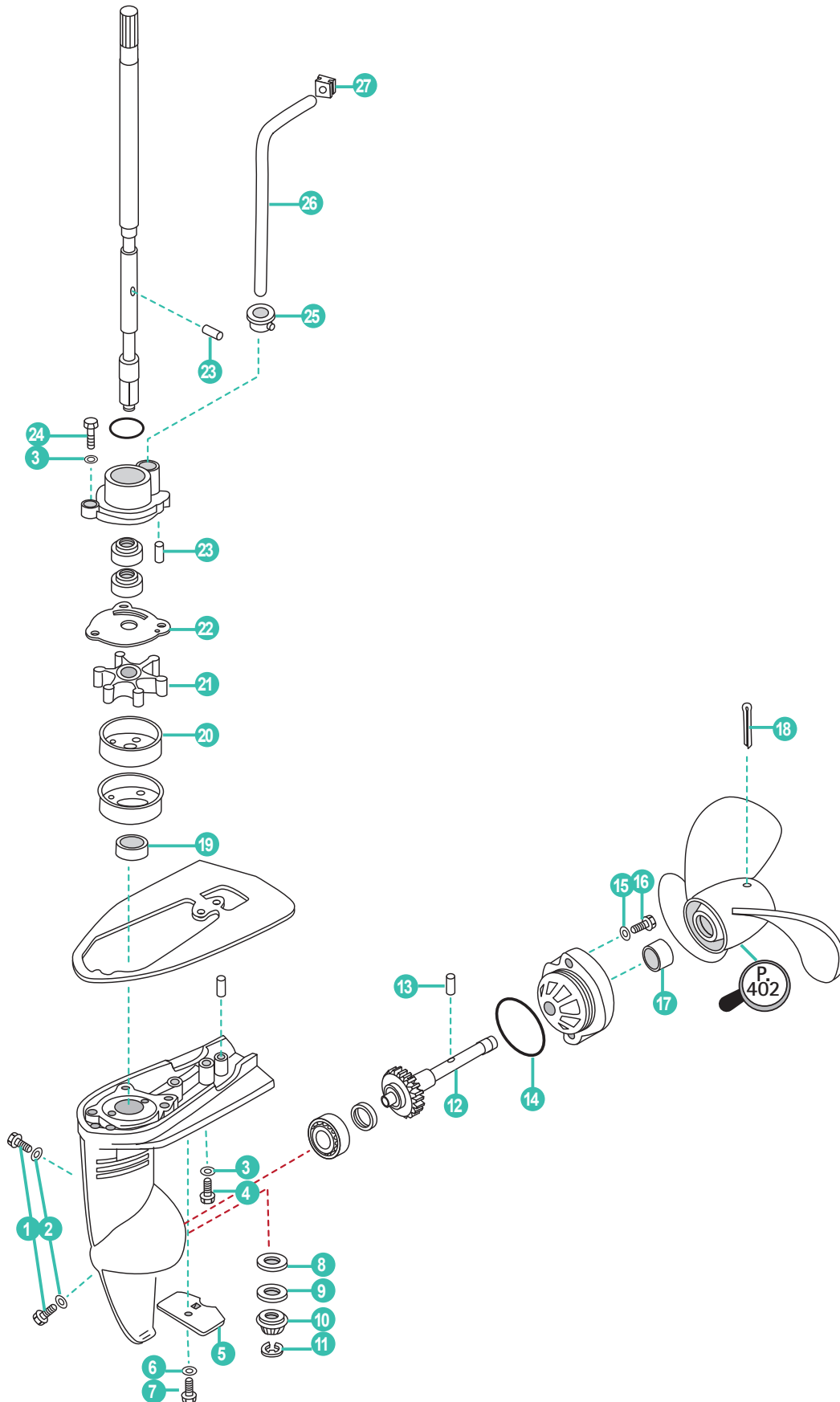

	REF	OEM				
1	REC90340-08002	22-81924M	TORNILLO DRENAJE	BOLT, DISCHARGING OIL	VITE DRENAGGIO	BOUCHON DE VIDANGE
2	REC90430-08020	27-81987M	JUNTA	GASKET	GUARNIZIONE	JOINT DE VIDANGE
3	PAGB/T97.1-8	12-82214M	ARANDELA	WASHER	RONDELLA	RONDELLE
4	PAGB/T5783-M6X30	10-83285M	TORNILLO	BOLT	VITE	VIS
5	CM6L5-45251-02	810945M	ÁNODO ZINC	ANODE	ANODO ZINCO	ANODE
6	PAGB/T861.1-87	12-82214M	ARANDELA	WASHER	RONDELLA	RONDELLE
7	PAGB/T5783-M6X35	10-91772M	TORNILLO	BOLT, FLANGE	VITE	VIS
8	PAF2.6-03000017	12-80404M	GRUESO	SHIM	SPESSORE	CALE
9	PAF4-03000006	12-81875M	ARANDELA	WASHER	RONDELLA	RONDELLE
10	REC646-45551-00	43-80405M	PIÑÓN ATAQUE	INITIATIVE GEAR	MARCIA INIZIATIVA	PIGNON D'ATTAQUE
11	PAGB/T896-86	53-82331M	CLIP	CIRCLIP	CLIP	CLIP
12	REC646-45560-00	43-80406M	ENGRANAJE CON EJE	GEAR WITH SHAFT	IGRANAGGIO CON ASSE	PIGNON
13	REC90250-03M10	17-81896M	PASADOR SEGURIDAD	PIN	SPINOTTO	LEVIER
14	REC93210-42101	25-14175M	ARO TÓRICA	O-RING	O-RING	JOINT TORIQUE
15	PAGB/T97.1-6	12-82214M	ARANDELA	WASHER	RONDELLA	RONDELLE
16	PAGB/T5783-M6X16	10-84368M	TORNILLO	BOLT	VITE	VIS
17	REC93103-10052	26-82250M	RETÉN	OIL SEAL	PARAOLIO	JOINT SPI
18	REC91490-30040	18-82134M	PASADOR ALETAS	PIN	SPINOTTO	PIN
19	REC93103-11051	26-82251M	RETÉN	OIL SEAL	PARAOLIO	JOINT SPI
20	REC646-44322-00	80393M	CASQUILLO INOX. BOMBA	INSERT	GHIERA INOX. POMPA	INSERT DE POMPE À EAU
21	REC646-44352-01	47-80395M	IMPULSOR	IMPELLER	GIRANTE	TURBINE
22	REC646-44322-00	80394M	PLATO BOMBA AGUA	OUTER PLATE	PIASTRA POMPA ACQUA	PLAQUE DE POMPE À EAU
23	PAF2.6-03000013	17-82356M	PIN	PIN	SPINOTTO	PIN
24	PAGB/T5783-M5X16	10-92521M	TORNILLO	BOLT	VITE	VIS
25	REC646-44366-01	26-80398M	RETÉN TUBO AGUA	SEAL WATER PIPE	ANELLO TUBO ACQUA	RETENUE TUBE D'EAU
26	REC6A1-44361-00	32-80396M	TUBO AGUA	TUBE, WATER	TUBO ACQUA	TUBE D'EAU
27	REC646-44365-00	26-80397M	RETÉN TUBO DE AGUA	I-SHAPED RUBBER BAND	ANELLO TUBO ACQUA	RETENUE TUBE D'EAU



2T 2, 2.5 HP
STROKES

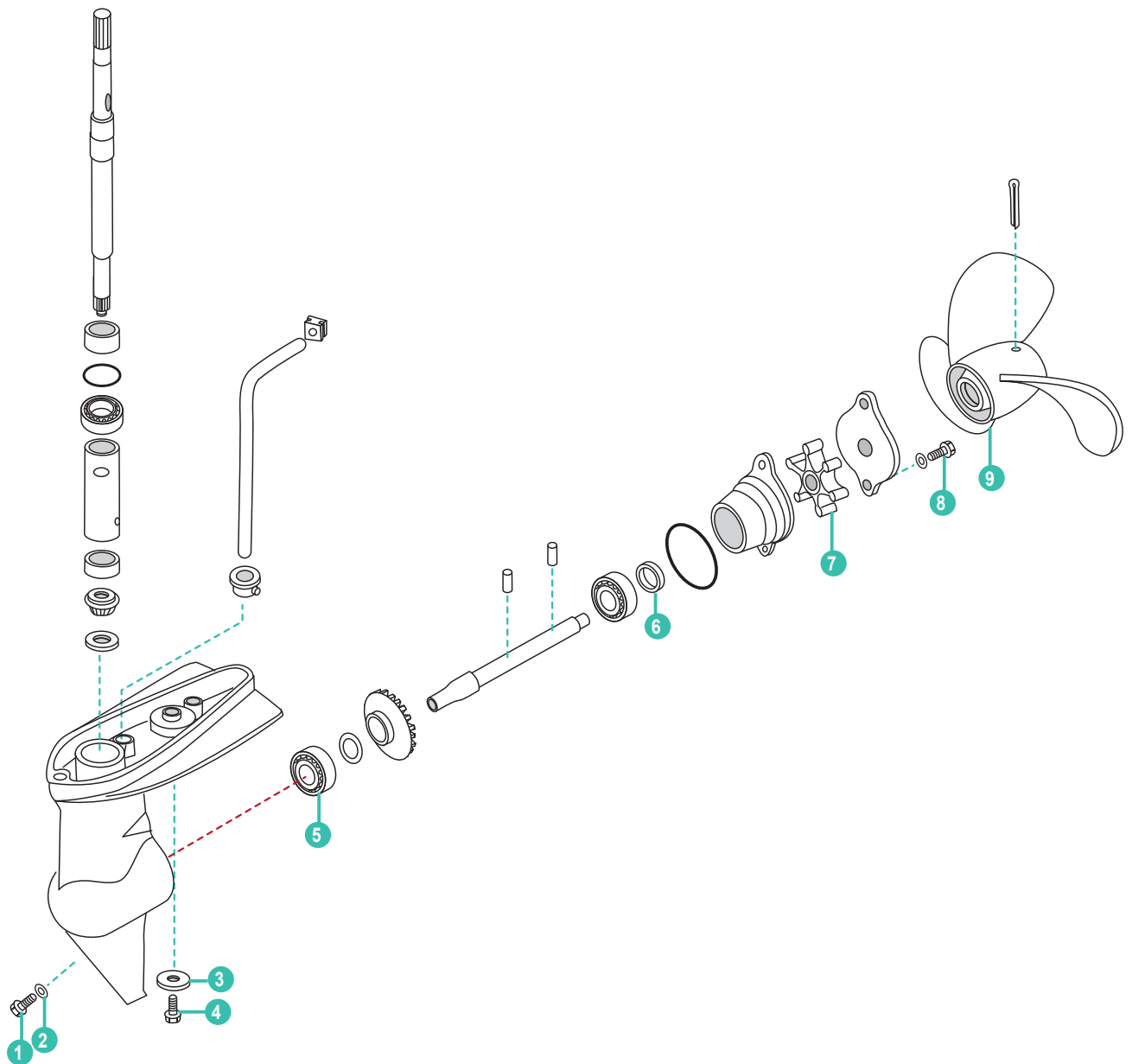

	REF	OEM				
1	REC90340-08002	953683	TORNILLO DRENAJE	BOLT, DISCHARGING OIL	VITE DRENAGGIO	BOUCHON DE VIDANGE
2	REC90430-08020	95220	JUNTA	GASKET	GUARNIZIONE	JOINT DE VIDANGE
3	TEN00824	823913Q	ÁNODO ZINC	ANODE	ANODO ZINCO	ANODE
4	PAGB/T5783-M6X16	16832	TORNILLO M6X16	BOLT M6X16	VITE M6X16	VIS M6X16
5	REC30-95347	95347	COJINETE	BEARING	CUSCINETTO	ROULEMENT
6	PAF8-04000101	95348	RETÉN ACEITE	OIL SEAL	PARAOLIO	JOINT SPI
7	REC47-952892	952892	IMPULSOR	IMPELLER	GIRANTE	TURBINE
8	PAGB/T5787-M6X20	167051	TORNILLO M6X20	BOLT M6X20	VITE M6X20	VIS M6X20
9	SOL0001-073-06P	815083	HÉLICE	PROPELLER	ELICA	HÉLICE

2T 3.9, 4, 4.5, 7.5, 9.8 HP (1975-86)
STROKES

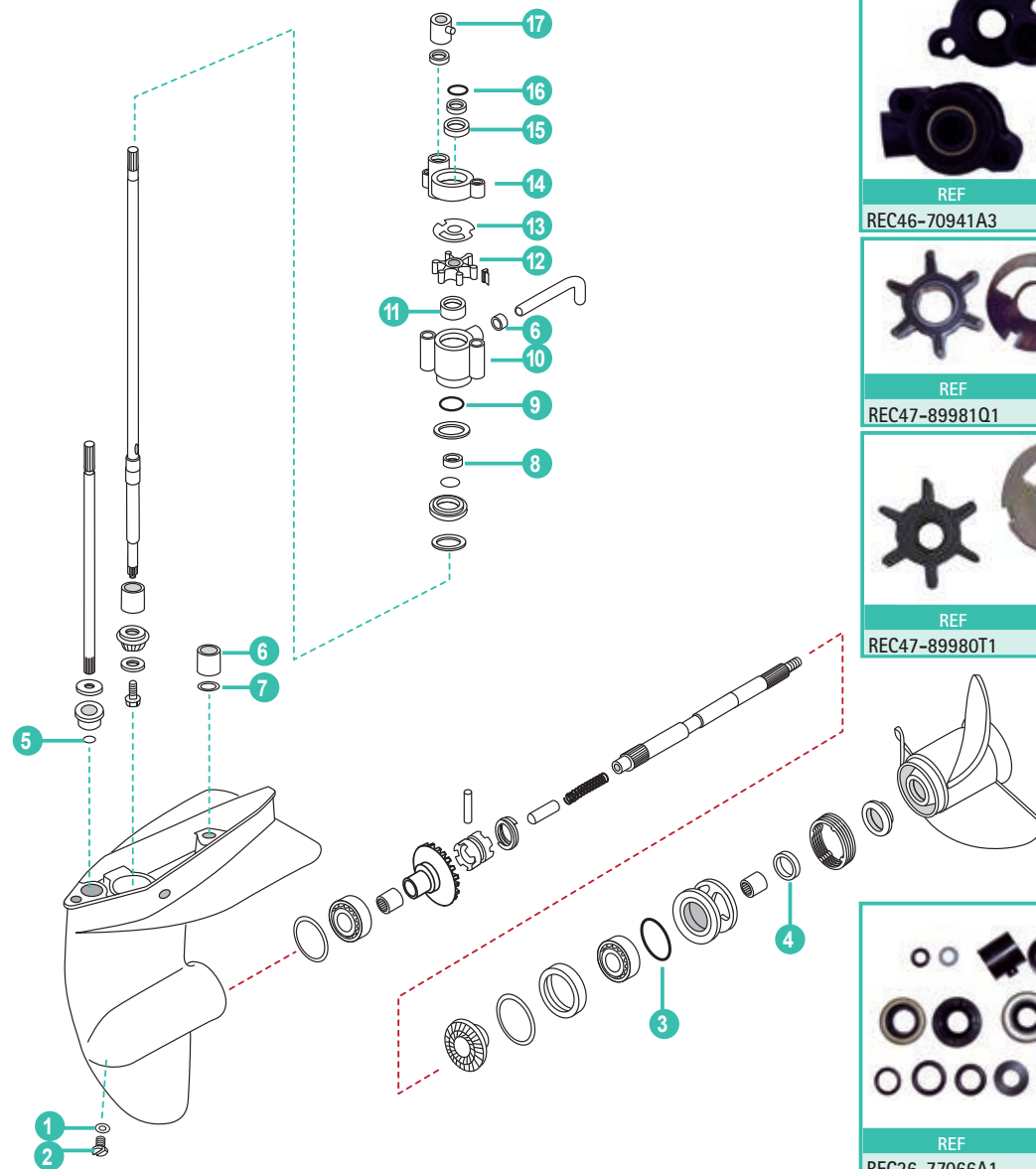

REF	OEM
REC46-70941A3	46-70941A3

REF	OEM
REC47-89981Q1	47-89981Q1

REF	OEM
REC47-89980T1	47-89980T1

REF	OEM
REC26-77066A1	26-77066A1

	REF	OEM				
1	REC12-191833	12-20260	JUNTA	GASKET	GUARNIZIONE	JOINT DE VIDANGE
2	REC10-79953Q04	10-79953Q2	JUEGO TORNILLO	SCREW SET	KIT VITE	VIS DE VIDANGE
3	REC25-30529	25-30529	ARO TÓRICO	O-RING	O-RING	JOINT TORIQUE
4	REC26-66022	26-66022	RETÉN ACEITE	OIL SEAL	PARAOLIO	JOINT SPI
5	REC303347	25-26802	ARO TÓRICO	O-RING	O-RING	JOINT TORIQUE
6	REC26-33613	26-33613	RETÉN	SEAL	TENUTA	RETIENUE
7	REC23-86215	23-86215	ESPACIADOR	SPACER	SPESSORE	ENTRETOISE
8	REC26-897153	26-96063	RETÉN ACEITE BASE BOMBA	OIL SEAL (FOR REC46-92970A1 PUMP BASE)	PARAOLIO BASE POMPA REC46-92970A1	JOINT SPI, BASE POMPA REC46-92970A1
	REC327031	26-30900	RETÉN ACEITE BASE BOMBA	OIL SEAL (FOR REC46-70941T01 PUMP BASE)	PARAOLIO BASE POMPA REC46-70941T01	JOINT SPI, BASE POMPA REC46-70941T01
9	REC309731	25-29439	ARO TÓRICO	O-RING	O-RING	TORIQUE
10	REC46-70941T01	46-70941A1	BASE BOMBA USAR CON IMPULSOR REC47-89981	PUMP BASE (USE WITH REC47-89981 IMPELLER)	BASE POMPA DA UTILIZZARE CON GIRANTE REC47-89981	BASE POMPA, USER AVEC LA TURBINE REC47-89981
11	REC70977T	70977	TAPA BOMBA	PUMP CUP	COPERCHIO POMPA	COUVERCLE POMPA
12	REC47-89980	47-89980	IMPULSOR (0.438 I.D.)	IMPELLER (0.438 I.D.)	GIRANTE (0.438 I.D.)	TURBINE (0.438 I.D.)
	REC47-89981	47-89981	IMPULSOR (0.456 I.D.)	IMPELLER (0.456 I.D.)	GIRANTE (0.456 I.D.)	TURBINE (0.456 I.D.)
13	REC46895	46895	TAPA BOMBA	WEAR PLATE	COPERCHIO POMPA	PLAQUE DE POMPE A EAU
14	REC93224A1	93224A1	CUERPO BOMBA	PUMP HOUSING	CORPO POMPA	CORPS DE POMPE A EAU
15	REC26-30913	26-30913	RETÉN ACEITE	OIL SEAL	PARAOLIO	JOINT SPI
16	REC3852045	25-62704	ARO TÓRICO	O-RING	O-RING	JOINT TORIQUE
17	REC26-36558	26-36558	GRUESO	GROMMET	SPESSORE	ENTRETOISE

2T 4 HP (6E0), 5HP (6E3)
STROKES

MERCURY MARINER

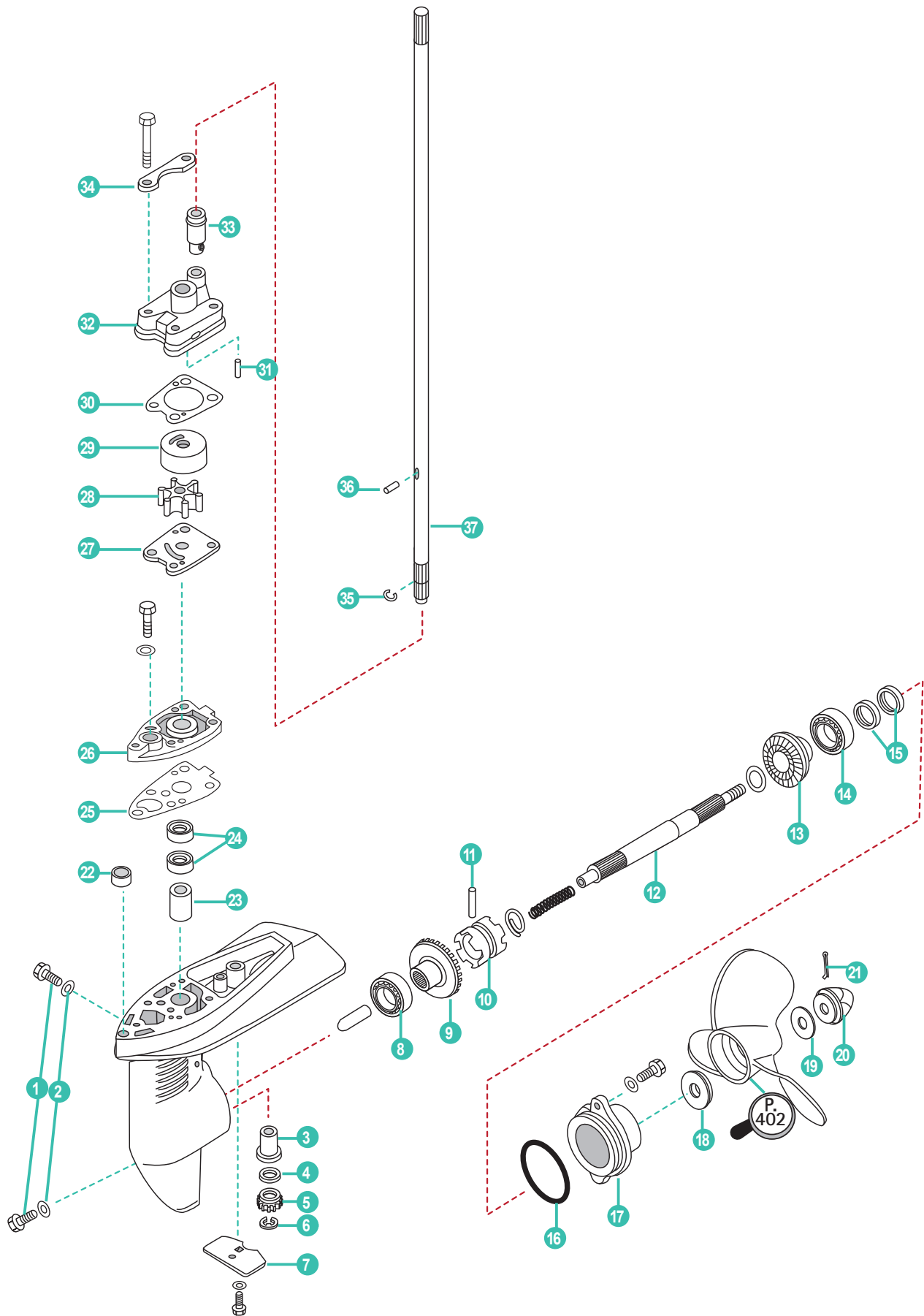

	REF	OEM				
1	REC90340-08002	22-81924M	TAPÓN ACEITE	PLUG, OIL	TAPPO OLIO	BOUCHON REMPLISSAGE D'HUILE
2	REC90430-08020	27-81987	JUNTA	GASKET	GUARNIZIONE	JOINT
3	REC6E0-45317-00	23-95477M	CASQUILLO EJE	BUSHING	CAPPUCCIO ASSE	BAGUE D'ARBRE
4	PAF4-03000006	12-96311M	ARANDELA	WASHER	RONDELLA	RONDELLE
5	REC6E0-45551-00	43-96310M	PIÑÓN ATAQUE	INITIATIVE GEAR	MARCIA INIZIATIVA	PIGNON D'ATTAQUE
6	PAGB/T896-86	53-82331M	CIRCLIP	CIRCLIP	CIRCLIP	CIRCLIP
7	CM6L5-45251-02	810945M	ÁNODO	ZINC ANODE	ANODO ZINCO	ANODE
8	PAGB/T276-6004C2	30-82291T	RODAMIENTO	BEARING	CUSCINETTO	ROULEMENT
9	REC6E0-45560-00	43-96312M	PIÑÓN MARCHA AVANTE	POSITIVE GEAR ASSY	PIGNONE MARCIA AVANTI	PIGNON DE MARCHE AVANT
10	REC6E0-45631-00	52-96313M	DESPLAZABLE	CLUTCH, DOG	SCORREVOLE	CRABOT
11	REC90250-05046	17-81902M	PASADOR	PIN STRAIGHT	SPINOTTO	PIN
12	REC6E0-45611-01	44-96314M	EJE HÉLICE	SHAFT, PROPELLER	ASSE ELICA	ARBRE D'HELICE
13	REC6E0-45570-00	43-96316M	PIÑÓN MARCHA ATRÁS	REVERSE GEAR	PIGNONE MARCIA INDIETRO	PIGNON MARCHE ARRIÈRE
14	PAGB/T276-6004C2	30-82291T	RODAMIENTO	BEARING	CUSCINETTO	ROULEMENT
15	REC93101-13M12	26-96317M	RETÉN	OIL SEAL	PARAOLIO	JOINT SPI
16	REC93210-48214	25-82280M	ARO TÓRICO	O-RING	O-RING	JOINT TORIQUE
17	PAF4-03050001	96318M	TAPA CÁRTER	COVER, LOWER CASING	COPERCHIO CARTER	COUVERCLE INFERIEUR EMBASE
18	PAF4-03000025		ESPACIADOR	SPACER	DISTANZIALE	ENTRETOISE
19	PAF4-03000026		ARANDELA INOX.	WASHER, STAINLESS STEEL	RONDELLA INOX.	RONDELLE INOX
20	REC647-45616-02	859931	TUERCA	NUT, PROPELLER	DADO	ÉCROU
21	PAGB/T91-1.6X12	18-82132M	PASADOR ALETAS	PIN, COTTER	SPINOTTO	PIN
22	PAF4-00000001	18853M	COLLAR	COLLAR	COLLARE	GUIDE CREUX
23	REC6E0-45316-00	23-95476M	CASQUILLO EJE	BUSHING	GHIERA ASSE	BAGUE BRONZE
24	REC93101-10M14	26-91726M	RETÉN	OIL SEAL	PARAOLIO	JOINT SPI
25	PAF4-03000011	27-96295	JUNTA	PACKING	GUARNIZIONE	JOINT
26	PAF4-03000012	8M0080450	BASE BOMBA DE AGUA	BASE, WATER PUMP	BASE POMPA ACQUA	BASE DE POMPE À EAU
27	PAF4-03000015	96303M	PLACA	OUTER PLATE	PIASTRA	PLAQUE
28	REC6E0-44352-00	47-96305M	IMPULSOR	IMPELLER	GIRANTE	TURBINE
29	REC6E0-44322-02	96302M	CASQUILLO INOX	CARTRIDGE INSERT	CAPPUCCIO	INSERT DE POMPE À EAU
30	PAF4-03000018	27-96300	JUNTA BOMBA	GASKET	GUARNIZIONE POMPA	JOINT DE POMPE
31	PAF4-03000013		PIN	PIN, DOWEL	SPINOTTO	PIN
32	PAF4-03000019	46-96299M	CUERPO BOMBA	HOUSING, WATER PUMP	CORPO POMPA	CORPS DE POMPE À EAU
33	PAF4-03000021	26-80398M	RETÉN GOMA, BOMBA DE AGUA	RUBBER TUBE, WATER PUMP	TENUTA IN GOMMA, POMPA ACQUA	MANCHON CAOUTCHOUC DE POMPE À EAU
34	PAF4-03000020	96306M	PLACA FIJACIÓN BOMBA DE AGUA	PLATE, WATER PUMP FIXED	PLACCA DI FISSAGGIO POMPA ACQUA	PLAQUE FIXATION DE POMPE À EAU
35	PAF4-03000005	96309M	CLIP	CLIP	CLIP	CLIP
36	PAF4-03000016	17-82355M	PIN	PIN, DOWEL	SPINOTTO	PIN
37	REC6E0-45511-01	45-96307M	EJE VERTICAL S	SHAFT, DRIVE S	ASSE VERTICALE S	ARBRE VERTICAL S
	REC6E0-45511-11	45-96308M	EJE VERTICAL L	SHAFT, DRIVE L	ASSE VERTICALE L	ARBRE VERTICAL L



2T 6C (6H8), 6D (6H6), 8C (6G1)
STROKES

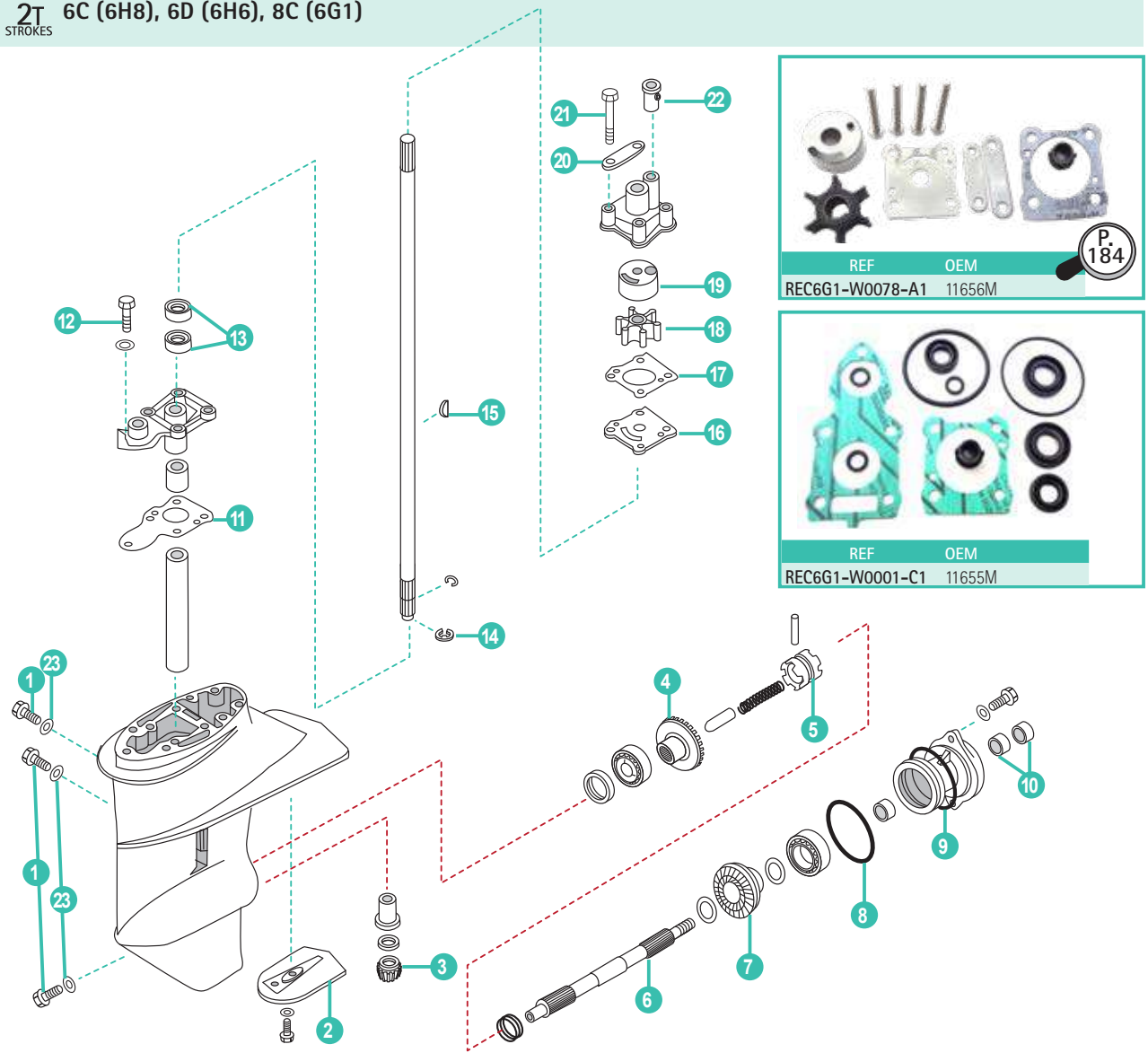

	REF	OEM				
1	REC90340-08002	22-81924M	TAPÓN	PLUG	TAPPO	BOUCHON REMPLISSAGE D'HUILE
2	TEN01118	97-14205M	ÁNODO	ANODE	ANODO	ANODE
3	REC6N0-G5551-00	43-11579M	PIÑÓN ATAQUE	INITIATIVE GEAR	MARCIA INIZIATIVA	PIGNON D'ATAQUE
4	REC6N0-G5560-00	43-11595M	PIÑÓN MARCHA AVANTE	POSITIVE GEAR ASSY	PIGNONE MARCIA AVANTI	PIGNON DE MARCHE AVANT
5	REC6G1-45631-00	52-11597M	EMBRAGUE DE GARRA	CLUTCH, DOG	SELETTORE	CRABOT
6	REC6G1-45611-01	44-11599M	EJE HÉLICE	SHAFT, PROPELLER	ASSE ELICA	ARBRE D'HELICE
7	REC6N0-G5571-00	43-11647M	PIÑÓN MARCHA ATRÁS	REVERSE GEAR	PIGNONE MARCIA INDIETRO	PIGNON MARCHE ARRIÈRE
8	REC93210-49046	25-82281M	ARO TÓRICO	O-RING	O-RING	JOINT TORIQUE
9	REC93210-53M08		ARO TÓRICO	O-RING	O-RING	JOINT TORIQUE
10	REC93101-15074	26-82226M	RETÉN	OIL SEAL	PARAOLIO	JOINT SPI
11	REC6G1-45315-A0	27-11574M	JUNTA	PACKING, LOWER CASING	GUARNIZIONE	JOINT
12	PAGB/T5783-M6X30	10-92523M	TORNILLO	BOLT	VITE	VIS
13	REC93101-11M23	26-11464M	RETÉN	OIL SEAL	PARAOLIO	JOINT SPI
14	REC99001-06600	53-82331M	CERCLIP	CIRCLIP	CIRCLIP	CIRCLIP
15	REC90280-03024	28-81912M	CHAVETA	KEY	CHIAVETTA	CLAVETTE
16	REC6G1-44323-00	11592M	PLATO	OUTTER PLATE, CARTRIDGE	PIASTRA	PLAQUE DE POMPE À EAU
17	REC6G1-44315-A0	27-11591M	JUNTA	GASKET, WATER PUMP	GUARNIZIONE	JOINT
18	REC6G1-44352-00	47-11590M	TURBINA	IMPELLER	GIRANTE	TURBINE
19	REC6G1-44322-00	11589M	CASQUILLO	INSERT, CARTRIDGE	GHIERA	INSERT DE POMPE À EAU
20	REC6G1-44328-00	11593M	PLACA FIJACIÓN BOMBA DE AGUA	PLATE, WATER PUMP FIXED	PLACCA DI FISSAGGIO POMPA ACQUA	PLAQUE FIXATION DE POMPE À EAU
21	REC97095-06045	10-92536M	TORNILLO	BOLT	VITE	VIS
22	REC647-44366-00	26-80532M	CASQUILLO GOMA	DAMPER	GHIERA GOMA	BAGUE CAOUTCHOUC
23	REC90430-08020	27-81987M	JUNTA	GASKET	GUARNIZIONE	JOINT

2T W8 (W MARATHON) (677-)
STROKES 8K (680-)

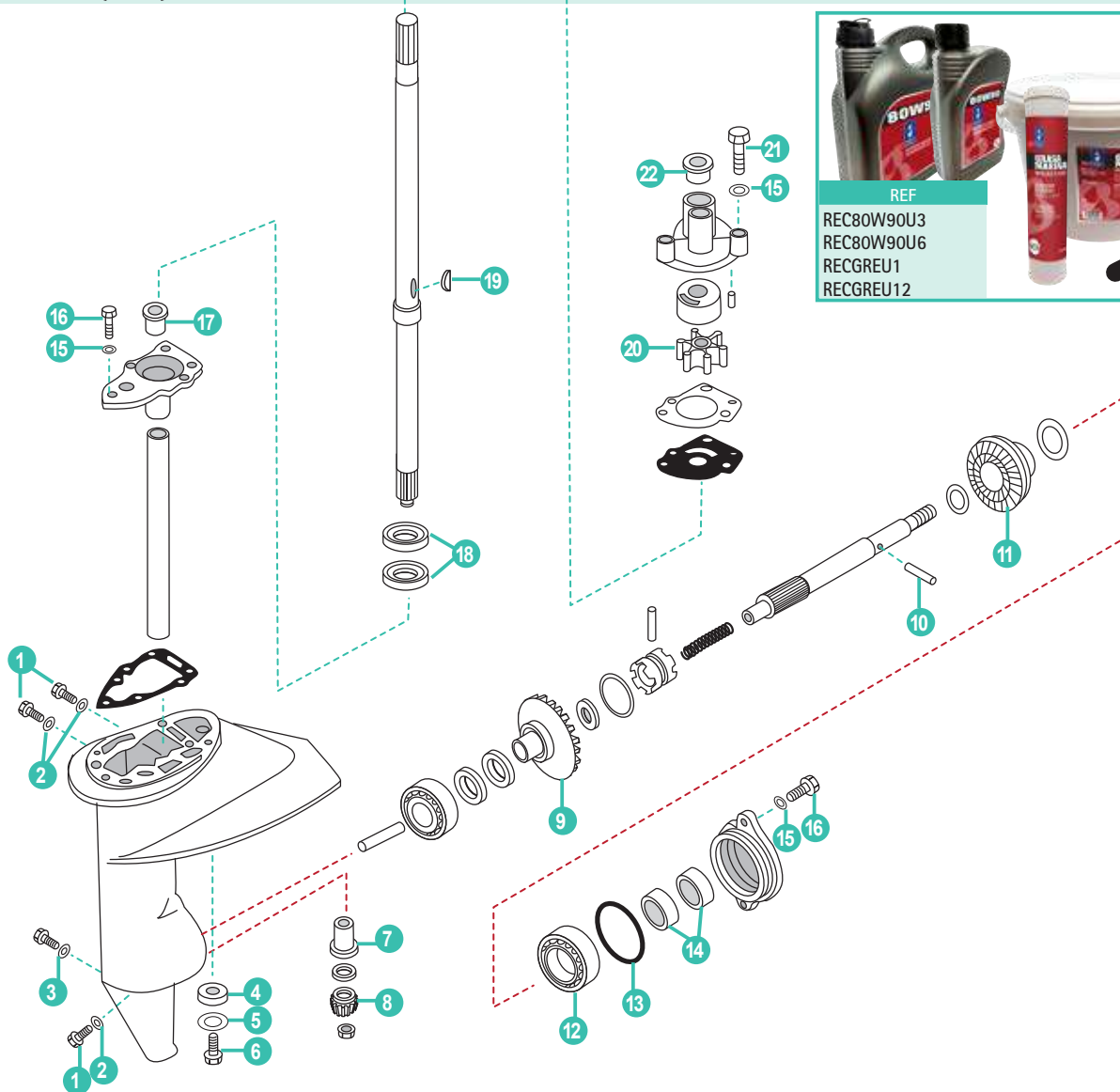

REF
REC80W90U3
REC80W90U6
RECGREU1
RECGREU2

P. 45

	REF	OEM				
1	REC90340-08002	22-81924M	TORNILLO	BOLT	VITE	VIS
2	REC90430-08020	27-81987	JUNTA	GASKET	GUARNIZIONE	JOINT
3	REC90430-06M03	27-95610	JUNTA	GASKET	GUARNIZIONE	JOINT
4	CM6E0-45251-11	97-18852M	ÁNODO	ANODE	ANODO	ANODE
5	PAGB/T861.1-87	12-827055M	ARANDELA	WASHER	RONDELLA	RONDELLE
6	PAGB/T5783-M6X35	10-91722M	TORNILLO	BOLT	VITE	VIS
7	REC647-45316-09	23-80536M	CASQUILLO	DAMPER	GHIERA GOMA	PIN
8	REC647-45551-00	43-82542M	PIÑÓN ATAQUE	INITIATIVE GEAR	MARCIA INIZIATIVA	PIGNON D'ATTAQUE
9	REC647-45560-00	43-80542M	PIÑÓN MARCHA AVANTE	POSITIVE GEAR ASSY	PIGNONE MARCIA AVANTI	PIGNON DE MARCHE AVANT
10	REC90250-05036	17-81901M	PASADOR	PIN	SPINOTTO	PIN
11	REC647-45570-00	43-80544M	PIÑÓN MARCHA ATRÁS	REVERSE GEAR	PIGNONE MARCIA INDIETRO	PIGNON MARCHE ARRIÈRE
12	REC93306-00519	30-8528001	COJINETE	BEARING	CUSCINETTO	ROULEMENT
13	REC93210-58677	25-15377M	ARO	O-RING	O-RING	JOINT TORIQUE
14	REC93101-15074	26-82226M	RETÉN ACEITE	OIL SEAL	PARAOLIO	JOINT SPI
15	PAGB/T97.1-6	12-881379	ARANDELA	WASHER	RONDELLA	RONDELLE
16	PAGB/T5783-M6X20	10-84058M	PERNO	BOLT	VITE	VIS
17	REC647-45316-09	23-80536M	CASQUILLO	BUSH	GHIERA	BAGUE
18	REC93101-18050	26-82228M	RETÉN ACEITE	OIL SEAL	PARAOLIO	JOINT SPI
19	REC90280-03024	28-81912M	CHAVETA	KEY	CHIAVETTA	CLAVETTE
20	REC662-44352-01	47-95611M	IMPULSOR	IMPELLER	GIRANTE	TURBINE
21	REC97095-06040	10-827043M	PERNO	BOLT	VITE	VIS
22	REC647-44366-00	26-80532M	GOMA	RUBER BAND	GOMMA	BAGUE

2T 9.9 (682)
STROKES 15 (684 / 6M7)

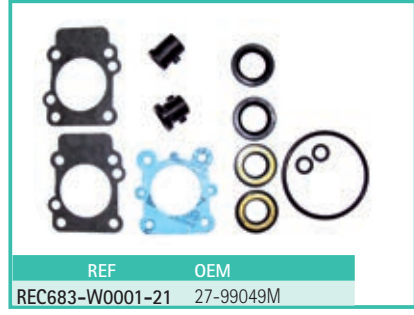
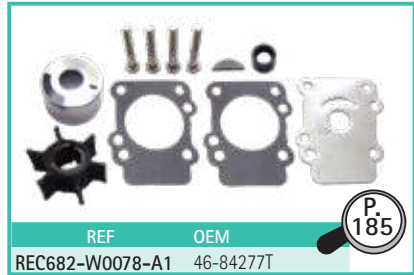
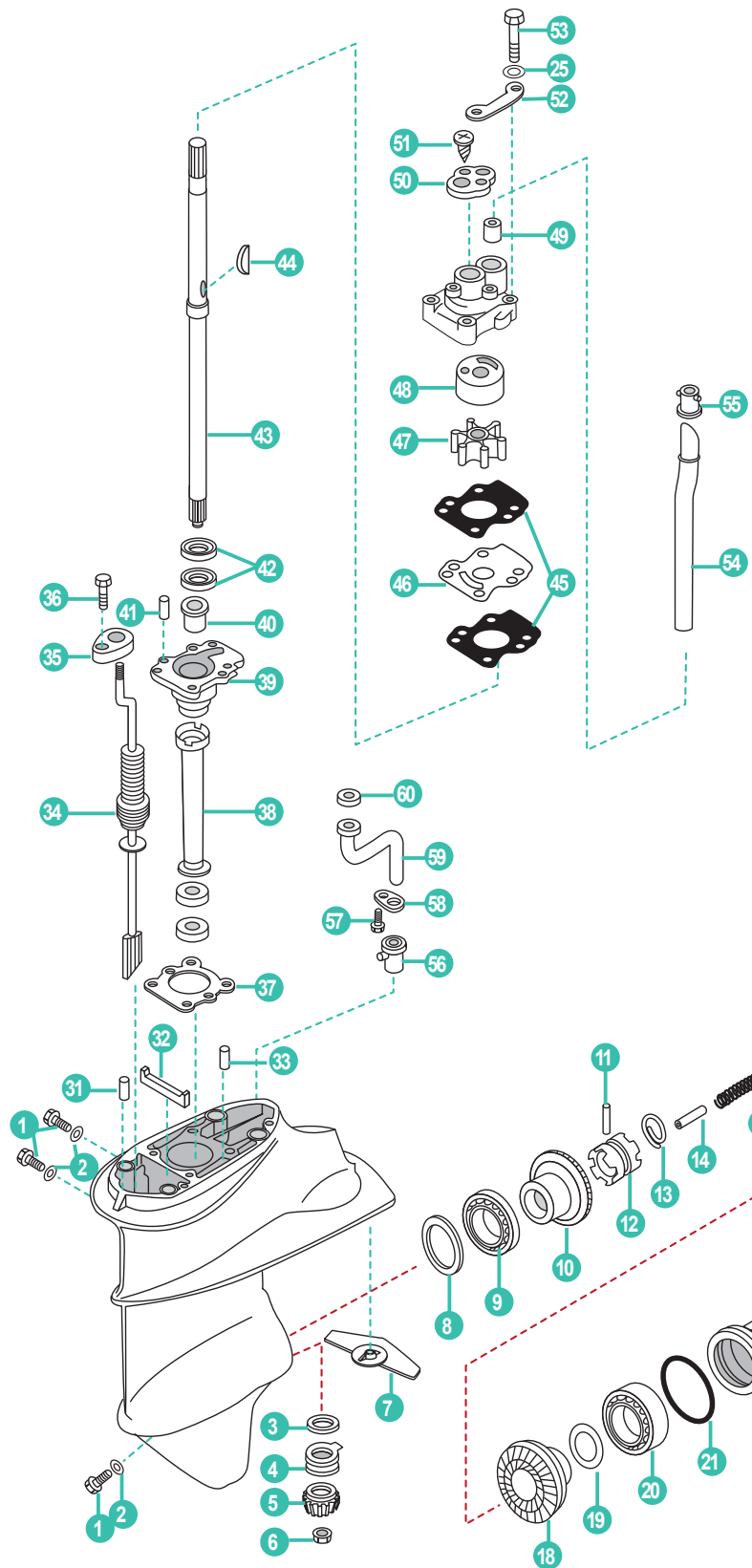

	REF	OEM				
1	REC90340-08002	22-81924M	TAPÓN	PLUG, STRAIGHT SCREW	TAPPO	BOUCHON DE VIDANGE
2	REC90430-08020	27-81987	JUNTA	GASKET	GUARNIZIONE	JOINT
3	PAF15-06000009	17-80252M	GRUESO (1.20mm)	SHIM (1.20mm)	SPESSORE (1.20mm)	CALE (1.20 mm)
4	REC93341-214U1	31-99030M	RODAMIENTO	BEARING	CUSCINETTO	ROULEMENT
5	REC6E7-45551-00	99041M	PIÑÓN ATAQUE	INITIATIVE GEAR	MARCIA INIZIATIVA	PIGNON D'ATAQUE
6	REC90179-08M06	99042M	TUERCA	NUT	DADO	ÉCROU

	REF	OEM				
7	TEN01116	811990M	ÁNODO	ANODE	ANODO	ANODE
	PAF15-06000010-1	81626M	GRUESO (0.05mm)	SHIM (0.05mm)	SPESSORE (0.05mm)	CALE (0.05 mm)
8	PAF15-06000010-2	18955M	GRUESO (0.12mm)	SHIM (0.12mm)	SPESSORE (0.12mm)	CALE (0.12 mm)
	PAF15-06000010-5	18958M	GRUESO (0.30mm)	SHIM (0.30mm)	SPESSORE (0.30mm)	CALE (0.30 mm)
	PAF15-06000010-7	18960M	GRUESO (0.50mm)	SHIM (0.50mm)	SPESSORE (0.50mm)	CALE (0.50 mm)
9	REC93332-00005	31-82321T	RODAMIENTO	BEARING	CUSCINETTO	ROULEMENT
10	REC6E7-45560-01	43-99043T	PIÑÓN MARCHA AVANTE	POSITIVE GEAR ASSY	PIGNONE MARCIA AVANTI	PIGNON DE MARCHE AVANT
11	REC90250-05010	17-81899M	PASADOR	PIN, STRAIGHT	SPINOTTO	PIN
12	REC682-45631-00	84274M	EMBRAGUE DE GARRA	CLUTCH, DOG	SELETTORE	CRABOT
13	REC648-45633-00	80678M	ANILLO	RING, CROSS PIN	O-RING	JOINT TORIQUE
14	REC650-45635-00	80923M	PISTÓN	PLUNGER, SHIFT	PISTONE	PISTON
15	PAF15-06070002	84064M	MUELLE	SPRING, COMPRESSION	MOLLA	RESSORT
16	REC683-45611-00	44-84078M	EJE HÉLICE	SHAFT, PROPELLER	ASSE ELICA	ARBRE D'HELICE
17	REC90201-17682	12-94627M	ARANDELA	WASHER, PLATE	RONDELLA	RONDELLE
18	REC6E7-45570-00	43-99044T	PIÑÓN MARCHA ATRÁS	REVERSE GEAR	PIGNONE MARCIA INDIETRO	PIGNON MARCHE ARRIÈRE
	PAF15-06080006-1	15-19148005	GRUESO (0.10mm)	SHIM (0.10mm)	SPESSORE (0.10mm)	CALE (0.10 mm)
19	PAF15-06080006-3	15-80259M	GRUESO (0.30mm)	SHIM (0.30mm)	SPESSORE (0.30mm)	CALE (0.30 mm)
	PAF15-06080006-5	15-80260M	GRUESO (0.50mm)	SHIM (0.50mm)	SPESSORE (0.50mm)	CALE (0.50 mm)
20	REC93306-00501	30-8528001	RODAMIENTO	BEARING	CUSCINETTO	ROULEMENT
21	REC93210-57M09	25-84089M	ARO TÓRICO	O-RING	O-RING	JOINT TORIQUE
22	REC683-45361-01-4D	84076T	DIÁBOLO	CAP, LOWER CASING	COP. CASSA INGRANAGGI	DIABOLO
23	REC93315-317U2	31-84086M	RODAMIENTO	BEARING	CUSCINETTO	ROULEMENT
24	REC93101-17054	26-8540171	RETÉN	OIL SEAL	PARAOLIO	JOINT SPI
25	PAGB/T97.1-6	12-82214M	ARANDELA	WASHER, PLATE	RONDELLA	RONDELLE
26	PAGB/T5783-M6X20	10-84058M	TORNILLO	BOLT	VITE	VIS
27	REC6E7-45987-00	12-815025M	ESPACIADOR	SPACER	DISTANZIALE	ENTRETOISE
28	PAGB/T96-10	859894	SEPARADOR	SPACER	DISTANZIALE	CALE
29	PAF15-06000016	859933	TUERCA HÉLICE	NUT, CASTLE	DADO ELICA	ÉCROU
30	PAGB/T91-2.5X20	18-815026	PASADOR ALETAS	PIN, COTTER	PIN ELICA	CLAVETTE
31	REC93606-12019		PIN	PIN	SPINOTTO	PIN
32	REC682-45376-01	94622M	GUÍA RETÉN	GUIDE, SEAL DAMPER	GUIDA BOCCOLA	GUIDE
33	PAF25-04000007	17-82354M	PIN	PIN, DOWEL	SPINOTTO	PIN
34	REC682-44147-00	84019M	TAPÓN GUÍA	BOOT, SHIFT ROD	TAPPO GUIDA	GUIDE
35	REC682-44176-00	84020M	SOPORTE	BRACKET	SUPPORTO	SUPPORT
36	PAGB/T845-ST4.8X9	10-84788M	TORNILLO	SCREW	VITE	VIS
37	REC683-45315-A0	27-84075	JUNTA	PACKING, LOWER CASING	GUARNIZIONE	JOINT
38	REC6E7-45536-00	23-99035M	CAMISA EJE	SLEEVE, DRIVE SHAFT	TUBO GUIDA	TUBE GUIDE
39	REC6E7-45331-00-CA	8M0057163	CUERPO DE RODAMIENTO	HOUSING, BEARING	CUSCINETTO	LOGEMENT
40	REC626-45316-09	23-82590M	CASQUILLO	BUSHING, DRIVE SHAFT	GHIERA	BAGUE
41	REC93606-12019	17-82364M	PIN	PIN, DOWEL	SPINOTTO	PIN
42	REC93101-20048	26-82229M	RETÉN	OIL SEAL	PARAOLIO	JOINT SPI
43	REC6E7-45501-00	45-99032M	EJE S	DRIVE SHAFT COMP. S	ASSE VERTICALE S	ARBRE VERTICAL S
	REC6E7-45501-11	45-99033M	EJE L	DRIVE SHAFT COMP. L	ASSE VERTICALE L	ARBRE VERTICAL L
44	REC90280-03024	28-81912M	CHAVETA	KEY, WOODRUFF	CHIAVETTA	CLAVETTE
45	REC682-44315-00	27-84024M	JUNTA	GASKET, WATER PUMP	GUARNIZIONE	JOINT DE POMPE A EAU
46	REC682-44323-40	842121M	PLATO	OUTER PLATE, CARTRIDGE	PIASTRA	PLAQUE DE POMPE À EAU
47	REC682-44352-01	47-84027T	TURBINA	IMPELLER	GIRANTE	TURBINE
48	REC682-44322-00	84025M	CASQUILLO INOX.	INSERT, CARTRIDGE	GHIERA INOX.	INSERT DE POMPE À EAU
49	REC682-44365-00	84022M	CASQUILLO GOMA	DAMPER, WATER SEAL	GHIERA GOMA	BAGUE
50	REC682-44312-00	84023M	TAPA CUERPO BOMBA AGUA	COVER, WATER PUMP HOUSING	COPERCHIO CORPO ACQUA	CORPS DE POMPE À EAU
51	PAGB/T845-ST4.2X16	10-84272M	TORNILLO	SCREW, TAPPING	VITE	VIS
52	REC682-44328-00	94624M	PLATO	PLATE	PIASTRA	PLAQUE
53	PAGB/T5782-M6X45	10-827043M	TORNILLO	BOLT	VITE	VIS
54	REC682-44361-01	32-84028M	TUBO DE AGUA S	WATER TUBE S	TUBO ACQUA S	TUBE D'EAU S
	REC682-44361-10	32-84029M	TUBO DE AGUA L	WATER TUBE L	TUBO ACQUA L	TUBE D'EAU L
55	REC626-44365-01	26-80239M	RETÉN	SEAL	PARAOLIO	JOINT SPI
56	REC6E7-44366-00	26-99031M	CASQUILLO GOMA	WATER SEAL	BOCCOLA GOMMA	GUIDE CAOUTCHOUC
57	PAGB/T5783-M6X10	10-84088M	TORNILLO	BOLT	VITE	VIS
58	REC683-44373-00	84072M	PLACA FIJACION TUBO	PLATE WATER TUBE	PLACCA SUPPORTO TUBO	PLAQUE DE FIXATION DE TUBE
59	REC683-44362-01	32-94625M	TUBO DE AGUA	WATER TUBE "B"	TUBO ACQUA	TUBE D'EAU
60	REC683-44365-01	26-94626M	CASQUILLO GOMA	SEAL WATER TUBE	BOCCOLA GOMMA	GUIDE CAOUTCHOUC

2T 20C (6A9) • 25C (695) • 30A (689)
STROKES

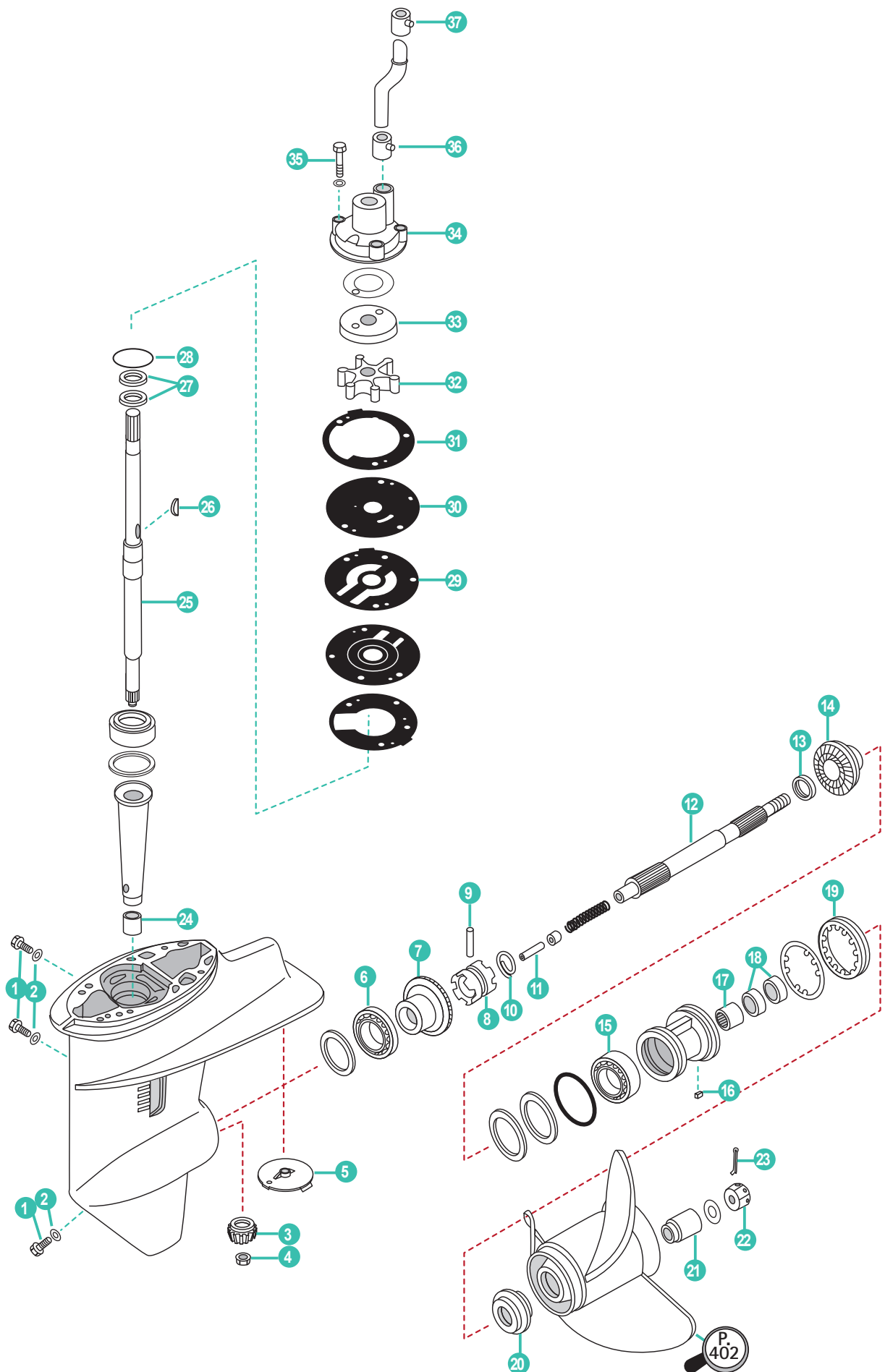

	REF	OEM				
1	REC90340-08002	22-81924M	TAPÓN ACEITE	PLUG, OIL	TAPPO OLIO	BOUCHON REMPLISSAGE D'HUILE
2	REC90430-08020	27-81987M	ARANDELA	WASHER	RONDELLA	JOINT DE VIDANGE
3	REC689-45551-00	43-84806M	PIÑÓN ATAQUE	INITIATIVE GEAR	MARCIA INIZIATIVA	PIGNON D'ATTAQUE
4	REC90179-09M02	11-84807M	TUERCA, PIÑÓN	NUT	DADO	ÉCROU
5	CM664-45371-01	82795M	ÁNODO	ANODE	ANODO	ANODE
6	REC93332-00005	31-82321M	COJINETE	BEARING	CUSCINETTO	ROULEMENT
7	REC689-45560-00	43-84808M	PIÑÓN MARCHA AVANTE	POSITIVE GEAR ASSY	PIGNONE MARCIA AVANTI	PIGNON DE MARCHÉ AVANT
8	REC664-45631-01	52-81644M	SELECTOR	CLUTCH	SELETTORE	CRABOT
9	REC90250-05010	17-81899M	PASADOR	PIN	SPINOTTO	LEVIER
10	REC648-45633-00	53-80678M	ARO, PASADOR	CROSS PIN	O-RING	JOINT TORIQUE
11	REC648-45635-00	80680M	PIVOTE	PIN	PERNO	PIN
12	REC689-45611-00	44-19124M	EJE HÉLICE	SHAFT PROPELLER	ASSE ELICA	ARBRE D'HELICE
13	REC90201-20417	12-81831M	ARANDELA	WASHER	RONDELLA	RONDELLE
14	REC689-45571-00-00	43-84810M	PIÑÓN MARCHA ATRÁS	REVERSE GEAR	PIGNONE MARCIA INDIETRO	PIGNON MARCHÉ ARRIÈRE
15	REC93306-00612	30-82295M	COJINETE	BEARING	CUSCINETTO	ROULEMENT
16	REC90282-04010	28-81916M	CHAVETA	KEY	CHIAVETTA	CLAVETTE
17	REC93315-22004	31-82315M	COJINETE	BEARING	CUSCINETTO	ROULEMENT
18	REC93101-20M07	26-84813M	RETÉN	OIL SEAL	PARAOLIO	JOINT SPI
19	REC664-45384-00	11-81619M	TUERCA	NUT	DADO	ÉCROU
20	REC664-45987-00	12-81650M	ESPACIADOR	SPACER	DISTANZIALE	CALE
21	REC689-45997-00	84823M	ESPACIADOR	SAPCER	DISTANZIALE	CALE
22	REC90171-14013-00	11-81774M	TUERCA HÉLICE	NUT	DADO	ÉCROU D'HELICE
23	REC91490-30030	18-82132M	PASADOR	COTTER PIN	PIN	GOUPILLE
24	REC93315-017U4	29-84803M	COJINETE, PIÑÓN	BEARING	CUSCINETTO	ROULEMENT
25	REC689-45501-10	45-84801M	EJE L	DRIVE SHAFT L	ASSE VERTICALE L	ARBRE VERTICAL L
26	REC664-44338-00	28-81603M	CUÑA	CHAVETA	KEY	CLAVETTE
27	REC93101-22067	26-82233M	RETÉN ACEITE	OIL SEAL	PARAOLIO	JOINT SPI
28	REC689-44315-A0	25-84054M	JUNTA BASE	GASKET	GUARNIZIONE	JOINT
29	REC689-44316-A0	27-95656M	JUNTA BASE	GASKET	GUARNIZIONE	JOINT
30	REC689-44323-00	95654M	CHAPA	PLATE	PIASTRA	PLAQUE
31	REC689-44324-A0	27-41273M	JUNTA, CHAPA	GASKET	GUARNIZIONE	JOINT
32	REC689-44352-02	47-84797M	IMPULSOR	IMPELLER	GIRANTE	TURBINE
33	REC689-W4432-01	95652M	ACOPLE	INSERT CUP	ACCOPIAMENTO	INSERT DE POMPE À EAU
34	REC689-44311-00	46-95651M	CUERPO BOMBA AGUA	HOUSING W.P.	CORPO POMPA ACQUA	CORPS DE POMPE
35	REC90101-06M56	10-84790M	TORNILLO CUERPO BOMBA	BOLT	VITE	VIS
36	REC626-44365-01	26-80239M	RETÉN SUPERIOR TUBO DE AGUA	DUMPER WATER TUBE	PARAOLIO SUPERIORE TUBO ACQUA	BAGUE TUBE D'EAU
37	REC689-44366-00	26-84818M	RETÉN SUPERIOR TUBO DE AGUA	DUMPER WATER TUBE	PARAOLIO SUPERIORE TUBO ACQUA	BAGUE TUBE D'EAU

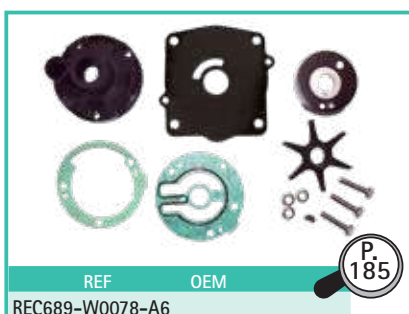

2T 30 - 70 HP (2, 3, 4 CYL) (1977-97)
STROKES

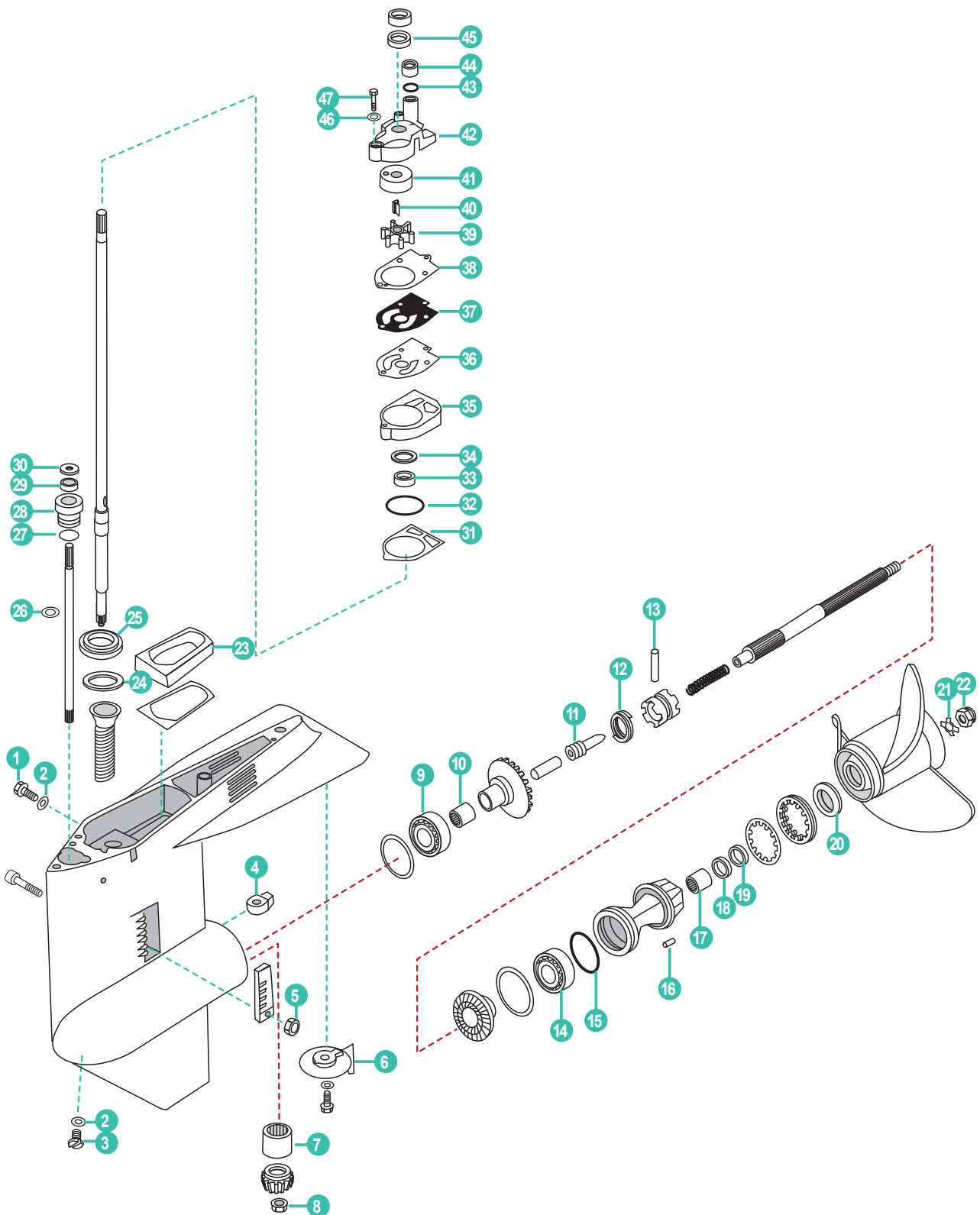

	REF	OEM				
1	REC10-79953Q04	10-79953Q2	JUEGO TORNILLOS	SCREW SET	KIT VITE	KIT VIS
2	REC12-191833	12-19183-3	JUNTA	GASKET	GUARNIZIONE	JOINT
3	REC22-67892A05	22-67892A1	TORNILLO DRENAJE	DRAINING SCREW	VITE DRENAGGIO	VIS DE VIDANGE
4	REC76039-4	76039-4	LEVA	SHIFT CAM	LEVA	CAM
5	REC11-859124	11-45812	CIERRE TUERCA	LOCK NUT	CHIUSURA DADO	ÉCROU
6	CM31640A	31640Q4	ÁNODO ALUMINIO	ANODE ALUMINUM	ANODO ALLUMINIO	ANODE ALUMINIUM
	CM31640	31640Q4	ÁNODO ZINC	ANODE ZINC	ANODO ZINCO	ANODE ZINC
7	REC31-62091T	31-6291T	RODAMIENTO	BEARING	CUSCINETTO	ROULEMENT
8	REC313339	11-55910	TUERCA PIÑÓN	PINION NUT	DADO PIGNONE	ÉCROU PIGNON
9	REC31-38356A1	31-38356A1	COJINETE	BEARING	CUSCINETTO	ROULEMENT
10	REC31-21739	31-21739	COJINETE	BEARING	CUSCINETTO	ROULEMENT
11	REC20843	20843	PASADOR	SLIDE	CHIAVETTA	INSERT
12	REC24-38114	24-38114	MUELLE	SPRING	MOLLA	RESSORT
13	REC17-8M0020942	17-38113	PASADOR	CROSS PIN	CHIAVETTA	CLAVETTE
14	REC30-20839T	30-20839T	COJINETE	BEARING	CUSCINETTO	ROULEMENT
15	REC3852866	25-31986	ARO TÓRICO	O-RING	O-RING	TORIQUE
16	REC28-30281	28-30281	CHAVETA	KEY	CHIAVETTA	CLAVETTE
17	REC31-21700	31-21700	COJINETE	BEARING	CUSCINETTO	ROULEMENT
18	REC26-69188	26-69188	RETÉN ACEITE	OIL SEAL	PARAOLIO	JOINT SPI
19	REC26-69189	26-69189	RETÉN ACEITE	OIL SEAL	PARAOLIO	JOINT SPI
20	REC73345A1	73345A1	TOPE HÉLICE	THRUST HUB	PUNTA ELICA	RONDELLE BUTEE D'HELICE
21	REC14-76281Q	14-76281	CIERRE HÉLICE	TAB WASHER	CHIUSURA ELICA	RONDELLE FREIN
22	REC11-69578Q1	11-69578A1	KIT CIERRE HELICE	PROP LOCK KIT	KIT CHIUSURA ELICA	KIT ECROU D'HELICE
23	REC37721001	37721	RETÉN	SEAL	TENUTA	JOINT
24	RM15-92881A1	15-92881A1	KIT SUPLEMENTOS	SHIM SET	KIT SUPPLEMENTI	KIT DE CALE
25	REC31-77420A1	31-77420A1	COJINETE	BEARING	CUSCINETTO	ROULEMENT
26	REC53-29641	53-29641	ARO RETENEDOR	RETAINING RING	O-RING	RAITENEUR
27	REC25-25439	25-25439	ARO TÓRICO	O-RING	O-RING	TORIQUE
28	REC23-77631A2	23-77631A2	ACOPLE EJE	BUSHING ASSEMBLY	ACCOPIO ASSE	INSERT
29	REC26-8164641	26-816464-1	RETÉN ACEITE	OIL SEAL	PARAOLIO	JOINT SPI
30	REC12-77674	12-77674	JUNTA	GASKET	GUARNIZIONE	JOINT
31	REC27-19552	27-19552	JUNTA	GASKET	GUARNIZIONE	JOINT
32	REC302588	25-26722	ARO TÓRICO	O-RING	O-RING	TORIQUE
33	REC26-79831	26-79831	RETÉN ACEITE	OIL SEAL	PARAOLIO	JOINT SPI
34	REC26-90562	26-90562	RETÉN ACEITE	OIL SEAL	PARAOLIO	JOINT SPI
35	REC46-77177A1	46-77177A1	BASE BOMBA AGUA	WATER PUMP BASE	BASE POMPA ACQUA	BASE POMPE À EAU
36	REC27-19553	27-19553	JUNTA	GASKET	GUARNIZIONE	JOINT
37	REC32768	32768	TAPA BOMBA	WEAR PLATE	COPERCHIO POMPA	PLAQUE DE POMPE À EAU
38	REC27-19551	27-19551	JUNTA	GASKET	GUARNIZIONE	JOINT
39	REC47-89983T	47-89983T	IMPULSOR	IMPELLER	GIRANTE	TURBINE
40	REC8M0032837	8M0032837	CHAVETA	KEY	CHIAVETTA	CLAVETTE
41	REC48753	48753	ACOPLE	INSERT CUP	ACCOPIAMENTO	INSERT DE POMPE À EAU
42	REC46-77822A1	46-77822A1	CUERPO BOMBA AGUA	WATER PUMP HOUSING	CORPO POMPA ACQUA	CORPS DE POMPE
43	REC12-38453	12-38453	JUNTA	GASKET	GUARNIZIONE	JOINT
44	REC26-38452	26-38452	GRUESO	GROMMET	SPESSORE	CALE
45	REC25-20273	25-20273	PASADOR	SLINGER	CHIAVETTA	CLAVETTE
46	REC12-29245	12-29245	ARANDELA	WASHER	RONDELLA	RONDELLE
47	REC11-8267089	11-13438	TORNILLO	BOLT	VITE	VIS

REF	OEM
REC46-77177A3	46-77177A3

P. 186

REF	OEM
REC47-89983Q1	47-89983Q1

P. 186

REF	OEM
REC26-79831A1	26-79831A1

P. 174

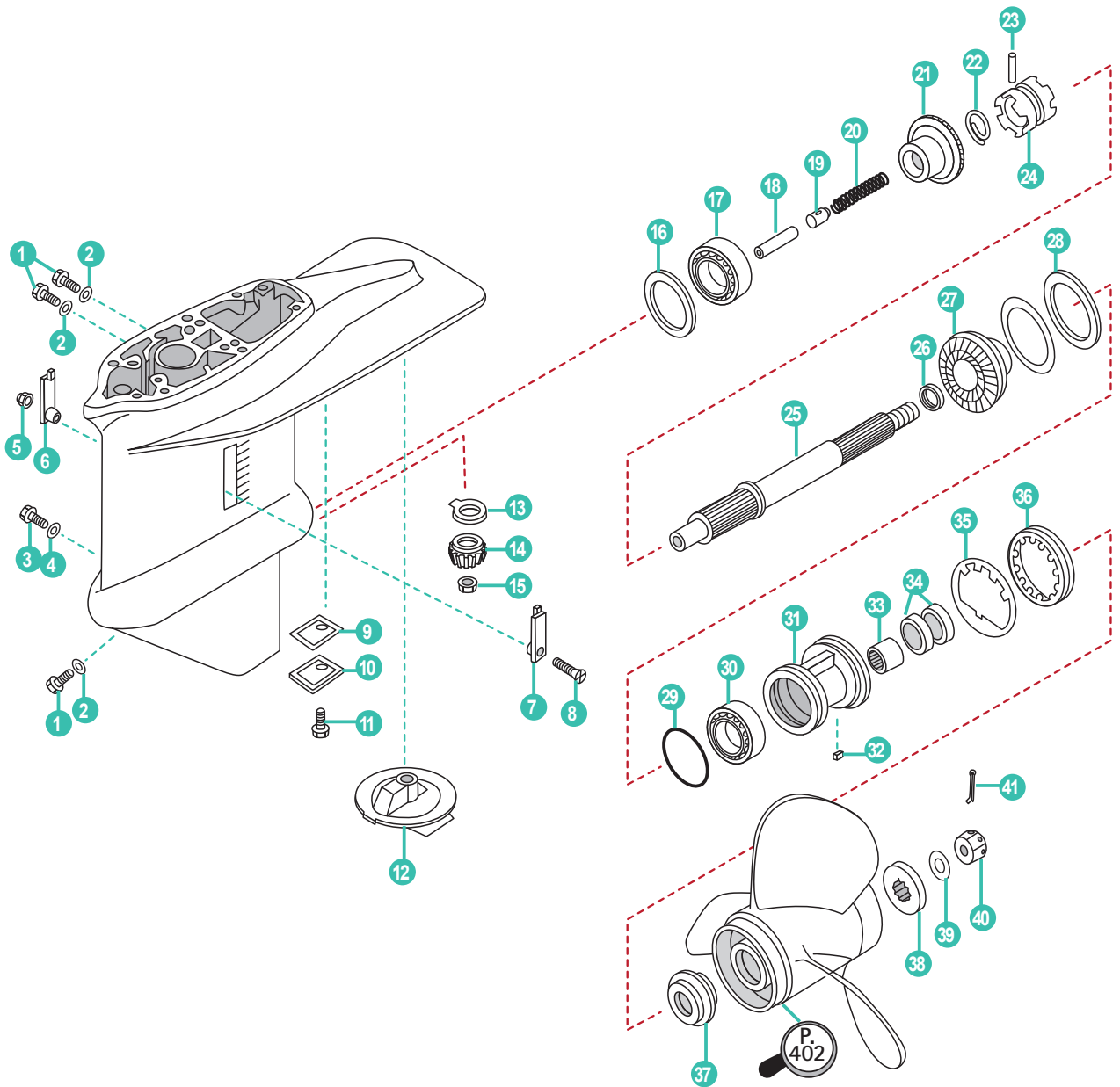

	REF	OEM				
1	REC90340-08002	22-81924M	TORNILLO NIVEL ACEITE	VENT PLUG	VITE LIVELLO OLIO	BOUCHON DE VIDANGE
2	REC90430-08020	27-95610M	ARANDELA	WASHER	RONDELLA	JOINT DE VIDANGE
3	REC90149-06M00	10-83392M	TORNILLO DRENAJE	DRAIN SCREW	VITE DRENAGGIO	BOUCHON DE VIDANGE
4	REC90430-06M03	27-95610M	JUNTA	GASKET	GUARNIZIONE	JOINT DE VIDANGE
5	PAGB/T889.1-M5	11-81781M	TUERCA	NUT	DADO	ÉCROU
6	REC688-45215-02	19167M	TAPA ENTRADA DE AGUA	WATER SCREEN	COPERCHIO RAFFREDDAMENTO	GRILLE D'ENTREE D'EAU
7	REC688-45214-02	97091M	TAPA ENTRADA DE AGUA	WATER SCREEN	COPERCHIO RAFFREDDAMENTO	GRILLE D'ENTREE D'EAU
8	PAGB/T820-M5X30	10-83858M	TORNILLO	SCREW	VITE	VIS
9	REC679-45315-A1	27-95418M	JUNTA	GASKET	GUARNIZIONE	JOINT
10	REC679-45321-02	95417M	PLACA	PLATE	PIASTRA	PLAQUE
11	PAGB/T818-M6X16	10-83870M	TORNILLO	SCREW	VITE	VIS
12	TEN01101	83859M	ÁNODO	ANODE	ANODO	ANODE
13	REC663-45552-00	12-81455M	COJINETE PLANO	BEARING	CUSCINETTO	ROULEMENT
14	REC6H9-45551-00	43-86869M	PIÑÓN ATAQUE	INITIATIVE GEAR	MARCIA INIZIATIVA	PIGNON D'ATTAQUE
15	REC90170-12138	11-81772M	TUERCA	NUT	DADO	ÉCROU
16	PAT40-04000004-1	15-19154M	GRUESO (0.10mm)	SHIM (0.10mm)	SPESSORE (0.10mm)	CALE (0.10mm)
	PAT40-04000004-5	15-81459M	GRUESO (0.30mm)	SHIM (0.30mm)	SPESSORE (0.30mm)	CALE (0.30mm)
17	REC93332-00003	31-82320M	COJINETE	BEARING	CUSCINETTO	ROULEMENT
18	REC676-45635-00	83419M	ÉMBOLO DE CAMBIO	PIVOT	PERNO	PIVOT
19	REC663-45634-00	81475M	DESILIZADOR DE CAMBIO	CLUTCH DOG	TRAINABILE CAMBIO	PISTON
20	REC90501-16M01	24-83429M	RESORTE DE COMPRESIÓN	SPRING	MOLLA	RESSORT
21	REC679-45560-00	43-83877M	PIÑÓN MARCHA AVANTE	POSITIVE GEAR ASSY	PIGNONE MARCIA AVANTI	PIGNON DE MARCHE AVANT
22	REC663-45633-00	52-81473M	ANILLO DEL PASADOR	ANNULAR SPRING, CLUTCH	ANELLO	RESSORT
23	REC90250-06023	17-81903M	PASADOR	PIN	FERMO	GOUPILLE
24	REC663-45631-00	52-81473M	EMBRAGUE DE GARRA	CLUCH DOG	SELETTORE	CRABOT
25	REC679-45611-00	44-94531M	EJE PROPULSOR	PROPELLER SHAFT	ASSE ELICA	ARBRE D'HELICE
26	REC90201-22429	12-81837M	ARANDELA PLANA	WASHER	RONDELLA	RONDELLE
27	REC679-45571-00	43-83879M	PIÑÓN MARCHA ATRÁS	REVERSE GEAR	PIGNONE MARCIA INDIETRO	PIGNON MARCHE ARRIÈRE
28	REC663-45576-00	12-81461M	ARANDELA DE EMPUJE	PUSH WASHER	RONDELLA DI SPINTA	RONDELLE D'APPUI
29	REC93210-66M98	25-82289M	O-RING	O-RING	O-RING	JOINT TORIQUE
30	REC93306-00702	30-82296M	COJINETE	BEARING	CUSCINETTO	ROULEMENT
31	REC679-45331-00	83880M	DIABOLO	DIABOLO	DIABOLO	DIABOLO
32	REC90282-04010	28-81916M	CHAVETA	KEY	CHIAVETTE	CLAVETTE
33	REC93317-22204	31-82317M	COJINETE	BEARING	CUSCINETTO	ROULEMENT
34	REC93101-22067	26-83406M	RETÉN DE ACEITE	SEAL OIL	PAROLIO	JOINT SPI
35	REC90214-48M03	14-81877M	ARANDELA	WASHER	RONDELLA	RONDELLE
36	REC697-45384-00	11-81450M	TUERCA	NUT	DADO	ÉCROU
37	REC663-45987-00	12-81477M	ESPACIADOR	DISTANCE WASHER	DISTANZIALE	ENTRETOISE
38	REC66T-45997-00	23-84445M	ESPACIADOR	DISTANCE WASHER	DISTANZIALE	ENTRETOISE
39	REC90389-22M01	12-83700M	ARANDELA	WASHER	RONDELLA	RONDELLE
40	REC90171-16011	11-81775M	TUERCA	NUT	DADO	ÉCROU D'HELICE
41	REC91490-30025	18-82132M	CLIP	CLIP	CLIP	GOUPILLE

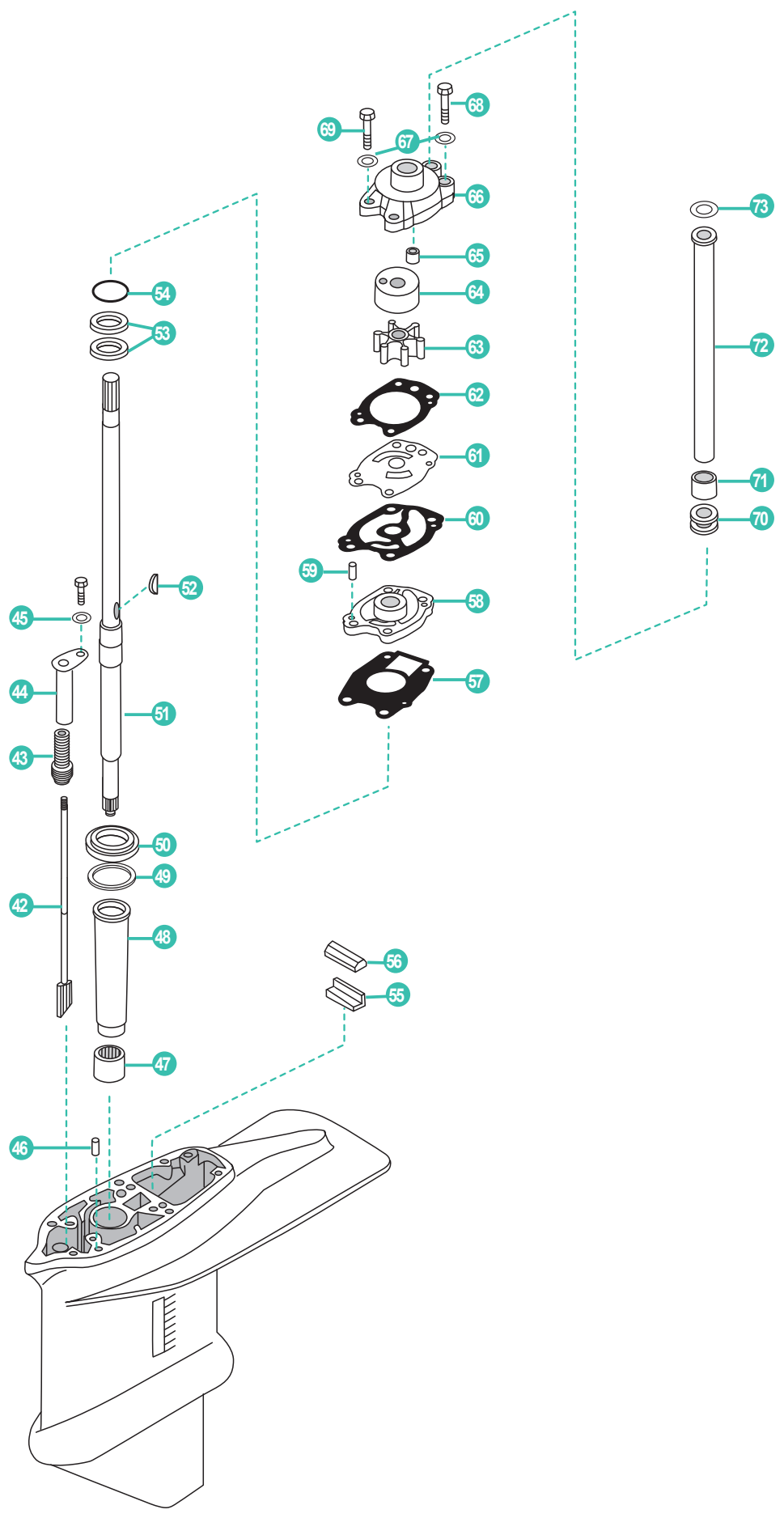

	REF	OEM				
42	REC679-44150-10	83881M	EJE SELECTOR L	SHAFT SELECTOR L	ASSE SELETTORE L	ARBRE SELECTEUR L
	REC679-44150-00	83882M	EJE SELECTOR S	SHAFT SELECTOR S	ASSE SELETTORE S	ARBRE SELECTEUR S
43	REC650-44147-00	82881M	FUELLE EJE	BOOT, SHIFT ROD	BOOT, SHIFT ROD	SOUFFLET
44	REC679-44152-00	83883M	BUJE LEVE DE CAMBIO	HUBE GEAR LEVE	MOZZO LEVA CAMBIO	LEVIER DE VITESSE
45	PAGB/T97.1-6	12-82214M	ARANDELA PLANA	WASHER	RONDELLA	RONDELLE
46	REC93606-12019	17-82364M	PIN CENTRADOR	PIN DOWEL	SPINOTTO DI CENTRAGGIO	CLAVETTE DE CENTRAGE
47	REC93315-32224	31-82316M	COJINETE	BEARING	CUSCINETTO	ROULEMENT
48	REC679-45536-00	83868M	CAMISA EJE TRASMISION	BUSHING NYLON	CAMICIA ASSE TRASMISSIONE	AXE TRANSMISSION
	PAT40-04000003-1	15-19148M	GRUESO (0.10mm)	SHIM (0.10mm)	SPESSORE (0.10mm)	CALE (0.10mm)
	PAT40-04000003-2	15-81469M	GRUESO (0.12mm)	SHIM (0.12mm)	SPESSORE (0.12mm)	CALE (0.12mm)
	PAT40-04000003-3	15-19149M	GRUESO (0.15mm)	SHIM (0.15mm)	SPESSORE (0.15mm)	CALE (0.15mm)
49	PAT40-04000003-4	15-19150M	GRUESO (0.18mm)	SHIM (0.18mm)	SPESSORE (0.18mm)	CALE (0.18mm)
	PAT40-04000003-5	15-19151M	GRUESO (0.30mm)	SHIM (0.30mm)	SPESSORE (0.30mm)	CALE (0.30mm)
	PAT40-04000003-6	15-19152M	GRUESO (0.40mm)	SHIM (0.40mm)	SPESSORE (0.40mm)	CALE (0.40mm)
	PAT40-04000003-7	15-19153M	GRUESO (0.50mm)	SHIM (0.50mm)	SPESSORE (0.50mm)	CALE (0.50mm)
50	PAT40-04000027	31-98933M	COJINETE	BEARING	CUSCINETTO	ROULEMENT
51	REC679-45501-10	45-83867M	EJE L	SHAFT L	ASSE L	ARBRE L
52	REC90280-04M00	28-83444M	CHAVETA	KEY	CHIAVETTA	CLAVETTE
53	REC93101-22067	26-83406M	RETÉN DE ACEITE	SEAL OIL	PARAOILIO	JOINT SPI
54	REC93210-41042	25-82275M	TÓRICA	O-RING	O-RING	JOINT TORIQUE
55	REC663-45376-00	81449M	GUIA RETEN	GUIDE RUB. SEAL	GUIDA PARAOLIO	GUIDE
56	REC663-45375-00	81448M	GOMA SELLADORA	SEALING RUBBER	ANELLO SIGILLANTE	JOINT CAOUTCHOUC
57	REC679-44316-A0	27-83865M	JUNTA	GASKET	GUARNIZIONE	JOINT
58	REC679-44341-00	46-83864M	CAJA BOMBA DE AGUA	WATER PUMP HOUSING	SCATOLA POMPA ACQUA	BASE DE POMPE À EAU
59	PAF25-04000007	17-82354M	PASADOR	PIN	FERMO	GOUPILLE
60	REC676-44324-A0	27-83399M	JUNTA	GASKET	GUARNIZIONE	JOINT
61	REC676-44323-00-40	83400M	PLACA EXTERIOR DEL CARTUCHO	OUTER PLATE	PLACCA ESTERNA	PLAQUE DE POMPE À EAU
62	REC676-44315-00	27-83398M	JUNTA	GASKET	GUARNIZIONE	JOINT
63	REC6F5-44352-00	47-99971M	IMPULSOR	IMPELLER	GIRANTE	TURBINE
64	REC676-44322-00	83403M	CASQUILLO INOX	CARTRIDGE INSERT	BOCCOLA	INSERT DE POMPE À EAU
65	REC663-44366-00	26-81426M	RETEN TUBO AGUA	DAMPER, WATER SEAL	GHIERA	JOINT DE TUBE D'EAU
66	REC676-44311-00	46-83396M	CAJA BOMBA DE AGUA	WATER PUMP HOUSING	SCATOLA POMPA ACQUA	CORPS DE POMPE À EAU
67	PAGB/T97.1-8	12-82217M	ARANDELA PLANA	WASHER	RONDELLA	RONDELLE
68	REC97095-08055	10-84057M	PERNO	BOLT	BOULONE	BOULON
69	REC97095-08045	10-82468M	PERNO	BOLT	BOULONE	BOULON
70	PAT40-02000002	26-81427M	GOMA DEL SELLO DE AGUA	GUIDE BUSHING, WATER PIPE	GUARNIZIONE	GUIDE DE PIPE D'EAU
71	REC90430-12072	25-81989M	JUNTA	GASKET	GUARNIZIONE	JOINT
72	REC676-44361-00	32-83451M	TUBO S	TUBE S	TUBO S	TUBE S
	REC676-44361-10	32-83452M	TUBO L	TUBE L	TUBO L	TUBE L
73	PAF25-02000019	12-81852M	GOMA DEL SELLO DE AGUA	GUIDE BUSHING, WATER PIPE	GUARNIZIONE	GUIDE DE PIPE D'EAU



2T 60 (2 CYL) (675)
STROKES

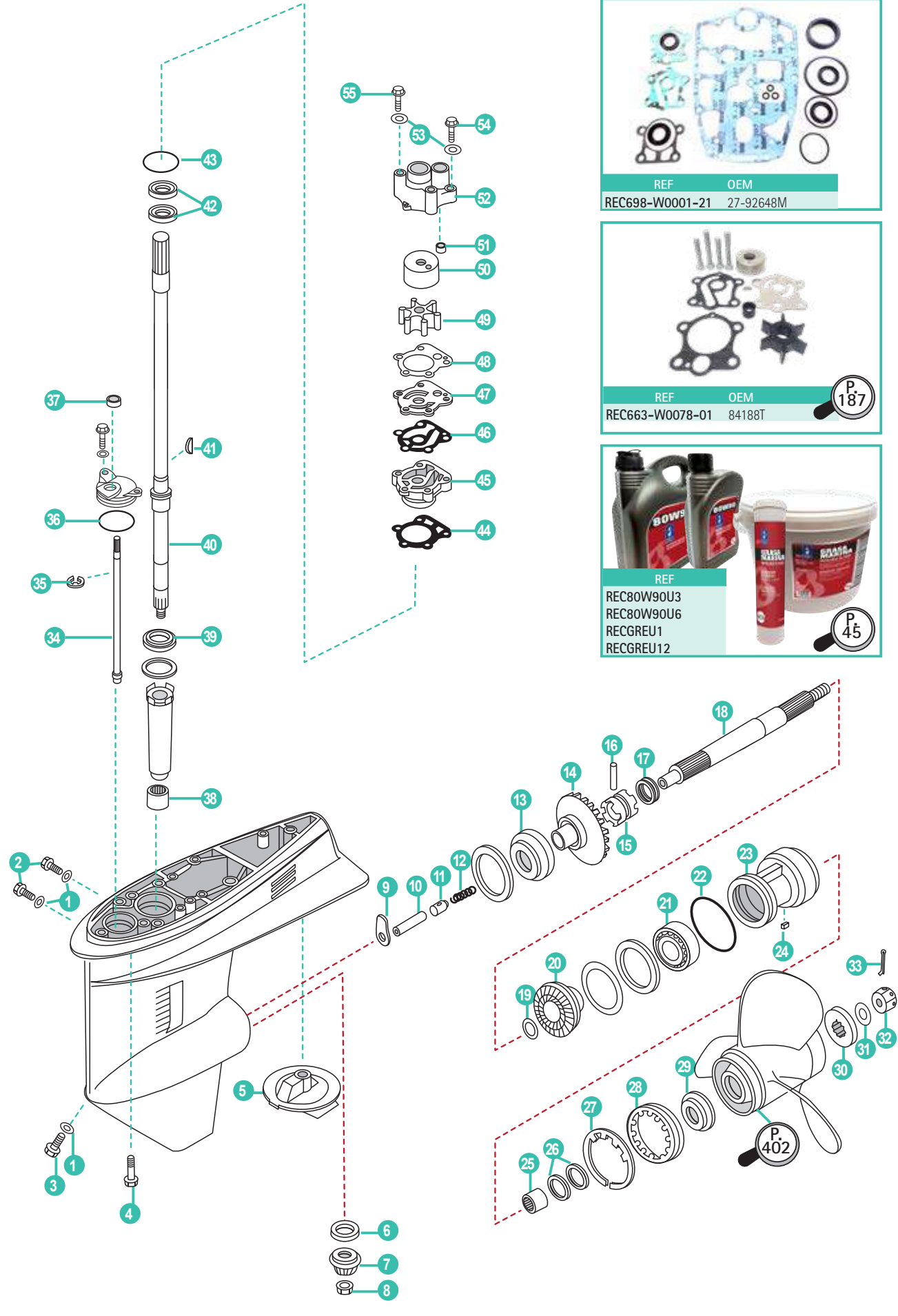

REF	OEM
REC698-W0001-21	27-92648M

REF	OEM
REC663-W0078-01	84188T

P 187

REF
REC80W90U3
REC80W90U6
RECGREU1
RECGREU12

P 45

	REF	OEM				
1	REC90430-08020	27-81987M	JUNTA	GASKET	GUARNIZIONE	JOINT DE VIDANGE
2	REC90340-08002	22-81924M	TORNILLO	STRAIGHT SCREW	VITE	VIS
3	REC688-45341-00	22-95632M	TAPÓN, DRENAJE	PLUG, DRAIN	VITE DRENAGGIO	BOUCHON DE VIDANGE
4	REC97075-10040	10-82474M	PERNO	BOLT	PERNO	BOULON
5	TEN01101	83859M	ÁNODO	ANODE	ANODO	ANODE
6	REC663-45552-00	12-81455M	COJINETE PLANO	BEARING, PLAIN	CUSCINETTO PIATTO	ROULEMENT
7	REC697-45551-00	43-84208M	PIÑÓN ATAQUE	INITIATIVE GEAR	MARCIA INIZIATIVA	PIGNON D'ATTAQUE
8	REC90170-12138	11-81772M	TUERCA	NUT	DADO	ÉCROU
9	REC663-44151-00	81409M	LEVA DE CAMBIO	CAM SHIFT	ALBERO	CAME
10	REC688-45635-00	81476M	PLUNGER, SHIFT	ÉMBOLO DE CAMBIO	CAMBIO PISTONE	PISTON
11	REC663-45634-00	81475M	DESLIZADOR CAMBIO	SLIDE, SHIFT	SCORREVOLE	DOUILLE
12	REC90501-16233	24-82091M	RESORTE DE COMPRESIÓN	SPRING	MOLLA	RESSORT
13	REC93332-00003	31-82320M	COJINETE	BEARING	CUSCINETTO	ROULEMENT
14	REC697-45560-00	43-84206M	PIÑÓN MARCHA AVANTE	POSITIVE GEAR ASSY	PIGNONE MARCIA AVANTI	PIGNON DE MARCHE AVANT
15	REC663-45631-00	52-81473M	EMBRAGUE DE GARRA	CLUTCH, DOG	GIUNTO A DENTI FRONTALE	CRABOT
16	REC90250-06023	17-81903M	PASADOR CILÍNDRICO	PIN, STRAIGHT	SPINOTTO	PIN
17	REC663-45633-00	81474M	ANILLO DE PASADOR	RING, CROSS PIN	O-RING	JOINT TORIQUE
18	REC697-45611-00	44-81472M	EJE PROPULSOR	SHAFT PROPELLER	ASSE	ARBRE D'HELICE
19	REC90201-22429	12-81837M	ARANDELA PLANA	WASHER, PLATE	RONDELLA	RONDELLE
20	REC697-45570-00	43-84207M	PIÑÓN MARCHA ATRÁS	REVERSE GEAR	PIGNONE MARCIA INDIETRO	PIGNON MARCHE ARRIÈRE
21	REC93306-00702	30-82296M	COJINETE	BEARING	CUSCINETTO	ROULEMENT
22	REC93210-66M98	25-82289M	ANILLO O	O- RING	O-RING	JOINT TORIQUE
23	REC663-45331-00-94	81446M	CAJA DE COJINETE	HOUSING, BEARING	SEDE CUSCINETTO	DIABOLO
24	REC90282-04010	28-81916M	CHAVETA	KEY, STRAIGHT	CHIAVETTA	CLAVETTE
25	REC93317-22204	31-82317M	COJINETE	BEARING	CUSCINETTO	ROULEMENT
26	REC93101-22067	26-82233M	SELLO ACEITE	OIL SEAL	PARAOLIO	JOINT SPI
27	REC90214-48M03	14-81877M	ARANDELA	WASHER	RONDELLA	RONDELLE
28	REC697-45384-00	11-81450M	TUERCA	NUT	DADO	ÉCROU
29	REC663-45987-00	73345	ESPACIADOR	SPACER	DISTANZIALE	ENTRETOISE
30	REC670-45997-00		ESPACIADOR	SPACER	DISTANZIALE	ENTRETOISE
31	REC92990-16200		ARANDELA PLANA	WASHER, PLAIN	RONDELLA	RONDELLE
32	REC90171-16011	11-81775M	TUERCA ENTALLADA	NUT, CASTLE	DADO	ÉCROU D'HELICE
33	REC91490-30025	18-82135M	CHAVETA	PIN, COTTER	CHIAVETTA	GOUPILLE
34	REC663-44144-01	81408M	VARILLA DE CAMBIO	ROD, SHIFT	ASTICELLA	LEVIER DE VITESSE
35	REC99001-08600-00	53-82334M	CLIP	CLIP	CLIP	CLAVETTE
36	REC93210-49046	25-82281M	ANILLO	O-RING	O-RING	JOINT TORIQUE
37	REC93106-09014	26-82257M	RETÉN DE ACEITE	OIL SEAL	PARAOLIO	JOINT SPI
38	REC93315-32224	31-82316M	COJINETE DE RODILLOS	BEARING	CUSCINETTO	ROULEMENT
39	REC93332-00001	31-82319M	COJINETE	BEARING	CUSCINETTO	ROULEMENT
40	REC663-45510-01	45-81451M	EJE DE MANDO	DRIVE SHAFT ASSY	ASSE VERTICALE	ARBRE VERTICAL
41	REC90280-03M03	28-81912M	CHAVETA	KEY, WOODRUFF	CHIAVE	CLAVETTE
42	REC93101-23070	26-82234M	SELLO ACEITE	OIL SEAL	PARAOLIO	JOINT SPI
43	REC93210-41042	25-82275M	ANILLO O	O-RING	O-RING	JOINT TORIQUE
44	REC663-44316-A0	27-81418M	EMPAQUE	GASKET, WATER PUMP	GUARNIZIONE	JOINT DE POMPE À EAU
45	REC663-44311-02	46-81422M	CAJA BOMBA	HOUSING, WATER PUMP	CORPO POMPA	BASE DE POMPE À EAU
46	REC663-44324-00	27-81421M	EMPAQUE	GASKET, CARTRIDGE	GUARNIZIONE	JOINT
47	REC663-44323-00	81420M	PLACA EXTERIOR	OUTTER PLATE	PIASTRA EXT.	PLAQUE DE POMPE À EAU
48	REC663-44315-A0	27-81417M	EMAPAQUE	GASKET, WATER PUMP	GUARNIZIONE	JOINT
49	REC6H3-44352-00	47-82824M	IMPULSOR	IMPELLER	GIRANTE	TURBINE
50	REC663-44322-00	81419M	CARTUCHO	INSERT CARTRIDGE	CARTUCCIA	INSERT DE POMPE À EAU
51	REC663-44366-00	26-81426M	GOMA SELLO	DAMPER, WATER SEAL	BOCCOLA GOMMA	BAGUE
52	REC663-44311-02	46-81416M	CAJA BOMBA	HOUSING, WATER PUMP	CORPO POMPA	CORPS DE POMPE À EAU
53	PAGB/T97.1-8	12-82217M	ARANDELA	WASHER	RONDELLA	RONDELLE
54	REC97095-08045	10-82468M	PERNO	BOLT	VITE	VIS
55	REC97095-08055	10-84057M	PERNO	BOLT	VITE	VIS

2T 2.0, 2.4, 2.5, V6
STROKES L4, L6, V6 (65-225 HP)

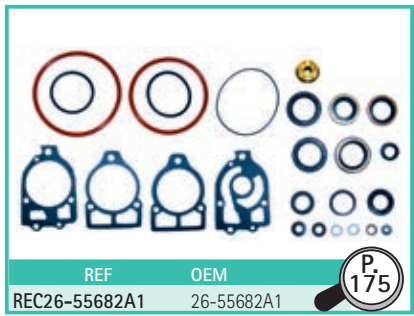
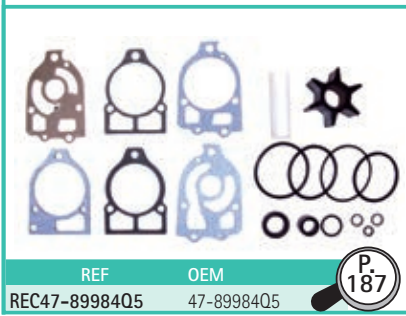
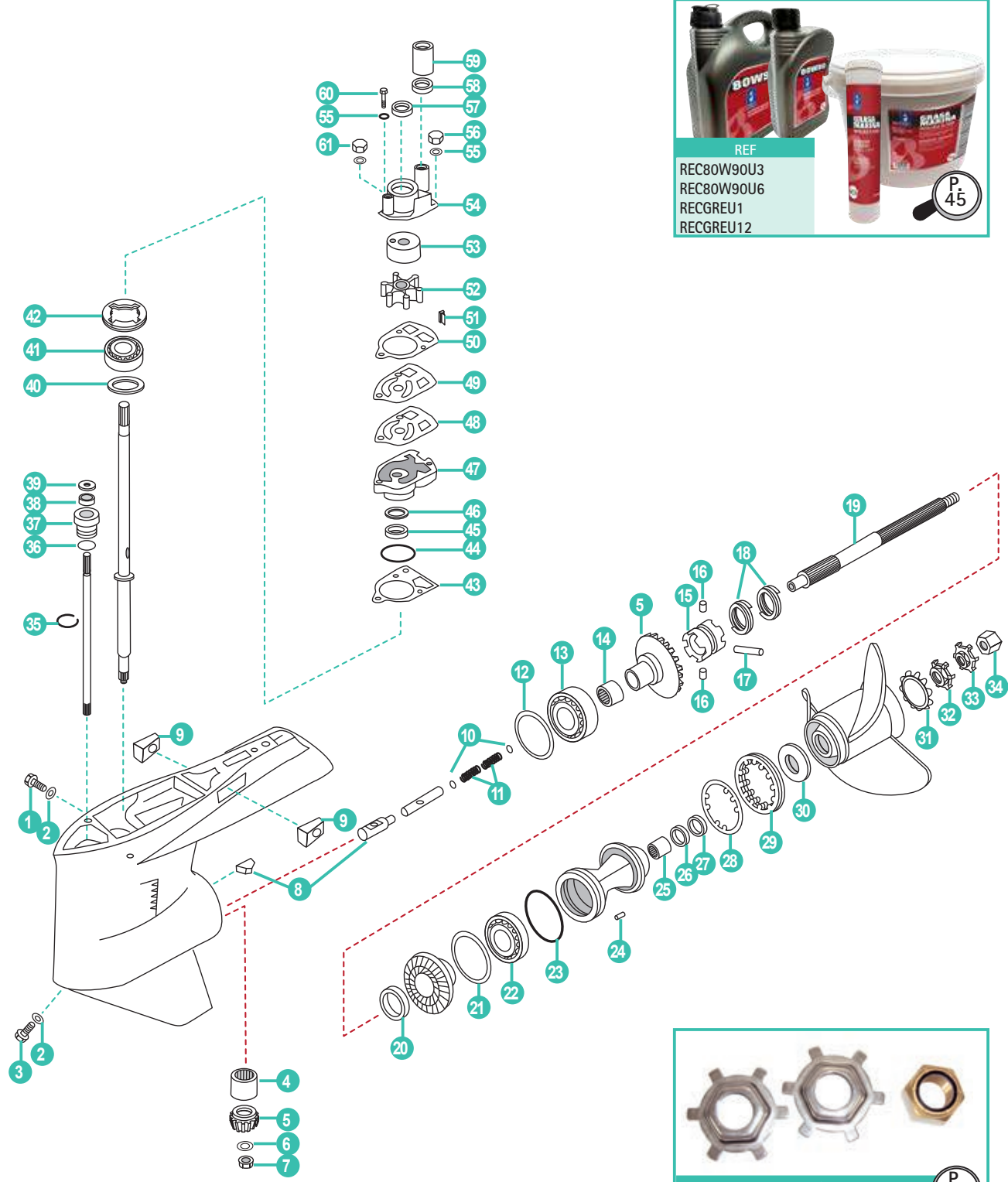

	REF	OEM				
1	REC10-79953Q04	10-79953Q2	TAPÓN, DRENAJE	PLUG, DRAIN	VITE DRENAGGIO	BOUCHON DE VIDANGE
2	REC12-191833	12-19183-3	JUNTA	GASKET	GUARNIZIONE	JOINT DE VIDANGE
3	REC22-67892A05	22-67892A1	TAPÓN, DRENAJE	PLUG, DRAIN	VITE DRENAGGIO	BOUCHON DE VIDANGE
4	REC387817	31-42647A1	COJINETE MODELOS V6	BEARING V6 MODELS	CUSCINETTO MODELLO V6	ROULEMENT V6
	REC31-32898T	31-32898T	COJINETE MODELOS EN LÍNEA	BEARING IN LINE MODELS	CUSCINETTO MODELLO IN LINEA	ROULEMENT LIGNE
5	REC43-859321A3	43-859321A3	MARCHA AVANTE (1.75:1)	P/FORWARD GEAR (1.75:1)	MARCIA IN AVANTI (1.75:1)	MARCHE AVANT (1.75:1)
6	REC350038	12-92721	ARANDELA	WASHER	RONDELLA	RONDELLE
7	REC11-35921	11-35921	TORNILLO	NUT	VITE	VIS
8	REC89594A1	89594A1	KIT EMPUJADOR	SHIFT KIT	KIT CAM/CAMBIO	KIT PISTON
9	CM826134	826134Q	ÁNODO ZINC	ANODE ZINC	ANODO ZINCO	ANODE ZINC
	CM826134A	826134Q	ÁNODO ALUMINIO	ANODE ALUMINUM	ANODO ALLUMINIO	ANODE ALUMINIUM
10	REC12-78910	12-78910	ARANDELA	WASHER	RONDELLA	RONDELLE
11	REC24-79910	24-79910	MUELLE	SPRING	MOLLA	RESSORT
12	REC15-47397A1	15-47397A1	KIT SUPLEMENTOS	SHIM SET	KIT SUPPLEMENTI	KIT CALE
13	REC31-30894A1	31-30894A1	COJINETE MODELOS EN LÍNEA	BEARING IN LINE MODELS	CUSCINETTO MODELLO IN LINEA	ROULEMENT LIGNE
	REC31-78172A1	31-78172A1	COJINETE MODELOS V 3.543"	BEARING V-MODELS 3.543"	CUSCINETTO MODELLO V 3.543"	ROULEMENT V3.543"
14	REC382343	31-54928-1	COJINETE MODELOS V	BEARING V-MODELS	CUSCINETTO MODELLO V	ROULEMENT V
	REC31-30895T	31-30895T	COJINETE MODELOS EN LÍNEA	BEARING IN LINE MODELS	CUSCINETTO MODELLO IN LINEA	ROULEMENT LIGNE
	REC52-853594T	52-853594T	SELECTOR	CLUTCH DOG	SELETTORE	CRABOT
	REC52-853594T	52-853594T	SELECTOR MODELOS V SIN PASADOR	CLUTCH DOG V-MODELS NON-RACHETING	SELETTORE MODELLO V SENZA SPINOTTO	CRABOT V SANS PIN
15	REC17-828356	17-828356	PASADOR (VERSIÓN 2 PINES)	DETENT PIN (DOUBLE PIN VERSION)	CHIAVETTA (2 SPINOTTI)	CLAVETTE (2 PINS)
17	REC17-8M0084681	17-30632	PASADOR MODELOS EN LÍNEA	CROSS PIN IN LINE MODELS	CHIAVETTA MODELLO IN LINEA	CLAVETTE LIGNE
	REC17-8M0084243	17-78905	PASADOR MODELOS V	CROSS PIN V-MODELS	CHIAVETTA MODELLO V	CLAVETTE V
18	REC24-30893	24-30893	MUELLE (VERSIÓN SIMPLE)	SPRING (SINGLE VERSION)	MOLLA (VERSIONE SIMPLE)	RESSORT (SIMPLE)
	REC24-78962	24-78962	MUELLE (VERSIÓN DOBLE)	SPRING (DOUBLE VERSION)	MOLLA (VERSIONE DOPPIA)	RESSORT (DOUBLE)
19	REC44-94148	44-94148	EJE HÉLICE (V6)	PROP SHAFT (V6)	ASSE ELICA (V6)	AXE D'HÉLICE (V6)
20	REC23-824108	23-824108	ESPACIADOR	THRUST SPACER	DISTANZIALE	ENTRETOISE
21	REC681001	68100-1	ARO	THRUST RING	O-RING	ENTRETOISE DE PIGNON
22	REC30-88957T	30-88957T	COJINETE	BEARING	CUSCINETTO	ROULEMENT
23	REC25-31534	25-896524	ARO TÓRICO	O-RING	O-RING	JOINT TORIQUE
24	REC28-30281	28-30281	CHAVETA	KEY	CHIAVETTA	CLAVETTE
25	REC387247	31-30956T	COJINETE	BEARING	CUSCINETTO	ROULEMENT
26	REC26-76868	26-76868	RETÉN ACEITE	OIL SEAL	PARAOILIO	JOINT SPI
27	REC26-12224	26-12224	RETÉN ACEITE	OIL SEAL	PARAOILIO	JOINT SPI
28	REC14-79447	14-79447	ARANDELA CIERRE	KEYED WASHER	RONDELLA CHIUSURA	RONDELLE
29	REC8M2011027	79448	TOPE TUERCA	COVER NUT	PUNTA DADO	ÉCROU A CRENAUX P
30	REC12-835467Q01	12-835467-1	TOPE HÉLICE	THRUST HUB	PUNTA ELICA	RONDELLE D'HÉLICE
31	REC13-423511	13-42351-1	CIERRE HÉLICE	LOCKWASHER	CHIUSURA ELICA	RONDELLE FREIN
32	REC12-31211Q03	12-31211A3	ARANDELA	WASHER	RONDELLA	RONDELLE
33	REC90508-ZW1-003	14-816629Q	ARANDELA	TAB WASHER	RONDELLA	RONDELLE
34	REC90301-ZW1-003	11-827614	TUERCA	LOCK NUT	DADO	ÉCROU
35	REC53-29641	53-29641	ARO RETENEDOR	RETAINING RING	CLIP	CLIPS
36	REC25-25439	25-25439	ARO TÓRICO	O-RING	O-RING	JOINT TORIQUE
37	REC23-77631A2	23-77631A2	CASQUILLO	BUSHING	GHIERA	INSERT
38	REC26-8164641	26-816464-1	RETÉN ACEITE	OIL SEAL	PARAOILIO	JOINT SPI
39	REC12-77674	12-77674	JUNTA	GASKET	GUARNIZIONE	JOINT
40	REC15-42637A1	15-42637A1	KIT SUPLEMENTOS	SHIM SET	KIT SUPPLEMENTI	KIT CALE
41	REC31-53079A1	31-63079A1	COJINETE (EJE 11163)	BEARING (SHAFT 11163)	CUSCINETTO (ASSE 11163)	ROULEMENT (AXE 11163)
	REC31-36387A1	31-36387A1	COJINETE	BEARING	CUSCINETTO	ROULEMENT
42	REC8245191	824519-1	RETENDOR	RETAINER	RITENITORE	RETENUE
43	REC27-426311	27-42631-1	JUNTA	GASKET	GUARNIZIONE	JOINT
44	REC25-90011	25-90011	ARO TÓRICO	O-RING	O-RING	JOINT TORIQUE
45	REC26-89238	26-89238	RETÉN ACEITE	OIL SEAL	PARAOILIO	JOINT SPI
46	REC26-16977	26-16977	RETÉN ACEITE	OIL SEAL	PARAOILIO	JOINT SPI
47	REC46-8M0077147	46-42579A3	BASE BOMBA	PUMP BASE	BASE POMPA	BASE POMPE
48	REC27-856081	27-85608-1	JUNTA	GASKET	GUARNIZIONE	JOINT
49	REC324351	32435	CIERRE BOMBA	WEAR PLATE	CHIUSURA POMPA	PLAQUE POMPE D'EAU
50	REC27-858524	27-858524	JUNTA	GASKET	GUARNIZIONE	JOINT
51	REC8M0032834	28-56654	CHAVETA	KEY	CHIAVETTA	CLAVETTE
52	REC47-89984T4	47-89984T4	IMPULSOR	IMPELLER	GIRANTE	TURBINE
53	REC48752T	48752T	TAPA BOMBA	PUMP CUP	COPERCHIO POMPA	COUVERCLE DE POMPE
54	REC46-96148T1	46-96148T1	CUERPO BOMBA	PUMP HOUSING	CORPO POMPA	CORPS DE POMPE A EAU
55	REC12-29245	12-29245	ARANDELA	WASHER	RONDELLA	RONDELLE
56	REC11-8267089	11-13438	TUERCA	NUT	DADO	ÉCROU
57	REC25-30271	25-30271	PASADOR	SLINGER	CHIAVETTA	PIN
58	REC26-38970	26-38970	RETÉN	SEAL	TENUTA	JOINT SPI
59	REC23-29804T	23-29804	TUBO GUÍA	TUBE GUIDE	TUBO GUIDA	TUBE GUIDE
60	REC10-96411	10-96411	TORNILLO	SCREW	VITE	VIS
61	REC11-13436	11-13436	TUERCA	NUT	DADO	ÉCROU

2T 3.0L: 225 CARB
STROKES 225, 250EFI/DFI

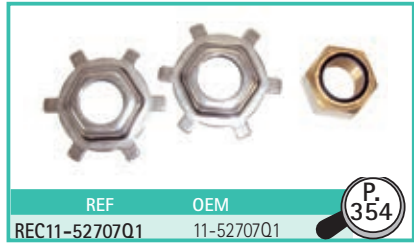
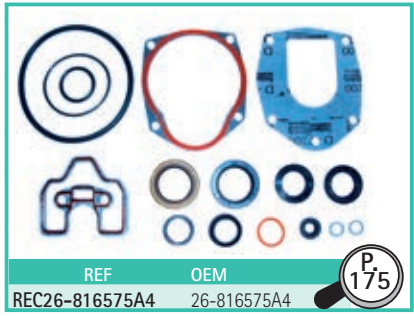
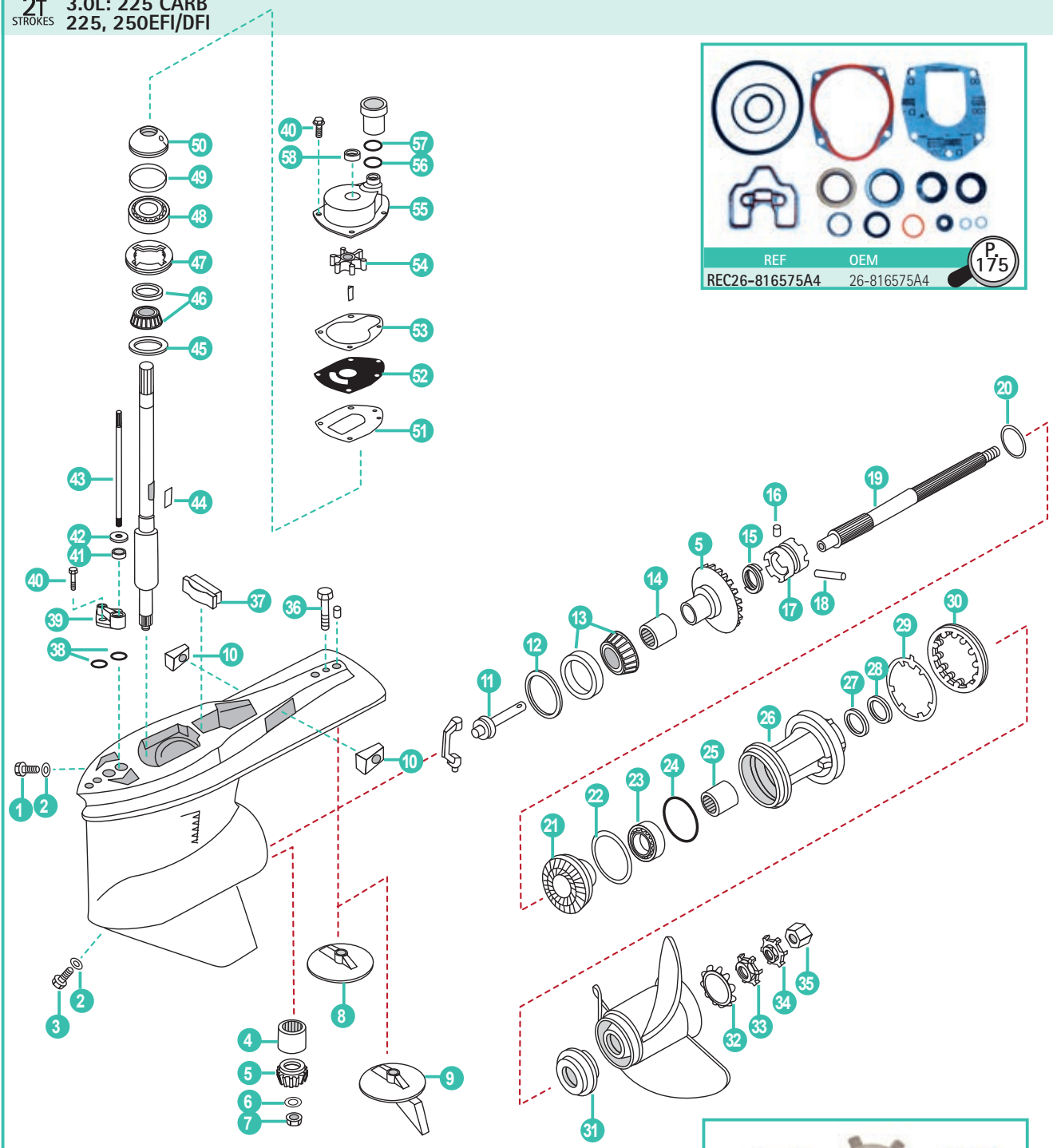



	REF	OEM				
1	REC10-79953Q04	10-79953Q2	TORNILLO	SCREW SET	VITE	VIS
2	REC12-191833	12-19183-2	JUNTA	GASKET	GUARNIZIONE	JOINT DE VIDANGE
3	REC22-67892A05	22-67892A1	TORNILLO DRENAJE	DRAINING SCREW	VITE DRENAGGIO	VIS DE VIDANGE
4	REC387817	31-42647A1	COJINETE	BEARING	CUSCINETTO	ROULEMENT
5	REC43-859321A3	43-859321A3	KIT PIÑONES ATAQUE (1.75:1)	P/FORWARD GEAR (1.75:1)	KIT PIGNONI AVANTI (1.75:1)	KIT MARCHE AVANT (1.75:1)
6	REC350038	12-92721	ARANDELA	WASHER	RONDELLA	RONDELLE
7	REC11-35921	11-35921	TUERCA	NUT	DADO	ÉCROU
8	CM762145	76214Q5	ÁNODO ZINC	ANODE ZINC	ANODO ZINCO	ANODE ZINC
	CM762145A	76214Q5	ÁNODO ALUMINIO	ANODE ALUMINUM	ANODO ALLUMINIO	ANODE ALUMINIUM
9	CM31640	31640Q4	ÁNODO ZINC	ANODE ZINC	ANODO ZINCO	ANODE ZINC
	CM31640A	31640Q4	ÁNODO ALUMINIO	ANODE ALUMINUM	ANODO ALLUMINIO	ANODE ALUMINIUM
10	CM826134	826134Q	ÁNODO ZINC	ANODE ZINC	ANODO ZINCO	ANODE ZINC
	CM826134A	826134Q	ÁNODO ALUMINIO	ANODE ALUMINUM	ANODO ALLUMINIO	ANODE ALUMINIUM
11	REC818349T1	818349T1	EJE CAMBIO	SHIFT SPOOL	ASSE CAMBIO	AXE DE CHANGEMENT
12	REC15-47397A1	15-47397A1	SUPLEMENTO (3.500 O.D.)	SHIM (3.500 O.D.)	SPESSORE (3.500 O.D.)	CALE (3.500 O.D.)
	REC15-44491A1	15-44491A1	SUPLEMENTO (3.265 O.S.)	SHIM (3.265 O.S.)	SPESSORE (3.265 O.S.)	CALE (3.265 O.S.)
13	REC31-35928T1	31-35928A1/T1	COJINETE (1.875 I.D./3.500 O.D.)	BEARING (1.875 I.D./3.500 O.D.)	CUSCINETTO (1.875 I.D./3.500 O.D.)	ROULEMENT (1.875 I.D./3.500 O.D.)
	REC31-828439A2	31-828439A2	COJINETE (1.875 I.D./3.265 O.D.)	BEARING (1.875 I.D./3.265 O.D.)	CUSCINETTO (1.875 I.D./3.265 O.D.)	ROULEMENT (1.875 I.D./3.265 O.D.)
	REC31-30894A1	31-30894A1	COJINETE (1.750 I.D./3.265 O.D.)	BEARING (1.750 I.D./3.265 O.D.)	CUSCINETTO (1.750 I.D./3.265 O.D.)	ROULEMENT (1.750 I.D./3.265 O.D.)
14	REC31-30895T	31-30895T	COJINETE	BEARING	CUSCINETTO	ROULEMENT
15	REC24-30893	24-30893	MUELLE	SPRING	MOLLA	RESSORT
16	REC17-828356	17-828356	TAPA PASADOR	DETENT PIN	CHIAVETTA	PIN
17	REC52-853594T	52-853594T	SELECTOR	CLUTCH DOG	SELETTORE	CRABOT
	REC52-859340T	52-859340T	SELECTOR	CLUTCH DOG	SELETTORE	CRABOT
18	REC17-8M0084681	17-30632	PASADOR	CROSS PIN	CHIAVETTA	CLAVETTE
19	REC44-824110	44-824110	EJE HÉLICE	PROP SHAFT	ASSE ELICA	AXE D'HÉLICE
20	REC23-824108	23-824108	ESPACIADOR	THRUST SPACER	DISTANZIAELE	ENTRETOISE
21	REC43-828073A1	43-828073A1	KIT PIÑONES M. ATRÁS (1.62:1)	REVERSE GEAR (1.62:1)	KIT PIGNONI INDIETRO (1.62:1)	KIT MARCHE ARRIÈRE (1.62:1)
22	REC681001	68100-1	ARO	THRUST RING	O-RING	ENTRETOISE DE PIGNON
23	REC30-88957T	30-88957T	COJINETE	BEARING	CUSCINETTO	ROULEMENT
24	REC25-31534	25-31534	ARO TÓRICO	O-RING	O-RING	JOINT TORIQUE
25	REC387247	30-30956	COJINETE	BEARING	CUSCINETTO	ROULEMENT
26	REC818763A10	818763A11/T11	COJINETE COLA	BEARING CARRIER	CUSCINETTO PIEDE	DIABOLO
27	REC26-76868	26-14077 26-76868	RETÉN	OIL SEAL	PARAOLIO	JOINT SPI
28	REC26-12224	26-12224	RETÉN	OIL SEAL	PARAOLIO	JOINT SPI
29	REC14-18323	14-18323	ARANDELA	TAB WASHER	RONDELLA	RONDELLE
30	REC8M2011027	79448	TUERCA CIERRE	COVER NUT	DADO CHIUSURA	ECROU À CRENAUX
31	REC12-31211Q01	12-835467	TOPE HÉLICE	THRUST WASHER	PUNTA ELICA	RONDELLE BUTEE D'HELICE
32	REC13-423511	13-42351-1	CIERRE	LOCKWASHER	CHIUSURA	RONDELLE FREIN
33	REC12-31211Q03	12-31211A3	TOPE CIERRE	TAB WASHER RECEIVER	PUNTA CHIUSURA	RONDELLE FREIN DE DIABOLO
34	REC90508-ZW1-003	14-816629	CIERRE HELICE	TAB WASHER	CHIUSURA ELICA	RONDELLE FREIN
35	REC11-52707Q1	11-827614Q	TUERCA CIERRE	LOCK NUT	DADO CHIUSURA	KIT ÉCROU D'HÉLICE
36	REC10-806327	10-806327	TORNILLO	SCREW	VITE	VIS
37	REC821526001	821526	TAPÓN SEPARADOR	FILLER BLOCK	TAPPO	PROTECTION CAOUTCHOUC
38	REC25-36318	25-36318	ARO TORICO	O-RING	O-RING	JOINT TORIQUE
39	REC23-815921A21	23-815921A4	CUERPO VARILLA	SHIFT BUSHING	CORPO ASTICELLA	INSERT D'AXE
40	REC10-816928	10-19937-16	TORNILLO	SCREW	VITE	VIS
41	REC26-8164641	26-816464-1	RETÉN	OIL SEAL	PARAOLIO	JOINT SPI
42	REC12-77674	12-77674	JUNTA	GASKET	GUARNIZIONE	JOINT
43	REC824145	824145	EJE CAMBIO	SHIFT SHAFT	ASSE CAMBIO	AXE DE CHANGEMENT
44	REC28-8M0032833	28-43037	CHAVETA	KEY	CHIAVETTA	CLAVETTE
45	REC15-42637A1	15-42637A1	SUPLEMENTO	SHIM	SPESSORE	CALE
46	REC31-36387A1	31-36387A1	COJINETE	BEARING	CUSCINETTO	ROULEMENT
47	REC8245191	824519-1	RETENEDOR	RETAINER	RITENETORE	RETENUE
48	REC26-66302	26-66302	RETÉN	OIL SEAL	PARAOLIO	JOINT SPI
49	REC25-90011	25-90011	ARO TÓRICO	O-RING	O-RING	JOINT TORIQUE
50	REC807929A1	807929A1	BASE BOMBA	CARRIER ASSY.	BASE POMPA	BASE DE POMPE
51	REC27-430331	27-43033-1	JUNTA	GASKET	GUARNIZIONE	JOINT
52	REC8172761	817276-1	TAPA BOMBA	WEAR PLATE	COPERCHIO POMPA	CORPS DE POMPE
53	REC27-8172771	27-817277-1	JUNTA	GASKET	GUARNIZIONE	JOINT
54	REC47-43026Q02	47-43026T2	IMPULSOR	IMPELLER	GIRANTE	TURBINE
55	RM817275A1	817275A1	TAPA BOMBA	WATER PUMP ASSY.	COPERCHIO POMPA	COUVERCLE POMPE
56	REC25-21836	25-21836	ARO TÓRICO	O-RING	O-RING	JOINT TORIQUE
57	REC25-35027	25-35027	ARO TÓRICO	O-RING	O-RING	JOINT TORIQUE
58	REC26-816575A2	26-816575A2	RETÉN GOMA	FACE SEAL	TENUTA GOMMA	RETENU EN CAOUTCHOUC

GUÍA KITS DE PIÑONES

GEAR SETS GUIDE

GUIDA KIT PIGNONI

GUIDE KITS DES PIGNONS

🔧	REDUCCIÓN RATIO RIDUZIONE REDUCTION	DIENTES JAW DENTI DENTS	KIT COMPLETO COMPLETE GEAR SET KIT COMPLETO KIT COMPLET		KIT 				
			REF	OEM	REF	OEM	REF	OEM	
40 - 50 HP (3 CYL)	9973100	1.83:1 (12:22)			REC43-803498T1	43-803498T1	REC43-822163T1	43-8822163T1	
50 HP (3 CYL)	9683055 - 9973099								
55 HP (3 CYL)	9741042	1.64:1 (14:23)			REC43-803499T1	43-803499T1		43-813695T	
60 HP (3 CYL)	9683055								
L4 100 HP (1.85L)	9523034	2.07:1 (14:29)							
L4 115 HP (1.85L)									
115 EFI (1.75L)	955971	Selector Cluth Selettore Crabot REC52-850048T	6	REC11557		43-803028T1 43-881260A5		43-850036T	
115 Optimax (1.50L)									
L4 125 HP (1.85L) Classic	9793577								
V6 200, 225 (3.0 L DFI) (1998+)	OG590000+	1.75:1 (12:21)			REC43-859321A3	43-859321A3		43-8859322A1	
V6 225, 250 (3.0 L EFI) (1995+)	OG129222+								
V6 225 Seapro (3.0 L Carb) (1994-98)	OG245605 - OG437999	1.62:1 (13:21)	6				REC43-828073A1	43-828073A1	
V6 225 (3.0 L Carb) (1994-98)	OD280813+								
V6 150 HP (1985)	6616991 - OA904645								
V6 175 HP (1980-81)	5393737 - 668750	2.0 (14:28)		REC11770		43-803619T1		43-85462T	
V6 200 HP (1980-81)	5393737 - 607319								
V6 150 HP (XR4, MAG III) 150 EFI (1993-98)	OD082000 - OG437999								
V6 175, 175 EFI (1985-98)	661875 - OG437999	1.87:1 (15:28)		REC43-44104T2	43-44104T2		43-44104A8	43-824986A2	
V6 200, 200 EFI (1985-98)	6625221 - OG437999								
V6 220 HP (1987-88)	B117319 +								
V6 225 HP	6437999								
V6- 3.0 L Carb		1.62 (13:21)			43-828072A2		43-828072A2	43-828073A1	
V6 225 Marathon									
V6 225 Seapro									



REC11557



REC11770



REC43-44104T2



REC43-803498T1



REC43-859321A3



REC43-878087A2



REC43-822163T1



REC43-828073A1

GUÍA PIÑONES

GEAR GUIDE

GUIDA PIGNONI

GUIDE DES PIGNONS

	CYL			KIT			
40	4	1989	USA	0C159200 +			REC31-38356A1
40	4	1989	BEL	9570790			REC31-38356A1
45	4	1986	USA	5531630			REC31-38356A1
45	4	1986	AUS	8063985			REC31-38356A1
45	4	1986	BEL	9248006			REC31-38356A1
45	4	1986	CAN	7143688			REC31-38356A1
50	4	1980-85	USA	5531630			REC31-38356A1
50	4	1980-85	AUS	8063985			REC31-38356A1
50	4	1980-85	BEL	9248006			REC31-38356A1
50	4	1980-85	CAN	7143688			REC31-38356A1
40	3	1997-98	USA	0G531301 +	REC43-803498T1	REC43-822163T1	REC31-66668A1
40	3	1997-98	BEL	9973100	REC43-803498T1	REC43-822163T1	REC31-66668A1
50	3	1991-95	USA	0D000750 - 0G589999	REC43-803499T1		REC983892
50	3	1991-95	BEL	9683055 - 9973099	REC43-803499T1		REC983892
50	3	1998	USA	0G590000 +	REC43-803498T1	REC43-822163T1	REC31-66668A1
50	3	1998	BEL	9973100	REC43-803498T1	REC43-822163T1	REC31-66668A1
55	3	1996	USA	0D000750 +	REC43-803499T1		REC983892
55	3	1996	BEL	9741042	REC43-803499T1		REC983892
60 Standard, Non-Bigfoot	3	1991-95	USA	0D000750 +	REC43-803499T1		REC983892
60 Standard, Non-Bigfoot	3	1991-95	BEL	9683055	REC43-803499T1		REC983892
60 3 Jaw Rev. Clutch Bigfoot	3	1991-95	USA	0D000750 - 0G589999			REC31-30894A1
60 3 Jaw Rev. Clutch Bigfoot	3	1991-95	BEL	9683055-9973099			REC31-30894A1
60 6 Jaw Rev. Clutch Bigfoot	3	1991-95	USA	0D000750 - 0G589999			REC31-30894A1
60 6 Jaw Rev. Clutch Bigfoot	3	1991-95	BEL	9683055 - 9973099			REC31-30894A1
60 6 Jaw Rev. Clutch Bigfoot	3	1998	USA	590000			REC31-30894A1
60 6 Jaw Rev. Clutch Bigfoot	3	1998	BEL	9973100			REC31-30894A1
70 3 Jaw Rev. Clutch	3	1987	USA	0A996142 - 0C221999			REC31-30894A1
70 3 Jaw Rev. Clutch	3	1987	BEL	9483121 - 9589038			REC31-30894A1
70 6 Jaw Rev. Clutch	3	1987	USA	0A996142 - 0C221999			REC31-30894A1
70 6 Jaw Rev. Clutch	3	1987	BEL	9483121 - 9589038			REC31-30894A1
75 3 Jaw Rev. Clutch	3	1990-93	USA	0A996142 +			REC31-30894A1
75 3 Jaw Rev. Clutch	3	1990-93	BEL	9483121			REC31-30894A1
75 6 Jaw Rev. Clutch	3	1994-98	USA	0A996142 +			REC31-30894A1
75 6 Jaw Rev. Clutch	3	1994-98	BEL	9483121			REC31-30894A1
80 3 Jaw Rev. Clutch	3	1987	USA	0A996142 - 0C221999			REC31-30894A1
80 3 Jaw Rev. Clutch	3	1987	BEL	9483121 - 9589038			REC31-30894A1
80 6 Jaw Rev. Clutch	3	1987	USA	0A996142 - 0C221999			REC31-30894A1
80 6 Jaw Rev. Clutch	3	1987	BEL	9483121 - 9589038			REC31-30894A1
90 3 Jaw Rev. Clutch	3	1987	USA	0A996142 +			REC31-30894A1
90 3 Jaw Rev. Clutch	3	1987	BEL	9483121			REC31-30894A1
90 6 Jaw Rev. Clutch	3	1987	USA	0A996142 +			REC31-30894A1
90 6 Jaw Rev. Clutch	3	1987	BEL	9483121			REC31-30894A1
100 3 Jaw Rev. Clutch	4	1988-93	USA	0B209468 +			REC31-30894A1
100 3 Jaw Rev. Clutch	4	1988-93	BEL	9523034			REC31-30894A1
100 High Altitude 3 Jaw Rev. Clutch		1988-93	USA	0B209468 +			REC31-30894A1
100 High Altitude 3 Jaw Rev. Clutch		1988-93	BEL	9523034			REC31-30894A1
100 6 Jaw Rev. Clutch	4	1988-98	USA	0B209468 +	REC11557		REC31-30894A1
100 6 Jaw Rev. Clutch	4	1988-98	BEL	9523034	REC11557		REC31-30894A1
100 High Altitude 6 Jaw Rev. Clutch		1988-93	USA	0B209468 +			REC31-30894A1
100 High Altitude 6 Jaw Rev. Clutch		1988-93	BEL	9523034			REC31-30894A1
115 3 Jaw Rev. Clutch	4	1988-93	USA	0C100000 +			REC31-30894A1
115 3 Jaw Rev. Clutch	4	1988-93	BEL	9559771			REC31-30894A1
115 High Altitude 3 Jaw Rev. Clutch		1989-93	USA	0C100000 +			REC31-30894A1
115 High Altitude 3 Jaw Rev. Clutch		1989-93	BEL	9559771			REC31-30894A1
115 6 Jaw Rev. Clutch	4	1989-93	USA	0C100000 +	REC11557		REC31-30894A1
115 6 Jaw Rev. Clutch	4	1989-93	BEL	9559771	REC11557		REC31-30894A1
115 High Altitude 6 Jaw Rev. Clutch		1989-93	USA	0C100000 +			REC31-30894A1
115 High Altitude 6 Jaw Rev. Clutch		1989-93	BEL	9559771			REC31-30894A1
125 3 Jaw Rev. Clutch	4	1994-98	USA	0D283222 +			REC31-30894A1
125 3 Jaw Rev. Clutch	4	1994-98	BEL	9793577			REC31-30894A1
125 High Altitude 3 Jaw Rev. Clutch		1994-98	USA	0D283222 +			REC31-30894A1
125 High Altitude 3 Jaw Rev. Clutch		1994-98	BEL	9793577			REC31-30894A1
125 6 Jaw Rev. Clutch	4	1994-98	USA	0D283222 +	REC11557		REC31-30894A1
125 6 Jaw Rev. Clutch	4	1994-98	BEL	9793577	REC11557		REC31-30894A1

MERCURY

RECAMBIOS MARINOS

	CYL		KIT			
125 High Altitude 6 Jaw Rev. Clutch	1994-98	USA	OD283222 +			REC31-30894A1
125 High Altitude 6 Jaw Rev. Clutch	1994-98	BEL	9793577			REC31-30894A1
V-135 Std. Rotation, 2:1 Ratio,	1986-88	USA	0A904646 - OG437999			REC31-78172A1
V-135 Counter Rotation,	1989-90	USA	OC100861 - OG437999			REC31-78172A1
V-135 Std. Rotation, 2:1 Ratio,	1997-04	USA	OG438000 +			REC31-30894A1
V-135 Counter Rotation,	1997-04	USA	OG438000 +			REC31-30894A1
V-135 DFI Std. Rotation, 2:1,	1998-04	USA	OG590000 +			REC31-30894A1
V-150 Std. Rotation, 2:1 Ratio,	1986-88	USA	0A904646 - OG437999			REC31-78172A1
V-150 Counter Rotation, 2:1,	1989-90	USA	OC100861 - OG437999			REC31-30894A1
V-150 (XR4, MAG II) Torpedo	1988-91	USA	OC239553 - 04303045			REC31-78172A1
V-150 (XR4, MAG III) Torpedo	1988-91	USA	OD082000 - OG437999	REC43-44104T2		REC31-78172A1
V-150 EFI Std. Rotation, 1.87:1,	1993-95	USA	OD082000 - OG437999	REC43-44104T2		REC31-78172A1
V-150 Std. Rotation, 2:1,	1996-98	USA	OG438000 +			REC31-30894A1
V-150 (XR6, MAG III) Std. Rot., 1.87:1,	1996-98	USA	OG438000 +			REC31-30894A1
V-150 EFI Std. Rot., 1.87:1,	1996-98	USA	OG438000 +			REC31-30894A1
V-150 DFI Std. Rot., 1.87:1,	1998	USA	OG590000 +			REC31-30894A1
V-175 Std. Rot	1980-81	USA	5393737 - 6618750	REC11770		REC31-78172A1
V-175 Std. Rot.,	1980-81	AUS	8064250	REC11770		REC31-78172A1
V-175 Std. Rot., 1.87:1 Ratio,	1985-88	USA	6618751 - OG437999	REC43-44104T2		REC31-78172A1
V-175 Counter Rot., 1.87:1 Ratio,	1985-88	USA	6618751 - OG437999			REC31-78172A1
V-175 EFI Std. Rot., 1.87:1,	1991	USA	OD000750 - OG437999	REC43-44104T2		REC31-78172A1
V-175 EFI Counter Rot., 1.87:1,	1991	USA	OD082000 - OG437999			REC31-78172A1
V-175 Std. Rot., 1.87:1,	1996-98	USA	OG438000 +			REC31-30894A1
V-175 Counter Rot., 1.87:1,	1996-98	USA	OG438000 +			REC31-30894A1
V-175 EFI Std. Rot., 1.87:1,	1996-98	USA	OG438000 +			REC31-30894A1
V-175 Counter Rot., 1.87:1,	1996-98	USA	OG438000 +			REC31-30894A1
V-200 Std. Rot.	1978-79	USA	5393737 - 6073191	REC11770		REC31-78172A1
V-200 Std. Rot.	1980-81	AUS	8061595 - 8065672	REC11770		REC31-78172A1
V-200 Std. Rot.	1982-84	USA	6073192 - 6625220			REC31-78172A1
V-200 Std. Rot., 1.87:1,	1985-88	USA	6625221 - OC291519	REC43-44104T2		REC31-78172A1
V-200 Std. Rot., 1.87:1,	1991	USA	OC291520 - OG437999	REC43-44104T2		REC31-78172A1
V-200 EFI Std. Rot., 1.87:1,	1989-90	USA	OC100861 - OC291519	REC43-44104T2		REC31-78172A1
V-200 EFI Std. Rot., 1.87:1,	1991	USA	OC291520 - OG437999	REC43-44104T2		REC31-78172A1
V-200 EFI Counter Rot., 1.87:1,	1992-95	USA	OD082000 - OG437999			REC31-78172A1
V-200 DFI Std. Rot., 1.87:1,	1997-04	USA	OG437999			REC31-35928T1
V-200 DFI Std. Rot., 1.75:1,	1997	USA	OG438000 +	REC43-859321A3		REC31-30894A1
V-200 DFI Counter Rot., 1.75:1,	1997	USA	OG386496 - OG437999			REC31-35928T1
V-200 Std. Rot., 1.87:1,	1996-98	USA	OG438000 +			REC31-30894A1
V-200 Counter Rot., 1.87:1,	1996-98	USA	OG438000 +			REC31-30894A1
V-200 EFI Std. Rot., 1.87:1,	1996-98	USA	OG438000 +			REC31-30894A1
V-200 Counter Rot., 1.87:1,	1996-98	USA	OG438000 +			REC31-30894A1
V-200 DFI Counter Rot., 1.75:1,	1997	USA	OG438000 +			REC31-30894A1
200 (3.0L) DFI Std. Rot., 1.75:1 Ratio	1998	USA	OG590000 +	REC43-859321A3		REC31-30894A1
200 (3.0L) Std. Rot., 1.75:1 Ratio	1998	USA	OG590000 +	REC43-859321A3		REC31-30894A1
225 (3.0L) DFI Std. Rot., 1.75:1 Ratio	1998	USA	OG590000 +	REC43-859321A3		REC31-30894A1
225 (3.0 Carb) Sea Pro , 1.62:1	1994-98	USA	- OG437999		REC43-828073A1	REC31-35928T1/ REC31-828439A2
225 (3.0 Carb) Sea Pro , 1.75:1	1994-98	USA	- OG437999			REC31-35928T1/ REC31-828439A2
V-220 Std. Rot., 1.87:1 Ratio	1987-88	USA	B117316 +	REC43-44104T2		REC31-78172A1
V-225 Std. Rot.,	1980-81	USA	5628028			REC31-78172A1
225 (3.0 Carb) Std. Rot., 1.62:1 Ratio	1994-98	USA	OD280813 +		REC43-828073A1	REC31-35928T1/ REC31-828439A2
225 (3.0L) EFI Std. Rot., 1.75:1 Ratio	1995-98	USA	OG129222-OG437999			REC31-30894A1
225 (3.0L) EFI Std. Rot., 1.75:1 Ratio	1995-98	USA	OG438000 +	REC43-859321A3		REC31-30894A1
225 (3.0L) EFI Std. Rot., 1.87:1 Ratio	1995-98	USA	OG438000 +			REC31-30894A1
250 (3.0L) EFI Std. Rot., 1.75:1 Ratio	1995-98	USA	OG129222-OG437999	REC43-859321A3		REC31-30894A1
250 (3.0L) EFI Std. Rot., 1.75:1 Ratio	1995-98	USA	OG438000 +	REC43-859321A3		REC31-30894A1
250 (3.0L) EFI Std. Rot., 1.87:1 Ratio	1995-98	USA	OG438000 +			REC31-30894A1
250 / 275 Std. Rotation	1989-94	USA	C101891 +			REC31-35928T1

PIÑONES ATAQUE	INITIATIVE GEAR	PIGNONI INIZIATIVA	PIGNONS D'ATTAQUE
----------------	-----------------	--------------------	-------------------

REF	OEM	
REC43-803498T1		

REF	OEM	
REC43-859321A3		

REF	OEM	
REC43-803499T1		

PIÑONES MARCHA ATRÁS	REVERSE GEAR	PIGNONI MARCIA INDIETRO	PIGNON DE MARCHÉ ARRIÈRE
----------------------	--------------	-------------------------	--------------------------

REF	OEM	
REC43-822163T1		

REF	OEM	
REC43-828073A1		

PIÑONES MARCHA AVANTE	POSITIVE GEAR	PIGNONI MARCIA AVANTI	PIGNON DE MARCHÉ AVANT
-----------------------	---------------	-----------------------	------------------------

REF	OEM	
REC31-38356A1		

REF	OEM	
REC983892		

REF	OEM	
REC31-30894A1		

REF	OEM	
REC31-78172A1		







REF	OEM	
REC31-35928T1		

REF	OEM	
REC31-828439A2		

TUERCA DE PIÑÓN	PINION NUTS	DADI PIGNONI	ÉCROU PIGNON
-----------------	-------------	--------------	--------------

REF	OEM	
REC11-35921	11-35921	

REF	OEM	
REC313339	11-55910	

SELECTORES			CLUTCH DOGS	SELETTORI	CRABOT												
REF	OEM			<table border="1"> <thead> <tr> <th>REF</th> <th>OEM</th> <th>DIENTES CONTRAROTACIÓN JAW REVERSE DENTI CONTROROTANTI DENTS CONTREROTATION</th> </tr> </thead> <tbody> <tr> <td>REC52-853594T</td> <td>52-853594T</td> <td>6</td> </tr> <tr> <td>REC52-850048T</td> <td>52-850048T</td> <td>6</td> </tr> <tr> <td>REC52-859340T</td> <td>52-859340T</td> <td>6</td> </tr> </tbody> </table>		REF	OEM	DIENTES CONTRAROTACIÓN JAW REVERSE DENTI CONTROROTANTI DENTS CONTREROTATION	REC52-853594T	52-853594T	6	REC52-850048T	52-850048T	6	REC52-859340T	52-859340T	6
REF	OEM	DIENTES CONTRAROTACIÓN JAW REVERSE DENTI CONTROROTANTI DENTS CONTREROTATION															
REC52-853594T	52-853594T	6															
REC52-850048T	52-850048T	6															
REC52-859340T	52-859340T	6															
REC6E5-45631-00	52-96313M	4A (6E0) 5C (6E3)															
REC664-45631-00	52-81644T	20C (Thru Propex) 25C/K (Thru Propex) 28 30a / w30cw/ Marathon															
REC682-45631-00	52-84274M	9.9C 15C/K/ (long) W15															

4T
STROKES

GUÍA SELECTORES	CLUTCH DOGS GUIDE	GUIDA SELETTORI	GUIDE DES CRABOTS
	CYL	RATIO 2.31:1	RATIO 2.33:1
30	OP017000-OP153499	REC52-850048T	
30 Carb	3 OP153500-OP400999	REC52-850048T	REC52-850048T
40	9944807-OP153499	REC52-850048T	
40	4 OP094500-OP206999	REC52-850048T	
50	OP017000 +	REC52-850048T	
50	4 OP094500 +	REC52-850048T	
50 EFI	4 OP153500 +	REC52-850048T	REC52-850048T
60	4 OP094500-OP206999	REC52-850048T	
60 EFI	4 OP153500-OP515896		REC52-850048T

2T
STROKES

GUÍA SELECTORES	CLUTCH DOGS GUIDE	GUIDA SELETTORI	GUIDE DES CRABOTS
	CYL	REF	
50	3 1991-95 USA	OD000750-0G589999	REC52-850048T
50	3 1991-95 BEL	9683055-9973099	REC52-850048T
55	3 1996 USA	OD000750 +	REC52-850048T
55	3 1996 BEL	9741042	REC52-850048T
60 Standard, Non Bigfoot	3 1991-95 USA	OD000750 +	REC52-850048T
60 Standard, Non Bigfoot	3 1991-95 BEL	9683055	REC52-850048T
60 3 Jaw Rev. Clutch Bigfoot	3 1991-95 USA	OD000750-0G589999	
60 3 Jaw Rev. Clutch Bigfoot	3 1991-95 BEL	9683055-9973099	
60 6 Jaw Rev. Clutch Bigfoot	3 1991-95 USA	OD000750-0G589999	REC52-850048T
60 6 Jaw Rev. Clutch Bigfoot	3 1991-95 BEL	9683055-9973099	REC52-850048T
60 6 Jaw Rev. Clutch Bigfoot	3 1998 USA	590000	REC52-850048T
60 6 Jaw Rev. Clutch Bigfoot	3 1998 BEL	9973100	REC52-850048T
70 3 Jaw Rev. Clutch	3 1987 USA	0A996142-0C221999	
70 3 Jaw Rev. Clutch	3 1987 BEL	9483121-9589038	
70 6 Jaw Rev. Clutch	3 1987 USA	0A996142-0C221999	REC52-850048T
70 6 Jaw Rev. Clutch	3 1987 BEL	9483121-9589038	REC52-850048T
75 3 Jaw Rev. Clutch	3 1990-93 USA	0A996142 +	
75 3 Jaw Rev. Clutch	3 1990-93 BEL	9483121	
75 6 Jaw Rev. Clutch	3 1994-98 USA	0A996142 +	REC52-850048T
75 6 Jaw Rev. Clutch	3 1994-98 BEL	9483121	REC52-850048T

	CYL			REF	
80 3 Jaw Rev. Clutch	3	1987	USA	0A996142-0C221999	
80 3 Jaw Rev. Clutch	3	1987	BEL	9483121-9589038	
80 6 Jaw Rev. Clutch	3	1987	USA	0A996142-0C221999	REC52-850048T
80 6 Jaw Rev. Clutch	3	1987	BEL	9483121-9589038	REC52-850048T
90 3 Jaw Rev. Clutch	3	1987	USA	0A996142 +	
90 3 Jaw Rev. Clutch	3	1987	BEL	9483121	
90 6 Jaw Rev. Clutch	3	1987	USA	0A996142 +	REC52-850048T
90 6 Jaw Rev. Clutch		1987	BEL	9483121	REC52-850048T
100 3 Jaw Rev. Clutch		1988-93	USA	0B209468 +	
100 3 Jaw Rev. Clutch		1988-93	BEL	9523034	
100 High Altitude 3 Jaw Rev. Clutch		1988-93	USA	0B209468 +	
100 High Altitude 3 Jaw Rev. Clutch		1988-93	BEL	9523034	
100 6 Jaw Rev. Clutch		1988-98	USA	0B209468 +	REC52-850048T
100 6 Jaw Rev. Clutch		1988-98	BEL	9523034	REC52-850048T
100 High Altitude 6 Jaw Rev. Clutch		1988-93	USA	0B209468 +	REC52-850048T
100 High Altitude 6 Jaw Rev. Clutch		1988-93	BEL	9523034	REC52-850048T
115 3 Jaw Rev. Clutch		1988-93	USA	0C100000 +	
115 3 Jaw Rev. Clutch		1988-93	BEL	9559771	
115 High Altitude 3 Jaw Rev. Clutch		1989-93	USA	0C100000 +	
115 High Altitude 3 Jaw Rev. Clutch		1989-93	BEL	9559771	
115 6 Jaw Rev. Clutch		1989-93	USA	0C100000 +	REC52-850048T
115 6 Jaw Rev. Clutch		1989-93	BEL	9559771	REC52-850048T
115 High Altitude 6 Jaw Rev. Clutch		1989-93	USA	0C100000 +	REC52-850048T
115 High Altitude 6 Jaw Rev. Clutch		1989-93	BEL	9559771	REC52-850048T
125 3 Jaw Rev. Clutch		1994-98	USA	0D283222 +	
125 3 Jaw Rev. Clutch		1994-98	BEL	9793577	
125 High Altitude 3 Jaw Rev. Clutch		1994-98	USA	0D283222 +	
125 High Altitude 3 Jaw Rev. Clutch		1994-98	BEL	9793577	
125 6 Jaw Rev. Clutch		1994-98	USA	0D283222 +	REC52-850048T
125 6 Jaw Rev. Clutch		1994-98	BEL	9793577	REC52-850048T
125 High Altitude 6 Jaw Rev. Clutch		1994-98	USA	0D283222 +	REC52-850048T
125 High Altitude 6 Jaw Rev. Clutch		1994-98	BEL	9793577	REC52-850048T
V-135 Std. Rotation, 2:1 Ratio, Non-Ratchng		1997-04	USA	0G438000 +	REC52-859340T
V-135 Counter Rotation, Non-Ratchng		1997-04	USA	0G438000 +	REC52-859340T
V-135 DFI Std. Rotation, 2:1, Non-Ratchng		1998-04	USA	0G590000 +	REC52-859340T
V-135 DFI Counter Rotation, Non-Ratchng		1998-04	USA	0G590000 +	REC52-859340T
V-150 (XR4, MAG II) w/ 4-1/4 Dia. Torpedo		1988-91	USA	0C239553-04303045	
V-150 Std. Rotation, 2:1, Non-Ratchng		1996-98	USA	0G438000 +	REC52-859340T
V-150 Counter Rotation, Non-Ratchng		1996-98	USA	0G438000 +	REC52-859340T
V-150 (XR6, MAG III) Std. Rot., 1.87:1, Non-Ratchng		1996-98	USA	0G438000 +	REC52-859340T
V-150 EFI Std. Rot., 1.87:1, Non-Ratchng		1996-98	USA	0G438000 +	REC52-859340T
V-150 EFI Counter Rot., 1.87:1, Non-Ratchng		1996-98	USA	0G438000 +	REC52-859340T
V-150 DFI Std. Rot., 1.87:1, Non-Ratchng		1998	USA	0G590000 +	REC52-859340T
V-150 DFI Counter Rot., 1.87:1, Non-Ratchng		1998	USA	0G590000 +	REC52-859340T
V-175 Counter Rot., 1.87:1, Non-Ratchng		1996-98	USA	0G438000 +	REC52-859340T
V-175 EFI Std. Rot., 1.87:1, Non-Ratchng		1996-98	USA	0G438000 +	REC52-859340T
V-175 Counter Rot., 1.87:1, Non-Ratchng		1996-98	USA	0G438000 +	REC52-859340T
V-200 DFI Std. Rot., 1.75:1, Non-Ratchng		1997	USA	0G438000 +	REC52-859340T
V-200 Std. Rot., 1.87:1, Non-Ratchng		1996-98	USA	0G438000 +	REC52-859340T
V-200 Counter Rot., 1.87:1, Non-Ratchng		1996-98	USA	0G438000 +	REC52-859340T
V-200 EFI Std. Rot., 1.87:1, Non-Ratchng		1996-98	USA	0G438000 +	REC52-859340T
V-200 Counter Rot., 1.87:1, Non-Ratchng		1996-98	USA	0G438000 +	REC52-859340T
V-200 DFI Counter Rot., 1.75:1, Non-Ratchng		1997	USA	0G438000 +	REC52-859340T
200 (3.0L) DFI Std. Rot., 1.75:1 Ratio		1998	USA	0G590000 +	REC52-853594T
200 (3.0L) Std. Rot., 1.75:1 Ratio		1998	USA	0G590000 +	REC52-853594T
225 (3.0L) DFI Std. Rot., 1.75:1 Ratio		1998	USA	0G590000 +	REC52-853594T
225 (3.0 Carb) Sea Pro Std. Rot., 1.62:1		1994-98	USA	- 0G437999	REC52-853594T
225 (3.0 Carb) Sea Pro Std. Rot., 1.75:1		1994-98	USA	- 0G437999	REC52-853594T
V-220 Std. Rot., 1.87:1 Ratio		1987-88	USA	B117316 +	REC52-853594T
V-225 Std. Rot., w/ pre-load pin in drive shaft		1980-81	USA	5628028	REC52-853594T
225 (3.0 Carb) Std. Rot., 1.62:1 Ratio		1994-98	USA	0D280813 +	REC52-853594T
225 (3.0L) EFI Std. Rot., 1.75:1 Ratio		1995-98	USA	0G129222-0G437999	REC52-853594T
225 (3.0L) EFI Std. Rot., 1.75:1 Ratio		1995-98	USA	0G438000 +	REC52-853594T
225 (3.0L) EFI Std. Rot., 1.87:1 Ratio		1995-98	USA	0G438000 +	REC52-853594T
250 (3.0L) EFI Std. Rot., 1.75:1 Ratio		1995-98	USA	0G129222-0G437999	REC52-853594T
250 (3.0L) EFI Std. Rot., 1.75:1 Ratio		1995-98	USA	0G438000 +	REC52-853594T
250 (3.0L) EFI Std. Rot., 1.87:1 Ratio		1995-98	USA	0G438000 +	REC52-853594T
250 / 275 Std. Rotation		1989-94	USA	C101891 +	REC52-853594T

EJE TRANSMISIÓN	DRIVE SHAFT	ASSE TRASMISSIONE	ARBRE DE TRANSMISSION		
REF	OEM			Ø 2	1
REC45-816919	45-816472 V6 (3.0L)	Cola moderna Late gearcase Piede moderna Embase moderne	18 ^{1/4} " 46,35 cm	1 ^{1/8} " 2,85 cm	13





EJE HÉLICE	PROP SHAFT	ASSE ELICA	ARBRE D'HÉLICE			
REF	OEM			Ø 2	1	3
REC44-824110	44-824110 V6 (3.0L)	Modelo moderno Late Gearcase Modello moderno Embase moderne	15 - 1/2" 39,37 cm	1 - 3/16" 3,016 cm	15	REC12-31211Q01
REC44-94148	44-94148 V6	Cola Alpha moderna. NO MONTAR EN EMBARCACIONES DE COMPETICIÓN Late Alpha Gearcase. DON'T USE ON BASS TOURNAMENT BOAT ENGINES Piede Alpha moderno. NON MONTARE SU IMBARCAZIONI DA COMPETIZIONE Embase moderne. NE PAS UTILISER POUR LA COMPETITION	15 - 1/2" 39,37 cm	1 - 3/16" 3,016 cm	15	REC12-31211Q01
	44-93003 L4, L6, V6	Cola 6 en línea antigua Early Inline 6 Gearcase Piede 6 in línea vecchio Embase ancienne 6 en ligne	15 - 1/4" 38,73 cm	1 - 3/16" 3,016 cm	15	REC12-31211Q01
REC44-12238T	44-12238T L4, V6, XR4, XRG (3 cyl)	Modelo moderno Late Gearcase	15 - 1/4" 38,73 cm	1 - 3/16" 3,016 cm	15	REC13191Q01
REC44-850308	44-850308 (3 - 4 cyl)	Modelo moderno Late Gearcase Embase moderne	15 - 1/4" 38,73 cm	1 - 3/16" 3,016 cm	15	REC13191Q01
	44-75365 (2, 3, 4 Cyl)	Cola pequeña Small Gearcase Piede piccola Embase petite	12 - 1/2" 39,37 cm	7/8" 2,22 cm	13	REC73345A1



ACOPLE CAMBIO	SHIFT BUSHING	ACCOPIAMENTO CAMBIO	SUPPORT SELECTEUR
REF	OEM		
REC23-815921A21	23-815921A4 - A10	200 - 250 HP (EFI / DFI / Carb) 3.0L Race Outboard (3.0L EFI)	

ACOPLE GOMA	GROMMET	GOMMINI	BAGUE
REF	OEM		
REC26-38970	26-38970	50 - V-225 HP XR-4 / XR-6 Race Outboard	

PASADOR	CROSS PIN	PIN	PIN		
REF	OEM		4T STROKES	2T STROKES	
REC17-8M0084681	17-30632	40 - 300 HP Raco Outboard	✓	✓	

TORNILLO DRENAJE **DRAIN SCREW**

REF	OEM	STROKES	STROKES
		4T	2T
REC22-67892A05	22-67892A1	6 HP +	✓ ✓





REF	OEM	STROKES	STROKES
		4T	2T
REC90340-08002	22-8M008360 22-8M0083059	JAPAN 8X1.25 metric	REC90430-08020 ✓

VITE DRENAGGIO **VIS DE VIDANGE**

REF	OEM	STROKES	STROKES
		4T	2T
REC10-79953Q04	10-79953A2	8 - 200 HP Race Outboard Sport Jet	✓ ✓



CASQUILLO **COUPLING ASSEMBLY**

REF	OEM	STROKES
REC816597A1	816597A1	200 - 225 HP (DFI / EFI / Carb / Seapro) (3.0L)



GHIERA **ACCOUPLMENT**

RETÉN GOMA **FACE SEAL**

REF	OEM	STROKES	STROKES
		4T	2T
REC26-816575A2	23-29804	65 - V-225 HP XR-4 / XR-6	



REF	OEM	STROKES	STROKES
		4T	2T
REC26-88397	26-88397	2.5L (EFI, OFFSHORE)	✓



PARAOLIO **JOINT**

REF	OEM	STROKES	STROKES
		4T	2T
REC682-44365-00	26-84022M	9.9, 15 HP (682/684)	✓



REF	OEM	STROKES	STROKES
		4T	2T
REC26-8M0142851	26-8M2014338	4 - 400 HP	✓



REF	OEM	STROKES	STROKES
		4T	2T
PAF15-02000006	26-852859	15K (65G/6M7K)	✓



CHAVETA KEY CHIAVETTA CLAVETTE

REF	OEM		4T STROKES	2T STROKES
REC8M0032834	28-56654	140 / 105 / 110 Jet 65 - V-225 HP XR-4 / XR-6 Race Outboard		
REC28-8M0032833	28-43037	30 - 300 HP	✓	✓
REC28-8M0032831	28-8M0032831 28-19699	30 - 60 HP	✓	✓
REC28-8M0032838	28-8M0032838 28-85119	9.9 - 50 HP	✓	✓
REC8M0032837	28-8M0032837 28-56662	30 - 70 HP	✓	
PAF8-04000021	17-9521811	2 - 9.9 HP	✓	✓
REC28-42376A2	28-42376A2	6 - 15 HP	✓	✓
REC28-803749	28-803749	9.9 - 18 HP	✓	✓



MUELLE SPRING MOLLA RESSORT

REF	OEM		4T STROKES	2T STROKES
REC24-30893	24-30893	40 - 350 HP Raco Outboard	✓	✓
REC24-38114	24-38114	8 - 70 HP	✓	✓



SUPLEMENTOS SHIMS SPESSORI CALES

REF	OEM		4T STROKES	2T STROKES
REC15-42637A1	15-42637A1	105 - 140 HP 150 / 175 ProXS 200 - 250 (3.0L EFI / DFI) V-135 - V-200 XR-4 / XR-6		
REC15-47397A1	15-47397A1	105 - 140 Jet 135 - 350 HP V-135 - V-225 XR-4 / XR-6	✓	✓



EJE CAMBIO SHIFT POOL ASSE CAMBIO ARBRE DE CHANGEMENT

REF	OEM	
REC818349T1	818349A1	200 - 250 HP (DFI / EFI / Carb) (3.0L)







TORNILLO SCREW VITE VIS







REF	OEM	
REC10-30720	10-30720	65 - V-225 HP XR-4 / XR-6



REF	OEM	
REC10-96411	10-96411	75 - V-225 HP XR-4 / XR-6 Race Outboard



ARANDELA		WASHER		RONDELLA		RONDELLE	
REF	OEM			REF	OEM		
REC12-77674	12-77674			REC12-86645	12-86645		
				REC19643	19643		
				REC12-191833	12-20260 12-19183		
				REC27-29586	27-29586		
REF	OEM			REF	OEM		new
REC350038	12-92721			REC12-20084	12-20084	MERCURY 39, 60, 110 (-1967) 6 SPLINE	
REF	OEM		new				
PAGB/T96-10	12-16146	4, 5 HP 8, 9.9 HP (2005+)	4T STROKES 2T STROKES ✓				

TUBO DE AGUA		WATER HOSE		TUBO ACQUA		TUYAU D'EAU	
REF	OEM			REF	OEM		
REC23-29804T	23-29804	8 - V-200 HP XR-6	4T STROKES 2T STROKES ✓ ✓	REC43023	43023	25 - 115 HP	✓ ✓
				REC43023-2	43023-2	40 - 115 HP	✓ ✓
REF	OEM		new	REF	OEM		new
REC26-36556	26-36556	3.5 - 40 HP	4T STROKES 2T STROKES ✓	REC26-38452	26-38452	35 - 70 HP	✓
REF	OEM		new	REF	OEM		new
REC22-887987A1	22-887987A1	135 - 400 HP 4 & 6 CYL	4T STROKES 2T STROKES ✓	REC8M0151044	8M0151044 8M0109700 893855 887774	25 - 60 HP	✓
REF	OEM		new				
REC8M0036238	8M0036238	75 - 150 HP	4T STROKES 2T STROKES ✓				

SISTEMA DE PROPULSIÓN PROPULSION SYSTEM

SISTEMA DI PROPULSIONE SYSTEME DE PROPULSION

HÉLICES ALUMINIO E
INOXIDABLE
DE 3 Y 4 PALAS

3 & 4 BLADE
ALUMINIUM & SS
PROPELLERS

ELICHE ALLUMINIO E
INOX DA 3 E 4 PALE

HELICE ALUMINIUM ET
INOX 3 ET 4 PALES

CÓDIGO DE REFERENCIAS

PART NO. CODING SYSTEM

SISTEMA DI CODICE

CODAGE DES REFERENCES

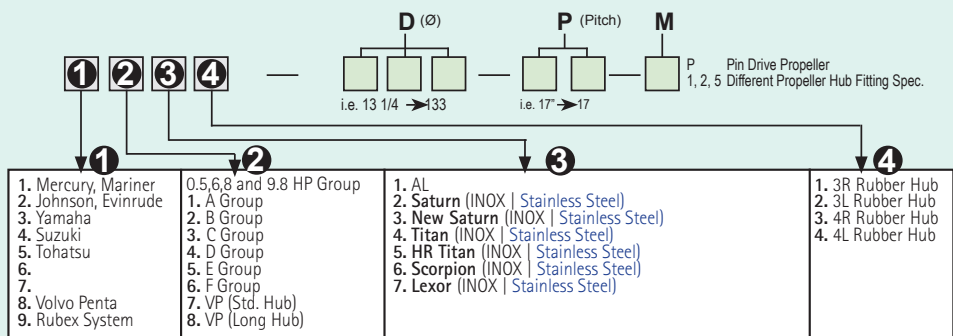

AMITA 3



Hélice de aluminio con núcleo de goma de gran resistencia.

Aluminum propeller with heavy duty rubber hub.

Eliche di alluminio con mozzi in gomma ad alta resistenza.

Hélice en aluminium avec moyeu en caoutchouc



AMITA 4



Hélices de aluminio con núcleo de goma de gran resistencia. Van muy suaves a poca velocidad y hace el barco muy manejable con la mar picada.

Aluminum propeller with heavy duty rubber hub. Smoother low speed makes the offshore boating activity much easier.

Eliche di alluminio con mozzo in gomma ad alta resistenza. Molto morbido a bassa velocità e rende la barca molto maneggevole con mare cattivo.

Hélice en aluminium avec moyeu en caoutchouc. Permet d'aller doucement à basse vitesse et rende le bateau très maniable lorsque la mer est agitée



TITAN



Hélices de acero inox. Diseño de pala grande para un área más grande. Gran capacidad de transporte de carga. Excelente economía de combustible.

Stainless steel propeller. High camber blade and large blade area design. Great load carrying capability. Excellent fuel economy.

Eliche in acciaio inossidabile. Ampia capacità di carico. Eccellente riduzione consumo del carburante.

Hélice en acier inoxydable. Lame à carrossage élevé et conception à grande surface de lame. Grande capacité de charge. Excellente économie de carburant.



NEW SATURN



Hélices de acero inoxidable. Ofrece buena aceleración y rendimiento. Tamaño más pequeño que ofrece un diámetro extragrande.

Stainless steel propeller. Offers good acceleration & all-round performance. Smaller pitch sizes offered in extra large diameter with increased blade area.

Eliche di acciaio inox. Buona accelerazione. Piccole dimensioni che offre un più grande diametro.

Hélice inox, offrant de bonnes accélérations et performances. Taille de pas réduite pour les modèles de grands diamètres avec une surface de pale plus importante.

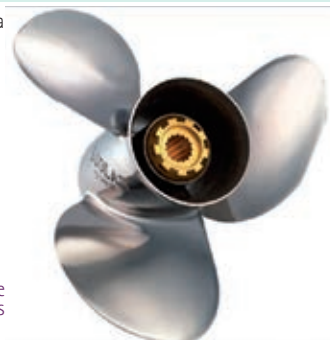

HR TITAN 3 PROP



Hélice de acero inoxidable. Alto rendimiento para cascos de alta velocidad. La inclinación de la hoja proporciona un excelente elevación de proa y aceleración. El diseño de copa grande aumenta la mordida y reduce el deslizamiento.

Stainless steel propeller. Performance prop for high speed planning hulls. High rake blade design provides excellent bow lift and acceleration. Heavy cup design increases bite and reduces slip.

Eliche in acciaio inox. Alte prestazioni per scafi ad alta velocità. Il passo della pala fornisce un'eccellente spinta e accelerazione. Il disegno aumenta le prestazioni.

Hélice en acier inoxydable. Hélice de performance pour les coques à grande vitesse. La conception des pales très arrondies avec une plus grande surface offre une excellente portance et des accélérations élevées en réduisant la consommation.



**GUÍA DE HÉLICES
CON NÚCLEO INTEGRADO**

**PROPELLERS APPLICATION
WITH RUBBER HUB**

**GUIDA ELICHE
CON MOZZO**

**GUIDE DES HELICES
ET MOYEUX**

	R.O. OEM						AL	INOX STAINLESS STEEL				
		AMITA 3	AMITA 4	NEW SATURN	TITAN	HR TITAN 3						
2.5, 3.5 HP	48-815083	3	7 ^{1/4"}	6	R	PLAST.	SOL0001-073-06P					
4, 4.5, 5, 6 HP		12	3	7.8	8	R	7					
							8	AL	SOL5011-078-08			
							9		SOL5011-078-09			
8, 9.9HP (2005+) 4 T/STROKES	48-895180A10 48-895182A10	12	3	8.5	8	R	7					
							8	2 ^{1/2"}	AL	SOL5011-085-08		
							9		SOL5011-085-09			
9.9HP (2005+) 15, 20 HP (2007+) 4 T/STROKES		14	3	9 ^{1/4"}	9	R	7					
							8		SOL5111-093-07			
							9	2 ^{1/2"}	AL	SOL5111-093-08		
							10		SOL5111-093-09			
4 T / Strokes 8, 9.9 HP (2002-04)	48-828152A12 48-828154A12						11					
							7		SOL1111-093-07			
							8		SOL1111-093-08			
2 T / Strokes 6, 8, 9.9 HP (1986+) 10 HP (1995-01) 15 HP (1989-06)	48-828156A12 48-828158A12	8	3	9 ^{1/4"}	9	R	2 ^{1/2"}	BlackMax	SOL1111-093-09			
							10		SOL1111-093-10			
							11		SOL1111-093-11			
4 T / Strokes 9.9, 15 HP BigFoot (1999-05)	48-19636A10 48-19638A40	10	3	10 ^{3/8"}	12	R	9 ^{1/2"}		SOL1211-110-09			
							11		SOL1211-105-11			
2 T / Strokes 18 HP (1980-85) 20, 25 HP (1980-05)	48-19639A40 48-19640A40 48-19642A40	10	3	10 ^{3/8"}	12	R	3"	BlackMax	SOL1211-103-12			
							13		SOL1211-101-13			
							14		SOL1211-100-14			
4 T / Strokes 25 HP (1999-05) 30 HP (1994-05, 2010+) 40, 50, 60 HP	48-87818A11 48-85632A40 48-816702A40 48-816704A40	13	3	12 ^{1/4"}	12	R	9		SOL1311-121-09	SOL1313-118-09		
							11		SOL1311-116-11	SOL1313-111-11		
							13	3 ^{1/4"}	BlackMax	SOL1311-114-12	SOL1313-108-12	
							13		SOL1311-111-13	SOL1313-105-13		
2 T / Strokes 30 - 70 HP (1994-05)	48-816706A40 48-73140A40			10 ^{3/8"}	14		14		SOL1311-111-14	SOL1313-105-14		
							15		SOL1311-110-15			
4 T / Strokes 25 HP (2006+) 30 HP (2006+) not Bigfoot		10	3	9.9	11	R	9		SOL5211-099-09			
							10		SOL5211-099-10			
							11	3"	SOL5211-099-11			
							12		SOL5211-099-12			
Base Tohatsu							13		SOL5211-099-13			
							9 ^{7/8"}	9		SOL3211-099-09		
							9 ^{7/8"}	10		SOL3211-099-10		
							9 ^{7/8"}	11		SOL3211-099-11		
							9 ^{7/8"}	12		SOL3211-099-12		
							9 ^{7/8"}	13	R	SOL3211-099-13		
							10 ^{3/4"}	10		SOL3231-108-10		
10 ^{1/2"}	11		SOL3231-105-11									
10 ^{1/4"}	12		SOL3231-103-12									
10 ^{1/8"}	13		SOL3231-101-13									

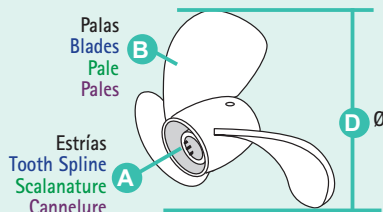

- P** Paso
Pitch
Passo
Pas
- R** Rotación L (izquierda) R (derecha)
Rotation L (left) R (Right)
Rotazione L (SX) R (DX)
Rotation L (gauche) R (droit)

	R.O. OEM	A B D P R					AL		INOX STAINLESS STEEL			
		AMITA 3		AMITA 4		NEW SATURN	TITAN	HR TITAN 3				
4 T / Strokes 40, 50, 60 HP (1995+) 75, 90, 115 HP	48-77338A45	14	11			BlackMax	SOL1411-140-11	SOL1413-133-13	SOL1431-140-11			
	48-77340A45	14	13			BlackMax	SOL1411-138-13	SOL1413-130-15	SOL1431-138-13			
	48-77341A45	13 ^{1/2"}	14			BlackMax	SOL1411-135-14					
	48-77342A45	13 ^{3/4"}	15			BlackMax	SOL1411-135-15	SOL1413-128-17	SOL1431-135-15			
	48-77344A45	13 ^{1/4"}	17			BlackMax	SOL1411-133-17	SOL1413-125-19	SOL1431-133-17			
	48-77346A45	13	19			BlackMax	SOL1411-130-19	SOL1413-125-21	SOL1431-130-19			
	48-77348A45	12 ^{3/4"}	21			BlackMax	SOL1411-130-21		SOL1431-130-21			
	2 T / Strokes 40, 50, 60 HP 65, 75, 90 HP 80, 85, 100, 115, 125, 140 HP	48-17310A46	15	3		R 4 1/4"	Vengeance					
	48-17312A46	14	10			Vengeance			SOL1431-140-11			
	48-17314A46	14	12			Vengeance			SOL1431-138-13			
48-16986A46	13 ^{3/8"}	14			Vengeance			SOL1431-135-15				
48-16988A46	13	18			Vengeance			SOL1431-133-17				
48-16990A46	13 ^{1/4"}	20			Laser II			SOL1431-130-19				
48-16992A46	13 ^{1/2"}	22			Laser II			SOL1431-130-21				
135-150-175HP	48-78116A45	15	15	R		BlackMax	SOL1511-150-15	SOL1513-148-15				
		15	15	L			SOL1512-150-15					
	48-832828A45	14.8	17	R		BlackMax	SOL1511-148-17	SOL1513-145-17				
		14.8	17	L			SOL1512-148-17					
	48-832830A45	15	3	14.5	19	R	4 3/4"	BlackMax	SOL1511-145-19	SOL1513-143-19		
		14.5	19	L				SOL1512-145-19				
	48-832832A45	14.3	21	R		BlackMax	SOL1511-143-21	SOL1513-140-21				
		14.3	21	L				SOL1512-143-21				
	48-832834A45	14.3	23	R		BlackMax	SOL1511-142-23					
		14.3	23	L				SOL1512-142-23				
200, 220, 225, 250, 275, 300 HP 3.4L	48-834850A45	4	15	16	R	Alpha 4		SOL1513-145-17				
	48-834852A45	4	14 ^{1/2"}	18	R	Alpha 4		SOL1513-143-19				
	48-834854A45	4	14	20	R	Alpha 4		SOL1513-140-21				
	48-834855A45	4	14	20	L	Alpha 4						
	90, 100, 115 HP Command Thrust	48-19838A46	3	15 ^{3/4"}	15	R	Mirage Plus	SOL1511-158-15				
	48-19841A46	3	15 ^{3/4"}	15	L	Mirage Plus	SOL1512-158-15					
	48-18278A46	3	15 ^{1/2"}	17	R	Mirage Plus	SOL1511-155-17				SOL1571-155-17	
	48-90159A46	15	3	15 ^{1/2"}	17	L	4 3/4"	Mirage Plus	SOL1512-155-17			SOL1572-155-17
	48-13700A46	3	15 ^{1/4"}	19	R	Mirage Plus	SOL1511-153-19				SOL1571-153-19	
	48-13701A46	3	15 ^{1/4"}	19	L	Mirage Plus	SOL1512-153-19			SOL1542-150-19	SOL1572-153-19	
48-13702A46	3	15	21	R	Mirage Plus	SOL1511-153-21				SOL1571-150-21		
48-13703A46	3	15	21	L	Mirage Plus	SOL1512-153-21				SOL1572-150-21		
48-13704A46	3	14 ^{3/4"}	23	R	Mirage Plus					SOL1571-148-23		
48-13705A46	3	14 ^{3/4"}	23	L	Mirage Plus					SOL1572-148-23		
		3	14 ^{1/2"}	25	R						SOL1571-145-25	

NÚCLEO INTERCAMBIABLE INTERCHANGEABLE HUB MOZZO INTERCAMBIABILE MOYEU INTERCHANGEABLE

	2T STROKES	4T STROKES	A	REF	
25 HP BigFoot (1999-05) 30HP BigFoot (2010+) 30HP (1994-05) 30HP Sea Pro/Marathon (1994+) 35HP (1994-89) 402 Et 500 (1974-84) 40-50HP No/Not/No Bigfoot (1977+) 45HP (1986-89) 48HP Mariner 55HP Sea Pro/Marathon (1995+) 60HP Mariner (1976) 60HP No/Not/Non Bigfoot, Sea Pro/Marathon (1978+) 65HP (1972-76) 70HP (1983+) 80HP Mariner (1977)					
40-60 HP Bigfoot, 40-140 HP (No/Not/Non 135HP) V4 Gearcase (1978+)	✓	✓	13	3 ^{1/4"}	SOLRBX-114 C
90HP, 115HP (Command Thrust) (2014+) 135HP (1987+), 150-300 HP (1978+)			15	4 ^{1/4"}	SOLRBX-102 D
-400HP Mercury Alpha One, Bravo One			15		SOLRBX-102 E
225 EFI (YAMAHA)	✓		15	4 ^{3/4"}	SOLRBX-124 E



HÉLICES PARA NÚCLEO INTERCAMBIABLE

PROPELLERS FOR INTERCHANGEABLE HUB

ELICHE PER MOZZO INTERCAMBIABILE

HELICES AVEC MOYEU INTERCHANGEABLE

	B	D	P	R	AL
C 30-75 HP	3	12.1	9	R	SOL9311-121-09
		12	10	R	SOL9311-120-10
		11-6	11	R	SOL9311-116-11
		11.4	12	R	SOL9311-114-12
		11.1	13	R	SOL9311-111-13
		11.1	14	R	SOL9311-111-14
		11	15	R	SOL9311-110-15
D 40-140 HP	3	14	9	R	SOL9411-140-09
		14	11	R	SOL9411-140-11
		13.75	13	R	SOL9411-138-13
		13.50	15	R	SOL9411-135-15
		13.25	17	R	SOL9411-133-17
		13.2	19	R	SOL9411-132-19
		13.2	21	R	SOL9411-132-21
E 135-350 HP	3	15.5	11	R	SOL9511-155-11
		15.3	13	R	SOL9511-153-13
		16	13	R	SOL9511-160-13
		15	15	R	SOL9511-150-15
		15	15	L	SOL9511-150-15
		14.8	17	R	SOL9511-148-17
		14.8	17	L	SOL9511-148-17
		14.5	19	R	SOL9511-145-19
		14.5	19	L	SOL9511-145-19
		14.3	21	R	SOL9511-143-21
		14.3	21	L	SOL9511-143-21

	B	D	P	R	INOX STAINLESS STEEL		
C 30-75 HP	3	11 ^{5/8}	11	R	SOL9331-116-11		
		11 ^{3/8}	12	R	SOL9331-114-12		
		11 ^{1/8}	13	R	SOL9331-111-13		
		11 ^{1/8}	14	R	SOL9331-111-14		
		11	15	R	SOL9331-110-15		
		D 40-140 HP	3	13 ^{3/4}	13	R	SOL9431-138-13
				13 ^{3/4}	13	L	SOL9432-138-13
13 ^{1/2}	15			R	SOL9431-135-15		
13 ^{1/2}	15			L	SOL9432-135-15		
13 ^{1/4}	17			R	SOL9431-133-17		
13 ^{1/4}	17			L	SOL9432-133-17		
13	19			R	SOL9431-130-19		
13	19			L	SOL9432-130-19		
13	21			R	SOL9431-130-21		
E 90-140 HP	3			14 ^{1/2}	15	R	SOL9531-145-15
		14 ^{1/2}	15	L	SOL9532-145-15		
		14 ^{1/4}	17	R	SOL9531-143-17		
		14 ^{1/4}	17	L	SOL9532-143-17		
		14	19	R	SOL9531-140-19		
		14	19	L	SOL9532-140-19		
		14	21	R	SOL9531-140-21		
		14	21	L	SOL9532-140-21		
		14	23	R	SOL9531-140-23		
		14	23	L	SOL9532-140-23		
		E 135-350 HP	3	15 ^{3/4}	15	R	SOL9571-158-15
15 ^{3/4}	15			L	SOL9572-158-15		
15 ^{1/2}	17			R	SOL9571-155-17		
15 ^{1/2}	17			L	SOL9572-155-17		
15 ^{1/4}	19			R	SOL9571-153-19		
15 ^{1/4}	19			L	SOL9572-153-19		
15	21			R	SOL9571-150-21		
15	21			L	SOL9572-150-21		
14 ^{3/4}	23			R	SOL9571-148-23		
14 ^{3/4}	23			L	SOL9572-148-23		
14 ^{1/2}	25			R	SOL9571-145-25		
14 ^{1/2}	25	L	SOL9572-145-25				

RUBEX



Núcleo intercambiable (no incluido).
Interchangeable hub (not included).
Mozzo intercambiable (non incluso).
Moyaux interchangeable (non inclus)

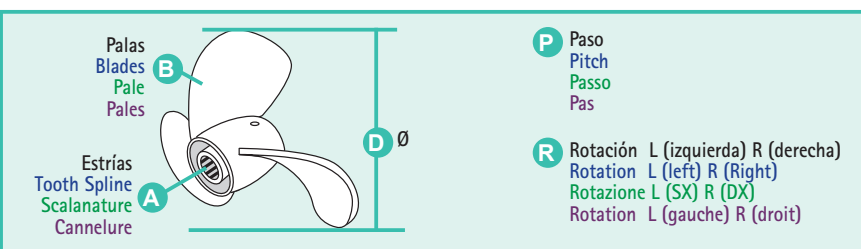

MERCURY

RECAMBIOS MARINOS

PIEZAS HÉLICE

PROP PARTS

PARTI ELICA

PARTS D'HÉLICE

TUERCA HÉLICE

PROP NUT

DADO ÉLICHE

ÉCROU D'HÉLICE

REF	OEM	
REC90301-ZW1-003	11-52707	V4 - V6
REC11-52707Q1		



REF	OEM	
REC11-69578Q1	11-69578	40-70 HP



REF	OEM
PAF15-06000016	11-16147



REF	OEM
REC11-4011912	11-4011912



REF	OEM	
REC11-161471	11-161471	8-30 HP



ARANDELA

WASHER

RONDELLA

RONDELLE

REF	OEM	
PAGB/T96-10	12-161402	8-30 HP



TOPE HÉLICE

THRUST HUB

RONDELLA

ENTRETOISE

REF	OEM		4T STROKES	2T STROKES
REC13191Q01	13191A1 75282A1	V4	✓	
		75-125 RUBBER HUB		✓
		40-60HP BIGFOOT		





REF	OEM	
REC73345A1	73345A1	40-60 HP STD



COBRE | BRASS | RAME | LAITON

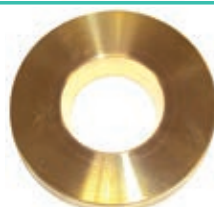





REF	OEM
REC12-31211Q01	12-825467 13171



TOPE HÉLICE		THRUST WASHER		FERMO PER ELICA		RONDELLE D'HÉLICE	
INOX SS							
REF	OEM		4T STROKES	2T STROKES	REF	OEM	
REC12-835467Q01	13171 835467Q01		75-125 HP FORCE 75 HP (1999)	✓	REC858498	858498	MERCURY 20-25 HP
			90-115 HP (1995+)				3 BLADES SS CLEAVER & CHOPPER II
			40-60HP BIGFOOT	✓			
							new
							
							new
REF	OEM		8-9.9 HP (2005+)		REF	OEM	
PAF8-04000019	8M0131240		STD PROP				

PASADOR		PIN		SPINOTTO		GOUPILLE FENDUE	
REF	OEM						
PAGB/T91-2.5X20	18-8150261	new					

ESPACIADOR		SPACER		DISTANZIALE		ENTRETOISE	
REF	OEM						
REC23-420911	23-420911	MARINER 9.9-15 HP	8	new			

CIERRE HÉLICE		TAB WASHER		CHIUSURA ELICA		RONDELLE VREIN	
REF	OEM		4T STROKES	2T STROKES	REF	OEM	
REC90508-ZW1-003	14-31210 14-816629Q		75-300 HP V4-V6 40-60 HP BIGFOOT	✓	REC13-423511	13-42351-1	135-275 HP V6
							
							
							
							
REF	OEM		18-70 HP NO BIGFOOT				
REC14-76281Q	14-76281						

TOPE CIERRE HÉLICE TAB WASHER RECEIVER RONDELLA CHIUSURA ENTRETOISE

REF	OEM	4T STROKES	2T STROKES	DIENTES JAW DENTI DENTS
REC12-31211Q03	12-31211A2	135-275 HP	V6	15



KIT CIERRE HÉLICE PROP NUT KITS KIT CHIUSURA ELICA KIT ECROU D'HELICE

REF	OEM	6-15 HP
REC21285		

REF	OEM	6-15 HP
REC22215		

REF	OEM	6-15 HP FORCE 9.9-15 HP (1998+) 9.9 HP (1994-04) 15 HP (1994-06)
REC13914Q02	11-13914A2	

REF	OEM	18-25 HP
REC21307		

REF	OEM	V4 - V6
REC11-52707Q1	11-52707Q1 11-52707A1	

REF	OEM	30 - 70 HP
REC11-31990Q02	11-31990A2	

GUÍA DE RECAMBIOS DE HÉLICE PROPELLER SPARE PARTS GUIDA RICAMBIO ELICHE GUIDE DES PIECES POUR HELICE

	1	2	3	4	5
8 / 9.8HP FS (2005 +)	PAF8-04000019		PAGB/T96-10	PAF15-06000016	PAGB/T91-2.5X20
18 To 25 HP (1980 +)	REC858498			REC11-4011912	
30 To 60 HP			REC14-76281Q	REC11-69578Q1	
70 HP + (Non Flo-Torq II)	REC12-835467Q01	REC12-31211Q03	REC90508-ZW1-003	REC11-52707Q1	
For Aft-Installed Rubber Hub Prop.					
70 - 140 HP (Inline 6 cyl. 1977+)		REC13191Q01	REC90508-ZW1-003	REC11-52707Q1	
60Hp BigFoot					
75 - 125 HP (1987+)					

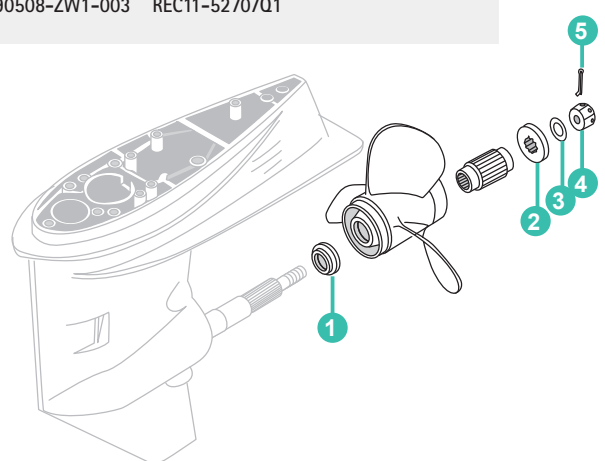

REF --> RO / OEM

REF	R.O. / OEM	
A		
ARC5362	50-834749	127
ARC5362	50-859171T	127
ARC5362	50-898265001	127
B		
BRA125-3/8X1/2	22-8M0086290	76
C		
CEF500301		172
CEF500302		171
CEF500309		171
CEF500310		171
CEF500311G		171
CEF500312		171
CEF500313G		171
CEF500314		171
CEF500315		172
CEF500316		171
CEF500318		172
CEF500320		171
CEF500321		171
CEF500322		171
CEF500325		171
CEF500326		171
CEF500344		172
CEF500377		172
CEFAJ6C		123
CHAL77JC4		122
CHAL78C		124
CHAL82C		124
CHAL82YC		122
CHAL87YCC		122
CHAL90C		122-124
CHAPROSU		125
CHAQL6VC		123-124
CHAQL78C		123-124
CHAQL78YC		122-123-124-125
CHARA8HC		69-121-122-123-124
CHARJ8C		122-123
CHARL82C		122-123
CHARL82YC		122-124
CHARL86C		122-124
CM09411	9411	197
CM15026A	11761001	233
CM17264	17264T2	197
CM31640	31640Q4	305-327-337
CM31640A	31640Q4	305-327-337
CM34127	34127T2	197
CM34127A	34127T2	197
CM34762	34762A1	197
CM34762A	34762A1	197
CM3H6-60218-000	875208	289
CM3V1-60217-0	853762T01	291-297
CM41106-ZW9-000A	8M0137344	197
CM42121	42121A2	293
CM42121A2	42121A2	197-293
CM43396	43396	198
CM43396A	43396	198
CM47820	47820	197
CM61A-45371-00A	888712	311
CM664-45371-01	82795M	325
CM67F-11325-00	804079	233
CM67F-11325-00	894079002	198
CM689-11325-00A	11761001	233
CM6E0-45251-11	97-18852M	321
CM6G1-45251-02		198
CM6G8-11325-00	825435	205
CM6L5-45251-02	810945M	315-319
CM76214	76214	197
CM76214	76214Q5	307
CM762145	76214Q5	337
CM762145A	76214	197
CM762145A	76214Q5	307-337
CM818298	818298A1	198
CM818298A	818298A1	198
CM820503	8205031	198
CM822157T2	822157T2	197-301
CM822777	822777Q1	197
CM8239121	8239121	198
CM825271	8252711	198
CM825271A	8252711	198
CM826134	826134	197
CM826134	826134Q	305-307-335-337
CM826134A	826134	197
CM826134A	826134Q	305-307-335-337
CM826887M	826887M	198
CM880653	880653	197
CM880653A	880653	197
CM89026	89026	197
CM892227	893404	198
CM892227A	893404	198
CM89949	89949A1	198
CM89949A	89949A1	198
CM942860	94286T1	197
CM984325	98432Q6	197

REF	R.O. / OEM	
CM984325A	98432Q6	197
CM984325A	98432T6	295
CMPCNCF16A	809664A 1	198
CMVERADO4KITA	97-8M0107550	198
CMVERADO4KITM	97-8M0107550	198
CMVERADO6KITA	8M0126670	198
CMVERADO6KITM	8M0126670	198
G		
GS11158	87-88107A5	131
GS11290		150
GS11291		150
GS11292		150
GS11294		150
GS30435		77
GS31001		77
GS31002		77
GS31022		73
GS31023		73
GS31025		73
GS31026	22-142131	73
GS31027	22-13563T-3	73
GS31028	22-13563T-3	73
GS31064		73
GS31065		76
GS31066	22-89771Q2	76
GS31067	22-34982	76
GS31068		73
GS31069		73
GS31078	22831T03	73
GS31079	30185T3	73
GS31080	30185T3	73
GS31081		73
GS31082	22-13563T-7	73
GS31090		71
GS31095	8M0054313	71
GS31096		71
GS31097		71
GS31099		71
GS31155		76
GS31156		76
GS31157		76
GS31166		76
GS31183		71
GS31187		71
GS35031		72
GS35032		72
L		
LENS3213		75
LENS3227		75-76
M		
MP39760	802136A1	131
MP41070	87-17009A2	131
MP41070	87-17009A5	131
N		
NGKB7HS	33-82371M	251
NGKB7HS-10	33-82370M	247
NGKB7HS-10		124
NGKB8HS-10		124
NGKB9HS-10		122
NGKBP6HS		122
NGKBP7HS-10		122
NGKBP8HN-10		122-123-124
NGKBP8HS-10		123-124
NGKBP8HS-15		122-124
NGKBP8HS-10		122-124
NGKBP7HS		122
NGKBP7HS-10		122-124
NGKBPZ8HN-10		122-124
NGKBR5HS		122-124
NGKBR6HS		122-124
NGKBR6HS-10	33-11458M	245
NGKBR6S		122-123
NGKBR7HS		122-123-124-243
NGKBR7HS-10	33-41263M	245
NGKBR8HIX		123-124-125
NGKBR8HS		123-124-125
NGKBU8H		123-124-125
NGKBUZ8H		123
NGKBUZHW		122-123-124-125
NGKBUZHW-2		122-123-124
NGKBZ7HS-10		123
NGKCPR6EA-9		124
NGKCR6HS		121-122-124-205
NGKDCPR6E	803507	203-213
NGKDCPR6E	33-803507	204-207
NGKDCPR6E		68-69-121-124
NGKDCPR6EIX		121-124
NGKDPR6EA-9		68-121-123-124
NGKDPR7EA-9	33-827858	211-215
NGKILFR6G-E	889680001	229
NGKILFR6G-E	889246Q39	231
NGKILFR6G-E		69-70-122
NGKIZFR5G		70

REF	R.O. / OEM	
NGKIZFR5J		70
NGKLF4E	898829001	69-122-123-226
NGKLF5A-11	859495	122-124-225-233
NGKLF6A-11		122-124
NGKLF7C-9		70-122
NGKZFR5F	33-8M0057936	69-122-227
P		
PAF15-00000014	27-8354272	209-236-237
PAF15-02000006	26-852859	345
PAF15-04000002	825953	233
PAF15-04000002	19-825953	81
PAF15-04000002	22-479452	215
PAF15-04000002		81
PAF15-04000003	27-11754M	251
PAF15-04000003	27-8886586	81
PAF15-04000003	81990M	225-233
PAF15-04000003		68-69-81-215
PAF15-04000005	22-83326M	205-209-247
PAF15-05000011		209-215
PAF15-05000012		209
PAF15-05000013		209
PAF15-05000014		209
PAF15-05170300W	89-825096T	133
PAF15-05170300W	89-825096T01	133
PAF15-06000009	17-80252M	322
PAF15-06000010-1	81626M	323
PAF15-06000010-2	18955M	323
PAF15-06000010-5	18958M	323
PAF15-06000010-7	18960M	323
PAF15-06000016	16147	291
PAF15-06000016	859933	323
PAF15-06000016	11-16147	352
PAF15-06000016		354
PAF15-06070002	84064M	323
PAF15-06080006-1	15-19148005	323
PAF15-06080006-3	15-80259M	323
PAF15-06080006-5	15-80260M	323
PAF15-07000000	802733A98	211
PAF15-07000001	17-825689	209-211
PAF15-07000001	17-825689	205
PAF15-07000007	25-853525	278
PAF15-07000013		209
PAF15-07000017	27-835383001	278
PAF15-07000024	85691	211
PAF15-07000028	10-855677	211
PAF15-07000030	88348935	219-223
PAF15-07000030	892454035	229
PAF15-07000031	825212	215
PAF15-07000031	825212001	219
PAF15-07000031	855676003	209
PAF15-07000031	8M0117413	223
PAF15-07000100	27-850836	211-234-237
PAF15-07000600	855685T	116
PAF15-07010000	8M0055024	209
PAF15-07010003	822625	209-215-219-223
PAF15-07010004	479452	219-223
PAF15-07010006	88305914	205
PAF15-07010006	22-822644	209
PAF15-07010007		209
PAF15-07010008	855678	209
PAF15-07010008	8M0099896	200
PAF15-07010008	97-855678	200
PAF15-07010008		68
PAF15-07010009	25-825040	215
PAF15-07010009	27-825040	209
PAF15-07010009		68
PAF15-07010011	855776	209-245
PAF15-07010012	855779	209-215
PAF15-07010014	26-850850	209
PAF15-07010018	27-834952	169
PAF15-07010018	27-834952002	209
PAF15-07010019	834953T02	209
PAF15-07010021	857080	165
PAF15-07010021	8250311	165-209-215
PAF15-07010021	8M0008243	165-219-223
PAF15-07010021		223
PAF15-07010022	824853	219-223
PAF15-07010022	27-824853	166-209-215
PAF15-07010022		68-69-164-165
PAF15-07010023	35-822626Q03	209
PAF15-07010024	31-834960	209
PAF15-07010026		209
PAF15-07010027	855690	225
PAF15-07010027	25-855690	211
PAF15-07010100	7-803538	111-113
PAF15-07010200	834974	209
PAF15-07020001	700-834963	209-242
PAF15-07020005	53-16057	207-242
PAF15-07020005	53-82343M	209
PAF15-07020005	53-82345M	242
PAF15-07020006	41-825713	209-242
PAF15-07020100	600-834961A1	209-242
PAF15-07030000	400-834957	209-242
PAF15-07030003	43-834955	211

REF	R.O. / OEM		REF	R.O. / OEM		REF	R.O. / OEM	
PAF15-07030004	12-850843	211	PAF25-05020003	893949	223	PAF40-05040002	893563	221
PAF15-07030005	1-855679	211	PAF25-05020003	26-825027	217	PAF40-05040003	893561	221
PAF15-07030006	26-855680	209-241	PAF25-05020003		239-241	PAF40-05040004	854713	221
PAF15-07030007	26-855681	209-241	PAF25-05021000		217-242	PAF40-05040100E1	893504T	219
PAF15-07040000	900-835430A1	211	PAF25-05020101	702-833098A1	217	PAF40-05040200	834781T1	221
PAF15-07040001	850838	211	PAF25-05020105	893863	221-223	PAF40-05040400	857078T1	223
PAF15-07040002	850839	211	PAF25-05020105	41-825016	217	PAF40-05040400	857087T1	221-241
PAF15-07040004	855959	211	PAF25-05020105	41-893863	242	PAF40-05040407		241
PAF15-07040005	24-850840	211	PAF25-05020106	893529	221-223	PAF40-05050000	881862T07	84
PAF15-07040006	822650	217	PAF25-05020106	40-825017	217	PAF40-05050000	881862T1	84
PAF15-07040006	893553	221	PAF25-05020106	40-893529	242	PAF40-05050000	892874T	84
PAF15-07040007	893554	221	PAF25-05020200	650-825018A1	217	PAF40-05050000	899106T	84
PAF15-07040007	28-822651	211-217	PAF25-05020200	856065T1	221	PAF40-05050000	8M0118176	84
PAF15-07040008	26-825455	211	PAF25-05020200	893530T01	223	PAF40-05050000	8M0141844	84
PAF15-07040009	880135	211	PAF25-05020200		242	PAF40-05070000	893693A04	219
PAF15-07040011	880134	211	PAF25-05020203-1	893630001	221	PAF40-05070002	825054	219
PAF15-07040012	825451	211	PAF25-05020203-1	23-825021	217	PAF40-05070003	855236	219
PAF15-07040013	24-825453	211	PAF25-05020203-2	893630	221	PAF40-05091400E1	821509T01	133
PAF15-07040014	24-825452	211	PAF25-05020203-2	23-8250212	217	PAF40-05100000E1	892267T02	96
PAF15-07040015	850842	211	PAF25-05020204	825019	221	PAF40-05100000E1	892267T03	96-108
PAF15-07040016	27-853523	211-241	PAF25-05020204	10-825010	217	PAF40-05100001E1	892267527	108
PAF15-07040017	12-82710M	211	PAF25-05020301	701-8318751	217	PAF40-05100002E1	892267528	108
PAF15-07040018	43-834973	211	PAF25-05020310	652-831876A1	217	PAF40-05100100E1	89226757	108
PAF15-07040020	834956	211	PAF25-05040000	27-830270	215-234	PAF40-05100100E1	892267537	108
PAF15-07040301	825451	211	PAF25-05040000	8M0049885	234-237	PAF40-05100200E1	883220	108
PAF15-07040303	825046	221	PAF25-05050001	822649	217	PAF40-05100301E1	892267A52	108
PAF15-07040303	10-825046	211-217	PAF25-05050001	832990T3	221	PAF40-05100500E1	892267A51	108
PAF15-07040303	10-825046001	207	PAF25-05050002	832990	217	PAF40-05100501E1	892267521	108
PAF15-07040304	826150	221	PAF25-05050002	832991T3	221	PAF40-05100502E1	892267534	87-108
PAF15-07040304	11-826150	211-217	PAF25-05050003	12-825044	217-221	PAF40-05100503E1	892267523	108
PAF15-07040304	11-826150001	207	PAF25-05050005	893552	221	PAF40-05100504E1	892267510	108
PAF15-07040500	834967A1	211-241	PAF25-05050005	24-823678	217	PAF40-05100701E1	892267A54	108
PAF15-07050001	834954	211	PAF25-05050006	10-827607	215	PAF40-05100703E1	892267506	108
PAF15-07050002	850837	211-239	PAF25-05050007	893586	219	PAF40-05100704E1	892267530	87-108
PAF15-07050003	25-8527681	211	PAF25-05050007	27-827610	215	PAF40-05100800E1	892267A55	108
PAF15-07050004	825490	211-215	PAF25-05050008	830274	217	PAF40-07010000E1		75
		205-219-	PAF25-05050009	825050	217	PAF6-03000001	46-16156	179-289
PAF15-07050004	859578A1	223-225-	PAF25-05050009	893560	221	PAF6-03000002	16157	289
		226-229-	PAF25-05050011	893562	221	PAF6-03000003	27-16158	68-289
		231-233	PAF25-05050011	24-825052	217	PAF60-05000003	8M0011870	223
PAF15-07050006	822650	211	PAF25-05050012	24-825052	217	PAF60-05000004	857078	223
PAF15-07060001	853811008	138	PAF25-05050013	25-826153	217	PAF60-05000004	27-857078	170
PAF15-07080000	35-826964T	78	PAF25-05050014	25-826154	217	PAF60-05000005	8M0118194	223
PAF15-07080000	35-879884T	78	PAF25-05050015	25-826152	217	PAF60-05020200	893565	223
PAF15-07080000		69	PAF25-05050016	878183	223	PAF8-00000002	803775006	160
PAF15-07140000	835389A2	84	PAF25-05050016	893581	221	PAF8-00000003	88552635	229
PAF15-07140000	835389T02	84	PAF25-05050016	17-825956	217	PAF8-00000003	10-89514001	207
PAF15-07140000	835389T1	84	PAF25-05050017	833104	217	PAF8-00000004	27-835427003	207-236-
PAF15-09000000		71	PAF25-05050018	4002320	221			237
PAF15-10030001		211	PAF25-05050018	12-4002319	217	PAF8-00000100	895167001	160
PAF166-010003	26-822647	217	PAF25-05050019	10-82641030	217	PAF8-00000200	803512001	207
PAF2.6-03000013	17-82356M	315	PAF25-05050021	893549	219	PAF8-005030010	850842001	207
PAF2.6-03000017	12-80404M	315	PAF25-05050021	26-825048	217	PAF8-02000006L	803755005	291
PAF20-05000400	339-879147T71	117	PAF25-05050100	830271T2	215	PAF8-02000006S	803755004	291
PAF25-00000006	804072	225	PAF25-05050200	2419-82500935	217	PAF8-02000007	804899002	291-297
PAF25-00000006	892086120	226-229	PAF25-05050300		217-221	PAF8-02000100	853771004	160
PAF25-00000013	8252312	236	PAF25-05050301	825045A2	217-221	PAF8-04000002-1	15-16141	289
PAF25-00000013	27-8252310	215	PAF25-05050400	852388A1	217	PAF8-04000002-2	15-813277	289
PAF25-00000013	27-8M0069692	236	PAF25-05050400	852388T1	241	PAF8-04000003	803740 1	291
PAF25-00000013		237	PAF25-05060002	855219	278	PAF8-04000004-1	853795 5	291
PAF25-00000014	825010	219-223	PAF25-05060003	878431	278	PAF8-04000005	161587	182-291
PAF25-00000014	17-82368M	251	PAF25-05080004	855837	278	PAF8-04000006	161586	68-182-291
PAF25-00000014	17-825010	215	PAF25-05120000	339-859738T1	117	PAF8-04000007	8037531	68-180-291
PAF25-02000019	12-81852M	331	PAF25-05130000	826398T3	84	PAF8-04000008	16158 5	68-291
PAF25-02010003	629101	223	PAF4-03000001	18853M	319	PAF8-04000009	803750A02	179-291
PAF25-02010005	826887M	215	PAF4-03000005	96309M	319	PAF8-04000010	8037511	181-291
PAF25-03000008		215	PAF4-03000006	12-81875M	315	PAF8-04000012	16140	291
PAF25-03000009		215	PAF4-03000006	12-96311M	319	PAF8-04000012-1	16141	287-297
PAF25-03000011		215	PAF4-03000011	27-96295	319	PAF8-04000012-2	813277	287-291
PAF25-04000007	17-82354M	323-331	PAF4-03000012	8M0080450	319	PAF8-04000013	804903	291
PAF25-05000002	82503395	223	PAF4-03000013		319	PAF8-04000014	803741 1	291
PAF25-05000002	10-82503395	215	PAF4-03000015	96303M	319	PAF8-04000015	895156	291
PAF25-05000003		215	PAF4-03000016	17-82355M	319	PAF8-04000016	895155	291
PAF25-05000004	25-833103	215-239	PAF4-03000018	27-96300	319	PAF8-04000017	803730001	291
PAF25-05000005	830272A1	215	PAF4-03000019	46-96299M	319	PAF8-04000019	803743	297
PAF25-05000007	8556692	215	PAF4-03000020	96306M	319	PAF8-04000019	803743002	291
PAF25-05000011	25-33466	278	PAF4-03000021	26-80398M	319	PAF8-04000019	8M0131240	353
PAF25-05000021	833102	217	PAF4-03000025		319	PAF8-04000019		354
PAF25-05000021	833102T	221	PAF4-03000026		319	PAF8-04000021	9521811	287
PAF25-05000022		217	PAF4-03050001	96318M	319	PAF8-04000021	17-9521811	346
		221-223-	PAF4-04000001	881816	311	PAF8-04000021	95218 11	291
PAF25-05000024	91800	231	PAF4-04000006	831246	225-233	PAF8-04000021		68
		217	PAF4-04000008	25-825492	211	PAF8-04000101	95348	287-291-
PAF25-05000026	11-81773M	217	PAF4-04000019	825666001	213			316
PAF25-05000035	893541082	223	PAF4-04000019	18856M	221-223	PAF8-04000200	803748 1	68-291
PAF25-05000100	35-822626Q04	215	PAF4-04000019	28-18856M	217	PAF8-04000301	803744002	291
PAF25-05010000	2806-0830267T3	215	PAF4-04000019	28-825666001	207	PAF8-04000302	892777002	291
PAF25-05010103	416223	219	PAF4-04000019	28-825666001	207	PAF8-04000303	803745 1	291
PAF25-05010104	384073	219	PAF4-04000030	95395	203-213	PAF8-04000305	16152	291
PAF25-05010106	8525601	215	PAF4-04000030	54-952245	72-204-	PAF8-04010000	16150	291
PAF25-05010107	35-8548091	215	PAF4-04010102	22-94716M	215-247	PAF8-04010000	8037391	291
PAF25-05010108	27-8547801	215	PAF4-05000010		251	PAF8-04020001L	803738005	291
PAF25-05010109	832734A2	215	PAF4-05000300	35-16248	68-77	PAF8-04020001S	803738004	291
PAF25-05010111	27-830298	170-215	PAF40-05000001		242	PAF8-04040000		291
PAF25-05010112	883336T1	215	PAF40-05000002	854341	219	PAF8-04040001	8037632T03	291
PAF25-05010113	22-996642	215	PAF40-05000005	893691T02	219	PAF8-04040002	16131	287-291
PAF25-05010302-1	893630001	223	PAF40-05000011	893697	219-223	PAF8-04040004	16130	291
PAF25-05010302-1	893631001	221-223	PAF40-05000053	804078	225	PAF8-05000002	27-803508017	207-239
PAF25-05010302-2	23-825024	217	PAF40-05000200	339-858942T1	117	PAF8-05000004	57-895120	207-272
PAF25-05010302-2	893631	221-223	PAF40-05000400	889575	110-113-	PAF8-05000009	27-853525001	278
PAF25-05020001	2417-830269A1	217-242			219-223	PAF8-05000017	32-895153	207
PAF25-05020002	832013							

REF	R.O. / OEM	REF	R.O. / OEM	REF	R.O. / OEM
PAF8-05000300	803844T01	PAGB/T5783-M6X35	88348935	PAT5-03000022	25-161771
PAF8-05000400		PAGB/T5783-M6X35	88525245	PAT5-03000023	16165
PAF8-05000500	339-803559A02	PAGB/T5783-M6X35	10-88348935	PAT5-03000201	46-826053T
PAF8-05000800	35-895152002	PAGB/T5783-M6X35	10-91722M	PAT5-03000400	44-195133
PAF8-05010000	878-815013T06	PAGB/T5783-M6X35	10-91772M	PAT5-03000402	24-17667
PAF8-05010002	22-822644001	PAGB/T5783-M6X40	4000333	PAT5-03000403	52-812946
PAF8-05010004	27-834952001	PAGB/T5783-M6X40	88525240	PAT5-03000404	16152
PAF8-05010005	853702005	PAGB/T5783-M6X8	400325	PAT5-03000500	825118T
PAF8-05010005	27-853702	PAGB/T5783-M6X8	4000325	PAT5-03000800	161451
PAF8-05010005	27-853702005	PAGB/T5783-M8X14	83124714	PAT85-00000012	82801M
PAF8-05010005	68-69-164-	PAGB/T5783-M8X25	827207	PATLA1412Z	23-16124
PAF8-05010005		PAGB/T5783-M8X25	8878272	PH130-0006	50-853805T03
PAF8-05010006	8537052	PAGB/T5783-M8X35	857139	PH130-0007	50-92669M
PAF8-05010009	31-834960T08	PAGB/T5783-M8X35	8852635	PH130-0007	81490M
PAF8-05010012	26-855681001	PAGB/T5783-M8X35	879194192	PH130-0007	97072M
PAF8-05010014	43-834955001	PAGB/T5783-M8X35	10-82442M	PH130-0009	50-819968
PAF8-05010015	895119	PAGB/T5783-M8X50	985810050	PH130-0009	50-819968-1
PAF8-05010016	11-855679001	PAGB/T5783-M8X55	881312	PH130-0009	50-819968-2
PAF8-05020001	400-834957T01	PAGB/T5783-M8X55	41884M	PH130-0009	50-819968-3
PAF8-05020101	700-834963A02	PAGB/T5785-M10X-1.25X40		PH130-0009	50-819968-4
PAF8-05020105	825713001	PAGB/T5787-1986	895810050	PH130-0009	50-819968T
PAF8-05020105	41-825713001			PH130-0009	50-853869
PAF8-05020200	600-834961002	PAGB/T5787-M6X20	167051	PH130-0009	50-853869-T
PAF8-05030001	850838T01			PH130-0010	50-29105
PAF8-05030002	850839T01	PAGB/T5787-M6X20	1993720	PH130-0010	50-30842
PAF8-05030004	855959001	PAGB/T5787-M6X30	858530	PH130-0010	50-31976
PAF8-05030005	24-803554005	PAGB/T5787-M6X30	892454030	PH130-0010	50-32411
PAF8-05030006	822650001	PAGB/T6170-85	400213	PH130-0010	50-37274
PAF8-05030007	28-803556	PAGB/T6182-2000	401388	PH130-0010	50-45822
PAF8-05030008	834956005	PAGB/T6182-M5	8528165	PH130-0010	50-48643
PAF8-05030009	24-825452001	PAGB/T818-M4X10	4005685	PH130-0010	50-55304A-1
PAF8-05030011	825455001	PAGB/T818-M4X8	804120	PH130-0010	50-673341
PAF8-05030011	26-825455001	PAGB/T818-M6X16	10-83870M	PH130-0010	50-87788
PAF8-05030012	27-853523001	PAGB/T820-M4X12	827443001	PH130-0011	50-44369
PAF8-05030015	895118	PAGB/T820-M5X30	10-83858M	PH130-0011	50-44369A1
PAF8-05030015	12-895118001	PAGB/T845-ST4.2X16	10-84272M	PH130-0011	50-73521
PAF8-05030100	900-835430T03	PAGB/T845-ST4.8X9	10-84788M	PH130-0014	50-73521T
PAF8-05030200	850841002	PAGB/T848-6	859768	PH130-0014	50-825991A2
PAF8-05030300	834967T03	PAGB/T848-6	953921	PH130-0015	50-44369A1
PAF8-05030400	834973001	PAGB/T848-6	12-953921	PH130-0015	50-73521
PAF8-05030400	43-834973001	PAGB/T861.1-87	12-82214M	PH130-0015	50-66015
PAF8-05040000	339-895110T01	PAGB/T861.1-87	12-827055M	PH130-0019	50-66015T
PAF8-05040000	339-895110T11	PAGB/T879.1-3.5X28	17-16150	PH130-0019	50-66015T1
PAF8-05090000W	855944T01	PAGB/T879.4-3X20	17-82145M	PH130-0021	50-893891T
PAGB/T1099-3X5X13	28-825666	PAGB/T889.1-M5	11-81781M	PH130-0021	50-893889T
PAGB/T276-6002	30-16132	PAGB/T896-86	53-82331M	PH130-0021	50-8M0033984
PAGB/T276-6004	16128	PAGB/T91-1.6X12	18-82132M	PH130-0021	50-90983A1
PAGB/T276-6004	30-1628	PAGB/T91-2.5X20	18-815026	PH130-0022	50-90983T1
PAGB/T276-6004C2	30-82291T			PH130-0022	50-820193
PAGB/T276-6204	30-8037331	PAGB/T91-2.5X20	18-8150261	PH130-0022	50-820193-1
PAGB/T3452.1-32.5X1	825057003	PAGB/T91-2.5X30		PH130-0023	50-818445-2
PAGB/T3452.1-35.5X1	25-825057003	PAGB/T91-3.2X18	18-815026	PH130-0023	50-818445-3
PAGB/T5287-6	12-825498	PAGB/T96-10	859894	PH130-0023	50-818445-5
PAGB/T5782-M6X125		PAGB/T96-10	12-16146	PH130-0024	50-822462
PAGB/T5782-M6X25	8248326	PAGB/T96-10		PH130-0024	50-822462T1
PAGB/T5782-M6X35	88348935	PAGB/T96-10	12-161402	PH130-0024	50-893890T
PAGB/T5782-M6X35	10-88348935	PAGB/T97.1-5		PH130-0024	822462T1
PAGB/T5782-M6X40	4000333	PAGB/T97.1-6	12-16826	PH130-0024	893890T
PAGB/T5782-M6X45	10-827043M	PAGB/T97.1-6	12-82214M	PH130-0025	50-819271
PAGB/T5782-M6X90	8M0008535	PAGB/T97.1-6	12-82214M	PH130-0025	50-820193A1
PAGB/T5782-M8X35	857139	PAGB/T97.1-6	12-881379	PH130-0028	50-854636T
PAGB/T5782-M8X35	10-857139	PAGB/T97.1-6		PH130-0028	50-859170T
PAGB/T5782-M8X40	88552640	PAGB/T97.1-8	12-82214M	PH130-0028	50-884045T
PAGB/T5782-M8X80	10-82506182	PAGB/T97.1-8	12-82217M	PH130-0028	50-888160T
PAGB/T5783-M5X12	10-41884M	PAGB/T97.1-8	814576M	PH130-0028	50-893891T
PAGB/T5783-M5X12	10-43092M			PH130-0028	854636T
PAGB/T5783-M5X12	10-82500930	PAGB/T97.1-8		PH130-0028	859170T
PAGB/T5783-M5X12	10-826957M			PH130-0028	893887T
PAGB/T5783-M5X12	10-850879	PAGB3452.1-82	25-8250572	PH130-0029	50-830308T
PAGB/T5783-M5X12	10-855778	PAGB3452.1-97.5X1.8	25-854722	PH130-0029	50-859168T
PAGB/T5783-M5X12		PAHT-2.5X60	816311T	PH130-0029	50-888151T
PAGB/T5783-M5X14	40011106			PH130-0029	50-893886T
PAGB/T5783-M5X16	40011107			PH130-0030	50-893886T
PAGB/T5783-M5X16	10-92521M	PAJASOF404-35-025	90196	PH130-0030	50-833153
PAGB/T5783-M6X10	10-84088M			PH130-0030	50-833153-1
PAGB/T5783-M6X12	8230427	PAJASOF40431-025	25-825492	PH130-0030	50-833153-2
PAGB/T5783-M6X12	88552512	PAJASOF40431-025	25-8M0052669	PH130-0030	50-833153-5
PAGB/T5783-M6X16	16832	PAJASOF40431-025		PH130-0030	50-832997 1
PAGB/T5783-M6X16	875206	PAJASOF40431-050	25-16131	PH130-0031	50-832997 2
PAGB/T5783-M6X16	881428	PAJISB2401P16	25-16178	PH130-0033	50-859377T
PAGB/T5783-M6X16	88552516	PAPS2700.04.03	26-822647	PH130-0033	50-884044T
PAGB/T5783-M6X16	10-8248324	PAT15-04010202	22-80122M	PH130-0033	50-888161T
PAGB/T5783-M6X16	10-826957M	PAT3.6-04000006	95229	PH130-0033	50-893888T
PAGB/T5783-M6X16	10-84368M	PAT3.6-04000006	28-95229	PH130-0034	50-852570T
PAGB/T5783-M6X16		PAT40-02000002	26-81427M	PH130-0034	50-857065
PAGB/T5783-M6X20	825702	PAT40-04000003-1	15-19148M	PH130-0034	50-859168T
PAGB/T5783-M6X20	8257021	PAT40-04000003-2	15-81469M	PH130-0040	50-30829
PAGB/T5783-M6X20	8254741	PAT40-04000003-3	15-19149M	PH130-0040	50-32403
PAGB/T5783-M6X20	88552520	PAT40-04000003-4	15-19150M	PH130-0040	50-37345
PAGB/T5783-M6X20	10-84058M	PAT40-04000003-5	15-19151M	PH130-0040	50-38890
PAGB/T5783-M6X20	8M4503518	PAT40-04000003-6	15-19152M	PH130-0040	50-38890A1
PAGB/T5783-M6X20	10-40011128	PAT40-04000003-7	15-19153M	PH130-0040	50-55601A
PAGB/T5783-M6X25	82500925	PAT40-04000004-1	15-19154M	PH130-0040	50-55601A2
PAGB/T5783-M6X25		PAT40-04000004-5	15-81459M	PH130-0041	50-44369A1
PAGB/T5783-M6X25	88552525	PAT40-04000007	31-98933M	PH130-0041	50-57485
PAGB/T5783-M6X25	10-11746M	PAT5-03000004-1	15-161631	PH130-0041	50-60315
PAGB/T5783-M6X25	10-2405M	PAT5-03000004-2	15-8132761	PH130-0041	50-65436
PAGB/T5783-M6X25	10-82500925	PAT5-03000005	27-16164	PH130-0041	50-66015
PAGB/T5783-M6X25	10-88348935	PAT5-03000006	27-16160	PH130-0041	50-66015-2
PAGB/T5783-M6X30	881427	PAT5-03000009	28-16155	PH130-0041	50-88119
PAGB/T5783-M6X30	88552530	PAT5-03000012	32-16167	PH130-0041	50-893891T
PAGB/T5783-M6X30	892454030	PAT5-03000013	26-16168	PH130-0042	50-893891T
PAGB/T5783-M6X30	10-8257021	PAT5-03000014	26-16171	PH130-0042	50-57465A1
PAGB/T5783-M6X30	10-83285M	PAT5-03000015	12-16140	PH130-0042	50-58330
PAGB/T5783-M6X30	10-92523M	PAT5-03000016	16133	PH130-0042	50-60975
		PAT5-03000020	23-16176	PH130-0042	50-72467
				PH130-0046	50-44415
				PH130-0046	50-77141

REF	R.O. / OEM	REF	R.O. / OEM	REF	R.O. / OEM			
PH130-0046	50-79472	129	PRE3300C12	8M0082584	160	REC10W30U3	83	
PH130-0046	50-884238T	129	PRE3300C13	8M0082585	160	REC10W30U6	83	
PH130-0047	480955	128	PRE3300C14	8M0082586	160	REC11-13436	11-13436	335
PH130-0047	50-583869	128	PRE3300C15	8M0082587	160	REC11-161471	11-161471	297
PH130-0047	50-616955-1	128	PRE3300C16	8M0082588	160	REC11-161471	11-161471	352
PH130-0047	50-819085	128	PRE3300C17	8M0082589	160	REC11-161470	16147	289
PH130-0047	50-819085-1	128	PRE3300C18	8M0082590	160	REC11-31990Q02	11-31990A2	354
PH130-0047	50-819085-T1	128	PRE3300C19	8M0082591	160			305-307-
PH130-0049	50-814980M	126	PRE3300C20	8M0082592	160	REC11-35921	11-35921	335-337-
PH130-0049	50-96359M	126	PRE3300C21	8M0082593	160			341
PH130-0049	50-97693M	126	PRE3300C22	8M0082594	160	REC11-4011912	11-40119-12	295
PH130-0055	50-804312T1	129	PRE3300C23	8M0082595	160	REC11-4011912	11-4011912	352
PH130-0057	50-881368T	129	PRE3300C24	8M0082596	160	REC11-4011912		354
PH130-0057	50-881368T1	129	PRE3300C25	8M0082597	160	REC11-401378	11-401378	305
PH130-0057	50-881368T2	129	PRE3300C26	8M0082598	160	REC11-40140	11-40140	293
PH130-0061	50-803835T02	126	PRE3300C27	8M0082599	160	REC11-52707Q1	11-52707A1	354
PH130-0062	50-814980M	127	PRE3300C28	8M0082600	160	REC11-52707Q1	11-52707Q1	334-336-
PH130-0066	50-853329T	129	PRE3300C29	8M0082601	160			354
PH130-0066	50-853329T01	129	PRE3300C30	8M0082602	160	REC11-52707Q1	11-827614Q	337
PH130-0066	50-892339T	129	PRE3300C31	8M0082603	160	REC11-52707Q1		352-354
PH130-0066	50-893892T	129	PRE3300C32		160	REC11-69578Q1	11-69578	352
PH130-0072	50-41583	127	PRE3300C33		160	REC11-69578Q1	11-69578A1	301-303-
PH130-0072	50-41583T	127	PRE3300C34	8M0082604	160			327
PH130-0074	50-888333T	130	PRE3300C35		160	REC11-69578Q1		354
PH130-0074	50-888333T1	130	PRE3300C36	8M0082605	160	REC11-8267089	11-13438	327-335
PH200-T003	19217A1-A5	151	PRE3300C38	8M0082606	160	REC11-859124	11-45812	327
PH200-T003	809885A2	151	PRE3300C40		160	REC11-88228	11-88228	295
PH200-T003	818903A1	151	PRE3300C42		160	REC11557		338
PH200-T003	819479A1	151	PRE3300C44		160	REC11770		338
PH200-T003	819480A1	151	PRE3300C46		160	REC12-12577	12-12577	305
PH200-T003	819762A4-A7	151	PRE3300C48		160	REC12-16448	12-16448	293
PH200-T003	81977A8-A9	151	PRE3300C50		160	REC12-191833	12-19183	347
PH200-T003	822870A1	151	PRE53006	8M0082529	160	REC12-191833	12-19183-2	337
PH200-T003	830250A3-T3	151	PRE53007	8M0082530	160			293-295-
PH200-T003	832021A1-T4-A2-T2	151	PRE53008	8M0082531	160	REC12-191833	12-19183-3	301-303-
PH200-T003	855654A1-T2	151	PRE53010	8M0082532	160			305-327-
PH200-T008	823653A5/A9	152	PRE53011	8M0082533	160			335
PH200-T008	92459A4	152	PRE53012	8M0082534	160	REC12-191833	12-20260	317-347
PH200-T010	828708	152	PRE53013	8M0082535	160	REC12-191833		68-69-70
PH200-T010	828708T	152	PRE53014	8M0082536	160	REC12-20084	12-20084	347
PH200-T010	878265A2	152	PRE53015	8M0082537	160	REC12-29245	12-29245	295-301-
PH200-T010	878265A4	152	PRE53016	8M0082538	160			327-335
PH200-T015	17649A1/A02	152	PRE53017	8M0082539	160	REC12-29245	12-89302	295
PH200-T033	824051	152	PRE53018	8M0082540	160	REC12-31211Q01	13171	352
PH200-T033	830250A6	152	PRE53019	8M0082541	160	REC12-31211Q01	12-825467	352
PH200-T069	88845T02	152	PRE53020	8M0082542	160	REC12-31211Q01	12-835467	337
PH200-T069	888645T1	152	PRE53021	8M0082543	160	REC12-31211Q03	12-31211A2	344
PH200-WH01	84-819514T26	151	PRE53022	8M0082544	160	REC12-31211Q03	12-31211A3	354
PH200-WH01	84-826075A2	151	PRE53023	8M0082545	160	REC12-31211Q03		335-337
PH200-WH01	84-826802A4	151	PRE53024	8M0082546	160	REC12-38453	12-38453	170-327
PH300-0019	821663	136	PREKM63706	8M0082547	160	REC12-41369	12-41369	293
PH300-0019	821663A1	136	PREKM63707	8M0082479	160	REC12-45176	12-45176	305
PH300-0030	889955	136	PREKM63708	8M0082480	160	REC12-76451	12-76451	169
PH300-0030	875285T1	136	PREKM63709	8M0082481	160	REC12-77674	77674	309
PH300-0030	881248T	136	PREKM63710	8M0082482	160	REC12-77674	12-77674	307-327-
PH300-0031	889956	136	PREKM63711	8M0082483	160			335-337-
PH300-0031	875286A1	136	PREKM63712	8M0082484	160	REC12-78910	12-78910	347
PH300-0031	881247A1	136	PREKM63713	8M0082485	160	REC12-78910	12-78910	335
PH300-0047	50-897755T	137	PREKM63714	8M0082486	160	REC12-815481	815481	305
PH300-0047	8M0063970	137	PREKM63715	8M0082487	160	REC12-835467Q01	13171	353
PH300-0048	892940T/T01	136	PREKM63716	8M0082488	160	REC12-835467Q01	12-835467-1	335
PH350-0003	62351	138	PREKM63717	8M0082489	160	REC12-835467Q01	835467Q01	353
PH350-0003	78614	138	PREKM63718	8M0082490	160	REC12-835467Q01		354
PH350-0003	332-2910	138	PREKM63719	8M0082491	160	REC12-85303	12-85303	169
PH350-0003	816770/T	138	PREKM63720	8M0082492	160	REC12-855941	12-855941	305
PH350-0003	8M0058226	138	PREKM63721	8M0082493	160	REC12-86645	12-86645	347
			PREKM63722	8M0082494	160	REC12-86645	12-86645-1	295-301
PH350-0003		135-136-147-148-149	PREKM63723	8M0082495	160	REC12-86645		252
			PREKM63724	8M0082496	160	REC12-8M0012298	812876	168
				8M0082497	160	REC12-94182	12-94182	168
					160	REC12094	46-43024A7	186-304
					160	REC12094	46-8M0113799	186
PH375-0008	809463A1	132				REC12094		189-191-
PH375-0011	25661-1	132						194-195
PH375-0028	89-68258A4	132						
PH375-0031	65057A1	132	RAC120R-RAC-01		75			
PH375-0034	89-818997A1	133	RAC31871	35-884380T	78	REC12415	12415	110
PH375-0034	89-850187T1	133	RAC31871	35-8M0020349	78	REC12596T2	12596T2	305
PH375-0036	89-818999A1/A2	133	RAC31871	8M0060041	78	REC13-423511	13-42351-1	335-337-
PH375-0036	89-825842A1	133	RAC31871	8M0122423	78			353
PH375-0036	89-850188A1	133	RAC320R-RAC-01	8M0097838	75	REC13191Q01	13191A1	305-352
PH375-0037	89-817109A1	134	RAC320R-RAC-03		75	REC13191Q01	75282A1	352
PH375-0037	89-817109A2	134	RAC490R-RAC-01		75	REC13191Q01		344-354
PH375-0037	89-817109A3	134	RACPF5510		74	REC13350	75692	162
PH375-0037		135	RACRK22628		76	REC13350	27-62386	162
PH375-0042	881352T	132	RACS3213		75	REC13650-52G00	898101118	112-113
PH375-0042	89-853809001	132	RACS3227		75	REC13650-56B00	880882T	109-114
PH375-0042	8M0098898	132	RACS3240		76	REC13914Q02	11-13914A2	354
PH375-0042		134-135	REC09168-10022	8M0082880	68-298	REC1395-2015	1399-1717	100
PH375-0047	804281T	132	REC09401-11425		72	REC1395-2015	1399-2015	100
PH375-0047	87-851839	132	REC09401-11425BULK		72	REC1395-2015	1399-3523	100
PH375-0047	87-8518391	132	REC10-30720		346	REC1395-2015		92-93-94
PH375-0047		134	REC10-48408	10-30720	293	REC1395-48401	1395-4808-1	93-94-95-
PH375-0048		134	REC10-49908	10-48408	295			103
		132	REC10-69570	10-49908	168	REC1395-5198	1399-5135	101
PH400-0002	398-832075A3-A4-A5-A6-A9-A12, 398-9873A22-A28	144	REC10-79953Q04	10-69570	345	REC1395-5198	1399-5198	92-93
PH400-0002		147-148-149	REC10-79953Q04	10-79953Q04	307	REC1395-6200	1395-6200	93-94-102
PHSEL-239	89-96158	133			293-295-	REC1395-6452	1395-6452	103
POWERHEAD20-25		217			301-303-	REC1395-6452	1395-8506	103
PRE30107	82779	159	REC10-79953Q04	10-79953Q2	327-335-	REC1395-6452		95-96
PRE30212	892790A01	159			337	REC1395-6523	1395-7623	106
PRE3300C05	8M0082577	160	REC10-806327	10-806327	307-337	REC1395-7623	1395-9267	106
PRE3300C06	8M0082578	160	REC10-816928	10-19937-16	337	REC1395-7623		95-96
PRE3300C07	8M0082579	160	REC10-816928	10-816928	307	REC1395-7824	1395-7824	95-96-105
PRE3300C08	8M0082580	160	REC10-82684430	10-826844-30	293-305	REC1395-8112231	1395-811223-1	102
PRE3300C09	8M0082581	160	REC10-91012	91012	249	REC1395-8112231	1395-8112231	249
PRE3300C10	8M0082582	160	REC10-94320	94320	252-253	REC1395-8112231		93-94-95
PRE3300C11	8M0082583	160	REC10-94320	10-94320	252	REC1395-811690-1	1395-811690-1	95-96-105
			REC10-96411	10-96411	335-346	REC1395-811691-2	1395-811691 2	95-96-
								103-104

REF	R.O. / OEM		REF	R.O. / OEM		REF	R.O. / OEM	
REC1395-811691-3	1395-811691	103-104	REC17-828356	17-828356	307-335-337	REC25-33465	25-54029	263-264-265
REC1395-823635-4	1395-823635-4	101	REC17-85096	17-85096	295	REC25-35027	25-35027	337
REC1395-823635-4	1395-8236354	252	REC17-85500	17-85500	295	REC25-36318	25-36318	337
REC1395-823635-4		104	REC17-85593	17-85593	295-301	REC25-36318	25-896322	307
REC1395-8318	1395-8318	92-93-94-95-104	REC17-8M0020942	17-38113	303-327	REC25-45258	25-45258	303
REC1395-8673	1395-8673	106	REC17-8M0084243	17-78905	335	REC25-457101	25-45710	305
REC1395-8673	1395-8983	106	REC17-8M0084681	17-30632	305-307-335-337-344	REC25-62700	25-62700	263-265
REC1395-8673		92-93-94-95			69-199	REC25-62702	627021	219-223
REC1395-9022	1395-9022	92-93-105	REC17264T2		199	REC25-62705001	25-6270501	226
REC1395-9024	1395-9024	93-102	REC17264T2AL		154	REC25-62706	25-62707	263-264-265
REC1395-9594	1395-9594	93-94-95-106	REC18-5007		154	REC25-64872	25-64872	168
REC1395-9595-1	1395-9595-1	93-94-95-105	REC18-5012		154	REC25-67202	25-69202	295
REC1395-9650		101-104	REC18495A13	18495A4-5-6-8-13	141	REC25-80863	25-20863	263
REC1395-9651	1395-9651	93-102	REC18495A26	18495-A10-12-15-18-19-26	142-147-148	REC25-80863	25-815460	301
REC1395-97611	1395-811357	101	REC18495A30	18495A9, A14, A15, A20, A21, A25, A30	141-147	REC25-80863	25-809086	97
REC1395-97611	1395-9179	101	REC19052A8	19052A1, 2, 3, 4, 5, 6, 8	141-147	REC25-815460	25-815460	303
REC1395-97611	1395-9377	101	REC19271-1	19271-1	93-94-104	REC25-818573	25-818573	238
REC1395-97611	1395-9645	101	REC19273	19273	106	REC25-821308	25-821308	301
REC1395-97611	1395-9725	101	REC19291A3	19291A3	301-303	REC25-822236	25-822236	293
REC1395-97611	1395-97611	101	REC19643	19643	347	REC25-823683	823683	252-253
REC1395-97611	1395-9803	101	REC19700A2	19700A2	69-181-191-193-194-303	REC25-823683	25-823683	263
REC1399-1473	1395-9258	92-93-104	REC19755T7	19755T7	307	REC25-823683	25-854639	264-265
REC1399-1473	1399-1138	104	REC200		150	REC25-854639	25-854639	168
REC1399-1473	1399-1473	104	REC20843	20843	303-327	REC25-85549	25-85549	295
REC1399-1473		92-93-94	REC21-13424A1	21-13424A1	90-93-94	REC25-86203	25-86203	181
REC1399-3938	1399-3938	79	REC21-30430A1	21-30430A1	94-95	REC25-86203	25-86203	295
REC1399-5137	1399-5137	92-93-101	REC21-30430A13	21-30430A13	90-94	REC25-89497	25-89497	263-265
REC1399-99	1399-99	278	REC21-30430A14	21-30430A14	90-94-95	REC25-896523	25-896523	264-307
REC14-18323	14-18323	337	REC21-30430A3	21-30430A3	91-93-94-95	REC25-898836	898836	231
REC14-76281Q	14-76281	301-303-327-354-353	REC21-30430A4	21-30430A4	91-93	REC25-8M0000190	25-8M0000190	309
REC14-79447	14-79447	335	REC21-30430A7	21-30430A7	91-95	REC25-8M0034912	8M0034912	227
REC14307T01	14307T01	86	REC21-42990A10	21-42990A10	90-93-94-95-96	REC25-8M0056667	8M0056667	227
REC14307T01	14307T01	86	REC21285		354	REC25-8M0087846	807375	297
REC14334A3	14334A3	179-191-193-194-303	REC21307		354	REC25-8M0142840	25-8M0142840	309
REC14355		269-270	REC22-41622	416223	223	REC25-90011	25-90011	263-335-337
REC14360T74	14360T74	84	REC22-424254	22-424254	76	REC25000	89876A3	74
REC14360T77	14360T77	85	REC22-67892A05	22-67892A05	303	REC25010		74
REC14365		269-270	REC22-67892A05		293-295-301-303-305-327-335-345	REC25020		74
REC14450		269-270	REC22-687271	22-687271	168	REC25030		74
REC14460		269-270	REC22-8189941	22-8189941	76	REC25W40U3		83
REC14479-1	14479-1	168	REC22-887987A1	22-887987A1	347	REC26-00173	26-85107	238
REC14480	14480	167	REC22-8M0001721		72	REC26-12224	26-12224	189-335-337
REC14586	14586	69-162-164	REC22215		354	REC26-12709	26-12709	238
REC14586A3	14586A3	164-166	REC23-29804	23-29804	335-347	REC26-14240	26-14240	238
REC14586A7	14586A7	164-166	REC23-29804T	23-29804	293	REC26-16051	26-16051	244
REC1463-9382	32193A2	119	REC23-41367	23-41367	293	REC26-16130	16130	289
REC1463-9382	806529A1	119	REC23-420911	23-42091-1	293	REC26-161301		188
REC14857A16	14857A10, A16	149	REC23-420911	23-420911	353	REC26-16162	26-16162	289
REC15-201		125	REC23-43045	23-43045	303	REC26-161622	161622	188-297-299
REC15-202		125	REC23-43052A4	23-43052A4	305	REC26-16703	26-16703	204
REC15-203	84-813715A1	125	REC23-77631A2	23-77631A2	327-335	REC26-16977	26-16977	177-238-263-335
REC15-204		125	REC23-813696A2	23-813696A2	303	REC26-24590	26-24590	176-177-238
REC15-38657A1	15-38657A1	307	REC23-815921A21	23-815921A4-A10	344	REC26-30913	26-30913	176-238-317
REC15-38657A1	8M0063268	309	REC23-821927	23-821927	293	REC26-32511	26-32511	238
REC15-42637A1	15-42637A1	346	REC23-823943	23-823943	293	REC26-33467	26-33467	176-238
REC15-42637A1	8M0063267	309	REC23-823944	23-823944	293	REC26-33613	26-33613	293-317
REC15-44491A1	15-44491A1	305-337	REC23-824108	23-824108	335-337	REC26-36556	26-36556	347
REC15-47397A1	15-47397A1	335-337-346	REC23-85095	23-85095	295	REC26-36558	26-36558	317
REC15-812770A1	15-812770A1	303	REC23-85557	23-85557	295	REC26-38452	26-38452	327-347
REC15-884327A02	15-884327A01	307	REC23-86215	23-86215	317	REC26-38970	26-38970	335-344
REC15-8M0063265	15-44492A1	305	REC23-891919001	23-891919001	307	REC26-41132	26-41132	295
REC1504952	87-19761	133	REC23-8M0142859	23-8M0142859	309	REC26-413651	26-41365-1	293
REC15200-96J00		88	REC23-8M0164967	23-8M0164967	309	REC26-41365A3	26-41365A3	174-176-293
REC155278A1	155278A1	91-93-94-95	REC23014A1	23014A1	91-92-93-94-95	REC26-419533	26-41953	238
REC16058	16058T	119	REC24-13421	24-29340A1-T1	130	REC26-419533	26-41953 3	263
REC16061T04	16061T04	140	REC24-30893	24-30893	303-305-307-335-337-346	REC26-419533		264-265
REC16066004	16066004	112	REC24-38114	24-38114	301-327-346	REC26-421021	26-42102-1	293
REC16157	16157	181	REC24-42996	24-42996	168	REC26-42133	26-42133	293
REC161571	161571	287	REC24-47968	24-47968	168	REC26-43035	26-43035	305
REC16159	16159	68-180-289	REC24-64878	24-64878	168	REC26-43035A4	26-43035A4	174-176-189-304
REC1623-822442A19	1623-822442A19	281	REC24-78962	24-78962	335	REC26-43036	26-43036	177-238-305
REC1623-822442A20	1623-822442A20	281	REC24-79910	24-79910	335	REC26-43993	26-43993	253
REC1623-859399T13	1623-859399T13	281	REC24-815418	24-815418	303	REC26-43993	26-43993	238
REC1623-859399T14	1623-859399T14	281	REC24-86860	24-86860	295	REC26-43993	26-43993	252-263
REC16253	16253	92-105	REC24-90392	24-90392	168	REC26-45587	26-45587	238
REC162532	162532	105	REC24111-827954T2	827954T	249-270	REC26-55682	26-32911	238
REC1647-9148T81	1647-9148T81	281	REC24942		74	REC26-55682	26-55682	177
REC1647-9148T82	1647-9148T82	281	REC24950	35-802893Q4	74	REC26-55682A1	26-55682A1	175-176-334
REC1647-9148T84	1647-9148T84	281	REC24952		74	REC26-56397	26-56397	238-164-363
REC1647-9148T85	1647-9148T85	281	REC25-20081	25-20081	263	REC26-56788	26-56788	177
REC16496	16496	168	REC25-20273	25-20273	181-327	REC26-62818	26-62818	238
REC1667-9011G90	1667-9011G70	282	REC25-21836	25-21836	309	REC26-66022	26-66022	293-317
REC1667-9011G90	1667-9011G90	282	REC25-25439	25-25439	327-335	REC26-66301	26-66301	263-264
REC1667-9011J41	1667-9011J41	282	REC25-30224	25-30224	303	REC26-66302	26-66302	263-264-337
REC1667-9011R6	1667-901110.11	282	REC25-30271	25-30271	181-335	REC26-66303A1	26-66303A1	175-176-176-177-188-189-238-301-303-327
REC1667-9011R6	1667-901167.78	282	REC25-30529	25-30529	317	REC26-69188	26-69188	188-189-176-177-188-189-238-301-303-327
REC1667-9011R6	1667-9011G51	282	REC25-31534	25-31534	337	REC26-69189	26-69189	176-177-188-189-238-301-303-327
REC1667-9011R6	1667-9011J6	282	REC25-31534	25-31534	335			
REC1667-9011R6	1667-9011R6	282	REC25-31534	25-31534	307			
REC16910-GB2-005	35-8M0157133	77	REC25-32546	25-32546	263-264			
REC17-43043	17-43043	303	REC25-33145	25-33145	293			
REC17-43043	8M0084244	309						
REC17-81511Q02	815111	287						
REC17-822369	17-822369	301						

REF	R.O. / OEM		REF	R.O. / OEM		REF	R.O. / OEM	
REC26-70080	26-89236	189-238	REC27-19552	27-19552	327	REC27-856081	27-85608-1	184-335
REC26-70081	26-70081	177-189-	REC27-19553	27-19553	183-327	REC27-85653A87	27-85653A87	257-261
REC26-72785	26-72785	238-305	REC27-25725	27-25725	154	REC27-856704	27-85610-1	184
REC26-76127	26-41131	238	REC27-25848	27-25848	170	REC27-856729	27-85490-2	262
REC26-76868	26-14077	177-295	REC27-25849	27-25849	107	REC27-856730	27-85653-1	276
REC26-76868	26-76868	238-337	REC27-279361	27-27936-1	279	REC27-858524	27-858524	184-335
REC26-76868	26-76868	238-305-	REC27-29166	27-29166	154	REC27-877361	27-87736-1	280
REC26-76868	26-76868	335-337	REC27-29586	27-29586	347	REC27-880624003	880624003	231
REC26-77066A1	26-77066A1	174-176-	REC27-31402	27-31402	278	REC27-880624003	27-880624003	237
REC26-79831	26-79831	174-176-	REC27-32438	27-32438	183	REC27-880624003		240
REC26-79831A1	26-79831A1	317	REC27-32771	27-32771	184	REC27-880729	27-880729	307
REC26-803514	898101285	176-177-	REC27-385011	27-38501-1	275	REC27-883213	27-883213	87-97
REC26-803514	25-803514	238-327	REC27-39401	27-39401	259	REC27-883252	27-883252	97
REC26-803514	26-803514	174-176-	REC27-39402	27-39402	276	REC27-883775	27-813859	280
REC26-803514	26-803514	327	REC27-396231	27-39623	182	REC27-88449	27-88449	262
REC26-8036674	8036674	REC27-39625	REC27-39625	27-39625	182	REC27-88449A32	27-88449A32	256-260
REC26-803752	803752	REC27-39626	REC27-39626	27-39626	182	REC27-884511	27-88451-1	258
REC26-807006	26-18816	REC27-41245-1	REC27-41245-1	27-41245-1	255-261	REC27-889319	27-889319	97
REC26-814669	26-814669	REC27-41246-1	REC27-41246-1	27-41246-1	255-261	REC27-889561	27-889561	274
REC26-814669A2	26-814669A2	REC27-41499A87	REC27-41499A87	27-41499A87	255-260	REC27-889617001	889617001	277
REC26-814670	26-814670	REC27-41670006	REC27-41670-3	27-41670-3	258	REC27-889618001	27-889618001	274
REC26-8164641	8164641	REC27-418786T	27-418786T	27-418786T	255-261	REC27-892211	27-89221-1	279
REC26-8164641	26-816464	REC27-42364A92	REC27-42364A92	27-42364A92	255-260	REC27-89221A88	27-89221A88	257-261
REC26-8164641	26-816464-1	REC27-426311	REC27-42631-1	27-42631-1	183-335	REC27-895822	27-895822	274
REC26-816575A2	23-29804	REC27-43004009	REC27-43004-1	27-43004-1	276	REC27-896142	896142	229
REC26-816575A2	26-816575A2	REC27-43004A99	REC27-43004A99	27-43004A99	253-256-	REC27-896142	27-896142	237
REC26-816575A4	26-816575A4	REC27-430057	REC27-430057	27-430057	260-261	REC27-896142		239-240
REC26-816575A5	26-816575A5	REC27-43006-8	REC27-43006-8	27-43006-8	170	REC27-897534A07	27-897534A07	226-235
REC26-8173971	817397 1	REC27-43007-3	REC27-43007-3	27-43007-3	167	REC27-898101331	898101331	68-287
REC26-820645A1	26-820645A1	REC27-430086	REC27-430086	27-430086	259	REC27-89937	27-89937	258
REC26-821092	26-821092	REC27-430331	REC27-43033-1	27-43033-1	276	REC27-8M0024563	27-897534	237
REC26-821309	26-821309	REC27-430472	REC27-43047-2	27-43047-2	183-305-	REC27-8M0024563	27-8M0024563	237
REC26-821310	26-821310	REC27-433374	REC27-43337-4	27-43337-4	307-337	REC27-8M0024563	8M0024563	226
REC26-821928	26-821928	REC27-437772	REC27-43777-2	27-43777-2	183-305	REC27-8M0024563		239
REC26-823894	26-68493	REC27-437792	REC27-43779-2	27-43779-2	275	REC27-8M0057703	27-8M0057703	237
REC26-830749	830749	REC27-43779A87	REC27-43779A87	27-43779A87	262	REC27-8M0057703	8M0057703	227
REC26-830749	26-830749	REC27-46351	REC27-46351	27-46351	262	REC27-8M0057703		239-240
REC26-830749	26-830749	REC27-47190	REC27-47190	27-47190	256-260	REC27-8M0057763	27-8M0057763	227-236
REC26-830749	26-830749	REC27-481641	REC27-48164-1	27-48164-1	154	REC27-8M0075040	27-8M0075040	182
REC26-830898	26-830898	REC27-48801	REC27-48801	27-48801	154	REC27-8M0075040	8M0075040	297
REC26-8509001	26-850901	REC27-552791	REC27-55279-1	27-55279-1	279	REC27-8M0075040		68
REC26-8509001	26-850901	REC27-62107	REC27-62107	27-62107	277	REC27-8M0135597	27-8M0135597	87-97
REC26-8509001	26-850901	REC27-62386001	REC27-62386	27-62386	279	REC27-8M0135804	27-8M0135804	182
REC26-8509001	26-850901	REC27-628601	REC27-62860-1	27-62860-1	166-169	REC27-8M0135804	8M0135804	298
REC26-8509001	26-850901	REC27-657443	REC27-65744-2	27-65744-2	258	REC27-8M0135806	27-8M0135806	182
REC26-8509001	26-850901	REC27-66847	REC27-66847	27-66847	280	REC27-8M0135806	8M0135806	298
REC26-8509001	26-850901	REC27-672751	REC27-67275-1	27-67275-1	167-275	REC27-8M0142616	27-8M0050720	183
REC26-8509001	26-850901	REC27-677511	REC27-67751-1	27-67751-1	280	REC27-8M0142616	8M0112903	309
REC26-8509001	26-850901	REC27-692381	REC27-69238-1	27-69238-1	279	REC27-8M0142616	8M0142616	183
REC26-8509001	26-850901	REC27-695242	REC27-69524-2	27-69524-2	276	REC27-8M0146938	8M0146938	309
REC26-8509001	26-850901	REC27-695252	REC27-69525-2	27-69525-2	275	REC27-8M4502052	27-19701	303
REC26-8509001	26-850901	REC27-703351	REC27-70335-1	27-70335-1	275	REC27-8M4502052	27-8M4502052	69-183
REC26-8509001	26-850901	REC27-72486A32	REC27-72486A32	27-72486A32	275	REC27-8M6000365	27-8M6000365	227
REC26-85370711	26-85370711	REC27-733771	REC27-73377-1	27-73377-1	256-260	REC27-8M6000366	27-8M6000366	234
REC26-8537077	26-8537077	REC27-75786	REC27-75786	27-75786	279	REC27-8M6000366	8M6000366	227
REC26-859093	26-815449	REC27-757911	REC27-75791-1	27-75791-1	277	REC27-8M6000366		239-240
REC26-880596502	26-880596502	REC27-75909	REC27-75909	27-75909	278	REC27-904301	27-90430-1	280
REC26-880629	26-880629	REC27-76636	REC27-76636	27-76636	259	REC27-904841	27-90484-1	276
REC26-88397	26-88397	REC27-76952	REC27-76952	27-76952	280	REC27-90484A88	27-90484A88	257-261
REC26-888483	888483	REC27-78028A78	REC27-78028A78	27-78028A78	279	REC27-935361	27-93536-1	280
REC26-888483	26-888483	REC27-782461	REC27-78246	27-78246	256-260	REC27-96278	27-96278	262
REC26-888483	26-888483	REC27-78409	REC27-78409	27-78409	276	REC27-96542-1	27-96281T01	254
REC26-888483	26-888906	REC27-78410	REC27-78410	27-78410	276	REC27-96542-1	27-96542-1	254
REC26-888483	26-888906	REC27-78411	REC27-78411	27-78411	262	REC27-96542-1		261
REC26-888593	26-888593	REC27-78690002	REC27-78690	27-78690	262	REC27-96761-1	27-96761-1	280
REC26-888920	26-888920	REC27-78690002	REC27-78690002	27-78690002	167-280	REC27-987691	27-98769-1	279
REC26-888921	26-888921	REC27-79583-1	REC27-79583-1	27-79583-1	167	REC27-991734	27-99173-2	276
REC26-89238	26-89238	REC27-79583A81	REC27-79583A81	27-79583A81	255-261	REC27-991764	27-99176-3	259
REC26-89238A2	26-89238A2	REC27-796501	REC27-79650-1	27-79650-1	258-261	REC27-991772	27-99177-2	259
REC26-897153	26-90063	REC27-803508	REC27-803508	27-803508	258	REC27-993163	27-993163	280
REC26-897153	26-90063	REC27-803508	REC27-803508	27-803508	204	REC27-993261	27-99326-1	182-295
REC26-897540	26-897540	REC27-8127755	REC27-812775-5	27-812775-5	204	REC27-997761	27-99776-1	259
REC26-8M0032912	26-8M0032912	REC27-812775A01	REC27-812775-4	27-812775-4	234	REC2704-821896A4	2704-821896A4	269
REC26-8M0032912	8M0032912	REC27-8128671	REC27-812867-1	27-812867-1	237	REC2704-821896A4	821896A4	253-271
REC26-8M0032912	8M0032912	REC27-8128672	REC27-812867-2	27-812867-2	276	REC2704-826191T4K	2704-826191A4	269
REC26-8M0033928	884461	REC27-812867A97	REC27-812867A97	27-812867A97	167	REC2704-826191T4K	2704-826191A4	271
REC26-8M0035127	8M0035127	REC27-812868	REC27-812868	27-812868	167	REC2704-826191T4K	2704-826191T4	271
REC26-8M0036343	26-804349004	REC27-812869	REC27-812869	27-812869	249-256	REC2704-826191T4K	826191T4	252-253
REC26-8M0142851	26-8M0142851	REC27-8141951	REC27-814195-1	27-814195-1	279	REC2704-826191T4K		270
REC26-8M0142851	26-8M2014338	REC27-814754A00	REC27-814754A00	27-814754A00	279	REC2720-881054T10K	2720-881054T10	271
REC26-8M0142979	26-8M0142979	REC27-815791A92	REC27-815791A92	27-815791A92	280	REC2720-881054T10K	2720-881054T3	268
REC26-8M0142979	26-8M0142979	REC27-8172771	REC27-817277-1	27-817277-1	257-261	REC2720-881055T10K	2720-881055T10	271
REC26-8M0142979	26-8M0142979	REC27-8172771	REC27-817277-1	27-817277-1	309	REC2720-881055T10K		268
REC26-90562	26-90562	REC27-8172771	REC27-817277-1	27-817277-1	183	REC28-30281	28-30281	327-335
REC26-94038	26-94038	REC27-8172771	REC27-817277-1	27-817277-1	305-307-	REC28-42376A2	28-42376A2	68-293-
REC26-99325	26-99325	REC27-8221370	REC27-8221370	27-8221370	337	REC28-803749	803749	297
REC27-11338A88	27-11338A88	REC27-822189	REC27-822189	27-822189	279	REC28-803749	28-803749	346
REC27-134612	27-134612	REC27-822217	REC27-822217	27-822217	69-183-</			

REF	R.O. / OEM		REF	R.O. / OEM		REF	R.O. / OEM	
REC29-818391001	29-818391	269	REC31-812873A1	31-812873A1	263-264	REC35-877761Q01	35-877761Q01	80
REC29-818391001		266-271	REC31-813048	31-813048	244-267-271	REC35-877761Q01		69-80-81-82
REC29-822553	29-822553	266-268-271	REC31-8130482	31-813048 2	267	REC35-87946Q04	35-87946Q04	78
REC29-88258	29-88258	252-269	REC31-8130482	31-8130482	248	REC35-87946Q04	35-87946Q3	78
REC29-88258	29-88258001	268	REC31-8130482		271	REC35-879885T	35-879885T	77
REC29-88258		266-271	REC31-814653T	814653T	309	REC35-879885T		69-70-81-82-83
REC2TU3		83	REC31-816773A2	31-816773A1	263-265	REC35-883701K01	35-877769Q01	80
REC2TU6		83	REC31-818889A1	31-818889A1	249	REC35-883701K01	35-883701K01	80
REC30-16049	16049	203	REC31-821321A1	31-821321A1	293-301	REC35-883701K01		70-80-82-83
REC30-16049	30-16049	242-244-263	REC31-828439A2	31-828439A2	337-340-341	REC35-883701K01		70-79-78-79
REC30-16049		241-264	REC31-855553	31-855553	249	REC35-893318T02	35-893318T02	70-79
REC30-160494	30-160494	248-263	REC31-879877A1	31-879877A1	266-267-271	REC35-896247	35-896247	69-79
REC30-16049T01	30-16049T01	248	REC31-884325T01	31-884325T01	307	REC35-896546T	35-877767K01	80
REC30-20839T	30-20839T	301-303-327	REC31-884325T01	8M0142835	309	REC35-896546T	35-877767Q01	80
REC30-62567T	30-62567T	263-264	REC31-98294A1	31-98294A1	295	REC35-896546T	35-896546T	80
REC30-63326T		264	REC31-10414	25-47254	263	REC35-896546T		69-80-82
REC30-64424T	30-64424	263	REC31-10414	25-97386	305	REC35-8M0088825	35-853733A2	78
REC30-64424T	30-64424T	263	REC31-10584	25-35276	264	REC35-8M0088825	35-853733T03	78
REC30-64424T		264	REC313339	11-55910	295	REC35-8M0088825	35-898101T68	78
REC30-67923T	30-67923	263	REC3164004		301-303-327-341	REC35-8M0088825	35-8M0088825	78
REC30-67923T	30-67923T	263	REC3164004AL		199	REC35-8M0088825		81
REC30-67923T		265	REC318395	878907	199	REC35-8M0106635	8M0106635	70-78-82-83
REC30-72961	31-72961	242	REC32-88005	32-88005	69-70-199	REC35-8M0122423	35-884380T	78
REC30-88957T	30-88957T	335-337	REC32-88006	32-88006	167	REC35-8M0122423	35-8M0020349	78
REC30-95347	95347	316	REC32-88006	32-88006	151	REC35-8M0122423	8M0060041	78
REC30-95347	30-95347	289	REC320961	26-56788	238	REC35-8M0122423	8M0122423	78
REC300-01852	332-5524, A1, A5, A6, A9, A12, A14	142	REC324351	32435	181-194-195-196-335	REC35-8M0123025	35-8M0123025	69-70-82-83
REC300-01852		147-148-149	REC327031	26-30900	317	REC35-8M0134466	35-8M0134466	70-80-82-83
REC300-03107	332-5772A1	141	REC327674	27-327674	275	REC35-8M0149607	35-8M0149607	68-78-81
REC300-03107	332-5772A2	141	REC32768	32768	327	REC35-8M0157620	35-8M0095658	77-81
REC300-03107	332-5772A3	141	REC32768	54705	181	REC35-8M0157620	8M0157616	74
REC300-03107	332-5772A5	141	REC32768		193-194	REC35-8M0157620	8M0157620	74
REC300-03107	332-5772A7	141	REC32800-38F10	881346T	138-139-146	REC350-01005-0	27-803663	254
REC300-03107		147-148	REC3303-812648T		100	REC350038	12-92721	307-335-337-347
REC300-08309	339-7370A13	117	REC3303-8231752		100	REC351-01005-0	27-803663018	254
REC300-08310	339-85699A1	119	REC331886	22-9964-1	169	REC3717139	30-63742T	263
REC300-8M0044991	300-8M0044991	118-119-120-227	REC332-2986A27	332-2986A21	142	REC3717139	63742T	249
REC300-8M0077471	339-879984A01	118	REC332-2986A27	332-2986A22	142	REC3717139		264
REC300-8M0077471	339-879984T00	118	REC332-2986A27	332-2986A25	142	REC3721001	37721	327
REC300-8M0077471	339-879984T01	118	REC332-2986A27	332-2986A27	147-148	REC378252	31-67445	267
REC300-8M0077471	339-8M0077471	118	REC332-4911A8	332-4911A2-3-5-8	141	REC382343	31-54928-1	335
REC300-8M0077471		119-120	REC332-4911A8	338-4733A2	141	REC3852045	25-62704	317
REC300-8M0088059	300-8M0088059	146	REC332-4911A8		147	REC3852866	25-31986	327
REC301877	25-85594	295-301	REC334-65021-1	803748	297	REC3852928	25-26855	301
REC302588	25-26722	327	REC334-65021-1	8M0135803	298	REC387247	30-30956	337
REC303347	25-26802	317	REC3355523	25-88955	263-265	REC387247	31-30956T	305
REC308627	25-20826	263	REC339-6120A1	339-5212A1	144	REC387247	31-30956T	335
REC309-01005-2	27-95299001	254	REC339-6120A1	339-5313A1	144	REC387247	42647A1	309
REC309731	25-29439	317	REC339-6120A1	339-5589A1	144	REC387817	31-42647A1	307-335-337
REC31-12576	31-12576	305	REC339-6120A1	339-5590A1	144	REC39-16054A5	39-16054A5	248-271
REC31-12578T	31-12578T	305	REC339-6120A1	339-6119A1	144	REC39-18653A12	39-18653A12	271
REC31-16052	31-16052	267	REC339-6120A1	339-6120A1	144	REC39-18653A12	39-18653A12	268
REC31-16052	31-16052	244-248	REC339-6120A1	339-6120A1	147	REC39-19721A6	39-19721A6	268-271
REC31-16052		271	REC339-6222A10	332-5524A1-2	140	REC39-803678A1	39-803678A1	271
REC31-16756A4	31-16756A4	265-267	REC339-6222A10	339-5287	140	REC39-803678A1	8M0080357	248
REC31-16756A6	31-16756A6	263-271	REC339-6222A10	339-6222A1-4-6-8-10	140	REC39-803678A3	39-803678A3	244-271
REC31-17514A2	17514A1	249	REC339-6222A10	339-778A1-3-5-6-9-12	140	REC39-813011A12	39-813011A12	269-270-272
REC31-17514A2	31-17514A1, A2	267	REC339-6222A10		147	REC39-817096A6	39-817096A6	269-271-272
REC31-17514A2	8M0045428	267	REC339-7452A19	339-7452A1, A2, A3, A7, A8, A9, A10, A11, A14, A15, A21	141-147	REC39-821695A4	39-821695A4	268-271
REC31-17514A2		266-271	REC339-825101T	339-825101T	118	REC39-822321A2	39-822321A12	269
REC31-21700	31-21700	301-303-327	REC339-825101T	339-825101T	117-119-120	REC39-822321A2	39-822321A2	269
REC31-21739	31-21739	295-303-327	REC339-877807A2	339-877807A2	118	REC39-822321A2	822321A 2	253
REC31-30894A1	31-30894A1	305-335-337-339-340-341	REC339-877807A2	339-877807A2	120	REC39-822321A2		271
REC31-30895T	31-30895	305	REC339-880615T01	339-880615T01	118	REC39-831255A6	831255A 6	249
REC31-30895T	31-30895T	335-337	REC339-880615T01	880615T01	226-231	REC39-8M0055809	39-8M0055809	207-242
REC31-32898T	31-32898T	335	REC339-880615T01	880615T014	229	REC39-8M0055809	898103A47	203
REC31-35928T1	31-35928A1/T1	337-340-341	REC339-880615T01	880615T014	229	REC39-93481A12	39-93481A12	270-272
REC31-36387A1	31-36387A1	335	REC339-880615T01	880615T014	120	REC394-1100A3	394-1100A3	154
REC31-36387A1	31-36387A1	337	REC339-8M0077473	339-883778A01	118	REC394-1130A1	394-1130A1	154
REC31-36387A1	8M0146566	309	REC339-8M0077473	339-883778A02	118	REC39580		179
REC31-38356A1	31-38356A1	327-339-341	REC345-00042-0	345-00042-0	248-249-271	REC398-173	398-173	118
REC31-41326	31-41326	295-301	REC345-65021-0	161541	172-299	REC398-174	398-174	154
REC31-42677A1	31-42677A1	305	REC346-01005-0	27-8129391	254	REC398-2202	398-2202	154
REC31-43012A1	31-43012A1,A2	267	REC35-18458Q4	35-18458Q4	74	REC398-5255	398-4770	145
REC31-43012A1	43012A 1	252	REC35-802893Q		74	REC398-5255	398-5255	145
REC31-43012A1	43012A 1	253	REC35-802893Q01		74	REC398-5255	398-5256	145
REC31-43012A1		266-271	REC35-80365M	35-80365M	77	REC398-5454A17	398-5454A2, A5, A6, A7, A8, A9, A17, A18, A55	144-148-149
REC31-43013T3	31-43012T3	267	REC35-822626Q03	35-822626Q03	80	REC398-5454A26	398-5454A26	145
REC31-43013T3	43013T 3	252	REC35-822626Q03	35-822626Q01	80	REC398-5454A35	398-5454A11, A15, A16, A30, A31, A32, A34, A35, A36, A61, A64, A66	144-148
REC31-43013T3	43013T 3	253	REC35-822626Q03	822626K03	213	REC398-5454A47	398-5454A7	146
REC31-43013T3		264-265	REC35-822626Q03		68-69-80-81	REC398-5454A7	398-5454A7	146
REC31-53079A1	31-63079A1	335	REC35-822626Q04	35-822626Q0480	80	REC398-5704A7	398-5704A2, A4, A5, A7	145
REC31-62091T	31-6291T	327	REC35-822626Q04	35-822626Q04	80	REC398-5704A7		147-148
REC31-62596A1	31-62596A1	266-267-271	REC35-822626Q04	822626K04	225	REC398-693	398-693	154
REC31-66668A1	31-99328A1	295-301-339	REC35-822626Q04	822626Q04	225	REC398-832074A4	398-818535A17-18	145
REC31-74248T	31-74248T	265-267	REC35-822626Q04	8M0065103	80	REC398-832074A4	398-9873A9-17-19-24-25-28-29-32-33-35-38-39	145
REC31-77420A1	31-77420A1	303-327	REC35-822626Q04	8M0065104	223	REC398-832074A4	F747095	145
REC31-77420A1	8M0146553	309	REC35-822626Q04		69-80-81-82	REC398-832074A4		145
REC31-78172A1	31-78172A1	335	REC35-822626Q15	35-822626Q15	80	REC398-832074A4		145
REC31-78172A1		340-341	REC35-822626Q15	35-822626T7	80	REC398-832074A4		145
REC31-8036752	31-803675 2	267	REC35-822626Q15	822626T7	233	REC398-832074A4		145
REC31-8036752	31-8036752	244	REC35-822626Q15		80-82	REC398-832074A4		

REF	R.O. / OEM	REF	R.O. / OEM	REF	R.O. / OEM		
REC398-832074A4	398-9710A11-12-14-15-22-23-25-28-30-31-33-34-36-38-39-43-45-46-47-48-49	REC44-12238T	44-12238T	305-344	REC47-89980	47-89980	171-192-317
REC398-832074A4		REC44-195133	44-195133	289	REC47-89980T1	47-89980T1	184-192-317
REC398-832075A20	398-832075A20	REC44-824110	44-824110	337-344	REC47-89981	47-89981	171-192-317
REC398-852386T8	398-852386A4	REC44-850308	44-850308	305-344	REC47-89981Q1	47-89981Q1	317
REC398-852386T8	398-852386T8	REC44-94148	44-94148	335-344	REC47-89981Q1	47-89981T2	184
REC398-852387T9	398-852387A4	REC45-161351	45-16135 1	289	REC47-89982	47-89982	171-193
REC398-852387T9	398-852387T9	REC45-816919	45-816472	344	REC47-89982T1	47-89982T1	185-193
REC398-852387T9	398-852387T9	REC45-854808A1	45-854808A1	305	REC47-89983Q1	47-89983Q1	327
REC398-852387T9	398-852387T9	REC45-858765T1	45-858765T1	305	REC47-89983Q1	47-89983T2	186
REC398-852387T9	398-852387T9	REC45-859105A1	45-859105A1	305	REC47-89983Q1	47-89983T2	186
REC398-852387T9	398-852387T9	REC45-875222A1	45-875222A1	305	REC47-89983T	47-89983T	171
REC398-852387T9	398-852387T9	REC45-878575T1	45-878575T1	305	REC47-89983T	47-89983T	327
REC398-855721T8	398-855721A4	REC45-8M0076368	45-16136 1	289	REC47-89984Q5	47-89984Q5	334
REC398-855721T8	398-855721T8	REC46-42040T5	46-42040A5	184	REC47-89984Q5	47-89984T6	187
REC398-855721T8	398-855721T8	REC46-42040T5	46-42040T5	293	REC47-89984T4	47-89984T4	171
REC398-8778A29	398-818535A3-5-8-9-10-13-14-15	REC46-42040T5	46-42040T5	191-192-193	REC47-89984T4	47-89984T4	335
REC398-8778A29	398-8778A10-16-17-18-21-22-23-24-25-26-27-28-29	REC46-42089A2	46-42089A2	179-191-192-193-293	REC47-89984T4	47-89984T4	194-195-196
REC398-8778A29	F749095	REC46-42089A5	46-42089A5	184-191-192-193-293	REC47-89984T4	47-89984T4	194-195-196
REC398-8778A29		REC46-60366T1	46-60366Q1	186	REC47-89984T4	47-89984T4	335
REC398-878143T05	398-878143T05	REC46-60366T1	46-60366T1	186	REC47-89984T4	47-89984T4	335
REC398-878143T05	398-878143T3	REC46-60366T1	46-60366T1	193-194	REC47-89984T4	47-89984T4	335
REC398-878143T05	398-878143T3	REC46-70941A3	46-70941A3	184-192-317	REC47-89984T4	47-89984T4	335
REC398-9610A18	398-9610A18	REC46-70941A3	46-70941A3	178-192-317	REC47-89984T4	47-89984T4	335
REC398-9610A19	398-9610A3-A5-A6-A9-A14-A19-A22-A24-A33	REC46-70941T01	46-70941A1	178-192-317	REC47-89984T4	47-89984T4	335
REC398-9610A19		REC46-73640A1	46-73640A1	179-193-194	REC47-89984T4	47-89984T4	335
REC3B2-01005-0	27-803663021	REC46-73640A2	46-73640A2	187-193-194	REC47-89984T4	47-89984T4	335
REC3C8-01005-4	27-81293910	REC46-77177A1	46-77177A1	178-193-194-327	REC47-89984T4	47-89984T4	335
REC3C8-01005-4	27-8M0062091	REC46-77177A3	46-77177A3	186-193-194-327	REC47-89984T4	47-89984T4	335
REC3F0-65029-0	898101332	REC46-77822A1	46-77822A1	179-193-194-327	REC47-89984T4	47-89984T4	335
REC3G2-06040-2	160643	REC46-812966A12	46-812966A12	186-302	REC47-89984T4	47-89984T4	335
REC3G2-06060-2	803706A3	REC46-812966A12	46-812966A12	186-302	REC47-89984T4	47-89984T4	335
REC3G2-06060-2	8M0047313	REC46-812966A12	46-812966A12	188-189-191-193-194	REC47-89984T4	47-89984T4	335
REC3G2-06060-2	8M0071855	REC46-812966A12	46-812966A12	178-191-194-303	REC47-89984T4	47-89984T4	335
REC3V1-87121-0	27-835427A04	REC46-821307A2	46-821307A2	178-191-193-194-301	REC47-89984T4	47-89984T4	335
REC40135		REC46-8M0061040	46-8M0061040	69-187-189	REC47-89984T4	47-89984T4	335
REC40145	35-816296Q03	REC46-8M0071747	46-42579A3	178-195-196-335	REC47-89984T4	47-89984T4	335
REC40155	35-816296Q2	REC46-96146A6	46-96146A6	178-193-196	REC47-89984T4	47-89984T4	335
REC40165		REC46-96148A8	46-60367A1	188	REC47-89984T4	47-89984T4	335
REC40470	1395-9262-1	REC46-96148A8	46-96148A8	187-188-334	REC47-89984T4	47-89984T4	335
REC40480	1395-5109-1	REC46-96148A8	46-96148A8	194-195-196	REC47-89984T4	47-89984T4	335
REC40970		REC46-96148T1	46-96148T1	180-194-195-196	REC47-89984T4	47-89984T4	335
REC40990		REC46-99157A02	46-99157A02	179-295	REC47-89984T4	47-89984T4	335
REC41-16056	41-16041	REC46-99157T2	46-99157T2	185-191-193-295	REC47-89984T4	47-89984T4	335
REC41-16056	41-80368003	REC46895	46895	180-192-317	REC47-89984T4	47-89984T4	335
REC41-803680002	41-803680002	REC47-161543	47-161543	287	REC47-89984T4	47-89984T4	335
REC41-803680003	41-803680003	REC47-161543	47-16154 3	289	REC47-89984T4	47-89984T4	335
REC41-8036801	41-8036801	REC47-161543	47-161543	187-172-193-194	REC47-89984T4	47-89984T4	335
REC41-825713002	41-825713002	REC47-19453Q2	47-19453Q2	68-172-187-193-194	REC47-89984T4	47-89984T4	335
REC41106-ZW9-000		REC47-19453T	47-19453T	69-172-173-191-193-194	REC47-89984T4	47-89984T4	335
REC41106-ZW9-000AL	8M0137344	REC47-20813	47-20813	303	REC47-89984T4	47-89984T4	335
REC41106-ZW9-000AL		REC47-22748	47-22748	171-192-196	REC47-89984T4	47-89984T4	335
REC414172	27-41417-2	REC47-22748	47-22748	171-192-196	REC47-89984T4	47-89984T4	335
REC414181	27-41418-1	REC47-420382	47-42038-2	68-172-191-192-193-293	REC47-89984T4	47-89984T4	335
REC414758	27-41475-8	REC47-42038Q3	47-42038Q3	293	REC47-89984T4	47-89984T4	335
REC414991	27-414991	REC47-42038Q3	47-42038Q3	184	REC47-89984T4	47-89984T4	335
REC42039	42039	REC47-42038T4	47-42038T4	191-192-193	REC47-89984T4	47-89984T4	335
REC421-B25F	1623-888680T06	REC47-42038Q3	47-42038Q3	191-192-193	REC47-89984T4	47-89984T4	335
REC421-B30F	1623-888680T07	REC47-42038Q3	47-42038Q3	191-192-193	REC47-89984T4	47-89984T4	335
REC42121Q02AL		REC47-42038Q3	47-42038Q3	191-192-193	REC47-89984T4	47-89984T4	335
REC42200	42200	REC47-42038Q3	47-42038Q3	191-192-193	REC47-89984T4	47-89984T4	335
REC42375	42375	REC47-42038Q3	47-42038Q3	191-192-193	REC47-89984T4	47-89984T4	335
REC42461A1	42461A1	REC47-42038Q3	47-42038Q3	191-192-193	REC47-89984T4	47-89984T4	335
REC42600A09	42600A1/3/5/09	REC47-42038Q3	47-42038Q3	191-192-193	REC47-89984T4	47-89984T4	335
REC428-B25F	1623-888680T08	REC47-42038Q3	47-42038Q3	191-192-193	REC47-89984T4	47-89984T4	335
REC428-B30F	1623-888680T09	REC47-42038Q3	47-42038Q3	191-192-193	REC47-89984T4	47-89984T4	335
REC42909A3	42909A3	REC47-42038Q3	47-42038Q3	191-192-193	REC47-89984T4	47-89984T4	335
REC42943A1	42943A 1	REC47-42038Q3	47-42038Q3	191-192-193	REC47-89984T4	47-89984T4	335
REC42943A1	42943A1	REC47-42038Q3	47-42038Q3	191-192-193	REC47-89984T4	47-89984T4	335
REC43-16138	16138	REC47-42038Q3	47-42038Q3	191-192-193	REC47-89984T4	47-89984T4	335
REC43-16138	43-16138	REC47-42038Q3	47-42038Q3	191-192-193	REC47-89984T4	47-89984T4	335
REC43-44104T2	43-44104T2	REC47-42038Q3	47-42038Q3	191-192-193	REC47-89984T4	47-89984T4	335
REC43-803498T1	43-803498T1	REC47-42038Q3	47-42038Q3	191-192-193	REC47-89984T4	47-89984T4	335
REC43-803499T1	43-803499T1	REC47-42038Q3	47-42038Q3	191-192-193	REC47-89984T4	47-89984T4	335
REC43-803739T03	803739T02	REC47-42038Q3	47-42038Q3	191-192-193	REC47-89984T4	47-89984T4	335
REC43-803740T02	803740T02	REC47-42038Q3	47-42038Q3	191-192-193	REC47-89984T4	47-89984T4	335
REC43-803741T03	803741T02	REC47-42038Q3	47-42038Q3	191-192-193	REC47-89984T4	47-89984T4	335
REC43-812944	812944	REC47-42038Q3	47-42038Q3	191-192-193	REC47-89984T4	47-89984T4	335
REC43-8129451	812945 1	REC47-42038Q3	47-42038Q3	191-192-193	REC47-89984T4	47-89984T4	335
REC43-822163T1	43-822163T1	REC47-42038Q3	47-42038Q3	191-192-193	REC47-89984T4	47-89984T4	335
REC43-822163T1	43-822163T1	REC47-42038Q3	47-42038Q3	191-192-193	REC47-89984T4	47-89984T4	335
REC43-822163T1	43-822163T1	REC47-42038Q3	47-42038Q3	191-192-193	REC47-89984T4	47-89984T4	335
REC43-828073A1	43-828073A1	REC47-42038Q3	47-42038Q3	191-192-193	REC47-89984T4	47-89984T4	335
REC43-859321A3	43-859321A3	REC47-42038Q3	47-42038Q3	191-192-193	REC47-89984T4	47-89984T4	335
REC43-878087A2	43-878087A2	REC47-42038Q3	47-42038Q3	191-192-193	REC47-89984T4	47-89984T4	335
REC43023	43023	REC47-42038Q3	47-42038Q3	191-192-193	REC47-89984T4	47-89984T4	335
REC43023-2	43023-2	REC47-42038Q3	47-42038Q3	191-192-193	REC47-89984T4	47-89984T4	335
REC43046	43046	REC47-42038Q3	47-42038Q3	191-192-193	REC47-89984T4	47-89984T4	335
REC43055A4	43055A4	REC47-42038Q3	47-42038Q3	191-192-193	REC47-89984T4	47-89984T4	335
REC43242-3	43242-3	REC47-42038Q3	47-42038Q3	191-192-193	REC47-89984T4	47-89984T4	335
REC43242-5	86210	REC47-42038Q3	47-42038Q3	191-192-193	REC47-89984T4	47-89984T4	335
REC43242-5	43242-5	REC47-42038Q3	47-42038Q3	191-192-193	REC47-89984T4	47-89984T4	335
REC43242-6	43242-6	REC47-42038Q3	47-42038Q3	191-192-193	REC47-89984T4	47-89984T4	335
REC43242-9	43242-9	REC47-42038Q3	47-42038Q3	191-192-193	REC47-89984T4	47-89984T4	335
REC44-12238T	44-12238T	REC47-803630					

REF	R.O. / OEM		REF	R.O. / OEM		REF	R.O. / OEM	
REC626-44365-01	26-80239M	323-325	REC664-45384-00	11-81619M	325	REC682-12414-A1	27-83940M	167
REC626-45316-09	23-82590M	323	REC664-45631-00	52-81644T	342	REC682-41114-00	27-83951M	169
REC629-803674	629-803674	248-270-271	REC664-45631-01	52-81644M	325	REC682-41133-A0	27-83955M	274
REC629-8036741	629-8036741	244-270-271	REC664-45987-00	12-81650M	325	REC682-44147-00	84019M	323
REC629-813047T01	629-813047T01	248-270-271	REC666K-13915-00	808504	79	REC682-44176-00	84020M	323
REC629-880855	629-880855	249-270	REC666K-13915-00	808504T1	79	REC682-44312-00	84023M	323
REC638-9002A6	838-9002A6	252-270	REC666M-46241-00	835392	211-272	REC682-44315-00	27-84024M	323
REC63P-13907-03	88089T01	85	REC666M-46241-00	57-835392Q	272	REC682-44322-00	84025M	181
REC63P-13907-03	880889T	85	REC666M-W0001-01	27-835427A00	208-235-237	REC682-44322-00	84025M	323
REC63P-45501-00	888696	313	REC666M-W0093-01	802706A1	92-101-103	REC682-44323-40	84026M	181
REC63P-45501-10	8886961	313	REC666N-11603-00	23-84445M	209-242	REC682-44323-40	842121M	323
REC63P-81950-00	881356001	132	REC666N-11603-00	17-92639M	329-333	REC682-44328-00	94624M	323
REC63P-81950-00	888320T	132	REC666T-45997-00	23-84445M	107	REC682-44352-01	47-84027T	171
REC63P-81950-00		135	REC667-14186-00	22-83369M	105	REC682-44352-01	47-84027T	323
REC640-9612A7	9612A 6	249-270-271	REC667-14966-00	891730A01	106	REC682-44352-01	32-84028M	323
REC644-818141A2		271	REC667-14966-01	27-83338M	170	REC682-44361-01	32-84029M	323
REC646-14623-A1	27-43004-1	277	REC667-41112-A0	27-83383M	275	REC682-44365-00	26-84022M	345
REC646-44322-00	80393M	315	REC667-41133-A0	46-83396M	331	REC682-44365-00	84022M	323
REC646-44322-00	80394M	315	REC667-44311-00	27-83398M	331	REC682-45113-A0	27-96618	277
REC646-44352-01	47-80395M	171-196-315	REC667-44315-00	83403M	331	REC682-45113-A0	94622M	323
REC646-44365-00	26-80397M	315	REC667-44322-00	83400M	331	REC682-45376-01	52-84274M	342
REC646-44366-01	26-80398M	315	REC667-44324-A0	27-83399M	331	REC682-45631-00	84274M	323
REC646-45551-00	43-80405M	315	REC667-44361-00	32-83451M	331	REC682-45631-00	46-84277M	185
REC646-45560-00	43-80406M	315	REC667-44361-01	32-83452M	331	REC682-W0078-A1	46-84277T	185
REC646-818845T6	646-818846	271	REC667-45114-A1	27-19175	277	REC682-W0078-A1	46-84277T	196
REC646-818845T6	646-8188461	271	REC667-45127-00	83384M	275	REC682-W0078-A1	46-84277T	322
REC646-818845T6	818846T 6	252-253	REC667-45128-00	83386M	275	REC683-44362-01	32-94625M	323
REC646-818845T6		270-271	REC667-45251-00		199	REC683-44365-01	26-94626M	323
REC647-11610-00	39-80422M	247	REC667-45251-00AL		199	REC683-44373-00	84072M	323
REC647-11610-10	39-80423M	247	REC667-45635-00	83419M	329	REC683-45315-A0	27-84075	323
REC647-11610-20	39-80424M	247	REC667-11181-A0	27-95595M	247-254	REC683-45361-01-4D	84076T	323
REC647-14323-00	10-80573M	105	REC667-11412-02		247	REC683-45611-00	44-84078M	323
REC647-14385-00	80450M	105	REC667-11422-02	761-8224M	247	REC683-W0001-21	27-99049M	322
REC647-14386-10	17-80451M	107	REC667-11432-02	761-8225M	247	REC688-14548-00	17-97730M	107
REC647-44366-00	26-80532M	320-321	REC667-11442-02	761-8226M	247	REC688-45123-00	27-81440M	275
REC647-45316-09	23-80536M	321	REC667-11631-00K	761-8226M	247	REC688-45214-02	97091M	329
REC647-45551-00	43-82542M	321	REC667-11635-00K	761-8226M	247	REC688-45215-02	19167M	329
REC647-45560-00	43-80542M	321	REC667-11636-00K	761-8226M	247	REC688-45341-00	22-95632M	333
REC647-45570-00	43-80544M	321	REC667-14343-68	95495M	104	REC688-45341-00	95632M	311
REC647-45616-02	859931	319	REC667-24411-02	84262M	89	REC688-45635-00	81476M	333
REC647-822373A09		271	REC667-24435-01	27-84264M	89	REC688-45997-00	8539481	311
REC648-14385-00	80591M	106	REC667-24471-01	84265M	89	REC688-82575-01	87-97682M	150
REC648-24411-00	80606M	89	REC667-26301-02	95405M	107	REC688-11181-00	27-19138M	254
REC648-24434-01	27-80613M	90	REC667-41112-A0	27-95597M	247	REC689-11610-00	39-14235M	271
REC648-24435-02	27-80614M	90	REC667-45113-A0		247	REC689-11631-00K	761-8484M	271
REC648-45633-00	53-80678M	325	REC677-W0093-00	84473M	101-104-247	REC689-11651-00		271
REC648-45633-00	80678M	323	REC679-44150-00	83882M	331	REC689-41112-A0	27-96656M	170
REC648-45635-00	80680M	325	REC679-44150-10	83881M	331	REC689-41114-A0	27-84741M	170
REC648771	64877-1	168	REC679-44152-00	83883M	331	REC689-44311-00	46-95651M	325
REC650-11370-00	21-80727M	243-247-251	REC679-44316-A0	27-83865M	331	REC689-44315-A0	25-84054M	325
REC650-24351-51		72	REC679-44341-00	46-83864M	331	REC689-44316-A0	27-95656M	325
REC650-44147-00	82881M	331	REC679-45315-A1	27-95418M	329	REC689-44324-A0	27-41273M	325
REC650-45635-00	80923M	323	REC679-45321-02	95417M	329	REC689-44352-02	47-84797M	171
REC655-12414-A1	27-81031M	166	REC679-45331-00	83880M	329	REC689-44352-02	47-84797M	325
REC65848	65848	169	REC679-45331-00	45-83867M	331	REC689-44352-02		196
REC65L-24563-00	35-888289T2	77-82	REC679-45501-10	83868M	331	REC689-44366-00	26-84818M	325
REC65W-46241-00	831294	217-272	REC679-45536-00	43-83877M	329	REC689-45501-10	45-84801M	325
REC65W-46241-00	57-8M0065179	272-273	REC679-45560-00	43-83879M	329	REC689-45551-00	43-84806M	325
REC65W-46241-00	57-831294	221	REC679-45571-00	44-94531M	329	REC689-45560-00	43-84808M	325
REC65W-82575-01	87-97757M	150	REC679-45611-00	44-94531M	329	REC689-45571-00-00	43-84810M	325
REC65W-W0001-00	27-830270A98	214-235-237	REC679-W0078-A1	83463T	186	REC689-45611-00	44-19124M	325
REC662-44352-01	47-95611M	321	REC67C-11181-01	83477T	219	REC689-45997-00	84823M	325
REC663-11193-00	27-81254M	262	REC67C-11181-01	27-8M0118180	234	REC689-W0001-C2	27-41899M	325
REC663-11634-00	53-81264M	251-271	REC67C-11181-01		237-239	REC689-W0078-A6	42431M	185
REC663-12416-00	27-81266M	167	REC67C-11181-01		219-223-237	REC689-W0078-A6	95661T	185
REC663-12416-00		251	REC67C-11351-00	892319001	237	REC689-W0078-A6		196-325
REC663-14548-00	17-81278M	107	REC67C-11351-00	27-859352	237-238-239	REC689-W0093-02	84456M	101-104
REC663-24411-00	84141M	89	REC67C-11356-00	25-854341	238	REC689-W4432-01	95652M	196-325
REC663-41114-00	27-81331M	170	REC67C-11603-00	39-893525A01	242	REC68F-83688-00	880885001	109-113-114
REC663-44144-01	81408M	333	REC67C-11603-00	893525A01	221-223	REC68V-11325-01AL		225
REC663-44151-00	81409M	333	REC67C-11603-00		217	REC68V-11351-00	8587321	225
REC663-44311-02	46-81416M	333	REC67C-41114-00	834775005	219	REC68V-11351-00	27-8587321	237
REC663-44311-02	46-81422M	333	REC67C-W0001-01	27-859352A02	219-235-237	REC68V-11351-00		238-239
REC663-44315-A0	27-81417M	333	REC67F-11181-03	8041151	225	REC68V-12111-00	804128T	225
REC663-44316-A0	27-81418M	333	REC67F-11181-03	27-8041151	234	REC68V-13915-00	35-881323T	79-88
REC663-44322-00	81419M	181-196-333	REC67F-11181-03		238-239	REC68V-14984-00	27-881325	87-88-97
REC663-44323-00	81420M	181-333	REC67F-11328-00	804086	225-233	REC68V-24410-00	880890A02	84
REC663-44324-00	27-81421M	333	REC67F-11416-00	804101T	225	REC68V-24410-00	880890T1	84
REC663-44366-00	26-81426M	331-333	REC67F-11416-20	804101T20	225	REC68V-24410-00	8M0091468	84
REC663-44366-00	81426M	313	REC67F-12411-01	8556761	225	REC68V-24410-00		85
REC663-45123-00	27-81440M	275	REC67F-12411-01	8556761	233	REC68V-24563-00	881540	77-81-82
REC663-45331-00-94	81446M	333	REC67F-12411-01	8M0117413	163	REC68V-81950-00	881350T	134-135
REC663-45375-00	81448M	331	REC67F-12411-01		164-165	REC68V-82380-00	880885T	110-114
REC663-45376-00	81449M	331	REC67F-12411-01		225-273	REC68V-85885-00	880884T	109-114
REC663-45510-01	45-81451M	333	REC67F-12411-01	804076	225	REC68V-8A360-00	880887T1	98-99
REC663-45552-00	12-81455M	329-333	REC67F-42411-A2	804145	225-273	REC692-24410-00	43113M	84
REC663-45576-00	12-81461M	329	REC67F-46241-00	804278T	138	REC692-24410-00	43113T	84
REC663-45631-00	52-81473M	329-333	REC67F-81960-12	804278T1	138	REC695-85540-11	430775M	141
REC663-45633-00	52-81473M	329	REC67F-81960-12	804278T11	138	REC696-45113-00	27-16717M	259
REC663-45633-00	81474M	333	REC67F-81960-12	804278T11	138	REC696-85540-12	41305M	140
REC663-45634-00	81475M	329-333	REC67F-85570-00	339-804271T	118	REC696-W0093-00	84419M	102-104
REC663-45987-00	73345	333	REC67F-W0001-00	27-804345A02	225	REC697-45114-00	7-98952M	277
REC663-45987-00	12-81477M	329	REC67F-W0001-00	27-804345A02	236	REC697-45384-00	11-81450M	329
REC663-85540-15	3030T/M	142	REC67F-W0001-00	27-858732T01	236	REC697-45384-00	11-81450M	333
REC663-W0078-01	84188T	187-196-332	REC67F-W0001-00	27-858732T02	236	REC697-45551-00	43-84208M	333
REC664-41114-A0	27-81570M	170	REC67F-W0093-00	804346T01	103	REC697-45560-00	43-84206M	333
REC664-41134-A0	27-826991M	275	REC67F-W0093-00	804346T02	103-225	REC697-45570-00	43-84207M	333
REC664-44338-00	28-81603M	325	REC67F-W0093-00	804346T1	103	REC697-45611-00	44-81472M	333
			REC67H-13907-00	808505T01	94-103	REC697-85570-00	97077M	118
			REC67H-13907-00	809088T01	86	REC698-W0001-21	27-92648M	332
			REC67H-13907-00	809088T1	86			2

REF	R.O. / OEM	REF	R.O. / OEM	REF	R.O. / OEM			
REC69J-11351-11	887810010	233	REC6E9-12414-A1	165	REC6P2-41122-00	887861	233	
REC69J-11351-11	27-887810011	237	REC6E9-41114-A0	170	REC6P2-41122-00	887861001	233	
REC69J-11351-11		238-240	REC6E9-W0093-02	17068M	102-104	REC6P2-W0001-01	27-887810A04	233-236-238
REC69J-12119-00	887870	233	REC6E9-W0093-03	97667M	102-104	REC6R3-85570-01	339-898103T	117-119
REC69J-13761-00	888212	98-99	REC6F5-11181-A2	27-11745M	251	REC705-850026T1K	705-850026A3	268
REC69J-13906-00	888227	97	REC6F5-11412-11	851997M	251	REC705-850026T1K	850026T 1	249
REC69J-13907-03	888246T	86	REC6F5-11422-11	827142M	251	REC705-850026T1K		270
REC69J-13907-03	888246T01	86	REC6F5-11432-11	827143M	251	REC705-850026T3	705-850026A3	271
REC69J-13907-03		88	REC6F5-11442-11	827144M	251	REC70720		76
REC69J-15451-00	887825	233	REC6F5-11515-00	13301M	251	REC70977T	70977	181-192-317
REC69J-24410-02	888251T	86	REC6F5-11610-00	39-11768T	251	REC8M0142688		114-115-301-303-327-344-352
REC69J-24410-02	888251T02	86	REC6F5-11610-10	39-11769M	251	REC73345A1	73345A1	164-166-164-166-164-166-303-305-327
REC69J-24410-02		88	REC6F5-11610-20	39-11770T	251	REC75692A6	75692A6	164-166
REC69J-24501-10	35-888279	78-82	REC6F5-11633-00	41-11771T	251	REC75692A7	75692A7	164-166
REC69J-24502-00	35-888279001	78-81	REC6F5-11651-00	629-9486T	251	REC75692Q2	75692Q2	164-166
REC69J-41134-A0	27-888658	277	REC6F5-11681-00	17-13302T	251	REC76039-4	76039-4	303-305-327
REC69J-41138-00	26-888660	277	REC6F5-12411-03	75692	162-251	REC76214Q5		199
REC69J-45361-00-8D	888708	311	REC6F5-12411-03	814554T01	162-251	REC76214Q5AL		69-70-199
REC69J-45375-00	8886653	311	REC6F5-12411-03		164	REC765-7441T32	765-7441T32	268-270
REC69J-45611-00	888699	311	REC6F5-15396-01-5B	815118M	251	REC765-7441T36	765-7441T36	268-270
REC69J-45631-00	888702	311	REC6F5-41111-01-1S	11753M	251	REC765-7442T32	765-7442T32	268-270
REC69J-46241-00	887883	233	REC6F5-41112-A0	27-11754	251	REC765-7442T36	765-7442T36	268-270
REC69J-46241-00		273	REC6F5-41113-A0-1S	11755M	251	REC765-7445A12	765-7445A12	268-270
REC69J-81960-13	888315A1	139	REC6F5-41114-A0	27-11756	251	REC765-7445T11	765-7445T11	268-270
REC69J-81960-13	8M0057158	139	REC6F5-44352-00	47-99971M	171-331	REC765-7446A11	765-7446A11	268-270
REC69J-85885-00	888204T	109-114	REC6F5-45113-A0	27-11885	251-258	REC765-7446T12	765-7446T12	268-270
REC69J-W0001-20-00	27-888658A04	175-190-313	REC6F5-85540-22	11737T	141	REC766-8666741	766-8666741	269-270
REC69K-45611-00	88869910	311	REC6F6-11111-00-1S	968-9325M	251	REC774-9137A11	774-9137A11	269
REC6A0-14325-00	10-41889M	105	REC6F6-11191-00-1S	11747M	251	REC774-9137A11	774-9137A11	252
REC6A0-82550-01	87-93102M	150	REC6F6-11193-A1	27-114749M	251	REC777-815965A4	777-815965A4	269-270-271
REC6A1-44361-00	32-80396M	315	REC6F6-11400-02	463-9327M	251	REC777-9009A7	777-9009A7	269-271
REC6A1-W0001-23	27-813500M	315	REC6F6-11631-00K	761-9329T	251	REC777-9009T13	774-9009A13	252-269-270-271
REC6A1-W0078-01	814453M	184	REC6F6-11635-00K		251	REC779-803677	779-803677	248-270-271
REC6A1-W0078-01	81445M	315	REC6F6-11636-00K	761-9331T	251	REC779-803677T02	779-803677002	248-270-271
REC6A1-W0093-01	92520M	100-104	REC6F6-W0093-00	11810M	102	REC779-804886	779-804886	244-270-271
REC6AH-12411-00	825212T02	68-205	REC6F6-W0093-00	11810T	102	REC779-879194T01	779-879194T01	248-270-271
REC6C5-13915-00	35-881323001	78-87-88	REC6G1-11193-A1	27-11454M	169-245	REC779-96152	779-96152	249-270-271
REC6C5-14984-00	27-881325001	97	REC6G1-11610-00	39-11462M	243	REC779-9615T	779-9615T	244-270-271
REC6C5-24251-00	35-892758001	77-81	REC6G1-11633-00	41-95601M	243-247	REC780-9229A7	780-9229A7	268-271
REC6C5-85885-00	880884001	109-113-114	REC6G1-11681-00	17-14193M	243-245-247	REC783-9613A1K	783-9613A1	271
REC6D8-11603-10	804107T1	225	REC6G1-11681-00	17-14193M	247	REC783-9613T1	783-9613T1	268-270-271
REC6D8-11604-10	804108T1	225	REC6G1-14546-00	11490M	104	REC783-9613T3	783-9613T3	268-271
REC6D8-13761-00	880887T02	98-99	REC6G1-14985-00	11489M	105	REC785-9737T9	785-9737T9	269-270
REC6D8-WS24A-00	35-8M0101436	78	REC6G1-24411-00	11499M	89	REC785-9738T9	785-9738T9	269-270
REC6D8-WS24A-00	35-8M0117705	78	REC6G1-24431-01	27-11500M	89	REC803034T	823034T	140-147
REC6D8-WS24A-00		81-82	REC6G1-24471-00	11497M	89	REC803061T1	803061T1	164-166
REC6E0-11193-A1	27-9991M	243	REC6G1-41112-A1	27-11456M	169-245	REC803529T06	803529T06	84
REC6E0-11631-00-98K	761-8256M	243-270	REC6G1-41114-A0	27-11456M	245	REC803529T06	803529T06	84
REC6E0-11651-01	629-9492M	243-247-270	REC6G1-41133-A0	27-11568M	274	REC803529T06	803529T06	84
REC6E0-24411-00	91753M	89	REC6G1-44315-A0	27-11591M	320	REC803529T06	803529T1	84
REC6E0-24434-00	27-91754M	89	REC6G1-44322-00	11589M	320	REC803673	803673	248
REC6E0-24435-00	27-91746M	89	REC6G1-44323-00	11592M	320	REC803702	803702T	116
REC6E0-24471-00	91748M	89	REC6G1-44328-00	11593M	320	REC803704	803704T	140
REC6E0-26301-01	11921M	107	REC6G1-44352-00	47-11590M	171-196-320	REC803751	803751	297-298
REC6E0-41112-A1	27-99995M	169-243	REC6G1-45113-A1	11560M	258	REC803753	803753	180
REC6E0-41114-A1	21-41279M	169	REC6G1-45113-A1	27-11560M	245	REC803753	803753	297
REC6E0-41114-A1	27-99993M	243	REC6G1-45315-A0	27-11574M	320	REC803753	803753	68
REC6E0-41114-A1	99993M	169	REC6G1-45611-01	44-11599M	320	REC803844T01	339-803844T01	116
REC6E0-44322-02	96302M	319	REC6G1-45631-00	52-11597M	320	REC804295T	804295T	110-113-114
REC6E0-44352-00	47-96305M	171-196-319	REC6G1-81970-62	810937M	138	REC807929A1	807929A1	179-196-337
REC6E0-45113-A1	27-91780	243	REC6G1-81970-62	810937T	138	REC809569	809569	92-93-106
REC6E0-45113-A1	27-91780M	258	REC6G1-81970-62	8M0091976	138	REC809570-1	809570-1	93-105
REC6E0-45316-00	23-95476M	319	REC6G1-W0001-C1	11655M	320	REC8107492	810749-2	95-96-103
REC6E0-45317-00	23-95477M	319	REC6G1-W0078-A1	11656M	184-320	REC8107493	810749-3	95-96-103
REC6E0-45511-01	45-96307M	319	REC6G1-W0078-A1	11656T	184	REC812887002	812887-1	168
REC6E0-45511-11	45-96308M	319	REC6G1-W0093-00	11502M	100-104-245	REC812929-1	812929-1	303
REC6E0-45551-00	43-96310M	319	REC6G5-44323-00	888691	199	REC813046002	813046002	244
REC6E0-45560-00	43-96312M	319	REC6G5-45251-02		199	REC8130461	8130461	248
REC6E0-45570-00	43-96316M	319	REC6G5-45251-02AL		199	REC813932	27-813932-2	259
REC6E0-45611-01	44-96314M	319	REC6G5-W0078-A1	888687A1	188-190	REC814080001	814080001	226
REC6E0-45631-00	52-96313M	319	REC6G8-11181-A1	27-8254821	205	REC815113T02	16064	116
REC6E0-W0001-C1	27-96324M	319	REC6G8-11181-A1	27-8254821	234	REC815113T02	16064A1	116
REC6E0-W0078-A2	96325T	319	REC6G8-11181-A1		237	REC815113T02	16064A3	116
REC6E5-12411-02	11919M	162-245	REC6G8-11325-00		199	REC815113T02	815113T02	116
REC6E5-12411-02	83282M	243	REC6G8-11325-00AL		199	REC815279A2	815279A2	139
REC6E5-12411-02		164	REC6G8-11351-A0	27-825847	205-236-237	REC815279A2	12082A1	139
REC6E5-14386-01	17-11794M	107	REC6G8-12414-A0	27-825701	205	REC815279A2	12082A7	139
REC6E5-24351-51		72	REC6G8-13440-00	35-825467A1	80	REC815279A2	12082A8	139
REC6E5-44312-00	888688	313	REC6G8-13440-00	35-825467T02	80	REC81554	858452-1	261
REC6E5-44315-A0	888692	313	REC6G8-13440-00	35-825467T1	80	REC816597A1	816597A1	345
REC6E5-44352-01	888689	173-313	REC6G8-41112-02	27-825693	205	REC817275A08	817275A08	187-189-191
REC6E5-44365-00	8886652	313	REC6G8-W0001-A3	27-825847A95	205-235-237	REC817275A09	817275A09	187
REC6E5-44366-00	8886651	313	REC6G9-85540-29	825667	140	REC817275A09	817275A09	307
REC6E5-45344-00	888695	313	REC6G9-85540-29	825667T	140	REC817275A1	817275A1	180-196-307-309
REC6E5-45631-00	52-96313M	342	REC6H1-45668-00	888704	311			
REC6E7-11181-00	27-18937M	254	REC6H1-W0093-01-00	84475M	102-104			
REC6E7-11631-00K	761-7982M-T	271	REC6H3-14590-00	17050M	104			
REC6E7-14385-00	14180M	105	REC6H3-44352-00	47-81423M	171			
REC6E7-44366-00	26-99031M	323	REC6H3-44352-00	47-82824M	333			
REC6E7-45331-00-CA	8M0057163	323	REC6H3-44352-00	47-97108M	171			
REC6E7-45501-00	45-99032M	323	REC6H3-44352-00		196			
REC6E7-45501-11	45-99033M	323	REC6H4-14985-01	804184	94-106			
REC6E7-45536-00	23-99035M	323	REC6H9-45551-01	43-86869M	243			
REC6E7-45551-00	99041M	322	REC6J1-11610-00	39-14197M	243			
REC6E7-45560-01	43-99043T	323	REC6L5-44352-00		171			
REC6E7-45570-00	43-99044T	323	REC6NO-G5551-00	43-11579M	320			
REC6E7-45987-00	12-815025M	323	REC6NO-G5560-00	43-11595M	320			
REC6E7-85570-19	95188T	116	REC6NO-G5571-00	43-11647M	320			
REC6E7-W0093-01	814481M	101-104	REC6P2-11193-00	887853	233			
REC6E8-14390-12	14216M	104	REC6P2-11194-00	887855	233			
REC6E9-11193-A0	27-97704M	262	REC6P2-11318-00	887805	233			
REC6E9-12413-00-1S	19255M	165-251	REC6P2-41114-00	887862	233			
REC6E9-12414-A1	27-814555M	167	REC6P2-41114-00	887862001	233			
REC6E9-12414-A1	27-97706M	251						

REF	R.O. / OEM		REF	R.O. / OEM		REF	R.O. / OEM
REC817275A2	817275A2	180-191-194-195-305	REC8542561	854256 1	101-103-214-219-109-113-114	REC883202T02	
REC817275A6	817275A6	188-196-336	REC854445	854445	142	REC887825	27-887825 170
REC817275Q05	817275A5	188	REC854512T	834520T	142	REC888590002	888590 153
REC8172761	8172761	309	REC854512T	854512T	142	REC888733T02	888733T02 86
REC8172761	817276-1	181-305-307-337	REC854513T	854513T	143	REC888733T1	888733T1 86
REC8172761		191-194-195-196	REC854513T	855748A2	143	REC89-818864T	89-818864T 134
REC818298Q1		199	REC854513T		148	REC89-825096T01	89-825096T01 133
REC818298Q1AL		69-70-199	REC85552001	85552001	295	REC89-825096T01	89-825096T01 134-135
REC818349T1	818349A1	346	REC855676002	855676002	162-207-213	REC89-96054T	89-96054 133
REC818349T1	818349T1	337	REC855686		74	REC89031A1	89031A1 90-94-95
REC818574	818574	261	REC855713A3	855713A3	140	REC89031A2	89031A2 91-95-96
REC818763A10	818763A11/T11	337	REC855713A3	855713A4	140	REC89031A3	89031A3 90-94-95
REC819113	27-819113	279	REC856542	27-856542-1	280	REC89031A4	89031A4 91-96
REC819114	27-819114	279	REC858498	858498	295-353-354	REC891663001	891663 109
REC8213161	8213161	301	REC858763	858763	71	REC891663001	891663001 113-114-115
REC8213542	821354-2	181-191-193-194-301	REC8597721	859772-1	238	REC892123002	877826 98-99
REC821354A04	821354A04	186-188-301	REC861155A3	861155A2	86	REC892123002	892123001 98-99
REC821354A2	821354A2	185-191-193-194-301	REC861155A3	861155A3	86	REC892123002	892123002 98-99
REC821526001	821526	337	REC8612882-1	8612882-1	167	REC892318	57-892318 137
REC821526001	821526001	307	REC86596T	86596T	167	REC892318	8M0012623 137
REC821889A50	821889A9, A22, A29, A34, A38, A40, A42, A46, A50, A51	149	REC866169T01	866169T01	87-88	REC892320	8M0026410 137
REC8219321	821932-1	293	REC86617A20	86617A2-A3-A5-A9-A11-A13-A17-A20	144-147	REC892320	27-892320 274
REC822157T2		199	REC86976	50-86996T	129	REC892864T04	892864T04 69-70-163-164-165
REC822157T2AL		199	REC86976	50-86976	129	REC892864T06	892864T06 163
REC822158	822158	301	REC87-18211	87-18211	133	REC892864T06	8M0090819 163
REC8235471	823547-1	301	REC87-18286A43	87-18286A43	159	REC893404	893404 199
REC823547A2	823547A2	174	REC87-18286A43	87-18286A26	159	REC893404AL	893404AL 199
REC823547A2	823547A2	301	REC87-18286A43	87-18286A43	159	REC893640T01	854515T2 138
REC823547A2	823547A2	176	REC87-19674A1	87-19674A1	150	REC893640T01	8307272 138
REC823700	27-823700-2	259	REC87-823609A17	87-823609A17	150	REC893640T01	893640T01/T1 138
REC824145	824145	337	REC87-858679T2	87-858679T2	159	REC893857	859770-1 303
REC8245191	8245191	309	REC87-859032T02	87-859032T02	159	REC893929A01	811618 151
REC8245191	824519-1	307-335-337	REC87-897716K01	87-897716	131	REC893929A01	811618A1 151
REC825212T02	855676003	162	REC87-897716K01	87-897716K01	131	REC893929A01	812843A1 151
REC825212T02	825212A1	162	REC87-91941A8	87-91941A8	158	REC893929A01	813442A1 151
REC825212T02	855676A1	162	REC87-91941A8	87-91941A8	158	REC893929A01	813442A2 151
REC825212T02		69-164	REC875208	875208	68-199	REC893929A01	893929A01 151
REC8252711		199	REC875208AL	875208AL	199	REC893929A01	96660A1 151
REC8252711AL		199	REC877805T	877805T	112-113	REC895338	895338 163
REC826134Q		69-70-199-303	REC878265A6	878265A6	151	REC895338	895338 163
REC826134QAL	826134Q	303	REC878265A6	878265A6	151	REC895338	895338 163
REC826549	27-826549	259	REC878408A1	878408A1	153	REC89594A1	89594A1 335
REC826729A10	826729A10/08	152	REC879147T62	879147T62	138	REC896688001	896688001 153
REC826729A10	826729A4	152	REC879147T96	803744T03	297	REC897526T	897526T 112-113-114
REC826729A10	826729A4/07	152	REC880596T55	880596T55	85	REC898101371	898101371 68-287
REC826729A10	99186-1	152	REC880596T55	880596T55	86	REC898101T67	898101T67 85-87
REC826729A10	99186T	152	REC880596T58	880596T58	85-87-88-89	REC899106T01	808505T 84
REC826729A10K	818186A6	153	REC880596T60	880596T60	87-88	REC899106T01	827682T 84
REC826729A10K	826729A07	153	REC881170A11	881170A11	156	REC899106T01	892874T01 84
REC826729A10K	826729A08	153	REC881170A12	881170A12	156	REC899106T01	899106T01 84
REC826729A10K	826729A09	153	REC881170A13	881170A13	157	REC899106T01	899106T01 85
REC826729A10K	826729A4	153	REC881170A14	881170A14	157	REC899883230	899883230 141
REC826729A10K	826729AA 10	153	REC881170A15	881170A15	155	REC899883230	339-7452 A2, A3 141
REC826738	27-826738	275	REC881170A16	881170A16	157	REC899883230	899883230 147
REC827365	827365	169	REC881170A20	16900A15	155	REC8M000822	828553 258
REC827509A10	827509A10,T7	119	REC881170A20	881170A20	157	REC8M0005405	8M0005405 226
REC827675A1	827675A1	151	REC881170A3	16901A15	155	REC8M0005777	12-858234 69-303
REC827955A2	827955A 2	249	REC881170A3	16902A15	155	REC8M0007131	888909A1 178
REC827955A2	827955A2	267	REC881170A7	881170A7	156	REC8M0007131	888909A1 307
REC828507Q4	57-828507Q4	137	REC881170A7	881170A7	156	REC8M0007131	888909A1 191
REC833072003	833072003	70-163	REC881447T	881447T	112-114	REC8M0011987	880609 112-226-229
REC833072004	833072004	70-163	REC881879T11	859210	111	REC8M0011987	8M0011987 112-231
REC84-813706A26	84-813706A26	125	REC881879T11	859210T	111	REC8M0011987	8M0011987 113-114-115
REC84-813706A26	84-99215A26	125	REC881879T11	859604A1	111	REC8M0021043	8M0021043 111
REC84-813715A8		125	REC881879T11	881879A6	111	REC8M0032834	28-56654 335-346
REC84-881908T3	84-881908T	125	REC881879T11	881879T11	111	REC8M0032837	28-56662 346
REC84-881908T4	84-881908T	125	REC881879T11	881879T11	111	REC8M0032837	28-8M0032837 346
REC847525	27-847525-1	280	REC881879T11	881879T11	111	REC8M0036238	8M0036238 347
REC850055001	850055	163	REC881879T11	881879T11	111	REC8M0041571	892811T02 98-99
REC850055001	850055001	163	REC881879T26	881879A19	114-115	REC8M0041571	8M0041571 98-99
REC850055001	850055001	164	REC881879T26	881879A20	111	REC8M0041571	8M0041571 98-99
REC850055A2	850055A2	164-166	REC881879T26	881879T26	111	REC8M0045124	8M0045124 117
REC850307	850307	305	REC882751A04	821509	114-115	REC8M0045124	8M0045124 119
REC850315A1	850315A1	305	REC882751A04	821509T01	133	REC8M0045278	27-857081 234
REC85083	85083	180-191-193-295	REC882751A04	82751A04	133	REC8M0045278	27-8M0045278 234
REC85094	85094	295	REC882751A04	82751A04	134	REC8M0045278	8M0118179 234
REC853762	853762	69-199-299	REC882751A1	828151	135-136	REC8M0046297	8M0046297 178-309
REC853762AL		199	REC882751A1	828151A1	133	REC8M0047624	8558432 86
REC853762T01		68-199	REC882751A1	82751A1	133	REC8M0047324	8M0047324 86
REC853762T01AL		199	REC882751A1	82751A2	133	REC8M0053823	8M0053823 307-309
REC853792T01	853792A1	185	REC882751A1	82751A1	134-135	REC8M0057716	8M0057716 175-189
REC853792T01	853792T01	185	REC883072T	817411	136	REC8M0057748	8M0057748 178
REC853792T01	853792T01	299	REC883072T	815279A1-2-3	139	REC8M0057748	8M0057748 178
REC853792T01		69-188	REC883072T	815279T-2-4-5	139	REC8M0059686	8M0059686 158
REC853811T10	853811T10	138	REC883072T	81579-1-2-3-4-5	139	REC8M0062770	8M0062770 87-88
REC853811T10	898103T14	138	REC883072T	830179-2	139	REC8M0062771	8M0062771 86-88
REC853811T10		139	REC883072T	830179T	139	REC8M0065064	8M0065064 175-190-306
REC853906A1	853906A1	305	REC883072T	854515T1	139	REC8M0065072	8M0065072 188-190-306
REC853908A1	853908A1	305	REC883072T		139	REC8M0067307	885599004 163
REC853960T	853960T	142	REC883072T		139	REC8M0067307	8M0057307 163
REC853960T	855747A1	142	REC883072T		139-147-148-149	REC8M0071855	339-803706A1 116
REC853960T		147	REC883202T02	883202A02	85	REC8M0075245	8M0041426 158
			REC883202T02	883202T02	85	REC8M0075245	8M0075245 158

REF	R.O. / OEM	REF	R.O. / OEM	REF	R.O. / OEM
REC8M0080349	8M0080349	REC90170-16M19	8813141	REC93101-11M23	26-11464M 320
REC8M0080357	8M0080357	REC90171-14013-00	11-81774M	REC93101-13M12	26-96317M 319
REC8M0082988	828358	REC90171-16011	11-81775M	REC93101-14M01	26-82165M 247
REC8M0082988	8283582	REC90171-18M04	887973	REC93101-15074	26-82226M 320-321
REC8M0082988	8283582	REC90179-08M06	99042M	REC93101-17054	26-8540171 323
REC8M0082988	8M0030022	REC90179-09M02	11-84807M	REC93101-18050	26-82228M 321
REC8M0082988	8M0082988	REC90183-02M03	8813142	REC93101-20048	26-82229M 323
REC8M0082988		REC90201-02M00	8043051	REC93101-20M07	26-84813M 325
REC8M0088080	8M0088080	REC90201-12565	12-81816M	REC93101-20M29	26-188843M 243-247
REC8M0088081	8M0088081	REC90201-16M00	88838012	REC93101-20M34	23-81841M 245
REC8M0088940	8M0088940	REC90201-17682	12-94627M	REC93101-22067	26-82233M 325-333
REC8M0088940	8M0142591	REC90201-20417	12-81831M	REC93101-22067	26-83406M 329-331
REC8M0088940	8M0142591	REC90201-22429	12-81837M	REC93101-23070	26-82234M 333
REC8M0091784	898101774	REC90201-22M01	8883632	REC93101-28M16	888694 313
REC8M0091784	8M0091784	REC90201-31M00	8043052	REC93101-30M17	8886941 190-311
REC8M0092849	86352	REC90206-22M19	8556822	REC93101-30M33	26-11758M 251
REC8M0092849	15920A54	REC90209-18112	12-84620M	REC93102-20M25	26-14195M 245-247
REC8M0092849	86352A48	REC90209-27M07	12-13305M	REC93102-35M18	26-11731M 251
REC8M0092849	86352A54	REC90214-48M03	14-81877M	REC93102-38008	804144 225-233
REC8M0092849	8M0092849	REC90250-03M10	17-81896M	REC93102-48009	8040992 225-239
REC8M0092849	8M0092850	REC90250-05010	17-81899M	REC93102-63004	887830 233-240
REC8M0092849	8M0092850	REC90250-05036	17-81901M	REC93103-10052	26-82250M 315
REC8M0092849	821400A2	REC90250-05046	17-81902M	REC93103-11051	26-82251M 315
REC8M0092849	8M0075845	REC90250-06023	17-81903M	REC93104-16M01	26-189721 251
REC8M0092849	8M0098264	REC90280-03024	28-81912M	REC93106-09014	26-82257M 333
REC8M0092849	8M0098264	REC90280-04M00	28-83444M	REC93106-09014	82257M 313
REC8M0103288	8M0103288	REC90280-04M05	8813421	REC93210-19MJ1	858581 233
REC8M0103288	8M0103289	REC90282-04010	28-81916M	REC93210-22M02	25-83348M 251
REC8M0117413	8M0117413	REC90301-ZW1-003	11-52407Q1	REC93210-25552	887812 233
REC8M0125617	881070T	REC90301-ZW1-003	11-52707	REC93210-25552	25-887812 238
REC8M0125617	8M125617	REC90301-ZW1-003	11-827614	REC93210-37160	8814371 313
REC8M0125617	8M0088351	REC90340-08002	953683	REC93210-41042	25-82275M 331-333
REC8M0133642	8M0133642	REC90340-08002	22-81924M	REC93210-42101	25-14175M 315
REC8M0133642	8M0133642	REC90340-08002	22-8M0083059	REC93210-42159	25-82276M 247
REC8M0133642	8M0133642	REC90340-08002	22-8M008360	REC93210-42159	26-94663M 245
REC8M0134459	8M0134459	REC90340-08002	22-95368 3	REC93210-42M70	25-95602M 247
REC8M0134464	8M0134464	REC90340-08002	81924M	REC93210-48214	25-82280M 319
REC8M0134472	8M0134472	REC90340-08002	90363A1	REC93210-49046	25-82281M 320-333
REC8M0134472	8M0134472	REC90340-08002	90363A1	REC93210-53M08	8814372 313
REC8M0134472	8M0134472	REC90340-08002	12-83700M	REC93210-54534	25-11451M 245
REC8M0134492	8M0134492	REC90340-08002	95610	REC93210-54M54	25-84089M 323
REC8M0134492	8M0134492	REC90340-08002	27-95610M	REC93210-58677	25-15377M 321
REC8M0134905	8M0135805	REC90340-08002	81924M	REC93210-65752-00	8255791 313
REC8M0139434	8M0139434	REC90340-08002	90363A1	REC93210-65M50	25-11759M 251
REC8M0142542	8M0010146	REC90340-08002	90363A1	REC93210-66M98	25-82289M 329-333
REC8M0142542	8M0142542	REC90340-08002	12-83700M	REC93210-86M38	8255792 313
REC8M0142688	71-8M0142688	REC90340-08002	95610	REC93211-04384	8814373 311
REC8M0142690	8M0142690	REC90340-08002	27-95610M	REC93224A1	46-93224A1 179
REC8M0143219	826729T2	REC90340-08002	27-95610M	REC93224A1	93224A1 317
REC8M0143219	855998A3, 05, 07, 08, 09, 10, 11	REC90340-08002	81987	REC93224A1	192
REC8M0143219	855998T1	REC90340-08002	95220	REC93306-00501	30-8528001 323
REC8M0143219	862729A2, 6	REC90340-08002	27-81987	REC93306-00519	30-8528001 321
REC8M0143219	8M0143219	REC90340-08002	27-81987M	REC93306-00612	30-82295M 325
REC8M0144930	17065A1	REC90340-08002	27-95220	REC93306-00702	30-82296M 329-333
REC8M0144930	84-816492A1	REC90340-08002	27-95610M	REC93306-204U0	30-18859M 243-247
REC8M0144930	84-8M0144930	REC90340-08002	25-81989M	REC93306-204U0	30-82299M 245
REC8M0144930	84-8M3001068	REC90340-08002	25-81989M	REC93306-210U0	8886814 311
REC8M0148668	885342001	REC90480-18065	804082	REC93306-306V1	30-11767T 251
REC8M0148668	885342002	REC90480-20M05	8887031	REC93306-307U0	30-11766T 251
REC8M0148668	8M0148668	REC90501-10M77	8266901	REC93310-112V0	31-91721M 243-245
REC8M0148668		REC90501-11M10-00	8266901	REC93310-418U0	31-94769M 247
REC8M0151044	887774	REC90501-14M02	24-82091M	REC93310-418V1	243-245
REC8M0151044	893855	REC90501-16233	24-83429M	REC93310-624U5	271
REC8M0151044	8M0109700	REC90501-16M11	804081	REC93310-727V7	29-13304M 251
REC8M0151044	8M0151044	REC90508-ZW1-003	14-31210	REC93311-83280	888681 311
REC8M0162139	8M0137816	REC90508-ZW1-003	14-816629	REC93315-017U4	29-84803M 325
REC8M0162139	8M0162139	REC90508-ZW1-003	14-816629Q	REC93315-22004	31-82315M 325
REC8M0162139		REC90508-ZW1-003	14-816629Q	REC93315-317U2	31-84086M 323
REC8M2011027	79448	REC90794-46866	26-20070	REC93315-32224	31-82316M 331-333
REC8M2011027	8M2000347	REC90794-46868	90890-06820	REC93315-43061	8886815 311
REC8M6000359	880596504	REC908855	90890-06820	REC93317-22024	31-82317M 329-333
REC8M6000359	880596522	REC908855	91-83164M	REC93317-330U2	8886812 313
REC8M6000359	880596524	REC91-00001	91-83164M	REC93332-00001	31-82319M 333
REC8M6000359	8M0007943	REC91-00002	91-12037	REC93332-00003	31-82320M 329-333
REC8M6000359	8M6000359	REC91-12037	91-31107T	REC93332-00005	31-82321M 325
REC8M6000359		REC91-31107T	91-31229	REC93332-00005	31-82321T 323
REC8M6000623	111	REC91-31229	91-31229	REC93332-00048	8886819 311
REC8M6000623	889659002	REC91-34569A1	91-34569A1	REC93332-000UE	31-13300T 251
REC8M6000623	897447002	REC91-36569T	91-36569T	REC93332-000W1	8886811 311
REC8M6000623	8M6000623	REC91-37241	91-37241	REC93341-214U1	31-99030M 322
REC8M6000623		REC91-43506T	91-43506T	REC93341-93020	8886813 313
REC8M6000623	8M0010469	REC91-56048001	91-56048001	REC93440-68M03	53-11760M 251
REC8M6000623	8M6000637	REC91-56775T	91-56775T	REC93450-13022	53-82342M 243-245-247
REC8M6000623		REC91-60523	91-60523	REC93450-15023	271
REC8M6000623		REC91-60526T	91-60526T	REC93501-04011	82346M 311
REC8M6000623	885548001	REC91-61067A04	91-61067A04	REC93602-14104	271
REC8M6000623	885548002	REC91-61069T	91-61069T	REC93602-14118	29-82350M 247
REC8M6000623	8M0010248	REC91-61077T	91-61077T	REC93602-20M02	271
REC8M6000623	8M6000639	REC91-859046Q3	91-859046Q3	REC93603-21111	29-82353M 251
REC8M6000623		REC91-859046Q4	91-859046Q4	REC93606-12019	17-82364M 323-331
REC8M6002428	8M0057686	REC91-895343T02	91-895343T02	REC93606-12019	18842M 243
REC8M6002428	8M6000652	REC91490-30025	887974	REC93606-12019	82364M 233-313
REC8M6002428	8M6002428	REC91490-30025	18-82132M	REC93606-12019	323
REC8M6003194	878187	REC91490-30025	18-82135M	REC93608-12M05	8886631 311
REC8M6003194	8M6003194	REC91490-30040	18-82132M	REC951853	27-98185 262
REC8M6003194		REC91490-30040	18-82134M	REC951853	27-981853 262
REC90095	283	REC92990-16200	887972	REC96452A4	770002 143
REC90101-06M56	10-84790M	REC92990-18200	26-91726M	REC96452A4	73372A1 143
REC90119-06M10	85277616	REC93101-10M14	26-95472M	REC96452A4	73410A1 143
REC90119-08M14	8814231	REC93101-10M25	26-95472M	REC96452A4	76681A1 143
REC90149-06M00	10-83392M			REC96452A4	96452A1-A4-A5 143
REC90170-12138	11-81772M			REC96452A4	147-148
				REC96455A8	68162A3 143
				REC96455A8	68162A6 143
				REC96455A8	96455A1 143
				REC96455A8	96455A8 143

REF	R.O. / OEM		REF	R.O. / OEM		REF	R.O. / OEM	
REC96455A8		147-148	SOL1311-121-09	48-87818A11	349	SOL9411-140-11		351
REC96455A9	681621, A5, A8	143	SOL1313-105-13	48-81670A40	349	SOL9431-130-19		351
REC96455A9	96455A4, A6, A9	A8	SOL1313-105-14	48-81670A40	349	SOL9431-130-21		351
REC96455A9		148-149	SOL1313-108-12	48-81670A40	349	SOL9431-133-17		351
REC96455T18	96455A18	143	SOL1313-111-11	48-85632A40	349	SOL9431-135-15		351
REC96455T18	96455T18	143	SOL1313-118-09	48-87818A11	349	SOL9431-138-13		351
REC96455T18		148-149	SOL1411-130-19	48-77346A45	350	SOL9432-130-19		351
REC97-8M0137814AL	97-8M0137814	70-199-309	SOL1411-130-21	48-77348A45	350	SOL9432-133-17		351
REC97075-10040	10-82474M	333	SOL1411-133-17	48-77344A45	350	SOL9432-135-15		351
REC97095-06040	10-827043M	321	SOL1411-135-14	48-77341A45	350	SOL9432-138-13		351
REC97095-06045	10-92536M	320	SOL1411-135-15	48-77342A45	350	SOL9511-143-21		351
REC97095-08045	10-82468M	331-332	SOL1411-138-13	48-77340A45	349	SOL9511-145-19		351
REC97095-08055	10-84057M	331-333	SOL1411-140-11	48-77338A45	349	SOL9511-148-17		351
REC98-8M0135821	98-8M0135821	68-185-188-298	SOL1413-125-19	48-77344A45	350	SOL9511-150-15		351
REC983892	31-812767A1	303-339-341	SOL1413-125-21	48-77346A45	350	SOL9511-153-13		351
REC98450A10	98450A1-A3-A5-A10	142-147	SOL1413-128-17	48-77342A45	350	SOL9511-155-11		351
REC99001-06600	53-82331M	320	SOL1413-130-15	48-77340A45	349	SOL9511-160-13		351
REC99001-08600-00	53-82334M	333	SOL1413-133-13	48-77338A45	349	SOL9531-140-19		351
REC99001-08600-00	82334M	313	SOL1431-130-19	48-16990A46	350	SOL9531-140-21		351
REC99021A14	99021A11	142	SOL1431-130-19	48-77346A45	350	SOL9531-140-23		351
REC99021A14	99021A14	142	SOL1431-130-21	48-16992A46	350	SOL9531-143-17		351
REC99021A16	99021A3, A5, A8, A13, A15, A16	143-148	SOL1431-133-17	48-77348A45	350	SOL9531-145-15		351
REC99021A6	99021A2, A6, K2	143-148	SOL1431-133-17	48-16988A46	350	SOL9532-140-19		351
RECKOA-A3721-00	804136	225	SOL1431-133-17	48-77344A45	350	SOL9532-140-21		351
RECKOA-A3722-00	804137	225	SOL1431-135-15	48-16986A46	350	SOL9532-140-23		351
RECKITMER115		69	SOL1431-135-15	48-77342A45	350	SOL9532-143-17		351
RECKITMER15		68	SOL1431-138-13	48-17314A46	350	SOL9532-145-15		351
RECKITMER150		69	SOL1431-138-13	48-77340A45	349	SOL9571-145-25		351
RECKITMER2.5		68	SOL1431-140-11	48-17312A46	350	SOL9571-148-23		351
RECKITMER20		68	SOL1431-140-11	48-77338A45	349	SOL9571-150-21		351
RECKITMER209		68	SOL1511-142-23	48-832834A45	350	SOL9571-153-19		351
RECKITMER25		69	SOL1511-143-21	48-832832A45	350	SOL9571-155-17		351
RECKITMER3.4		70	SOL1511-145-19	48-832830A45	350	SOL9571-158-15		351
RECKITMER323		68	SOL1511-148-17	48-832828A45	350	SOL9572-145-25		351
RECKITMER4		68	SOL1511-150-15	48-78116A45	350	SOL9572-148-23		351
RECKITMER4.6		70	SOL1511-153-19	48-13700A46	350	SOL9572-148-23		351
RECKITMER40		69	SOL1511-153-21	48-13702A46	350	SOL9572-150-21		351
RECKITMER50		68	SOL1511-155-17	48-18278A46	350	SOL9572-153-19		351
RECKITMEROP115		70	SOL1511-158-15	48-19838A46	350	SOL9572-155-17		351
RECKITMEROP225		70	SOL1512-142-23	48-832834A46	350	SOL9572-158-15		351
RECKITMERVERADO4		69	SOL1512-143-21		350	SOLRBX-102		350
RECKITMERVERADO6		70	SOL1512-145-19		350	SOLRBX-114		350
RECKITMERVERADO6AL		69-199	SOL1512-148-17		350	SOLRBX-124		350
RECKITMERVERADO6AL		70-199	SOL1512-150-15		350	STA93900		161
RECMC00004	8M0100526	186	SOL1512-153-19	48-13701A46	350	STA93922		161
RECOBBRACKET		74	SOL1512-153-19	48-13703A46	350	STA93932		161
RECOBELEMENT		75	SOL1512-155-17	48-90159A46	350	STA94100		161
RECOBFILALU		75	SOL1512-158-15	48-19841A46	350	TENO0800	31640	200
RECOBFILTER		75	SOL1513-140-21	48-832832A46	350	TENO0800AL	31640	200
RECYCS-225-15		75	SOL1513-140-21	48-834854A45	350	TENO0801	34127	200
RM15-92881A1	15-92881A1	327	SOL1513-143-19	48-832830A45	350	TENO0802	94286	200
RM27-880552A07	27-880552A07,A06	236	SOL1513-143-19	48-834852A45	350	TENO0803	47820	201
RM27-880552A07	27-880552A07/O6	231	SOL1513-145-17	48-832828A45	350	TENO0804	46399	200
RM27-880552A07		238	SOL1513-145-17	48-832828A45	350	TENO0805	46396	201
RM27-896142A07	27-896142A06,A07	236	SOL1513-145-17	48-834850A45	350	TENO0808	34762	200
RM27-896142A07	27-896142A07/O6	229-238	SOL1513-148-15	48-78116A45	350	TENO0809	85824	201
RM27-8M0024565	896277006	229	SOL1571-145-25	48-13704A46	350	TENO0810	42121	201
RM27-8M0024565	27-8M0024565	234	SOL1571-148-23	48-13702A46	350	TENO0811	9411	201
RM27-8M0024565	8M0024565	226	SOL1571-150-21	48-13700A46	350	TENO0812	98432	200
RM27-8M0024565		238-239	SOL1571-153-19	48-18278A46	350	TENO0812	98432T6	295
		240	SOL1571-155-17	48-18278A46	350	TENO0813	823912-1	202
		235	SOL1572-148-23	48-13705A46	350	TENO0813	97-823912	207
		231-235	SOL1572-150-21	48-13703A46	350	TENO0816	818298	201
		238-240	SOL1572-153-19	48-13701A46	350	TENO0816AL	818298	201
		74	SOL3211-099-09		349	TENO0821	89949	201
		75	SOL3211-099-11		349	TENO0822	825271	201
		79	SOL3211-099-12		349	TENO0823	823912	213-289
		79	SOL3211-099-13		349	TENO0823	825271	202
		69	SOL3231-101-13		349	TENO0823	825271	68-69
		272	SOL3231-103-12		349	TENO0824	823913	202
		68-162	SOL3231-105-11		349	TENO0824	823913Q	287-316
		204	SOL3231-108-10		349	TENO0824		68
		180-337	SOL5011-078-07		349	TENO0825	818298	202
		68-162	SOL5011-078-08		349	TENO0825AL	818298	202
		238	SOL5011-078-09		349	TENO0826	76214	201
		162	SOL5011-085-07	48-895180A10	349	TENO0827	17264	200
		284	SOL5011-085-08	48-895182A10	349	TENO0827	17264T2	303
		83	SOL5011-085-09		349	TENO0829	822157	200
		83	SOL5111-093-07		349	TENO0829AL	822157	200
		83	SOL5111-093-08		349	TENO0829AL	822157T2	301
		83	SOL5111-093-09		349	TENO0830	822777	200
		83	SOL5111-093-11		349	TENO0831	826887M	202
		71	SOL5211-099-09		349	TENO0832	80653	201
		71	SOL5211-099-10		349	TENO0833	893404	201
		71	SOL5211-099-11		349	TENO0834	875208	202
		316	SOL5211-099-13		349	TENO0835	76214-4	201
		349	SOL9311-110-15		349	TENO0837	8M0012083	70-201
		287	SOL9311-111-13		349	TENO0838	847635001	202
		349	SOL9311-111-14		349	TENO0839	853762	200
		349	SOL9311-111-14		349	TENO0840	8239121	201
		349	SOL9311-111-14		351	TENO0841	804043	69-202
		349	SOL9311-111-14		351	TENO0842	8M0057772	69-202
		349	SOL9311-111-14		351	TENO0842AL	8M0057772	202
		349	SOL9311-116-11		351	TENO0843AL	879150A65	202
		349	SOL9311-120-10		351	TENO1101	83859M	329-333
		349	SOL9311-121-09		351	TENO1108		201
		349	SOL9331-110-15		351	TENO1116	811990M	322
		349	SOL9331-111-13		351	TENO1118	97-14205M	320
		349	SOL9331-111-14		351	TENO1121	84732M	247
		349	SOL9331-114-12		351	TENO1127	83394M	251
		349	SOL9331-116-11		351	TENO1166	83330M	251
		349	SOL9411-132-19		351	TRI305-0386		72
		349	SOL9411-132-21		351	TRI305-0566		72
		349	SOL9411-133-17		351			
		349	SOL9411-135-15		351			
		349	SOL9411-138-13		351			
		349	SOL9411-140-09		351			

RO / OEM --> REF

RO/OEM	REF	RO/OEM	REF	RO/OEM	REF
9411	CM09411	197	94286	TEN00802	200
9411	TEN00811	201	94320	REC10-94320	252-253
12415	REC12415	110	95220	REC90430-08020	287-291-297-299-316
13171	REC12-31211Q01	352	95229	PAT3.6-04000006	203-213
13171	REC12-835467Q01	353	95347	REC30-95347	316
14480	REC14480	167	95348	PAF8-04000101	287-291-316
14586	REC14586	69-162-164	95395	PAF4-04000030	203-213
16049	REC30-16049	203	95610	REC90430-06M03	233
16057	REC53-16057	203	98432	TEN00812	200
16064	REC815113T02	116	160643	REC3G2-06040-2	117
16128	PAGB/T276-6004	287	161451	PAT5-03000800	289
16130	PAF8-04040004	291	161471	REC11-161471	297
16130	REC26-16130	289	161541	REC345-65021-0	172-299
16131	PAF8-04040002	287-291	161543	REC47-161543	287
16133	PAT5-03000016	289	161571	REC161571	287
16138	REC43-16138	287	161586	PAF8-04000006	68-182-291
16140	PAF8-04000012	291	161587	PAF8-04000005	182-291
16141	PAF8-04000012-1	287-291	161622	REC26-161622	188-297-299
16147	PAF15-06000016	297	162532	REC162532	105
16147	REC11-16147Q	289	167051	PAGB/T5787-M6X20	203-287-298-299-316
16150	PAF8-04010000	291	384073	PAF25-05010104	219
16152	PAF8-04000305	291	400213	PAGB/T6170-85	229
16152	PAT5-03000404	289	400325	PAGB/T5783-M6X8	219
16157	PAF6-03000002	289	401388	PAGB/T6182-2000	229-231
16157	REC16157	181	416223	PAF25-05010103	219
16159	REC16159	68-180-289	416223	REC22-41622	223
16165	PAT5-03000023	289	479452	PAF15-07010004	219-223
16253	REC16253	92-105	480955	PH130-0047	128
16496	REC16496	168	490955	PH130-0047	128
16832	PAGB/T5783-M6X16	203-213-287-316	627021	REC25-62702	219-223
17264	TEN00827	200	629101	PAF25-02010003	223
19273	REC19273	106	770002	REC96452A4	143
19552	REC27-19552	183	803507	NGKD CPR6E	203-213
19643	REC19643	347	803508	REC27-803508	204
20843	REC20843	303-327	803673	REC803673	248
21836	REC25-21836	309	803735	REC25-8M0087846	297
31640	TEN008000	200	803743	PAF8-04000019	297
31640	TEN00800AL	200	803745	REC52-803745	297
32435	REC324351	181-194-195-196-335	803748	REC334-65021-1	297
32768	REC32768	327	803749	REC28-803749	297
34127	TEN00801	200	803751	REC803751	297-298
34762	TEN00808	200	803752	REC26-803752	297-298
37721	REC37721001	327	803753	REC803753	297
42039	REC42039	293	804043	TEN00841	69-202
42121	TEN00810	201	804072	PAF25-00000006	225
42200	REC42200	180-191-192-193-293	804076	REC67F-41114-A2	225
42375	REC42375	293	804078	PAF40-05000053	225
43023	REC43023	301-303-305-347	804079	CM67F-11325-00	233
43046	REC43046	305	804080	REC60H-12416-00	225
43396	CM43396	198	804081	REC90501-16M11	225
43396	CM43396A	198	804082	REC90480-20M05	225
43993	REC26-43993	253	804086	REC67F-11328-00	225-233
46396	TEN00805	201	804120	PAGB/T818-M4X8	225
46399	TEN00804	200	804136	RECK0A-A3721-00	225
46895	REC46895	180-192-317	804137	RECK0A-A3722-00	225
47270	REC29-47270	249	804144	REC93102-38008	225-233
47820	CM47820	197	804145	REC67F-46241-00	225
47820	TEN00803	201	804184	REC6H4-14985-01	94-106
48752	REC48752T	181	804540	RM804540	68-162-164-203-204
48753	REC48753	181-193-194-327	804903	PAF8-04000013	291
54705	REC32768	181	808504	REC66K-13915-00	79
62351	PH350-0003	138	809569	REC809569	92-93-106
65848	REC65848	169	811618	REC893929A01	151
70977	REC70977T	181-192-317	811628	REC878265A6	151
73345	REC663-45987-00	333	812876	REC12-8M0012298	252
75692	REC13350	162	812944	REC43-812944	287-289
75692	REC6F5-12411-03	162	813277	PAF8-04000012-2	287-291
76214	CM76214	197	815083	SOLO001-073-06P	316
76214	CM762145A	197	815111	REC17-815111Q02	287
76214	TEN00826	201	815481	REC12-815481	305
77674	REC12-77674	309	817411	REC883072T	139
78614	PH350-0003	138	818298	TEN00816	201
79448	REC8M2011027	307-335-337	818298	TEN00816AL	201
80375	REC803753	180	818298	TEN00825	202
80653	TEN00832	201	818298	TEN00825AL	202
81987	REC90430-08020	311	818391	REC29-818391001	252
82779	PRE30107	159	818574	REC818574	261
85083	REC85083	180-191-193-295	821509	REC882751A04	133
85094	REC85094	295	821526	REC821526001	337
85691	PAF15-07000024	211	821663	PH300-0019	136
85824	TEN00809	201	822157	TEN00829	200
86210	REC43242-5	107	822157	TEN00829AL	200
86352	REC8M0092849	150	822158	REC822158	301
89026	CM89026	197	822625	PAF15-07010003	209-215-219-223
89949	TEN00821	201	822649	PAF25-05050001	217
90196	PAJASOF404-35-025	219-223-226-229-231-233	822650	PAF15-07040006	217
91012	REC10-91012	249	822777	PAF15-07050006	211
91800	PAF25-05000024	221-223-231	823033	TEN00830	200
			823548	REC61N-85570-01	116
				REC54-8M0064024	301
823683	REC25-823683	252-253	823912	TEN00823	213-289
823912	TEN00823	213-289	823913	TEN00824	202
823913	TEN00824	202	824051	PH200-T033	152
824051	PH200-T033	152	824145	REC824145	337
824145	REC824145	337	824853	PAF15-07010022	219-223
824853	PAF15-07010022	219-223	825010	PAF25-00000014	219-223
825010	PAF25-00000014	219-223	825019	PAF25-05020204	221
825019	PAF25-05020204	221	825027	PAF25-05020003	221
825027	PAF25-05020003	221	825046	PAF15-07040303	221
825046	PAF15-07040303	221	825050	PAF25-05050009	217
825050	PAF25-05050009	217	825054	PAF40-05070002	219
825054	PAF40-05070002	219	825212	PAF15-07000031	215
825212	PAF15-07000031	215	825271	TEN00822	201
825271	TEN00822	201	825271	TEN00823	202
825271	TEN00823	202	825435	CM668-11325-00	205
825435	CM668-11325-00	205	825451	PAF15-07040012	211
825451	PAF15-07040012	211	825451	PAF15-07040301	211
825451	PAF15-07040301	211	825490	PAF15-07050004	211-215
825490	PAF15-07050004	211-215	825667	REC66G-85540-29	140
825667	REC66G-85540-29	140	825702	PAGB/T5783-M6X20	211
825702	PAGB/T5783-M6X20	211	825953	PAF15-04000002	233
825953	PAF15-04000002	233	826134	CM826134	197
826134	CM826134	197	826134	CM826134A	197
826134	CM826134A	197	826150	PAF15-07040304	221
826150	PAF15-07040304	221	827207	PAGB/T5783-M8X25	225
827207	PAGB/T5783-M8X25	225	827365	REC827365	169
827365	REC827365	169	828151	REC882751A1	133
828151	REC882751A1	133	828358	REC8M0082988	112
828358	REC8M0082988	112	828553	REC8M000822	258
828553	REC8M000822	258	828708	PH200-T010	152
828708	PH200-T010	152	830274	PAF25-05050008	217
830274	PAF25-05050008	217	830749	REC26-830749	309
830749	REC26-830749	309	831246	PAF4-04000006	225-233
831246	PAF4-04000006	225-233	831294	REC65W-46241-00	217-272
831294	REC65W-46241-00	217-272	832013	PAF25-05020002	221
832013	PAF25-05020002	221	832990	PAF25-05050002	217
832990	PAF25-05050002	217	833102	PAF25-05000021	217
833102	PAF25-05000021	217	833104	PAF25-05050017	217
833104	PAF25-05050017	217	834777	REC67C-11181-01	219
834777	REC67C-11181-01	219	834954	PAF15-07050001	211
834954	PAF15-07050001	211	834956	PAF15-07040200	211
834956	PAF15-07040200	211	834974	PAF15-07010200	209
834974	PAF15-07010200	209	835392	REC66M-46241-00	211-272
835392	REC66M-46241-00	211-272	850055	REC850055001	163
850055	REC850055001	163	850307	REC850307	305
850307	REC850307	305	850837	PAF15-07050002	211-239
850837	PAF15-07050002	211-239	850838	PAF15-07040001	211
850838	PAF15-07040001	211	850839	PAF15-07040002	211
850839	PAF15-07040002	211	850842	PAF15-07040015	211
850842	PAF15-07040015	211	853762	REC853762	69-199-299
853762	REC853762	69-199-299	853762	TEN00839	200
853762	TEN00839	200	854341	PAF40-05000002	219
854341	PAF40-05000002	219	854445	REC854445	109-113-114
854445	REC854445	109-113-114	854713	PAF40-05040004	221
854713	PAF40-05040004	221	855219	PAF25-05060002	278
855219	PAF25-05060002	278	855236	PAF40-05070003	219
855236	PAF40-05070003	219	855678	PAF15-07010008	209
855678	PAF15-07010008	209	855690	PAF15-07010027	225
855690	PAF15-07010027	225	855776	PAF15-07010011	209-245
855776	PAF15-07010011	209-245	855779	PAF15-07010012	209-215
855779	PAF15-07010012	209-215	855837	PAF25-05080004	278
855837	PAF25-05080004	278	855959	PAF15-07040004	211
855959	PAF15-07040004	211	857078	PAF60-05000004	223
857078	PAF60-05000004	223	857080	PAF15-07010021	165
857080	PAF15-07010021	165	857139	PAGB/T5782-M8X35	223
857139	PAGB/T5782-M8X35	223	857139	PAGB/T5783-M8X35	219
857139	PAGB/T5783-M8X35	219	858498	REC858498	295-353-354
858498	REC858498	295-353-354	858530	PAGB/T5787-M6X30	225
858530	PAGB/T5787-M6X30	225	858581	REC93210-19MJ1	233
858581	REC93210-19MJ1	233	858763	REC858763	71
858763	REC858763	71	859210	REC881879T11	111
859210	REC881879T11	111	859495	NGK LFR5A-11	122-124-225-233
859495	NGK LFR5A-11	122-124-225-233	85976		

RO/OEM	REF		RO/OEM	REF		RO/OEM	REF	
898101371	REC898101371	68-287	11-81773M	PAF25-05000026	217	12-953921	PAGB/T848-6	204
898829001	NGKLF4AE	69-122-123-226	11-81774M	REC90171-14013-00	325	12-96311M	PAF4-03000006	319
899883230	REC899883230	141	11-81775M	REC90171-16011	329-333	12082A1	REC815279A2	139
985810050	PAGB/T5783-M8X50	231	11-81781M	PAGB/T889.1-M5	329	12082A7	REC815279A2	139
1-855679	PAF15-07030005	211	11-826150	PAF15-07040304	211-217	12082A8	REC815279A2	139
10-11746M	PAGB/T5783-M6X25	251	11-826150001	PAF15-07040304	207	12596T2	REC12596T2	305
10-19937-16	REC10-816928	337	11-827614	REC90301-ZW1-003	335	13-42351-1	REC13-423511	335-337-353
10-2405M	PAGB/T5783-M6X25	251	11-827614Q	REC11-52707Q1	337	13191A1	REC13191Q01	305-352
10-30720	REC10-30720	346	11-84807M	REC90179-09M02	325	13301M	REC6F5-11515-00	251
10-40011128	PAGB/T5783-M6X20	215	11-855679001	PAF8-05010016	207	1395-4808-1	REC1395-48401	93-94-95-103
10-41884M	PAGB/T5783-M5X12	209	11-88228	REC11-88228	295	1395-5109-1	REC40480	102
10-41889M	REC6A0-14325-00	105	11489M	REC6G1-14985-00	105	1395-6200	REC1395-6200	93-94-102
10-43092M	PAGB/T5783-M5X12	209	11490M	REC6G1-14546-00	104	1395-6452	REC1395-6452	103
10-48408	REC10-48408	293	11497M	REC6G1-24471-00	89	1395-7623	REC1395-7623	106
10-49908	REC10-49908	295	11499M	REC6G1-24411-00	89	1395-7824	REC1395-7824	95-96-105
10-69570	REC10-69570	168	11502M	REC6G1-W0093-00	100-104-245	1395-811223-1	REC1395-8112231	102
10-79953A2	REC10-79953Q04	345	11560M	REC6G1-45113-A1	258	1395-8112231	REC1395-8112231	249
10-79953Q04	REC10-79953Q04	307	11589M	REC6G1-44322-00	320	1395-811357	REC1395-97611	101
		293-295-301-303-305-317-327-335-337	11592M	REC6G1-44323-00	320	1395-811690-1	REC1395-811690-1	95-96-105
10-80573M	REC647-14323-00	105	11593M	REC6G1-44328-00	320	1395-811691	REC1395-811691-3	103-104
10-806327	REC10-806327	307-337	11655M	REC6G1-W0001-C1	320	1395-811691 2	REC1395-811691-2	95-96-103-104
10-816928	REC10-816928	307	11656M	REC6G1-W0078-A1	184-320	1395-823635-4	REC1395-823635-4	101
10-82442M	PAGB/T5783-M8X35	251	11656T	REC6G1-W0078-A1	184	1395-8236354	REC1395-823635-4	252
10-82468M	REC97095-08045	331-333	11737T	REC6F5-85540-22	141	1395-8318	REC1395-8318	92-93-94-95-104
10-82474M	REC97075-10040	333	11747M	REC6F6-11191-00-1S	251	1395-8506	REC1395-6452	103
10-8248324	PAGB/T5783-M6X16	303	11753M	REC6F5-41111-01-1S	251	1395-8673	REC1395-8673	106
10-82500925	PAGB/T5783-M6X25	211-215	11755M	REC6F5-41113-A0-1S	251	1395-8983	REC1395-8673	106
10-82500930	PAGB/T5783-M5X12	209	11810M	REC6F6-W0093-00	102	1395-9022	REC1395-9022	92-93-105
10-825010	PAF25-05020204	217	11810T	REC6F6-W0093-00	102	1395-9024	REC1395-9024	93-102
10-82503395	PAF25-05000002	215	11919M	REC6E5-12411-02	162-245	1395-9179	REC1395-97611	101
10-825046	PAF15-07040303	211-217	11921M	REC6E0-26301-01	107	1395-9258	REC1399-1473	104
10-825046001	PAF15-07040303	207	12-12577	REC12-12577	305	1395-9262-1	REC40470	100
10-82506182	PAGB/T5782-M8X80	215	12-13305M	REC90209-27M07	251	1395-9267	REC1395-7623	106
10-8257021	PAGB/T5783-M6X30	251	12-16140	PAF5-03000015	289	1395-9377	REC1395-97611	101
10-82641030	PAF25-05050019	217	12-161402	PAGB/T96-10	352	1395-9594	REC1395-9594	93-94-95-106
10-826844-30	REC10-82684430	293-305	12-16146	PAGB/T96-10	289-347	1395-9595-1	REC1395-9595-1	93-94-95-105
10-826957M	PAGB/T5783-M5X12	211	12-16448	REC12-16448	293	1395-9645	REC1395-97611	101
10-826957M	PAGB/T5783-M6X16	251	12-16826	PAGB/T97.1-6	289	1395-9651	REC1395-9651	93-102
10-827043M	PAGB/T5782-M6X45	323	12-19183	REC12-191833	347	1395-9725	REC1395-97611	101
10-827043M	REC97095-06040	321	12-19183-2	REC12-191833	337	1395-9761	REC1395-97611	101
10-827607	PAF25-05050006	215			293-295-301-303-305-327-335	1395-97611	REC1395-97611	101
10-83285M	PAGB/T5783-M6X30	315	12-20084	REC12-20084	347	1395-9803	REC1395-97611	101
10-83392M	REC90149-06M00	329	12-20260	REC12-191833	317-347	1399-1138	REC1399-1473	104
10-83858M	PAGB/T820-M5X30	329	12-29245	REC12-29245	295-301-327-335	1399-1473	REC1399-1473	104
10-83870M	PAGB/T818-M6X16	329	12-31211A2	REC12-31211Q03	354	1399-1717	REC1395-2015	100
10-84057M	REC97095-08055	331-333	12-31211A3	REC12-31211Q03	335-337	1399-2015	REC1395-2015	100
10-84058M	PAGB/T5783-M6X20	321-323	12-38453	REC12-38453	170-327	1399-3523	REC1395-2015	100
10-84088M	PAGB/T5783-M6X10	323	12-4002319	PAF25-05050018	217	1399-3938	REC1399-3938	79
10-84272M	PAGB/T845-ST4.2X16	323	12-41369	REC12-41369	293	1399-5135	REC1395-5198	101
10-84368M	PAGB/T5783-M6X16	315	12-45176	REC12-45176	305	1399-5137	REC1399-5137	92-93-101
10-84788M	PAGB/T845-ST4.8X9	323	12-76451	REC12-76451	169	1399-5198	REC1395-5198	101
10-84790M	REC90101-06M56	325	12-77674	REC12-77674	307-327-335-337-347	1399-99	REC1399-99	278
10-850879	PAGB/T5783-M5X12	211				14-18323	REC14-18323	337
10-855677	PAF15-07000028	211	12-78910	REC12-78910	335	14-18323	REC90508-ZW1-003	353
10-855778	PAGB/T5783-M5X12	209	12-80404M	PAF2.6-03000017	315	14-76281	REC14-76281Q	301-303-327-354-353
10-857139	PAGB/T5782-M8X35	215	12-81455M	REC663-45552-00	329-333	14-79447	REC14-79447	335
10-88348935	PAGB/T5782-M6X35	215	12-81461M	REC663-45576-00	329	14-816629	REC90508-ZW1-003	337
10-88348935	PAGB/T5783-M6X25	215	12-81477M	REC663-45987-00	329	14-816629Q	REC90508-ZW1-003	305
10-88348935	PAGB/T5783-M6X35	215	12-815025M	REC6E7-45987-00	323	14-81877M	REC90214-48M03	329-333
10-89514001	PAF8-00000003	207	12-81650M	REC664-45987-00	325	14180M	REC6E7-14385-00	105
10-91722M	PAGB/T5783-M6X35	321	12-81816M	REC90201-12565	247	14216M	REC6E8-14390-12	104
10-91772M	PAGB/T5783-M6X35	315	12-81831M	REC90201-20417	251-325	14307A1	REC14307T01	86
10-92521M	PAGB/T5783-M5X16	315	12-81837M	REC90201-22429	329-333	14307T01	REC14307T01	86
10-92523M	PAGB/T5783-M6X30	320	12-81852M	PAF25-02000019	331	14334A3	REC14334A3	179-191-193-194-303
10-92536M	REC97095-06045	320	12-81875M	PAF4-03000006	315	14360T74	REC14360T74	84
10-94320	REC10-94320	252	12-82214M	PAGB/T861.1-87	315	14360T77	REC14360T77	85
10-96411	REC10-96411	335-346	12-82214M	PAGB/T97.1-6	315-323-331	14479-1	REC14479-1	168
11-13436	REC11-13436	335	12-82214M	PAGB/T97.1-8	315	14586A3	REC14586A3	164-166
11-13438	REC11-8267089	327-335	12-82217M	PAGB/T97.1-8	331-333	14586A7	REC14586A7	164-166
11-13914A2	REC13914Q02	354	12-825044	PAF25-05050003	217-221	14857A10, A16	REC14857A16	149
11-16147	PAF15-06000016	352	12-825467	REC12-31211Q01	352	15-16141	PAF8-04000002-1	289
11-161471	REC11-161471	352	12-825498	PAGB/T5287-6	211	15-161631	PAT5-03000004-1	289
11-31990A2	REC11-31990Q02	354	12-827055M	PAGB/T861.1-87	321	15-19148005	PAF15-06080006-1	323
11-35921	REC11-35921	305-307-335-337-341	12-82710M	PAF15-07040017	211	15-19148M	PAT40-04000003-1	331
11-40119-12	REC11-4011912	295	12-835467-1	REC12-31211Q01	337	15-19149M	PAT40-04000003-3	331
11-4011912	REC11-4011912	352	12-83700M	REC12-835467Q01	335	15-19150M	PAT40-04000004-4	331
11-401378	REC11-401378	305	12-84620M	REC90389-22M01	329	15-19151M	PAT40-04000003-5	331
11-40140	REC11-40140	293	12-850843	REC90209-18112	243-245-247	15-19152M	PAT40-04000003-6	331
11-45812	REC11-859124	327	12-850843	PAF15-07030004	211	15-19153M	PAT40-04000003-7	331
11-52407Q1	REC90301-ZW1-003	305	12-85303	REC12-85303	169	15-19154M	PAT40-04000004-1	329
11-52707	REC90301-ZW1-003	352	12-855941	REC12-855941	305	15-38657A1	REC15-38657A1	307
11-52707A1	REC11-52707Q1	354	12-858234	REC8M0005777	69-303	15-42637A1	REC15-42637A1	335-337-346
11-52707Q1	REC11-52707Q1	354	12-86645	REC12-86645	347	15-44491A1	REC15-44491A1	305-337
11-55910	REC313339	334-336-354	12-86645-1	REC12-86645	295-301	15-44492A1	REC15-8M00663265	305
11-69578	REC11-69578Q1	342	12-881379	PAGB/T97.1-6	251-321	15-47397A1	REC15-47397A1	335-337-346
11-69578A1	REC11-69578Q1	301-303-327	12-89302	REC12-29245	295	15-80259M	PAF15-06080006-3	323
11-81450M	REC697-45384-00	329-333	12-895118001	PAF8-05030015	207	15-80260M	PAF15-06080006-5	323
11-81619M	REC664-45384-00	325	12-92721	REC350038	307-335-337-347	15-812770A1	REC15-812770A1	303
11-81772M	REC90170-12138	329-333	12-94182	REC12-94182	168	15-8132761	PAT5-03000004-2	289
			12-94627M	REC90201-17682	323	15-813277	PAF8-04000002-2	289
						15-81459M	PAT40-04000004-5	329

RO/OEM	REF		RO/OEM	REF		RO/OEM	REF	
15-81469M	PAT40-04000003-2	331	18856M	PAF4-04000019	221-223	23014A1	REC23014A1	91-92-93-94-95
15-884327A01	REC15-884327A02	307	18955M	PAF15-06000010-2	323	24-17667	PAT5-03000402	289
15-92881A1	RM15-92881A1	327	18958M	PAF15-06000010-5	323	24-29340A1-T1	REC24-13421	130
155278A1	REC155278A1	91-93-94-95	18960M	PAF15-06000010-7	323	24-30893	REC24-30893	303-305-307-335-337-346
15920A54	REC8M0092849	150	19-825953	PAF15-04000002	81	24-38114	REC24-38114	301-327-346
16058T	REC16058	119	19052A1, 2, 3, 4, 5, 6, 8	REC19052A8	141-147	24-42996	REC24-42996	168
16061T04	REC16061T04	140	19167M	REC688-45215-02	329	24-47968	REC24-47968	168
16064A1	REC815113T02	116	19217A1-A5	PH200-T003	151	24-64878	REC24-64878	168
16064A3	REC815113T02	116	19255M	REC6E9-12413-00-15	165-251	24-78962	REC24-78962	335
16158 5	PAF8-04000008	68-291	19271-1	REC19271-1	93-94-104	24-79910	REC24-79910	335
1623-822442A19	REC1623-822442A19	281	19291A3	REC19291A3	301-303	24-803554005	PAF8-05030005	207
1623-822442A20	REC1623-822442A20	281	19513 3	REC44-195133	289	24-815418	REC24-815418	303
1623-859399T13	REC1623-859399T13	281	19700A2	REC19700A2	69-181-191-193-194-303	24-82091M	REC90501-16233	333
1623-859399T14	REC1623-859399T14	281	19755T7	REC19755T7	307	24-823678	PAF25-05050005	217
1623-888680T06	REC421-B25F	283-311	21-13424A1	REC21-13424A1	90-93-94	24-825052	PAF25-05050011	217
1623-888680T07	REC421-B30F	283-311	21-30430A1	REC21-30430A1	92-93-94-95	24-825052	PAF25-05050012	217
1623-888680T08	REC428-B25F	283-311	21-30430A13	REC21-30430A13	90-94	24-825452	PAF15-07040014	211
1623-888680T09	REC428-B30F	283-311	21-30430A14	REC21-30430A14	90-94-95	24-825452001	PAF8-05030009	207
1647-9148T81	REC1647-9148T81	281	21-30430A3	REC21-30430A3	91-93-94-95	24-825453	PAF15-07040013	211
1647-9148T82	REC1647-9148T82	281	21-30430A4	REC21-30430A4	91-93	24-83429M	REC90501-16M01	329
1647-9148T84	REC1647-9148T84	281	21-30430A7	REC21-30430A7	91-95	24-850840	PAF15-07040005	211
1647-9148T85	REC1647-9148T85	281	21-41279M	REC6E0-41114-A1	169	24-88680	REC24-88680	295
1667-901110, 11	REC1667-9011R6	282	21-42990A10	REC21-42990A10	90-93-94-95-96	24-90392	REC24-90392	168
1667-901167, 78	REC1667-9011R6	282	21-80727M	REC650-11370-00	243-247-251	2417-830269A1	PAF25-05020001	217-242
1667-9011G51	REC1667-9011R6	282	22-13563T-3	GS31027	73	2419-82500935	PAF25-05050200	217
1667-9011G70	REC1667-9011G90	282	22-13563T-3	GS31028	73	25-11451M	REC93210-54M54	245
1667-9011G90	REC1667-9011G90	282	22-13563T-7	GS31082	73	25-11759M	REC93210-65M50	251
1667-9011J41	REC1667-9011J41	282	22-142131	GS31026	73	25-14175M	REC93210-42101	315
1667-9011J6	REC1667-9011R6	282	22-34982	GS31067	76	25-15377M	REC93210-58677	321
1667-9011R6	REC1667-9011R6	282	22-424254	REC22-424254	76	25-161771	PAT5-03000022	289
16900A15	REC881170A15	155	22-479452	PAF15-04000002	215	25-16178	PAJISB2401P16	289
16900A20	REC881170A20	157	22-67892A05	REC22-67892A05	303	25-20081	REC25-20081	263
16901A15	REC881170A3	155	22-67892A1	REC22-67892A05	293-295-301-303-305-327-335-345	25-20273	REC25-20273	181-327
16902A15	REC881170A7	156	22-687271	REC22-687271	168	25-20826	REC308627	263
16907A15	REC881170A7	156	22-80122M	PAT15-04010202	251	25-20863	REC25-80863	263
17-11794M	REC6E5-14386-01	107	22-8189941	REC22-8189941	76	25-21836	REC25-21836	337
17-13302T	REC6F5-11681-00	251	22-81924M	REC90340-08002	315-319-320-321-322-325-329-333	25-25439	REC25-25439	327-335
17-14193M	REC6G1-11681-1	243-245-247	22-822644	PAF15-07010006	209	25-26722	REC302588	327
17-16150	PAGB/T879.1-3.5X28	289	22-822644001	PAF8-05010002	207	25-26802	REC303347	317
17-30632	REC17-8M0084681	305-307-335-337-344	22-83326M	PAF15-04000005	205-209-247	25-26855	REC3852928	301
17-38113	REC17-8M0020942	303-327	22-83369M	REC676-14966-00	105	25-26855	REC309731	317
17-43043	REC17-43043	303	22-887987A1	REC22-887987A1	347	25-30224	REC25-30224	303
17-78905	REC17-8M0084243	335	22-89771Q2	GS31066	76	25-30271	REC25-30271	181-335
17-80252M	PAF15-06000009	322	22-8M0083059	REC90340-08002	345	25-30529	REC25-30529	317
17-80451M	REC647-14386-10	107	22-8M008360	REC90340-08002	345	25-31305	REC553126	263
17-81278M	REC663-14548-00	107	22-8M0086290	BRA125-3/8X1/2	76	25-31534	REC25-31534	337
17-81896M	REC90250-03M10	315	22-94716M	PAF4-04010102	251	25-31986	REC3852866	327
17-81899M	REC90250-05010	323-325	22-95368 3	REC90340-08002	289	25-32546	REC25-32546	263
17-81901M	REC90250-05036	321	22-95632M	REC688-45341-00	333	25-32546	REC25-32546	263
17-81902M	REC90250-05046	319	22-9964-1	REC331886	169	25-33145	REC25-33145	293
17-81903M	REC90250-06023	329-333	22-996642	PAF25-05010113	215	25-33466	PAF25-05000011	278
17-82145M	PAGB/T879.4-3X20	251	22831T03	GS31078	73	25-35027	REC25-35027	337
17-822369	REC17-822369	301	23-16124	PATLA1412Z	289	25-35276	REC310584	295
17-82354M	PAF25-04000007	323-331	23-16176	PAT5-03000020	289	25-36318	REC25-36318	337
17-82355M	PAF4-03000016	319	23-29804	REC23-29804T	335-347	25-45258	REC25-45258	303
17-82356M	PAF2.6-03000013	315	23-29804	REC26-816575A2	345	25-45710	REC25-45710	305
17-82364M	REC93606-12019	323-331	23-41367	REC23-41367	293	25-47254	REC310414	263
17-82368M	PAF25-00000014	251	23-42091-1	REC23-420911	293	25-54029	REC25-33465	263-264-265
17-825010	PAF25-00000014	215	23-420911	REC23-420911	353	25-62700	REC25-62700	263-265
17-825689	PAF15-07000001	209-211	23-43045	REC23-43045	303	25-62704	REC3852045	317
17-825689	PAF15-07000001	205	23-43052A4	REC23-43052A4	305	25-6270501	REC25-62705001	226
17-825956	PAF25-05050016	217	23-77631A2	REC23-77631A2	327-335	25-64872	REC25-64872	168
17-828356	REC17-828356	307-335-337	23-80536M	REC647-45316-09	321	25-67207	REC25-62706	263-264-265
17-85096	REC17-85096	295	23-813696A2	REC23-813696A2	303	25-69202	REC25-67202	295
17-85500	REC17-85500	295	23-815921A4	REC23-815921A21	337	25-803514	REC26-803514	244
17-85593	REC17-85593	295-301	23-815921A4-A10	REC23-815921A21	344	25-809086	REC25-809086	97
17-92639M	REC676-14186-00	107	23-81841M	REC93101-20M34	245	25-815460	REC25-80863	301
17-9521811	PAF8-04000021	346	23-821927	REC23-821927	293	25-815460	REC25-815460	303
17-97730M	REC688-14548-00	107	23-823943	REC23-823943	293	25-818573	REC25-818573	238
17050M	REC6H3-14590-00	104	23-823944	REC23-823944	293	25-81989M	REC90430-12072	331
17065A1	REC8M0144930	159	23-823944	REC23-823944	293	25-821308	REC25-821308	301
17068M	REC6E9-W0093-02	102-104	23-824108	REC23-824108	335-337	25-822236	REC25-822236	293
17264T2	CM17264	197	23-825021	PAF25-05020203-1	217	25-82275M	REC93210-41042	331-333
17264T2	TEN00827	303	23-8250212	PAF25-05020203-2	217	25-82276M	REC93210-42159	247
17514A1	REC31-17514A2	249	23-825024	PAF25-05010302-1	217	25-82280M	REC93210-48214	319
17649A1/A02	PH200-T015	152	23-8250241	PAF25-05010302-2	217	25-82281M	REC93210-49046	320-333
18-815026	PAGB/T91-2.5X20	323	23-82590M	REC626-45316-09	323	25-82289M	REC93210-66M98	329-333
18-815026	PAGB/T91-3.2X18	289	23-84445M	REC667-45997-00	329-333	25-823683	REC25-823683	263
18-8150261	PAGB/T91-2.5X20	68-353-354	23-85095	REC23-85095	295	25-825040	PAF15-07010009	215
18-82132M	PAGB/T91-1.6X12	319	23-85557	REC23-85557	295	PAGB/T3452.1-35.5x1.		278
18-82132M	REC91490-30025	329	23-86215	REC23-86215	317	25-8250572	PAGB3452.1-82	278
18-82132M	REC91490-30030	325	23-891919001	REC23-891919001	307	25-825492	PAF4-04000008	211
18-82134M	REC91490-30040	315	23-8M0142859	REC23-8M0142859	309	25-825492	PAJASOF40431-025	215
18-82135M	REC91490-30025	333	23-8M0164967	REC23-8M0164967	309	25-826152	PAF25-05050015	217
18495-A10-12-	REC18495A26	142-147-148	23-95476M	REC6E0-45316-00	319	25-826153	PAF25-05050013	217
15-18-19-26			23-95477M	REC6E0-45316-00	319	25-826154	PAF25-05050014	217
18495A4-5-6-8-13	REC18495A13	141	23-99035M	REC6E7-45536-00	323	25-833103	PAF25-05000004	215-239
18495A9, A14, A15, A20, A21, A25, A30	REC18495A30	141-147				25-83348M	REC93210-22M02	251
18842M	REC93606-12019	243				25-84054M	REC689-44315-A0	325
18853M	PAF4-00000001	319				25-84089M	REC93210-57M09	323
						25-8527681	PAF15-07050003	211

RO/OEM	REF		RO/OEM	REF		RO/OEM	REF	
25-853525	PAF15-07000007	278	26-80398M	PAF4-03000021	319	27-11574M	REC6G1-45315-A0	320
25-854341	REC67C-11356-00	238	26-80398M	REC646-44366-01	315	27-11591M	REC6G1-44315-A0	320
25-854639	REC25-854639	168	26-804349004	REC26-8M0036343	226	27-11745M	REC6F5-11181-A2	251
25-854722	PAGBT3452.1-97.5X1.8	215	26-80532M	REC647-44366-00	320-321	27-11754	REC6F5-41112-A0	251
25-85549	REC25-85549	295	26-81426M	REC663-44366-00	331-333	27-11754M	PAF15-04000003	251
25-855690	PAF15-07010027	211	26-81427M	PAT40-02000002	331	27-11756	REC6F5-41114-A0	251
25-85594	REC301877	295-301	26-814669	REC26-814669	303	27-11885	REC6F5-45113-A0	251-258
25-86203	REC25-86203	181	26-814669A2	REC26-814669A2	174-176-188-189-302	27-134612	REC27-134612	279
25-86203	REC25-86203	295	26-814670	REC26-814670	303	27-13461A99	REC27-13461A99	256-261
25-887812	REC93210-25552	238	26-815449	REC26-859093	263-265	27-13937-6	REC27-139376	279
25-88955	REC335523	263-265	26-816464	REC26-816464	238	27-13958-1	REC27-139581	276
25-89497	REC25-89497	263	26-816464-1	REC26-816464-1	303-305-307-327-335-337	27-14318-3	REC27-14318005	167
25-896322	REC25-36318	307	26-816575A2	REC26-816575A2	307-337	27-14697A87	REC27-14697A87	257-261
25-896523	REC25-896523	307	26-816575A4	REC26-816575A4	175-176-336	27-15172-3	REC27-151724	279
25-896524	REC25-31534	335	26-816575A5	REC26-816575A5	175-176-336	27-16158	PAF6-03000003	68-289
25-8M0000190	REC25-8M0000190	309	26-820645A1	REC26-820645A1	174	27-16160	PAT5-03000006	68-289
25-8M0052669	PAJASOF40431-025	205	26-821092	REC26-821092	238	27-16164	PAT5-03000005	289
25-8M0142840	REC25-8M0142840	309	26-821309	REC26-821309	301	27-16717M	REC696-45113-00	259
25-90011	REC25-90011	263-335-337	26-821310	REC26-821310	301	27-18785T	REC27-18785T	254-261
25-95602M	REC93210-42M70	247	26-82165M	REC93101-14M01	247	27-18786T	REC27-418786T	255-261
25-97386	REC310414	305	26-821928	REC26-821928	293	27-18937M	REC6E7-11181-00	254
25661-1	PH375-0011	132	26-82226M	REC93101-15074	320-321	27-19138M	REC689-11181-00	254
26-11464M	REC93101-11M23	320	26-82228M	REC93101-18050	321	27-19175	REC676-45114-A1	277
26-11731M	REC93102-35M18	251	26-82229M	REC93101-20048	323	27-19202	REC27-19202001	68-182-293
26-11758M	REC93101-30M33	251	26-82233M	REC93101-22067	325-333	27-19202	REC27-192043	182
26-12224	REC26-12224	189-335-337	26-82234M	REC93101-23070	333	27-19204-3	REC27-192043	293
26-12709	REC26-12709	238	26-82250M	REC93103-10052	315	27-19205-1	REC27-19205002	166
26-14077	REC26-76868	238-337	26-82251M	REC93103-11051	315	27-19551	REC27-19551	183-327
26-14195M	REC93102-20M25	245-247	26-82257M	REC93106-09014	333	27-19552	REC27-19552	327
26-14240	REC26-14240	238	26-822647	PAF166-010003	217	27-19553	REC27-19553	183-327
26-16051	REC26-16051	244	26-822647	PAPS2700.04.03	211-221	27-19701	REC27-8M4502052	303
26-16162	REC26-16162	289	26-825027	PAF25-05020003	217	27-25725	REC27-25725	154
26-16168	PAT5-03000013	289	26-825048	PAF25-05050021	217	27-25848	REC27-25848	107
26-16171	PAT5-03000014	289	26-825455	PAF15-07040008	211	27-25849	REC27-25849	107
26-16703	REC26-16703	204	26-825455001	PAF8-05030011	207	27-27936-1	REC27-279361	279
26-16977	REC26-16977	177-238-263-335	26-830749	REC26-830749	307	27-29166	REC27-29166	154
26-18816	REC26-807006	238	26-830749A01	REC26-830749A01	189-190-307	27-29586	REC27-29586	347
26-18843M	REC93101-20M29	243-247	26-830898	REC26-830898	263-265	27-31402	REC27-31402	278
26-189721	REC93104-16M01	251	26-832013	PAF25-05020002	217	27-32438	REC27-32438	183
26-20070	REC908855	176-238	26-83406M	REC93101-22067	329-331	27-327674	REC327674	275
26-24590	REC26-24590	176-177-238	26-84022M	REC682-44365-00	345	27-32771	REC27-32771	184
26-30900	REC327031	317	26-84813M	REC93101-20M07	325	27-38501-1	REC27-385011	275
26-30913	REC26-30913	176-238-317	26-84818M	REC689-44366-00	325	27-39401	REC27-39401	259
26-32511	REC26-32511	238	26-850850	PAF15-07010014	209	27-39402	REC27-39402	276
26-32911	REC26-55682	238	26-85090	REC26-85090001	295	27-39623	REC27-396231	182
26-33467	REC26-33467	238	26-85090A1	REC26-85090A1	174-176-295	27-39625	REC27-39625	182
26-33613	REC26-33613	293-317	26-85090A2	REC26-85090A2	174-176-295	27-39626	REC27-39626	182
26-36556	REC26-36556	347	26-85107	REC26-00173	238	27-41245-1	REC27-41245-1	255-261
26-36558	REC26-36558	317	26-852859	PAF15-02000006	345	27-41246-1	REC27-41246-1	255-261
26-38452	REC26-38452	327-347	26-85370711	REC26-85370711	244	27-41273M	REC689-44324-A0	325
26-38970	REC26-38970	335-344	26-8537077	REC26-8537077	204-241	27-41417-2	REC414172	278
26-41131	REC26-76127	177-295	26-8540171	REC93101-17054	323	27-41418-1	REC414181	278
26-41132	REC26-41132	295	26-8545680	PAF15-07030006	209-241	27-41475-8	REC414758	274
26-41365-1	REC26-413651	293	26-855681	PAF15-07030007	209-241	27-41491	REC414991	274
26-41365A3	REC26-41365A3	174-176-293	26-855681001	PAF8-05010012	207	27-41499A87	REC27-41499A87	255-260
26-41953	REC26-419533	238	26-880596502	REC26-880596502	87-88-89-97	27-41670-3	REC27-41670006	258
26-41953 3	REC26-419533	263	26-880629	REC26-880629	274	27-41899M	REC689-W0001-C2	325
26-42102-1	REC26-421021	293	26-88397	REC26-88397	345	27-42364A92	REC27-42364A92	255-260
26-42133	REC26-42133	293	26-888483	REC26-888483	307	27-42631-1	REC27-426311	183-335
26-43035	REC26-43035	305	26-888593	REC26-888593	70-81	27-43004-1	REC27-43004009	276
26-43035A4	REC26-43035A4	174-176-189-304	26-888660	REC69J-41138-00	277	27-43004-1	REC646-14623-A1	277
26-43036	REC26-43036	177-238-305	26-888906	REC26-888483	307	27-43004A99	REC27-43004A99	253-256-260-261
26-43943	REC26-43993	238	26-888920	REC26-888920	307	27-43004A99	REC27-43004A99	252
26-43993	REC26-43993	252-263	26-888921	REC26-888921	307	27-430057	REC27-430057	170
26-45587	REC26-45587	238	26-89236	REC26-70080	189-238	27-43006-8	REC27-430068	167
26-55682	REC26-55682	238	26-89238	REC26-89238	177-238-335	27-43007-3	REC27-430075	259
26-55682A1	REC26-55682A1	175-176-334	26-89238A2	REC26-89238A2	175-176	27-43008	REC27-430086	276
26-56397	REC26-56397	238-164-363	26-896524	REC25-31534	307	27-43033-1	REC27-430331	183-305-307-337
26-56788	REC320961	238	26-8M0032912	REC26-8M0032912	229	27-43034-1	REC27-8172771	183
26-62818	REC26-62818	238	26-8M0142851	REC26-8M0142851	309	27-43047-2	REC27-430472	183-305
26-66022	REC26-66022	293-317	26-8M0142979	REC26-8M0142979	175-190-309	27-43337-4	REC27-433374	275
26-66301	REC26-66301	263-264	26-8M2014338	REC26-8M0142851	345	27-43777-2	REC27-437772	262
26-66302	REC26-66302	263-264-337	26-90063	REC26-897153	238	27-43779-2	REC27-437792	262
26-66303A1	REC26-66303A1	175-176	26-90562	REC26-90562	176-177-238-327	27-43779A87	REC27-43779A87	256-260
26-68493	REC26-823894	238	26-91726M	REC93101-10M14	319	27-46351	REC27-46351	154
26-69188	REC26-69188	176-177-188-189-238-301-303-327	26-94038	REC26-94038	177-238	27-47190	REC27-47190	154
26-69189	REC26-69189	176-177-188-189-238-301-303-327	26-94626M	REC683-44365-01	323	27-48164-1	REC27-481641	279
26-70081	REC26-70081	177-189-238-305	26-94663M	REC93210-42159	245	27-48801	REC27-48801	277
26-72785	REC26-72785	238	26-95472M	REC93101-10M25	243	27-55279-1	REC27-552791	279
26-76868	REC26-76868	238-305-335-337	26-96063	REC26-897153	317	27-62107	REC27-62107	279
26-77066A1	REC26-77066A1	174-176-317	26-96317M	REC93101-13M12	319	27-62386	REC13350	162
26-79831	REC26-79831	176-177-238-327	26-99031M	REC6E7-44366-00	323	27-62386	REC27-62386001	166-169
26-79831A1	REC26-79831A1	174-176-327	26-99325	REC26-99325	295	27-62860-1	REC27-628601	258
26-80239M	REC626-44365-01	323-325	27-11338A88	REC27-11338A88	257-261	27-65744-2	REC27-657443	280
26-803514	REC26-803514	204	27-11454M	REC6G1-11193-A1	169-245	27-66847	REC27-66847	167-275
26-80397M	REC646-44365-00	315	27-11456M	REC6G1-41112-A1	169-245	27-67275-1	REC27-672751	280
			27-11456M	REC6G1-41114-A0	245	27-67751-1	REC27-677511	279
			27-114749M	REC6F6-11193-A1	251	27-69238-1	REC27-692381	276
			27-11500M	REC6G1-24431-01	89	27-69524-2	REC27-695242	275
			27-11560M	REC6G1-45113-A1	245	27-69525-2	REC27-695252	275
			27-11568M	REC6G1-41133-A0	274	27-70335-1	REC27-703351	275
						27-72486A32	REC27-72486A32	256-260

RO/OEM	REF		RO/OEM	REF		RO/OEM	REF	
27-733771	REC27-733771	279	27-835383001	PAF15-07000017	278	27-8M6000366	REC27-8M6000366	234
27-75786	REC27-75786	277	27-835427003	PAF8-00000004	207-236	27-90430-1	REC27-904301	280
27-75791	REC27-757911	278	27-8354272	PAF15-00000014	209-236-237	27-90484-1	REC27-904841	276
27-75909	REC27-75909	259	27-835427A00	REC66M-W0001-01	208-235-237	27-90484A88	REC27-90484A88	257-261
27-76636	REC27-76636	280	27-835427A04	REC3V1-87121-0	235-237	27-91746M	REC6E0-24435-00	89
27-76952	REC27-76952	279	27-83865M	REC679-44316-A0	331	27-91754M	REC6E0-24434-00	89
27-78028A78	REC27-78028A78	256-260	27-83940M	REC27-83940	167	27-91780	REC6E0-45113-A1	243
27-78069	REC27-8231422	259	27-83940M	REC682-12414-A1	167	27-91780M	REC6E0-45113-A1	258
27-78246	REC27-782461	276	27-83951M	REC682-41114-00	169	27-92648M	REC698-W0001-21	332
27-78409	REC27-78409	276	27-83955M	REC682-41133-A0	274	27-93536-1	REC27-935361	280
27-78410	REC27-78410	262	27-84024M	REC682-44315-00	323	27-95220	REC90430-08020	289
27-78411	REC27-78411	276	27-84075	REC683-45315-A0	323	27-9529001	REC309-01005-2	254
27-78690	REC27-78690002	167-280	27-84264M	REC677-24435-01	89	27-95418M	REC679-45315-A1	329
27-78690002	REC27-78690002	167	27-84741M	REC689-41114-A0	170	27-95595M	REC677-11181-A0	247-254
27-79583-1	REC27-79583-1	255-261	27-847525-1	REC847525	280	27-95597M	REC677-41112-A0	247
27-79583A81	REC27-79583A81	258-261	27-84775	REC61T-45113-A0	259	27-95610	REC90430-06M03	321
27-79650-1	REC27-796501	258	27-850283	REC27-850283	280	27-95610M	REC90430-06M03	329
27-803508	REC27-803508	234	27-850836	PAF15-07000100	211-234-237	27-95610M	REC90430-08020	329
27-803508017	PAF8-05000002	207-239	27-850836001	PAF8-05000100	207-234-237	27-95656M	REC689-44316-A0	325
27-803663	REC350-01005-0	254	27-85087	REC27-85087	182	27-96278	REC27-96278	262
27-803663018	REC351-01005-0	254	27-853523	PAF15-07040016	211-241	27-96281T01	REC27-96542-1	254
27-803663021	REC3B2-01005-0	254	27-853523001	PAF8-05030012	207-241	27-96295	PAF4-03000011	319
27-8041151	REC67F-11181-03	234	27-853525001	PAF8-05000009	278	27-96300	PAF4-03000018	319
27-804345A02	REC67F-W0001-00	225-236	27-853702	PAF8-05010005	204	27-96324M	REC6E0-W0001-C1	319
27-80613M	REC648-24434-01	90	27-853702005	PAF8-05010005	166-207	27-96542-1	REC27-96542-1	254
27-80614M	REC648-24435-02	90	27-8547801	PAF25-05010108	215	27-96602M	REC682-11351-A0	258
27-81031M	REC655-12414-A1	166	27-85487	REC27-85487	262	27-96618	REC682-45113-A0	277
27-812370	REC27-821370	279	27-85490-2	REC27-856729	262	27-96656M	REC689-41112-A0	170
27-81254M	REC663-11193-00	262	27-85491-2	REC27-854913	170	27-96761-1	REC27-967611	280
27-81266M	REC663-12414-00	167	27-85491A90	REC27-85491A90	255-260	27-97704M	REC6E9-11193-A0	262
27-812775-4	REC27-812775A01	276	27-85492-2	REC27-854924	275	27-97706M	REC6E9-12414-A1	251
27-812775-5	REC27-8127755	276	27-85608-1	REC27-856081	184-335	27-98185	REC951853	262
27-812867-1	REC27-8128671	167	27-85610-1	REC27-856704	184	27-981853	REC951853	262
27-8128672	REC27-8128672	167	27-85653-1	REC27-856730	276	27-98769-1	REC27-987691	279
27-812867A97	REC27-812867A97	249-256	27-85653A87	REC27-85653A87	257-261	27-99049M	REC683-W0001-21	322
27-812868	REC27-812868	279	27-856542-1	REC856542	280	27-99173-2	REC27-991734	276
27-812869	REC27-812869	279	27-857078	PAF60-05000004	170	27-99176-3	REC27-991761	259
27-8129391	REC346-01005-0	254	27-857081	REC8M0045278	234	27-99177-2	REC27-991772	259
27-81293910	REC3C8-01005-4	254	27-858524	REC27-858524	184-335	27-993163	REC27-993163	280
27-813331M	REC663-41114-00	170	27-8587321	REC68V-11351-00	237	27-99326-1	REC27-993261	182-295
27-813500M	REC6A1-W0001-23	315	27-858732T01	REC67F-W0001-00	236	27-99776-1	REC27-997761	259
27-813859	REC27-883775	280	27-858732T02	REC67F-W0001-00	236	27-99911M	REC6E0-11193-A1	243
27-813932-2	REC813932	259	27-859352	REC67C-11351-00	237	27-99993M	REC6E0-41114-A1	243
27-81417M	REC663-44315-A0	333	27-859352A02	REC67C-W0001-01	219-235-237	27-99995M	REC6E0-41112-A1	169-243
27-81418M	REC663-44316-A0	333	27-87736-1	REC27-877361	280	2704-821896A4	REC2704-821896A4	269
27-814195-1	REC27-8141951	280	27-880552A06	RM27-880552A07	236	2704-826191A4	REC2704-826191A4	269-271
27-81421M	REC663-44324-00	333	27-880552A07	RM27-880552A07	231	2704-826191T4	REC2704-826191T4	271
27-81440M	REC663-45123-00	275	27-880624003	REC27-880624003	237	2720-881054T10	REC2720-881054T10K	271
27-81440M	REC688-45123-00	275	27-880729	REC27-880729	307	2720-881054T3	REC2720-881054T10K	268
27-814555M	REC6E9-12414-A1	167	27-881325	REC68V-14984-00	87-88-97	2720-881055T10	REC2720-881055T10K	271
27-814754A00	REC27-814754A00	257-261	27-881325001	REC6C5-14984-00	87-97	2720-881055T3	REC2720-881055T10K	268
27-81570M	REC664-41114-A0	170	27-883213	REC27-883213	87-97	28-16155	PAT5-03000009	289
27-815791A92	REC27-815791A92	257-261	27-883252	REC27-883252	97	28-18856M	PAF4-04000019	217
27-817277-1	REC27-8172771	305-307-337	27-88449	REC27-88449	262	28-19699	REC28-8M0032831	346
27-819113	REC819113	279	27-88449A32	REC27-88449A32	256-260	28-30281	REC28-30281	327-335
27-819114	REC819114	279	27-88451-1	REC27-884511	258	28-42376A2	REC28-42376A2	68-293-346
27-81987	REC90430-08020	319-321-322	27-887810011	REC69J-11351-11	237	28-43037	REC28-8M0032833	305-307-337-346
27-81987M	REC90430-08020	315-320-325-333	27-887810A04	REC6P2-W0001-01	233-236-238	28-43037	REC28-8M0032833	346
27-822189	REC27-822189	69-183-301-303	27-887825	REC887825	170	28-56654	REC8M0032834	335-346
27-822217	REC27-822217	183-301	27-887848	REC69J-11181-03	233-235-238-240-261	28-56662	REC8M0032837	346
27-822420A94	REC27-822420A94	255	27-887848-1	REC69J-11182-03	233-235-238-240	28-803556	PAF8-05030007	207
27-822844T04	REC27-822844T04	254-261	27-888658	REC69J-41134-A0	277	28-803749	REC28-803749	346
27-823700-2	REC823700	259	27-8886586	PAF15-04000003	81	28-81603M	REC664-44338-00	325
27-824853	PAF15-07010022	166-209-215	27-888658A04	REC69J-W0001-20-00	175-190-313	28-81912M	REC90280-03024	320-321-323-333
27-825032	REC27-825032	234-238	27-889319	REC27-889319	97	28-81916M	REC90282-04010	325-329-333
27-825040	PAF15-07010009	209	27-889561	REC27-889561	274	28-822651	PAF15-07040007	211-217
27-8252310	PAF25-00000013	215	27-889618001	REC27-889618001	274	28-825666	PAGB/T1099-3X5X13	211
27-8254821	REC6G8-11181-A1	205-234	27-89221-1	REC27-892211	279	28-825666001	PAF4-04000019	207
27-825693	REC6G8-41112-02	205	27-89221A88	REC27-89221A88	257-261	28-83444M	REC90280-04M00	331
27-825701	REC6G8-12414-A0	205	27-892320	REC892320	274	28-85119	REC28-8M0032838	346
27-825847	REC6G8-11351-A0	205-236-237	27-895374006	RM27-8M0033476	235	28-8M0032831	REC28-8M0032831	303-346
27-825847A95	REC6G8-W0001-A3	205-235-237	27-895822	REC27-895822	274	28-8M0032837	REC8M0032837	346
27-826549	REC826549	259	27-896142	REC27-896142	237	28-8M0032838	REC28-8M0032838	295-301-346
27-826738	REC826738	275	27-896142A06/07	RM27-896142A07	229-236-238	28-95229	PAT3.6-04000006	207
27-826991M	REC664-41134-A0	275	27-897534	REC27-8M0024563	237	2806-	PAF25-05010000	215
27-827176M	REC6E9-41114-A0	170	27-897534A07	REC27-897534A07	226-235	0830267T3		
27-827284	REC27-827284	167	27-89937	REC27-89937	258	29-13304M	REC93310-727V7	251
27-827610	PAF25-05050007	215	27-8M0024563	REC27-8M0024563	237	29-47270	REC29-47270	268
27-828553A97	REC27-828553A97	256	27-8M0024565	RM27-8M0024565	234	29-67483	REC29-67483	266-268-269
27-828816	REC27-828816	81	27-8M0045278	REC8M0045278	234	29-818391	REC29-818391001	269
27-830270A98	PAF25-05040000	215-234	27-8M0057703	REC27-8M0142616	183	29-822553	REC29-822553	266-268-271
27-830298	PAF25-05010111	170-215	27-8M0057703	REC27-8M0057703	237	29-82350M	REC93602-14118	247
27-832934A00	REC27-832934A00	257	27-8M0057763	REC27-8M0057763	227-236	29-82353M	REC93603-21111	251
27-83338M	REC676-41112-A0	170	27-8M0062091	REC3C8-01005-4	254	29-84803M	REC93315-017U4	325
27-83383M	REC676-41133-A0	275	27-8M0069692	PAF25-00000013	236	29-88258	REC29-88258	252-269
27-83398M	REC676-44315-00	331	27-8M0075040	REC27-8M0075040	182	29-88258001	REC29-88258	268
27-83399M	REC676-44324-A0	331	27-8M0118180	REC67C-11181-01	234	30-11766T	REC93306-307U0	251
27-834777	REC67C-11181-01	234	27-8M0135597	REC27-8M0135597	87-97	30-11767T	REC93306-306V1	251
27-834952	PAF15-07010018	169	27-8M0135806	REC27-8M0135806	182	30-16049	REC30-16049	242-244-263
27-834952001	PAF8-05010004	169-207	27-8M0135806	REC27-8M0135806	182	30-16049T01	REC30-16049T01	248
27-834952002	PAF15-07010018	209	27-8M4502052	REC27-8M4502052	69-183	30-16132	PAGB/T276-6002	289
			27-8M6000365	REC27-8M6000365	227	30-1628	PAGB/T276-6004	289

RO/OEM	REF		RO/OEM	REF		RO/OEM	REF	
30-18859M	REC93306-204U0	243-247	32-83451M	REC676-44361-00	331	35-825467T02	REC668-13440-00	80
30-20839T	REC30-20839T	301-303-327	32-83452M	REC676-44361-10	331	35-825467T1	REC668-13440-00	80
30-30956	REC387247	337	32-84028M	REC682-44361-01	323	35-826964T	PAF15-07080000	78
30-62567T	REC30-62567T	263	32-84029M	REC682-44361-10	323	35-851848003	PAF8-05000024	207
30-63742	REC377139	263	32-88005	REC32-88005	151	35-853333T	REC35-853333T	79
30-63742T	REC377139	263	32-88006	REC32-88006	151	35-853733A2	REC35-8M0088825	78
30-64424	REC30-64424T	263	32-895153	PAF8-05000017	207	35-853733T02	REC35-8M0088825	78
30-64424T	REC30-64424T	263	32-94625M	REC683-44362-01	323	35-853733T03	REC35-8M0088825	78
30-67923	REC30-67923T	263	32193A2	REC1463-9382	119	35-8548091	PAF25-05010107	215
30-67923T	REC30-67923T	263	33-11458M	NGKBR6HS-10	245	35-877761K01	REC35-877761Q01	80
30-8037331	PAGB/T276-6204	291	33-41263M	NGKBR7HS-10	245	35-877761Q01	REC35-877761Q01	80
30-82291T	PAGB/T276-6004C2	319	33-803507	NGKDCPR6E	204-207	35-877767K01	REC35-896546T	80
30-82295M	REC93306-00612	325	33-82370M	NGKBR7HS-10	247	35-877767Q01	REC35-896546T	80
30-82296M	REC93306-00702	329-333	33-82371M	NGKBR7HS	251	35-877769Q01	REC35-883701K01	80
30-82299M	REC93306-204U0	245	33-827858	NGKDPR7EA-9	211-215	35-87946Q04	REC35-87946Q04	78
30-8528001	REC93306-00501	323	33-8M0057936	NGKZFR5F	69-122-227	35-87946Q3	REC35-87946Q04	78
30-8528001	REC93306-00519	321	332-2910	PH350-0003	138	35-879884T	PAF15-07080000	78
30-88957T	REC30-88957T	335-337	332-2986A21	REC332-2986A27	142	35-879885T	REC35-879885T	77
30-95347	REC30-95347	289	332-2986A22	REC332-2986A27	142	35-881323001	REC6C5-13915-00	78-87-88
300-8M0044991	REC300-8M0044991	118-227	332-2986A25	REC332-2986A27	142	35-881323T	REC68V-13915-00	79-88
300-8M0088059	REC300-8M0088059	146	332-2986A27	REC332-2986A27	142	35-883701K01	REC35-883701K01	80
30185T3	GS31079	73	332-4911A2-3-5-8	REC332-4911A8	141	35-884380T	RAC31871	78
30185T3	GS31080	73	332-5524, A1	REC300-01852	142	35-884380T	REC35-8M0122423	78
3030T/M	REC663-85540-15	142	332-5524A1-2	REC339-6222A10	140	35-888279	REC69J-24501-10	78-82
31-12576	REC31-12576	305	332-5772A1	REC300-03107	141	35-888279001	REC69J-24502-10	78-81
31-12578T	REC31-12578T	305	332-5772A2	REC300-03107	141	35-888289T2	REC65L-24563-00	77-82
31-13300T	REC93332-000UE	251	332-5772A3	REC300-03107	141	35-892758001	REC6C5-24251-00	77-81
31-16052	REC31-16052	244-248-267	332-5772A5	REC300-03107	141	35-893318T02	REC35-893318T02	70-79
31-16756A4	REC31-16756A4	265-267	332-5772A7	REC300-03107	141	35-895152002	PAF8-05000800	207
31-16756A6	REC31-16756A6	263-271	332-7778, A1, A3, A5, A6, A9, A12, A14	REC300-01852	142	35-896247	REC35-896247	69-79
31-17514A1, A2	REC31-17514A2	267	338-4733A2	REC332-4911A8	141	35-896546T	REC35-896546T	80
31-21700	REC31-21700	301-303-327	339-5212A1	REC339-6120A1	144	35-897575T01	RM35-8M0082911	79
31-21739	REC31-21739	295-303-327	339-5287	REC339-6222A10	140	35-897575T02	RM35-8M0082911	79
31-30894A1	REC31-30894A1	305-335-337-339-340-341	339-5313A1	REC339-6120A1	144	35-898101T68	REC35-8M0088825	78
31-30895	REC31-30895T	305	339-5589A1	REC339-6120A1	144	35-8M0020349	RAC31871	78
31-30895T	REC31-30895T	335-337	339-5590A1	REC339-6120A1	144	35-8M0020349	REC35-8M0122423	78
31-30956	REC387247	305	339-6119A1	REC339-6120A1	144	35-8M0088825	REC35-8M0088825	78
31-30956T	REC387247	335	339-6120A1	REC339-6120A1	144	35-8M0095658	REC35-8M0157620	74
31-32898T	REC31-32898T	335	339-6120A1-4-6-8-10	REC339-6222A10	140	35-8M0101436	REC6D8-W524A-00	78
31-35928A1/T1	REC31-35928T1	337-340-341	339-7370A13	REC300-08309	117	35-8M0117705	REC6D8-W524A-00	78
31-36387A1	REC31-36387A1	335-337	339-7452 A2, A3	REC899883230	141	35-8M0123025	REC35-8M0123025	70-80-82-83
31-38356A1	REC31-38356A1	327	339-7452A19	REC339-7452A19	141-147	35-8M0134466	REC35-8M0134466	68-78-81
31-41326	REC31-41326	295-301	339-778A1-3-5-6-9-12	REC339-6222A10	140	35-8M0149607	REC35-8M0149607	77-81
31-42647A1	REC387817	307-335-337	339-803559A02	PAF8-05000500	117	35-8M0157133	REC16910-GB2-005	77
31-42677A1	REC31-42677A1	305	339-803706A1	REC8M0071855	116	39-11462M	REC661-11610-00	243
31-43012A1,A2	REC31-43012A1	267	339-803844T01	REC803844T01	116	39-11768T	REC6F5-11610-00	251
31-43012T3	REC31-43012T3	267	339-804271T	REC67F-85570-00	118	39-11769M	REC6F5-11610-10	251
31-54928-1	REC382343	335	339-804271T	REC67F-85570-00	118	39-11770T	REC6F5-11610-20	251
31-62596A1	REC31-62596A1	266-267-271	339-825101T	REC339-825101T	118	39-14197M	REC6J1-11610-00	243
31-6291T	REC31-62091T	327	339-85699A1	REC300-08310	119	39-14235M	REC689-11610-00	271
31-63079A1	REC31-53079A1	335	339-858942T1	PAF40-05000200	117	39-15320M	REC682-11610-01	271
31-67445	REC378252	267	339-859738T1	PAF25-05120000	117	39-16054A5	REC39-16054A5	248-271
31-72961	REC30-72961	242	339-877807A2	REC339-877807A2	117	39-18563A12	REC39-18563A12	271
31-74248T	REC31-74248T	265-267	339-879147T71	PAF20-05000400	117	39-18653A12	REC39-18653A12	268
31-77420A1	REC31-77420A1	303-327	339-879984A01	REC300-8M0077471	118	39-19721A6	REC39-19721A6	268-271
31-78172A1	REC31-78172A1	335	339-879984T00	REC300-8M0077471	118	39-2784112	RM39-27841A12	272
31-803675 2	REC31-8036752	267	339-879984T01	REC300-8M0077471	118	39-803678A1	REC39-803678A1	271
31-8036752	REC31-8036752	244	339-880615T01	REC339-880615T01	118	39-803678A3	REC39-803678A3	244-271
31-812767A1	REC983892	303-339-341	339-883778A02	REC339-8M0077473	118	39-80422M	REC647-11610-00	247
31-812768	REC31-812768	303	339-883778A01	REC339-8M0077473	118	39-80423M	REC647-11610-10	247
31-812873A1	REC31-812873A1	263-264	339-895110T01	PAF8-05040000	100	39-80424M	REC647-11610-20	247
31-813048	REC31-813048	244-267-271	339-895110T11	PAF8-05040000	100	39-813011A12	REC39-813011A12	269-270-272
31-813048 2	REC31-8130482	267	339-898103T	REC678-85570-01	117-119	39-817096A6	REC39-817096A6	269-271-272
31-8130482	REC31-8130482	248	339-898103T	REC678-85570-01	117-119	39-821695A4	REC39-821695A4	268-271
31-816773A1	REC31-816773A2	263-265	339-895110T01	PAF8-05040000	100	39-822321A12	REC39-822321A2	269
31-818889A1	REC31-818889A1	249	339-895110T11	PAF8-05040000	100	39-822321A2	REC39-822321A2	269
31-821321A1	REC31-821321A1	293-301	339-895110T11	PAF8-05040000	100	39-893525A01	REC67C-11603-00	242
31-82315M	REC93315-22004	325	339-895110T11	PAF8-05040000	100	39-8M0055809	REC39-8M0055809	207-242
31-82316M	REC93315-32224	331-333	339-898103T	REC678-85570-01	117-119	39-93481A12	REC39-93481A12	270-272
31-82317M	REC93317-22204	329-333	339-8M0077471	REC300-8M0077471	118	39-1100A3	REC39-1100A3	154
31-82319M	REC93332-00001	333	339-8M0077473	REC339-8M0077473	118	39-1130A1	REC39-1130A1	154
31-82320M	REC93332-00003	329-333	34127T2	CM34127	197	398-173	REC398-173	118
31-82321M	REC93332-00005	325	34127T2	CM34127A	197	398-174	REC398-174	154
31-82321T	REC93332-00005	323	345-00042-0	REC345-00042-0	248-249-271	398-2202	REC398-2202	154
31-828439A2	REC31-828439A2	337	34762A1	CM34762	197	398-4770	REC398-5255	145
31-834960	PAF15-07010024	209	34762A1	CM34762A	197	398-5255	REC398-5255	145
31-834960T08	PAF8-05010009	207	35-16248	PAF4-05000300	68-77	398-5256	REC398-5255	145
31-84086M	REC93315-317U2	323	35-18458Q4	REC35-18458Q4	74	398-5454A11-		
31-855553	REC31-855553	249	35-802893Q01	RM35-802893Q01	74	A15-A16-A30-		
31-879877A1	REC31-879877A1	266-267-271	35-802893Q4	REC24950	74	A31-A32-A34-	REC398-5454A35	144-148
31-88269T	REC5007190	267	35-80365M	REC35-80365M	77	A35-A36-A61-		
31-884325T01	REC31-884325T01	307	35-816296Q03	REC40145	77	A64-A66		
31-91721M	REC93310-112V0	243-245	35-816296Q2	REC40155	77	398-5454A2	REC398-5454A7	146
31-94769M	REC93310-418U0	247	35-822626Q03	PAF15-07010023	209	398-5454A2, A5, A6, A7, A8, A9, A17, A18, A55	REC398-5454A17	144-148-149
31-98294A1	REC31-98294A1	295	35-822626Q03	REC35-822626Q03	80			
31-98933M	PAT40-04000027	331	35-822626Q04	REC5GH-13440-00	209-215	398-5454A26	REC398-5454A26	145
31-99030M	REC93341-214U1	322	35-822626Q03	PAF25-05000100	215	398-5454A7	REC398-5454A7	146
31-99328A1	REC31-66668A1	295-301-333	35-822626Q0480	REC35-822626Q04	80	398-5704A2-		
31640Q4	CM31640	305-327-337	35-822626Q15	REC35-822626Q03	80	A4-A5-A7	REC398-5704A7	145
31640Q4	CM31640A	305-327-337	35-822626Q15	REC35-822626Q15	80			
32-16167	PAT5-03000012	289	35-822626Q2	REC35-822626Q04	80	398-693	REC398-693	154
32-80396M	REC6A1-44361-00	315	35-822626T7	REC35-822626Q15	80	398-818535A17-18	REC398-832074A4	145
			35-825467A1	REC668-13440-00	80			

RO/OEM	REF	RO/OEM	REF	RO/OEM	REF
398-818535A3-5-8-9-10-13-14-15	REC398-8778A29	43-96310M	REC6E0-45551-00	47-19453Q2	REC47-19453QZ
398-832075A20	REC398-832075A20	43-96312M	REC6E0-45560-00	47-19453T	REC47-19453T
398-832075A3-A4-A5-A6-A9-A12	PH400-0002	43-96316M	REC6E0-45570-00	47-20813	REC47-20813
398-852386A4	REC398-852386T8	43-99043T	REC6E7-45560-01	47-22748	REC47-22748
398-852386T8	REC398-852386T8	43-99044T	REC6E7-45570-00	47-42038-2	REC47-420382
398-852387A4	REC398-852387T9	43012A 1	REC31-43012A1	47-42038Q3	REC47-42038Q3
398-852387T9	REC398-852387T9	43013T 3	REC31-43013T3	47-42038T4	REC47-42038Q3
398-855721A4	REC398-855721T8	43023-2	REC43023-2	47-43026Q06	REC47-43026Q06
398-855721T8	REC398-855721T8	43026T2	REC47-43026Q02	47-43026T11,T8	REC47-43026Q06
398-8778A10-16-17-18-21-22-23-24-25-26-27-28-29	REC398-8778A29	43055A4	REC43055A4	47-43026T2	REC47-43026Q02
398-878143T05	REC398-878143T05	430775/M	REC695-85540-11	47-803630T	REC47-803630T
398-878143T3	REC398-878143T05	43113M	REC692-24410-00	47-803748K01	REC47-803748K01
398-9610A18	REC398-9610A18	43113T	REC692-24410-00	47-803748Q01	REC47-803748K01
398-9610A3-A5-A6-A9-A14-A19-A22-A24-A33	REC398-9610A19	43242-3	REC43242-3	47-803748Q01	REC47-803748K01
398-9710A11-12-14-15-22-23-25-28-30-31-33-34-36-38-39-43-45-46-47-48-49	REC398-832074A4	43242-5	REC43242-5	47-80395M	REC646-44352-01
398-9873A22-A28	PH400-0002	43242-6	REC43242-6	47-81423M	REC6H3-44352-00
398-9873A9-17-19-24-25-28-29-32-33-35-38-39	REC398-832074A4	43242-9	REC43242-9	47-82824M	REC6H3-44352-00
40-825017	PAF25-05020106	44-11599M	REC6G1-45611-01	47-84027T	REC682-44352-01
40-893529	PAF25-05020106	44-12238T	REC44-12238T	47-84797M	REC689-44352-02
400-834957	PAF15-07030000	44-19124M	REC689-45611-00	47-85089-10	REC47-8508910
400-834957T01	PAF8-05020001	44-195133	PAT5-03000400	47-85089-3	REC47-8508910
41-11771T	REC6F5-11633-00	44-81472M	REC697-45611-00	47-85089Q4	REC47-85089Q4
41-16041	REC41-16056	44-824110	REC44-824110	47-85089T7	REC47-85089T7
41-803680002	REC41-803680002	44-84078M	REC683-45611-00	47-89980	REC47-89980
41-803680003	REC41-803680003	44-850308	REC44-850308	47-89980T1	REC47-89980T1
41-80368003	REC41-16056	44-94148	REC44-94148	47-89981	REC47-89981
41-8036801	REC41-8036801	44-94531M	REC679-45611-00	47-89981Q1	REC47-89981Q1
41-825016	PAF25-05020105	44-96314M	REC6E0-45611-01	47-89981T2	REC47-89981Q1
41-825713	PAF15-07020006	45-16135 1	REC45-161351	47-89982	REC47-89982
41-825713001	PAF8-05020105	45-16136 1	REC45-8M0076368	47-89982T1	REC47-89982T1
41-825713002	REC41-825713002	45-81451M	REC663-45510-01	47-89983Q1	REC47-89983Q1
41-893863	PAF25-05020105	45-816472	REC45-816919	47-89983T	REC47-89983T
41-95601M	REC6G1-11633-00	45-83867M	REC679-45501-10	47-89983T2	REC47-89983T2
41305M	REC696-85540-12	45-84801M	REC689-45501-10	47-89983T3	REC47-89983T3
41884M	PAG6B/T5783-M8X55	45-854808A1	REC45-854808A1	47-89983T4	REC47-89983T4
42121A2	CM42121	45-858765T1	REC45-858765T1	47-89984Q5	REC47-89984Q5
42121A2	CM42121A2	45-859105A1	REC45-859105A1	47-89984T4	REC47-89984T4
42431M	REC689-W0078-A6	45-875222A1	REC45-875222A1	47-89984T6	REC47-89984T6
42461A1	REC42461A1	45-878575T1	REC45-878575T1	47-8M0142980	REC47-8M0142980
42600A1/3/5/09	REC42600A09	45-96307M	REC6E0-45511-01	47-95289	REC47-952892
42647A1	REC387247	45-96308M	REC6E0-45511-11	47-95611M	REC662-44352-01
42909A3	REC42909A3	45-99032M	REC6E7-45501-00	47-96305M	REC6E0-44352-00
42943A 1	REC42943A1	46-16156	PAF6-03000001	47-97108M	REC6H3-44352-00
42943A1	REC42943A1	46-42040A5	REC46-42040T5	47-99971M	REC6F5-44352-00
43-11579M	REC6N0-G5551-00	46-42040T5	REC46-42040T5	48-13700A46	SOL1511-153-19
43-11595M	REC6N0-G5560-00	46-42089A2	REC46-42089A2	48-13700A46	SOL1511-153-19
43-11647M	REC6N0-G5571-00	46-42089A5	REC46-42089A5	48-13701A46	SOL1511-153-19
43-16138	REC43-16138	46-42579A3	REC46-8M0077147	48-13701A46	SOL1542-150-19
43-44104T2	REC43-44104T2	46-43024A7	REC46-43024A7	48-13701A46	SOL1572-153-19
43-803498T1	REC43-803498T1	46-60366Q1	REC46-60366Q1	48-13702A46	SOL1572-153-21
43-803499T1	REC43-803499T1	46-60366T1	REC46-60366T1	48-13703A46	SOL1572-150-21
43-80405M	REC646-45551-00	46-60367A1	REC46-96148A8	48-13704A46	SOL1571-148-23
43-80406M	REC646-45560-00	46-70941A1	REC46-70941T01	48-13705A46	SOL1572-148-23
43-80542M	REC647-45560-00	46-70941A3	REC46-70941A3	48-16986A46	SOL1431-135-15
43-80544M	REC647-45570-00	46-73640A1	REC46-73640A1	48-16988A46	SOL1431-133-17
43-822163T1	REC43-822163T1	46-73640A2	REC46-73640A2	48-16990A46	SOL1431-130-19
43-82542M	REC647-45551-00	46-77177A1	REC46-77177A1	48-16992A46	SOL1431-130-21
43-828073A1	REC43-828073A1	46-77177A3	REC46-77177A3	48-17312A46	SOL1431-140-11
43-834955	PAF15-07030003	46-77822A1	REC46-77822A1	48-17314A46	SOL1431-138-13
43-834955001	PAF8-05010014	46-7822A1	REC46-7822A1	48-18278A46	SOL1511-155-17
43-834973	PAF15-07040018	46-812966A11	REC46-812966A12	48-18278A46	SOL1571-155-17
43-834973001	PAF8-05030400	46-812966A12	REC46-812966A12	48-19636A10	SOL1211-110-09
43-83877M	REC679-45560-00	46-812966A7	REC46-812966A7	48-19638A40	SOL1211-105-11
43-83879M	REC679-45571-00	46-81416M	REC663-44311-02	48-19639A40	SOL1211-103-12
43-84206M	REC697-45560-00	46-81422M	REC663-44311-02	48-19640A40	SOL1211-101-13
43-84207M	REC697-45570-00	46-821307A2	REC46-821307A2	48-19642A40	SOL1211-100-14
43-84208M	REC697-45551-00	46-826053T	PAT5-03000201	48-19838A46	SOL1511-158-15
43-84806M	REC689-45551-00	46-83396M	REC676-44311-00	48-19841A46	SOL1512-158-15
43-84808M	REC689-45560-00	46-83864M	REC679-44341-00	48-73140A40	SOL1311-110-15
43-84810M	REC689-45571-00-00	46-84277M	REC682-W0078-A1	48-77338A45	SOL1411-140-11
43-859321A3	REC43-859321A3	46-84277T	REC682-W0078-A1	48-77338A45	SOL1413-133-13
43-86869M	REC6H9-45551-00	46-84277T	REC682-W0078-A1	48-77338A45	SOL1431-140-11
43-878087A2	REC43-878087A2	46-8M0061040	REC46-8M0061040	48-77340A45	SOL1411-138-13
43-8822163T1	REC43-822163T1	46-8M0113799	REC12094	48-77340A45	SOL1431-138-13
		46-93224A1	REC93224A1	48-77341A45	SOL1411-135-14
		46-95651M	REC689-44311-00	48-77342A45	SOL1411-135-15
		46-96146A6	REC46-96146A6	48-77342A45	SOL1413-128-17
		46-96148A8	REC46-96148A8	48-77342A45	SOL1431-135-15
		46-96148T1	REC46-96148T1	48-77344A45	SOL1411-133-17
		46-96299M	PAF4-03000019	48-77344A45	SOL1413-125-19
		46-99157A02	REC46-99157A02	48-77344A45	SOL1431-133-17
		46-99157T2	REC46-99157T2	48-77346A45	SOL1411-130-19
		463-9327M	REC6F6-11400-02	48-77346A45	SOL1413-125-21
		47-11590M	REC6G1-44352-00	48-77348A45	SOL1411-130-21
		47-16154 3	REC47-161543	48-77348A45	SOL1431-130-21
				48-78116A45	SOL1511-150-15
				48-78116A45	SOL1513-148-15

RO/OEM	REF	RO/OEM	REF	RO/OEM	REF
48-815083	SOL0001-073-06P	349	50-822462	PH130-0024	127
48-816702A40	SOL1311-114-12	349	50-822462T1	PH130-0024	127
48-816702A40	SOL1313-108-12	349	50-825991A2	PH130-0014	126
48-816704A40	SOL1311-111-13	349	50-830308T	PH130-0029	126
48-816704A40	SOL1313-105-13	349	50-832997 1	PH130-0031	130
48-816706A40	SOL1311-111-14	349	50-832997 2	PH130-0031	130
48-816706A40	SOL1313-105-14	349	50-833153	PH130-0030	130
48-828152A12	SOL1111-093-07	349	50-833153-1	PH130-0030	130
48-828154A12	SOL1111-093-08	349	50-833153-2	PH130-0030	130
48-828156A12	SOL1111-093-09	349	50-833153-5	PH130-0030	130
48-828158A12	SOL1111-093-10	349	50-834749	ARC5362	127
48-832828A45	SOL1511-148-17	350	50-852570T	PH130-0034	126
48-832828A45	SOL1513-145-17	350	50-853329T	PH130-0066	129
48-832830A45	SOL1511-145-19	350	50-853329T01	PH130-0066	129
48-832830A45	SOL1513-143-19	350	50-853805T03	PH130-0006	126
48-832832A45	SOL1511-143-21	350	50-853869	PH130-0009	129
48-832832A46	SOL1513-140-21	350	50-853869-T	PH130-0009	129
48-832834A45	SOL1511-142-23	350	50-854636T	PH130-0028	126
48-832834A46	SOL1512-142-23	350	50-856996T	REC86976	129
48-834850A45	SOL1513-145-17	350	50-857065	PH130-0034	126
48-834852A45	SOL1513-143-19	350	50-859168	PH130-0034	126
48-834854A45	SOL1513-140-21	350	50-859168T	PH130-0034	126
48-85632A40	SOL1311-116-11	349	50-859169T	PH130-0029	126
48-85632A40	SOL1313-111-11	349	50-859170T	PH130-0028	126
48-87818A11	SOL1311-121-09	349	50-859171T	ARC5362	127
48-87818A11	SOL1313-118-09	349	50-859377T	PH130-0033	127
48-895180A10	SOL5011-085-07	349	50-86976	REC86976	129
48-895182A10	SOL5011-085-08	349	50-87788	PH130-0010	128
48-90159A46	SOL1512-155-17	350	50-879150A85	REC50-879150A85	128
48-90159A46	SOL1572-155-17	350	50-88119	PH130-0041	127
48752T	REC48752T	335	50-881368T	PH130-0057	129
50-29105	PH130-0010	128	50-881368T1	PH130-0057	129
50-30829	PH130-0040	127	50-881368T2	PH130-0057	129
50-30842	PH130-0010	128	50-884044T	PH130-0033	127
50-31976	PH130-0010	128	50-884045T	PH130-0028	126
50-32403	PH130-0040	127	50-884238T	PH130-0046	129
50-32411	PH130-0010	128	50-888151T	PH130-0029	126
50-37274	PH130-0010	128	50-888160T	PH130-0028	126
50-37345	PH130-0040	127	50-888161T	PH130-0033	127
50-38890	PH130-0040	127	50-888333T	PH130-0074	130
50-38890A1	PH130-0040	127	50-888333T1	PH130-0074	130
50-41583	PH130-0072	127	50-892339T	PH130-0066	129
50-41583T	PH130-0072	127	50-893886T	PH130-0029	126
50-44369	PH130-0011	127	50-893888T	PH130-0033	127
50-44369A1	PH130-0011	127	50-893889T	PH130-0021	126
50-44369A1	PH130-0015	127	50-893890T	PH130-0024	127
50-44369A1	PH130-0041	127	50-893891T	PH130-0019	128
50-44415	PH130-0046	129	50-893891T	PH130-0041	127
50-45822	PH130-0010	128	50-893892T	PH130-0066	129
50-48643	PH130-0010	128	50-893897T	PH130-0028	126
50-55304A-1	PH130-0010	128	50-897525T05	REC50-879150A85	128
50-55601A	PH130-0040	127	50-897755T	PH300-0047	137
50-55601A2	PH130-0040	127	50-898103T94	REC50-879150A85	128
50-57465A1	PH130-0042	128	50-898103T95	REC50-879150A85	128
50-57485	PH130-0041	127	50-898265001	ARC5362	127
50-58330	PH130-0042	128	50-8M003398A	PH130-0021	126
50-583869	PH130-0047	128	50-8M0166297	REC50-8M0166297	129
50-60315	PH130-0041	127	50-8M0088064	REC50-8M0166297	129
50-60975	PH130-0042	128	50-8M0159603	REC50-8M0166297	129
50-616955-1	PH130-0047	128	50-90983A1	PH130-0021	126
50-65436	PH130-0041	127	50-90983T1	PH130-0021	126
50-66015	PH130-0019	128	50-92669M	PH130-0007	128
50-66015	PH130-0041	127	50-96359M	PH130-0049	126
50-66015-2	PH130-0041	127	50-97693M	PH130-0049	126
50-66015T1	PH130-0019	128	52-11597M	REC6G1-45631-00	320
50-673341	PH130-0010	129	52-42389	REC52-42389	293
50-72467	PH130-0042	128	52-812946	PAT5-03000403	289
50-73521	PH130-0011	127	52-81473M	REC663-45631-00	329-333
50-73521	PH130-0015	127	52-81473M	REC663-45633-00	329
50-73521T	PH130-0011	127	52-81644M	REC664-45631-01	325
50-77141	PH130-0046	129	52-81644T	REC664-45631-00	342
50-79472	PH130-0046	129	52-84274M	REC682-45631-00	342
50-803835T02	PH130-0061	126	52-850048T	REC52-850048T	303-305-342-343
50-804312T1	PH130-0055	129			
50-814980M	PH130-0049	126	52-853594T	REC52-853594T	335-337-342-343
50-814980M	PH130-0062	127			
50-818445-2	PH130-0023	130	52-859340T	REC52-859340T	335-337-342-343
50-818445-3	PH130-0023	130	52-96313M	REC6E0-45631-00	319
50-818445-5	PH130-0023	130	52-96313M	REC6E5-45631-00	342
50-819085	PH130-0047	128	53-11760M	REC93440-68M03	251
50-819085-1	PH130-0047	128	53-16057	PAF15-07020005	207-242
50-819085-T1	PH130-0047	128	53-16057	REC53-16057	244-248-249
50-819271	PH130-0025	128	53-29641	REC53-29641	303-305-327-335
50-819968	PH130-0009	129			
50-819968-1	PH130-0009	129	53-80678M	REC648-45633-00	325
50-819968-2	PH130-0009	129	53-81264M	REC663-11634-00	251-271
50-819968-3	PH130-0009	129	53-82331M	PAGB/T896-86	315-319
50-819968-4	PH130-0009	129	53-82331M	REC99001-06600	320
50-819968T4	PH130-0009	129	53-82334M	REC99001-08600-00	333
50-820193	PH130-0022	128	53-82342M	REC93450-13022	243-245-247
50-820193-1	PH130-0022	128	53-82343M	PAF15-07020005	209
50-820193-T1	PH130-0022	128	53-82345M	PAF15-07020005	242
50-820193A1	PH130-0025	128	53-880719	REC53-880719	307
53-8M0051043	REC53-8M0051043	307			
54-816311T	PAF8-05000025	207			
54-952245	PAF4-04000030	72-204-215-247			
54293A10	REC54293A10	134			
55278A4	REC55278A4	90-94			
55278A5	REC55278A5	90-94			
56678A1	REC56678A1	91-93-94			
57-828507 1	REC57-828507001	137			
57-82850704	REC82850704	137			
57-831294	PAF25-05000023	221			
57-835392Q	REC66M-46241-00	272			
57-880566Q14	REC57-880566Q14	137-273			
57-892318	REC892318	137			
57-895120	PAF8-05000004	207-272			
57-897574Q01	REC57-897574Q01	137-273			
57-8M0031641	REC57-8M0031641	137-273			
57-8M0065179	REC65W-46241-00	272-273			
57-8M0072670	REC57-8M0072670	272-273			
57-8M0135591	REC57-8M0135591	272-273			
57-8M0142251	REC57-8M0142251	137-273			
600-834961002	PAF8-05020200	207-242			
600-834961A1	PAF15-07020100	209-242			
629-803674	REC629-803674	248-270			
629-8036741	REC629-8036741	244-270-271			
629-813047T01	REC629-813047T01	248-270-271			
629-880855	REC629-880855	249-270			
629-9486T	REC6F5-11651-00	251			
629-9492M	REC6E0-11651-01	243-247-270			
63742T	REC377139	249			
646-818846	REC646-818845T6	271			
646-8188461	REC646-818845T6	271			
64877-1	REC648771	168			
650-825018A1	PAF25-05020200	217			
65057A1	PH375-0031	132			
652-831876A1	PAF25-05020310	217			
68100-1	REC681001	335-337			
681621, A5, A8	REC96455A9	143			
68162A3	REC96455A8	143			
68162A6	REC96455A8	143			
7-803538	PAF15-07010100	111-113			
7-98952M	REC697-45114-00	277			
700-834963	PAF15-07020001	209-242			
700-834963A02	PAF8-05020101	207-242			
700-893524T08	PAF40-05020101	242			
701-8318751	PAF25-05020301	217			
702-833098A1	PAF25-05020101	217			
705-850026A3	REC705-850026T1K	268			
705-850026A3	REC705-850026T3	271			
71-8M0142688	REC8M0142688	111			
73345A1	REC73345A1	301-303-327-344-352			
73372A1	REC96452A4	143			
73410A1	REC96452A4	143			
75282A1	REC13191Q01	352			
75692A6	REC75692A6	164-166			
75692A7	REC75692A7	164-166			
75692Q2	REC75692Q2	164-166			
76039-4	REC76039-4	303-305-327			
761-7982M-T	REC6E7-11631-00K	271			
761-8224M	REC677-11631-00K	247			
761-8225M	REC677-11635-00K	247			
761-8226M	REC677-11636-00K	247			
761-8256M	REC6E0-11631-00-98K	243-270			
761-8484M	REC689-11631-00K	271			
761-9329T	REC6F6-11631-00K	251			
761-9331T	REC6F6-11636-00K	251			
76214-4	TEN00835	201			
76214Q5	CM76214	307			
76214Q5	CM762145	337			
76214Q5	CM762145A	307-337			
765-7441T32	REC765-7441T32	268-270			
765-7441T36	REC765-7441T36	268-270			
765-7442T32	REC765-7442T32	268-270			
765-7442T36	REC765-7442T36	268-270			
765-7445A12	REC765-7445A12	268-270			
765-7445T11	REC765-7445T11	268-270			
765-7446A11	REC765-7446A11	268-270			
765-7446T12	REC765-7446T12	268-270			
766-8666T41	REC766-8666T41	269-270			
766-8667T41	REC766-8667T41	269-270			
76681A1	REC96452A4	143			
774-9009A13	REC777-9009T13	252-26			

RO/OEM	REF		RO/OEM	REF		RO/OEM	REF	
779-96152	REC779-96152	249-270-271	814576M	PAGB/T97.1-8	311	826729A/08	REC826729A10	152
779-9615T	REC779-9615T	244-270-271	814653T	REC31-814653T	309	826729A07	REC826729A10K	153
780-9229A7	REC780-9229A7	268-271	81474M	REC663-45633-00	333	826729A08	REC826729A10K	153
783-9613A1	REC783-9613A1K	271	81475M	REC663-45634-00	329-333	826729A09	REC826729A10K	153
783-9613T1	REC783-9613A1K	268-270-271	81476M	REC688-45635-00	333	826729A4	REC826729A10	152
783-9613T3	REC783-9613T3	268-271	81490M	PH130-0007	128	826729A4	REC826729A10K	153
785-9737T9	REC785-9737T9	269-270	815083A01	SOL0001-073-06P	287	826729A4/07	REC826729A10	152
785-9738T9	REC785-9738T9	269-270	815113T02	REC815113T02	116	826729AA10	REC826729A10K	153
802136A1	MP39760	131	815118M	REC6F5-15396-01-5B	251	826729T2	REC8M0143219	153
802529T02	REC803529T06	84	815279A1-2-3	REC883072T	139	826887M	CM826887M	198
802706A1	REC66M-W0093-01	92-101-103	815279A2	REC815279A2	139	826887M	PAF25-02010005	215
802733A98	PAF15-07000000	211	815279T-2-4-5	REC883072T	139	826887M	TEN00831	202
803061T1	REC803061T1	164-166	81579-1-2-3-4-5	REC883072T	139	827142M	REC6F5-11422-11	251
803529T	REC803529T06	84	81579-1-2-3-4-5	REC883072T	139	827143M	REC6F5-11432-11	251
803529T03	REC803529T06	84	81626M	PAF15-06000010-1	323	827144M	REC6F5-11442-11	251
803529T06	REC803529T06	84	816311T	PAHT-2.5X60	215-219-223-225-247	827509A10,T7	REC827509A10	119
803529T1	REC803529T06	84	816311T	REC54-816311T	223-225	827616T 1	REC493-827616T1	252-253-270
803702T	REC803702	116	816597A1	REC816597A1	345	827675A1	REC827675A1	151
803704T	REC803704	140	816770/T	PH350-0003	138	827682T	REC899106T01	84
803706A3	REC3G2-06060-2	141	817275A08	REC817275A08	187-189-191	827954T	REC2411-827954T2	249-270
803739T02	REC43-803739T03	297	817275A09	REC817275A09	187-307	827955A 2	REC827955A2	249
803740 1	PAF8-04000003	291	817275A1	REC817275A1	180-196-307-309	827955A2	REC827955A2	267
803740T02	REC43-803740T02	297	817275A1	REC817275A1	180-191-194-195-305	827955M	CM664-45371-01	325
803741 1	PAF8-04000014	291	817275A2	REC817275A2	180-337	82801M	PAT85-00000012	311
803741T02	REC43-803741T03	297	817275A5	REC817275A5	188	828151A1	REC882751A1	133
803744T03	REC879147T96	297	817275A6	REC817275A6	188-196-336	828708T	PH200-T010	152
803745 1	PAF8-04000303	291	817276-1	REC8172761	181-305-307-337	82881M	REC650-44147-00	331
803748 1	PAF8-04000200	68-291	817397 1	REC26-8173971	249	830179-2	REC883072T	139
803750A02	PAF8-04000009	179-291	818186A6	REC826729A10K	153	830179A1-2-3	REC883072T	139
8037632T03	PAF8-04040001	291	818298A1	CM818298A	198	830179T	REC883072T	139
803844T01	PAF8-05000300	119	818298A1	CM818298A	198	830250A3-T3	PH200-T003	151
80393M	REC646-44322-00	315	818349A1	REC818349T1	346	830250A6	PH200-T033	152
80394M	REC646-44322-00	315	818349T1	REC818349T1	337	830271T2	PAF25-05050100	215
804101T	REC67F-11416-00	225	818763A11/T11	REC818763A10	337	830272A1	PAF25-05000005	215
804101T10	REC67F-11416-10	225	818846T 6	REC646-818845T6	252-253	831255A 6	REC39-831255A6	249
804101T20	REC67F-11416-20	225	818903A1	PH200-T003	151	832021A1-T4-A2-T2	PH200-T003	151
804107T1	REC6D8-11603-10	225	81924M	REC90340-08002	311	832734A2	PAF25-05010109	215
804108T1	REC6D8-11604-10	225	819479A1	PH200-T003	151	83282M	REC6E5-12411-02	243
804128T	REC68V-12111-00	225	819480A1	PH200-T003	151	832990T3	PAF25-05050001	221
804278T	REC67F-81960-12	138	819762A4-A7	PH200-T003	151	832991T3	PAF25-05050002	221
804278T1	REC67F-81960-12	138	81977A8-A9	PH200-T003	151	833102T	PAF25-05000021	221
804278T11	PH375-0047	132	81990M	PAF15-04000003	225-233	83330M	TEN01166	251
804282T	PH375-0048	132	821354-2	REC8213542	181-191-193-194-301	83384M	REC676-45127-00	275
804295T	REC804295T	110-113-114	821354A04	REC821354A04	186-188-301	83386M	REC676-45128-00	275
804346T01	REC67F-W0093-00	103	821354A2	REC821354A2	185-191-193-194-301	83394M	TEN01127	251
804346T02	REC67F-W0093-00	103-225	821400A2	REC8M0098264	153	83400M	REC676-44323-00-40	331
804346T1	REC67F-W0093-00	103	821509T01	PAF40-05091400EI	133	83403M	REC676-44322-00	331
80447M	REC626-14390-90	104	821509T01	REC882751A04	133	83419M	REC676-45635-00	329
80450M	REC647-14385-00	105	821663A1	PH300-0019	136	834520T	REC854512T	142
80591M	REC648-14385-00	106	821889A9, A22, A29, A34, A38, A40, A42, A46, A50, A51	REC821889A50	149	834780T1	PAF40-05040001	221
80606M	REC648-24411-00	89	821896A 4	REC2704-821896A4	253-271	834781T1	PAF40-05040200	221
806529A1	REC1463-9382	119	821932-1	REC8219321	293	834821T	REC854513T	143
80678M	REC648-45633-00	323	822157T2	CM822157T2	197-301	834953T02	PAF15-07010019	209
80680M	REC648-45635-00	325	822157T2	TEN00829AL	301	834967A1	PAF15-07040500	211-241
807929A1	REC807929A1	179-196-337	822321A 2	REC39-822321A2	253	834967T03	PAF8-05030300	207-241
808504T1	REC66K-13915-00	79	822462T1	PH130-0024	127	835389A2	PAF15-07140000	84
808505T	REC899106T01	84	82257M	REC93106-09014	313	835389T02	PAF15-07140000	84
808505T01	REC67H-13907-00	86	822626K03	REC35-822626Q03	213	835389T1	PAF15-07140000	84
80889T01	REC63P-13907-03	85	822626K04	REC35-822626Q04	219	835467Q01	REC12-835467Q01	353
809088T01	REC67H-13907-00	86	822626Q02	REC35-822626Q02	225	838-9002A6	REC638-9002A6	252-270
809088T1	REC67H-13907-00	86	822626T7	REC35-822626Q15	233	83859M	TEN01101	329-333
80923M	REC650-45635-00	323	822777Q1	CM822777	197	83868M	REC679-45536-00	331
809463A1	PH375-0008	132	822870A1	PH200-T003	151	83880M	REC679-45331-00	329
809570-1	REC809570-1	93-105	823034T	REC803034T	140-147	83881M	REC679-44150-10	331
809664A 1	CMPNCF16A	198	82334M	REC99001-08600-00	313	83882M	REC679-44150-00	331
809885A2	PH200-T003	151	82346M	REC93501-04011	311	83883M	REC679-44152-00	331
810749-2	REC8107492	95-96-103	823547-1	REC8235471	301	84-813706A26	REC84-813706A26	125
810749-3	REC8107493	95-96-103	823547A2	REC823547A2	174	84-813715A1	REC15-203	125
810937M	REC6G1-81970-62	138	82364M	REC93606-12019	233-313	84-816492A1	REC8M0144930	159
810937T	REC6G1-81970-62	138	823653A5/A9	PH200-T008	152	84-819514T26	PH200-WHO1	151
810945M	CM6L5-45251-02	315-319	823912-1	TEN00813	202	84-826075A2	PH200-WHO1	151
811618A1	REC893929A01	151	824519-1	TEN00824	287-316	84-826802A4	PH200-WHO1	151
811990M	TEN01116	322	825045A2	PAF25-05050301	307-335-337	84-881908T	REC84-881908T3	125
812843A1	REC893929A01	151	825118T	PAT5-03000500	289	84-881908T	REC84-881908T4	125
812887-1	REC812887002	168	825212A1	REC825212T02	162	84-8M0144930	REC8M0144930	159
812929-1	REC812929-1	303	825212T02	REC825212T02	68-205	84-8M3001068	REC8M0144930	159
812945 1	REC43-8129451	289	82547A2	REC823547A2	301	84-99215A26	REC84-813706A26	125
813442A1	REC893929A01	151	825667T	REC669-85540-29	140	84019M	REC682-44176-00	323
813442A2	REC893929A01	151	826134Q	CM826134	305-307-335-337	84020M	REC682-44176-00	323
81408M	REC663-44144-01	333	826134Q	CM826134A	305-307-335-337	84022M	REC682-44365-00	323
81409M	REC663-44151-00	333	826191T 4	REC2704-826191T4K	252-253	84023M	REC682-44312-00	323
81419M	REC663-44322-00	181-196-333	826398T3	PAF25-05130000	84	84025M	REC682-44322-00	181
81420M	REC663-44323-00	181-333				84025M	REC682-44322-00	323
81426M	REC663-44366-00	313				84026M	REC682-44323-40	181
814453M	REC6A1-W0078-01	184				84064M	PAF15-06070002	323
81445M	REC6A1-W0078-01	315				84072M	REC683-44373-00	323
81446M	REC663-45331-00-94	333				84076T	REC683-45361-01-40	323
814481M	REC6E7-W0093-01	101-104				84141M	REC663-24411-00	89
81448M	REC663-45375-00	331				84188T	REC663-W0078-01	187-196-332
81449M	REC663-45376-00	331				842121M	REC682-44323-40	323
81454T01	REC6F5-12411-03	162-251				84262M	REC677-24411-02	89
						84265M	REC677-24471-01	89

RO/OEM	REF		RO/OEM	REF		RO/OEM	REF	
8M0071855	REC3G2-06060-2	141	8M0100526	RECMC00004	186	94622M	REC682-45376-01	323
8M0075040	REC27-8M0075040	297	8M0103288	REC8M0103288	87-88-89	94624M	REC682-44328-00	323
8M0075245	REC8M0075245	158	8M0103289	REC8M0103289	86-88-89	95188T	REC6E7-85570-19	116
8M0075845	REC8M0098264	153	8M0106635	REC35-8M0106635	70-78-82-83	95218 11	PAF8-04000021	291
8M0080349	REC8M0080349	249-271	8M0109700	REC8M0151044	347	95368 3	REC90340-08002	291
8M0080357	REC39-803678A1	248	8M0112903	REC27-8M0142616	309	95405M	REC677-26301-02	107
8M0080357	REC8M0080357	244-248-271	8M0117413	PAF15-07000031	223	95417M	REC679-45321-02	329
8M0080450	PAF4-03000012	319	8M0117413	REC67F-12411-01	163	95495M	REC677-14343-68	104
8M0082479	PREKM63706	160	8M0117413	REC8M0117413	162-164	95632M	REC688-45341-00	311
8M0082480	PREKM63707	160	8M0118176	PAF40-05050000	84	95652M	REC689-W4432-01	196-325
8M0082481	PREKM63708	160	8M0118179	REC8M0045278	223	95654M	REC689-44323-00	325
8M0082482	PREKM63709	160	8M0118194	PAF60-05000005	223	95661T	REC689-W0078-A6	185
8M0082483	PREKM63710	160	8M0122423	RAC31871	78	9612A 6	REC640-9612A7	249-270-271
8M0082484	PREKM63711	160	8M0122423	REC35-8M0122423	78	96302M	REC6E0-44322-02	319
8M0082485	PREKM63712	160	8M0126670	CMVERADO6KITA	198	96303M	PAF4-03000015	319
8M0082486	PREKM63713	160	8M0126670	CMVERADO6KITM	198	96306M	PAF4-03000020	319
8M0082487	PREKM63714	160	8M0131240	PAF8-04000019	353	96309M	PAF4-03000005	319
8M0082488	PREKM63715	160	8M0133642	REC8M0133642	139	96318M	PAF4-03050001	319
8M0082489	PREKM63716	160	8M0134459	REC8M0134459	98-99	96325T	REC6E0-W0078-A2	319
8M0082490	PREKM63717	160	8M0134464	REC8M0134464	87	96452A1-A4-A5	REC96452A4	143
8M0082491	PREKM63718	160	8M0134472	REC8M0134472	117-119	96455A1	REC96455A8	143
8M0082492	PREKM63719	160	8M0134477	REC8M0134477	138	96455A18	REC96455T18	143
8M0082493	PREKM63720	160	8M0134492	REC8M0134492	179-298	96455A4, A6, A9	REC96455A9	A8
8M0082494	PREKM63721	160	8M0134493	REC8M0134493	178-298	96455A8	REC96455A8	143
8M0082495	PREKM63722	160	8M0135803	REC334-65021-1	298	96455T18	REC96455T18	143
8M0082496	PREKM63723	160	8M0135804	REC27-8M0135804	298	968-9325M	REC6F6-11111-00-1S	251
8M0082497	PREKM63724	160	8M0135805	REC8M0135805	180-298	97-14205M	TENO1118	320
8M0082529	PRE53006	160	8M0135806	REC27-8M0135806	298	97-18852M	CM6E0-45251-11	321
8M0082530	PRE53007	160	8M0137344	CM41106-ZW9-000A	197	97-823912	TENO0813	207
8M0082531	PRE53008	160	8M0137344	REC41106-ZW9-000AL	298	97-855678	PAF15-07010008	200
8M0082532	PRE53009	160	8M0137347	REC8M0137347	298	97-8M0107550	CMVERADO4KITA	198
8M0082533	PRE53010	160	8M0137816	REC8M0162139	163	97-8M0107550	CMVERADO4KITM	198
8M0082534	PRE53011	160	8M0139434	REC8M0139434	68-162-164	REC97-8M0137814	REC97-8M0137814AL	70-199-309
8M0082535	PRE53012	160	8M0141844	PAF40-05050000	84	97072M	PH130-0007	128
8M0082536	PRE53013	160	8M0142542	REC8M0142542	110-114-115	97077M	REC697-85570-00	118
8M0082537	PRE53014	160	8M0142591	REC8M0089940	152	97091M	REC688-45214-02	329
8M0082538	PRE53015	160	8M0142616	REC27-8M0142616	183	97667M	REC6E9-W0093-03	102-104
8M0082539	PRE53016	160	8M0142690	REC8M0142690	110-114-115	98-8M0135821	REC98-8M0135821	68-185-188-298
8M0082540	PRE53017	160	8M0142835	REC31-884325T01	309	98396A38	SIE18-8004	71
8M0082541	PRE53018	160	8M0143219	REC8M0143219	153	98396A38	SIE18-8005	71
8M0082542	PRE53019	160	8M0146553	REC31-77420A1	309	98432Q6	CM984325	197
8M0082543	PRE53020	160	8M0146566	REC31-36387A1	309	98432Q6	CM984325A	197
8M0082544	PRE53021	160	8M0146938	REC27-8M0146938	309	98432T6	CM984325A	295
8M0082545	PRE53022	160	8M0148668	REC8M0148668	110	98432T6	TENO0812	295
8M0082546	PRE53023	160	8M0151044	REC8M0151044	347	98450A1-A3-A5-A10	REC98450A10	142-147
8M0082547	PRE53024	160	8M0157616	REC35-8M0157620	74	99021A11	REC99021A14	142
8M0082577	PRE3300C05	160	8M0157620	REC35-8M0157620	74	99021A14	REC99021A14	142
8M0082578	PRE3300C06	160	8M0162139	REC8M0162139	163	99021A2, A6, K2	REC99021A6	143-148
8M0082579	PRE3300C07	160	8M125617	REC8M0125617	109	99021A3, A5, A8, A13, A15, A16	REC99021A16	143-148
8M0082580	PRE3300C08	160	8M2000347	REC8M2011027	309	99041M	REC6E7-45551-00	322
8M0082581	PRE3300C09	160	8M4503518	PAGB/T5783-M6X20	223	99042M	REC90179-08M06	322
8M0082582	PRE3300C10	160	8M6000359	REC8M6000359	106	99186-1	REC826729A10	152
8M0082583	PRE3300C11	160	8M6000366	REC27-8M6000366	227	99186/T	REC826729A10	152
8M0082584	PRE3300C12	160	8M6000634	REC8M6000634	111	99660A1	REC89329A01	151
8M0082585	PRE3300C13	160	8M6000637	REC8M6000637	111	99993M	REC6E0-41114-A1	169
8M0082586	PRE3300C14	160	8M6000639	REC8M6000639	110	F747095	REC398-832074A4	145
8M0082587	PRE3300C15	160	8M6000652	REC8M6002428	98-99	F749095	REC398-8778A29	145
8M0082588	PRE3300C16	160	8M6002428	REC8M6002428	98-99	F97068-2	REC895338	163
8M0082589	PRE3300C17	160	8M6003194	REC8M6003194	113			
8M0082590	PRE3300C18	160	900-835430A1	PAF15-07040000	211			
8M0082591	PRE3300C19	160	900-835430T03	PAF8-05030100	207			
8M0082592	PRE3300C20	160	90363A1	REC90363A1	91-96			
8M0082593	PRE3300C21	160	90890-06820	REC90890-06820	286			
8M0082594	PRE3300C22	160	91-12037	REC91-12037	284			
8M0082595	PRE3300C23	160	91-31107T	REC91-31107T	284			
8M0082596	PRE3300C24	160	91-31229	REC91-31229	283			
8M0082597	PRE3300C25	160	91-31229A7	RM91-31229A7	284			
8M0082598	PRE3300C26	160	91-34569A1	REC91-34569A1	283			
8M0082599	PRE3300C27	160	91-36569T	REC91-36569T	283			
8M0082600	PRE3300C28	160	91-43506T	REC91-43506T	285			
8M0082601	PRE3300C29	160	91-56048001	REC91-56048001	285			
8M0082602	PRE3300C30	160	91-56775T	REC91-56775T	285			
8M0082603	PRE3300C31	160	91-60523	REC91-60523	285			
8M0082604	PRE3300C34	160	91-60526T	REC91-60526T	285			
8M0082605	PRE3300C36	160	91-61067A04	REC91-61067A04	285			
8M0082606	PRE3300C38	160	91-61069T	REC91-61069T	285			
8M0082880	REC09168-10022	68-298	91-61077T	REC91-61077T	285			
8M0082988	REC8M0082988	112	91-821887T1	REC91-859046Q4	284			
8M0084244	REC17-43043	309	91-83164M	REC90890-06820	286			
8M0088080	REC8M0088080	174-189-304	91-859046Q3	REC91-859046Q3	284			
8M0088081	REC8M0088081	175-189-304	91-895343T01	REC91-895343T02	286			
8M0088351	REC8M0133642	139	91-895343T02	REC91-895343T02	286			
8M0089940	REC8M0089940	152	91-8M0072133	REC55005	286			
8M0090819	REC892864T06	163	91748M	REC6E0-24471-00	89			
8M0091468	REC68V-24410-00	84	91753M	REC6E0-24411-00	89			
8M0091784	REC8M0091784	98-99	92-858026QB1	RM92-858026QB1U6	83			
8M0091976	REC6G1-81970-62	138	92-858027QB1	RM92-858027QB1U3	83			
8M0092849	REC8M0092849	150	92-8M0086220	RM92-8M0086220U6	83			
8M0092850	REC8M0092849	150	92-8M0086221	RM92-8M0086221U3	83			
8M0097838	RAC320R-RAC-01	75	92459A4	PH200-T008	152			
8M0098264	REC8M0098264	153	92520M	REC6A1-W0093-01	100-104			
8M0098898	PH375-0042	132	93224A1	REC93224A1	317			
8M0099896	PAF15-07010008	200	94286T1	CM942860	197			

SISTEMA ALIMENTACIÓN Y FILTRACIÓN 384

ACEITE	392
ACELERADOR - CABLE	430
BOMBA DE COMBUSTIBLE	392
BOMBA DE COMBUSTIBLE ELÉCTRICA	393
BOMBA DE COMBUSTIBLE MECÁNICA	392
BOMBA DE COMBUSTIBLE - JUNTAS	393
BOMBA DE COMBUSTIBLE - KIT	393
MEMBRANAS	394
MEMBRANAS - GUÍA	395
VÁLVULA	394
VST - JUNTAS	394
CARBURADOR	396
AGUJA - KIT	398
BOYAS	397
CARBURADOR COMPLETO	396
CARBURADOR - KITS	396
GUÍA KITS DE CARBURADORES	398
KIT DE VÁLVULA	398
RETENEDOR	398
COMPONENTES TANQUE Y CONECTORES	384
CONECTOR DE DEPÓSITO	384
PASAMAMPAROS	385
FILTRO DE ACEITE	391
JUNTA TAPÓN DEL CARTER	391
FILTRO DE COMBUSTIBLE Y ELEMENTOS	385
BRACKET	385
FILTRO COMBUSTIBLE - SEPARADOR AGUA	385
FILTRO DECANTADOR, VASO TRASPARENTE	386
FILTRO COMBUSTIBLE - EN LÍNEA	388
LLAVES PARA FILTRO	388
RACOR DE LATÓN	388
FILTRO COMBUSTIBLE - CARBURADOR	390
VST - FILTRO	390
FILTRO COMBUSTIBLE ALTA PRESIÓN	390
INYECTORES	395
INYECTOR	395
PLATINOS Y CONDENSADORES	426
CONDENSADORES Y PLATINOS	426
GUÍA	427
KITS	427

SISTEMA ELÉCTRICO 399

BOBINAS	400
BUJÍAS	401
EVINRUDE	403
JOHNSON	401
JUEGOS DE CABLES ALTO RENDIMIENTO	404
PIPA	405
CDI Y CAJAS NEGRAS	414
DESCONECTORES DE SEGURIDAD	422
LLAVES DE ARRANQUE	409
MOTORES DE ARRANQUE	405
GUÍA	408
MUELLE DE ARRANQUE	408
MUELLE SEGURO	408
UÑAS ARRANQUE MANUAL	409
REGULADORES Y RECTIFICADORES	411
GUÍA	414
SENSORES	399
SENSOR CMP	399
SENSOR IAC	399
SENSOR MAT/MAP	399
SOLENOIDE RELE	409
RELE DE TRIM	410
STARTOR	418
GUÍA CAJA NEGRA, STARTOR, TRIGGER	420
TRIGGER	417
TRIM, TILT & POWER TRIM	423
INSTALACIÓN ELÉCTRICA	423
KIT EXTRACTOR DE TAPONES TRIM	426
POWER TRIM COMPLETO	425
TAPÓN PISTÓN	426
TRIM COMPLETO	423
TRIM - SENSOR	425

SISTEMA DE GOBIERNO 428

INTERRUPTORES PARA MANDOS	429
ARNÉS	430
CABLES DE CONTROL	430
EXTENSIÓN ARNÉS	430
INTERRUPTOR MANDO	429
MANDOS DE CONTROL	428
MANDO LATERAL	428
MANDO PARA CONSOLA	429

SISTEMA DE REFRIGERACIÓN 431

ANODOS	455
ÁNODO CANADA METAL	455
ÁNODO RECMAR	458
ÁNODO TECNOSEAL	459

BOMBA DE AGUA	445
CASQUILLO	447
CIRCLIP	447
CUERPO	445
GUÍA BOMBAS DE AGUA	453
JUNTA TÓRICA	448
JUNTAS	449
JUNTAS BASE	446
KIT DE REPARACIÓN	449
TAPA IMPULSOR	448
TUBOS AGUA DE CULATA	455
GUÍA DE IMPULSORES	440
CHAVETA	441
KITS DE RETENES Y JUNTAS	441
GUÍA AROS TÓRICOS	442
RETENES	443
RETENES - GUÍA	444
LÍQUIDO INHIBIDOR DE LA CORROSIÓN	431
TERMOSTATO	432
ARANDELA	438
ASIENTO	436
ASIENTO VÁLVULA	438
CAMISA	438
CUBIERTA	436
DIAFRAGMA	438
GRUESO	436
GUÍA	439
JUNTAS	436
JUNTAS TAPA DE REFRIGERACIÓN	437
KIT TAPÓN	439
NIPLE	438
RESORTE	437
RETÉN MUELLE	437
TAPA	438
TERMOSTATO	433
TERMOSTATO - DESPIECES	432
TERMOSTATO - KIT	434
VÁLVULA ANTIPRESIÓN	437

PARTES DEL MOTOR 463

CIGÜEÑAL	466
BIELAS	466
COJINETES CABEZA DE BIELA	469
COJINETES CENTRALES	469
COJINETES INFERIORES	470
COJINETES PIE DE BIELA	468
COJINETES SUPERIORES	469
GUÍA COJINETES	470
GUÍA RETENES	468
RETENES	467
RETENES - KITS	467
DESPIECE MOTOR DE 4 TIEMPOS	463
CORREAS DE DISTRIBUCIÓN	481
JUNTAS DE MOTOR 4 TIEMPOS	464
BASE DE MOTOR	465
CULATA	464
CULATA - GUÍA	464
CULATA - KIT	465
JUNTAS CUERPO DE MARIPOSA	466
JUNTAS RETÉN SUPERIOR	466
JUNTAS TAPA DE TERMOSTATO	465
JUNTAS VÁLVULA DE PRESIÓN	466
TAPA DE BALANCINES	465
JUNTAS DE MOTOR 2 TIEMPOS	475
BASE DE MOTOR	480
CULATA	475
CULATA - GUÍA	479
CULATA - KIT	477
PISTONES	472
KITS DE PISTONES	473

SISTEMA ESCAPE Y ADMISIÓN 482

SISTEMA DE ADMISIÓN	484
JUNTAS BASE RETÉN	487
JUNTAS BOMBA DE ACEITE	487
JUNTAS CAJA Y BASE DE LENGÜETA	486
JUNTAS CARBURADOR - COLECTOR ADM.	485
JUNTAS COLECTOR	486
JUNTAS CUERPO PALOMILLA - COLECTOR	485
JUNTAS DE ADMISIÓN A CARBURADOR	485
JUNTAS GUÍA CADENA	487
JUNTAS SILENCIADOR	488
JUNTAS TAPA PASO AGUA BLOQUE	484
JUNTAS TAPA TRANSFERENCIA CROSSFLOW	485
RETENES DE ACEITE	489
JUNTAS TAPÓN DE DRENAJE	489
SISTEMA DE ESCAPE	482
JUNTAS	482
JUNTAS CUERPO DE ESCAPE INTERMEDIAS	483
RETENES CUERPO DE ESCAPE	483
JUNTAS DE CARTER	484

UNIDADES DE TRANSMISIÓN 490

CARCASA	493
COLA COMPLETA	490
GUÍA DE COLAS	493
HERRAMIENTAS DE COLA	494
EXTRACTOR DE COJINETES Y HÉLICES	494
EXTRACTOR DE PIÑONES	494
HERRAMIENTAS VOLANTE DE MOTOR	495
KIT HERRAMIENTAS	494
KIT LLAVE HÉLICE	495
LLAVE TUERCA DIÁBOLO	494
LLAVE TUERCA EJE VERTICAL	495
DESPIECE COLAS 4 TIEMPOS	496
J4, J5, J6	496
J10, J15	498
J25	500
J25, J30, J40, J50	502
DF40, DF50	504
J/BJ 60, 70	506
J/BJ 90, 115, 140	507
J/BJ 200, 225, 250	508
DESPIECE COLAS 2 TIEMPOS	509
4, 4.5, 5, 6, 7.5, 8	509
9.9, 15	510
25, 28	511
20, 35	512
40, 50	514
40, 60	516
40, 60, 75	518
V4	520
V4/V6	524
V4/V6 O	526
V4/V6 M	528
V6	530
PIEZAS TRANSMISIÓN	532
CASQUILLO BASCULANTE	539
COJINETE BOMBA DE ACEITE	539
COJINETE BOMBA DE AGUA	541
DIÁBOLO	540
DIÁBOLO - COJINETE	540
DIÁBOLO - TÓRICA	540
EJE HÉLICE	538
EJE TRANSMISIÓN INFERIOR	537
EJE TRANSMISIÓN INFERIOR - COJINETES	537
EJE TRANSMISIÓN SUPERIOR	538
EJE TRANSMISIÓN SUPERIOR - COJINETES	538
GUÍA COJINETES DE COLA	536
KITS DE PIÑONES	532
PAÑADOR	534
PIÑÓN ATAQUE - ARANDELA	533
PIÑÓN ATAQUE - GRUESO	533
PIÑONES ATAQUE	533
PIÑONES MARCHA ATRÁS	532
PIÑONES MARCHA AVANTE	532
SELECTOR	533
SELECTOR - MUELLE	534
SELECTOR - PASADOR	534
SELECTOR - VARILLA	534
SELECTOR - GUÍA	535
TORNILLO DRENAJE	540
TUBO DE AGUA	540
VARILLA DE CAMBIO - ARO TÓRICO	539
VARILLA DE CAMBIO - FUELLE	539
VARILLA DE CAMBIO - TUERCA	539
KIT REPARACIÓN COLA	541
CAMBIO ELÉCTRICO	542
CAMBIO MECÁNICO	541
COLA DE 2 PIEZAS	542
GUÍA	543

SISTEMA DE PROPULSIÓN 544

HÉLICES AL E INOX DE 3 Y 4 PALAS	544
GUÍA HÉLICES CON NÚCLEO INTEGRADO	545
HÉLICES PARA NÚCLEO INTERCAMBIABLE	547
NÚCLEO INTERCAMBIABLE	547
PIEZAS DE HÉLICE	548
ESPACIADOR	548
GUÍA KITS DE RECAMBIO	552
GUÍA RECAMBIOS DE HÉLICE	549
KIT CIERRE HÉLICE	550
PASADOR	548
TOPE HÉLICE	549
TUERCA HÉLICE	548
REF --> RO	553
RO --> REF	

JOHNSON EVINRUDE

EN FUEL & FILTRATION SYSTEM	384	TECNOSEAL	459	POWERHEAD WATER COVER GASKETS	484
CARBURATOR	396	IMPELLER GUIDE	440	REED PLATE GASKETS	486
CARBURATOR KIT - GUIDE	398	KEY	441	THROTTLE BODY TO MANIFOLD GASKETS	485
CARBURATOR - KITS	396	SEAL KIT	441	OIL SEALS	489
FLOATS	397	GEARCASE SEAL	443	UNIT DRIVES & COMPONENTS	490
NEEDLE VALVE, KIT	398	GEARCASE SEAL APPLICATION	444	EMPTY GEARCASE	493
RETAINER	398	O-RING APPLICATION	442	GEARCASE ASSY	490
VALVE KIT	398	THERMOSTAT	432	GEARCASE GUIDE	493
FUEL FILTERS AND ELEMENTS	385	COVER	436	GEAR CASE PARTS - 4 STROKES	496
BRACKET	385	CUP	438	J4, J5, J6	496
COMPLET FUEL FILTER WITH BOWL	386	DIAPHRAGM	438	J10, J15	498
FILTER KEY	388	GASKETS	436	J25	500
FUEL FILTER	390	GROMMET	436	J25, J30, J40, J50	502
FUEL FILTER - CARBURETOR	390	NIPLÉ	438	DF40, DF50	504
HIGH PRESSURE	395	PLUG WATER FLUSH	439	J/BJ 60, 70	506
IN-LINE FUEL FILTER	388	PRESSURE VALVE	437	J/BJ 90, 115, 140	507
RACOR MADE IN BRASS	388	SEAT	436	J/BJ 200, 225, 250	508
VST - FUEL FILTER	390	SLEEVE	438	GEAR CASE PARTS - 2 STROKES	509
FUEL PUMP	392	SPRING	437	4, 4.5, 5, 6, 7.5, 8	509
FUEL PUMP - ELECTRIC	393	THERMOSTAT - KIT	434	9.9, 15	510
FUEL PUMP - GASKETS & KITS	393	THERMOSTAT ASSEMBLIES	432	25, 28	511
FUEL PUMP - MECHANICAL	392	THERMOSTAT - GUIDE	439	20, 35	512
DIAPHRAGM SET	394	VALVE SEAT	438	40, 50	514
CHECK VALVE	394	WASHER	438	40, 60	516
VST - GASKETS	394	WATER PUMP	445	40, 60, 75	518
DIAPHRAGM SET APPLICATION	395	CLIP	447	V4	520
FUEL TANK COMPONENTS & CONNECTORS	384	HOUSING	445	V4/V6	524
TANK CONNECTOR	384	IMPELLER PLATE	448	V4/V6 O	526
THRU HULL	385	SLINGER	447	V4/V6 M	528
OIL	392	TUBOS AGUA DE CULATA	455	V6	530
OIL FILTER & PLUG GASKET	391	WATER PUMP - GASKET	446-449	GEARCASE SEAL KIT	541
POINTS & CONDENSERS	426	WATER PUMP - O-RING	448	ELECTRIC SHIFT	542
CONDENSERS & POINTS GUIDE	427	WATER PUMP - GUIDE	453	GEARCASE SEAL KIT APPLICATION	543
THROTTLE CABLE	430	WATER PUMP - SERVICE KIT	449	MECHANICAL SHIFT	541
WATER SEPARATING FUEL FILTER	385	ENGINE PARTS	463	TWO-PIECE GEARCASE	542
ELECTRIC SYSTEM	399	CRANKSHAFT	466	STERN DRIVE PARTS	532
CDI & POWER PACK	414	BEARING - GUIDE	470	BUSH SWIVEL	539
COILS	400	CENTER BEARING	469	CLUTCH DOGS	533
CUT OFF SWITCHES	422	CONNECTING ROAD BEARING, BIG END	469	CLUTCH DOGS - GUIDE	535
IGNITION STARTER SWITCH	409	CONNECTING ROAD BEARING, SMALL END	468	CLUTCH DOGS - ROD PUSH	534
REGULATOR AND RECTIFIERS	411	CONNECTING ROD	466	CLUTCH DOGS - SPRING	534
REGULATORS GUIDE	414	CRANKSHAFT GUIDE	468	COMPLETE GEAR SET	532
SENSORES CMP, IAC, MAT/MAP	399	CYLINDER GASKET	466	DIABOLO	540
SOLENOID RELAY	409	LOWER BEARING	470	DRAIN WATER TUBE	540
RELAY - TRIM	410	UPPER BEARING	469	DRAIN, SCREW AND GASKETS	540
SPARK PLUG	401	OIL SEALS SETS	467	INITIATIVE GEAR	533
EVINRUDE	403	ENGINE PARTS - 4 STROKES	463	LOWER DRIVE SHAFT	537
JOHNSON	401	ENGINE GASKETS - 4 STROKES	464	LOWER HOUSING BEARING GUIDE	536
HD SPARK PLUG WIRE SET	404	CYLINDER COVER	465	OIL PUMP - BEARING	539
SPARK PLUG PIPE	405	CYLINDER GASKET	465	POSITIVE GEAR	532
STARTERS	405	CYLINDER HEAD GASKET	464	PROP SHAFT	538
GUIDE	408	CYLINDER HEAD GASKET - KIT	465	REVERSE GEAR	532
REWIND SPRING	408	GASKET, PRESSURE VALVE	466	SHIFT, BELOW	539
STARTER PAWL SPRING	408	GASKET, THROTTLE BODY	466	SHIFT, O-RING	539
STARTER PAWL	409	GASKET, UPPER SEAL	466	TURNBUCKLE, CUTCH ROD	539
STARTOR	418	THERMOSTAT COVER	465	UPPER DRIVE SHAFT	538
GUIDE - POWER PACK, STARTOR, TRIGGER	420	ENGINE GASKETS - 2 STROKES	475	WATER PUMP - BEARING	541
TRIGGER	417	CYLINDER GASKET	480	TOOLS	494
TRIM, TILT & POWER TRIM	423	CYLINDER HEAD GASKET	475	BEARING CARRIER RETAINER WRENCH	494
COMPLETE TRIM ASSEMBLY	423	CYLINDER HEAD GASKET - GUIDE	479	FLYWHEEL PULLER	495
PLUG PISTON TRIM	426	CYLINDER HEAD GASKET - KIT	477	GEAR CASE TOOL KIT	494
POWER TRIM ASSEMBLY	425	GUIDE TIMING BELT	481	PINION NUT ADAPTOR KIT	495
TRIM PLUGS EXTRACTOR	426	PISTONS	472	PROP AND BEARING PULLER	494
TRIM SENSOR	425	EXHAUST & INTAKE SYSTEM	482	PROP WRENCH KIT	495
WIRING HARNESS	423	EXHAUST SYSTEM	482	UNIVERSAL PULLER PLATE	494
STEERING SYSTEM	428	EXHAUST SYSTEM - INTERMEDIATE HOUSING	483	POPULSION SYSTEM	544
ENGINE CONTROLS	428	EXHAUST SYSTEM - GASKETS	482	3 & 4 BLADE ALUMINIUM & SS PROPELLERS	544
CONSOLE CONTROL	429	OIL PAN GASKET	484	INTERCHANGEABLE HUB	547
SIDE CONTROL	428	SEALS - HOUSING EXHAUST	483	PROPELLERS APPLICATION WITH RUBBER HUB	545
SWITCHES & CABLES	429	INTAKE SYSTEM	484	PROPELLERS FOR INTERCHANGEABLE HUB	547
ARNES	430	AIR SILENCER GALLERY	488	PROP PARTS	548
ARNES EXTENSION	430	CARBURETOR TO INTAKE GASKETS	485	PROPELLER - WASHER	548
CONTROL CABLE	430	GALLERY	486	PROPELLER KITS & HARDWARE GUIDE	552
CONTROL SWITCH	429	GASKET OIL PUMP	487	PROPELLER NUT	548
COOLING SYSTEM	431	GASKET TIMING CHAIN GUIDE BASE	487	PROPELLER NUT - KITS	550
ANODE	455	GASKET, COLLECTOR	486	PROPELLER SPARE PARTS	549
CANADA METAL	455	GASKET, MOUNT OIL SEAL COVER	487	THRUST WASHER	549
RECMAR	458	INTAKE TO CARBURETOR GASKETS	485	REF --> RO	553
		POWERHEAD TRANSFER GASKET	485	RO --> REF	

SISTEMA DI ALIMENTAZIONE E FILTRAZIONE	384	KIT TENUTE	441	GUARNIZIONE SCARICO ED INTERMEDIE	483
CAVO ACCELERATORE	430	GUIDA TENUTE PIEDE	444	PARAOILIO SCARICO	483
CARBURATORE	396	O-RING	442	UNITA DI TRASMISSIONE	490
CARBURATORE - GUIDA KIT	398	TENUTE PIEDE	443	CARCASSA	493
CARBURATORE - KIT	396	LIQUIDO INIBITORE DELLA CORROSIONE	431	GUIDA PIEDE	493
CARBURATORE COMPLETO	396	POMPA ACQUA	445	PIEDI	490
FERMO	398	POMPA ACQUA - CORPO	445	ATTREZZI	494
GALLEGGIANTE	397	GUARNIZIONE - BASE POMPA	446	CHIAVE DADO ASSE VERTICALE	495
KIT DE VALVOLA	398	BOCCOLA	447	CHIAVE PER CUSCINETTO	494
KIT SPILLO CONICO	398	CLIP	447	ESTRATTORE CUSCINETTI E ELICA	494
COMPONENTI SERBATOIO E CONETTORI	384	GUARNIZIONE	448	ESTRATTORE PIGNONE	494
ATTACCO SERBATOIO	384	PIASTRA GIRANTE	448	ESTRATTORE VOLANO	495
PASSASCAFFO	385	GUARNIZIONE - POMPA	449	KIT ATTEZZI PIEDI	494
FILTRI BENZINA E RACCORDI	385	KIT RICAMBI POMPA ACQUA	449	KIT CHIAVE ELICHA	495
CHIAVE DA FILTRO	388	POMPA ACQUA - GUIDA	453	PARTI PIEDE	532
FILTRO BENZINA - CARBURATORE	390	KIT TUBI ACQUA TESTATA	455	ALBERO TRANS. INFERIORE - CUSCINETTO	537
FILTRO BENZINA ALTA PRESSIONE	390	TERMOSTATO	432	ALBERO TRANS. SUPERIORE - CUSCINETTO	538
FILTRO BENZINA PER MONTARE IN LINEA	388	ESPLOSO TERMOSTATO	432	ASSE ELICA	538
FILTRO BENZINA VST BASSA PRESSIONE	390	TERMOSTATO	433	ASSE TRASMISSIONE INFERIORE	537
FILTRO DI DECANTAZIONE BENZINA CON VASCHETTA TRASPARENTE	386	TERMOSTATO - KIT	434	ASSE TRASMISSIONE SUPERIORE	538
FILTRO SEPARATORE ACQUA-BENZINA	385	SEDE DI TERMOSTATO	436	ASTA PRESSIONE	534
RACCORDO IN OTTONE	388	TERMOSTATO - COPERCHIO	436	DADO ASTA CAMBIO	539
SUPPORTO	385	SPESSORE	436	DIABOLO	540
FILTRO OLIO	391	TERMOSTATO - GUARNIZIONI	436	DIABOLO - CUSCINETTO	540
GUARNIZIONE TAPPO	391	GUARNIZIONE COPERCHIO REFRIGERAZIONE	437	GUIDA CUSCINETTI PIEDE	536
INNIEITTORE	395	MOLLA	437	KIT PIGNONI COMPLETO	532
OLIO	392	TENUTA MOLLA	437	MANICOTTO MARCE	539
POMPA BENZINA	392	VALVOLA ANTI-PRESSIONE DE TERMOSTATO	437	O-RING DIAVOLO	540
POMPA BENZINA MECCANICA	392	RONDELLA	438	O-RING MARCE	539
POMPA BENZINA ELETTRICA	393	SEDE DI VALVOLA	438	PIGNONI INIZIATIVA	533
GUARNIZIONI	393	TERMOSTATO - MANICOTTO	438	PIGNONI MARCIA AVANTI	532
POMPA BENZINA- KIT	393	MEMBRANA	438	PIGNONI MARCIA INDIETRO	532
KIT MEMBRANA	394	NIPLI	438	POMPA ACQUA	541
VALVOLA	394	COPERCHIO	438	POMPA OLIO	539
GUARNIZIONE VST	394	GUIDA	439	RONDELLA PIGNONI INIZIATIVA	533
GUIDA MEMBRANA	395	KIT TAPPO	439	SELETTORE	533
PUNTINE E CONDENSATORE	426	PARTI MOTORE	463	SELETTORE - GUIDA	535
GUIDA E KIT	427	ALBERO MOTORE	466	SELETTORE - MOLLA	534
SISTEMA ELETTRICO	399	BIELLA	466	SELETTORE - PIN	534
BOBINE	400	CUSCINETTO - GUIDA	470	SPESSORE PIGNONI INIZIATIVA	533
CANDELE	401	CUSCINETTO CENTRALI	469	SPINOTTO	534
EVINRUDE	403	CUSCINETTO DI BIELLA, FINALE GRANDE	469	TUBO DRENAGGIO ACQUA	540
JOHNSON	401	CUSCINETTO DI BIELLA, FINALE PICCOLO	468	VITI E GUARNIZIONE, DRENAGGIO	540
KIT CAVI CANDELE, ALTE PRESTAZIONI	404	CUSCINETTO INFERIORE	470	PARTI PIEDI DE 4 TEMPI	496
GOMITO PER CANDELE	405	CUSCINETTO SUPERIORE	469	J4, J5, J6	496
CDI E CENTRALINA	414	PARAOILIO	467	J10, J15	498
CHIAVETTA DI SICUREZZA	422	PARAOILIO - GUIDA	468	J25	500
CHIAVI DI ACCENSIONE	409	PARAOILIO - KIT	467	J25, J30, J40, J50	502
MOTORINI AVVIAMENTO	405	CINGHIE DISTRIBUZIONE	481	DF40, DF50	504
MOLLE AVVIAMENTO	408	GUARNIZIONI DE MOTORE 4 TEMPI	464	J/BJ 60, 70	506
MOLLE DI SICUREZZA AVVIAMENTO	408	GUARNIZIONE BASE MOTORE	465	J/BJ 90, 115, 140	507
PIASTRA AVVIAMENTO MANUALE	409	GUARNIZIONE COPERCHIO PUNTERIE	465	J/BJ 200, 225, 250	508
REGOLATORI E RADDRIZZATORI	411	GUARNIZIONE COPERCHIO TERMOSTATO	465	PARTI PIEDI DE 2 TEMPI	509
GUIDA	414	GUARNIZIONE CORPO FARFALLATO	466	4, 4.5, 5, 6, 7.5, 8	509
SENSORE	399	GUARNIZIONE DE TESTATA	464	9.9, 15	510
SENSORE CMP	399	GUARNIZIONE PARAOLIO SUPERIORE	466	25, 28	511
SENSORE IAC	399	GUARNIZIONE TESTATA - KIT	465	20, 35	512
SENSORE MAT/MAP	399	GUARNIZIONE VALVOLA PRESSIONE	466	40, 50	514
SOLENOIDE RELE	409	GUARNIZIONI MOTORE 2 TEMPI	475	40, 60	516
RELE TRIM	410	GUARNIZIONE BASE MOTORE	480	40, 60, 75	518
STARTOR	418	GUARNIZIONE DE TESTATA	475	V4	520
GUIDA CENTRALINA, STARTOR, TRIGGER	420	GUARNIZIONE TESTATA - GUIDA	479	V4/V6	524
TRIGGER	417	GUARNIZIONE TESTATA - KIT	477	V4/V6 O	526
TRIM, TILT & POWER TRIM	423	PARTI MOTORI 4 TEMPI	463	V4/V6 M	528
ESTRATTORE PER TAPPI DI TRIM	426	J/BJ 40, 50 HP	463	V6	530
INSTALLAZIONE ELETTRICA	423	PISTONI	472	KIT RIPARAZIONE PIEDE	541
MOTORINO TRIM COMPLETO	423	KIT PISTONE	473	CAMBIO MECCANICO	541
POWER TRIM COMPLETO	425	SISTEMA DI SCARICO E ASPIRAZIONE	482	CAMBIO ELETTRICO	542
TAPPO PISTONE TRIM	425	SISTEMA ASPIRAZIONE	484	PIEDE 2 PEZZI	542
TRIM - SENSORE	425	GUARNIZIONE ASPIRAZIONE - CARBURATORE	485	GUIDA KIT RIPARAZIONE PIEDE	543
SISTEMA DI GUIDA	428	GUARNIZIONE BASE PARAOLIO	487	SISTEMA DI PROPULSIONE	544
COMANDI DI CONTROLLO	428	GUARNIZIONE CARTER CATENA	487	ELICHE ALLUMINIO E INOX DA 3 E 4 PALE	544
COMANDO LATERALE	428	GUARNIZIONE COLLETORE	486	ELICHE PER MOZZO INTERCAMBIABILE	547
COMANDO PER CONSOLLA	429	GUARNIZIONE COPERTORE	485	GUIDE ELICHE CON MOZZO	545
INTERRUTTORI E CAVI	429	GUARNIZIONE COPERTORE CROSSFLOW	485	MOZZO INTERCAMBIABILE	547
CAVI	430	GUARNIZIONE COPERCHIO PASSAGGIO ACQUA	484	PARTI ELICA	548
CAVI COMANDO	430	GUARNIZIONE CORPO FARFALLA COLLETORE	485	DADO DI ELICA	548
ESTENSIONE	430	GUARNIZIONE INTERMEDIA CARBURATORE - COLLETORE	485	DISTANZIALE ELICA	548
INTERRUTTORI CONTROLLO	429	GUARNIZIONE MARMITA	488	GUIDA RICAMBI CHIUSURA ELICHE	552
SISTEMA DI RAFFREDDAMENTO	431	GUARNIZIONE PIASTRA	486	GUIDA RICAMBIO ELICHE	549
ANODI	455	GUARNIZIONE PIASTRA	486	KIT CHIUSURA ELICA	550
CANADA METAL	455	GUARNIZIONE POMPA D'OLIO	487	RONDELLA CHIUSURA	549
RECMAR	458	PARAOILIO	489	SPINOTTO	548
TECNOSEAL	459	GUARNIZIONE TAPPO DRENAGGIO	489	REF --> RO	553
GUIDA GIRANTE	440	SISTEMA SCARICO	482	RO --> REF	
CHIAVETTA	441	GUARNIZIONE COPPA OLIO	484		
		GUARNIZIONE SCARICO	482		

SYSTÈME D'ALIMENTATION ET DE FILTRATION	384	POMPE À EAU	445	JOINT SPI	489
HUILES	392	CLIPS	447	JOINT DE VIDANGE	489
CÂBLES D'ACCELERATION	430	INSERT	447	EMBASES ET PIÈCES	490
POMPE À ESSENCE	392	JOINT DE BASE DE POMPE À EAU	446	CARTER	493
POMPE À ESSENCE MECANIQUE	392	KIT REPARATION	449	EMBASE	490
POMPE À ESSENCE ELECTRIQUE	393	PLAQUE DE TURBINE	448	GUIDE D'EMBASES	493
POMPE À ESSENCE - JOINTS	393	POMPE À EAU - CORPS	445	OUTILS	494
KIT POMPE ESSENCE	393	POMPE À EAU - JOINT TORIQUE	448	CLE POUR ARBRE VERTICAL	495
KIT DIAPHRAGME	394	POMPE À EAU - GUIDE	453	CLE POUR ECROU D'HELICE	495
SOUPAPE	394	POMPE À EAU - JOINT	449	CLE POUR ECROU DE DIABOLO	494
JOINTS VST	394	TUYAU D'EAU DE CULASSE	455	EXTRACTEUR DE ROULEMENTS D'HELICE	494
GUIDE DIAPHRAGME	395	GUIDE TURBINES	440	EXTRACTEUR DE VOLANT MOTEUR	495
CARBURATEUR	396	CLAVETTE	441	EXTRACTEUR PIGNONS ET ROULEMENTS	494
CARBURATEUR - GUIDE KITS	398	KITS JOINTS	441	KIT OUTILS POUR EMBASES	494
CARBURATEUR - KIT	396	JOINT TORIQUE	442	KIT REPARATION EMBASE	541
CARBURATEUR COMPLET	396	JOINTS	443	CARTER EN DEUX PARTIES	542
FLOTTEUR	397	GUIDE DES JOINTS	444	CHANGEMENT DE VITESSE ELECTRIQUE	542
KIT SIEGE, POINTEAU ET GICLEUR	398	SALT OFF	431	CHANGEMENT DE VITESSE MECANIQUE	541
KIT SOUPAPE	398	THERMOSTAT	432	GUIDE KIT REPARATION	543
RETENUE	398	BAGUE	436	PIÈCES D'EMBASES DE 4 TEMPS	496
COMPOSANTS ET CONNECTEURS DU RESERVOIR	384	COUPELLE DE RESSORT	437	J4, J5, J6	496
PASSE-CLOISON	385	COUVERCLE	436	J10, J15	498
RACCORDS DE RESERVOIR	384	COUVERCLE	438	J25	500
FILTRE A HUILE	391	DIAPHRAGME	438	J25, J30, J40, J50	502
JOINT DE VIDANGE	391	GUIDE	439	DF40, DF50	504
FILTRE À ESSENCE ET CARTOUCHE DE RECHANGE	385	JOINT DE PLAQUE DE REFROIDISSEMENT	437	J/BJ 60, 70	506
CLÉ À FILTRE	388	JOINT DE THERMOSTAT	436	J/BJ 90, 115, 140	507
FILTRE À ESSENCE BASSE PRESSION	390	JOINT DE VALVE	438	J/BJ 200, 225, 250	508
FILTRE À ESSENCE HAUTE PRESSION	390	KIT BOUCHON	439	PIÈCES D'EMBASES DE 2 TEMPS	509
FILTRE À ESSENCE DE CARBURATEUR	390	KIT THERMOSTAT	434	4, 4.5, 5, 6, 7.5, 8	509
FILTRE À ESSENCE EN LIGNE	388	LOGEMENT	438	9.9, 15	510
FILTRE SÉPARATEUR EAU-ESSENCE	385	PIÈCES DE THERMOSTAT	432	25, 28	511
FILTRE SÉPARATEUR EAU-ESSENCE AVEC BOL TRANSPARENT	386	RESSORT	437	20, 35	512
RACCORD EN LAITON	388	RONDELLE	438	40, 50	514
TÊTE DE FILTRE À ESSENCE	385	SOUPAPE DE PRESSION DE THERMOSTAT	437	40, 60	516
INJECTEURS	395	TETINE	438	40, 60, 75	518
VIS PLATINEES ET CONDENSATEUR	426	THERMOSTAT	433	V4	520
GUIDE ET KITS	427	PIECES MOTEUR	463	V4/V6	524
SYSTÈME ÉLECTRIQUE	399	VILEBREQUIN	466	V4/V6 0	526
BOBINES	400	BIELLE	466	V4/V6 M	528
BOUGIES	401	GUIDE ROULEMENT	470	V6	530
EVINRUDE	403	JOINT SPI	467	PIÈCES D'EMBASES	532
JOHNSON	401	JOINT SPI - GUIDE	468	ARBRE D'HELICE	538
CAPUCHON DE BOUGIE	405	JOINT SPI - KIT	467	ARBRE DE TRANSMISSION INFERIEUR	537
KIT FAISCEAU DE BOUGIE	404	ROULEMENT CENTRAL	469	ARBRE DE TRANSMISSION INFERIEUR - ROULEMENT	537
CDI ET BOITIER ELECTRONIQUE	414	ROULEMENT INFÉRIEUR	470	ARBRE DE TRANSMISSION SUPERIEUR	538
COUPE CIRCUIT DE SÉCURITÉ	422	ROULEMENT PIED DE BIELLE	468	ARBRE DE TRANSMISSION SUPERIEUR - ROULEMENT	538
CONTACTEUR À CLÉ	409	ROULEMENT SUPERIEUR	469	BAGUE TOURNANTE	539
DEMARRÉUR	405	ROULEMENT TÊTE DE BIELLE	469	CRABOT	533
CLIQUET D'ARRÊT DU LANCEUR MANUEL	409	PIÈCES MOTEURS 4 TEMPS	463	CRABOT - GUIDE	535
GUIDE RESSORT DE DÉMARRAGE	408	GUIDE DES COURROIES DE DISTRIBUTION	481	CRABOT - PIVOT	534
RESSORT DE DÉMARRAGE	408	JOINTS DE MOTEUR 4 TEMPS	464	CRABOT - TIGE DE POUSSEE	534
RESSORT DE SÉCURITÉ DÉMARRAGE	408	JOINT DE CACHE CULBUTEUR	465	DIABOLO	540
REGULATEURS ET RECTIFIEURS	411	JOINT DE THROTTLE BODY	466	DIABOLO - JOINT TORIQUE	540
GUIDE REGULATER	414	JOINT LOGEMENT THERMOSTAT	465	DIABOLO - ROULEMENT	540
SONDE IAT/ IAC/ CMP	399	JOINT SOUPAPE DE PRESSION	466	DIABOLO - JOINT TORIQUE	532
CAPTEUR MAP/MAT	399	JOINT SPI SUPERIEUR	466	LEVIER - JOINT TORIQUE	539
SOLENOIDE RELAIS	409	JOINTS DE CULASSE	464	LEVIER - SOUFFLET	539
TRIM	410	JOINTS DE CULASSE - KIT	465	LEVIER - ECROU	539
STARTOR	418	JOINTS DE CULASSE - GUIDE	479	PIGNON D'ATTAQUE	533
GUIDE BOITIER ELECTRONIQUE, STARTOR, TRIGGER	420	JOINT DE CULASSE - KIT	477	PIGNON D'ATTAQUE - CALE	533
TRIGGER	417	JOINT DE TETE MOTRICE	480	PIGNON D'ATTAQUE - RONDELLE	533
TRIM, TILT & POWER TRIM	423	JOINT DE CULASSE - KIT	479	PIGNON MARCHE ARRIÈRE	532
BOUCHON VERIN DE TRIM	426	JOINT DE TETE MOTRICE	480	PIGNON MARCHE AVANT	532
INSTALLATION ELECTRIQUE	423	PISTONS	472	RESSORT DE SELECTEUR	534
KIT EXTRACTEUR	426	PISTONS - KIT	473	ROULEMENT D'EMBASE - GUIDE	536
MOTEUR DE TRIM COMPLET	423	SYSTÈME D'ÉCHAPPEMENT ET D'ADMISSION	482	ROULEMENT DE POMPE À EAU	541
POWER TRIM COMPLET	425	SYSTÈME D'ADMISSION	484	ROULEMENT DE POMPE À HUILE	539
SONDE DE TRIM	425	JOINT CORPS DE PAPILLON POUR COLLECTEUR	485	TUBE DE VIDANGE DE LA POMPE À EAU	540
SYSTÈME DE DIRECTION	428	JOINT DE COLLECTEUR	486	VIS ET JOINTS DE VIDANGE	540
INTERRUPTEUR ET CÂBLES	429	JOINT DE COUVERCLE D'HUILE	487	SYSTÈME DE PROPULSION	544
CÂBLES DE COMMANDE	430	JOINT DE CULASSE - TRANSFERT POUR MOTEURS CROSSFLOW	485	HÉLICE ALUMINIUM ET INOX 3 ET 4 PALES	544
FAISCEAU ELECTRIQUE	430	JOINT DE PLAQUE	486	GUIDE DES HÉLICES ET MOYEURS	545
INTERRUPTEUR DE CONTRÔLE	429	JOINT DU CARBURATEUR AU COLLECTEUR D'ADMISSION	485	HELICES AVEC MOYEU INTERCHANGEABLE	547
RALLONGE FAISCEAU	430	JOINT DU CARTER D'ADMISSION AU CARBURATEUR	485	MOYEU INTERCHANGEABLE	547
BOITIER DE COMMANDE	428	JOINT DU GUIDE DE DISTRIBUTION	487	PIÈCES POUR HÉLICE	548
BOITIER LATERAL	428	JOINT DU SILENCIEU	488	ÉCROU D'HELICE	548
BOITIER POUR CONSOLE	429	JOINT POMPE D'HUILE	487	ÉCROU D'HELICE - KIT	550
SYSTÈME DE REFROIDISSEMENT	431	JOINTS DE COUVERCLE DU PASSAGE D'EAU	484	ENTRETOISE D'HELICE	548
ANODES	455	SYSTÈME D'ÉCHAPPEMENT	482	GOUPILLE FENDUE	548
CANADA METAL	455	JOINT D'ÉCHAPPEMENT	482	GUIDE DES KITS ET PIÈCES POUR HÉLICE	552
RECMAR	458	JOINT D'ÉCHAP. DU CORPS INTERMÉDIAIRE	483	GUIDE DES PIÈCES POUR HELICE	549
TECNOSEAL	459	JOINT DE CARTER D'HUILE	484	RONDELLE DE BUTÉE	549
		JOINT DU COUVERCLE D'ÉCHAPPEMENT	483	REF --> RO	553
				RO --> REF	

SISTEMA DE ALIMENTACIÓN Y FILTRACIÓN FUEL & FILTRATION SYSTEM

SISTEMA DI ALIMENTAZIONE E FILTRAZIONE SYSTÈME D'ALIMENTATION ET DE FILTRATION

COMPONENTES TANQUE Y CONECTORES

FUEL TANK COMPONENTS & CONNECTORS

COMPONENTI SERBATOIO E CONETTORI

COMPOSANTS ET CONNECTEURS DU RESERVOIR

CONECTOR DE DEPÓSITO

TANK CONNECTOR

ATTACCO SERBATOIO

RACCORDS DE RESERVOIR

Fabricado en latón.

Made in machined brass.

Fabbricato in ottone.

Fait en laiton.

REF	1/4" NPT	1
GS31068		



Para conectar dos motores a un sólo depósito, o viceversa.
Fabricado en latón.

To connect two motors to a single tank, or vice versa.
Made in machined brass

Per collegare due motori a un singolo serbatoio o viceversa.
Fabbricato in ottone.

Pour connecter deux moteurs à un même réservoir, ou inversement.
Fait en laiton.

REF	1/4" NPT	1
GS31069		



Toma de tanque de combustible.
Fabricado en latón.

Fuel tank connector
Made in machined brass

Filettatura per serbatoio benzina
Fabbricato in ottone.

Prise de réservoir de carburant.
Fait en laiton.

REF	OEM	1/4" NPT	1
GS31021			
GS31083	772681	1/4" NPT	1



GS31021



GS31083



CONECTOR DOBLE

DOUBLE CONNECTOR

CONNETTORE DOPPIO

CONNECTEUR DOUBLE

REF	8 mm	1
GS31092		



REF	OEM	COMPATIBLE	3/8"	1	2T STROKES	4T STROKES
GS31089	5032150	REC65720-986LO	3/8"	1		
GS31084	174508	GS31083	5/16"	1		25 - 140 hp
GS31085	176445	GS31083	3/8"	1		
GS31035	5033222		5/16"	1	60 hp	
GS31036	5033222		3/8"	1		



GS31089, GS31084, GS31085



GS31035-GS31036



REF	OEM	10, 15 HP (2003-05)
REC65720-98520	5033221	



new

REF	OEM	6 - 200 HP	3/8"
REC65720-986LO	5032150		



new

PASAMAMPAROS	THRU HULL	PASSASCAFO	PASSE-CLOISON						
Para atravesar mamparos de hasta 12 mm. Fabricado en latón.	For bulkhead up to 12 mm. Made in machined brass.	Per attraversare paratie fino a 12 mm. Fabricato in ottone.	Pour traverser des cloisons jusqu'à 12 mm. Fait en laiton.						
<table border="1"> <thead> <tr> <th>REF</th> <th></th> <th></th> </tr> </thead> <tbody> <tr> <td>GS31064</td> <td>3/8"</td> <td>1</td> </tr> </tbody> </table>	REF			GS31064	3/8"	1			
REF									
GS31064	3/8"	1							

FILTRO DE COMBUSTIBLE Y ELEMENTOS	FUEL FILTERS AND ELEMENTS	FILTRI BENZINA E RACCORDI	FILTRE A ESSENCE ET CARTOUCHE DE RECHANGE																								
BRACKET	BRACKET	SUPPORTO	TÊTE DE FILTRE À ESSENCE																								
Con 2 tapones de bronce y 2 tubos de extensión. (2 entradas y 2 salidas).	With 2 brass plugs and 2 extension tubes. (2 inputs & 2 outputs).	Con 2 tappi di bronzo e 2 tubi di estensione. (2 ingressi entrata carburante e 2 uscite carburante).	Avec 2 bouchons en bronze et 2 tubes d'extension. (2 entrées et 2 sorties).																								
<table border="1"> <thead> <tr> <th>REF</th> <th>R.O. OEM</th> <th></th> <th></th> </tr> </thead> <tbody> <tr> <td>REC25000</td> <td>89876A3</td> <td>1/4"</td> <td>AL</td> </tr> <tr> <td>REC25010</td> <td></td> <td>1/4"</td> <td>INOX /SS AISI316</td> </tr> <tr> <td>REC25020</td> <td></td> <td>3/8"</td> <td>AL</td> </tr> <tr> <td>REC25030</td> <td></td> <td>3/8"</td> <td>INOX /SS AISI316</td> </tr> <tr> <td>RECOBBRACKET</td> <td></td> <td>1/4"</td> <td>Plástico Plastic Plastica Plastique</td> </tr> </tbody> </table>	REF	R.O. OEM			REC25000	89876A3	1/4"	AL	REC25010		1/4"	INOX /SS AISI316	REC25020		3/8"	AL	REC25030		3/8"	INOX /SS AISI316	RECOBBRACKET		1/4"	Plástico Plastic Plastica Plastique			
REF	R.O. OEM																										
REC25000	89876A3	1/4"	AL																								
REC25010		1/4"	INOX /SS AISI316																								
REC25020		3/8"	AL																								
REC25030		3/8"	INOX /SS AISI316																								
RECOBBRACKET		1/4"	Plástico Plastic Plastica Plastique																								
	REC25000 - REC25020	REC25010 - REC25030	RECOBBRACKET																								

FILTRO COMBUSTIBLE SEPARADOR DE AGUA	WATER SEPARATING FUEL FILTER	FILTRO SEPARATORE ACQUA-BENZINA	FILTRE SÉPARATEUR EAU-ESSENCE																		
<table border="1"> <thead> <tr> <th>REF</th> <th>MICRON</th> <th></th> </tr> </thead> <tbody> <tr> <td>REC24942</td> <td>10</td> <td>4 7/16" = 11 cm</td> </tr> <tr> <td>REC35-802893Q01</td> <td>10</td> <td>3 3/4"</td> </tr> <tr> <td>REC855686</td> <td>28</td> <td>4 7/16"</td> </tr> <tr> <td>REC35-802893Q</td> <td>25</td> <td>3 3/4"</td> </tr> <tr> <td>RACPF5510</td> <td>10</td> <td>4 7/16"</td> </tr> </tbody> </table>	REF	MICRON		REC24942	10	4 7/16" = 11 cm	REC35-802893Q01	10	3 3/4"	REC855686	28	4 7/16"	REC35-802893Q	25	3 3/4"	RACPF5510	10	4 7/16"			
REF	MICRON																				
REC24942	10	4 7/16" = 11 cm																			
REC35-802893Q01	10	3 3/4"																			
REC855686	28	4 7/16"																			
REC35-802893Q	25	3 3/4"																			
RACPF5510	10	4 7/16"																			
	RACPF5510	REC24942	REC35-802893Q01	REC855686	REC35-802893Q																

Filtro original.	OEM filter.	Filtro benzina originale.	Filtre à essence original								
<table border="1"> <thead> <tr> <th>REF</th> <th>R.O. OEM</th> <th>MICRON</th> <th></th> </tr> </thead> <tbody> <tr> <td>RM35-802893Q</td> <td>35-802893Q01</td> <td>10</td> <td>3 3/4"</td> </tr> </tbody> </table>	REF	R.O. OEM	MICRON		RM35-802893Q	35-802893Q01	10	3 3/4"			
REF	R.O. OEM	MICRON									
RM35-802893Q	35-802893Q01	10	3 3/4"								



FILTRO CON BRACKET	OEM FILTER WITH BRACKET	FILTRO BENZINA CON SUPPORTO	FILTRE A ESSENCE AVEC SUPPORT															
Con 2 tapones de bronce y 1 tubo de extensión.	With 2 brass plugs & 1 extension tube.	Con 2 tappi di bronzo e 1 tubo di estensione.	Avec 2 bouchons en bronze et 1 tube d'extension															
<table border="1"> <thead> <tr> <th>REF</th> <th>MICRON</th> <th></th> <th></th> <th>BRACKET</th> </tr> </thead> <tbody> <tr> <td>REC24950</td> <td>25</td> <td>1/4"</td> <td>50 GPH</td> <td>AL</td> </tr> <tr> <td>REC24952</td> <td>10</td> <td>1/4"</td> <td>50 GPH</td> <td>AL</td> </tr> </tbody> </table>	REF	MICRON			BRACKET	REC24950	25	1/4"	50 GPH	AL	REC24952	10	1/4"	50 GPH	AL			
REF	MICRON			BRACKET														
REC24950	25	1/4"	50 GPH	AL														
REC24952	10	1/4"	50 GPH	AL														

FILTRO DECANTADOR DE COMBUSTIBLE COMPLETO CON VASO TRASPARENTE



COMPLET FUEL FILTER WITH TRANSPARENT BOWL

FILTRO DI DECANTAZIONE BENZINA COMPLETO CON VASCHETTA TRASPARENTE

FILTRE SÉPARATEUR EAU-ESSENCE AVEC BOL TRANSPARENT

REF	OEM		BRACKET 	
RAC320R-RAC-01			AL	F75-150 HP
RAC320R-RAC-03	8M0097838	RACS3213 LENS3213	Plástico Plastic Plastica Plastique	SeaPro (2014-)



REF			BRACKET 
RECOBFILALU			AL
RECOBFILTER	RECOBELEMENT LENS3213	150 l/h	Plástico Plastic Plastica Plastique



REF		MICRON		
REC90794-46866	REC90794-46868	10	117 l/h	175 hp



LLAVE PARA FILTRO
FILTER KEY
CHIAVE DA FILTRO
CLÉ A FILTRE



REF
RECYS-225-15



REF	MICRON	
PAF40-0701000EI	10	70 hp



new

REF		MICRON		
RAC120R-RAC-01	RACS3240 LENS3227	10	114 l/h	50 - 115 hp

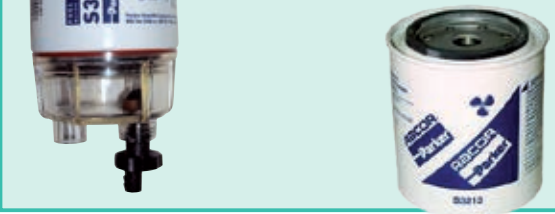

new

FILTRO DECANTADOR GASOLINA

COMPLETE FUEL FILTER

FILTRO DECANTATORE BENZINA

FILTRE DÉCANTEUR POUR ESSENCE

RACOR



	RAC120R-RAC-01	RAC320R-RAC-01	RAC320R-INOX-01	RAC320R-RAC-02
	114 l/h 30 gph	340 l/h 60 gph	340 l/h 60 gph	340 l/h 60 gph
	RACS3240	RACS3213	RACS3213	RACS3220UL
CAZOLETA TRANSPARENTE (sólo se recomienda para fueraborda.) CLEAR BOWL (Just for outboards) VASCHETTA TRASPARENTE (Solo nei fuoribordo.) BOL TRANSPARENT (Uniquement recommandé pour les hors-bord.)	✓	✓	✓	✗
ROSCAS CENTRALES CENTRAL THREADS FILETTO CENTRALE FILETAGES CENTRAUX	M18 x 1.5	1 1/4"	1 1/4"	1 1/4"
TAMAÑO ROSCA CABEZA HEAD PORT SIZE DIMENSIONE VITE TESTA TAILLE DU FILETAGE DE TÊTE	1/4-18 NPTF	1/4-18 NPTF	1/4-18 NPTF	1/4-18 NPTF
X Ø	166 x 81 mm	238 x 102 mm	238 x 102 mm	238 x 102 mm
	0,5 kg	0,9 kg	0,9 kg	0,9 kg
CAIDA DE PRESIÓN PRESSURE DROP CADUTA DI PRESSIONE CHUTE DE PRESSION	0.15 PSI 0.01 bar	0.61 PSI 0.04 bar	0.61 PSI 0.04 bar	0.61 PSI 0.04 bar
MAX	7 PSI 0.05 bar	7 PSI 0.05 bar	7 PSI 0.05 bar	7 PSI 0.05 bar
DESMONTAJE CARTUCHO-CAZOLETA ELEMENT REMOVAL UNDERBOWL RIMOZIONE DELLA CARTUCCIA DEMONTAGE DE LA CARTOUCHE	25,4 mm 1"	25,4 mm 1"	25,4 mm 1"	25,4 mm 1"
	-40°C +124°C			

ELEMENTOS DE RECAMBIO

ELEMENT

ELEMENTI DI RICAMBIO

CARTOUCHE DE RECHANGE

REF	FILTRO FILTER FILTRO FILTRE
RACS3240	RAC120R-RAC-01
LENS3240	
RACS3227	Yamaha-Suzuki
LENS3227	
RACS3213	RAC320R-RAC-01
RACS3213	RAC320R-RAC-01 INOX
LENS3213	RAC320R-RAC-03
RACS3214	Johnson & Evinrude
RACS3228UL	RAC320R-RAC-02, (bracket RACOR)

LENS3240
LENS3227
LENS3214



RACS3240
RACS3227
RACS3214



RACS3228UL

FILTRO CON POMBA CEBADORA

FILTER WITH PRIMMING PUMP

FILTRO CON PEMPETA PER RIEMPIRE

FILTRE ESSENCE AVEC POMPE D'AMORCAGE



REF	R.O. OEM		MICRON			
RAC490R-RAC-01	8M0097838	RACS3227 LENS3227	10	340 l/h	3/8" NPTF	150 hp



RACOR

JOHNSON EVINRUDE

RECAMBIOS MARINOS

Filtro de combustible con braket.

Complete fuel filter with braket.

Filtro combustibile con supporto.

Filter à carburant avec support.

REF		
RAC23299-10	RAC23289-10	130 HP (4 T/ Strokes)

RACOR.



LLAVES PARA FILTRO

FILTER KEY

CHIAVE DA FILTRO

CLÉ À FILTRE

REF
RACRK22628

RACOR.



REF	65 - 110 mm
REC70720	

RECMAR

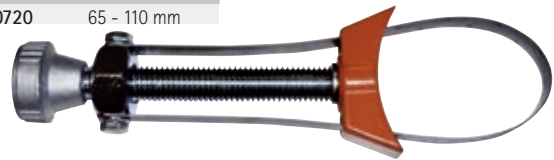



RACOR DE LATÓN



RACOR MADE IN BRASS

RACCORDO IN OTTONE

RACCORD EN LAITON

REF			
GS31065	1/4" NPT	3/8" = 9.5 mm	1
GS31166	1/4" NPT	5/16" = 7.9 mm	2
GS31155	3/8" NPT	3/8" = 9.5 mm	2
GS31156	3/8" NPT	5/16" = 7.9 mm	2
GS31157	3/8" NPT	1/4" = 6.4 mm	2



REF	R.O. OEM			
GS31066	22-8977102	1/4" NPT	5/16" = 7.9 mm	2
GS31067	22-34982	1/4" NPT	3/8" = 9.5 mm	2

GOLDENSHIP







FILTRO COMBUSTIBLE PARA MONTAJE EN LINEA



IN-LINE FUEL FILTER

FILTRO BENZINA PER MONTARE IN LINEA



FILTRE A ESSENCE EN LIGNE

REF					GOLDENSHIP
GS31001	50 l/h	6-8 mm	plástico plastic plastique	1	
GS31002	150 l/h	8-10 mm	plástico plastic plastique	1	



REF	OEM			
REC40145	0354016	1/4"	1/4"	plástico plastic plastique
REC40155		5/16"	5/16"	
REC40165		3/8"	3/8"	
REC40135	398327 398319	5/16"	3/8"	



REF			
GS30435	6, 8, 10 mm	metal + cristal metal + crystal metallo + cristallo métal + cristal	1



GOLDENSHIP

REF	OEM		2T STROKES	4T STROKES
REC15410-87J30	5035974		J/ BJ25 HP BJ60, BJ70 HP J/ BJ90 HP J/ BJ115 HP J/ BJ140 HP (2005+)	✓





REF	OEM		2T STROKES	4T STROKES
REC15410-98500	5032238		✓	✓

E40, E50, E70
J4, J5, J6, J10, J15, J40, J50, J60, J70
BJ40, BJ50, BJ60, BJ70
(2000+)



REF	OEM		E-TEC 40, 50, 60, 75, 90, 115, 150, 175, 200 DPL	2T STROKES	4T STROKES
REC5007335	5007326 5005266	3/8"		✓	





REF	OEM		2T STROKES	4T STROKES
REC15410-93J00	5034984		✓	

200-225 HP
V6





new

REF	OEM		4 Et6 HP (1 CYL) (2012-15) 9.8 HP (2 CYL) (2012-15) 15 HP (2CYL) (2012-14)	2T STROKES	4T STROKES
PAF4-05000300	5040140			✓	✓



new

REF	OEM		E25, E30, E40, E50, E70 J30, J40, J50, J60, J70, J90, J115, J140 BJ40, BJ50, BJ60, BJ70, BJ90, BJ115, BJ140 (2000+)
REC15410-87J10	5032323 5030702		



REF	OEM		E5RECS (1998-01) E5RLECS (1998-01)	2T STROKES	4T STROKES
REC16910-GB2-005	5030183			✓	



new

REF	OEM		60° V4 Et V6 (1991-06)
REC433190	433190 765553		



REF	OEM		200-225 HP V6	2T STROKES	4T STROKES
REC65L-24563-00	5035695 0778162			✓	✓



new

KIT FILTRO COMBUSTIBILE FUEL FILTER KIT KIT FILTRO BENZINA KIT FILTRE A ESSENCE

REF	OEM
REC35-49088A2	312456
REC981911	981911



REC35-49088A2 REC981911

ELEMENTO FILTRO COMBUSTIBILE FUEL FILTER ELEMENT CARTICIA FILTRO BENZINA ELEMENT FILTRE A ESSENCE

REF	OEM
REC982230	982230



FILTRO COMBUSTIBLE - CARBURADOR

FUEL FILTER - CARBURETOR

FILTRO BENZINA - CARBURATORE

FILTRE A ESSENCE DE CARBURATEUR

REF	OEM
REC984491	984491



REF	OEM
REC305185	305185



REF	OEM
REC1397-2150	983870 910139



REF	OEM
REC308239	308239



REF	OEM
REC35-53336	908034



FILTRO COMBUSTIBLE ALTA PRESIÓN

FUEL FILTER HIGH PRESSURE

FILTRO BENZINA ALTA PRESSIONE

FILTRE A ESSENCE HAUTE PRESSION

REF	OEM	2T STROKES	4T STROKES
REC15440-93J00	5034985	BJ/J200, BJ/J225 6 Cyl (2004-07)	✓



REF	OEM	2T STROKES	4T STROKES
REC15410-87J00	5031400	E40, 50 J40, 50 BJ40, 50 (1999+)	✓



REF	OEM	2T STROKES	4T STROKES
REC15440-99E01	5030706	60, 70 HP (1998-02)	✓



new

REF	OEM	2T STROKES	4T STROKES
REC15440-90J00	5033704	90-140 HP	✓



new

FILTRO COMBUSTIBLE VST BAJA PRESIÓN

FUEL FILTER VST LOW PRESSURE

FILTRO BENZINA VST BASSA PRESSIONE

FILTRE À ESSENCE BASSE PRESSION

REF	OEM	2T STROKES	4T STROKES
REC69J-24501-10	5034995	200, 225 HP V6 (2004-07)	✓





new

FILTRO DE ACEITE



OIL FILTER

FILTRO OLIO



FILTRE A HUILE

REF	OEM		2T STROKES	4T STROKES
REC16510-05240	5033102, 7		9.9 - 15 HP (2002-07)	✓
 REC09280-54001	5033009			





REF	OEM		2T STROKES	4T STROKES
REC16510-90J00	5033539 778886		90-115 HP (2003+) EFI	✓





REF	OEM		2T STROKES	4T STROKES
REC434839	434839		9.9 Et 15 HP (1995-01)	✓
			70 HP (-1998)	





REF	OEM		2T STROKES	4T STROKES
REC16510-82703	5033919 778887		140 HP (2003+) EFI	✓



REF	OEM		2T STROKES	4T STROKES
REC16510-87J00	5031411 778885		25-70 HP (1998-05)	✓



REF	OEM		2T STROKES	4T STROKES
REC16510-93J00	5035703 778888		200-225 HP (2004+)	✓



JUNTA TAPON CARTER

OIL DRAIN PLUG GASKET

GUARNIZIONE TAPPO

JOINT DE VIDANGE

REF	OEM	
REC09168-12012	5030465	30HP+



REF	OEM	
REC09168-12017	5031863 5032987	4-30 HP





ACEITE



OIL

OLIO

HUILES

REF			
REC2TU6	1 L	6	2 STROKES
REC2TU3	5 L	3	TC-W3
REC5W40U6	1 L	6	SAE 5W40
REC5W40U3	5 L	3	
REC10W30U6	1 L	6	SAE 10W30
REC10W30U3	5 L	3	
REC10W40U6	1 L	6	SAE 10W40
REC10W40U3	5 L	3	
REC25W40U3	5 L	3	SAE 25W40
REC80W90U3	5 L	3	SAE 80W90
REC80W90U6	1 L	6	



REF			
RM92-858026QB1U6	1 L	6	2 STROKES
RM92-858027QB1U3	3,8 L	3	
RM92-8M0086220U6	1 L	6	SAE 10W30
RM92-8M0086221U3	4 L	3	



RM92-858026QB1U6 RM92-858027QB1U3 RM92-8M0086220U6 RM92-8M0086221U3

BOMBA DE COMBUSTIBLE

FUEL PUMP

POMPA BENZINA

POMPE À ESSENCE

BOMBA DE COMBUSTIBLE MECANICA

FUEL PUMP MECHANICAL

POMPA BENZINA MECCANICA

POMPE À ESSENCE MECANIQUE

REF	OEM		2T STROKES	4T STROKES
PAF4-04090000	5037518 5033371		4, 5, 6 HP	✓





REF	OEM		2T STROKES	4T STROKES
REC1399-07351	438562		9,9, 15 HP (1993-02)	✓



REF	OEM		2T STROKES	4T STROKES
REC1399-07350	397839		6, 8, 9,9, 15 HP	✓



REF	OEM		2T STROKES	4T STROKES
REC1399-07353	438555		20 - 30 HP (1990-00)	✓



REF	OEM		2T STROKES	4T STROKES
REC1399-07352	438556	25 - 50 HP (1976-99) Sin VRO Without VRO Senza VRO Sans VRO		✓



REF	OEM		2T STROKES	4T STROKES
REC438559	0438559 0765591	EVINRUDE: BE25, BE35, E25, E35, SE105, SE125 JOHNSON: BJ25, J25, J115, SJ125 (1997-05)		✓



BOMBA DE COMBUSTIBLE ELECTRICA **FUEL PUMP ELECTRIC**

REF	OEM		2T STROKES	4T STROKES
REC63P-13907-03	5032617 5033702 5036635 5030700	E40, J40, BJ40 E50, J50, BJ50 E70, J70, BJ70 J60, BJ60 (2001-06)		✓



POMPA BENZINA ELETTRICA **POMPE À ESSENCE ELECTRIQUE**

REF	OEM		2T STROKES	4T STROKES
REC5004428	5004428 5000800 0439347	75 HP (2000-03) 90 HP (1998-03) 100 HP (2004-05) 115 HP (1998-06) 135 HP (2000-06) 150 Et 175 HP (1999-06) 4 Et 6 CYL (3.600 Bore)		✓

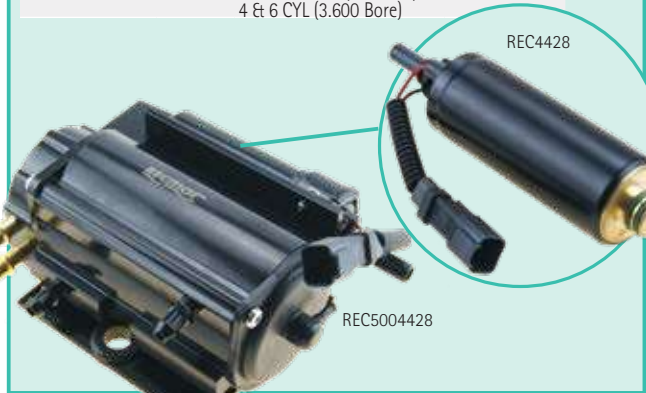

JUNTAS BOMBA DE COMBUSTIBLE **FUEL PUMP GASKETS**

REF	OEM	
REC338876	338876	
REC303615	303615	

GUARNIZIONI POMPA **JOINTS POMPE À ESSENCE**

REF	OEM	
REC338879	338879	

KITS BOMBA COMBUSTIBLE **KIT, FUEL PUMP**

REF	OEM	
REC398514	398514	

KIT POMPA BENZINA **KIT POMPE ESSENCE**

REF	OEM	
REC393088	393088	

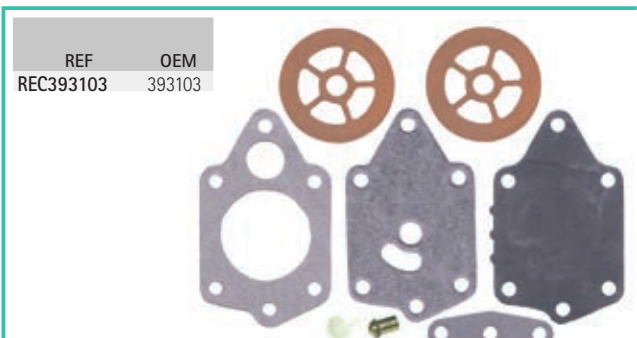
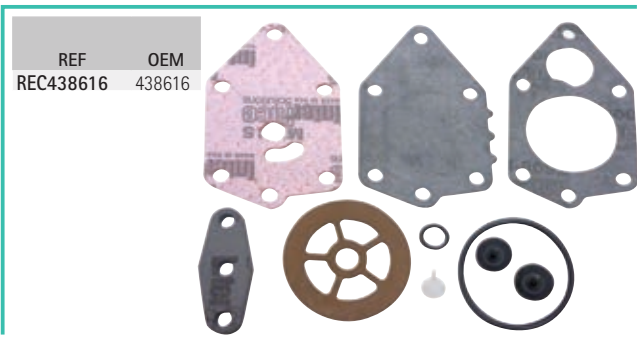

VÁLVULA CHECK VALVE VALVOLA SOUPAPE



KIT MEMBRANAS DIAPHRAGM SET



KIT MEMBRANA KIT DIAPHRAGME

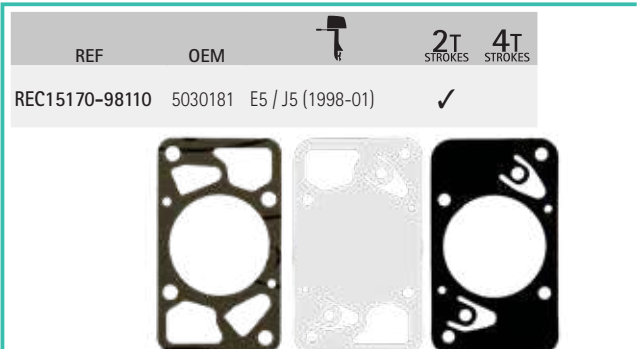

JUNTAS VST VST GASKETS

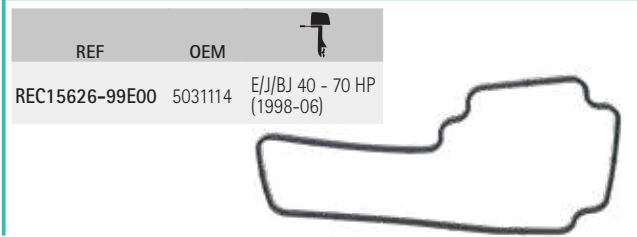

GUARNIZIONE VST JOINTS VST

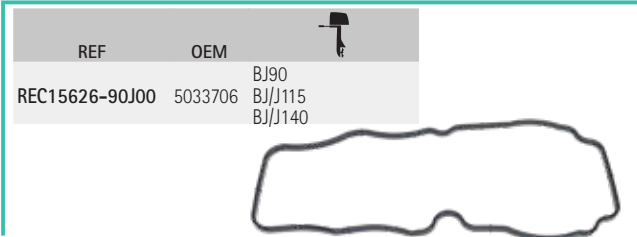

GUÍA DE MEMBRANAS DIAPHRAGM SET APPLICATION GUIDA MEMBRANA GUIDE DIAPHRAGME

	OE	REF	2T STROKES	4T STROKES
2,5	1987-88	REC393088		
4	1982-95	REC393088		
4, 5, 6	2003-07	REC15170-91J00		✓
4.0 Deluxe	1992-93	REC393088		
4.5	1982-87	REC393088		
5	1985-93	REC393088		
5	1998-01	REC15170-98110		✓
6	1986-93	REC393088		
6.5	1989-90	REC393088		
7.5	1982-83	REC393088		
8	1984-93	REC393088		
9.9, 15	1981	REC393103		
9.9, 15	1982-92	REC393088		
9.9, 15 elec.	1990	REC438616		
9.9, 15	2005-07	REC15170-94J00		✓
10/14	1989-90	REC393088		
J10 - J70	1998-07	REC15170-99E00		
14	1988	REC393088		
20, 25	1982-84	REC393103		
20, 25, 30	1987	REC398514		
20, 25	1988-89	REC432962		
20, 25, 30 Ro	1990	REC432962		
20, 30	1990	REC438616		
20, 30, 35 Re	1990	REC432962		
20, 35 Rope	1989-90	REC432962		
25 Com	1982	REC393103		
25 Com	1988-90	REC432962		
E25, E30, E40, E50, E70	1998-07	REC15170-99E00		
28	1987	REC398514		
30	1984	REC393103		
40	1987	REC398514		
40	1990	REC438616		
40/50	1988	REC432962		
BJ40 - BJ70	1998-07	REC15170-99E00		

	OE	REF	2T STROKES	4T STROKES
45, 55	1985-86	REC398514		
45, 55	1987	REC398514		
45, 55 Com	1989-90	REC398514		
45, 48, 50	1989	REC438616		
48	1987	REC398514		
48	1988-90	REC432962		
48	1987	REC398514		
48	1988	REC432962		
48, 50	1990	REC432962		
50, 60	1982-84	REC393103		
55	1983	REC393103		
55 Com	1984	REC393103		
60	1988	REC398514		
65	1985-87	REC393103		
65	1990	REC398514		
65 Com	1984	REC393103		
65 Com	1988-89	REC398514		
70/75	1982-84	REC393103		
70	1990	REC398514		
80	1978-83	REC393103		
88	1987	REC398514		
88/90/110	1988-89	REC398514		
88/90/100/115	1990	REC398514		
90/115	1983	REC393103		
90/115/140	1982	REC393103		
100 Com	1989-90	REC398514		
115 Com	1989-90	REC398514		
V4 140	1983	REC393103		
150/175/200	1982	REC393103		
V6 150/175	1983	REC393103		
155 Com	1989-90	REC398514		
V6 235	1983	REC393103		
2.6	1984	REC398514		
3.0	1991-93	REC393088		

INYECTORES INJECTOR INNIETTORE INJECTEURS

INYECTOR COMBUSTIBLE FUEL INJECTOR INNIETTORE COMBUSTIBILE INJECTEURS ESSENCE

REF	OEM		2T STROKES	4T STROKES
REC15710-66D00	5032693	60HP (4 CYL) (2002-06) 70 HP (4 CYL) (2001-06)		✓



REF	OEM		2T STROKES	4T STROKES
REC15710-65D00	5033708	90, 100, 115 HP (4 CYL) (2003-06)		✓





new

REF	OEM		2T STROKES	4T STROKES
REC15710-87J00	5031403	40, 50HP (3 CYL) (2002-06)		✓



REF	OEM		2T STROKES	4T STROKES
REC15710-99E00	5030708	70HP (4 CYL) (1998-00)		✓



REF	OEM	 2T	 4T
		STROKES	STROKES
REC15710-93J00	5035010	200, 225HP (2004-06)	✓

new





P 38

REF
STA93008
STA93016



P 38

REF
GE22207

CARBURADOR

CARBURATOR

CARBURATORE

CARBURATEUR

CARBURADOR COMPLETO

FULL CARBURATOR

CARBURATORE COMPLETO

CARBURATEUR COMPLET

REF	OEM	 2T	 4T
		STROKES	STROKES
REC13200-91J70	5036549 5036191 5036192	4, 5, 6 HP	✓

new



KITS CARBURADORES

CARBURETOR KITS

KIT CARBURATORI

KIT CARBURATEUR

REF	OEM
REC438996	435442 438996



REF	OEM
REC439071	439071 398532 383067 383052 382049





REF	OEM
REC439078	435752 439078 435678 43577 435676





REF	OEM
REC439072	439072 398452 391305 398453



REF	OEM	
REC13910-89J01	5032424	E25 / J25 E30 / J30 (2000-06)



REF	OEM	
REC18-7761	4, 8 HP (2007)	



REF	OEM
REC396701	396701 398729 392061



REF	OEM
REC439076	439076 434888 435443 398526 392550



REF	OEM
REC439074	4359073



REF	OEM
REC439075	439074 439075



REF: GEGC15

BOYAS		FLOATS		GALLEGGIANTE		FLOTTEUR DE CARBURATEUR	
REF	OEM	REF	OEM	REF	OEM	2T STROKES	4T STROKES
REC382363	382363			REC13250-95D01	5033086	10, 15 HP (2cyl)	✓



new

KIT AGUJA CARBURADOR		NEEDLE VALVE, KIT	KIT SPILLO CONICO CARBURATORE	KIT SIEGE, POINTEAU ET GICLEUR
REF	OEM		REF	OEM
REC387262	379312 387262		REC396521	378895 396521 678882
REF	OEM		REF	OEM
REC396522	379312 396522		REC396520	396520

RETENEDOR	RETAINER	FERMO	RETENUE
REF	OEM		
REC315232	315232	5 - 75 HP	

KIT DE VÁLVULA	VALVE KIT	KIT VALVOLA	KIT SOUPAPE
REF	OEM		
REC18-7044		9.9, 15 HP	

LEVA ACELADOR	ACCELERATOR CAM	CAMMA ACCELERATORE	CAME D'ACCELÉRATEUR
REF	OEM		
REC0323327	0323327	2 - 15 HP	new

GUÍA KITS CARBURADOR	GUIDE, CARBURATOR KIT	GUIDA KIT CARBURATORE	GUIDE KITS CARBURATEURS
----------------------	-----------------------	-----------------------	-------------------------

KIT				KIT				KIT																															
2	3	3	4	4	4	4.5	5	5	5	5.5	6	6	6	6	7.5	7.5	8	8	8	8	9.9	9.9	14	15	15	18	20	20	20	20	25	SAIL	DR	25	25				
1970-90	1952-67	1968	1965-78	1983-89	1991-93	2007	1982-84,87	1965-67	1968	1984-85	1954-67	1954-79	1968	1984-85	1986	1955-58	1982-83	1984-85	1986	2007	1974-88	1989	1968	1989	1974-88	1957-68	1969-73	1957-68	1969-90	1991-97	1991-95	1954-55	1978-90	1969-95	1991-95				
REC439071	REC439071	REC439071	REC439071	REC439072	REC18-7761	REC439072	REC439071	REC439075	REC439072	REC439071	REC439071	REC439071	REC439075	REC439072	REC439074	REC439071	REC439072	REC439072	REC439074	REC18-7761	REC439072	REC439074	REC439072	REC439072	REC439071	REC439071	REC396701	REC396701	REC396701	REC439074	REC439078	REC439075	REC396701	REC396701	REC396701	REC439078			
REC396522	REC396521	REC396522	REC396522	REC396522		REC396522	REC396522	REC396521	REC396522	REC396522	REC396522	REC396522	REC396521	REC396522	REC396522	REC396522	REC396522	REC396522	REC396521	REC396522	REC396522	REC396522	REC396522	REC396522	REC396522	REC396521	REC396521	REC396522	REC396522	REC396521	REC396521	REC396521	REC396521	REC396521	REC396521	REC396521	REC396521		
25 (4T/Stroke)	28	28	28	30	30	30	30	33	35	35	35	35	40	40	40	45	45	48	50	50	55	55	60	60	60	60	65	65	70	70	75	85	85	V-4	88, 90				
2004	1962-64	1976-95	1992-93	1956	1976-95	1991-93	2004	1965-70	1957-59	1976-95	1991-3	1960-63	1965-78	1971-92	1993	1971-95	1992	1992-95	1958-59	1993	1968-69	1971-95	1992	1964-67	1970-95	1992-93	1972-95	1992-93	1975-88	1971-79	1969-70	1991-93	1969-79	1983-84	1985-95				
REC13910-89J01	REC439075	REC396701	REC439078	REC396521	REC396701	REC439078	REC13910-89J01	REC439075	REC439075	REC396701	REC439078	REC439075	REC439075	REC396701	REC439078	REC396701	REC439078	REC439078	REC396701	REC396701	REC396701	REC396701	REC439078	REC439078	REC396701	REC396701	REC439078	REC396701	REC396701	REC439078	REC439078	REC439078	REC439078	REC439078	REC439078	REC439078	REC439078		
90	100	100	100	100	110	115	115	V-6	115	120	125	125	125C	135	140	140	140	140	140	150	150 C	150	155	175	175	185	185	200	200	200	200	225	235	250	275 (3.6L)	300			
1981-83	1971, 980	1972, 979	1985-95	1985-90	1969	1980-95	1970	1973-79	1976-90	1983	1985-94	1971-72	1993-94	1989-95	1973-76	1977	1980-83	1978-79	1986-90	1993-94	1979-90	1993	1992-93	1984-93	1977-91	1992-93	1984	1989-93	1976-83	1987-90	1992-93	1986-93	1978-84	1991-93	1985-88	1988	1991-93		
REC439076	REC439076	REC439076	REC439076	REC439076	REC439076	REC439076	REC439076	REC439076	REC439076	REC439078	REC439078	REC396521	REC439078	REC439078	REC439078	REC439076	REC439076	REC439076	REC439078	REC439078	REC439078	REC439078	REC439078	REC439078	REC439078	REC439078	REC439078	REC439078	REC439078	REC439078	REC439078	REC439078	REC439078	REC439078	REC439078	REC439078	REC439078	REC439078	REC439078

SISTEMA ELÉCTRICO ELECTRIC SYSTEM

SISTEMA ELETTRICO SYSTÈME ELECTRIQUE

SENSORES	SENSORS	SENSORE	CAPTEURS
SENSOR MAP/MAT	MAP/MAT SENSOR	SENSORE MAP/MAT	CAPTEUR MAP/MAT

REF	OEM		2T STROKES	4T STROKES
REC18590-72F21	5033780	200, 225 HP 90, 115, 140 HP		✓



new

SENSOR IAT	IAT SENSOR	SENSORE IAT	SONDE IAT
------------	------------	-------------	-----------

REF	OEM		2T STROKES	4T STROKES
REC13650-52G00	5031392	40, 50, 90, 115, 140, 200, 225 HP		✓



new

REF	OEM		2T STROKES	4T STROKES
REC13650-56B00	5030687	60, 70 HP		✓



new

SENSOR IAC	IAC SENSOR	SENSORE IAC	SONDE IAC
------------	------------	-------------	-----------

REF	OEM		2T STROKES	4T STROKES
REC18137-52D00	5035412	200, 225 HP (2003-08)		✓



new

SENSOR CMP	CMP SENSOR	SENSORE CMP	SONDE CMP
------------	------------	-------------	-----------

REF	OEM		2T STROKES	4T STROKES
REC33220-76G02	5031468 5032786	40, 50, 90, 115, 140 HP		✓



new

BOBINAS

COILS

BOBINE

BOBINES

BOBINA

COIL

BOBINA

BOBINE

REF	OEM
REC0502880	581407
REC0502881	502881 581786



REF	OEM	2T STROKES	4T STROKES
REC33410-94400-000	5032732	10 - 15 HP (2002-04)	✓



REF	OEM
REC0502888	582888 582091



REF	OEM
REC584561	584561 582366 583737



REF	OEM
REC0502890	502890 582160 584632



REF	OEM
REC0583740	583740



REF	OEM
REC0582508	582508



REF	OEM
REC0584477	584477

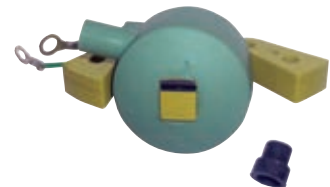

GUÍA DE BOBINAS

GUIDE, COILS

GUIDA BOBINA

GUIDE DES BOBINES

KIT				KIT				KIT			
REF	YR	REF	UNIT	REF	YR	REF	UNIT	REF	YR	REF	UNIT
1.5, 2 COLT, JR.	1968-90	REC0584477	1	8	1985-90	REC0582508	2	25	1973-76	REC0502881	2
2, 2.2, 3	1995	REC0583740	1	9.5	1964-73	REC0584477	2	25	1977-84	REC584561	2
3	1952-68	REC0584477	1	9.9, 15	1974-76	REC0502880	2	25	1985	REC0582508	2
4	1950-76	REC0584477	1	9.9, 15	1977-84	REC584561	2	25 COMM	1985-91	REC0582508	2
4	1981-89	REC0584477	1	9.9, 15	1985	REC0582508	2	25 COMM	1956-70	REC0584477	2
4 DELUXE	1977-80	REC584561	1	9.9, 15	1985	REC0583740	1	28	1987-88	REC584561	2
4.5	1980-84	REC584561	2	9.9, 15	1989-95	REC584561	2	28	1997-98	REC0583740	2
4.5	1986-87	REC0582508	2	9.9, 15 (4T/Stroke)	1994	REC33410-94400-000	2	28	1989	REC0582508	2
5	1950-76	REC0584477	2	10 - 15	2002-04	REC0584477	2	30	1956-70	REC0584477	2
5	1985-91	REC0582508	2	10	1951-63	REC584561	2	30	1977-84	REC584561	2
5.5 - 6	1950-76	REC0584477	2	10, 14 COMM	1989-90	REC584561	2	30	1985	REC0582508	2
6	1977-84	REC584561	2	14	1988	REC584561	2	33,35	1956-70	REC0584477	2
6	1985-90	REC0582508	2	15	1951-72	REC0584477	2	35	1976	REC0502881	2
6.5 COMM	1989-90	REC0582508	2	18	1951-72	REC0584477	2	35	1977-84	REC584561	2
6.8	1991-99	REC0583740	1	18,2	1973	REC0502881	2	40	1960-73	REC0584477	2
7.5	1954-58	REC0584477	2	20	1951-72	REC0584477	2	40	1974	REC0502880	2
7.5	1980-84	REC584561	2	20	1985	REC0582508	2	40 (B)	1975-83	REC0502881	2
8	1980-84	REC584561	2	25	1951-72	REC0584477	2	40	1977-84	REC584561	2
								40	1985-88	REC0582508	2

KIT				UNIT				KIT				UNIT			
40 COMM	1985-90	REC0582508	2	85	1978-84	REC584561	4	150	1976-78	REC0502888	1				
45 COMM	1985-92	REC0582508	2	85	1985	REC0582508	4	150	1979-84	REC584561	6				
45 SS	1987-90	REC0582508	2	88	1987	REC0582508	4	150 (A)	1985	REC0582508	6				
45	1989-96	REC0583740	2	90	1978-84	REC584561	4	155 COMM (A)	1984	REC0582508	6				
48	1987	REC0582508	2	90	1985-94	REC0582508	4	2500 CC	1988	REC0582508	6				
50	1971-75	REC0502890	2	90	1995-99	REC0583740	2	175 V6	1991-99	REC0583740	3				
50	1978-84	REC584561	2	100	1971-72	REC0582382	1	175	1976-78	REC0502888	6				
50	1985-88	REC0582508	2	100	1978-84	REC584561	4	175	1979-84	REC584561	6				
55	1978-84	REC584561	2	100	1985	REC0582508	4	175 (A)	1985	REC0582508	6				
60	1978-84	REC584561	2	1600 CC	1988	REC0582508	4	185	1984	REC0582508	6				
60	1985	REC0582508	3	110	1986-90	REC0582508	4	200	1976-78	REC0502888	6				
60 SST	1989-90	REC0582508	3	115	1969-70	REC0582382	1	200	1979-84	REC584561	6				
65	1971-75	REC0502890	3	115	1973-74	REC0502890	4	200	1985	REC0582508	6				
65	1979-84	REC584561	3	115	1976-77	REC0502888	4	225	1986	REC0582508	6				
65 COMM	1985	REC0582508	3	115	1978-94	REC584561	4	235	1976-78	REC0502888	6				
70	1974-75	REC0502890	4	120	1985	REC0582508	4	235	1979-84	REC584561	6				
70	1979-84	REC584561	3	125	1971-72	REC0582382	1	250	1991	REC0582508	8				
70	1985	REC0582508	3	125	1991	REC0582508	4	275	1985	REC0582508	8				
70	1974-74	REC0502890	1	125 COMM	1989	REC0582508	4	300, 3.6	1985	REC0582508	8				
75	1979-84	REC584561	3	135	1973-75	REC0502890	4	SAIL DRIVE	1978-84	REC584561	2				
75	1985	REC0582508	3	135	1976	REC0502888	4	SAIL DRIVE	1985	REC0582508	2				
85	1969-72	REC0582382	1	135	1977	REC0502888	4								
85	1973-75	REC0502890	1	140	1978-84	REC584561	4								
85	1976-77	REC0502888	4	140	1985	REC0582508	4								

BUJÍAS SPARK PLUG CANDELE BOUGIES

JOHNSON

		NGK		CHAMPION		2T	4T			NGK		CHAMPION		2T	4T
						STROKES	STROKES							STROKES	STROKES
2.0 Excel 4, Ultra	1988-87	NGKB7HS	CHAUL81C					9.9, 2 T, OHC	2001-77	NGKBR7HS	CHAQL82C	CHAL82C			
2.0 Colt, Jr	1990-71	NGKBR6S	CHARJ8C	CHAJ8C				10 COM	2003-94	NGKBR7HS	CHAQL82C	CHAL82C			
2.0, 2R	1984-71	NGKBR6S	CHARJ8C	CHAJ8C				10 COM	1993-92	NGKBZ7HS-10	CHAQL77JC4	CHAL77JC4			
2.0 (1 Cyl)	2001-91	NGKBPR6HS	CHAQL87YC	CHAL87YCC				10 COM	1982-81		CHAL77JC4	CHAL78V			
2.3 (1 Cyl)	1998-91	NGKBPR6HS	CHAQL87YC	CHAL87YCC				14 COM	1991-81	NGKBZ7HS-10	CHAQL77JC4	CHAL77JC4			
2.5	1988-87	NGKBR6HS	CHAQL82C	CHAL82C				14	1989-88	NGKBZ7HS-10	CHAQL77JC4	CHAL77JC4			
3.0 (2 Cyl)	1997-89	NGKBR6HS	CHAQL82C	CHAL82C				15 Kero	1998-95	NGKBUHXW-1	CHAUL77V	CHAQL82C			
3.3 (1 Cyl)	2003-91	NGKBPR6HS	CHAQL87YC	CHAL87YCC				15 COM	2001-94	NGKBR7HS	CHAQL82C	CHAL82C			
4.0 Excel, Ultra	1988-87	NGKBZ7HS-10	CHAQL77JC4	CHAL77JC4				15 COM	1993-92	NGKBZ7HS-10	CHAQL77JC4	CHAL77JC4			
4.0 (2 Cyl)	2003-89	NGKBR6HS	CHAQL82C	CHAL82C				15 OHC	2003-95	NGKDCPR7E	CHARA8HC			✓	
4.0	1988	NGKBZ7HS-10	CHAQL77JC4	CHAL77JC4				15	2001-94	NGKBR7HS	CHAQL82C	CHAL82C	✓		
4.0	1987-77	NGKBR6HS	CHAQL82C	CHAL82C				15	1992-77	NGKBZ7HS-10	CHAQL77JC4	CHAL77JC4			
4.0	1984-81	NGKBZ7HS-10	CHAQL77JC4	CHAL77JC4				15	1980-78		CHAL78V				
4.0	1976-69	NGKBR6S	CHARJ8C	CHAJ8C				15	1976-74	NGKB7HS	CHAUL81C	CHARJ8C			
4.5	1985-80	NGKBR6HS	CHAQL82C	CHAL82C				18 Jet (2 Cyl)	1998-95	NGKBR7HS	CHAQL82C	CHAL82C			
5.0 Angler	1968-65	NGKBR6S	CHARJ8C	CHAJ8C				20 Jet (2 Cyl)	2001-99	NGKBR7HS	CHAQL82C	CHAL82C			
5.0 (1 Cyl)	2001-98	NGKBZ7HS-10	CHAQL77JC4	CHAL77JC4				20, (2 Cyl)	1998-78	NGKBR7HS	CHAQL82C	CHAL82C			
5.0	1997-90	NGKBR6HS	CHAQL82C	CHAL82C				20	1993-78	NGKBR7HS	CHAQL82C	CHAL82C			
6.0, 6R, 6RL	1976-71	NGKBR6S	CHARJ8C	CHAJ8C				25 COM	2002-81	NGKBUHXW-1	CHAUL77V	CHAQL82C			
6.0	2001-77	NGKBR6HS	CHAQL82C	CHAL82C	✓			25, (3 Cyl)	2001-95	NGKBR6HS	CHAQL82C	CHAL82C			
6.0	1976-65	NGKBR6S	CHARJ8C	CHAJ8C				25, E,EL,R,RL	1976-73	NGKBR6S	CHARJ8C	CHAJ8C			
6.5 COM	1993-81	NGKBR6HS	CHAQL82C	CHAL82C				25, (2 Cyl)	2002-77	NGKBR7HS	CHAQL82C	CHAL82C			
7.5	1997-77	NGKBR6HS	CHAQL82C	CHAL82C				25	1976-69	NGKBR6S	CHARJ8C	CHAJ8C			
8.0 COM	2001-77	NGKBR6HS	CHAQL82C	CHAL82C				28, SPL, (2 Cyl)	1997-78	NGKBR7HS	CHAQL82C	CHAL82C			
8.0	2001-77	NGKBR6HS	CHAQL82C	CHAL82C	✓			28 Jet	2003-92	NGKBPZ8HS-10	CHAQL78YC	CHAL78YC			
9.9 4 T, OHC	2003-95	NGKDCPR7E	CHARA8HC					30 Jet (2 Cyl)	2001-99	NGKBPR7HS	CHAQL78YC	CHAL78YC			
9.9, 2 T SOHC	2003-02	NGKDCPR7E	CHARA8HC					30 OHC	2003-95	NGKDCPR7E	CHARA8HC	CHAQL82C		✓	
								30, (2 Cyl)	2002-78	NGKBR7HS	CHAQL82C	CHAL82C			

			NGK	CHAMPION	2T STROKES	4T STROKES
35 Jet (2 Cyl)	2003-93	NGKBPZ8HS-10		CHAQL78YC CHAL78YC		
35, (3 Cyl)	2001-95	NGKBR7HS				
35, (2 Cyl)	1997-77	NGKBZ7HS-10		CHAQL77JC4 CHAL77JC4		
40 Jet (3 Cyl)	2001-99	NGKBR7HS		CHAQL82C CHAL82C		
40 COM 45 cid	2003-84	NGKBUHXW-1		CHAUL77V		
40 COM 43 cid	1990-81	NGKBR7HS		CHAQL82C CHAL82C		
40, E,EL,R,RL	1976-75	NGKBZ7HS-10		CHAQL77JC4 CHAL77JC4		
40 DOHC	2003-02	NGKDPCR7E		CHARA8HC		✓
40, (2 Cyl)	2002-89	NGKBPZ8HS-10		CHAQL78YC CHAL78YC		
40, (2 Cyl)	1988-80	NGKBZ7HS-10		CHAQL77JC4 CHAL77JC4		
45 COM	2002-84	NGKBUHXW-1		CHAUL77V		
48, SPL (2 Cyl)	1997-94	NGKBPZ8HS-10		CHAQL78YC CHAL78YC		
48, (2 Cyl)	1997-89	NGKBPZ8HS-10		CHAQL78YC CHAL78YC		
48, (2 Cyl)	1988-80	NGKBZ7HS-10		CHAQL77JC4 CHAL77JC4		
50, (3 Cyl)	1998-95	NGKBPZ8HS-10		CHAQL78YC CHAL78YC		
50, (2 Cyl)	2002-89	NGKBPZ8HS-10		CHAQL78YC CHAL78YC		
50, (2 Cyl)	1988-80	NGKBZ7HS-10		CHAQL77JC4 CHAL77JC4		
55 COM, (2 Cyl)	1995-94	NGKBPZ8HS-10		CHAQL78YC CHAL78YC		
55 COM	2003-86	NGKBUHXW-1		CHAUL77V		
55, (2 Cyl)	1989-76	NGKB7HS		CHAUL81C		
60 OHC	2005-02	NGKBPR6ES				✓
60, (3 Cyl) 56 cid	1998-94	NGKBPZ8HS-10		CHAQL78YC CHAL78YC		
60, (3 Cyl) 56 cid	1993-89	NGKBZ7HS-10		CHAQL77JC4 CHAL77JC4		
60, (3 Cyl) 49 cid	1989-75	NGKBZ7HS-10		CHAQL77JC4 CHAL77JC4		
60, (2 Cyl)	1985-80	NGKBZ7HS-10		CHAQL77JC4 CHAL77JC4		
65 COM, (3 Cyl)	1995-94	NGKBPZ8HS-10		CHAQL78YC CHAL78YC		
65 COM HC LC	2003-88	NGKBUHXW-1		CHAUL77V		
65 COM HC LC	1987-84	NGKBZ7HS-10		CHAQL77JC4 CHAL77JC4		
65 Jet CV4	1997-92	NGKBR7HS		CHAQL82C CHAL82C		
65, (3 Cyl)	1973-72	NGKBZ7HS-10		CHAQL77JC4 CHAL77JC4		
70, (3 Cyl) 56 cid	2001-97	NGKBPZ8HS-10		CHAQL78YC CHAL78YC		
70, (3 Cyl) 56 cid	1993-89	NGKBZ7HS-10		CHAQL77JC4 CHAL77JC4		
70, (3 Cyl) 49 cid	1989-75	NGKBZ7HS-10		CHAQL77JC4 CHAL77JC4		
75, (3 Cyl) 49 cid	1989-75	NGKBZ7HS-10		CHAQL77JC4 CHAL77JC4		
80 Jet CV4	2001-79	NGKBR7HS		CHAQL82C CHAL82C		
85, V4 Backtroller	1995-94	NGKBR7HS		CHAQL82C CHAL82C		
85	1993-86	NGKBZ7HS-10		CHAQL77JC4 CHAL77JC4		
85	1980-68	NGKB7HS		CHAUL81C		
88 CV4 SPL	1997-79	NGKBR7HS		CHAQL82C CHAL82C		
90 Turbojet CV4	1998-94	NGKBR7HS		CHAQL82C CHAL82C		
90 LV4 FFI	1998	NGKPZFR6H		CHAXC12PEPB		
90 LV4	2000-95	NGKBPZ8HS-10		CHAQL78YC CHAL78YC		
90 CV4	1998-79	NGKBR7HS		CHAQL82C CHAL82C		
100 V4	1980-79	NGKB7HS		CHAUL81C		
100 COM	2001-84	NGKBUHXW-1		CHAUL77V		

			NGK	CHAMPION	2T STROKES	4T STROKES
105 COM LV4	2003-97	NGKBPZ8HS-10		CHAQL78YC CHAL78YC		
105 LV6 105 Jet	2003-93	NGKBPZ8HS-10		CHAQL78YC CHAL78YC		
110 CV4	1997-79	NGKBR7HS		CHAQL82C CHAL82C		
112 CV4	1997-79	NGKBR7HS		CHAQL82C CHAL82C		
115 Turbojet CV4	1998-94	NGKB7HS		CHAUL81C		
115 LV4 FFI	1998	NGKPZFR6H		CHAXC12PEPB		
115 Fast Stike LV4	2002-95	NGKBPZ8HS-10		CHAQL78YC CHAL78YC		
115 CV4	1998-79	NGKBR7HS		CHAQL82C CHAL82C		
115 COM	1984-75	NGKB7HS		CHAUL81C		
115	1993-86	NGKBZ7HS-10		CHAQL77JC4 CHAL77JC4		
115	1979-73	NGKBZ7HS-10		CHAQL77JC4 CHAL77JC4		
115	1985	NGKBUHXW-1		CHAUL77V		
120 LV4	2003-85	NGKBPZ8HS-10		CHAQL78YC CHAL78YC		
125 COM	1972-71	NGKB7HS		CHAUL81C		
130 LV4	2003-85	NGKBPZ8HS-10		CHAQL78YC CHAL78YC		
135 Starflite	1984-73	NGKBUHXW-1		CHAUL77V		
140 LV4	2003-85	NGKBPZ8HS-10		CHAQL78YC CHAL78YC		
140	1984-73	NGKBUHXW-1		CHAUL77V		
150 LV6 FFI	1998-97	NGKPZFR6H		CHAXC12PEPB		
150 Fast Strike LV6	2002-91	NGKBPZ8HS-10		CHAQL78YC CHAL78YC		
150 CV6	1991-88	NGKBZ7HS-10		CHAQL77JC4 CHAL77JC4		
150 CV6	1987-78	NGKBUHXW-1		CHAUL77V		
150 COM LV6	1998-93	NGKBPZ8HS-10		CHAQL78YC CHAL78YC		
155 CV6	1987-78	NGKBZ8H		CHAQL16V		
155 COM CV6	1992-89	NGKBZ8H		CHAQL16V		
175 LV6 FFI	1998	NGKPZFR6H		CHAXC12PEPB		
175 Fast strike LV6	2002-91	NGKBPZ8HS-10		CHAQL78YC CHAL78YC		
175 CV6	1991-88	NGKBZ7HS-10		CHAQL77JC4 CHAL77JC4		
175	1987-77	NGKBUHXW-1		CHAUL77V		
185	1987-77	NGKBZ8H		CHAQL16V		
185	1993-90	NGKBZ7HS-10		CHAQL77JC4 CHAL77JC4		
200	1983-76	NGKBZ8H		CHAQL16V		
200 COM	1992	NGKBZ8H		CHAQL16V		
200 COM	1998-93	NGKBPZ8HS-10		CHAQL78YC CHAL78YC		
200 V6	1993-86	NGKBZ7HS-10		CHAQL77JC4 CHAL77JC4		
200 Venom LV6	2003-94	NGKBPZ8HS-10		CHAQL78YC CHAL78YC		
225 V6	1993-86	NGKBZ7HS-10		CHAQL77JC4 CHAL77JC4		
225 Venom LV6	2003-94	NGKBPZ8HS-10		CHAQL78YC CHAL78YC		
235	1985-78	NGKBUHXW-1		CHAQL16V		
250 LV6	2001-99	NGKBUHXW-1		CHAQL16V		
250 V8	1997-85	NGKBPZ8HS-10		CHAQL78YC CHAL78YC		
275	1988-85	NGKBPR7HS		CHAQL78YC CHAL78YC		
300 V8	1997-85	NGKBPZ8HS-10		CHAQL78YC CHAL78YC		

			NGK	CHAMPION	2T STROKES	4T STROKES
65, CV4 65 Jet	1997-92	NGKBR7HS		CHAQL82C CHAL82C		
65 COM, (3 Cyl)	1995-94	NGKBPZ8HS-10		CHAQL78YC CHAL78YC		
65 COM HOLO	1997-88	NGKBUHXW-1		CHAUL77V		
65 COM HOLO	1987-84	NGKBZ7HS-10		CHAQL77JC4 CHAL77JC4		
70 OHC 298cc	2003-98	NGKBPR6ES				✓
70, (3 Cyl) 56 cid	1998-94	NGKBPZ8HS-10		CHAQL78YC CHAL78YC		
70, (3 Cyl) 56 cid	1993-89	NGKBZ7HS-10		CHAQL77JC4 CHAL77JC4		
70, (3 Cyl) 49 cid	1989-75	NGKBZ7HS-10		CHAQL77JC4 CHAL77JC4		
75, (3 Cyl) 49 cid	1989-75	NGKBZ7HS-10		CHAQL77JC4 CHAL77JC4		
75 E-TEC	2005-04	NGKPZFR6H				
80 Jet CV4	1998-79	NGKBR7HS		CHAQL82C CHAL82C		
85, V4 Backtroller	1995-94	NGKBR7HS		CHAQL82C CHAL82C		
85	1993-86	NGKBZ7HS-10		CHAQL77JC4 CHAL77JC4		
85	1980-68	NGKB7HS		CHAUL81C		
88 CV4 SPL	1997-79	NGKBR7HS		CHAQL82C CHAL82C		
90 Tubojet CV4	1997-94	NGKBR7HS		CHAQL82C CHAL82C		
90 LV4 FFI	1998-00	NGKPZFR6H		CHAXC12PEPB		
90 LV4	1998-95	NGKBPZ8HS-10		CHAQL78YC CHAL78YC		
90 CV4	1998-79	NGKBR7HS		CHAQL82C CHAL82C		
90 E-TEC	2005-04	NGKPZFR6H				
100 V4	1980-79	NGKB7HS		CHAUL81C		
100 COM	1998-84	NGKBUHXW-1		CHAUL77V		
105 COM LV4	2003-97	NGKBPZ8HS-10		CHAQL78YC CHAL78YC		
105 LV6 105 Jet	2003-93	NGKBPZ8HS-10		CHAQL78YC CHAL78YC		
110 CV4	1997-79	NGKBR7HS		CHAQL82C CHAL82C		
112 CV4	1997-79	NGKBR7HS		CHAQL82C CHAL82C		
115 Turbojet CV4	1998-94	NGKB7HS		CHAUL81C		
115 LV4 FFI	2003-98	NGKPZFR6H		CHAXC12PEPB		
115 Intruder LV4	1998-95	NGKBPZ8HS-10		CHAQL78YC CHAL78YC		
115 CV4	1998-79	NGKBR7HS		CHAQL82C CHAL82C		
115 COM	1984-75	NGKB7HS		CHAUL81C		
115	1993-86	NGKBZ7HS-10		CHAQL77JC4 CHAL77JC4		

			NGK	CHAMPION	2T STROKES	4T STROKES
115	1979-73	NGKBZ7HS-10		CHAQL77JC4 CHAL77JC4		
115	1985	NGKBUHXW-1		CHAUL77V		
120 LV4	2003-85	NGKBPZ8HS-10		CHAQL78YC CHAL78YC		
125 COM	1972-71	NGKB7HS		CHAUL81C		
130 LV4	2003-85	NGKBPZ8HS-10		CHAQL78YC CHAL78YC		
135	1984-73	NGKBUHXW-1		CHAUL77V		
140 LV4	2003-85	NGKBPZ8HS-10		CHAQL78YC CHAL78YC		
140	1984-73	NGKBUHXW-1		CHAUL77V		
150 LV6 FFI	1998-97	NGKPZFR6H		CHAXC12PEPB		
150 Intruder LV6	1998-91	NGKBPZ8HS-10		CHAQL78YC CHAL78YC		
150 CV6	1991-88	NGKBZ7HS-10		CHAQL77JC4 CHAL77JC4		
150 CV6	1987-78	NGKBUHXW-1		CHAUL77V		
150 COM LV6	1998-93	NGKBPZ8HS-10		CHAQL78YC CHAL78YC		
155 CV6	1987-78	NGKBUHXW-1		CHAUL77V		
155 COM CV6	1992-89	NGKBUHXW-1		CHAUL77V		
175 LV6 FFI	1998	NGKPZFR6H		CHAXC12PEPB		
175 Intruder LV6	1998-91	NGKBPZ8HS-10		CHAQL78YC CHAL78YC		
175 CV6	1991-88	NGKBZ7HS-10		CHAQL77JC4 CHAL77JC4		
175	1987-77	NGKBUHXW-1		CHAUL77V		
185	1987-77	NGKBUZ8H		CHAQL16V		
185 COM	1993-90	NGKBZ7HS-10		CHAQL77JC4 CHAL77JC4		
200 Vindicator L	1998-94	NGKBPZ8HS-10		CHAQL78YC CHAL78YC		
200 V6	1993-86	NGKBZ7HS-10		CHAQL77JC4 CHAL77JC4		
200 LV6 FFI	2004-99	NGKPZFR6H		CHAXC12PEPB		
200 COM	1998-93	NGKBPZ8HS-10		CHAQL78YC CHAL78YC		
200 COM	1992	NGKBUHXW-1		CHAUL77V		
200	1983-76	NGKBUHXW-1		CHAUL77V		
225 Vindicator	1998-94	NGKBPZ8HS-10		CHAQL78YC CHAL78YC		
225LV6 FFI	2004-99	NGKPZFR6H		CHAXC12PEPB		
225	1993-86	NGKBZ7HS-10		CHAQL77JC4 CHAL77JC4		
235	1985-78	NGKBUHXW-1		CHAUL77V		
250 V8	1997-85	NGKBPZ8HS-10		CHAQL78YC CHAL78YC		
275	1988-85	NGKBPZ8HS-10		CHAQL78YC CHAL78YC		
300 V8	1997-85	NGKBPZ8HS-10		CHAQL78YC CHAL78YC		

JUEGOS DE CABLES, ALTO RENDIMIENTO

Núcleo del cable de Kevlar de 8 mm antimagnético. Funda de silicona amarilla. Terminales bujías con muelle de acero inox. Terminal del distribuidor de cobre. Terminales bobina. Silicona resistente a altas temperaturas. Garantía de 5 años.

Capuchón de silicona
Silicone jacket
Rivestimento in silicone
Capuchon en silicone



Rizado especial
Fiberglass braiding
Fibra di vetro
Tresse en fibre de verre

Terminal de acero inox
Stainless Steel terminal
Terminale di acciaio inox
Terminal en acier inox

REF	OEM	
REC15-201		5" = 12,7 cm
REC15-202		7" = 17,78 cm
REC15-203	84-813715A1	9" = 22,86 cm
REC15-204		12" = 30,48 cm

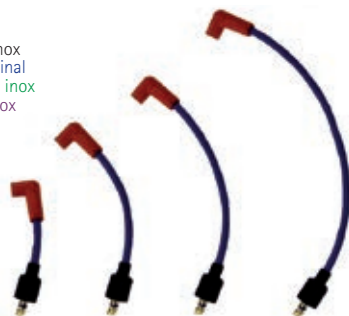

HD SPARK PLUG WIRE SET

Antimagnetic Kevlar core. Yellow silicone boot Et jacket. SS snaplock. Brass distributor terminal. Coil terminals. High resistant silicone. 5 year warranty.

KIT CAVI CANDELE, ALTE PRESTAZIONI

Nucleo del cavo di Kevlar da 8 mm antimagnetico. Copertura di silicone gialla. Terminali candele con molle di acciaio inox. Terminale lato spinterogeno in rame. Terminale Bobine. Silicone resistente alle alte temperature. Garanzia di 5 anni.

KIT FAISCEAU DE BOUGIE

Noyau en Kevlar antimagnétique. Gaine en silicone jaune. Bornes de bougie d'allumage avec ressort en acier inoxydable. Terminal de distribution en laiton. Bornes de bobine. Silicone haute résistance. Garantie 5 ans.

Camisa de silicona de 8 mm
8 mm silicone jacket
Rivestimento in silicone da 8 mm
Gaine silicone de 8mm



Látex resistente altas temperaturas
Heat resistant latex
Látex resistente alle alte temperature
Látex résistant à haute température

Núcleo de Kevlar
Kevlar core
Nucleo de Kevlar
Noyau de Kevlar

Acero inox
Stainless Steel
Acciaio inox
Acier inox

PIPA PARA BUJÍAS

SPARK PLUG PIPE

GOMITO PER CANDELE

CAPUCHON DE BOUGIE

Pipa de silicona para bujía con resistor. Conexión a prueba de agua.

Silicone pipe with resistor. Waterproof connection.

Gomito in silicone per candele. Connessione a prova di acqua.

Capuchon de bougie en silicone avec résistance. Connexion étanche

REF
CHAPROSU



MOTORES DE ARRANQUE STARTERS

MOTORINI AVVIAMENTO DEMARREUR

REF	OEM	⚡	☀️	🔧	2T STROKES	4T STROKES
PH130-0014	386430 586276	12V	10 CCW	8 HP (1996-98) 8 - 15 HP (1974-92)	✓	✓



REF	OEM	⚡	☀️	🔧	2T STROKES	4T STROKES
PH130-0061	5040343	12V	10 CCW	E10 / B10 (2012+)		✓



REF	OEM	⚡	☀️	🔧	2T STROKES	4T STROKES
PH130-0013	584608 586275	12V	10 CCW	L / E / BE 10 E / BE 15 J / BJ 10, 15 (1995-04) 9.9 - 15 HP (305 cc)		✓



REF	OEM	⚡	☀️	🔧	2T STROKES	4T STROKES
PH130-0006	5040786	12V	9 CCW	E15 / B15 (2012+)		✓



REF	OEM	⚡	☀️	🔧	2T STROKES	4T STROKES
PH130-0035	586768 587045	12V	9	E15 / 25 / 30 / 40 / 50 / 55 / 60 / 65 / 75 / 90 (2001+) E-TEC	✓	



REF	OEM	⚡	☀️	🔧	2T STROKES	4T STROKES
PH130-0038	386591 392133 585061 586278 277432 278232 378674 379091 379818 380139 380238 381864 385401 386597	12V	11	E20, 25, 28, E30, E35 HE25 BE20, BE25 BJ25, BJ30 J25, 30, 28, 35 TJ25 SJ25, 30 TE25 VE25 VJ25, VJ28 (1976-05)	✓	



REF	OEM	⚡	☀️	🔧	2T STROKES	4T STROKES
PH130-0077	5036972	12V	9 CCW	J25 / BJ25 (2006-11)		✓



REF	OEM	⚡	☀️	🔧	2T STROKES	4T STROKES
PH130-0017	5583473 585059 778991	12V	9	VE25 / 28 / 30 TE25 / TE30 J20 / 25 / 30 / 35 TJ25 VJ25 / 28 / 30 / 35 (1988-93)		✓



REF	OEM	⚡	☀️	🔧	2T STROKES	4T STROKES
PH130-0026	586277 584818 778996	12V	10	BJ25, 35 HE35 HJ35 E25 / 35 J25 / 35 (1996+)		✓



REF	OEM	⚡	☀️	🔧	2T STROKES	4T STROKES
PH130-0016	583482 585056 586279	12V	9	E40 / 48 / 50, TE40 / 50 VE40 / 48 / 50, J40 / 48 / 50 TJ40 / 50, VJ40 / 48 / 50 E40 / 48 / 50, BE40 / 50 HE40, SE50 HJ40 BJ40 / 50 RJ50 X50 (1989-05)		✓



REF	OEM	⚡	☀️	🔧	2T STROKES	4T STROKES
PH130-0045	384163 387684 389275 585063 586280 778993	12V	9	40 - 60 HP (2cyl) (1971-99)		✓







REF	OEM	⚡	☀️	🔧	2T STROKES	4T STROKES
PH130-0043	383691 384777 386657 391735 585058 585197 586281	12V	9	55 - 75 HP (3 cyl) E70 / 75 BE50 / 60 / 70 J70 / 75 / 65 / 60 TJ60 / 70 VJ60 / 70 E 60 / 65 / 70 BJ 60 / 70 (1971-04)		✓







REF	OEM	⚡	☀️	🔧	2T STROKES	4T STROKES
PH130-0079	5030780	12V	8	E70 / B70 (1998-00)		✓







REF	OEM				2T STROKES	4T STROKES
PH130-0032	438878 586257	12V	8	75 - 175 HP (1991+) V4 & V6 Ficht	✓	







REF	OEM				2T STROKES	4T STROKES
PH130-0044	385529 389954 585057 585196 586282 586283 386465 389380 391554 585051	12V	10	80 - 140 HP (1973-98) V4 CROSS	✓	







REF	OEM				2T STROKES	4T STROKES
PH130-0071	5033799	12V	9	J90 / BJ90 J115 / BJ115 J140 / BJ140 (2003-06)		✓







REF	OEM				2T STROKES	4T STROKES
PH130-0027	584980 586284	12V	8	100 Comercial 1997, 80 Jet 1998 E90 / J90 / BJ90 / BE90 E115 BE115 HE115 L115 J115 BJ115 SJ115 (1995-06) V4	✓	







REF	OEM				2T STROKES	4T STROKES
PH130-0012	393570 585060 586285 778994	12V	10	120 - 140 HP (1985+)	✓	



REF	OEM				2T STROKES	4T STROKES
PH130-0018	432925 586286 586287	12V	10 CCW	150 - 175 HP V6 Eagle (1991+)	✓	



REF	OEM				2T STROKES	4T STROKES
PH130-0039	387094 395207 585062 586288 778992 777693	12V	8	150 - 235 HP V6 Cross	✓	



REF	OEM				2T STROKES	4T STROKES
PH130-0078	5035078	12V	9	J200, BJ200 J225, BJ225 (2004-06)		✓



REF	OEM				2T STROKES	4T STROKES
PH130-0008	391511 397023 396235 584799 586890 384799 586289 586411 586731 586897 586957	12V	10 CCW	V6 - V8 (115 - 300 HP) (1985+) Looper		✓



MUELLES ARRANQUE

REWIND SPRING

MOLLE AVVIAMENTO

RESSORT DE DÉMARRAGE

REF	OEM
REC93-08668	395460
REC0326877	326877
REC93-06511	312932
REC93-06522	323653 338534



**MUELLES ARRANQUE
GUIA**

**REWIND SPRING
GUIDE**

**MOLLE AVVIAMENTO
GUIDA**

**GUIDE RESSORT DE
DÉMARRAGE**

	REF
2	1969-80 REC93-06511
3	1954-68 REC93-08668
4	1969-92 REC93-06511
4	1969-80 REC93-06511
4	1981-92 REC0326877

	REF
4.5	1980-90 REC93-06511
5.5	1954-68 REC93-08668
7.5	1954-68 REC93-08668
9.9	1980-92 REC93-06522
10	1980-92 REC93-06522

	REF
10	1950-63 REC93-08668
12	1980-92 REC93-06522
12	1956-68 REC93-08668
15	1979-92 REC93-06522
15	1956-68 REC93-08668

	REF
18	1956-68 REC93-08668
20	1956-92 REC93-08668
28	1969-92 REC93-08668
25/30	1969-92 REC93-08668
35	1969-92 REC93-08668

**MUELLE SEGURO
ARRANQUE**

STARTER PAWL SPRING

**MOLLE DI SICUREZZA
AVVIAMENTO**

**RESSORT DE SÉCURITÉ
DÉMARRAGE**

REF	OEM	
REC93-08663	203697	20, 25, 30, 35 HP (1968-84)



REF	OEM	
REC93-08664	203725	25, 30, 35 HP (1968-84)



REF	OEM	
REC93-08665	330527	20, 25 HP (1985-97)



REF	OEM	
REC93-08667	335905	5, 6, 8, 10, 15, 25, 35 HP (1993-97)



REF	OEM	
REC93-08666	331970	3, 4, 5, 6, 8, 10, 15, 25, 35 HP (1993-97)



UÑAS ARRANQUE MANUAL

STARTER PAWL

PIASTRA AVVIAMENTO MANUALE

CLIQUET D'ARRET DU LANCEUR MANUEL

REF	OEM	
	2	1971-88
	JR / COLT	1990
	3	1957-67
	4	1978-90
	5.5	1957-64
	7.5	1957-76
	10	1957-62
	18	1957-73
REC300-01744	203698	25
		25
		35
		45
		50
		60
		75
		80



REF	OEM	
		20
		25
REC300-01633	330525	25C
		30
		30
		35



LLAVES DE ARRANQUE

IGNITION STARTER SWITCH

CHIAVI DI ACCENSIONE

CONTACTEUR A CLÉ

REF	OEM		POSICIONES POSITIONS POSIZIONE POSITIONS
GS11153	386545	6	3 OFF - RUN - START
MP39760	393301 508180		



MP39760



GS11153

REF	OEM		2T STROKES	4T STROKES
REC5005801	5005801 0175974	10 - 200 HP (1996+)	✓	✓





SOLENOIDE RELÉ



SOLENOID RELAY

SOLENOIDE RELE



SOLENOIDE RELAIS

REF	OEM			
PH375-0029	985063 892187 98410 778025 584128	(1987+)	12 V	3



REF	OEM			
REC584580	584580	9.9 / 15 HP (4 T/ Stroke) (1995-01) 8 HP (1996-98) 9.9 / 15 HP (1993+)	12 V	4



REF	OEM			
REC89-825096T01	5030783	9.9 - 70 HP (1998+)	12 V	4



REF	OEM		2T STROKES	4T STROKES
REC38860-76F01	5033264	10 - 225 HP		✓



new

REF	OEM			
PH375-0033	172869 581528 777699	9.9 - 235 HP (1975-92)	12 V	4



REF	OEM			
REC586774	586774 5009214	25 - 300 HP (2004+) E-Tec	12 V	4



REF	OEM			
PH375-0030	979774 778021	(1972-77)	12 V	3



REF	OEM			
REC3857533	584416 581295 582472 582473 586147 586224 777702	40 - 300 HP (1991+)	12 V	4



REF	OEM			
REC378444	378444 777700	18 - 80 HP (1966-85)	12 V	4



REF	OEM			
PH375-0027	586730 586842 778209 980801 981703 982189 985064 385389	75 - 250 HP (1997+)	12 V	4



REF	OEM			
PH375-0012	582708 395419 380095 383622 389398 389493 586180	20 - 300 HP (1992+)	12 V	4



TRIM

REF	OEM			
REC581528	581528 172869 777699	9.9 - 235 HP (1977-92)	12 V	4



REF	OEM		2T STROKES	4T STROKES
REC0586767	0586767 586767	15-300 HP (E-TEC)		✓

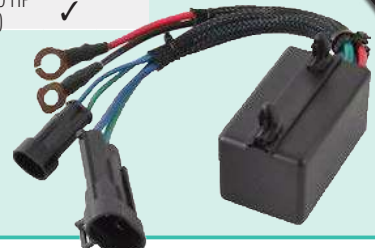

new

REF	OEM			
PH375-0047	5031483 5032195	25 - 115 HP (1999+)	12 V	3



REF	OEM			
PH375-0048	5032197	E25 / E30 (2000+)	12 V	3



REGULADORES Y RECTIFICADORES

REGULATOR AND RECTIFIERS

REGOLATORI E RADDRIZZATORI



REGULATEURS ET RECTIFIEURS

REF	OEM		
PH350-0002	581778	4-5 A	9.9, 15
			20 (D)
			25
			28
			30 (D)
			35
			40
			45
			45SS
			48
			55(A)





REF	OEM
PH350-0003	509219





REF	OEM		
PH350-0001	583408 582399	6-10 A	50
			55
			60
			60
			60(F)
			SST60
			65
			65
			70(B)
			75
			85
			88
			90
			100(C)
			115
			125
			135(G)
			140
			150
			155
			175
			185
			200
235			



REF	OEM		2T STROKES	4T STROKES
REC32800-94620	5034255	4, 5, 6 HP		✓



REF	OEM		2T STROKES	4T STROKES
REC32800-95D01	5030356	5 - 15 HP (1998+)	✓	✓



REF	OEM		2T STROKES	4T STROKES
REC32800-94J11	5036261	10,15 HP	✓	





REF	OEM		2T STROKES	4T STROKES
REC0585081	0585081		10, 15 HP	✓



REF	OEM		2T STROKES	4T STROKES
REC32800-38F10	5036107		40, 50 HP	✓





REF	OEM		2T STROKES	4T STROKES
REC32800-89J11	5034680		J25, J30	✓





REF	OEM		2T STROKES	4T STROKES
REC32800-87J10	5032615		BJ40, BJ50, J40, J50	✓





REF	OEM		2T STROKES	4T STROKES
REC32800-89J00	5032030		E25, E30 (2000-01)	✓



REF	OEM		2T STROKES	4T STROKES
REC32800-92E20	5030795		J60, BJ60, J70, BJ70	✓





REF	OEM		2T STROKES	4T STROKES
REC300-03587	585001		25 - 70 HP (1992+)	✓

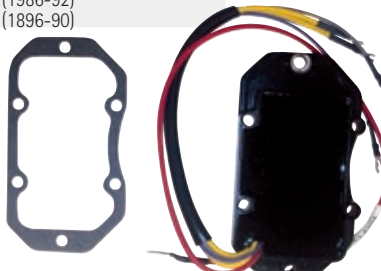

REF	OEM		2T STROKES	4T STROKES
REC0395204	395204		E85 (1992-95)	✓
	395391		E115 (1992-95)	
	395391		E150 (1986-91)	
	582904		E155 (1986-92)	
			E175 (1896-90)	



REF	OEM		2T STROKES	4T STROKES
REC300-03588	584890		25 - 35 HP (1995+)	✓



REF	OEM		2T STROKES	4T STROKES
REC32800-90J00	5033820 5036618		90-115 HP	✓



Cuerpo reciclado Recycled housing Corpo rigenerato Corps recyclé

REF	OEM		2T STROKES	4T STROKES
REC0585195	583529 584204 585195	90, 100, 115, 150, 175 HP (1989-98)	✓	



REF	OEM		2T STROKES	4T STROKES
REC300-03585	586075	V6 60°, 90-115 HP (1996+)	✓	





Cuerpo reciclado Recycled housing Corpo rigenerato Corps recyclé

REF	OEM		2T STROKES	4T STROKES
REC0763791	583512 584205 585192	120, 125, 130, 135, 140 HP (1991-98)	✓	



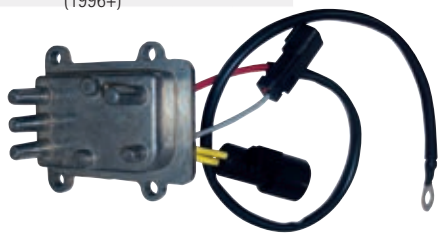

REF	OEM		2T STROKES	4T STROKES
REC300-03586	586048	V6 60°, 150-175 HP (1996+)	✓	



REF	OEM		2T STROKES	4T STROKES
REC0586271	586271 584641 585995	200, 225, 250 HP (1993-99)	✓	



REF	OEM		2T STROKES	4T STROKES
REC300-08010	439561	V6 60°, 150-175 HP (1991-95)	✓	



REF	OEM		2T STROKES	4T STROKES
REC0583689	583266 583689 586000 5844241	275, 300 HP (1986-90)	✓	

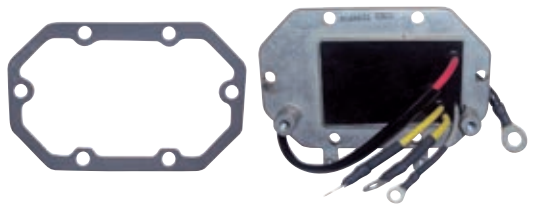

new

REF	OEM		2T STROKES	4T STROKES
REC32800-93J03	5036637	BJ200, BJ225	✓	





GUÍA REGULADORES

REGULATORS GUIDE

GUIDA REGOLATORI

GUIDE REGULATEUR

		REF
25 / 40 / 50TL J Elec TR	1992	REC300-03587
25SIK / SIL / SIT	1994-1995	REC300-03587
25 / 35 3 Cyl	1995	REC300-03588
35JET / TL / J Elec.	1992-1993	REC300-03587
35JET / M-TE / TTL	1993-1995	REC300-03587
35JET / EL / TL / TTL	1996	REC300-03587
35JET Elec.	1997	REC300-03587
40 / 50TE / EL / TL / TTL	1993-1996	REC300-03587
40 / 50 Elec. 2T	1993-03	REC300-03587
60	1992-01	REC300-03587
65 Elec.	1992	REC300-03587
70	1974-91	REC300-03587
80 Jet	1992-94 & 1996	REC0585195
85	1992-95	REC0585195
88	1992-96	REC0585195
90-115 60° V4	1996	REC300-03585
90	1989-95	REC0585195
100 Comercial	1988-97	REC0585195
100	1991-94	REC0585195
110	1989	REC0585195
112	1994-96	REC0585195
115	1990-98	REC0585195
120	1988-90, 1992-94	REC0763791
125	1991-95	REC0763791
130	1994-2000	REC0763791
140	1988-1994	REC0763791
150 / 175 60° V6	1991-95	REC300-08010

		REF
150 / 175 60° V6	1996 Et up	REC300-03586
155 Comercial	1989-90	REC0585195
185 / 200 / 225	1993-94	REC0586271
185 / 200 / 225 / 200COM	1990-92	REC0583689
200 / 225	1986-1989	REC0583689
200 / 225 / 200COM	1994-97	REC0586271
250 / 300	1991-95	REC0586271
250	1997	REC0586271
275	1985-1986	REC0583689
275 / 300 (3.6L)	1987	REC0583689
275 / 300	1988	REC0583689
300 (3.6L)	1985-1986	REC0583689
300	1989-90	REC0583689
1.8 / 2.0L V4	1987-1990	REC0583689
2.7L V6	1986-87	REC0583689
3.0L V6	1988-90	REC0583689
3.0L V6	1993-98	REC0583689
3.6L V8	1987	REC0583689
4.0L V8	1989-1990	REC0583689
V4 Et V6 Crossflow	Todos / All / tutti	REC0395204

CDI Y CAJAS NEGRAS

CDI & POWER PACK

CDI E CENTRALINA

CDI ET BOITIER ELECTRONIQUE

REF	OEM
REC0584035	583471 584034 584035



REF	OEM
REC0584041	583489 584040 584041



REF	OEM
REC0586661	584636 584637 585114 586212 586661

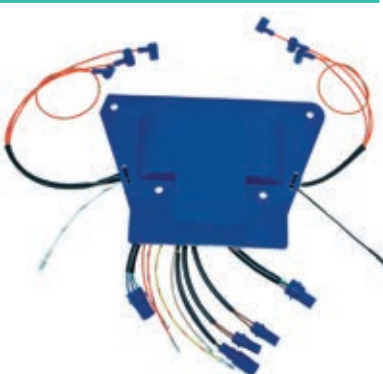

REF	OEM
REC0586667	583476 584036 584037 586217 586667

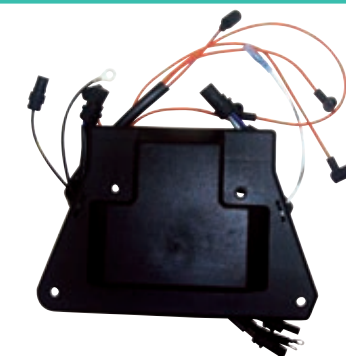

REF	OEM
REC0765386	586015 586098 586292

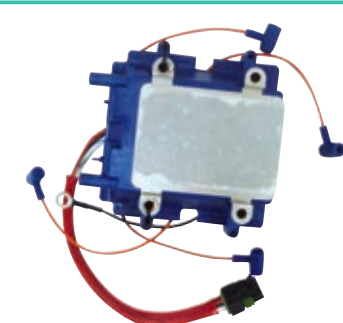

REF	OEM
REC0763803	584642



REF	OEM
REC0583865	583865



REF	OEM
REC584030	583777 584029 584030

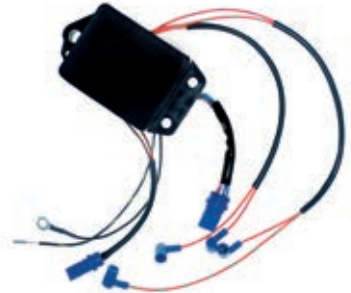

REF	OEM
REC0584986	584986 584988 584912 584989 584991



REF	OEM
REC0763793	582705



REF	OEM
REC0584985	584910 584985 584990

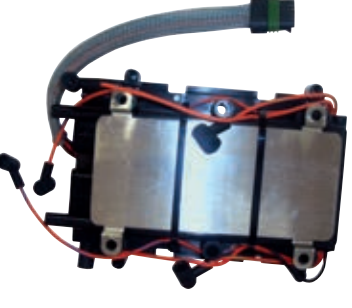

REF	OEM
REC0585274	585274



REF	OEM
REC0436367	436367 584122



REF	OEM
REC0586798	584783



REF	OEM
REC5004532	584808 585145 585189 5004533



REF	OEM
REC0582262	5814014 582262 583041 583103 583336



REF	OEM
REC0584028	583773 584027 584028



REF	OEM
REC0175316	175316 585261 585262



REF	OEM
REC0586697	396141
	582281
	582285
	582502
	582757
	582880
	583167
	583168
	583169
	583170
	583175
583604	



REF	OEM	✂
REC0582642	582138	4
	582400	
	582642	
	582556	



REF	OEM
REC0582901	582474
	582864
	582901



REF	OEM	✂
REC0582125	582684	4
	582125	
	582454	
	581805	



REF	OEM
REC0586695	396077
	582261
	582504
	582714
	582800
	582889
	583172
	583174
	583241
	584508
	584528
584746	



REF	OEM	✂
REC0582452	582453	3
	583380	



REF	OEM
REC5001344	584767
	584768
	584908
	585074



REF	OEM
REC0583320	583122
	583320



REF	OEM
REC0582115	582115
	583125
	583143



REF	OEM
REC0583114	583114



REF	OEM	🔧
REC115742	115742	3.3 HP (1995+)

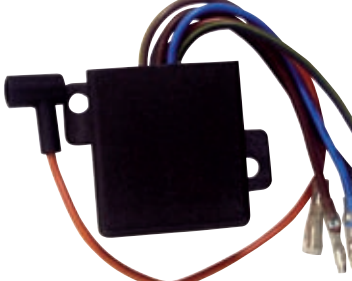

REF	OEM
REC0583748	583748



REF	OEM
REC300-26084	583663 583667 584488



REF	OEM	Icon
REC0582057	582057	2 Cyl



REF	OEM	Icon
REC0764708	581397	2 Cyl

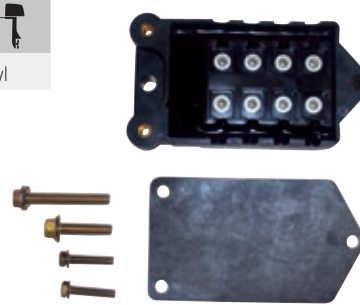

REF	OEM
REC581726	581726

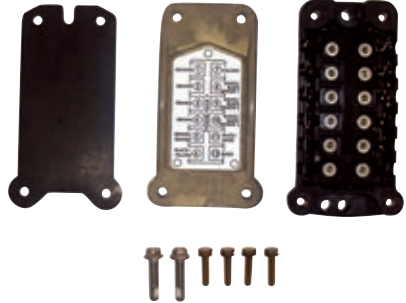

REF	OEM
REC0582056	581731 582056



REF	OEM
REC300-26085	583896 584329 584331 584489



TRIGGERS

REF	OEM
REC0583387	583387



REF	OEM
REC0385008	384461 385008



REF	OEM
REC0586343	584265 584914 586343



REF	OEM
REC0763808	175386



REF	OEM
REC0763773	584804 763773



REF	OEM
REC0763776	583289 583379 582514 583045 763776



REF	OEM
REC763775	583533 584586 763775



REF	OEM
REC0763782	583508 763773

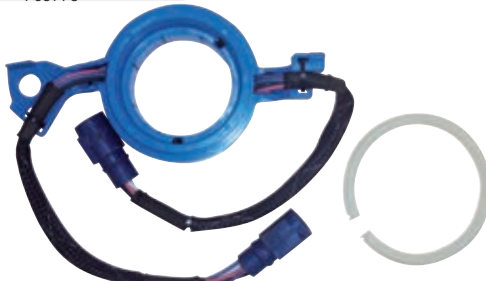

STARTOR

REF	OEM
REC5000611	581670 584504 584840 585073



REF	OEM	
REC0583724	581957 582506 582730 583119 583644 583724	9 A



REF	OEM
REC0584333	583485 584333



REF	OEM	
REC0763760	584849 763760	20 A

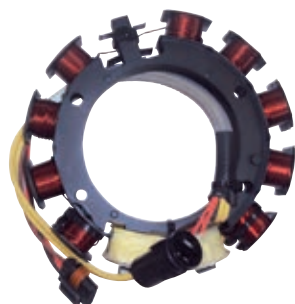

REF	OEM	
REC0584954	584954	6 A



REF	OEM	
REC0583670	582847 583117 583670	35 A

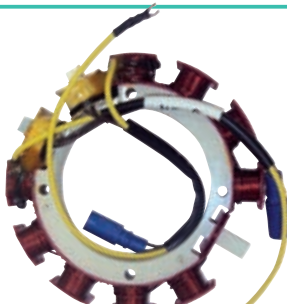

Remanufacturado Rebuilt Rigenerato Reconditioné

REF	OEM	⚡
REC0583672	582016	9 A
	582497	
	582867	
	583023	
	583104	
	583671	
	583672	
	581030	
	581987	



REF	OEM	⚡
REC0583668	582574	35 A
	583050	
	583274	
	583668	
	763785	

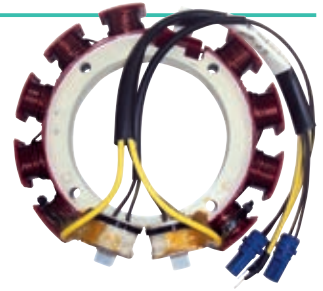

REF	OEM	⚡
REC0763769	583410 763769	9 A

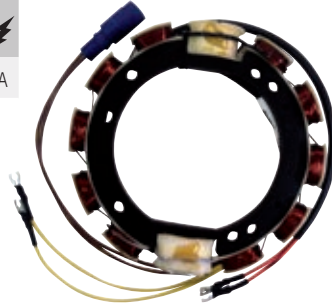

REF	OEM	⚡	🔧
REC0763759	584109 584981	35 A 6 cyl	

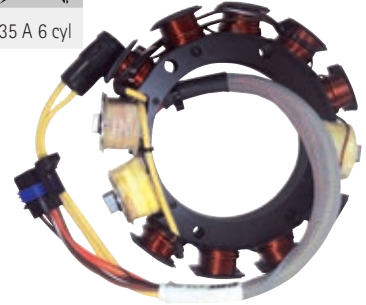

REF	OEM	⚡
REC0763770	581651 584755 585087 763770	5 A

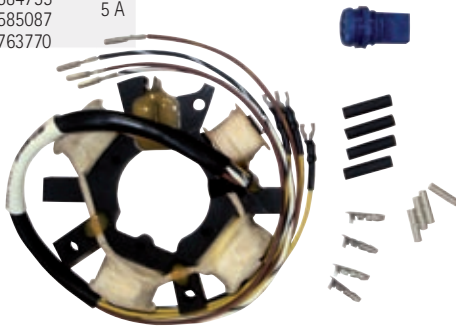

REF	OEM	⚡
REC0763767	583340 583536 763767	9 A



REF	OEM	⚡
REC0763763	584560 763763	6 A
REC0763779	584643 763779	35 A



REF	OEM	⚡
REC0763765	583415 584287 763765	35 A

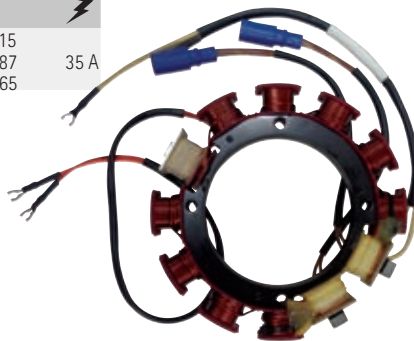

REF	OEM	⚡
REC0584288	583561 584288	35 A

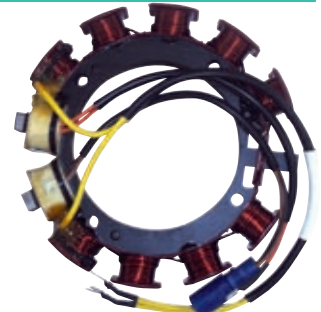

REF	OEM	⚡
REC0583415	584287 763765	35 A



REF	OEM	⚡
REC0763764	583710 584292 763764	35 A

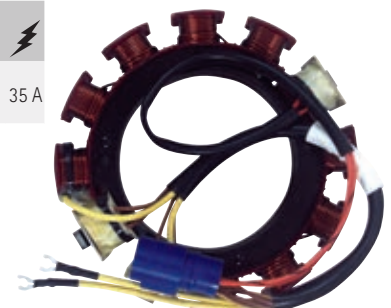

GUÍA	APPLICATION	GUIDA	GUIDE		
	CYL	CAJA NEGRA POWER PACK CENTRALINA BOITIER ELECTRONIQUE		STARTOR	TRIGGER
		2T STROKES	4T STROKES		
3.3	2 1995		REC115742		
4	2 77-84		REC0582452	REC5000611	REC0583387
4, 4.5, 5	2 1985		REC0586697	REC5000611	REC0583387
4	2 1994-96		REC0586697	REC5000611	REC0583387
5	2 1989-92		REC300-26084	REC5000611	REC0583387
5	2 1993-98		REC0586697	REC5000611	REC0583387
6	2 1977-84		REC0582452	REC5000611	REC0583387
6, 8	2 1985		REC0586697	REC5000611	REC0583387
6	2 1989-92		REC300-26084	REC5000611	REC0583387
6	2 1994-2000		REC0586697	REC5000611	REC0583387
8	2 1989-92		REC300-26084	REC5000611	REC0583387
8	2 1994-2003		REC0586697	REC5000611	REC0583387
9.9	2 1985-88		REC0586697	REC5000611	REC0583387
9.9	2 1989-92		REC300-26084	REC5000611	REC0583387
9.9	2 1993		REC0586798	REC0763770	REC0583387
9.9	2 1994-95		REC0586798	REC0763770	
9.9 MAN.	2 1996-2005		REC0586798	REC5000611	
9.9 ELEC.	2 1995-2003		REC0586798	REC0763770	REC0583387
10	2 1994		REC0586798	REC5000611	REC0583387
10	2 1996-98	✓		REC0584954	
14	2 1988		REC0586697	REC5000611	REC0583387
14	2 1989-90		REC300-26084	REC5000611	REC0583387
15	2 1983-84		REC0582452	REC5000611	
15	2 1988		REC0586697	REC5000611	REC0583387
15	2 1989-91		REC300-26084	REC5000611	REC0583387
15	2 1992		REC300-26085	REC5000611	REC0583387
15	2 1993			REC0763770	
15	2 1994		REC0586798	REC5000611	
15	2 1995-2000		REC0586798	REC5000611	REC0583387
15 ELEC.	2 1996-97		REC0586798	REC0763770	
15	2 1996-2000	✓		REC0584954	REC32800-95D01
20	2 1982-84		REC0582452	REC5000611	REC0583387
20	2 1985-88		REC0586697	REC5000611	REC0583387
20	2 1989-92		REC300-26085	REC5000611	REC0583387
20	2 1993-2000		REC5001344	REC5000611	REC0583387
25	2 1982-84		REC0582452	REC5000611	REC0583387
25	2 1985-88		REC0586697	REC5000611	REC0583387
25	2 1989-92		REC300-26085	REC5000611	REC0583387
25	2 1993-2005		REC5001344	REC5000611	REC0583387
25	3 1994-95		REC5004532	REC0763763	
28	2 1985-88		REC0586697	REC5000611	REC0583387
28	2 1989-92		REC300-26085	REC5000611	REC0583387
28	2 1993-98		REC5001344	REC5000611	REC0583387
30	2 1984		REC0582452	REC5000611	REC0583387
30	2 1985-88		REC0586697	REC5000611	REC0583387
30	2 1989-92		REC300-26085	REC5000611	REC0583387
30	2 1993-2005		REC5001344	REC5000611	REC0583387
35	2 1982-84		REC0582452	REC5000611	REC0583387
35	2 1985-88		REC0586697	REC5000611	REC0583387
35	2 1989-92		REC300-26085	REC5000611	REC0583387
35	2 1992-93		REC0175316	REC0763763	REC0763808
35	2 1993-97		REC5001344	REC5000611	REC0583387
35	2 1993-95		REC0175316	REC0763763	REC0763808
35	2 1996-97		REC0175316	REC0763763	REC0763808
40	2 1985-88		REC0586697	REC5000611	REC0583387
40	2 1989-92		REC300-26085	REC5000611	REC0583387
40	2 1992		REC0175316	REC0763763	REC0763808
40	2 1993		REC5001344	REC5000611	REC0583387
40	2 1993-95		REC0175316	REC0763763	REC0763808
40	2 1996-97		REC5001344	REC5000611	REC0583387
40	2 1996-97		REC0175316	REC0763763	REC0763808
40 MAN.	2 1985		REC0586695	REC5000611	REC0583387
40 COM	2 1993-97		REC0586695	REC5000611	REC0583387
40 MAN.	2 2000-05		REC5001344	REC5000611	REC0583387
40 ELEC.	2 2000-05		REC0175316	REC0763763	REC0763808
45 COM	2 1985		REC0586695	REC5000611	REC0583387
45	2 1986-90		REC0586697	REC5000611	REC0583387
45 COM	2 1989-91		REC300-26085	REC5000611	REC0583387
45 COM	2 1992-2000		REC0586695	REC5000611	REC0583387
48	2 1987-88		REC0586697	REC5000611	REC0583387
48	2 1989-93		REC300-26085	REC5000611	REC0583387
48	2 1994-96		REC5001344	REC5000611	REC0583387
50	2 1971-75		REC0764708		
50 ELEC.	2 1979-83		REC0582452		
50	2 1979-83		REC0582452	REC5000611	REC0583387
50	2 1985-88		REC0586697	REC5000611	REC0583387
50	2 1989-92		REC300-26085	REC5000611	REC0583387
50 TE-S	2 1992		REC0175316	REC0763763	REC0763808
50	2 1993-95		REC0175316	REC0763763	
50 MAN.	2 1993-95		REC5001344	REC5000611	REC0583387
50	3 1996-98		REC5004532	REC0763763	REC0763773

	CYL	CAJA NEGRA POWER PACK CENTRALINA BOTIER ELECTRONIQUE		STARTOR	TRIGGER
		2T STROKES	4T STROKES		
50 MAN.	2	1997-99	REC5001344	REC5000611	REC0583387
50 ELEC ST	2	1997-99	REC0175316	REC0763763	REC0763808
50 MAN.	2	1998-99	REC5001344	REC5000611	REC0583387
55	2	1979-82	REC0582452		
55	2	1988	REC0586697	REC5000611	REC0583387
55 COM	2	1983-84	REC0582901	REC5000611	REC0583387
55 COM	2	1985	REC0586695	REC5000611	REC0583387
55 COM	2	1986-87	REC0586697	REC5000611	REC0583387
55	2	1989-91	REC300-26085	REC5000611	REC0583387
55	2	1992-2000	REC0586695	REC5000611	REC0583387
60	2	1985	REC0586697	REC5000611	REC0583387
60	3	1986-89	REC0582115	REC0583724	
60	3	1989-91	REC0583748		
60	3	1992	REC0583748	REC0763763	
60	3	1993-2001	REC5004532	REC0763763	REC0763773
65 COM	3	1986-88	REC0583320	REC0583724	
65 COM	3	1989-95	REC0583748		
65 COM ELEC	3	1993-94	REC5004532	REC0763763	REC0763773
65 COM VRO	3	1995	REC0583748		
65 COM	3	1996-2000	REC0585274	REC0763763	
70	3	1986-88	REC0582115	REC0583724	
70	3	1989-91	REC0583748		
70	3	1992	REC0583748	REC0763763	
70	3	1993-2001	REC5004532	REC0763763	REC0763773
75	3	1986-88	REC0582115	REC0583724	
85	4	1973-77	REC0582056		
85	4	1978-83	REC0582125	REC0583672	
85 TJL	4	1991-95	REC0584028	REC0763767	REC0763776
85 TTL/TRIM	4	1994	REC584030	REC0763767	REC0763776
85 TTL	4	1995	REC0584028	REC0763767	REC0763776
88	4	1988	REC0582262	REC0763767	
88	4	1989-93	REC0584028	REC0763767	REC0763776
88	4	1994	REC584030	REC0763767	REC0763776
88	4	1994-96	REC0584028	REC0763767	REC0763776
90, 6, 10 Amp.	4	1984	REC0582125	REC0583672	
90	4	1989-93	REC0584028	REC0763767	REC0763776
90	4	1994-95	REC584030	REC0763767	REC0763776
90 20 / 25IN	4	1996-97	REC0584028	REC0763767	REC0763776
90 60° Deg.	4	1996-2006	REC0765386	REC0763760	REC0586343
100	4	1990-93	REC0584028	REC0763767	REC0763776
100	4	1994	REC584030	REC0763767	REC0763776
100 COM	4	1989-97	REC584030	REC0763767	REC0763776
100	4	1989	REC0584028	REC0763767	REC0763776
100 COM, 105	4	2000-06	REC0765386	REC0763760	REC0586343
112 20, 25 IN	4	1994-96	REC0584028	REC0763767	REC0763776
115 6, 10 Amp.	4	1978-84	REC0582125	REC0583672	
115 No Not Trim	4	1985		REC0583672	
115	4	1990-93	REC0584028	REC0763767	REC0763776
115	4	1994	REC584030	REC0763767	REC0763776
115	4	1995-96	REC0584028	REC0763767	REC0763776
115 60° Deg.	4	1995-2006	REC0765386	REC0763760	REC0586343
115 20,25 IN	4	1997	REC0584028	REC0763767	REC0763776
120 35 Amp.	4	1984-87	REC0582125		
120	4	1986-87	REC0582262		REC0763776
120 Looper	4	1988-90	REC0584041	REC0763769	REC0763782
120 35 Amp.	4	1988-95	REC0584041	REC0584288	REC0763782
120 10 Amp.	4	1992-94	REC0584041	REC0763769	REC0763782
125	4	1991-94	REC0584041	REC0763769	REC0763782
125 COM ELEC.	4	1989-95	REC0584041	REC0763769	REC0763782
130 35 Amp.	4	1988-2000	REC0584041	REC0584288	REC0763782
130	4	1995-2000	REC0584041	REC0763769	REC0763782
135	4	1973-77	REC0582056		
135	4	2001	REC0584041	REC0763769	REC0763782
140	4	1977	REC0582056		
140	4	1978-84	REC0582125	REC0583672	
140 10 Amp.	4	1984	REC0582125	REC0583672	
140 Looper	4	1988-95	REC0584041	REC0763769	REC0763782
150	6	19978	REC0582057		
150	6	1979-84	REC0582642	REC0583672	
150 35 Amp.	6	1984	REC0582642	REC0583668	
150	6	1985		REC0583672	
150 35 Amp.	6	1985		REC0583668	
150 TL/TX	6	1986-87	REC0583114	REC0583672	
150 ST	6	1986-88	REC0583114		
150 SL/ST	6	1989-90	REC0583865	REC0763764	
150 ST	6	1990	REC0583865	REC0763764	
150 60°	6	1991	REC0584985	REC0583415	REC0586343
150 SL/ST	6	1991	REC0583865	REC0763764	REC0586343
150	6	1992-2006	REC0584985	REC0763759	REC0586343
155 COM 35 Amp.	6	1984	REC0582642	REC0583668	
155 COM	6	1984		REC0583668	
155 COM	6	1986-88		REC0583668	
155 COM	6	1989-92	REC0583865	REC0763764	
175	6	1977-78	REC0582057		
175	6	1979-83	REC0582642	REC0583672	

🔧	CYL		2T	4T	CAJA NEGRA POWER PACK CENTRALINA BOITIER ELECTRONIQUE	STARTOR	TRIGGER
			STROKES	STROKES			
175	6	1985-88				REC0583668	
175	6	1989-90			REC0583865	REC0763764	
175GL/EK/EL/NX	6	1991-2006			REC0584985	REC0763759	REC0586343
175	6	1992-98			REC0584985	REC0763759	REC0586343
185	6	1979-84			REC0582642	REC0583672	
185	6	1985				REC0583668	
185	6	1990-92			REC0586667	REC0763765	REC763775
200	6	1976-78			REC0582057		
200	6	1979-83			REC0582642	REC0583672	
200	6	1986-87				REC0583670	
200	6	1988-92			REC0586667	REC0763765	REC763775
200	6	1993-2000			REC0586661		REC763775
225	6	1988-1992			REC0586667	REC0763765	REC763775
225	6	1993-2000			REC0586661	REC0763779	REC763775
235	6	1978			REC0582057		
235	6	1979-84			REC0582642	REC0583672	
235 35 Amp.	6	1984			REC0582642	REC0583668	
235 10 Amp.	6	1985				REC0583672	
235 35 Amp.	6	1985				REC0583668	
275 3.6L	8	1986-87			REC0582262	REC0583670	
250	8	1993-95			REC0763803	REC0763779	
250	8	1997			REC0763803	REC0763779	
300 3.6L	8	1986-87			REC0582262	REC0583670	
300	8	1993-95			REC0763803	REC0763765	
2.5L, 2.6L	6	1982			REC0582642	REC0583672	
1.6L	8	1983			REC0582125	REC0583672	
2.6L 35 Amp.	6	1983			REC0582642	REC0583668	
1.6L S V4	8	1984			REC0582125	REC0583672	
2.5L, 2.6L	6	1984				REC0583668	
1.6L	4	1985				REC0583672	
2.5L, 2.6L	6	1985				REC0583668	
2.6L 35 Amp.	6	1986			REC0583114	REC0583668	
1.8L	4	1987			REC0582262		
2.7L	6	1987				REC0583668	
3.6L	8	1987			REC0582262	REC0583670	
1.6L	4	1988-90			REC0582262	REC0763767	REC0763776
2.0L	4	1988-90			REC0584041	REC0584288	REC0763782
3.0L	6	1988-90			REC0586667	REC0763765	REC763775
4.0L	8	1989-90			REC0584035	REC0763765	

DESCONECTORES DE SEGURIDAD

CUT OFF SWITCHES

CHIAVETTA DI SICUREZZA

COUPE CIRCUIT DE SECURITE

REF	OEM
MP28870	585134



REF	OEM
REC37830-89E03	5030225 5032047



REF	OEM
REC37820-92E03	5031481



KITS Interruptor de encendido para todo tipo de motores fueraborda o intraborda **KITS** Emergency and stop switch for inboard or outboards. **KIT** Interruttore di accensione per tutti i tipi di motori fuoribordo o entro bordo. **KITS** Coupe circuit de sécurité pour moteur inboard ou hors-bord

REF KIT	CUERDA WIRE CORDA CORDON	
REC40970	REC40990	1

RECmar

REF KIT	CUERDA WIRE CORDA CORDON	
GS11290	GS11291	1

GOLDENSHIP

REF KIT	
GS11292	1

GOLDENSHIP

REF	
GS11294	1

J/E, OMC, Mercury, Yamaha, Honda, Suzuki, Tohatsu.

GOLDENSHIP

TRIM, TILT & POWER TRIM

INSTALACIÓN ELÉCTRICA **WIRING HARNESS** **INSTALLAZIONE ELETTRICA** **INSTALLATION ELECTRIQUE**

KIT CONVERSIÓN Sustituye de 2 a 3 cables. **CONVERSION KIT** Converts 3-wire Tilt and Trim motors to 2-Wire design **KIT CONVERSIONE** Sostituisce da 2 a 3 cavi. **KIT DE CONVERSION DE 3 A 2 FILS**

REF	OEM
PH200-WH01	84-819514T26 84-826075A2 84-826802A4



MOTOR TRIM COMPLETO **COMPLETE TRIM ASSEMBLY** **MOTORINO TRIM COMPLETO** **MOTEUR DE TRIM COMPLET**

REF	OEM				2T STROKES	4T STROKES
PH200-T020	387277 582048 582155 584107 582047 777784	3, 4, 6 Cyl (1981+)	3	3	✓	



REF	OEM				2T STROKES	4T STROKES
PH200-T014	391264 393259 393988 394176 983019	3, 4, 6 Et 8 Cyl (1981+)	3	2	✓	



REF	OEM				2T STROKES	4T STROKES
PH200-T072	5005822 5005831 5005875 5006479	J/E 15- 90 HP (2004+)		4	2	✓







REF	OEM				2T STROKES	4T STROKES
PH200-T022	433226	40, 48, 50 HP (1989+)		4	2	✓



REF	OEM				2T STROKES	4T STROKES
PH200-T021	437801 435532	Heavy Duty, J Suffix 25, 40, 48, 50 HP (1992+) Hollow hex. shaft.		4	2	✓







REF	OEM				2T STROKES	4T STROKES
REC38100-96J00	5033838 5034526 5034627 5035113 5035513	J60 / 70 / 90 / 115 / 140 / 200 / 225 BJ60 / 70 / 90 / 115 / 140 / 220 / 225 (2003-06)		4	2	✓



REF	OEM				2T STROKES	4T STROKES
PH200-T046	5032670	E40 / J40 / BJ40 E50 J50 / BJ50 (2001-04)		4	2	✓



REF	OEM				2T STROKES	4T STROKES
PH200-T005	434495 434496 438529 5005374 438531	60, 70, 90, 115, 150, 175, 200, 225 HP (1991+) 120 - 140 HP (1991-94) 50 HP (3 cyl) 60 JP V4 - 130 HP		4	2	✓





REF	OEM				2T STROKES	4T STROKES
PH200-T062	5036081 5032670 5031482	J/BJ 40, 50 (1999-06)		4	2	✓



new



REF	OEM				2T STROKES	4T STROKES
REC38100-99E01-0EP	5030829 5030828 5030830 5031166	J70		4	2	✓

REF	OEM				2T STROKES	4T STROKES
REC38100-87J00	5031482	E40 / E50 (1999-06)		4	2	✓



REF	OEM				2T STROKES	4T STROKES
PH200-T061	5006319 5005838 5005817	E75, E90, E115, E130 (2004+) J40, J50 (2005) E-TEC	4	2	✓	



REF	OEM				2T STROKES	4T STROKES
REC435548	435548 983446 985237	V6 Commercial (1993) V8 (1993+)	3	2	✓	



REF	OEM				2T STROKES	4T STROKES
PH200-T004	439937 5005254 438786	75-250 HP (1998+)	4	2		



REF	OEM		2T STROKES	4T STROKES
REC173944	173944 172588	Motores pequeños Small outboards Motori piccoli Petits Moteurs	✓	

Para bomba OMC 173946 OMC pump 173946 Pompa OMC 173946 Pompe OMC 173946



POWER TRIM COMPLETO

POWER TRIM ASSEMBLY

POWER TRIM COMPLETO

POWER TRIM COMPLET

REF	OEM		2T STROKES	4T STROKES
REC18-6865	5005114	3 RAM 115-225 HP No / Not 250 Et 300 HP	✓	✓



SENSOR DE TRIM

TRIM SENSOR

SENSORE TRIM

SONDE DE TRIM

REF	OEM		2T STROKES	4T STROKES
REC34801-93J03	5035099 5036277	J, BJ200HP J, BJ225 HP		✓



new

REF	OEM		2T STROKES	4T STROKES
REC34801-99E04	5036054 5031474 5031116	J, BJ40 J, BJ50 J, BJ60 J, BJ70 J30 J, BJ90 J, BJ115 J, BJ140		✓



new

RELÉ DE TRIM

TRIM RELAY

RELE TRIM

RELAIS DE TRIM

REF	OEM		2T STROKES	4T STROKES
REC38410-93J12	5036701 5034606	40- 300 HP		✓

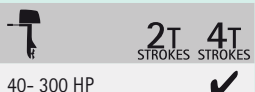

new

TAPON PISTÓN TRIM

PLUG PISTON TRIM

TAPPO PISTONE TRIM

BOUCHON VERIN DE TRIM

REF	OEM	
REC48630-94900	5030870 J70	

new

REF	OEM	
REC48630-92J00	5033935 J, BJ140 HP	

new

EXTRACTOR TAPONES DE TRIM

TRIM PLUGS EXTRACTOR

ESTRATTORE PER TAPPI DI TRIM

KIT EXTRACTEUR

REF	
RECTOOLTRIMKIT	RECTOOLTRIM1 + RECTOOLTRIM2 + RECTOOLTRIM3

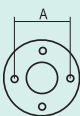

REF					
RECTOOLTRIM1	1/2"	+ RECPIN4	+ RECPIN4.5	38 mm	
RECTOOLTRIM2	1/2"	+ RECPIN4	+ RECPIN4.5	32 mm	
RECTOOLTRIM3	1/2"	+ RECPIN6		35 mm	

	TRIM PISTON	TILT PISTON
Evinrude E-Series E115 to E225 (1998+)	RECTOOLTRIM2	RECTOOLTRIM3
Evinrude E-TEC 115 to 300Hp	RECTOOLTRIM2	RECTOOLTRIM3
Jhonson J-Series J115 to J250 (1998-06)	RECTOOLTRIM2	RECTOOLTRIM3

KITS DE RECAMBIO

Los pines de repuesto no tienen garantía.

REF	
RECPIN4	3 PIN x 4 mm
RECPIN4.5	3 PIN x 4.5 mm
RECPIN6	3 PIN x 6 mm

SPARE KITS

Replacement pins are not guaranteed.



KIT DI RICAMBIO

I perni di ricambio non sono garantiti.

KIT DE RECHANGE

Les pines de remplacement ne sont pas garanties

REF STA84154



REF STA84104



PLATINOS Y CONDESADORES

POINTS & CONDENSERS

PUNTINE E CONDENSATORE

VIS PLATINEES ET CONDENSATEUR

CONDENSADORES

CONDENSERS

CONDENSATORI

CONDENSATEUR

REF	OEM
REC0580321	580321



REF	OEM
REC0581419	581419



REF	OEM
REC0580256	580256



PLATINOS		POINTS		PUNTINE		VIS PLATINEES	
REF	OEM			REF	OEM		
REC0581207	581207			REC0580148	580148		
							
REF	OEM						
REC0580290	580290						
							

KITS

REF	PLATINO POINT PUNTINO VIS PLATINEE	CONDENSADOR CONDENSER CONDENSATORE CONDENSATEUR	
REC0172522	REC0580148	REC0580321	X2
REC0172523	REC0580148	REC0581419	X2
REC0172806	REC0581207	REC0581419	X2
REC0172525	REC0580290	REC0580256	X2



REC0172522



REC0172523



REC0172806



REC0172525

GUÍA PLATINOS Y CONDENSADORES					CONDENSERS & POINTS GUIDE					GUIDA CONDENSATORI E PUNTINE					GUIDE CONDENSATEUR ET VIS PLATINEES				
REF		PLATINO POINT PUNTINO VIS PLATINEE	CONDENSADOR CONDENSER CONDENSATORE CONDENSATEUR	KIT	REF		PLATINO POINT PUNTINO VIS PLATINEE	CONDENSADOR CONDENSER CONDENSATORE CONDENSATEUR	KIT	REF		PLATINO POINT PUNTINO VIS PLATINEE	CONDENSADOR CONDENSER CONDENSATORE CONDENSATEUR	KIT	REF		PLATINO POINT PUNTINO VIS PLATINEE	CONDENSADOR CONDENSER CONDENSATORE CONDENSATEUR	KIT
3	1950-68	REC0580148	REC0580321	REC0172522	30	1956	REC0580148	REC0580321	REC0172522	30	1956	REC0580148	REC0580321	REC0172522	30	1956	REC0580148	REC0580321	REC0172522
4	1969-76	REC0580148	REC0580321	REC0172522	33	1965-70	REC0580148	REC0581419	REC0172523	33	1965-70	REC0580148	REC0581419	REC0172523	33	1965-70	REC0580148	REC0581419	REC0172523
4	1981-90	REC0580148	REC0580321	REC0172522	35	1957-61	REC0580148	REC0580321	REC0172522	35	1957-61	REC0580148	REC0580321	REC0172522	35	1957-61	REC0580148	REC0580321	REC0172522
4.5	1981	REC0581207	REC0581419	REC0172806	35	1976	REC0580148	REC0581419	REC0172523	35	1976	REC0580148	REC0581419	REC0172523	35	1976	REC0580148	REC0581419	REC0172523
5	1950-68	REC0580148	REC0580321	REC0172522	40	1951-61	REC0581207	REC0580321	REC0172522	40	1951-61	REC0581207	REC0580321	REC0172522	40	1951-61	REC0581207	REC0580321	REC0172522
5.5	1954-64	REC0580148	REC0580321	REC0172522	40	1962-73	REC0580148	REC0581419	REC0172523	40	1962-73	REC0580148	REC0581419	REC0172523	40	1962-73	REC0580148	REC0581419	REC0172523
6	1951-76	REC0580148	REC0580321	REC0172522	40	1974-83	REC0580148	REC0581419	REC0172523	40	1974-83	REC0580148	REC0581419	REC0172523	40	1974-83	REC0580148	REC0581419	REC0172523
7.5	1950-68	REC0580148	REC0580321	REC0172522	40C	1981-83	REC0581207	REC0581419	REC0172806	40C	1981-83	REC0581207	REC0581419	REC0172806	40C	1981-83	REC0581207	REC0581419	REC0172806
9.5	1964-73	REC0580148	REC0580321	REC0172522	45	1958-59	REC0580290	REC0580256	REC0172525	45	1958-59	REC0580290	REC0580256	REC0172525	45	1958-59	REC0580290	REC0580256	REC0172525
9.5	1974-76	REC0581207	REC0581419	REC0172806	50	1958-59	REC0580290	REC0580256	REC0172525	50	1958-59	REC0580290	REC0580256	REC0172525	50	1958-59	REC0580290	REC0580256	REC0172525
9.9	1974-76	REC0580290	REC0581419	REC0172806	60	1964-67	REC0580290	REC0580256	REC0172525	60	1964-67	REC0580290	REC0580256	REC0172525	60	1964-67	REC0580290	REC0580256	REC0172525
10	1950-68	REC0580148	REC0580321	REC0172522	75	1960-65	REC0580290	REC0580256	REC0172525	75	1960-65	REC0580290	REC0580256	REC0172525	75	1960-65	REC0580290	REC0580256	REC0172525
15	1974-76	REC0581207	REC0581419	REC0172806	80	1966-67	REC0580290	REC0580256	REC0172525	80	1966-67	REC0580290	REC0580256	REC0172525	80	1966-67	REC0580290	REC0580256	REC0172525
15	1950-68	REC0580148	REC0580321	REC0172522	90	1964-75	REC0580290	REC0580256	REC0172525	90	1964-75	REC0580290	REC0580256	REC0172525	90	1964-75	REC0580290	REC0580256	REC0172525
18	1957-61	REC0580148	REC0580321	REC0172522	100	1966	REC0580290	REC0580256	REC0172525	100	1966	REC0580290	REC0580256	REC0172525	100	1966	REC0580290	REC0580256	REC0172525
18	1962-73	REC0580148	REC0581419	REC0172523															
20	1957-76	REC0580148	REC0581419	REC0172523															
25	1969-76	REC0580148	REC0581419	REC0172523															
28	1962-64	REC0580148	REC0581419	REC0172523															

SISTEMA DE GOBIERNO STEERING SYSTEM

SISTEMA DI GUIDA SYSTÈME DE COMMANDE

MANDOS DE CONTROL

ENGINE CONTROLS

COMANDI DI
CONTROLLO



BOITIER DE COMMANDE

MANDO LATERAL



SIDE CONTROL

COMANDO LATERALE

BOITIER LATERAL

REF	OEM	TRIM			BRP
REC5006180	5006180	✓	✓		1996+



REF	OEM	TRIM			BRP
REC5006181	5006181		✓		1974+





MANDO PARA CONSOLA

CONSOLE CONTROL

COMANDO PER
CONSOLLA



BOITIER POUR CONSOLE

REF	OEM	TRIM		
REC5006182	5006182	✓		BRP 1996+
REC5006184	5006184	✓		BRP 1996+



REC5006182

REC5006184

REF	OEM	TRIM		
REC5006186	5006186	✓	✓	BRP 1996+



INTERRUPTORES
Y CABLES

SWITCHS & CABLES

INTERRUTTORI E CAVI

INTERRUPTEUR
ET CÂBLES

INTERRUPTOR MANDO

CONTROL SWITCH

INTERRUTTORI
CONTROLLO

INTERRUPTEUR DE
CONTROLE

REF	OEM
REC0176408	176408

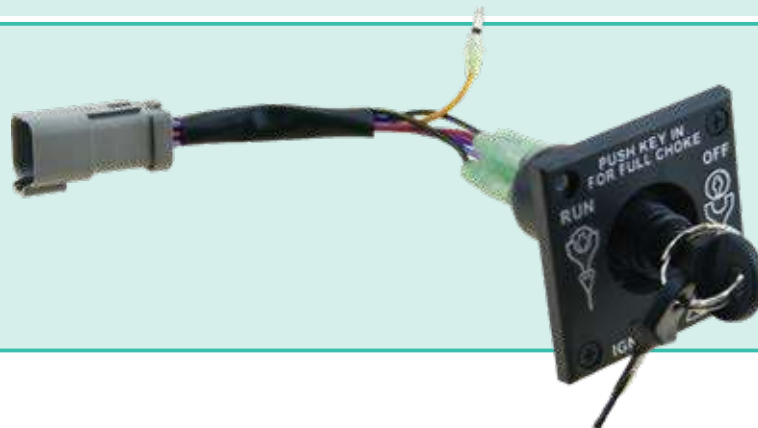

ARNÉS

ARNES

CAVI

FAISCEAU ELECTRIQUE

REF	OEM	
REC0176340	176340	10 FT
REC0176342	176342	20 FT



REC0176342

REC0176340

EXTENSIÓN DE ARNÉS

ARNES EXTENSION

ESTENSIONE

RALLONGE FAISCEAU

REF	OEM	
REC0176333	176333	5 FT
REC0176335	176335	20 FT



REC0176333

REC0176335

CABLES DE CONTROL

CONTROL CABLE

CAVI COMANDO

CÂBLES DE COMMANDE

REF	OEM	
PREMC30506	173106	6' / 1,80 m
PREMC30507	173107	7' / 2,10 m
PREMC30508	173105	8' / 2,45 m
PREMC30509	173109	9' / 2,75 m
PREMC30510	173110	10' / 3,05 m
PREMC30511	173111	11' / 3,35 m
PREMC30512	173112	12' / 3,65 m
PREMC30513	173113	13' / 3,95 m
PREMC30514	173114	14' / 4,25 m
PREMC30515	173115	15' / 4,60 m
PREMC30516	173116	16' / 4,90 m
PREMC30517	173117	17' / 5,20 m
PREMC30518	173118	18' / 5,50 m
PREMC30519	173119	19' / 5,80 m
PREMC30520	173120	20' / 6,10 m
PREMC30521	173121	21' / 6,40 m
PREMC30522	173122	22' / 6,70 m
PREMC30523	173123	23' / 7,00 m
PREMC30524	173124	24' / 7,30 m



CABLES DE ACELERADOR

THROTTLE CABLE

CAVO ACCELERATORE

CÂBLES D'ACELERATION

REF	OEM	
REC0397004	397004	6, 8 (1968-90)
REC0433325	433325	8
REC0435230	435230	15 (1989+)
REC0500581	500581 396161	20, 25, 30 (1986+)
REC0398243	398243	25 (1989+)
REC0439542	439542	35



SISTEMA DE REFRIGERACIÓN COOLING SYSTEM

SISTEMA DI RAFFREDDAMENTO SYSTÈME DE REFROIDISSEMENT

LÍQUIDO INHIBIDOR DE LA CORROSIÓN

SALT OFF

Diseñado especialmente para eliminar sedimentos de sal de cualquier superficie pintada, de metal, fibra de vidrio, vinilo, caucho, cristal o plástico. Es el método más eficaz para proteger los motores, los aparejos de pesca... Genera una capa de polímeros que evita futuras sedimentaciones.

It is specifically formulated to quickly and effectively remove salt deposits from metal, fiberglass, plastic or painted surfaces. It contains special polymers that bond to the treated surface to help prevent the formation of future deposits.

LIQUIDO INIBITORE DELLA CORROSIONE

SALT OFF

Appositamente progettato per rimuovere depositi di sale da qualsiasi superficie verniciata, metallo, fibra di vetro, vinile, gomma, vetro o plastica. È il metodo più efficace per proteggere motori, attrezzi da pesca... Genera uno strato di polimeri che impedisce la futura sedimentazione.

La protection SALT OFF est formulé pour éliminer les dépôts de sel sur toutes les surfaces marines. Utilisable pour le rinçage des moteurs hors bord et inboard et les embases. Il laisse un film de protection spécial pour prévenir des attaques futures du sel.

new



REF
STA94100

Star brite



REF	Image of Jug	Volume
STA93900		3,78 L
STA93922		650 ml
STA93932		1 L

STA93900



STA93932



STA93922



P
32



P
39

JOHNSON EVINRUDE

RECAMBIOS
MARINOS

TERMOSTATO

THERMOSTAT

TERMOSTATO

THERMOSTAT

DESPIECES DE TERMOSTATO

THERMOSTAT ASSEMBLIES

ESPLOSO TERMOSTATO

PIÈCES DE THERMOSTAT

2 CYL 25/35 HP (1996-01)

REF	OEM				
1	308458	ARO	O-RING	O-RING	JOINT TORIQUE
2	REC336185	336185	ARANDELA	WASHER	RONDELLA
3	336211	MUELLE	SPRING	MOLLA	RESSORT
4	REC878904	436195	TERMOSTATO	THERMOSTAT	TERMOSTATO
5	336179	MUELLE	SPRING	MOLLA	RESSORT
6	REC301967	301967	ARO	O-RING	JOINT TORIQUE

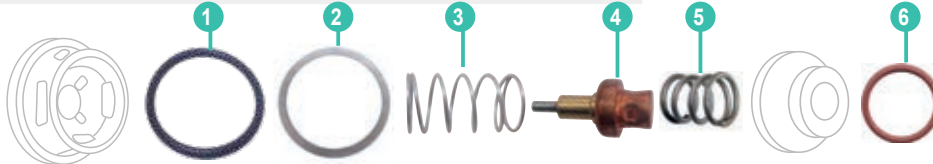

2, 3 CYL, V4 LOOPCHARGED (1992-00)

REF	OEM				
1	REC343141	343141	TAPA	COVER	COPERCHIO
2	REC329830	329830	JUNTA	GASKET	GUARNIZIONE
3	REC336185	336185	ARANDELA	WASHER	RONDELLA
4	336211	MUELLE 60-70 HP (1993) y V4 Con tapa de termostato 339207	SPRING60-70 HP (1993) Et V4 use with cover 339207	MOLLA 60-70 HP (1993) e V4 usare con coperchio 339207	RESSORT 60-70 HP (1993) et V4 avec couvercle 339207
4	342421	MUELLE 40-70 HP (1995-96) y V4	SPRING 40-70 HP (1995-96) Et V4	MOLLA 40-70 HP (1995-96) e V4	RESSORT 40-70 HP (1995-96) et V4
4	343115	MUELLE 40-70 HP (1997-98)	SPRING 40-70 HP (1997-98)	MOLLA 40-70 HP (1997-98)	RESSORT 40-70 HP (1997-98)
4	343020	MUELLE V4	SPRING V4	MOLLA V4	RESSORT V4
5	REC435957	435957	DIAFRAGMA	DIAPHRAGM	MEMBRANA
6	REC878904	436195	TERMOSTATO	THERMOSTAT	TERMOSTATO
7	336179	MUELLE	SPRING	MOLLA	RESSORT
8	REC336178	336178	CAMISA TERMOSTATO	THERMOSTAT SLEEVE	SEDE TERMOSTATO



V4 CROSSFLOW

REF	OEM				
1	REC332369	332369	JUNTA	GASKET	GUARNIZIONE
2	REC321692	321692	GRUESO	GROMMET	SPESSORE
3	REC318395	318395	VÁLVULA	VALVE	VALVOLA
4	REC6F5-12411-03	5005440	TERMOSTATO	THERMOSTAT	TERMOSTATO
5	REC321932	321932	JUNTA	GASKET	GUARNIZIONE
6	REC317245	317245	MUELLE	SPRING	MOLLA
7	REC318373	318373	JUNTA (1973-77)	GASKET (1973-77)	GUARNIZIONE (1973-77)
7	REC342513	342513	JUNTA (1978-97)	GASKET (1978-97)	GUARNIZIONE (1978-97)

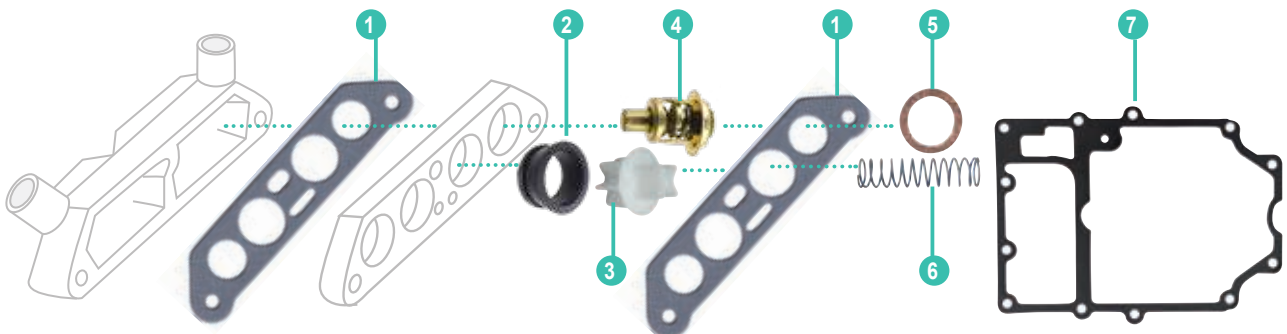

V6 CROSSFLOW

	REF	OEM				
1	REC321184	321184	JUNTA	GASKET	GUARNIZIONE	JOINT
2	REC317245	317245	MUELLE	SPRING	MOLLA	RESSORT
3	REC6F5-12411-03	5005440	TERMOSTATO	THERMOSTAT	TERMOSTATO	THERMOSTAT
4	REC27-62386001	310058	JUNTA	GASKET	GUARNIZIONE	JOINT
5	REC306643	306643	TORNILLO	SCREW	VITE	VIS
6	REC321120	321120	TAPA CIERRE	PLATE SEAL	COPERCHIO	COUVERCLE
7	REC321221	321221	DIAFRAGMA	DIAPHRAGM	MEMBARNA	DIAPHRAGME
8	REC321027	321027	VÁLVULA	VALVE	VALVOLA	SOUPAPE
9	REC320880	320880	ASIENTO VÁLVULA	VALVE SEAT	SEDE VALVOLA	SIEGE DE SOUPAPE
10	REC321222	321222	TAPA VÁLVULA	VALVE CUP	COPERCHIO VALVOLA	COUVERCLE

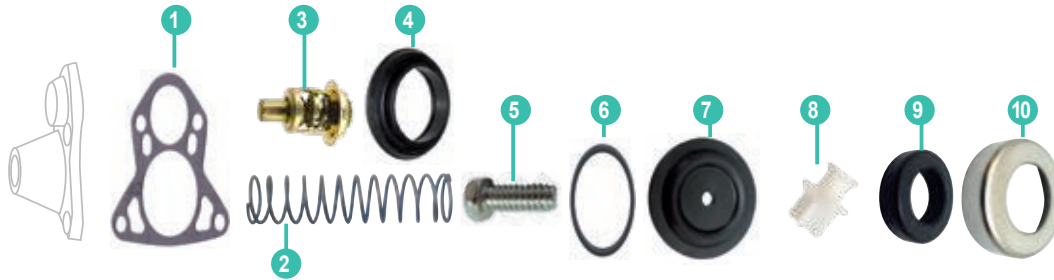

TERMOSTATO

THERMOSTAT

TERMOSTATO

THERMOSTAT

REF	OEM		°C
REC396987	396987	3 Cyl (-1985)	61°



REF	OEM		°C
REC434137	434137	3 Cyl, (1986-91) V4 Loopcharged, V8	61°



REF	OEM		°C
REC5001036	5001036	V6 200-250 Ficht Flujo alto Higher flow Flusso alto Haut débit	56°



REF	OEM		°C
REC878904	436195	9.9, 15, 40, 48, 50 HP 3 Cyl, V4	61°



REF	OEM		°C
REC6F5-12411-03	434841 5005440	6-55 HP, V4, V6 Crossflow	61°



REF	OEM		°C
REC394411	394411	Vernatherm, 65, 85, 100, 115, 135 HP (1971-90)	61°



REF	OEM		°C
REC435491	435491	V4, 90-115 HP (1995+) V6, 150-175 HP (1991+)	61°



REF	OEM		°C
REC437090	437090	V6 OFFSHORE Acero Inox. Flujo bajo. Stainles Steel. Lower flow. Acciaio inox. Flusso basso. Acier inox. Faible débit	56°



REF	OEM		2T STROKES	4T STROKES	°C
REC17670-94J01	5036226	J/BJ25		✓	60°



REF	OEM		2T STROKES	4T STROKES	°C
REC17670-87J00	50317562	40 - 70 HP		✓	72°



REF	OEM		2T STROKES	4T STROKES	°C
REC17670-91J01	5033385	2, 4, 5 hp		✓	50°





REF	OEM		2T STROKES	4T STROKES	°C
REC17670-90J10	5033722	J/BJ 90 - 225 HP		✓	71°



REF	OEM		2T STROKES	4T STROKES	°C
REC17670-93962	5030742 5031175 5030742	J/BJ 70-140 HP		✓	50°



REF	OEM		2T STROKES	4T STROKES	°C
REC67F-12411-01	5033721	J/BJ140		✓	60°



REF	OEM		2T STROKES	4T STROKES	°C
REC17670-94402	5031758	10 - 70 HP		✓	60°



KITS TERMOSTATO

THERMOSTATO KITS

KIT TERMOSTATO

KIT THERMOSTAT

REF		°C	REF	OEM	TERMOSTATO	THERMOSTAT	TERMOSTATO	THERMOSTAT
REC13450	3 CYL	90°	REC396987		TERMOSTATO	THERMOSTAT	TERMOSTATO	THERMOSTAT
			REC332108	332108	JUNTA	GASKET	GUARNIZIONE	JOINT
			REC3852120		JUNTA	GASKET	GUARNIZIONE	JOINT



REF		°C	REF	OEM	TERMOSTATO	THERMOSTAT	TERMOSTATO	THERMOSTAT
REC13350	6-55 HP V4, V6	90°	REC6F5-12411-03	434841	TERMOSTATO	THERMOSTAT	TERMOSTATO	THERMOSTAT
			REC27-62386001	332108	JUNTA	GASKET	GUARNIZIONE	JOINT



REF		°C	REF	OEM				
REC13270	V4 Crossflow	143°	REC6F5-12411-03	434841	TERMOSTATO	THERMOSTAT	TERMOSTATO	THERMOSTAT
			REC318395	318395	TERMOSTATO	THERMOSTAT	TERMOSTATO	THERMOSTAT
			REC321932	321932	JUNTA	GASKET	GUARNIZIONE	JOINT
			REC332369	332369	JUNTA	GASKET	GUARNIZIONE	JOINT
			REC317245	317245	VÁLVULA	VALVE	VALVOLA	SOUPAPE
			REC321692	321692	MUELLE	SPRING	MOLLA	RESSORT
			REC332369	332369	GRUESO	GROMMET	SPESSORE	CALE



REF		°C	REF	OEM				
REC435597			REC435491	435491	TERMOSTATO	THERMOSTAT	TERMOSTATO	THERMOSTAT
			REC338632	338632	TAPA	COVER	COPERCHIO	COUVERCLE
			REC331188	331188	TÓRICA	O-RING	O-RING	TORIQUE
			337067	MUELLE	SPRING	MOLLA	RESSORT	



REF		°C	REF	OEM				
REC13290	V4-V6	143° 60°	REC435491	435491	TERMOSTATO	THERMOSTAT	TERMOSTATO	THERMOSTAT
			REC338632	338632	TAPA	COVER	COPERCHIO	COUVERCLE
			REC331188	331188	TÓRICA	O-RING	O-RING	JOINT TO-RIQUE
			337067	MUELLE	SPRING	MOLLA	RESSORT	
			REC343105	343105	CAMISA	SLEEVE	CAMICIA	BAGUE DE THERMOSTAT



REF		°C	REF	OEM				
REC13310			REC437090	437090	TERMOSTATO	THERMOSTAT	TERMOSTATO	THERMOSTAT
			REC332944	332944	TAPA	COVER	COPERCHIO	COUVERCLE
			REC331188	331188	TÓRICA	O-RING	O-RING	JOINT TO-RIQUE
			337067	MUELLE	SPRING	MOLLA	RESSORT	
			REC339044	339044	JUNTA	GASKET	GUARNIZIONE	JOINT



REF		°C	REF	OEM				
REC13280	V6 Crossflow	143°	REC6F5-12411-03	434841	TERMOSTATO	THERMOSTAT	TERMOSTATO	THERMOSTAT
			REC27-62386001	310058	RETÉN	SEAL	PARAOLIO	JOINT SPI
			REC321184	321184	JUNTA	GASKET	GUARNIZIONE	JOINT
			REC320880	320880	ASIENTO VÁLVULA	VALVE SEAT	SEDE VALVOLA	JOINT DE VALVE
			REC321027	321027	VÁLVULA	VALVE	VALVOLA	SOUPAPE
			REC321222	321222	TAPA VÁLVULA	VALVE CUP	COPERCHIO VALVOLA	COUVERCLE SOUPAPE
			REC317245	317245	MUELLE	SPRING	MOLLA	RESSORT
			REC321221	321221	DIAFRAGMA VÁLVULA	VALVE DIAPHRAGM	MEMBRANA DI VALVOLA	JOINT DE VALVE
			REC321220	321220	MUELLE RETENEDOR	SPRING RETAINER	MOLLA DI CONTENIMENTO	RESSORT RETENEUR





REF		°C	REF	OEM				
REC13260	V6 Offshore	133°	REC437090	437090	TERMOSTATO	THERMOSTAT	TERMOSTATO	THERMOSTAT
			REC332944	332944	TAPA	COVER	COPERCHIO	COUVERCLE
			REC331188	331188	TÓRICA	O-RING	O-RING	JOINT TORIQUE
			337067	MUELLE	SPRING	MOLLA	RESSORT	
			REC343105	3343105	CAMISA	SLEEVE	CAMICIA	BAGUE DE THERMOSTAT
			REC339044	339044	JUNTA	GASKET	GUARNIZIONE	JOINT





JUNTAS TERMOSTATO

THERMOSTATO GASKETS

REF	OEM		GOMA RUBBER GOMMA CAOUTCHOUT	CORCHO CORK SUGHERO LIEGE
REC323582	323582	2 cyl. Crossflow, 9.9 - 25 HP	✓	



REF	OEM		GOMA RUBBER GOMMA CAOUTCHOUT	CORCHO CORK SUGHERO LIEGE
REC0329319	329319	2 Cyl, Crossflow 8 - 30 HP	✓	



REF	OEM		GOMA RUBBER GOMMA CAOUTCHOUT	CORCHO CORK SUGHERO LIEGE
REC339044	339044	60° V4, V6	✓	





GUARNIZIONI TERMOSTATO

JOINTS DE THERMOSTAT

REF	OEM		GOMA RUBBER GOMMA CAOUTCHOUT	CORCHO CORK SUGHERO LIEGE
REC27-62386001	310058	2 Cyl, Crossflow 90° V6 Crossflow	✓	





REF	OEM		GOMA RUBBER GOMMA CAOUTCHOUT	CORCHO CORK SUGHERO LIEGE
REC332130	332130	3 Cyl	✓	



REF	OEM		GOMA RUBBER GOMMA CAOUTCHOUT	CORCHO CORK SUGHERO LIEGE
REC3852120	313416	3 CYL		✓



REF	OEM		GOMA RUBBER GOMMA CAOUTCHOUT	CORCHO CORK SUGHERO LIEGE
REC321932	321932	90° V4 Crossflow		✓



ASIENTO DE TERMOSTATO

THERMOSTATO SEAT

SEDE DI TERMOSTATO

JOINT DE THERMOSTAT



REF	OEM	
REC335981	335981	



CUBIERTAS TERMOSTATO



THERMOSTATO COVER



COPERCHIO TERMOSTATO

COUVERCLE DE THERMOSTAT

REF	OEM		
REC343141	343141	50 - 70 HP (1986+)	

REF	OEM		
REC332944	332944	2 Cyl, Loopcharged (1997) V6 Offshore	

REF	OEM		
REC338632	338632	60° V4, V6	



REF	OEM		
REC344771	344771 0344771	EFI & E-TECH 200 - 300 HP (1999+)	



















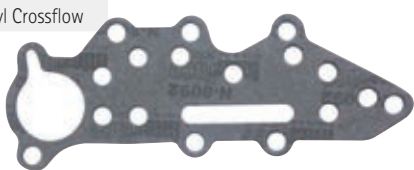





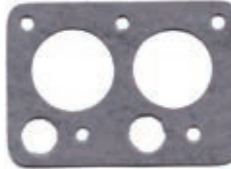





GRUESO

GROMMET

SPESSORE

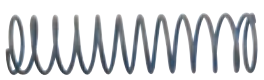
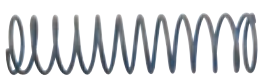
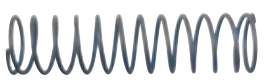
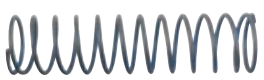
BAGUE

REF	OEM		
REC321692	321692	V4 Crossflow	

JUNTAS TAPA DE REFRIGERACIÓN			GASKET, EXHAUST INNER COVER	GUARNIZIONE COPERCHIO REFRIGERAZIONE			JOINT DE PLAQUE DE REFROIDISSEMENT
REF	OEM			REF	OEM		
REC329076	329076	6 - 8 HP		REC336947	336947	5, 6, 8, 10, 15 HP (1991-01)	
REF	OEM			REF	OEM		
REC308328	308328	2 Cyl Crossflow		REC311145	311145	2 Cyl Crossflow	
REF	OEM			REF	OEM		
REC318917	318917	2 Cyl Crossflow		REC329830	329830	2, 3 Cyl Loopcharged 90° V4 Loopcharged	
REF	OEM			REF	OEM		
REC332108	332108	3 Cyl 49 C.I. (1985-88)		REC305586	305586	90° V4 Crossflow	
REF	OEM			REF	OEM		
REC332369	332369	90° V4 Crossflow		REC321184	321184	90° V6 Crossflow	
REF	OEM			REF	OEM		
REC337068	337068	90° V6 Loopcharged		REC321027	321027	V6 Crossflow	
VÁLVULA ANTIPRESIÓN DE TERMOSTATO			THERMOTAT, PRESSURE VALVE	VALVOLA ANTI-PRESSIONE DE TERMOSTATO			SOUPAPE DE PRESSION DE THERMOSTAT
REF	OEM			REF	OEM		
REC318395	318395	V4 Crossflow		REC321027	321027	V6 Crossflow	
RESORTE			SPRING	MOLLA			RESSORT
REF	OEM			REF	OEM		
REC337067	337067			REC317245	317245		
REC317245	317245						
RETENEDOR MUELLE			SPRING RETAINER	TENUTA MOLLA			COUPELLE DE RESSORT
REF	OEM			REF	OEM		
REC321220	321220	V6 Crossflow		REC321220	321220	V6 Crossflow	

DIAFRAGMA DIAPHRAGM MEMBRANA DIAPHRAGME

REF	OEM	
REC435957	321692	2 Cyl, 3 Cyl V4 Loopcharged



REF	OEM	
REC394408	394408	V4 / V6 Loopcharged



REF	OEM	
REC321221	321221	V6 Crossflow





ASIENTO DE VÁLVULA VALVE SEAT SEDE DI VALVOLA JOINT DE VALVE

REF	OEM	
REC320880	320880	V6 Crossflow



TAPA CUP COPERCHIO COUVERCLE

REF	OEM	
REC330273	330273	V4 / V6 Loopcharged





REF	OEM	
REC321222	321222	V6 Crossflow





CAMISA TERMOSTATO THERMOSTAT SLEEVE MANICOTTO TERMOSTATO LOGEMENT THERMOSTAT

REF	OEM	
REC343105	343105	



REF	OEM	
REC336178	336178	2 Cyl, 3 Cyl, V4 Loopcharged



REF	OEM	
REC337533	337533	90° V6 Loopcharged





ARANDELA WASHER RONDELLA RONDELLE



REF	OEM	
REC336185	336185	2 Cyl, 3 Cyl V4 Loopcharged



NIPLE NIPPLE NIPLE TETINE

REF	OEM		
REC126776	126776	5/16	60 - 70 HP (1988+)



REF	OEM		
REC321886	321886	3/8	9.9 - 15 HP(1978-95) 20 - 35 HP (1978-80) 3 Cyl, V4 (-1978), V6 (1978-92) 40 - 60 HP, 2 Cyl (1978-91) V6 (1987-90) Loopcharged V8 (1986-91) Con dirección hidráulica. With Power Steering. Con timoneria idraulica. Avec direction hydraulique



KIT	PLUG WATER FLUSH	KIT TAPPO	KIT BOUCHON
REF	OEM		
REC17913-93J00	5035054 J/BJ 25 - 225 HP	REC17914-93J00	5035055

GUÍA DE TERMOSTATO		THERMOSTAT GUIDE	GUIDA TERMOSTATO	GUIDE THERMOSTAT						
	KIT	TERMOSTATO THERMOSTAT TERMOSTATO THERMOSTAT	VÁLVULA VALVE VALVOLA SOUPAPE	KIT VÁLVULA VALVE KIT KIT VALVOLA KIT SOUPAPE	DIAPHRAGMA DIAPHRAGM MEMBRANA DIAPHRAGME	RETÉN VÁLVULA VALVE RETAINER TENUTA VALVOLA JOINT SOUPAPE	TAPA VÁLVULA VALVE CUP COPERCHIO VALVOLA COUVERCLE SOUPAPE	MUELLE VÁLVULA VALVE SPRING MOLLA VALVOLA RESSORT SOUPAPE	GOMA GROMMET GOMMA BAGUE	
5	1965-68, 86	REC13350	REC6F5-12411-03							
5.5	1959-64	REC13350	REC6F5-12411-03							
6	1965-79, 86	REC13350	REC6F5-12411-03							
7.5	1980-86	REC13350	REC6F5-12411-03							
8	1986	REC13350	REC6F5-12411-03							
9.5	1964-73	REC13350	REC6F5-12411-03							
9.9	1974-86	REC13350	REC6F5-12411-03							
10	1959-63	REC13350	REC6F5-12411-03							
15	1974-86	REC13350	REC6F5-12411-03							
18	1959-73	REC13350	REC6F5-12411-03							
20	1981-94	REC13350	REC6F5-12411-03							
25	1969-94	REC13350	REC6F5-12411-03							
28	1989-94	REC13350	REC6F5-12411-03							
30	1986-94	REC13350	REC6F5-12411-03							
35	1959-76, 94	REC13350	REC6F5-12411-03							
40	1960-69	REC13350	REC6F5-12411-03							
45	1989-92	REC13350	REC6F5-12411-03							
50	1971, 75, 79, 81, 86	REC13350	REC6F5-12411-03							
55	1976-92	REC13350	REC6F5-12411-03							
60	1969-70	REC13350	REC396987							
60	1980-86	REC13350	REC6F5-12411-03							
60,60 TTL	1993		REC878904							
65	1971-73	REC13450	REC396987							
65	1993		REC878904							
65C	1984-86	REC13450	REC396987							
65Jet	1994-95	REC13270	REC6F5-12411-03	REC318395				REC317245	REC321692	
70	1974-86	REC13450	REC396987							
70,70 TTL	1993		REC878904							
75	1978-88	REC13450	REC396987							
80Jet	1994-95	REC13270	REC6F5-12411-03	REC318395				REC317245	REC321692	
85	1978-80	REC13270	REC6F5-12411-03	REC318395				REC317245	REC321692	
85	1993-95		REC6F5-12411-03	REC318395				REC317245	REC321692	
88	1987-95		REC6F5-12411-03	REC318395				REC317245	REC321692	
90	1983-95		REC6F5-12411-03	REC318395				REC317245	REC321692	
90 Jet	1994		REC6F5-12411-03	REC318395				REC317245	REC321692	
100	1979-80		REC6F5-12411-03	REC318395				REC317245	REC321692	
100	1990-95		REC6F5-12411-03	REC318395				REC317245	REC321692	
100 Comm	1984-95		REC6F5-12411-03	REC318395				REC317245	REC321692	
110	1985-89		REC6F5-12411-03	REC318395				REC317245	REC321692	
112	1994-95	REC13270	REC6F5-12411-03	REC318395				REC317245	REC321692	
115	1978-95	REC13270	REC6F5-12411-03	REC318395				REC317245	REC321692	
120	1988-91				REC394408		REC330273			
140	1978-85	REC13270	REC6F5-12411-03	REC318395				REC317245	REC321692	
140	1988-91				REC394408		REC330273			
150	1978-91	REC13350	REC6F5-12411-03	REC321027	REC320880	REC321221	REC321220	REC321222	REC317245	REC321692
155	1984-91	REC13350	REC6F5-12411-03	REC321027	REC320880	REC321221	REC321220	REC321222	REC317245	REC321692
175	1977-91	REC13350	REC6F5-12411-03	REC321027	REC320880	REC321221	REC321220	REC321222	REC317245	REC321692
185	1984-85	REC13350	REC6F5-12411-03	REC321027	REC320880	REC321221	REC321220	REC321222	REC317245	REC321692
200	1977-83	REC13350	REC6F5-12411-03	REC321027	REC320880	REC321221	REC321220	REC321222	REC317245	REC321692
200	1988-93					REC394408	REC321220	REC330273		
225	1988-93					REC394408	REC321220	REC330273		
235	1978-85	REC13350	REC6F5-12411-03	REC321027	REC320880	REC321221	REC321220	REC321222	REC317245	REC321692

REF	OEM	CEF	A	B	C	CHAVETA KEY CIAVETTA CLAVETTE
REC0767407	433935		11,28	34	17,56	
REC386084	386084	CEF500355	12,75	38,6	17,6	REC300611
REC395289	395289	CEF500370C	16	51	19	REC344470
REC765431	382547	CEF500307	19,25	91,5	25,4	REC308928
REC775518	375638	CEF500351	12,7	69	12,8	REC308928
REC396725	396725	CEF500303C	19,13	91,5	25,4	REC331901 REC334897
REC777213	377230	CEF500352	16,04	69,8	22,1	REC308928
REC385072	385072	CEF500306	19,15	89	31,9	REC308928
REC777212	389642	CEF500305	22,32	89	31,9	REC308928
REC777129	389589	CEF500345	16,04	69,20	22,25	REC300611
REC5001593	435821 5001593		22,41	89	31,9	REC331107
REC777214	396809	CEF500346C	16,04	70	22,3	REC331901
REC432941	432941	CEF500372C	19,13	91,30	25,40	REC334897
REC434424	434424	CEF500350	11	69	12,8	REC300611
REC389576	389576 436137	CEF500354G	11,2	38,4	17,9	REC300611
REC763735	387361	CEF500358	11,2	38,4	17,9	
REC390286	390286	CEF500353	17,5	51,5	19	REC308928
REC17461-98503	5030188	CEF500336	10,15	41	14	REC09420-03002
REC17461-93903	5033112	CEF500329	13,2	42	22	REC17462-93990
REC17461-96312	5031417	CEF500362G	17,1	67,5	16,18	REC09420-04006
REC17461-87E12	5030723	CEF500365	22,2	78,3	35,1	
REC17461-90J01	5033542	CEF500367	24,3	86	31,7	REC09420-05009

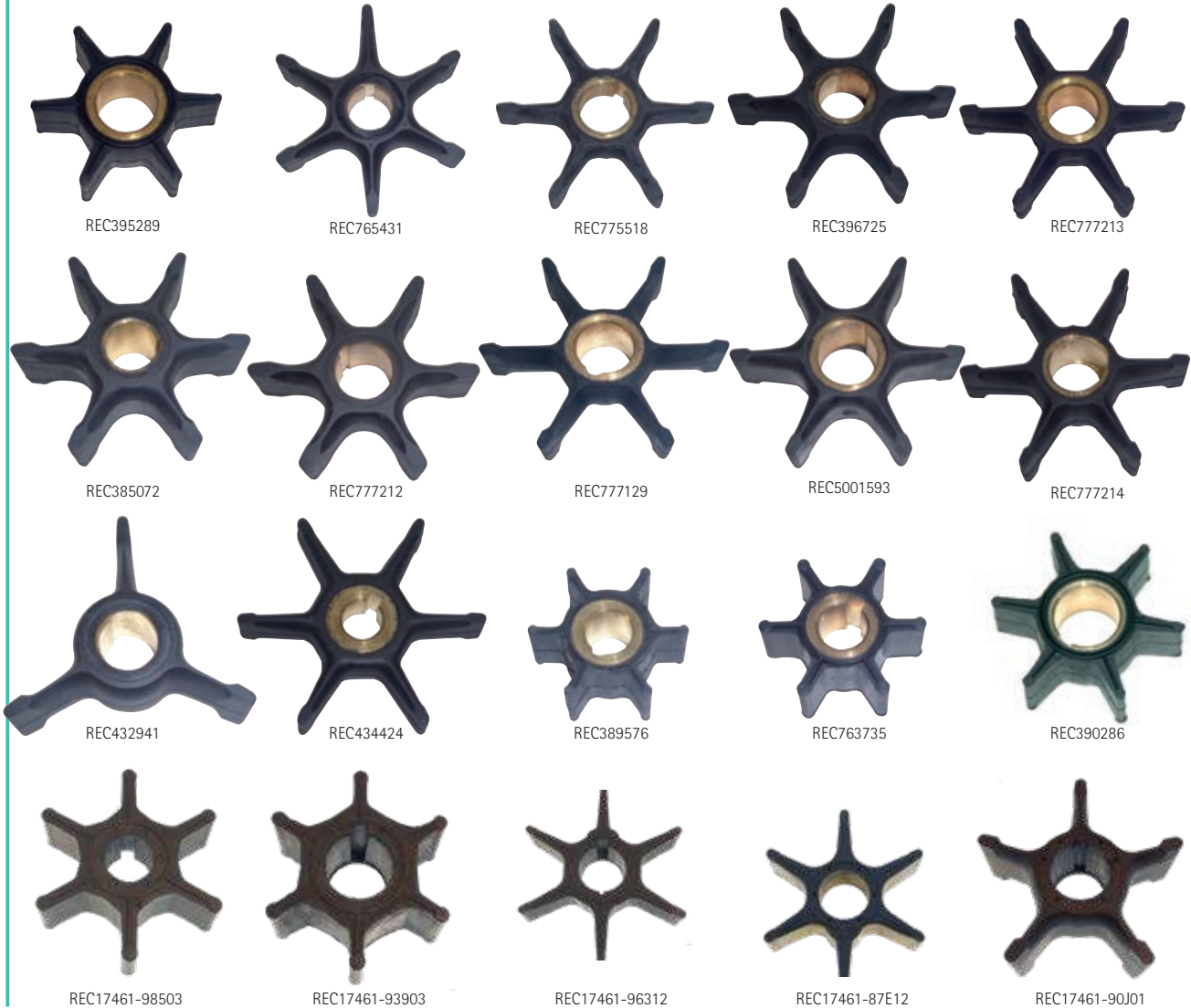
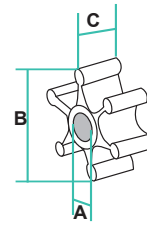

CHAVETA		KEY		CHIAVETTA		CLAVETTE	
REF	OEM	2T STROKES	4T STROKES		2T STROKES	4T STROKES	
REC331901	331901						Plástico
REC344470	330619	✓					Plastic
REC331107	331107						Plastico
							Plastique
REF	OEM	2T STROKES	4T STROKES		2T STROKES	4T STROKES	
REC334897	334897	✓					Plástico
							Plastic
							Plastico
							Plastique
REF	OEM		2T STROKES	4T STROKES	new		
REC09420-04006	5031281	25, 30, 40, 50 HP		✓			
REF	OEM		2T STROKES	4T STROKES	new		
REC17462-93990	5033113	10, 15 HP		✓			
REF	OEM		2T STROKES	4T STROKES	new		
REC09420-03002	5030137	4, 5, 6 HP		✓			
REF	OEM		2T STROKES	4T STROKES	new		
REC09420-05009	5034842 5033632 5084842	90, 115, 140 HP 200, 225 HP		✓			

KITS DE RETENES		SEAL KIT		KIT TENUTE		KITS JOINTS			
REF	OEM		2T STROKES	4T STROKES	REF	OEM		2T STROKES	4T STROKES
REC25700-95D01	5032167, 5036040	E25 / J25 / E30 / J30 (2000-07)		✓	REC25700-88L00	5031456	E40 / J40 / BJ40 E50 / J50 / BJ50 (1999-06)		✓
REF	OEM		2T STROKES	4T STROKES	REF	OEM		2T STROKES	4T STROKES
REC25700-95J00	5037038	J25 / BJ25 (2006-07)			REC25700-99E00	5034776	J60 / J70 / BJ60 / BJ70 (2005-06)		✓

new

REF	OEM	
REC25700-87E00	5030973 5034775	J/BJ 60, 70 HP

REF	OEM		2T STROKES	4T STROKES
REC25700-92J00	5033922	J140 / BJ140 (2003-06)		✓

REF	OEM		2T STROKES	4T STROKES
REC25700-90J01	5033798	J90 / BJ90 J115 / BJ115 (2003-06)		3

REF	OEM		2T STROKES	4T STROKES
REC25700-93J00	5035077	J200 / J225 / BJ200 / BJ225 (2004-06)		3

AROS TÓRICOS O-RING O-RING JOINT TORIQUE

REF	OEM	Ø INT. (")	ANCHO WIDTH LARGHEZZA LARGEUR
REC25-48171	202893	.370	.065
REC301877	301877	.245	.155
REC301967	301967	.799	.103
REC25-33145	302337	2.025	.135
REC302537	302537	1.375	.100
REC125017	302540	1.000	.135
REC302588	302588	1.735	.135
REC339543	303059 339543	.500	.100
REC3852045	303067 329381	.360	.100
REC25-62702	303191	.301	.070
REC303347	303347	.445	.090
REC25-35027	303360	1.060	.135
REC304174	304174	.500	.065
REC305123	305123	3.780	.135
REC305242	305242	.300	.135
REC3852928	305270	1.620	.135

REF	OEM	Ø INT. (")	ANCHO WIDTH LARGHEZZA LARGEUR
REC332583	305739 317178 332583 332584	.250	.065
REC308876	308876	2.235	.100
REC309731	309731	1.185	.100
REC310414	310414	3.625	.135
REC310584	310584	.750	.135
REC25-30613	310585, 310967	.740	.100
REC25-62705	311338	.750	.065
REC313175	313175	4.750	.135
REC313340	313340	1.690	.100
REC967344	313446	3.315	.135
REC313754	313754	1.835	.100
REC338518	313893 338518	2.550	.100
REC314491	314491	.970	.065
REC314728	314728	2.125	.100

REF	OEM	Ø INT. (")	ANCHO WIDTH LARGHEZZA LARGEUR
REC318372	318372	.320	.155
REC318717	318717	1.500	.210
REC0319662	319662	1.799	.103
REC326649	326649 329380 909047	.620	.100
REC326741	326741	4.484	.139
REC333572	333572	.250	.100
REC335523	335523		
REC338522	338522		
REC553126	553126	3.250	.135
REC0554545	554545	1.120	.100
REC908194	908194	4.000	.100
REC908383	908383	2.485	.100
REC909140	909140		
REC25-25439	3852565	.862	.103



RETENES

GEARCASE SEAL

TENUTE PIEDE

JOINTS

REF	OEM	EJE SHAFT ASSE ARBRE	CALIBRE BORE FORO CALIBRE	REF	OEM	EJE SHAFT ASSE ARBRE	CALIBRE BORE FORO CALIBRE	REF	OEM	EJE SHAFT ASSE ARBRE	CALIBRE BORE FORO CALIBRE
REC302564	302564	0.7500	1.3750	REC911685	911685	2.0000	2.5000	REC313353	313353	1.9375	2.4375
REC303345	303345	0.5625	1.0000	REC3853655	916058	0.5000	0.9062	REC26-419533	313992	1.1875	1.8750
REC767970	305987	1.0000	1.3750	REC321786	321786	0.6250	1.1250	REC314167	314167	0.4375	0.9375
REC309989	309989	1.3750	2.0000	REC321787	321787	0.6250	1.1250	REC318972	318972	0.5000	0.8750
REC310599	310599	1.0000	1.5000	REC321788	321788	0.5000	1.0000	REC26-76868	320862	1.1875	1.6875
REC310649	310649	2.5000	3.0000	REC331103	331103	1125	1625	REC26-69188	321453	0.8750	1.2500
REC313282	313282	0.5625	1.0625	REC341280	341280	875	1375	REC321459	321459	0.6250	1.1250
REC313284	313284	0.6250	1.1250	REC3852548	3852548	1.3750	2.1875	REC321466	321466	0.7500	1.1250
REC341281	314281	1.25	1.6875	REC321831	321831	0.7500	1.2500	REC321467	321467	1.0000	1.3750
REC330327	330327	0.6250	1.1250	REC321895	321895	1.5625	1.9219	REC321480	321480	0.5000	1.2500
REC342786	332205	0.7500	1.2500	REC321928	321928	0.6250	1.3750	REC981195	981195	1.5000	2.1250
REC332261	332261	0.6250	1.3750	REC324639	324639	0.4375	0.9375	REC981196	981196	1.7500	2.5000
REC908855	908855	625	1000	REC327031	327031	0.4375	0.8750	REC981268	981268	1.6250	2.5000
REC353076	332942	1.5625	2.0625	REC329922	329922	0.8125	1.3750	REC321481	334950	1.2500	1.6875
REC339620	339620	1.6250	2.1250	REC329923	329923	0.8750	1.3750	REC342786	342786	0.7500	1.1875
REC911019	911019	1.0000	1.3750	REC330137	330137	1.1250	1.6250				



GUÍA RETENES

GEARCASE SEAL APPLICATION

GUIDA TENUTE PIEDE

GUIDE DES JOINTS

Reten	Año	EJE HÉLICE PROP SHAFT ASSE ELICA ARBRE D'HELICE		EJE COLA DRIVE SHAFT ASSE PIEDE ARBRE D'EMBASE	
		UN.	UN.	UN.	UN.
1.5, 2, 2.5, 3	1958-68		1	REC327031	1
1.5, 2	1968-90	REC327031	1	REC327031	1
2.5, 4	1973-80	REC327031	1	REC327031	2
2.5	1987	REC324639	2	REC327031	2
2.5, 4	1981-95		1	REC327031	2
3 Weedless	1958-68	REC327031	1		1
3, 4, 6 Weedless	1968-82	REC314167	1	REC314167	1
4	1981-90	REC324639	2		1
4	1984, 1986-95		1	REC324639	2
4.5, 7.5	1980-87		1	REC324639	1
5, 5.5, 6, 7.5	1957-64	REC303345	1	REC303345	1
5, 6, 8	1980-87		1	REC324639	2
6	1965-67		1	REC313282	1
6	1968-79	REC313282	1	REC314167	1
9.5	1964-73	REC303345	1	REC303345	1
9.9	1974-83	REC321481	1	REC321480	1
9.9	1984-95	REC321481	1	REC321480	1
10	1957-58	REC313284	1	REC321788	1
10	1959-63	REC303345	1	REC303345	1
10	1981	REC313282 (INNER)	1		1
10	1989	REC321787 REC321459 REC321787	1	REC330327 REC321459 REC330327	1
14	1988-90	REC321459 REC321481	1	REC321459 REC321480	1
15	1974-83	REC321481	2	REC321480	1
15	1984-95	REC321481	2	REC321480	1
18	1957	REC313284	1	REC321788	1
18	1958-73	REC313284	1	REC321788	1
20	1981-82	REC321787 REC321786	1	REC321786	1
20	1983	REC321787 REC321786	1	REC321459 REC321786	1
20	1984	REC318972 REC321459	1	REC330327 REC321786	1
20	1985-86	REC26-69188	1	REC321928	1
20	1987-95	REC26-69188	1	REC321928 REC332261	1
25	1969-76	REC313284	1	REC321788	1
25	1977-78	REC313284	1	REC321788	1
25	1979-82	REC321787 REC321786	1	REC321786	1
25	1983	REC321787 REC321786	1	REC321459 REC321786	1
25	1984	REC321787 REC321459	1	REC330327 REC321786	1
25	1985-86	REC26-69188	1	REC321928	2
25	1987-95	REC26-69188	1	REC330327 REC321786	1
25 C	1982	REC321786	1	REC321786	1
25 C	1983	REC321787 REC321459	1	REC321459 REC321786	1
25 C	1984-90	REC321787 REC321459	1	REC330327 REC321459	1
28	1962-64	REC302564	1	REC313284	1
28	1987-90	REC321787 REC321459	1	REC330327 REC321459	1
30	1984-86	REC26-69188	1	REC321928	1
30	1987-95	REC26-69188	1	REC321928 (INNER)	1
33	1965-76	REC302564	1	REC313284	1
35	1957-59	REC302564	1	REC313284	1
35	1976	REC26-69188	1	REC321459	2
35	1977-86	REC26-69188	2	REC321928	2
35	1987-90	REC26-69188	2	REC321928 (INNER)	1
40	1960-61	REC302564	1	REC313284	1
40	1962-73	REC302564	1	REC313284	1
40	1974-76	REC302564	1	REC321481	1
40 C	1981-86	REC302564	1	REC321481	2
40	1984-85	REC321467	2	REC321466 REC330327	2
40 (AR, AE, AT)	1988	REC330137	1	REC321459 REC342786 REC321459	1
40	1986-89	REC321467	2	REC330327 REC321459	1
45 C	1985	REC330137	2	REC330327 REC321459	1
45 C	1986	REC330137	2	REC342786 REC321459	1
45 C	1987	REC330137	2	REC330327 REC321459	1
45 C	1988-94	REC330137	2	REC330327 REC321459	1
45 C	1995	REC330137	2	REC342786 REC321466	1

Reten	Año	EJE HÉLICE PROP SHAFT ASSE ELICA ARBRE D'HELICE		EJE COLA DRIVE SHAFT ASSE PIEDE ARBRE D'EMBASE	
		UN.	UN.	UN.	UN.
48	1988-95	REC321467	2	REC342786 REC321466	1
50 (Manual)	1971-74	REC330137	2	REC321459	2
50	1975	REC321467	2	REC321466	1
50	1979	REC330137	2	REC321459	2
50	1980	REC321467	2	REC321466	1
50/60 (Pull Start)	1981-83	REC330137	2	REC321459	1
50/60 (Electric)	1981-83	REC321467	2	REC321466	1
50/60	1984-85	REC321467	2	REC321466	1
50/60 corto Small	1986-87	REC321467	2	REC342786	1
50/60 largo Large				REC321466	
50/60 Lungo Longue	1986-87	REC330137	2	REC342786 REC321466	1
50/60	1988-89	REC330137	2	REC342786 REC321466	1
50	1990-95	REC321467	2	REC342786 REC321466	1
55	1968-69	REC310599	2	REC321466	2
55	1976-77	REC321467	2	REC321466	2
55	1978	REC321466	1	REC321466	2
55	1979-83	REC330137	2	REC321459	1
55 (Electric)	1980-83	REC310599	2	REC321466 REC330327	2
55 C	1984	REC330137	2	REC321459	1
55 C	1985	REC330137	2	REC330327	1
55 C	1986	REC330137	2	REC342786 REC321466	1
55 C	1987-94	REC330137	2	REC330327 REC321466	1
55 C	1995	REC330137	2	REC342786 REC321895	1
60	1970	REC310599	1	REC321466	2
60 (3-Cyl.)	1971	REC330137	2	REC321466	2
60 (Pull Start)	1980-83	REC330137	2	REC321459	2
60 (Electric)	1980-83	REC330137	2	REC321466	2
60	1970	REC310599	1	REC321466	2
60 SST	1989	REC321467	2	REC342786 REC321466	1
60 SST	1990	REC321467	2	REC342786 REC321466	1
60 (3-Cyl.)	1987-95	REC330137	2	REC342786 REC321466	1
65 (3-Cyl.)	1972-73	REC330137	2	REC321466	2
65 C	1984-85	REC330137	2	REC321466	2
65 C	1986-89	REC330137	2	REC342786 REC321466	1
65 C	1974-85	REC330137	2	REC321466	2
70 (L)	1986-95	REC330137	2	REC342786 REC321466	1
70 (S)	1977-85	REC321467	2	REC321466	2
75 (L)	1975-84	REC330137	2	REC321466	2
75 (S)	1986-87	REC330137	2	REC342786 REC321466	1
75 (S)	1975-84	REC321467	2	REC321466	2
85	1969-70	REC310599	2	REC321466	2
85	1971-72	REC330137	2	REC321466	2
85	1973-80	REC330137	2	REC26-69188 REC329922	2
88	1987-94	REC330137	2	REC329922	1
90	1981-83	REC330137	2	REC26-69188 REC329922	2
90	1984-94	REC330137	2	REC329922	1
90 Seadrive	1985-90	REC330137	2	REC329922 REC329923	1
100	1971-72	REC330137	2	REC321466	2
100	1979-80	REC330137	2	REC26-69188	2
100 C	1984-90	REC26-76868	2	REC329922 REC329923	1
110	1986-88	REC330137	2	REC329922 REC329923	1
115	1969-70	REC310599	2	REC321466	2
115	1973-83	REC330137	2	REC26-69188 REC329922	2
115	1984-85	REC330137	2	REC329922	1
115	1990-94	REC330137	2	REC329922 REC329923	1
120	1985	REC26-76868	2	REC329922 REC329923	1
120	1986-88	REC330137	2	REC329922 REC329923	1
120	1989	REC26-76868	2	REC329922 REC329923	1
120	1990-94	REC330137	2	REC329922 REC329923	1
125	1971-72	REC330137	2	REC321466	2

EJE HÉLICE PROP SHAFT ASSE ELICA ARBRE D'HELICE	UN.	EJE COLA DRIVE SHAFT ASSE PIEDE ARBRE D'EMBASE	UN.		
				UN.	
125 C	1989	REC26-76868	2	REC329922	1
125 C (ESX)	1989	REC330137	2	REC329923	1
135	1973-76	REC330137	2	REC26-69188	2
140	1977-83	REC330137	2	REC26-69188	2
140	1984	REC330137	2	REC26-69188	2
140	1985	REC26-76868	2	REC329922	1
140	1986-94	REC330137	2	REC329922	1
140 TX	1989	REC26-76868	1	REC329923	1
150	1978-83	REC26-76868	2	REC26-69188	2
150	1984	REC26-76868	2	REC329922	1
155 C	1984-85	REC26-76868	2	REC329923	1
155 C	1986-90	REC26-76868	2	REC329922	1
175	1977-85	REC26-76868	2	REC26-69188	2
175	1986-90	REC26-76868	2	REC329922	1

EJE HÉLICE PROP SHAFT ASSE ELICA ARBRE D'HELICE	UN.	EJE COLA DRIVE SHAFT ASSE PIEDE ARBRE D'EMBASE	UN.		
				UN.	
185	1984-85	REC26-43035	2	REC329922	1
185	1990	REC26-76868	2	REC329923	1
200	1976-83	REC26-76868	2	REC26-69188	2
200	1984-85	REC26-76868	2	REC329922	1
200, 225	1986-90	REC26-76868	2	REC329923	1
235	1978-83	REC26-76868	2	REC26-69188	2
235	1984-85	REC26-76868	2	REC329922	1
275	1985-88	REC26-76868	2	REC329923	1
3.6L, 300	1985-90	REC26-76868	2	REC329922	1

BOMBA DE AGUA

WATER PUMP

POMPA ACQUA



POMPE À EAU

CUERPO BOMBA DE AGUA HOUSING, WATER PUMP

CORPO, POMPA ACQUA

CORPS DE POMPE À EAU

REF	OEM	EJE HÉLICE PROP SHAFT ASSE ELICA ARBRE D'HELICE	2T STROKES	4T STROKES
REC17411-93901	5033107	J10 / J15 (2002-06)		✓





REF	OEM	EJE HÉLICE PROP SHAFT ASSE ELICA ARBRE D'HELICE	2T STROKES	4T STROKES
REC330560	330560	18, 25, 28 HP	✓	

Escape a través de aleta de cavitación.
w/ Thru-Cavitation Plate Exhaust.
Scarico tramite aletta di cavitazione.
Échappement par la plaque de cavitación.



REF	OEM	EJE HÉLICE PROP SHAFT ASSE ELICA ARBRE D'HELICE	2T STROKES	4T STROKES
REC17411-94421	5031990	E25 / E30 J25 / J30 (2002-07)		✓



REF	OEM	EJE HÉLICE PROP SHAFT ASSE ELICA ARBRE D'HELICE	2T STROKES	4T STROKES
REC390613	390613	40 HP 2 Cyl. Crossflow	✓	



REF	OEM	EJE HÉLICE PROP SHAFT ASSE ELICA ARBRE D'HELICE	2T STROKES	4T STROKES
REC389577	389577	4 - 8 HP	✓	✓



REF	OEM	EJE HÉLICE PROP SHAFT ASSE ELICA ARBRE D'HELICE	2T STROKES	4T STROKES
REC438544	3438544	2 Cyl. Loopcharged	✓	



REF	OEM	STROKES	2T	4T
REC435390	435390	8, 9,9, 15 HP	✓	✓



REF	OEM	STROKES	2T	4T
REC384087	384087	2 Cyl. Loopcharged	✓	



REF	OEM	STROKES	2T	4T
REC393632	393632	20, 25, 35 HP	✓	

Con casquillo de bronce. Escape a través de la hélice.
 W/ brass bushing. w/ Thru-Prop Exhaust.
 Con ghiera in bronzo. Scarico tramite l'elica.
 Avec insert en bronze. Echappement par hélice.



REF	OEM	STROKES	2T	4T
REC438543	438543	2 Cyl. Loopcharged 3 Cyl.	✓	



REF	OEM	STROKES	2T	4T
REC435990	435990	2V4, V6 Et V8	✓	

Con agujero spary
 W/ spray hole
 Con foro
 Avec trou



REF	OEM	STROKES	2T	4T
REC5007968	435959	V4, V6 Et V8	✓	



JUNTA BASE DE BOMBA WATER PUMP, GASKET BASE

REF	OEM	STROKES	2T	4T
REC17472-97J00	5037432	JZR4	✓	



new

GUARNIZIONE BASE POMPA JOINT DE BASE DE POMPE A EAU

REF	OEM	STROKES	2T	4T
REC17472-87E10	5030725	J/BJ 90, 115, 140 HP	✓	

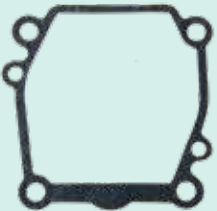

new

REF	OEM	STROKES	2T	4T
REC17472-96303	5036681 5031419	BJ J25, 30 J/BJ 40-50 HP	✓	





new

CASQUILLO **SLINGER** **BOCCOLA** **INSERT**

REF	OEM		2T STROKES	4T STROKES
REC56130-94413-OEP	5032802	J/BJ 40, 50 HP		✓





REF	OEM		2T STROKES	4T STROKES
REC325397	325397	40 HP 2 Cyl. Crossflow	✓	





REF	OEM		2T STROKES	4T STROKES
REC324641	324641	4-8 HP	✓	✓





REF	OEM		2T STROKES	4T STROKES
REC340619	340619	2 Cyl. Loopcharged 3 Cyl.	✓	



REF	OEM		2T STROKES	4T STROKES
REC324097	324097	8, 9.9, 15 HP	✓	✓





REF	OEM		2T STROKES	4T STROKES
REC320775	320775 + 320776	2 Cyl. Loopcharged	✓	



REF	OEM		2T STROKES	4T STROKES
REC328751	328751	18-35 HP 2 Cyl. Crossflow 3 Cyl.	✓	



REF	OEM		2T STROKES	4T STROKES
REC338486	338486	V4, V6 & V8	✓	



REF	OEM		2T STROKES	4T STROKES
REC17413-95J00	5036900	J/BJ 25 HP		✓



new

REF	OEM		2T STROKES	4T STROKES
REC17413-92J01	50367173	J/BJ 90, 115, 140 HP		✓



new

CIRCLIP, BOMBA DE AGUA **CLIP** **CLIP** **CLIPS**

REF	OEM	
REC09380-15001	5033027	J10, 15 HP



new

JUNTA TÓRICA
BOMBA DE AGUA

WATER PUMP, O-RING

GUARNIZIONE

JOINT TORIQUE DE POMPE
À EAU

REF	OEM		2T STROKES	4T STROKES	new
REC17417-92J00	5037175	J/BJ 90, 115, 140 HP		✓	



REF	OEM		2T STROKES	4T STROKES	new
REC17416-95J00	5036901	J/BJ 25		✓	



REF	OEM		2T STROKES	4T STROKES	new
REC17416-93J00	5035039	J/BJ 200, 225 HP		✓	



TAPA IMPULSOR

IMPELLER PLATE

PIASTRA GIRANTE

PLAQUE DE TURBINE

REF	OEM		2T STROKES	4T STROKES	new
REC17471-97J00	5037431	J2 HP		✓	



REF	OEM		2T STROKES	4T STROKES	new
REC17471-94401	5031418	E25, E30, E40 J25, J30, J40, J50 BJ40, BJ50 (1999-07)		✓	



REF	OEM		2T STROKES	4T STROKES	new
REC17471-98601	5031196 5030189 5031196	J5 HP		✓	



REF	OEM		2T STROKES	4T STROKES	new
REC17471-92J00	5034651 5037170 5030724 5037170	J/BJ 140, 90, 115		✓	



REF	OEM		2T STROKES	4T STROKES	new
REC17471-93902	5033114	J10 / J15 (2002-07)		✓	



REF	OEM		2T STROKES	4T STROKES	new
REC17471-92J02	5035041	J/BJ 225, 200 HP		✓	



REF	OEM		2T STROKES	4T STROKES	new
REC17471-95J01	5036902	J/BJ 25 HP		✓	





JUNTAS BOMBA

WATER PUMP GASKETS

GUARNIZIONI POMPA

JOINTS DE POMPE

REF	OEM		2T STROKES	4T STROKES
REC17472-98611	5030190	E5 / J5 (1998)	✓	





REF	OEM		2T STROKES	4T STROKES
REC17472-91J00	5033381	J14 / J5 / J6 (2003-07)		✓





REF	OEM		2T STROKES	4T STROKES
REC17472-93911	5035603	J10 / J15 (2004-07)		✓





REF	OEM		2T STROKES	4T STROKES
REC55122-94400	5031535	J40 / E40 / BJ40 J50 / E50 / BJ50 (1999-06)		✓



REF	OEM		2T STROKES	4T STROKES
REC17452-93910	5033110	J10 / J15 (2002-07)		✓



REF	OEM		2T STROKES	4T STROKES
REC17472-93J00	5035042	J200 / J225 BJ200 / BJ225 (2004-06)		✓





KITS DE REPARACIÓN BOMBA DE AGUA

WATER PUMP SERVICE KITS

KIT RICAMBI POMPA ACQUA

KIT REPARATION DE POMPE À EAU

REF	OEM		2T STROKES	4T STROKES
REC12065		4, 4.5, 5, 6, 7.5 Et 8 HP (1980+)	✓	✓



REF	OEM		2T STROKES	4T STROKES
REC17400-98652	5030352	E4 / E5 J4 / J5 (1998-04)	✓	✓



REF	OEM		2T STROKES	4T STROKES
REC17400-98661	5034323	J4 / J5 / J6 (2005-07)		✓



REF	OEM		2T STROKES	4T STROKES
REC394711	394711	9.9, 15 HP (1974+) (1994+)	✓	✓



REF	OEM		2T STROKES	4T STROKES
REC17400-93951	5033106	J10 / J15 (2002-06)		✓

REF	OEM		2T STROKES	4T STROKES
REC17400-94J00	5037545	J10, 15 HP		✓

new

REF	OEM		2T STROKES	4T STROKES
REC395270	395270	18, 25 Et 28 HP 2-Cyl. (1979-98)		✓

Crossflow con escape a través de la hélice y cola de una pieza
 Crossflow with thru-prop exhaust and one-piece gearcase.
 Crossflow con scarico dall'elica e piede in 1 pezzo.
 Crossflow avec échappement par l'hélice. carter 1 partie

REF	OEM		2T STROKES	4T STROKES
REC393630	393630	20-35 HP 2 Cyl. (1980-05)		✓

Crossflow con escape a través de la hélice y cola de una pieza
 Crossflow with thru-prop exhaust and one-piece gearcase.
 Crossflow con scarico dall'elica e piede in 1 pezzo.
 Crossflow avec échappement par l'hélice. carter 1 partie

REF	OEM		2T STROKES	4T STROKES
REC17400-95J02	5036908	J/BJ 25 HP		✓

new

REF	OEM		2T STROKES	4T STROKES
REC437907	437909	25, 30 Et 35 HP 3-Cyl. (1996-01) Loopcharged		✓

REF	OEM		2T STROKES	4T STROKES
REC391741	391741	40 HP 2 Cyl. (1974-76) Crossflow 40 Comm. 2 Cyl. (1981-87)		✓

Crossflow con escape a través de la aleta de cavitación. Cola de dos piezas.
 Crossflow thru-cavitation plate exhaust and two-piece gearcase.
 Crossflow scarico attraverso l'aletta di cavitazione.
 Crossflow avec échappement par la plaque de cavitation. Carter en 2 parties

REF	OEM		2T STROKES	4T STROKES
REC438602	438602	Cola larga / large gearcase / Piede lungo 40-60 HP 2-Cyl. (1979-05) Loopcharged 65, 70 Et 75 HP 3-Cyl. (1979-85) Loopcharged		✓

Bomba agua con chaveta impulsor de plástico.
 Large water pump with the plastic wedge key impeller.
 Piede a gambo lungo. Pompa acqua con chiave girante in plastica.
 Pompe à eau avec clavette de turbine en plastique

REF	OEM		2T STROKES	4T STROKES
REC5000308	5000308	40, 45 Et 55 HP (1995-05) 40, 50 Et 60 HP 2-Cyl.		✓

Loopcharged cola larga. Bomba de agua grande con impulsor de seis palas.
 Loopcharged large gearcase. Large water pump with the six vane impeller.
 Loopcharged piede con gambo lungo. Pompa acqua grande con girante a sei pale.
 Loopcharged embase large. Grande pompe à eau avec turbine 6 pales

REF	OEM		2T STROKES	4T STROKES
REC438592	438592	40, 45, 48 Et 50 HP 2-Cyl. (1989-05)	✓	

Loopcharged cola corta. Bomba de agua grande con impulsor tres palas.
 Loopcharged small gearcase. Large water pump with the three vane impeller.
 Loopcharged piede con gambo corto. Pompa acqua grande con girante a tre pale.
 Loopcharged embase courte. Pome à eau avec turbine 3 pales





REF	OEM		2T STROKES	4T STROKES
REC17400-87E04	5031731	E70 (1999-00)		✓



REF	OEM		2T STROKES	4T STROKES
REC17400-92J00	5037176	J/BJ 90, 115, 140 HP		✓

new



REF	OEM		2T STROKES	4T STROKES
REC17400-96403	5031744	E40 / J40 E50 / J50 (2000-02)		✓



REF	OEM		2T STROKES	4T STROKES
REC17400-90J20	5033541	J90 / J115 / J140 BJ90 / BJ118 / BJ140 (2003-06)		✓



REF	OEM		2T STROKES	4T STROKES
REC432955	432955	65, 70 Et 75 HP 3 Cyl. (1986-01)	✓	

Loopcharged con cola larga. Bomba de agua grande con chaveta de impulsor de plástico.
 Loopcharged large gearcase. Large water pump with plastic wedge key impeller.
 Loopcharged piede a gambo lungo. Pompa acqua grande conchiave girante in plastica.
 Loopcharged embase longue. Pompe à eau avec clavette en plastique



REF	OEM		2T STROKES	4T STROKES
REC17400-93J01	5035036	J200 / J225 BJ200 / BJ225 (2004-06)		✓



REF	OEM		2T STROKES	4T STROKES
REC438579	438579	70 Et 75 HP 3-Cyl. (1974-78) Loopcharged	✓	

Cola larga. Bomba de agua grande con chaveta impulsor de media luna.
 Large gearcase. Large water pump with half-moon key impeller.
 Piede a gambo lungo. Pompa acqua grande, con calettatura girante a mezza luna.
 Embase longue. Pompe à eau avec clavette demi lune



REF	OEM		2T STROKES	4T STROKES
REC389133	389133	2 Cyl. (1971-78) 3 Cyl. Loopcharged	✓	

Loopcharged cola corta. Bomba de agua pequeña
 Loopcharged small gearcase. Small water pump
 Loopcharged piede con gambo corto. Pompa acqua piccola.
 Loopcharged embase courte. Petite pompe à eau.



REF	OEM		2T STROKES	4T STROKES
REC439077	439077	2 Cyl. (1984-94) 3 Cyl. Loopcharged		✓

Loopcharged cola corta. Bomba de agua pequeña casquillo impulsor de plástico
 Loopcharged small gearcase. Small water pump with plastic wedge key impeller.
 Loopcharged piede con gambo lungo. Pompa acqua grande con girante a sei pale.
 Loopcharged embase courte. Grande pompe à eau avec turbine 6 pales.



REF	OEM		2T STROKES	4T STROKES
REC5001594	5001594	V4/V6/V8		✓

V4/V6/V8 con eje 20" (1979-06) Chaveta impulsor de plástico
 V4/V6/V8 with 20" shaft (1979-06) Plastic wedge key impeller.
 V4/V6/V8 con asse da 20" (1979-06) Chiave girante in plastica.
 V4/V6/V8 avec arbre de 20" (1979-06) Clavette turbine en plastique.



REF	OEM		2T STROKES	4T STROKES
REC395073	0395073	(1977-78) V4 (1976-78) V6		✓

V4 con cambio mecánico/hidráulico.
 V6 con cambio mecánico/hidráulico. Chaveta impulsor de media luna.
 V4 with mech./hydraulic shift.
 V6 with mech./hydraulic shift. Half-moon key impeller.
 V4 con cambio meccanico/idraulico.
 V6 con cambio meccanico/idraulico. Calattatura girante a mezza luna
 V4 avec changement mecanique/hydraulique.
 V6 avec changement mecanique/hydraulique. Clavette de turbine demie lune.



REF	OEM		2T STROKES	4T STROKES
REC5001595	5001595	V4/V6/V8 (1979-06)		✓

Con ejes de 25 y 30". Es el mismo kit que el REC5001594 pero con un agujero en el cuerpo de la bomba para refrigeración extra. Chaveta impulsor de plástico.
 With 25" and 30" shaft. Same water pump kit as REC5001594 except with a spray hole in pump housing for extra cooling of the long shaft exhaust housings. Plastic wedge key impeller.
 Con asse da 25 e 30" Il kit è identico al REC5001594, l'unica differenza è un foro nel corpo pompa che permette una refrigerazione extra.
 Avec arbre de 25" et 30". C'est le même kit que REC5001594 mais avec un trou dans le cors de la pompe pour une refroidissement extra. Clavette turbine en plastique.



REF		2T STROKES	4T STROKES	REF	OEM					
REC12104		✓		REC5001593	435821	IMPULSOR	IMPELLER	GIRANTE	TURBINE	X 1
				REC331107	331107	CHAVETA	KEY	CHIAVE	CLAVETTE	X 1
				REC338486	338486	TAPA BOMBA	PUMP CUP	COPERCHIO POMPA	COUVERCLE POMPE	X 1
				REC338485	338485	TAPA	WATER PLATE	COPERCHIO	PLAQUE	X 1
				REC338484	338484	JUNTA	GASKET	GUARNIZIONE	JOINT	X 1
				REC25-30613	310585	TÓRICA	O-RING	O-RING	JOINT TORIQUE	X 1
				REC331353	331353	RETÉN	SEAL	TENUTA	JOINT SPI	X 1
				REC320943	320943	GRUESO	GROMMET	SPESSORE	CALE	X 1
				REC314008	314008	GRUESO TUBO	TUBE GROMMET	SPESSORE TUBO	CALE DE TUYAU	X 1
				REC338893	338893	TAPA	COVER	COPERCHIO	COUVERCLE	X 1
				REC306643	306643	TORNILLO	SCREW	VITE	VIS	X 2
				REC302325	302325	TORNILLO	SCREW	VITE	VIS	X 4
				REC332583	332584	TÓRICA	O-RING	O-RING	JOINT TORIQUE	X 1
				REC321008	321008	GRUESO CAMBIO	SHIFT GROMMET	SPESSORE CAMBIO	CALE	X 1











**GUÍA
BOMBAS DE AGUA**

WATER PUMP GUIDE

**GUIDA
POMPA ACQUA**

**GUIDE
POMPE À EAU**

	2T STROKES	4T STROKES	CUERPO HOUSING CORPO CORPS	EJE SHAFT ASSE ARBRE					KIT	KIT COMPLETO FULL KIT KIT COMPLETO KIT COMPLET	
1.5 HP - 15 HP											
1.5					1968-70	REC763735					
2					1971-88	REC763735					
2.5						REC0767407					
3					1952-68	REC434424				REC12108	
3						REC0767407					
3,4					1991-96			REC324641			
4					1969-72	REC434424				REC12108	
4 (90)					1973-80	REC763735					
4 (110)					1973-82	REC434424				REC12108	
4 (90)					1981-90	REC389576		REC324641			
4 Deluxe					1985-88	REC389576	REC324640	REC324641	REC389577	REC396644	REC12065
4 Deluxe					1989-96	REC0767407	REC324640	REC324641			
4.5					1980-84	REC389576	REC324640	REC324641	REC389577	REC396644	REC12065
5					1965-68	REC434424				REC12108	
5					1986-90	REC389576	REC324640	REC324641	REC389577	REC396644	REC12065
5		✓			-1998	REC389576	REC324640	REC324641	REC389577	REC396644	REC12065
5.5					1956-64	REC434424					
6					1965-79	REC434424					
6					1984-96	REC389576	REC324640	REC324641	REC389577	REC396644	REC12065
6		✓			-1998	REC389576	REC324640	REC324641	REC389577	REC396644	REC12065
7.5					1954-58	REC389576				REC12108	
7.5					1980-83	REC389576	REC324640	REC324641	REC389577	REC396644	REC12065
8					1984-96	REC389576	REC324640	REC324641	REC389577	REC396644	REC12065
8		✓			-1995	REC386084	REC318995	REC324097	REC435390	REC394711	
9.9	✓				1974-96	REC386084	REC318995	REC324097	REC435390	REC394711	
9.9		✓			1995-01	REC386084	REC318995	REC324097	REC435390	REC394711	
10					1956-63	REC775518					
15					1953-56	REC775518					
15	✓				1974-96	REC386084	REC318995	REC324097	REC435390	REC394711	
15		✓			1995-01	REC386084	REC318995	REC324097	REC435390	REC394711	
18 - 40 HP 2 Cyl. Crossflow											
18					1957-73	REC775518					
18					1997-98	REC395289	REC765642	REC328751	REC330560	REC395270	
20					1966-67	REC775518					
20											
a través de hélice Thru-Prop attraverso elica per Hélice					1985-98	REC395289	REC328755	REC328751	REC393632	REC393630	
25					1969-78	REC775518					
25					1969-78	REC775518					
25					1979-05	REC395289	REC765642	REC328751	REC330560	REC395270	
25											
a través de hélice Thru-Prop attraverso elica per Hélice					1985-05	REC395289	REC765642	REC328751	REC393632	REC393630	
28					1986-98	REC395289	REC765642	REC328751	REC330560	REC395270	
35											
con term w. Therm Con Term avec thermostat					1958-59	REC777213					
35											
a través de hélice Thru-Prop attraverso elica per Hélice					1980-96	REC395289	REC328755	REC328751	REC393632	REC393630	
40					1960-70	REC777213					
40					1974-76	CEF500353		REC325397	REC390613	REC391741	
40					1981-87	CEF500353		REC325397	REC390613	REC391741	
40 - 60 HP 2 Cyl. Loopcharged											
40			S		1984-88	REC777214	REC320981	REC320775	REC384087	REC439077	
40			S		1989-98	REC432941	REC341038	REC340619	REC438544	REC438592	
40 Comm.			S		1993-94	REC777214	REC320981	REC340619	REC438544	REC439077	
40			L		1995-05	REC396725	REC341038	REC340619		REC5000308	
45 Comm.			S		1986-94	REC777214	REC320981	REC320775	REC384087	REC439077	
45 Comm.			L		1995-05	REC396725	REC341038	REC340619		REC5000308	
48			S		1987-88	REC777214	REC320981	REC320775	REC384087	REC439077	
48			S		1989-98	REC432941	REC341038	REC340619	REC438544	REC438592	
50			S		1971-78	REC777213	REC320981	REC320775	REC384087	REC389133	
50			S		1979-85	REC777129	REC320981	REC320775	REC384087		
50			S		1986-88	REC777214	REC320981	REC320775	REC384087	REC439077	
50			S		1989-98	REC432941	REC341038	REC340619	REC438544	REC438592	
55 Comm.			S		1986-94	REC777214	REC320981	REC320775	REC384087	REC439077	
55			L		1995-05	REC396725	REC341038	REC340619		REC5000308	
60			S		1980-85	REC777129	REC320981	REC320775	REC384087		
60			L		1986-88	REC396725	REC341038	REC340619	REC438543	REC438602	

	2T STROKES	4T STROKES	CUERPO HOUSING CORPO CORPS	EJE SHAFT ASSE ARBRE					KIT	KIT COMPLETO FULL KIT KIT COMPLETO KIT COMPLET
3 Cyl.										
25, 35										REC437907
55										
60										
60										
60		✓			REC341038	REC340619	REC438543			REC432955
60		✓			REC341038	REC340619	REC438543			REC432955
65										
65					REC396725	REC341038	REC340619	REC438543		REC432955
70					REC765431	REC341038	REC340619	REC438543		REC438579
70					REC396725	REC341038	REC340619	REC438543		REC432955
70		✓			REC396725	REC341038	REC340619	REC438543		REC432955
75					REC765431	REC341038	REC340619	REC438543		REC438579
75					REC396725	REC341038	REC340619	REC438543		REC432955
V4										
85					REC385072					
85					REC777212					
85			25"		REC777212	REC338485	REC338486	REC435990		REC395073
85					REC777212	REC338485	REC338486	REC435990		REC395073
85					REC5001593	REC338485	REC338486	REC435990	REC12104	REC5001594
90					REC5001593	REC338485	REC338486	REC435990	REC12104	REC5001594
90			20"		REC5001593	REC338485	REC338486	REC435990	REC12104	REC5001594
90			25"		REC5001593	REC338485	REC338486	REC5007968	REC12104	REC5001595
100					REC385072					
100					REC5001593	REC338485	REC338486	REC435990		REC395073
100					REC5001593	REC338485	REC338486	REC435990	REC12104	REC5001594
100			20"		REC5001593	REC338485	REC338486	REC435990	REC12104	REC5001594
100			25"		REC5001593	REC338485	REC338486	REC5007968	REC12104	REC5001595
105					REC5001593	REC338485	REC338486	REC5007968	REC12104	REC5001595
115					REC777212					
115			25"		REC777212	REC338485	REC338486	REC435990		REC395073
115					REC777212	REC338485	REC338486	REC435990		REC395073
115					REC5001593	REC338485	REC338486	REC435990	REC12104	REC5001594
115			20"		REC5001593	REC338485	REC338486	REC435990	REC12104	REC5001594
115			25"		REC5001593	REC338485	REC338486	REC5007968	REC12104	REC5001595
120					REC5001593	REC338485	REC338486	REC435990	REC12104	REC5001594
120			25"		REC5001593	REC338485	REC338486	REC5007968	REC12104	REC5001595
125					REC385072					
130					REC5001593	REC338485	REC338486	REC435990	REC12104	REC5001594
130			25"		REC5001593	REC338485	REC338486	REC5007968	REC12104	REC5001595
135					REC777212					
135			20"		REC5001593	REC338485	REC338486	REC435990	REC12104	REC5001594
135			25"		REC5001593	REC338485	REC338486	REC5007968	REC12104	REC5001595
140					REC777212	REC338485	REC338486	REC435990		REC395073
140					REC5001593	REC338485	REC338486	REC435990	REC12104	REC5001594
140			20"		REC5001593	REC338485	REC338486	REC435990	REC12104	REC5001594
140			25"		REC5001593	REC338485	REC338486	REC5007968	REC12104	REC5001595
V6										
150					REC777212	REC338485	REC338486	REC435990		REC395073
150					REC5001593	REC338485	REC338486	REC435990	REC12104	REC5001594
150			20"		REC5001593	REC338485	REC338486	REC435990	REC12104	REC5001594
150			25"		REC5001593	REC338485	REC338486	REC5007968	REC12104	REC5001595
175					REC777212	REC338485	REC338486	REC435990		REC395073
175					REC5001593	REC338485	REC338486	REC435990	REC12104	REC5001594
175			20"		REC5001593	REC338485	REC338486	REC435990	REC12104	REC5001594
175			25"		REC5001593	REC338485	REC338486	REC5007968	REC12104	REC5001595
185					REC5001593	REC338485	REC338486	REC435990	REC12104	REC5001594
185			20"		REC5001593	REC338485	REC338486	REC435990	REC12104	REC5001594
185			25"		REC5001593	REC338485	REC338486	REC5007968	REC12104	REC5001595
200					REC777212	REC338485	REC338486	REC435990		REC395073
200					REC5001593	REC338485	REC338486	REC435990	REC12104	REC5001594
200			20"		REC5001593	REC338485	REC338486	REC435990	REC12104	REC5001594
200			25" 30"		REC5001593	REC338485	REC338486	REC5007968	REC12104	REC5001595
225					REC5001593	REC338485	REC338486	REC435990	REC12104	REC5001594
225			20"		REC5001593	REC338485	REC338486	REC435990	REC12104	REC5001594
225			25" 30"		REC5001593	REC338485	REC338486	REC5007968	REC12104	REC5001595
235					REC777212	REC338485	REC338486	REC435990		REC395073
235					REC5001593	REC338485	REC338486	REC435990	REC12104	REC5001594
250			20"		REC5001593	REC338485	REC338486	REC435990	REC12104	REC5001594
250			25" 30"		REC5001593	REC338485	REC338486	REC5007968	REC12104	REC5001595
V8										
250					REC5001593	REC338485	REC338486	REC435990	REC12104	REC5001594
250			20"		REC5001593	REC338485	REC338486	REC435990	REC12104	REC5001594
250			25" 30"		REC5001593	REC338485	REC338486	REC5007968	REC12104	REC5001595
275					REC5001593	REC338485	REC338486	REC435990	REC12104	REC5001594
300					REC5001593	REC338485	REC338486	REC435990	REC12104	REC5001594
300			20"		REC5001593	REC338485	REC338486	REC435990	REC12104	REC5001594
300			25" 30"		REC5001593	REC338485	REC338486	REC5007968	REC12104	REC5001595

TUBOS DE AGUA DE CULATA

HOSE WATER CYLINDER HEAD

KIT TUBI ACQUA TESTATA

TUYAU D'EAU DE CULASSE

REF	OEM		ESTRIBOR STARBOARD TRIBORDO DROITE	BABOR PORT BABORDO GAUCHE
REC0340975	340975	90 (1994-95)	✓	
		100 (1996-97)		
		115 (1994-97)		
		E88 (1996)		
		E90 (1996-98)		
REC0340976	340976	E100 (1996-97)		✓
		E112 (1996)		
		E115 (1996-98)		
		J88 (1996)		
		J90 (1996-98)		
		J100 (1997-98)		
		J112 (1996)		
J115 (1996-98)				



REC0340975

REC0340976

CANADA METAL





ÁNODO

ANODE

ANODI

ANODE

ZN		AL		OEM
CM123009	0,09	CM123009A	0,03	123009 173029





ZN		AL		OEM
CM392462	0,65	CM392462A	0,25	392462





ZN		AL		OEM
CM327606	0,08	CM327606A	0,03	327606



ZN		AL		OEM
CM393023	0,22	CM393023A	0,09	393023



ZN		AL		OEM
CM334451	0,09	CM334451A	0,03	334451 432397





ZN		AL		OEM
CM433458	0,33	CM398331A	0,33	433458 398331





ZN		AL		OEM
CM976669	0,43	CM976669A	0,17	976669





ZN		AL		OEM
CM398873	0,15	CM398873A	0,06	398873





ZN		AL		OEM
CM389999	0,23	CM389999A	0,09	389999



ZN		AL		OEM
CM431708	0,27	CM431708A	0,10	431708



ZN		OEM	
CM338635	0,06	338635	9,9 HP 15 CV



ZN	KG (kg)	AL	KG (kg)	OEM
CM392123	0,76	CM392123A	0,29	392123



ZN	KG (kg)	OEM
CM5031705	0,02	5031705



ZN	KG (kg)	AL	KG (kg)	OEM
CM397768	0,31	CM397768A	0,12	397768



ZN	KG (kg)	AL	KG (kg)	OEM
CM5007089	0,72	CM5007089A	0,28	433580



ZN	KG (kg)	AL	KG (kg)	OEM
CM980756	0,96	CM980756A	0,37	980756



ZN	KG (kg)	OEM	HP
CM55321-93900	0,06	5033185	9,9 - 15 HP



ZN	KG (kg)	OEM
CM55321-87J00	0,02	5031705



ZN	KG (kg)	OEM	HP
CM5033167	0,05	5033167	9,9 - 15 HP



ZN	KG (kg)	AL	KG (kg)	OEM
CM984547	1,10	CM984547A	0,43	983952



ZN	KG (kg)	OEM	HP
CM5032930	0,09	5032930	90 - 115 HP



ZN	KG (kg)	OEM	HP
CM55320-98600	0,10	5030267	5 HP



ZN	KG (kg)	OEM	HP
CM5031538	0,08	5031538	2 - 8 HP



ZN	KG (kg)	OEM	HP
CM434029	0,19	434029	20 - 25 HP



ZN	KG (kg)	OEM	2T STROKES	4T STROKES
CM55125-95500	0,16	5031536	70 HP	✓



ZN	KG (kg)	OEM	60, 70, 90, 115, 140 HP (2002-06)
CM5032929	0,25	5032929	



OMC

ZN	KG (kg)	AL	KG (kg)	OEM
CM983494	0,82	CM983494A	0,32	983494



ZN	KG (kg)	OEM
CM338742	0,40	338742



ZN	KG (kg)	AL	KG (kg)	OEM
CM984513	0,97	CM984513A	0,38	984513



ZN	KG (kg)	OEM	100 -245 HP
CM982438	0,85	982277 982438	



ZN	KG (kg)	AL	KG (kg)	OEM
CM984547	0,91	CM984547A	0,35	984547



KITS

AL	KG (kg)	
CMOMCV4V6KITA	0,55	OMC V4-V6
CMOMC5075KITA	0,52	OMC 50-75 HP



ÁNODO

ANODE

ANODI

ANODE

JOHNSON EVINRUDE

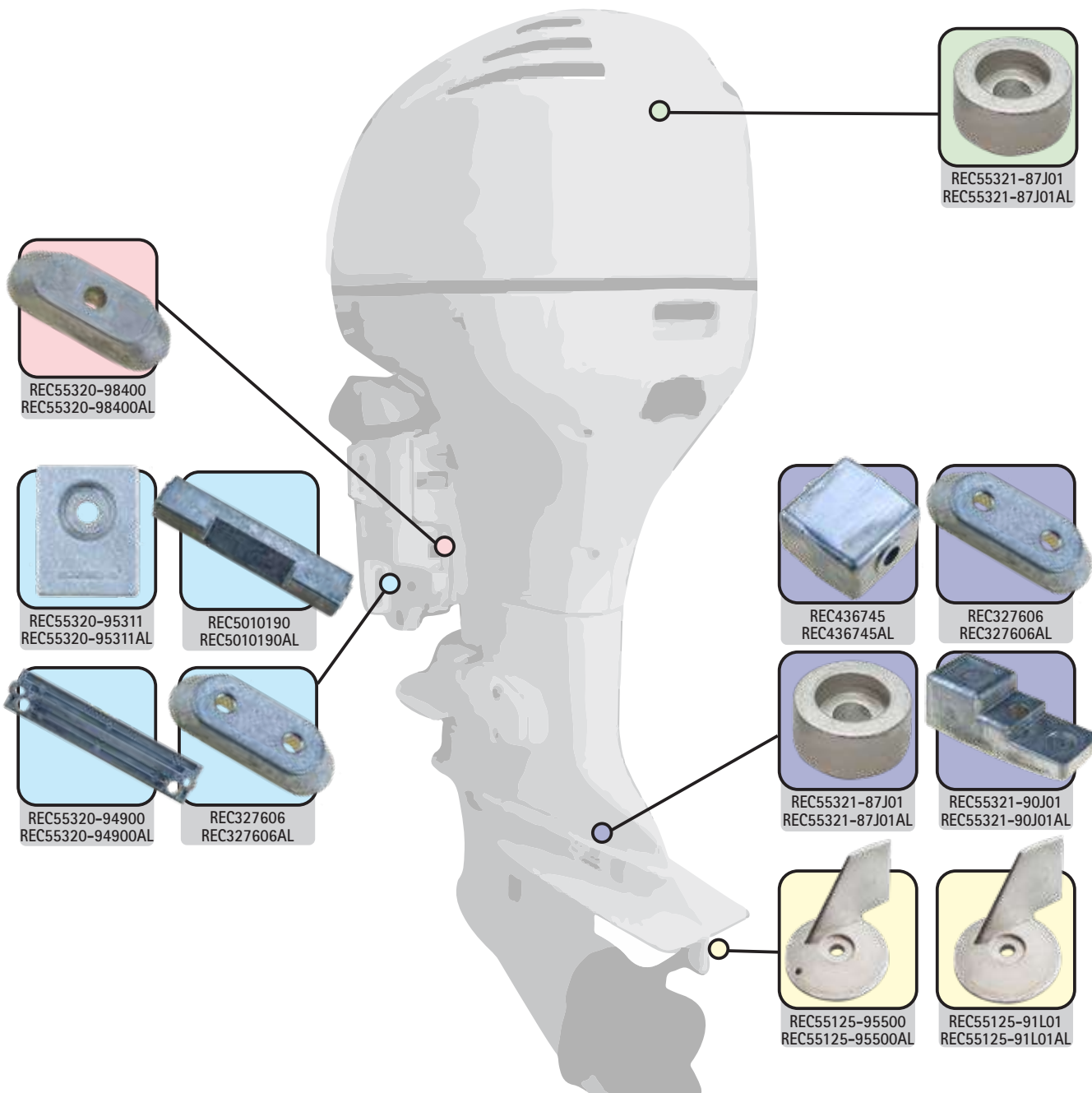

	MOTOR ENGINE MOTORE MOTEUR	SOPORTE BRACKET SUPPORTO SUPPORT	TRIM	COLA GEAR CASE PIEDE EMBASE	TRIM TAB
40HP +				REC436745 REC436745AL	
60 To 300HP (V4 & V6)		REC5010190 REC5010190AL			
1.2 TO 175HP		REC327606 REC327606AL		REC327606 REC327606AL	
40/50/70HP					REC55125-95500 REC55125-95500AL
5HP			REC55320-98400 REC55320-98400AL		
5 TO 225HP		REC55320-95311 REC55320-95311AL			
4/5/6HP				REC55321-87J01 REC55321-87J01AL	
40 TO 250HP	REC55321-87J01 REC55321-87J01AL				
60 TO 225HP		REC55320-94900 REC55320-94900AL			
25/30HP					REC55125-91L01 REC55125-91L01AL
60/70/90/115HP				REC55321-90J01 REC55321-90J01AL	

ÁNODO

ANODE

ANODI

ANODE

ZN	KG (kg)	OEM	
TEN00920	0,72	987067	OMC 5700



ZN	KG (kg)	OEM	
TEN00929	0,19	389999	OMC Sail Drive



ZN	KG (kg)	OEM	
TEN00900	0,47	976669	OMC P



ZN	KG (kg)	OEM	
TEN00906	0,73	983494	OMC



ZN	KG (kg)	OEM	
TEN00901	0,58	982277	OMC M 100 - 245 HP



ZN	KG (kg)	OEM	
TEN00919	0,61	986158 3853930	OMC Cobra



ZN	KG (kg)	OEM	
TEN00902	0,97	385818 982438	OMC G 100 - 245 HP



ZN	KG (kg)	OEM	
TEN00920	0,98	3854061 987067	OMC Cobra 5700



ZN	KG (kg)	OEM	
TEN00903	0,98	3853818 984513	OMC COBRA



ZN	KG (kg)	OEM	
TEN00922	1,00	3854130	OMC King Cobra



ZN	KG (kg)	OEM	
TEN00904	1,29	983952	OMC COBRA 130 - 185 HP



ZN	KG (kg)	OEM	
TEN00916	0,80	984547	OMC



ZN	KG (kg)	OEM	
TEN00930	0,08	5030265 5035786	40 - 40/50 HP (4T/STROKES)



ZN	KG (kg)	OEM	
TEN00917	0,30	431708	OMC JOHNSON / EVINRUDE Diabolo 70 - 120 HP



ZN	KG (kg)	OEM	
TEN00907BIS	397768	3/8 UNC THREAD	



ZN	KG (kg)	OEM	
TEN00923	0,54	OMC JOHNSON / EVINRUDE 225 HP	



ZN	KG (kg)	AL	KG (kg)	OEM	
TEN00911	0,19	TEN00911AL	395780	OMC Cobra JOHNSON / EVINRUDE	



ZN	KG (kg)	OEM	
TEN00908	0,82	392123	OMC 90 - 140 HP JOHNSON / EVINRUDE 90 - 140 HP



ZN	KG (kg)	AL	KG (kg)	OEM	
TEN00928	0,25	TEN00928AL	0,100	397768	OMC JOHNSON / EVINRUDE



ZN	KG (kg)	AL	KG (kg)	OEM	
TEN00925	0,02	TEN00925AL	5031705		



ZN	KG (kg)	AL	KG (kg)	OEM	
TEN00918	0,72	TEN00918AL	5007089 433580	JOHNSON / EVINRUDE 60 - 300 HP	



ZN	KG (kg)	AL	KG (kg)	OEM	
TEN00907	0,25	TEN00907AL	393023 436745	OMC 50, 60, 70, 90, 140 HP JOHNSON / EVINRUDE 50, 115, 120, 140, 200 HP	



ZN	KG (kg)	OEM	
TEN00913	0,08	432397 334451	JOHNSON / EVINRUDE 4 - 7,5 HP



ZN	KG (kg)	OEM	
TEN00921	0,83	338635	JOHNSON 8, 9.9, 15 HP



ZN	KG (kg)	OEM		
TEN00914	0,119	434029	JOHNSON / EVINRUDE	
TEN00914/1	0,20		20 - 25 HP	✓



ZN	KG (kg)	OEM		
TEN00932	0,10	5030267	JOHNSON / EVINRUDE	
			HPS	



ZN	KG (kg)	OEM		
TEN00910	0,33	398331 433458	J/E	
			160 - 280 HP, V4, V6	



ZN	KG (kg)	AL	KG (kg)	OEM	
TEN00937	0,10	TEN00937AL		5032930	J/E 140 HP



ZN	KG (kg)	OEM		
TEN00909	0,70	392462	OMC 50 - 75 HP	
			J/E 50 - 75 HP	



ZN	KG (kg)	OEM		2T STROKES	4T STROKES
TEN00934	0,05	5033185	J/E		✓
			9,9 - 15 HP		



ZN	KG (kg)	OEM		2T STROKES	4T STROKES
TEN00933	0,02	5031705	J / E 3.5, 5, 6 HP		✓



ZN	KG (kg)	OEM		2T STROKES	4T STROKES
TEN00931	0,19	5031536	J/E 70 HP		✓



ZN	KG (kg)	OEM		2T STROKES	4T STROKES
TEN00935	0,08	5031538	J / E 10, 15 HP		✓



ZN	KG (kg)	OEM		
TEN00905	0,44	338742	OMC 55 HP	



ZN	KG (kg)	OEM		
TEN00936	0,05	5033167	J / E	



ZN	KG (kg)	OEM		
TEN00915	0,16	398873	398873	



ZN	KG (kg)	AL	KG (kg)	OEM		2T STROKES	4T STROKES
TEN00926	0,51	TEN00926AL		5034616 5030907	EVINRUDE		✓
					40 - 70 HP		



ZN	KG (kg)	OEM	EVINRUDE	2T STROKES	4T STROKES
TEN00927	0,25	5032929	EVINRUDE 70 HP		✓



ZN	KG (kg)	OEM	JOHNSON
TEN00912	0,08	173029 123009 327606	JOHNSON 2 - 150 HP



KITS

new

ZN	KG (kg)
TENKITOMC-50-75	



new

ZN	KG (kg)
TENKITOMC-V4-V6	



TORNILLO INOX

SS SCREW

new

REF	OEM	ÁNODO ANODE ANODO ANODE
PAGB/T5783-M6X14	5036691	CM55321-87J00 CM11130-94600 TEN01213 TEN01205



VITE INOX

VIS INOX

new

REF	OEM	ÁNODO ANODE ANODO ANODE	6 X 15
REC09116-06094	5030034 5030035 5030036	55321-93J00	6 X 15

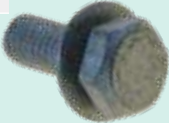

new

REF	OEM	ÁNODO ANODE ANODO ANODE	6 X 25
REC09116-06121	5030391 5032502	55321-94900	6 X 25



JUNTA TÓRICA

O-RING

O-RING

JOINT TORIQUE

new

REF	OEM	ÁNODO ANODE ANODO ANODE
REC09280-22019	5035305	CM55321-87J00 TEN01213



JUNTA TAPA DEL ÁNODO

GASKET, ANODE COVER

GUARNIZIONE, COPERCHIO ANODO

JOINT, COUVERCLE D'ANODE

new

REF	OEM
REC11265-87E10	5030623



PARTES DEL MOTOR ENGINE PARTS

PARTI MOTORE PIECES MOTEUR

DESPIECE MOTOR DE 4
TIEMPOS

ENGINE PARTS
4 STROKES

PARTI MOTORI
4 TEMPI

PIECES MOTEURS DE 4
TEMPS

4T J/BJ 40, 50 HP
STROKES

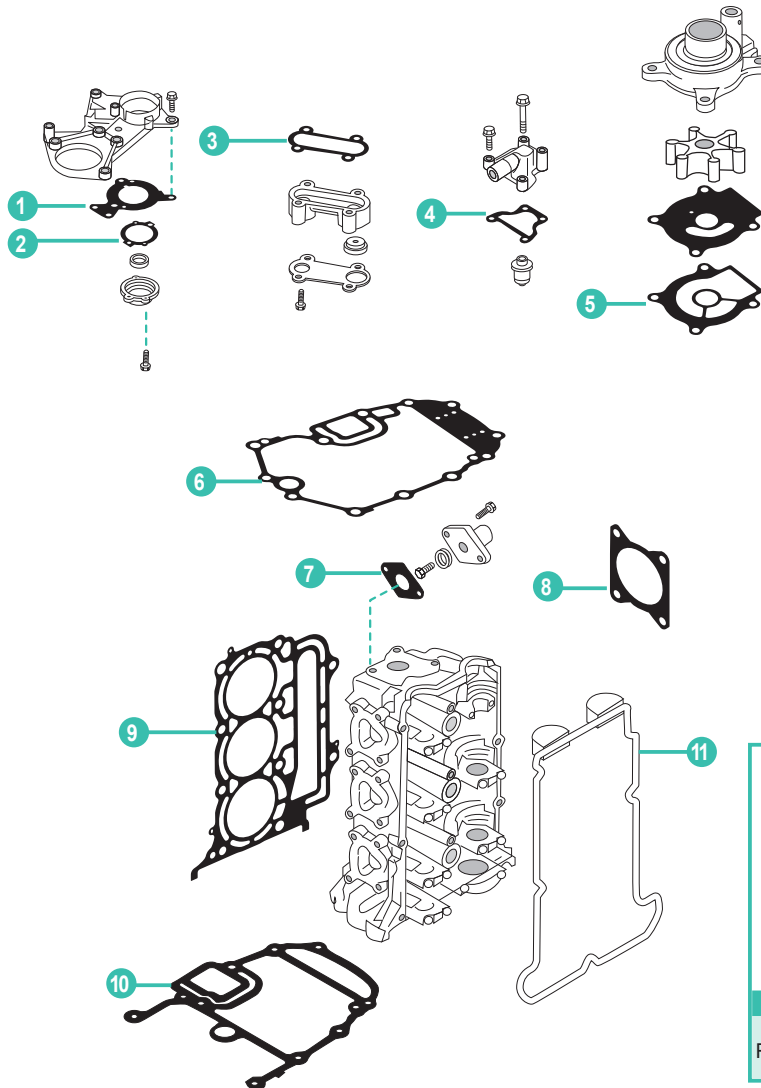

REF	OEM
REC11400-87804	5034354 5036714 5031302

P. 484

	REF	OEM				
1	REC11413-87J00	5031304	RETÉN SUPERIOR	SEAL UPPER	PARAOLIO SUPERIORE	JOINT SPI
2	REC11433-87J00	5031306	JUNTA DEL RETÉN SUPERIOR	SEAL UPPER, GASKET	GUARNIZIONE PARAOLIO SUPERIORE	JOINT
3	REC17616-87J00	5031426	JUNTA DE LA VÁLVULA DE PRESIÓN	PRESURE VALVE, GASKET	GUARNIZIONE, VALVOLA PRESIONE	JOINT SOUPAPE DE PRESSION
4	REC17685-87D10	5031430	JUNTA TAPA DE TERMOSTATO	THERMOSTAT COVER GASKET	GUARNIZIONE COPERCHIO TERMOSTATO	JOINT LOGEMENT THERMOSTAT
5	REC17472-96303	503681	JUNTA DE LA BOMBA DE AGUA	WATER PUMP, GASKET	GUARNIZIONE POMPA ACQUA	JOINT POMPE À EAU
6	REC11489-87J00	5031307	JUNTA DEL CÁRTER	OIL PAN, GASKET	GUARNIZIONE COPPA OLIO	JOINT DE CARTER
7	REC11265-87E10	5030623	JUNTA TAPA DEL ÁNODO	GASKET, COVER ANODE	GUARNIZIONE COPERCHIO ANODO	JOINT D'ANODE D'ÉCHAPPEMENT
8	REC13421-87J00	5031390	JUNTA DEL CUERPO DE MARIPOSA	THRPTTLE BODY GASKET	GUARNIZIONE CORPO FARFALLATO	JOINT DE THROTTLE BODY
9	REC11141-87J02	5031293	JUNTA DE CULATA	CYLINDER HEAD, GASKET	GUARNIZIONE TESTATA	JOINT DE CULASSE
10	REC51211-87J00	5031523	JUNTA BASE MOTOR	GASKET ENGINE	GUARNIZIONE BASE MOTORE	JOINT DE TÊTE MOTRICE
11	REC11189-87J00	5031297	JUNTA TAPA DE BALANCÍN	GASKET CYLINDER COVER	GUARNIZIONE COPERCHIO PUNTERIE	JOINT COUVERCLE

JUNTAS DE MOTOR
4 TIEMPOS

ENGINE GASKET
4 STROKES

GUARNIZIONI DE
MOTORE 4 TEMPI

JOINTS DE MOTEUR
4 TEMPS

4T
STROKES

JUNTAS DE CULATA

CYLINDER HEAD GASKET

GUARNIZIONE DE TESTATA

JOINTS DE CULASSE

REF	OEM	
REC11141-97J02	5037490	2 HP



REF	OEM	
REC11141-87J02	5031293 5034353	J/BJ 40, 50 HP

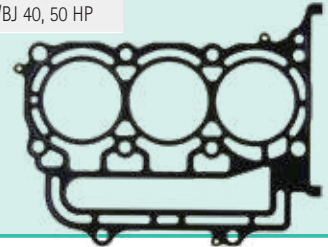

new

REF	OEM	
REC11141-91JL0	5033342	J4, 5, 6 HP



new

REF	OEM	
REC11141-90J01	5033639	90 & 115 HP

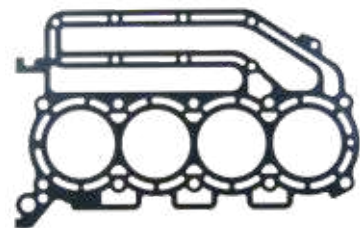

REF	OEM	
REC11141-95J00	5036802	25 HP



REF	OEM	
REC11141-92J01	5034644	140 HP

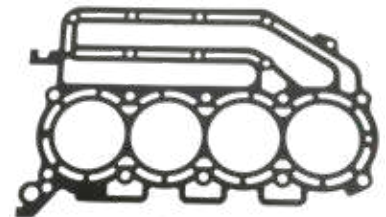

REF	OEM	
REC11141-93E20	5033046	9.9 & 15 HP



REF	OEM		
REC11142-93J10	5035971	200 & 225 HP	PORT
REC11141-93J10	5036629	200 & 225 HP	STB



4T
STROKES

GUÍA
JUNTAS DE CULATA

CYLINDER GASKET
GUIDE

GUIDA
GUARNIZIONE TESTATA

GUIDE
JOINTS DE CULASSE

	RO/OEM	REF	ESTRIBOR STB TRIBORDO DROIT	BABOR PORT BABORDO GAUCHE
J2R4SUC	2007	5037490	REC11141-97J02	
J10	2002-04	5033046	REC11141-93E20	
J15	2002-04	5033046	REC11141-93E20	
J/BJ25	2006-07	5036802	REC11141-95J00	
J90/BJ90	2003-06	5033639	REC11141-90J01	
J115/BJ115	2003-06	5033639	REC11141-90J01	
J140/BJ140	2004-05	5034644	REC11141-92J01	
BJ200	2006	5036629-5035971	REC11141-93J10	REC11142-93J10
BJ225	2006	5036629-5035971	REC11141-93J10	REC11142-93J10

4T STROKES **KITS JUNTAS DE CULATA** **CYLINDER HEAD GASKET KIT** **KIT GUARNIZIONE TESTATA** **KITS JOINTS DE CULASSE**

REF	OEM	
REC11400-87804	5034354 5036714 5031302	BJ, J40, J50HP

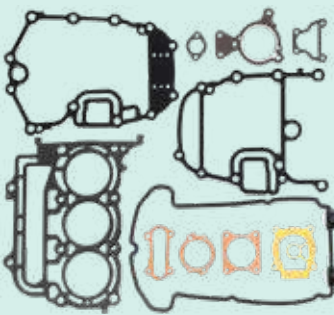



new

4T STROKES **JUNTAS BASE DE MOTOR** **CYLINDER GASKET** **GUARNIZIONE BASE MOTORE** **JOINTS DE TÊTE MOTRICE**

REF	OEM	
REC51142-93J00	5035135	J/BJ200 J/BJ225 (2004-06)



REF	OEM	
REC51211-90J10	5034757	J/BJ90 J/BJ115 J/BJ140 (2004-06)



REF	OEM	
REC51211-93J00	5035138	J/BJ200 J/BJ225 (2004-06)

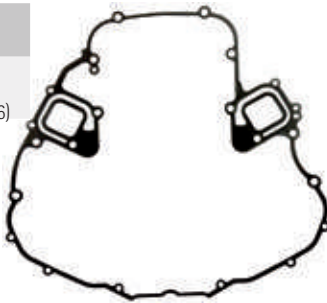

REF	OEM	
REC51211-87J00	5031523	J, BJ40, BJ50 HP

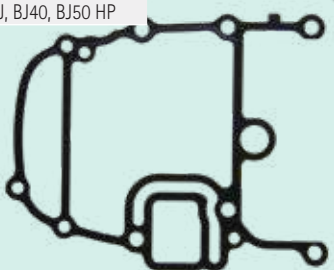

REF	OEM	
REC51211-90J2	5037205	J, BJ 90, 115, 140 HP

Motores modernos
New engines
Motore moderno
Moteurs modernes

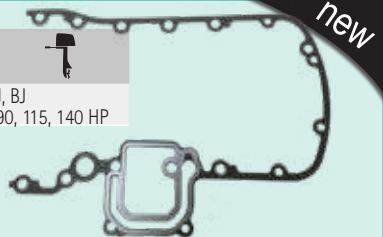

new

4T STROKES **JUNTA TAPA DE BALANCINES** **GASKET, CYLINDER COVER** **GUARNIZIONE COPERCHIO PUNTERIE** **JOINT DE CACHE CULBUTEUR**

REF	OEM	
REC11189-87J00	5031297	J/BJ 40, 50 HP



new

4T STROKES **JUNTA TAPA DE TERMOSTATO** **GASKET, THERMOSTAT COVER** **GUARNIZIONE COPERCHIO TERMOSTATO** **JOINT LOGEMENT THERMOSTAT**

REF	OEM	
REC17685-87D10	5031430	J/BJ 40, 50 HP



new

4T STROKES JUNTA VÁLVULA DE PRESION GASKET, PRESSURE VALVE GUARNIZIONE VALVOLA PRESSIONE JOINT SOUPAPE DE PRESSION

REF	OEM	Icon
REC17616-87J00	5031426	J/BJ 40, 50 HP



4T STROKES JUNTA RETÉN SUPERIOR GASKET, UPPER SEAL GUARNIZIONE PARAOLIO SUPERIORE JOINT SPI SUPERIEUR

REF	OEM	Icon
REC11413-87J00	5031304 5032428	J/BJ 40, 50 HP



REF	OEM	Icon
REC11433-87J00	5031306	J/BJ 40, 50 HP



4T STROKES JUNTAS CUERPO DE MARIPOSA GASKET, THROTTLE BODY GUARNIZIONE CORPO FARFALLATO JOINT DE THROTTLE BODY

REF	OEM	Icon
REC13421-87J00	5031390	J/BJ 40, 50 HP



CIGÜEÑAL CRANKSHAFT ALBERO MOTORE VILEBREQUIN

REF	OEM	Icon
REC0334665	334665	60 (1989-92) 65 COM (1989-92) 70 (1989-95)



BIELAS CONNECTING ROD BIELLA BIELLE

REF	OEM	Icon
REC5004705	394488	V4 Loopcharged, V6



REF	OEM	Icon
REC395861	395861	30 HP (1999-01) 40 HP (1985-02) 45 HP (1986-87, 1990-97) 48 HP (1987-96) 50 HP (1985-02) 55 HP (1985-96, 1999-01) 60 HP (1985)



REF	OEM	Icon
REC394462	394462	40 HP (1999-01) 50 HP (1995-98) 60 HP (1989-01) 70 HP (1986-01)



KIT RETENES OIL SEALS SETS KIT PARAOLIO KIT JOINT SPI

REF	OEM	
REC18-4332	9.9 - 15 HP	





REF	OEM	
REC18-8355	20 - 30AC, TE, E (1990) 20 35R / 25 COM (1990) 25, 28, 32R, TE, RE (1991-92) 20 - 35 R, 25, 30TE, 20 -30E (1996) 20 - 30AC, E, 25 COM, 28 (1994-96)	



REF	OEM	
REC18-4329	20 HP (1981-89) 25 HP (1977-89) 28 HP (1986-88) 30 HP (1984-89) 35 HP (1976-89)	



REF	OEM	
REC18-4331	CrossFlow V4 - V6	



REF	OEM	
REC18-4330	40 - 75 HP	



RETENES OIL SEALS PARAOLIO JOINT SPI

REF	OEM	
REC340559	340559 034559 0778417	E/J 40 HP - 200 HP (1994+)



REF	OEM	
REC328603	328603	20, 35 HP CROSSFLOW (1985-05)



REF	OEM	
REC398051	398051	20, 35 HP (1976-05)



GUÍA RETENES

CRANKSHAFT GUIDE

GUIDA PARAOLIO

GUIDE JOINTS SPI

		1	2
9.9	1974-83	REC321831	1
9.9	1984-95	REC321831 REC321788	1
10	1981	REC321831	
10	1989	REC321831 REC321788	1
14	1988-90	REC321831 REC321788	1
15	1974-83	REC87670	1
15	1984-95	REC321831 REC321788	1
18	1957	REC321467	1
18	1958-73	REC767970	1
25	1969-76	REC767970	1
40	1960-61	REC767970	1
40	1974-76	REC321895	1
40 C	1981-86	REC321895	1
40	1984-85	REC321895	1
40 (AR,AE,AT)	1988	REC321895	1
40	1986-89	REC321895	1
45 C	1985-95	REC321895	1
48	1988-95	REC321895	1
50	1971-80	REC321895	1
50/60	1981-89	REC321895	1
50	1990-95	REC321895	1
55	1968-69	REC321895	1
55, 55 C	1976-85	REC321895	1
55 C	1986-95	REC321895	1
60	1970	REC321895	1
60 (3-Cyl.)	1971	REC321895	1
60	1980-83	REC321895	1
60 SST	1989	REC321895	1
60 SST	1990	REC321895	1
60 (3-Cyl.)	1987-95	REC321895	1
65 (Manual)	1968	REC321895	1
65 (3-Cyl.)	1972-73	REC321895	1
65 C	1984-89	REC321895	1
70 (Large)	1974-85	REC321895	1
70 (Large)	1986-95	REC321895	1

		1	2
70 (Small)	1977-85	REC321895	1
75 (Large)	1975-87	REC321895	1
75 (Small)	1975-84	REC321895	1
85	1969-72	REC339620	1
85	1973-80	REC339620	2
88	1987-94	REC339620	2
90	1981-83	REC339620	2
90	1984-94	REC329923	1
90 Seadrive	1985-90	REC339620	2
100	1971-72	REC339620	1
100	1979-80	REC339620	2
100 C	1984-90	REC339620	2
110	1986-88	REC339620	2
115	1969-83	REC339620	1
115	1984-85	REC339620	2
115	1990-94	REC339620	2
120	1985-94	REC339620	2
125	1971-72	REC339620	1
125 C	1989	REC339620	2
125 C (ESX)	1989	REC329923	1
135	1973-76	REC339620	2
140	1977-84	REC339620	2
140	1985-94	REC339620	2
140 TX	1989	REC339620	2
150	1978-83	REC339620	2
150	1984	REC339620	2
155 C	1984-85	REC339620	2
155 C	1986-90	REC339620	2
175	1977-85	REC339620	2
175	1986-90	REC339620	2
185	1984-85	REC339620	2
185	1990	REC339620	2
200	1976-83	REC339620	2
200	1984-85	REC339620	2
200,225	1986-90	REC339620	2
235	1978-85	REC339620	2
275	1985-88	REC339620	2
3.6L, 300	1985-90	REC339620	2

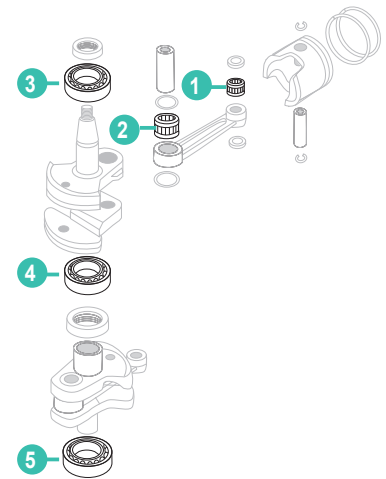
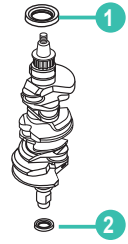

COJINETES PIE DE BIELA

CONNECTING ROD BEARING, SMALL END

CUSCINETTO DI BIELA, FINALE PICCOLO

ROULEMENT PIED DE BIELLE

REF	OEM	
REC395627	395627	20 - 35 HP (1981-95) 45 - 60 (2 Cyl) (1977-95) V4 Crossflow (3 Cyl) (-1973) V6 Crossflow (-1976) V4, V6 60°



REF	OEM	
REC434844	434844	V4, V6, V8 90° LoopedCharged (1985+)





2

COJINETES
CABEZA DE BIELLACONNECTING ROAD
BEARING, BIG ENDCUSCINETTO DI BIELLA,
FINALE GRANDEROULEMENT TÊTE DE
BIELLE

REF	OEM			OEM
REC31-17514A2	437088	20 - 35 HP (1976-95) 46 - 60 HP (2 Cyl) (1971-94) 3 Cyl (1968-93) V4 (1961-73)	REC764102	387139 387142



Ø 1.1825 - 30 mm



REF	OEM			OEM
REC387787	387787	V4 Crossflow (-1979) V6 Crossflow (-1976) V4-V6 60°	REC764102	387139 387142

Ø 1.375



REF	OEM			OEM
REC878763	396041	V4, V6, V8 90° LoopedCharged (1985-95)		

Ø 1.500



REF	OEM
REC5007190	387041



REF	OEM
REC388344	388344



REF	OEM
REC764102	387139



3

COJINETES SUPERIORES

UPPER BEARING

CUSCINETTO SUPERIORE

ROULEMENT SUPERIEUR

REF	OEM	
REC390900	390900	45 - 60 HP 2 Et 3 Cyl
REC398529	398529	45 - 60 HP (Modernos Late models Moderno Moderne) 2 Et 3 Cyl
REC31-02799	393896	



REC390900

REC398529

REC31-02799



4

COJINETES CENTRALES

CENTER BEARING

CUSCINETTO CENTRALI

ROULEMENT CENTRAL

REF	OEM		
REC395401	395401	9.9 - 15 HP (1974-95) 9.9 - 15 HP (1974-83) 40C (-1974)	Ø 0.8125
REC378252	378252	45 - 60 HP (2 Cyl) (-1971) V4 (3 Cyl) (1962-78)	Ø 1.375
REC5007190	387041	V4 Crossflow (-1979) V6 Crossflow (-1976) V4-V6 60°	Ø 2.1875



REC395401

REC378252

4

REF	OEM	
REC310433	310433	40C (-1974) 45 - 60 HP (2 Cyl) (-1971) V4 (3 Cyl) (1962-78) V4 Crossflow (-1979)
REC352960	320499	V6 Crossflow (-1976) V4-V6 60°

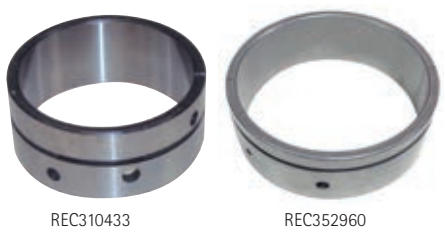

REC310433

REC352960

5

COJINETES INFERIORES

LOWER BEARING

CUSCINETTO INFERIORE

ROULEMENT INFERIEUR

REF	OEM
REC31-02803	385503
REC31-02747	330854
REC31-02806	390641



REF	OEM	
REC377139	377139	3 Cyl (1968-94)

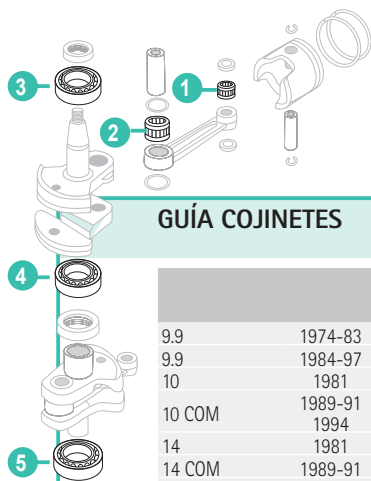



GUÍA COJINETES

GUIDE BEARING

GUIDA CUSCINETTO

GUIDE ROULEMENT

		1	2		3	4		5
9.9	1974-83	REC395627	REC395401			REC395401		
9.9	1984-97	REC395627	REC395401					
10	1981	REC395627	REC395401					
10 COM	1989-91 1994		REC395401					
14	1981		REC395401			REC395401		
14 COM	1989-91	REC395627	REC395401					
15	1974-83	REC395627	REC395401			REC395401		
15	1984-97	REC395627	REC395401					
15 COM	1994	REC395627	REC395401					
18	1970-73	REC395627		REC764102				
18 JET	1996-97	REC395627	REC388344		REC31-02799	REC31-02798		REC31-02747
20	1981-84	REC395627	REC388344	REC764102		REC31-02798		REC31-02747
20	1985-97		REC388344		REC31-02799	REC31-02798		REC31-02747
25	1970-76			REC764102				
25	1977	REC395627	REC388344	REC764102				REC31-02747
25	1978-80	REC395627	REC388344	REC764102		REC31-02798		REC31-02747
25	1981-84		REC388344	REC764102		REC31-02798		REC31-02747
25	1985-97		REC388344		REC31-02799	REC31-02798		REC31-02747
25 COM (NO mod. D)	1982-84		REC388344	REC764102		REC31-02798		REC31-02747
25 COM	1985-97	REC395627	REC388344		REC31-02799	REC31-02798		REC31-02747
28	1987-97	REC395627	REC388344		REC31-02799	REC31-02798		REC31-02747
30	1984		REC388344	REC764102		REC31-02798		REC31-02747
30	1985-97		REC388344		REC31-02799	REC31-02798		REC31-02747
33	1970		REC388344	REC764102				
35	1976-80	REC395627	REC388344	REC764102				REC31-02747
35	1981-84	REC395627	REC388344	REC764102		REC31-02798		REC31-02747
35	1985-97	REC395627	REC388344		REC31-02799	REC31-02798		REC31-02747
40	1971-73	REC395627	REC388344	REC764102				
40	1974-76 1983	REC395627	REC388344	REC764102		REC378252	REC310433	REC377139
40	1984-86	REC395627	REC388344		REC390900	REC378252	REC310433	REC377139
40	1987-97	REC395627	REC388344		REC398529	REC378252	REC310433	REC377139
40 COM	1982-83	REC395627	REC388344			REC378252	REC310433	REC377139
40 COM	1984-85	REC395627	REC388344		REC390900	REC378252	REC310433	REC377139
40 COM	1989-90	REC395627	REC388344		REC398529	REC378252	REC310433	REC377139
40 COM	1994	REC395627	REC388344		REC398529	REC378252	REC310433	
40 COM	1995-00	REC395627			REC398529	REC378252	REC310433	
45 COM	1985-86 1987-94	REC395627	REC388344		REC390900	REC378252	REC310433	REC377139
45 COM	1995-97	REC395627			REC398529	REC378252	REC310433	
45 SS	1987-90	REC395627	REC388344		REC390900	REC378252	REC310433	REC377139
48	1987	REC395627	REC388344		REC390900	REC378252	REC310433	REC377139
48	1988-96	REC395627	REC388344		REC398529	REC378252	REC310433	REC377139
50	1979-83	REC395627	REC388344	REC764102	REC390900	REC378252	REC310433	REC377139

		1	2		3	4		5
50	1984-86	REC395627	REC388344		REC390900	REC378252	REC310433	REC377139
50 (2 Cyl)	1987-00	REC395627	REC388344		REC398529	REC378252	REC310433	REC377139
50 (3 Cyl)	1995-00	REC395627			REC398529	REC378252	REC310433	REC377139
55	1976-81		REC388344	REC764102	REC390900	REC378252	REC310433	REC377139
55 COM	1982	REC395627	REC388344	REC764102	REC390900	REC378252	REC310433	REC377139
55 COM	1983-86	REC395627	REC388344		REC390900	REC378252	REC310433	REC377139
55 COM	1987-94	REC395627	REC388344		REC398529	REC378252	REC310433	REC377139
55 COM	1995-00	REC395627			REC398529	REC378252	REC310433	
60	1980-83		REC388344	REC764102	REC390900	REC378252	REC310433	REC377139
60	1984-85	REC395627	REC388344		REC390900	REC378252	REC310433	REC377139
60	1986-90							
60	1991-93	REC395627	REC388344		REC398529	REC378252	REC310433	REC377139
60	1994-01	REC395627			REC398529	REC378252	REC310433	REC377139
SST-60	1989-90		REC388344		REC390900	REC378252	REC310433	REC377139
65	1972-73	REC395627	REC388344	REC764102	REC390900	REC378252	REC310433	REC377139
65 COM	1984	REC395627	REC388344	REC764102	REC390900	REC378252	REC310433	REC377139
65 COM	1985-90	REC395627	REC388344		REC390900	REC378252	REC310433	REC377139
65 COM	1991-93		REC388344		REC398529	REC378252	REC310433	
65 COM	1994-01	REC395627			REC398529	REC378252	REC310433	
70	1974-75	REC395627	REC388344	REC764102	REC390900	REC378252	REC310433	REC377139
70	1976-84							
70	1985-90	REC395627	REC388344		REC390900	REC378252	REC310433	REC377139
70	1991-93	REC395627	REC388344		REC398529	REC378252	REC310433	REC377139
70	1994-97	REC395627			REC398529	REC378252	REC310433	REC377139
75	1975		REC388344	REC764102	REC390900	REC378252	REC310433	REC377139
75	1976-84	REC395627	REC388344	REC764102	REC390900	REC378252	REC310433	REC377139
75	1985-88	REC395627	REC388344		REC390900	REC378252	REC310433	REC377139
80 JET	1992-98	REC395627	REC387787		REC390900	REC5007190	REC352960	REC31-02803
85	1968-72	REC395627	REC388344	REC764102		REC378252	REC310433	REC377139
85	1973	REC395627	REC388344	REC764102		REC378252	REC310433	REC31-02803
85	1974-78	REC395627	REC387787			REC378252	REC310433	REC31-02803
85	1979-80	REC395627	REC387787			REC5007190	REC352960	REC31-02803
85	1991-95							
88	1987-96	REC395627	REC387787			REC5007190	REC352960	REC31-02803
90 (90° V)	1981-03		REC387787			REC5007190	REC352960	REC31-02803
90 (60° V)	1995-03	REC395627	REC387787			REC5007190	REC352960	
90 JET	1994-95	REC434844	REC387787			REC5007190	REC352960	REC31-02803
100	1979-80		REC387787			REC5007190	REC352960	REC31-02803
100	1990-94	REC434844	REC387787			REC5007190	REC352960	REC31-02803
100 COM	1984-05	REC434844	REC387787			REC5007190	REC352960	REC31-02803
110	1986-89	REC434844	REC387787			REC5007190	REC352960	REC31-02803
115	1994-96	REC395627	REC387787			REC5007190	REC352960	REC31-02803
115	1974-78	REC395627	REC387787			REC378252	REC310433	REC31-02803
115	1979-85	REC395627	REC387787			REC5007190	REC352960	REC31-02803
115 (90° V)	1990-06	REC434844	REC387787			REC5007190	REC352960	REC31-02803
115 (60° V)	1995-06	REC395627	REC387787			REC5007190	REC352960	
115 JET	1994-06		REC387787			REC5007190	REC352960	REC31-02803
120	1985-94		REC878763			REC5007190	REC352960	REC31-02806
125	1971-72	REC395627	REC388344	REC764102		REC378252	REC310433	REC377139
125 COM	1989-95	REC395627	REC878763			REC5007190	REC352960	REC31-02806
125 ESX	1991-94		REC878763			REC5007190	REC352960	REC31-02806
130	1994-00	REC395627	REC878763			REC5007190	REC352960	REC31-02806
135	1974-76	REC434844	REC387787			REC378252	REC310433	REC31-02803
140	1977-78	REC395627	REC387787			REC378252	REC310433	REC31-02803
140	1979-84	REC434844	REC387787			REC5007190	REC352960	REC31-02803
140	1985-94	REC434844	REC878763			REC5007190	REC352960	REC31-02806
150	1978-91	REC434844	REC387787	REC764102		REC5007190	REC352960	REC31-02803
150 (60° V)	1991-06	REC434844	REC387787			REC5007190	REC352960	
150 COM (60° V)	1993-95	REC395627	REC387787			REC5007190	REC352960	
155 COM	1984-92	REC434844	REC387787	REC764102		REC5007190	REC352960	REC31-02803
175	1977-91	REC434844	REC387787	REC764102		REC5007190	REC352960	REC31-02803
175 (60° V)	1991-97	REC434844	REC387787			REC5007190	REC352960	
185	1984-85	REC434844	REC387787	REC764102		REC5007190	REC352960	REC31-02803
185	1990-94	REC434844	REC878763			REC5007190	REC352960	REC31-02806
200	1976-83		REC387787	REC764102		REC5007190	REC352960	REC31-02803
200	1986-06		REC878763			REC5007190	REC352960	REC31-02806
200 COM	1990, 1994		REC878763			REC5007190	REC352960	REC31-02806
225	1986-06		REC878763			REC5007190	REC352960	REC31-02806
235	1978-85		REC387787	REC764102		REC5007190	REC352960	REC31-02803
250	1991-95		REC878763			REC5007190	REC352960	REC31-02806
250	1997							
275	1985-88		REC878763			REC5007190	REC352960	REC31-02806
3.6L	1985-87		REC878763			REC5007190	REC352960	REC31-02806
300	1988-95		REC878763			REC5007190	REC352960	REC31-02806

PISTONES

PISTONS

PISTONI

PISTONS

DISEÑOS DE PISTONES

PISTON DESIGNS

DISEGNO DEI PISTONI

DESSIN DES PISTONS

Existen tres tipos de diseño diferentes utilizados en los motores Johnson-Evinrude: Crossflow, Loopcharged y 4 Tiempos.

There are three basic piston designs used in Johnson / Evinrude outboard engines: Crossflow, Loopcharged and Four-Stroke.

Esistono tre tipi di disegni diversi utilizzati nei motori Johnson-Evinrude: Crossflow, Loopcharged e 4 Tempi.

Il existe trois types de dessin différents utilisés sur les moteurs Johnson-Evinrude: Crossflow, Loopcharged et 4T

CROSSFLOW

Mientras la mezcla de aire y combustible circula a través del cilindro, un deflector dirige la mezcla hacia la cámara de combustión.

As the air / fuel mixture travels through the transfer port and into the cylinder, a deflector, cast into the top of the piston, directs the air / fuel mixture towards the combustion chamber.

Mentre la miscela d'aria e il combustibile circolano attraverso il cilindro il deflettore del pistone dirige la miscela verso la camera di combustione.

Lorsque le mélange air-carburant circule dans le cylindre, un déflecteur dirige le mélange dans la chambre de combustion.

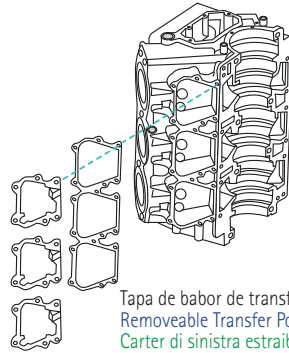

Tapa de babor de transferencia desmontable
Removeable Transfer Port Cover
Carter di sinistra estraibile
Couvercle gauche de transfert démontable



Pistón con deflector
Piston with Deflector Top
Pistone con deflettore
Piston avec déflecteur

LOOPCHARGED

El motor loopcharged tiene una toma de transferencia en la pared del cilindro, de tal forma que dirige la mezcla de aire y combustible hacia la cámara de combustión, arrancando así, sin la necesidad de un deflector.

A loopcharged engine has a transfer port cast into the cylinder wall in such a way that it will direct the air / fuel mixture towards the combustion chamber and spark plug tip without the need for a piston deflector.

Aspirazione nella parete del cilindro in maniera tale da dirigere la miscela d'aria e combustibile verso la camera di combustione, non avendo così la necessità di convogliare la combustione con il deflettore.

Le moteur Loopcharged a un orifice de transfert dans la paroi du cylindre, de telle sorte qu'il dirige le mélange d'air et de carburant vers la chambre de combustion, démarrant ainsi, sans avoir besoin d'un déflecteur.

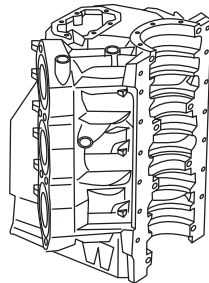

Tapa de babor de transferencia fija
Non-Removeable Transfer Port Cover
Carter di sinistra fisso
Couvercle gauche de transfert fixe



Pistón con tapa plana
Piston with Flat Top
Pistone con testa piana
Piston à tête plate

4 TIEMPOS

Los motores de 4 tiempos son bastante nuevos en la industria náutica. Son los favoritos de la mayoría de los fabricantes pues respetan las leyes sobre el medio ambiente. El aceite almacenado en el cárter de estos motores sale disparado hacia las paredes de los pistones y sus aros para su lubricación.

4 STROKES

Four-stroke / four-cycle engines are fairly new to the marine industry. They have become the engine design preferred by most marine engine manufacturers to meet government mandated exhaust emission standards. Oil stored in the crankcase of these engines is splashed onto the cylinder walls for piston and ring lubrication.

4 TEMPI

I motori a 4 tempi sono abbastanza nuovi nell' industria nautica. Sono i preferiti dalla maggior parte dei fabbricanti perchè rispettano le leggi sull' ambiente. L'olio è immagazzinato nel carter di questi motori e scorre nelle pareti dei pistoni e delle fasce per la lubrificazione.

4 TEMPS

Les moteurs à 4 temps sont relativement nouveaux dans l'industrie maritime. Ils sont les favoris de la plupart des fabricants car ils respectent les lois sur l'environnement. L'huile stockée dans le carter de ces moteurs jaillit vers les parois des pistons et leurs segments pour la lubrification.



Pistón con tapa plana y aro de aceite en la parte inferior
Piston with Flat Top and Oil Ring in the Bottom Position
Pistone con testa piana e paraolio
Piston avec tête plate et bague d'huile en bas



KITS DE PISTONES
AROS , PASADORES, BULÓN

PISTON KITS
RINGS, PIN AND CIRCLIP



KIT PISTONE
FASCE, SPINOTTO E CLIP

KIT PISTON
SEGMENTS, AXE ET CLIPS



CROSSFLOW

	STD (2.188")		0.30 (2.188")		
	REF	OEM	REF	OEM	
	REC5006670	5006670	REC5006662	5006662	(2 Cyl) 9.9 HP (1981-92) 15 HP (1981-92)
	REC386918	386279	REC386280	386280	





	STD (3.000")		0.30 (3.030")		
	REF	OEM	REF	OEM	
	REC5006657	5006657	REC5006664	5006664	(2 Cyl) 20 HP (1981-83) 25 HP (1986-94) 30 HP (1984-94)
	REC396377	396377	REC396379	396379	





	STD (3.500")		0.30 (3.530")		
	REF	OEM	REF	OEM	
	REC5006658	5006658	REC5006669	5006669	V4 85 HP (1979-80) 88 HP (1987-93) 90 HP (1981-93) 100 HP (1984-94) 110 HP (1986-90) 115 HP (1973-85) 135 HP (1974-76) 140 HP (1977-84) 150 HP (1978-91) 175 HP (1977-85) 185 HP (1984-85) 200 HP (1976-83) 235 HP (1978-79)
	REC394930	394930	REC396504	396504	





	STD (3.625")		0.30 (3.655")		
	REF	OEM	REF	OEM	
			REC5006668	5006668	V4 175 HP (1986-91) 235 HP (1980-85)
	REC390509	390509	REC390510	390510	





LOOPCHARGED

	STD (3.187")		0.30 (3.217")		
	REF	OEM	REF	OEM	
	KIT REC435546	5006655	REC5006665	5006665	(2 Cyl) 40 HP (1984-94) 45 HP (1994) 48 HP (1987-94) 50 HP (1981-94) 55 HP (1994) 60 HP (1980-85)
	REC391170	391170	REC391416	391416	



	STD (3.000")		0.30 (3.030")		
	REF	OEM	REF	OEM	
	REC5006751	5006751	REC5006666	5006666	(3 Cyl) 60 HP (1986-88) 65 HP COM (1984-86) 70 HP (1976-85) 75 HP (1976-88)
	REC396377	396377	REC396379	396379	





	STD (3.187")		0.30 (3.217")		
	REF	OEM	REF	OEM	
	REC5006701	5006701	REC5006702	5006702	(3 Cyl) 50 HP (1995-98) 60 HP (1989-94) 65 HP (1987-94) 70 HP (1986-94)
	REC391170	391170	REC391416	391416	



	STD (3.685")		STD 0.30 (3.715")		PORT 0.30 (3.715")		
	REF	OEM	REF	OEM	REF	OEM	
			REC5006713	5006713	REC5006711	5006711	OCEAN PRO/RUNNER 90° 200 HP / 225 HP (1993-01) Con carburadores With carburetors Con carburatori Avec carburateur
	REC436254	436254					



	STD (3.1875")		
	REF	OEM	
	REC5006694	5006694	(3 Cyl) 60 HP (1994-01) 65 HP (1994-01) 70 HP (1994-01)
	REC436972	436972	



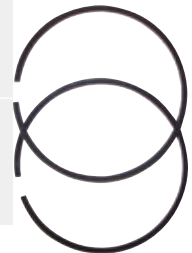

	REF	OEM	STD	
REC396504	396504	3.530"	V8 275 HP (1985-87) V8 300 HP (1985-87)	
REC431870	431870	3.685"	V4 120 HP 90° (1988-94) V4 140 HP 90° (1988-94) V6 200 HP (1988-92) V6 225 HP (1988-92) V8 275 HP (1991-98) V8 300 HP (1988-95)	



4T SERIE EAGLE / JET EAGLE

STROKES

	STD (3.600")		STD 030 (3.630")		PORT (3.600")		PORT 030 (3.630")		
	REF	OEM	REF	OEM	REF	OEM	REF	OEM	
	REC5006688	5006688	REC5006716	5006716	REC5006687	5006687	REC5006714	5006714	V4 60° 90 HP (1995-06) V6 60° 115 HP (1995-06) JET EAGLE V4 60° 105 HP (1993-97) JET EAGLE V6 60° 150 HP (1991-06) 175 HP (1991-06)
	REC436353	436353			REC436353	436353			



4T SERIE FITCH

STROKES

	STD (3.600")		PORT (3.600")		STD 030 (3.630")		
	REF	OEM	REF	OEM	REF	OEM	
	REC5006728	5006728	REC5006727	5006727	REC5006730	5006730	75, 90, 115, 150, 175 HP 60° (2000+)
	REC436353	436353	REC436353	436353			



2T
STROKES

JUNTAS DE MOTOR 2 TIEMPOS ENGINE GASKET 2 STROKES GUARNIZIONI MOTORE 2 TEMPI JOINTS DE MOTEUR 2 TEMPS

JUNTAS DE CULATA CYLINDER HEAD GASKET GUARNIZIONE DE TESTATA JOINT DE CULASSE

REF	OEM
REC313782	313782



REF	OEM
REC802307	332010



REF	OEM
REC329419	329419



REF	OEM
REC802288	325273



REF	OEM
REC330818	330818



REF	OEM
REC338222	338222



REF	OEM
REC335359	335359 327795



REF	OEM
REC340115	340115



REF	OEM
REC328623	328623



REF	OEM
REC319633	319633



REF	OEM
REC318358	318358



REF	OEM
REC203130	203130

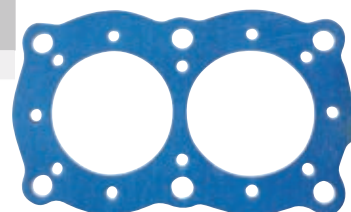

REF	OEM
REC329103	329103



REF	OEM
REC332819	332819



JOHNSON EVINRUDE

RECAMBIOS
MARINOS

REF	OEM
REC307069	307069



REF	OEM
REC878846	313413

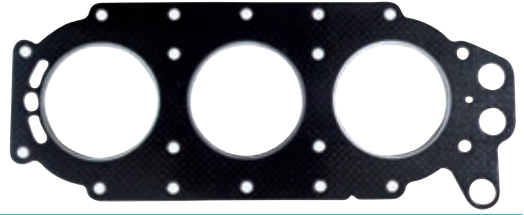

REF	OEM
REC335361	335361 325647



REF	OEM
REC333670	334726 333670



REF	OEM
REC332817	332817



REF	OEM
REC329836	329836



REF	OEM
REC332816	332816

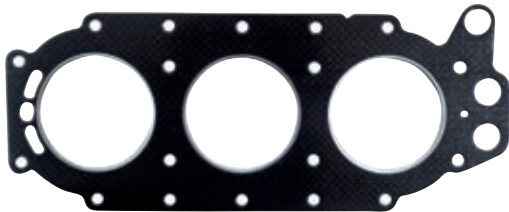

REF	OEM
REC766779	335360 320745



REF	OEM
REC345257	345257



REF	OEM
REC332818	332818



REF	OEM
REC331211	331211



REF	OEM
REC340116	340116 333554



**KITS
JUNTAS DE CULATA**

**CYLINDER HEAD GASKET
KIT**

**KIT
GUARNIZIONE TESTATA**

**KITS
JOINT DE CULASSE**

REF	OEM	
REC802113	394546	9.9 - 15 HP (1984-92)

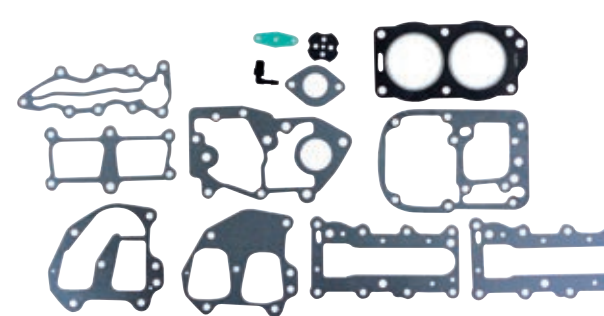

REF	OEM	
REC439083	393433 439083	40 - 60 HP (2 cyl) Loopcharged (1998-01)



REF	OEM	
REC436358	436358	9.9 - 15 HP (1993-99)

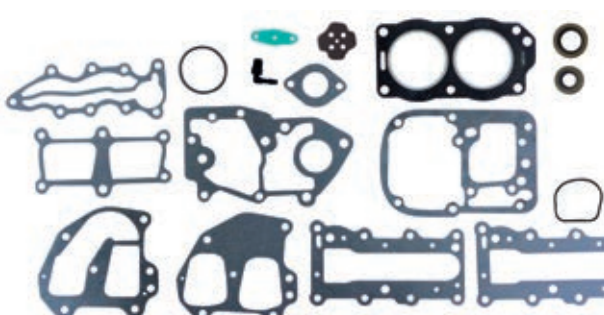

REF	OEM	
REC39390	398047 438904	60 - 70 HP (3 cyl) (1986-01)

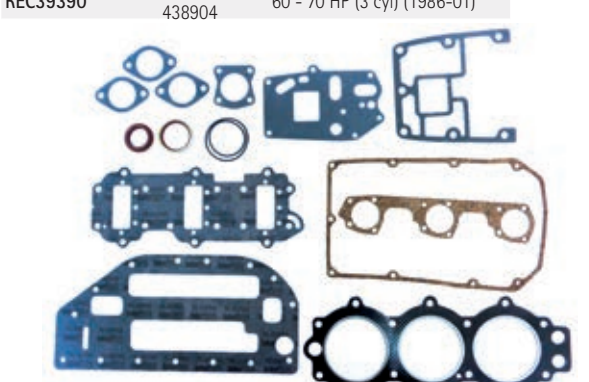

REF	OEM	
REC802133	433941 392567 392615	20 - 30 HP Crossflow (1996-99)

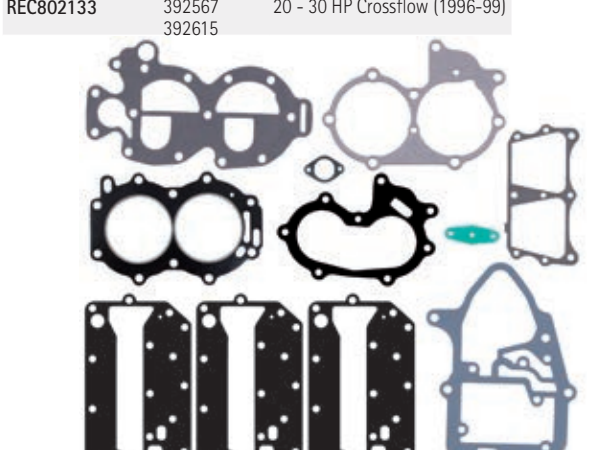

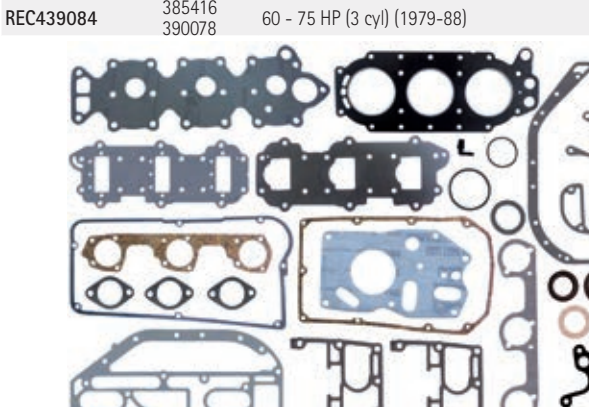

REF	OEM	
REC439084	385416 390078	60 - 75 HP (3 cyl) (1979-88)

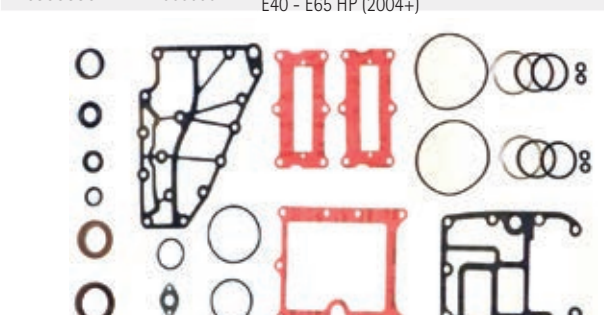

REF	OEM	
REC5005907	5005907	E-TEC (2 cyl en línea inline in linea en ligne) E40 - E65 HP (2004+)



REF	OEM	
REC5005931	5005931	E-TEC (4 cyl en línea inline in linea en ligne) E75, E90 HP (2004+)



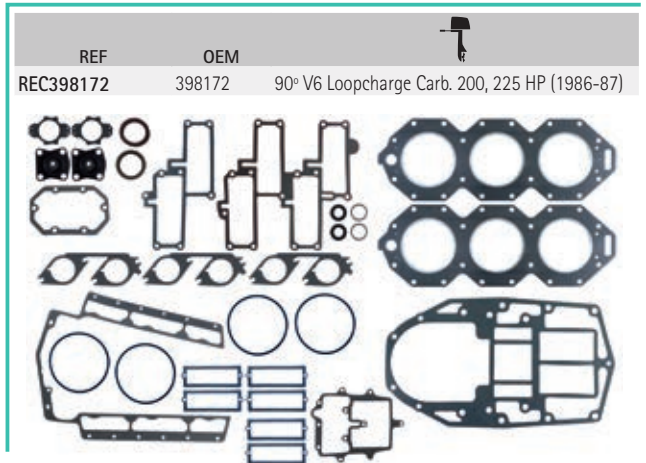
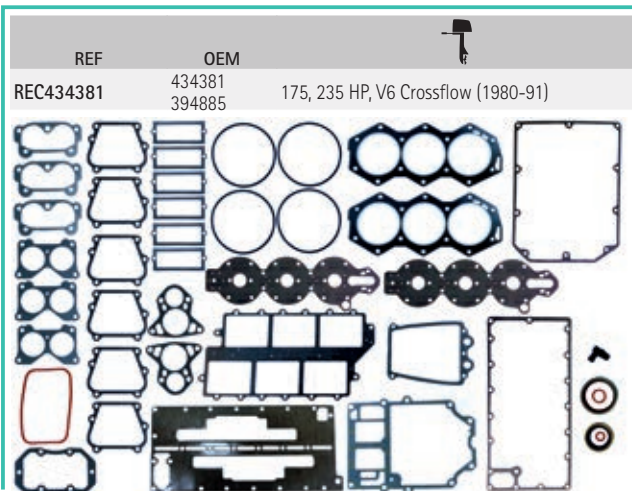
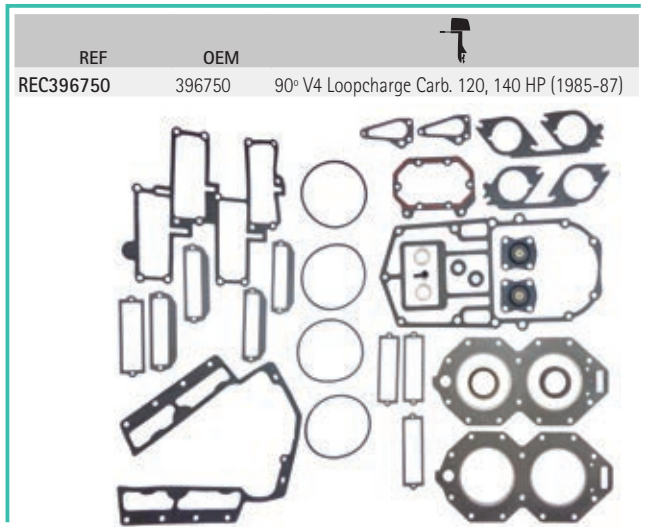
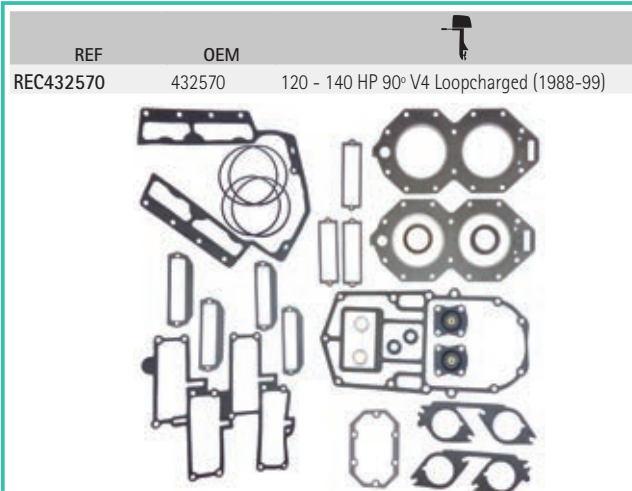
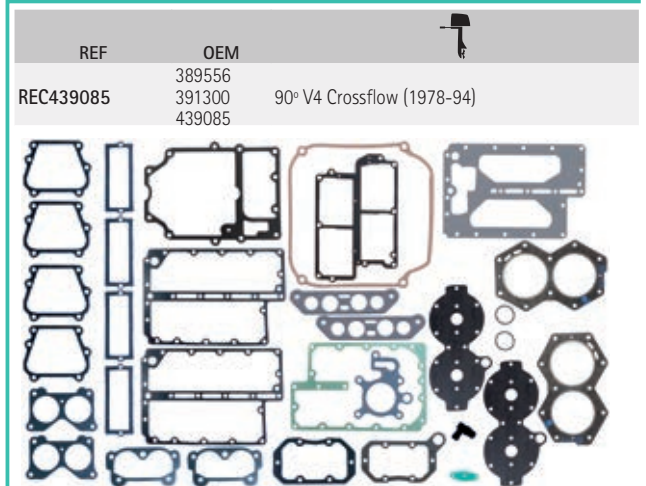
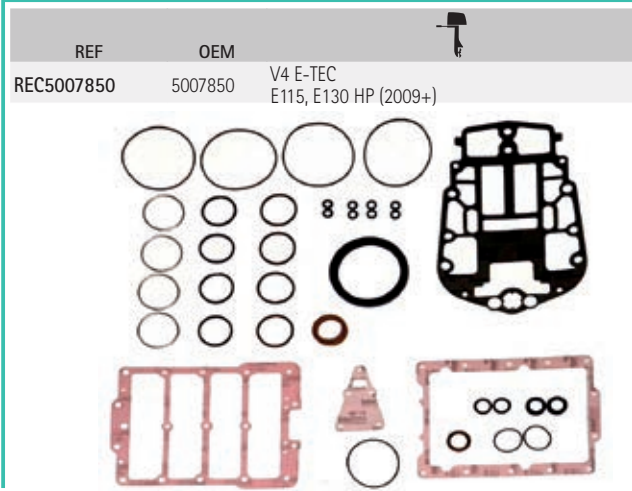
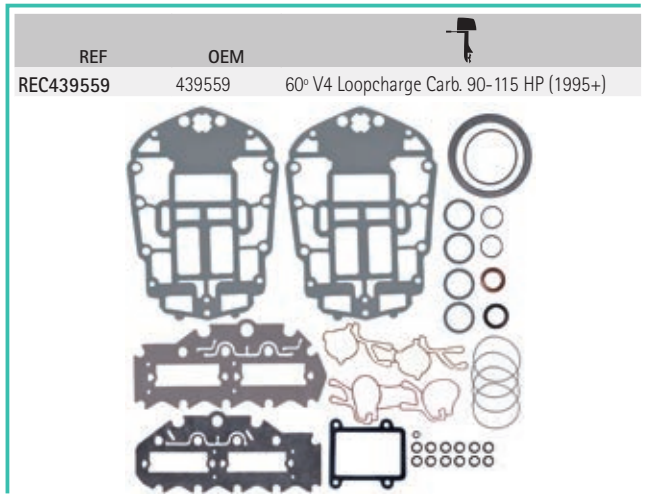
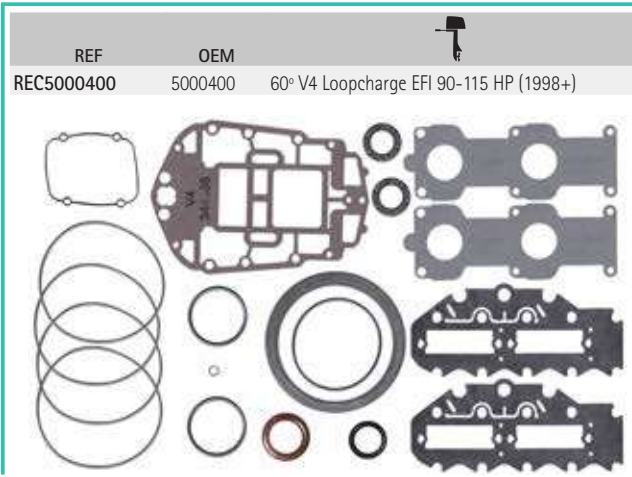

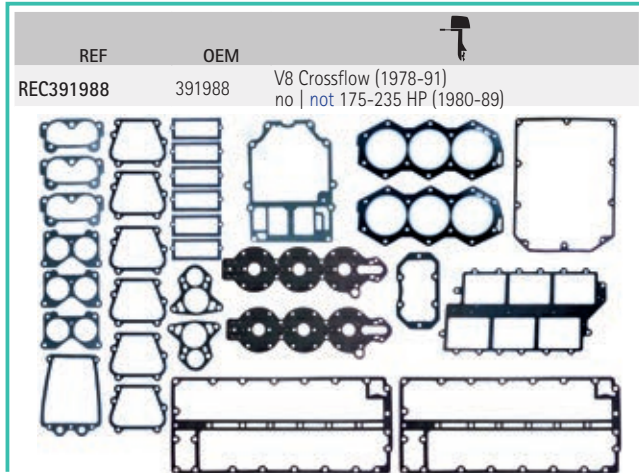
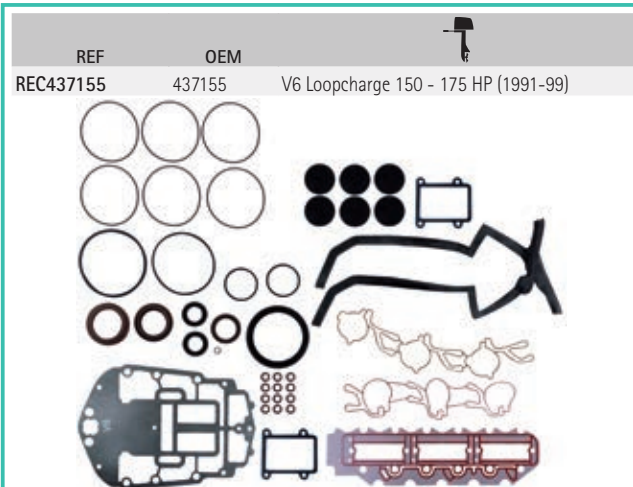
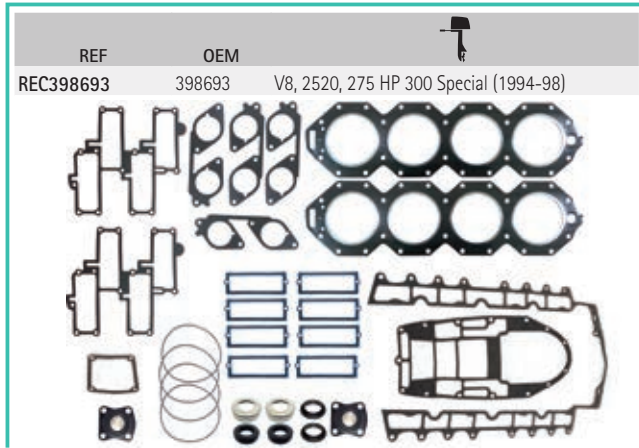
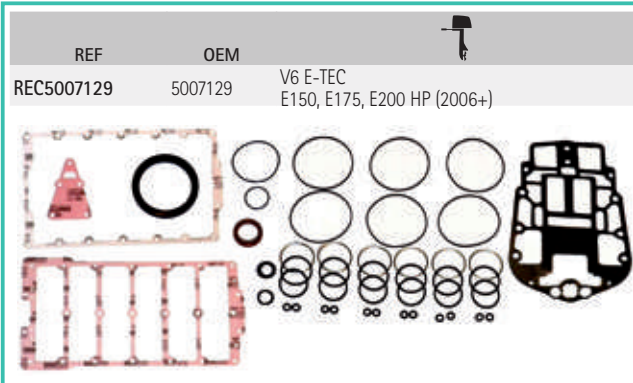
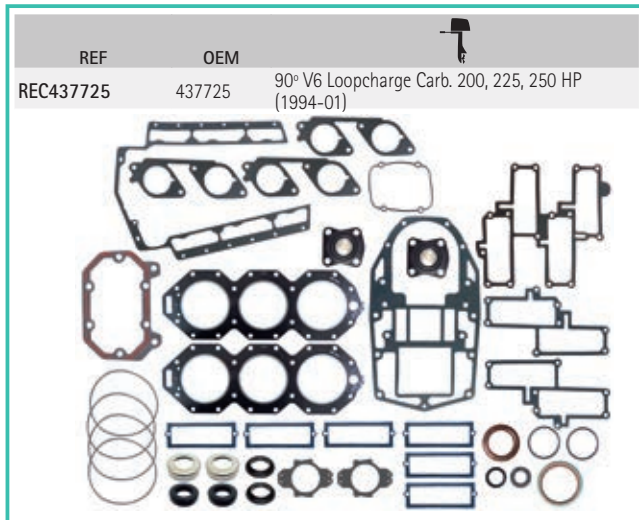
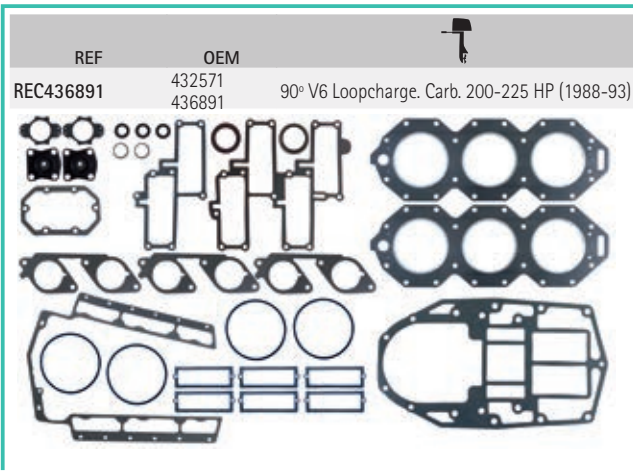

2T
STROKES

GUÍA JUNTAS DE CULATA

CYLINDER HEAD GASKET GUIDE

GUIDA GUARNIZIONE TESTATA

GUIDE JOINTS DE CULASSE

		cyl	KIT	
2 Colt, Junior	1969-90			REC313782
4	1968-80			REC203130
2.5, 3, 4, 4.5, Ultra, Excel 4	1981-98			REC802307
5, 5.5, 6	1959-73			REC329103
6	1980-98			REC802288
9.9, 15	1974-92	2	REC802113	REC330818
9.9, 15	1993-99	2	REC436358	REC338222
20, 25, 28, 30	-1979	2	REC802133	
20, 25, 28, 30, 35 (521 cc)	1979-00			REC329419
35 (521 cc)	1976-78			REC319633
35	1979-86	2	REC802133	
40	1960-76			REC307069
40, 40 COMM (719 cc)	1968-86			REC307069
40, 45, 48, 50, 55, 60 (737 cc)	1976-01			REC335359
40, 45, 48, 55	-1980	2	REC439083	
E40	2004	2	REC5005907	
50	1971-75	2	REC439083	

		cyl	KIT	
55	1976	2	REC439083	
55	1977-79	2	REC439083	
50	1980	2	REC439083	
50	1995	3	REC39390	
55, 60	1980-85	2	REC439083	
55, 60, 65	1968-73			REC878846
60 (814 cc)	1986-89	3		REC878846
60 (913 cc)	1974-85	3		REC878846
60	1986-88	3	REC439084	
60	-1989	3	REC39390	
E60	2004	2	REC5005907	
60, 65	1970-73			REC332816
65	1972-73	3	REC439084 + REC878846	
65	1984-86	3	REC439084	
65	-1987	3	REC39390	
70	1974-85	3	REC439084	

2T
STROKES

		cyl	KIT	
70	-1986	3	REC39390	
70 (814 cc)	1989-01	3		REC329836
70 (913 cc)	1986-01	3		REC329836
75 (814 cc)	1975-89	3		REC878846
75 (814 cc)	1975-78	3		REC332816
75	2004	4	REC5005931	
115,135	1973			REC318358
V4 CROSSFLOW				
85, 88, 90, 100, 110, 115	1978-94			REC318358
85, 88, 90, 110, 115	-1979		REC439085	
E90	2004	4	REC5005931	
100, 115, 140	1978-84		REC439085	
115	1985		REC439085	REC332819
115, 135, 140	1973-78		REC318358	REC318358
E115	2009		REC5007850	
135, 140	1973-84			REC332819
140	1977-84			REC318358
E130	2009		REC5007850	
V4 90° LOOPCHARGED				
120, 140	1985-87		REC396750	REC328623
120, 130, 140	1988-94		REC432570	REC340115
130	1995		REC432570	
V4 60° LOOPCHARGED				
90-115	-1995		REC439559	
90-115 FFI	-1998		REC5000400	
V6 90° CROSSFLOW				
2.6XP-GT	1983-85			REC332818
150	1978-91		REC391988	

		cyl	KIT	
150, 155, 175, 185, 200	1976-85			REC332817
E150	2006		REC5007129	
155	1986-91		REC391988	
175	1977-85		REC391988	
E175	2006		REC5007129	
185	1984-85		REC391988	
200	1976-83		REC391988	
E200	2006		REC5007129	
235	1978-79		REC391988	REC766779 REC332817
175	1986-91		REC434381	REC335361 REC335361
235	1980-85		REC434381	REC332818
V6 60° LOOPCHARGED				
150-175 V6 60°	-1991		REC437155	
V6 90° LOOPCHARGED				
200, 225	1985-87		REC398172	
200, 225	1986-87			REC331211
200, 225	1988-1993		REC436891	REC333670
200, 225, 250	1994-01		REC437725	REC345257
V8 LOOPCHARGED 4L				
250, 275, 300 Special	-1988		REC398693	
250, 275, 300	1988-93			REC340116
300	1993-94			REC340116

JUNTAS BASE DE MOTOR

CYLINDER GASKET

GUARNIZIONE
BASE MOTORE

JOINTS DE TETE MOTRICE

REF	OEM	
REC324717	324717	9.9 - 15 HP (1972-85)



REF	OEM	
REC325721	325721	9.9 - 15 HP (1986+)

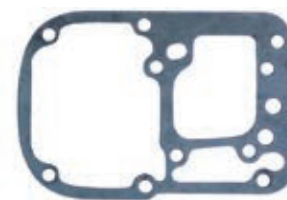

REF	OEM	
REC319710	319710	25, 35 HP (1976-78)

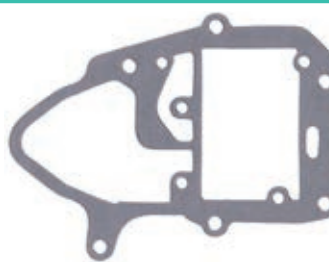

REF	OEM	
REC0330621	330621	25, 35 HP (1979+)

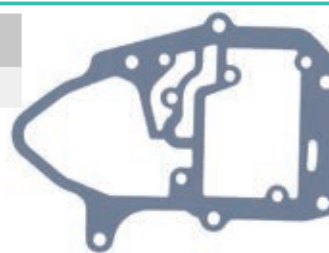

REF	OEM	
REC319348	319348	28, 33, 40 HP



REF	OEM	
REC351018	351018	2 Cyl Loopcharged

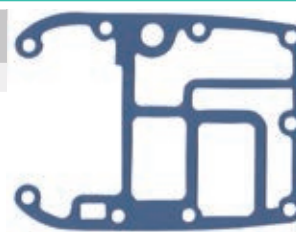

REF	OEM	
REC313763	313763	3 cyl Junta fina Thin gasket guarnizione fina joint fine
REC328618	328618	3 cyl Junta gruesa Thick gasket guarnizione gorda joint grosse



REF	OEM	
REC329828	329828	3 cyl, 60, 70 HP

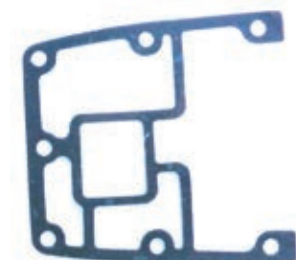

REF	OEM	
REC318373	318373	90° V4 Crossflow (1973-77)

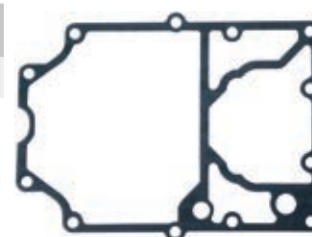

REF	OEM	
REC342513	342513	90° V4 Crossflow (1978-97)

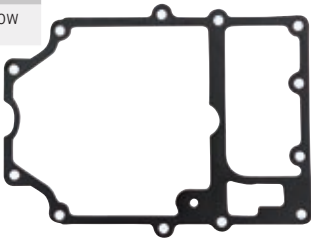

REF	OEM	
REC323214	323214	90° V6 Crossflow

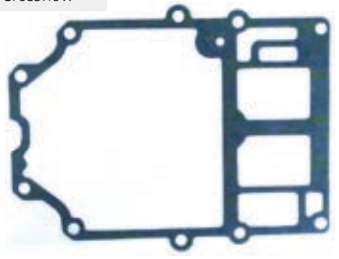

REF	OEM	
REC328590	328590	90° V4 Loopcharged

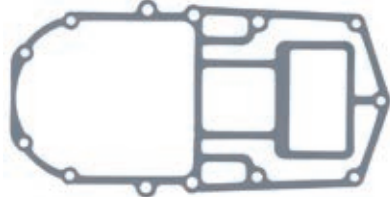

REF	OEM	
REC333879	333879	90° V6 Loopcharged

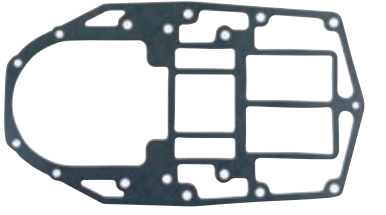

REF	OEM	
REC343853	343853	60° V4 (1997)

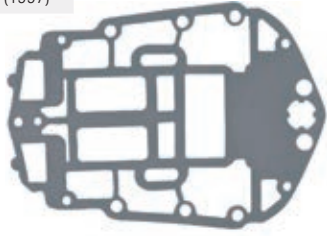

REF	OEM	
REC335419	335419	60° V6

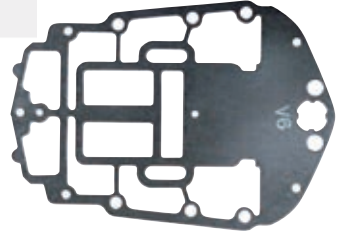

REF	OEM	
REC344386	344386	60° V4 (1988+)

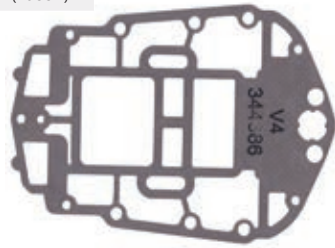

REF	OEM	
REC329975	329975	90° v8 Loopcharged

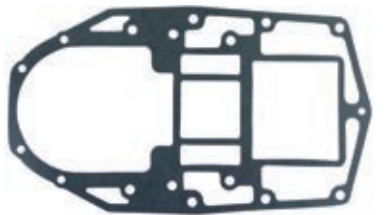



GUÍA
CORREAS DE
DISTRIBUCIÓN

GUIDE
TIMING BELT

GUIDA
CINGHIE DISTRIBUZIONE

GUIDE DES COURROIES
DE DISTRIBUTION

		REF	OEM
J10/J15 HP	69	REC12761-93E0	5033070
J/JJ 60, 70 HP	89	REC12761-72F00	5030660



new

SISTEMA DE ESCAPE Y ADMISIÓN EXHAUST & INTAKE SYSTEM

SISTEMA DI SCARICO E ASPIRAZIONE SYSTEME D'ÉCHAPPEMENT ET D'ADMISSION

SISTEMA DE ESCAPE

EXHAUST SYSTEM

SISTEMA SCARICO

SYSTÈME D'ÉCHAPPEMENT

JUNTAS ESCAPE

GASKETS, EXHAUST

GUARNIZIONE SCARICO

JOINT D'ÉCHAPPEMENT

REF	OEM	
REC802243	313065	5, 5.5, 6 HP

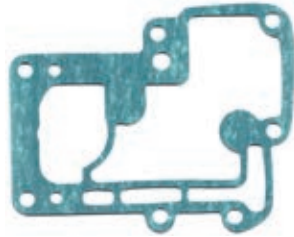

REF	OEM	
REC0326264	326264	2 Cyl Crossflow

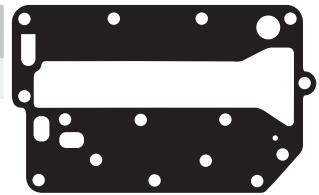

REF	OEM	
REC325211	325211	5, 5.5, 6 HP



REF	OEM	
REC315868	315868	2 Cyl Loopcharged

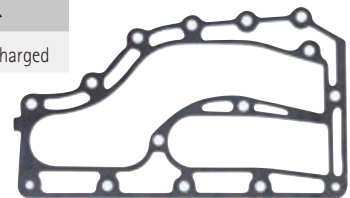

REF	OEM	
REC318925	318925	9.9, 15 HP



REF	OEM	
REC315869	315869	2 Cyl Loopcharged

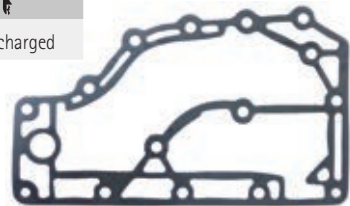

REF	OEM	
REC0324323	3234323	25, 35 HP

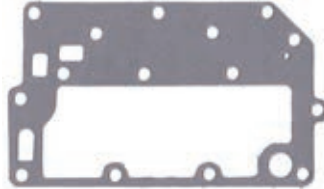

REF	OEM	
REC331916	331916	3 Cyl

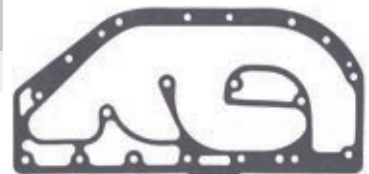

REF	OEM	
REC14212-93J00	5034982	J/BJ200 J/BJ225 (2004-06)

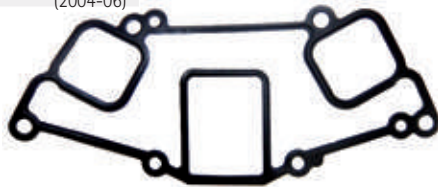

REF	OEM	
REC331917	331917	3 Cyl



REF	OEM	
REC14152-93J00	5034979	J/BJ200 PORT
REC14151-93J00	5034978	J/BJ225 (2004-06) STB

REC14151-93J00



REC14152-93J00





REF	OEM	
REC343863	343863	3 Cyl 60 - 70 HP

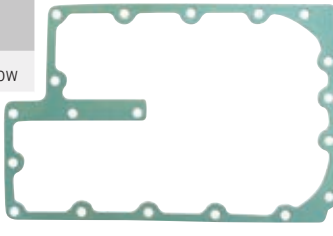

REF	OEM	
REC317955	317955	90° V4 Crossflow





REF	OEM	
REC323469	323469	90° V4 Crossflow

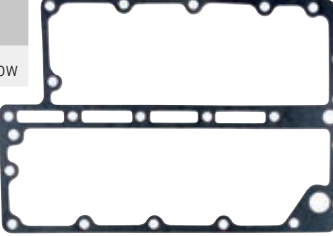

REF	OEM	
REC317914	317914	90° V4 Crossflow



REF	OEM	
REC393561	393561	90° V6 Crossflow, 235 HP



REF	OEM	
REC305176	305176	90° V4 Crossflow

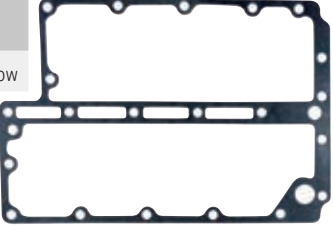

REF	OEM	
REC321182	321182	90° V6 Crossflow





JUNTAS CUERPO DE ESCAPE INTERMEDIAS

INTERMEDIATE HOUSING EXHAUST GASKET

GUARNIZIONE SCARICO ED INTERMEDIE

JOINT D'ÉCHAPPEMENT DU CORPS INTERMÉDIAIRE

REF	OEM	
REC351019	351019	2 Cyl Loopcharged





REF	OEM	
REC329826	329826	2 Cyl Loopcharged



REF	OEM	
REC336308	336308	3 Cyl, 60, 70, HP (1986+)



REF	OEM	
REC331016	331016	3 Cyl (1972-85)





RETENES CUERPO DE ESCAPE

SEALS - HOUSING EXHAUST

PARAOLIO SCARICO

JOINT DU COUVERCLE D'ÉCHAPPEMENT

REF	OEM	
REC320936	320936	V4 - V6



REF	OEM	
REC320961	320961	V4 - V6

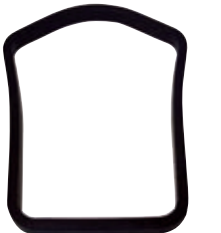

REF	OEM	
REC324937	324937	40 - 75 HP



4T
STROKES

JUNTAS DE CARTER

OIL PAN GASKET

GUARNIZIONE COPPA OLIO

JOINT DE CARTER D'HUILE

REF	OEM	
REC11489-90J00	5033649	J/BJ90 J/BJ115 J/BJ140 (2003-06)

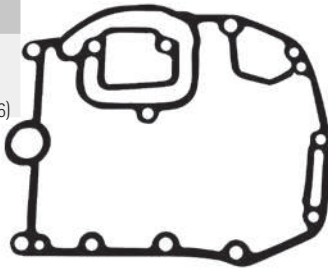

REF	OEM	
REC11489-93E11	5034462	J10 J15 (2004-07)

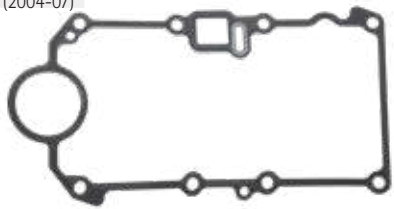

REF	OEM	
REC11489-87J00	5031307	J/BJ 40, 50HP

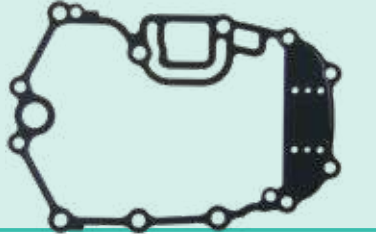

new

REF	OEM	
REC11489-93J00	5034878	J/BJ200 J/BJ225 (2004-06)

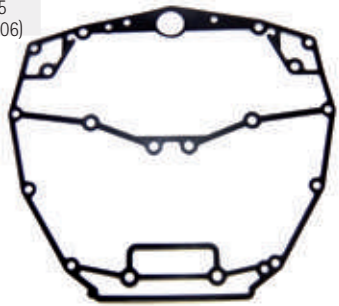

SISTEMA DE ADMISIÓN INTAKE SYSTEM

SISTEMA ASPIRAZIONE SYSTEME D'ADMISSION

JUNTAS TAPA PASO AGUA BLOQUE

POWERHEAD WATER PASSAGE COVER GASKETS

GUARNIZIONI COPERCHIO PASSAGGIO ACQUA

JOINTS DE COUVERCLE DU PASSAGE D'EAU

REF	OEM	
REC350357	342291	60° V4 / V6

Junta base regulador
Regulation mount gasket
Guarnizione base regolatore
Joint base régulateur



REF	OEM	
REC315538	315538	50, 55 HP

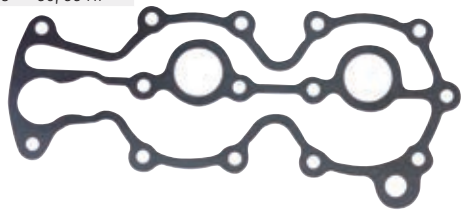

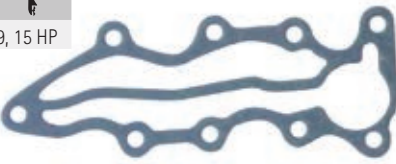

REF	OEM	
REC329920	329920	9.9, 15 HP





REF	OEM	
REC327674	327674	25, 35 HP





REF	OEM	
REC319665	319665	25, 35 HP



REF	OEM	
REC766871	318609	3 Cyl



REF	OEM	
REC318335	318335	V4



JUNTAS CUERPO PALOMILLA A COLECTOR **THROTTLE BODY TO MANIFOLD GASKETS** **GUARNIZIONI CORPO FARFALLA COLLETTORE** **JOINT CORPS DE PAPILLON POUR COLLECTEUR**

REF	OEM	
REC332319	332319	120 - 300 HP (1986+)



JUNTAS TAPA TRANSFERENCIA BABOR MOTORES CROSSFLOW **CROSSFLOW ENGINE POWERHEAD TRANSFER PORT GASKET** **GUARNIZIONI COPERCHIO SINISTRO MOTORI CROSSFLOW** **JOINT DE COUVERCLE DE TRANSFERT POUR MOTEURS CROSSFLOW**

REF	OEM	
REC319332	319332	9.9, 15 HP



REF	OEM	
REC307133	307133	90° V4



REF	OEM	
REC0319661	319661	25, 35 HP

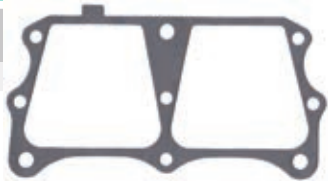

JUNTAS DE CARBURADOR A COLECTOR ADMISION **CARBURETOR TO INTAKE MANIFOLD GASKETS** **GUARNIZIONI INTERMEDIA CARBURATORE - COLLETTORE ASPIRAZIONE** **JOINT DU CARBURATEUR AU COLLECTEUR D'ADMISSION**

REF	OEM	
REC325092	325092	20 - 75 (1980+)



REF	OEM	
REC318932	318932	6 - 30 (1975+)



REF	OEM	
REC327707	327707	V4 / V6



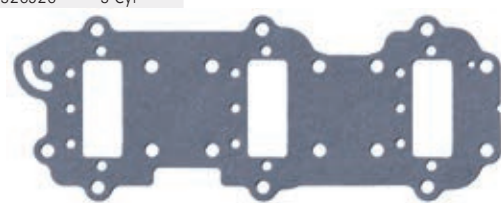

REF	OEM	
REC326926	326926	3 Cyl

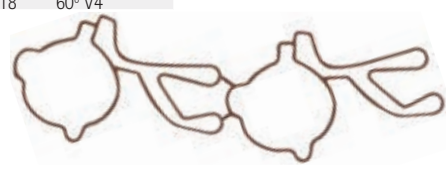

JUNTAS DE ADMISION BABOR A CARBURADOR **PORT INTAKE TO CARBURATOR GASKETS** **GUARNIZIONI ASPIRAZIONE SINISTRA - CARBURATORE** **JOINT DU CARTER D'ADMISSION GAUCHE AU CARBURATEUR**

REF	OEM	
REC335818	335818	60° V4





REF	OEM	
REC335403	335403	60° V6

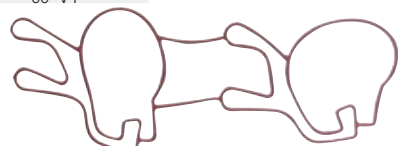

JUNTAS DE ADMISION ESTRIBOR A CARBURADOR **STB INTAKE TO CARBURATOR GASKETS** **GUARNIZIONI ASPIRAZIONE DISTRA - CARBURATORE** **JOINT DU CARTER D'ADMISSION DROIT AU CARBURATEUR**

REF	OEM	
REC335819	335819	60° V4



REF	OEM	
REC335404	335404	60° V6



JUNTAS CAJA LENGÜETA REED BOX GASKETS GUARNIZIONE PIASTRA JOINT DE PLAQUE

REF	OEM	
REC332266	332266	90° V4, V6 Loopcharged



JUNTAS BASE LENGÜETA REED PLATE GASKETS GUARNIZIONE PIASTRA JOINT DE PLAQUE

REF	OEM	
REC318924	318924	9.9, 15 HP



REF	OEM	
REC325260	325260	9.9, 15 HP



REF	OEM	
REC0321479	321479	25, 35 HP





REF	OEM	
REC0326260	326260	25, 35 HP



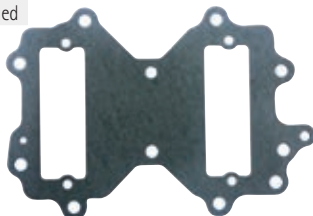

JUNTAS COLECTOR GASKET, COLLECTOR GUARNIZIONE COLLETTORE JOINT DE COLLECTEUR

REF	OEM	
REC315578	315578	2 Cyl Loopcharged

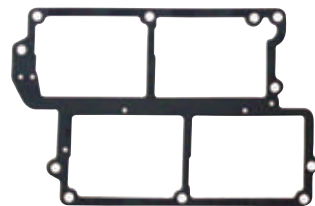

REF	OEM	
REC319174	319174	90° V4



REF	OEM	
REC335633	335633	2 Cyl Loopcharged



REF	OEM	
REC328622	328622	90° V4 / V6 Loopcharged

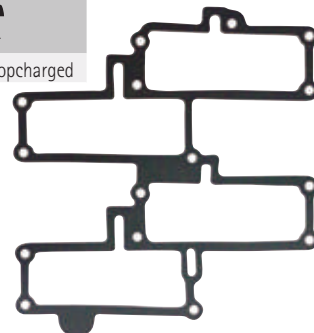

REF	OEM	
REC13122-95J00	5036852	J/BJ 25 (2006-07)



REF	OEM	
REC336388	336388	60° V4
REC336289	336389	60° V4

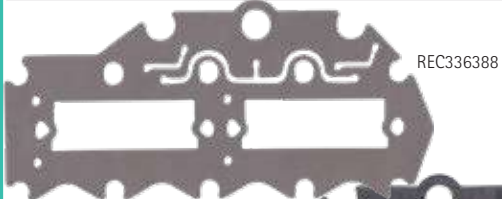

REC336388

REF	OEM	
REC13119-93J00	5034959	J/BJ 200 J/BJ 225 (2004-06)



REC336289



REF	OEM	
REC329718	329718	90° V6 Crossflow



REF	OEM	
REC336226	336226	60° V4 Babor Port Babordo Babord

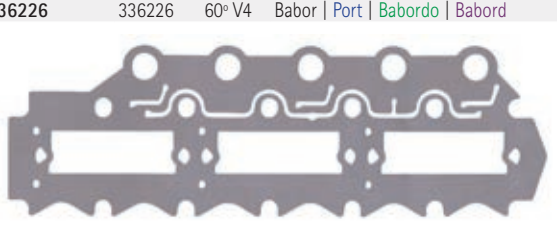

REF	OEM	
REC331532	331532	90° V6 Loopcharged

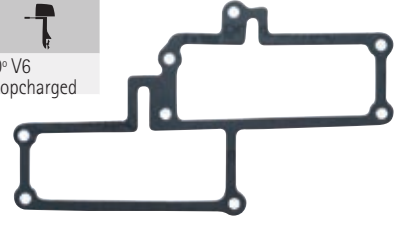



REF	OEM	
REC336227	336227	60° V6 Estribor STB Tribordo Tribord

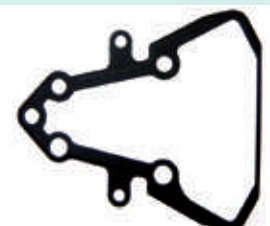

JUNTAS BASE RETÉN	GASKET, MOUNT OIL SEAL COVER	GUARNIZIONE, BASE PARAOLIO	JOINT DE COUVERCLE D'HUILE						
<table border="1"> <thead> <tr> <th>REF</th> <th>OEM</th> <th></th> </tr> </thead> <tbody> <tr> <td>REC51123-93J00</td> <td>5035133</td> <td>J/BJ 200 J/BJ 225 (2004-06)</td> </tr> </tbody> </table>	REF	OEM		REC51123-93J00	5035133	J/BJ 200 J/BJ 225 (2004-06)			
REF	OEM								
REC51123-93J00	5035133	J/BJ 200 J/BJ 225 (2004-06)							

JUNTAS, GUÍA CADENA	GASKET TIMING CHAIN GUIDE BASE	GUARNIZIONE CARTER CATENA	JOINT DU GUIDE DE DISTRIBUTION						
<table border="1"> <thead> <tr> <th>REF</th> <th>OEM</th> <th></th> </tr> </thead> <tbody> <tr> <td>REC12778-93J00</td> <td>5034916</td> <td>J/BJ 200 J/BJ 225 (2004-06)</td> </tr> </tbody> </table>	REF	OEM		REC12778-93J00	5034916	J/BJ 200 J/BJ 225 (2004-06)			
REF	OEM								
REC12778-93J00	5034916	J/BJ 200 J/BJ 225 (2004-06)							

JUNTAS BOMBA DE ACEITE	GASKET OIL PUMP GALLERY	GUARNIZIONE POMPA D'OLIO	JOINT POMPE D'HUILE												
<table border="1"> <thead> <tr> <th>REF</th> <th>OEM</th> <th></th> </tr> </thead> <tbody> <tr> <td>REC16433-93J00</td> <td>5035022</td> <td>J200 / BJ200 4225 / BJ225 (2004-06)</td> </tr> </tbody> </table>	REF	OEM		REC16433-93J00	5035022	J200 / BJ200 4225 / BJ225 (2004-06)		<table border="1"> <thead> <tr> <th>REF</th> <th>OEM</th> <th></th> </tr> </thead> <tbody> <tr> <td>REC17693-95J00</td> <td>5036914</td> <td>J/BJ 25 (2006-07)</td> </tr> </tbody> </table>	REF	OEM		REC17693-95J00	5036914	J/BJ 25 (2006-07)	
REF	OEM														
REC16433-93J00	5035022	J200 / BJ200 4225 / BJ225 (2004-06)													
REF	OEM														
REC17693-95J00	5036914	J/BJ 25 (2006-07)													

JUNTAS SILENCIADOR

AIR SILENCER GALLERY

GUARNIZIONE MARMITA

JOINT DU SILENCIEU

REF	OEM	
REC338882	338882	5 - 35 HP



REF	OEM	
REC314115	314115	70, 75 HP



REF	OEM	
REC323338	323338	25, 35 HP



REF	OEM	
REC386573	386573 319771	85 - 140 HP



REF	OEM	
REC330689	330698	35 - 55 HP



REF	OEM	
REC333008	333008	3 Cyl



REF	OEM	
REC330909	330909	35 - 55 HP



REF	OEM	
REC321794	3214794	3 Cyl



REF	OEM	
REC321497	321497	40 - 60 HP



REF	OEM	
REC321722	3214722	V4

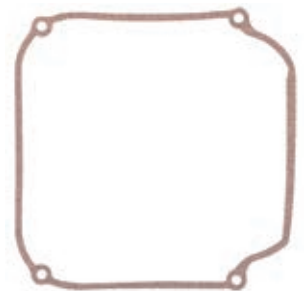

REF	OEM	
REC320679	320679	40 - 60 HP

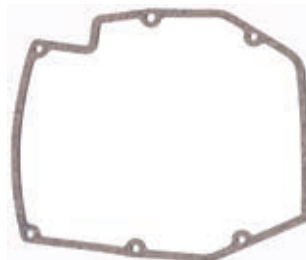

RETENES DE ACEITE

OIL SEALS

PARAOLIO



JOINT SPI



RETÉN DE ACEITE



OIL SEAL



PARAOLIO



JOINT SPI



REF	OEM		
REC09282-10008	5030107	E5 / J5 J4 / J6 (1998-07)	



REF	OEM		
REC09282-12008	5030108	E5 / J5 J4 / J6 (1998-07)	



REF	OEM		
REC09282-12010	5033011	J10 J15 (2002-07)	



REF	OEM		
REC09282-17009	5031266	E25 / J 25 E40 / J40 E50 / J50 E30 / J50 (1999-07)	



REF	OEM		
REC09282-15008	5036938	J/BJ25 (2006-07)	



REF	OEM		
REC09283-20018	5030110	E5 / J5 (1998-01)	



REF	OEM		
REC09282-17005	5031264	E40 / J40 / BJ40 E50 / J50 / BJ50 (1999-06)	



REF	OEM		
REC09283-20045	5030111	E5 / J5 (1998-01)	



REF	OEM		
REC09283-10003	5030109	E5 / J5 (1998-01)	

REF	OEM		
REC09283-25076	5033481	J4 / J5 / J5 (2003-06)	

REF	OEM		
REC09283-10009	5033339	J4 / J5 / J6 (2003-07)	

REF	OEM		
REC09289-17006	5033015	J10 J15 (2002-07)	

REF	OEM		
REC09289-20009	5031893	E25 / J25 / BJ25 E30 / J30 / BJ30 (2000-07)	



REF	OEM		
REC09289-22007	5031270	E40 / J40 / BJ40 E50 / J50 / BJ50 (1999-06)	

JUNTA TAPÓN DE DRENAJE

O-RING DRAIN CAP

GUARNIZIONE TAPPO DRENAGGIO

JOINT DE VIDANGE

REF	OEM		
REC09168-10022	5030071	4 - 140 HP	10 x 17 x 1.5 mm

new

JOHNSON EVINRUDE

RECAMBIOS MARINOS

UNIDADES DE TRANSMISIÓN UNIT DRIVES & COMPONENTS

UNITÀ DI TRASMISSIONE EMBASES ET PIÈCES

COLA

GEARCASE ASSY

PIEDI

EMBASE

2 & 3 CYL. LOOPCHARGED

Cola pequeña estilo "antiguo"
(1975-88)
Altura: 15-1/2".
Final de la aleta de cavitación afilado.
Seis agujeros sobre la aleta de cavitación. Tomas internas de agua (cuatro agujeros). Sin tubo corredera.

Small Gearcase "Old" Style
(1975-88)
15-1/2" tall.
Pointed at the trailing end of the cavitation plate. Six holes above the cavitation plate. Internal water intake screens (four holes). No speedo pitot.

Piede vecchia generazione
(1975-88)
Altezza:15-1/2".
Terminale pinna di cavitazione sottile.
Sei fori nella pinna, e prese d'acqua a 4 fori.
Senza tubo scorrevole.

Petite embase ancienne génération
(1975-88)
Hauteur : 15-1 / 2".
Fin d'aileron de cavitation pointu. Six trous sur l'aileron de cavitation. Prises d'eau internes (quatre trous). Sans tube coulissant

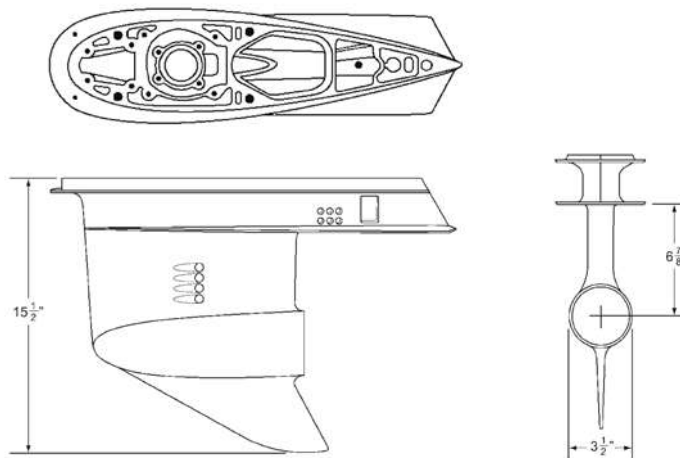

Cola pequeña estilo "moderno"
(1989-05)
Altura: 15-3/5".
Final de la aleta de cavitación afilado
Seis agujeros sobre la aleta de cavitación
Tomas externas de agua
Con tubo corredera

Small Gearcase "New" Style
(1989-05)
15-3/2" tall.
Pointed at the trailing end of the cavitation plate.
Six holes above the cavitation plate.
External water intake screens.
Includes speedo pitot.

Piede moderna generazione
(1989-05)
Altezza:15-3/5".
Terminale pinna di cavitazione sottile.
Sei fori nella pinna, e prese d'acqua a 4 fori.
Senza tubo scorrevole.

Petite queue de style "moderne"
(1989-05)
Hauteur : 15-3 / 5".
Fin d'aileron de cavitation conique
Six trous sur l'aileron de cavitation
Prises d'eau extérieures
Avec tube de speedo

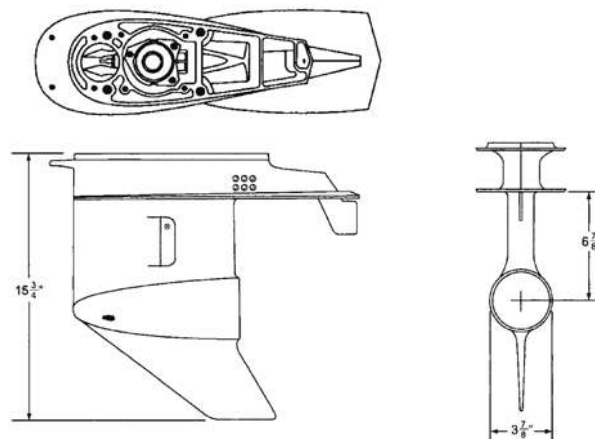

Cola larga (1975-06)
 Altura: 17-7/16"
 Final de la aleta de cavitación afilado
 Seis agujeros sobre la aleta de cavitación
 Tomas internas de agua (tres agujeros)
 Sin tubo corredera

Large Gearcase (1975-06)
 17-7/16" tall.
 Pointed at the trailing end of the cavitation plate.
 Six holes above the cavitation plate.
 Internal water intake screens (three holes).
 No speedo pitot.

Piede lungo (1975-06)
 Altezza: 17-7/16".
 Terminale pinna di cavitazione sottile.
 Sei fori nella pinna, e prese d'acqua a 4 fori.
 Senza tubo scorrevole.

Embase longue (1975-06)
 Hauteur : 17-7/16".
 Fin d'aileron de cavitation conique
 Six trous sur l'aileron de cavitation
 Prises d'eau internes (trois trous)
 Sans tube speedo

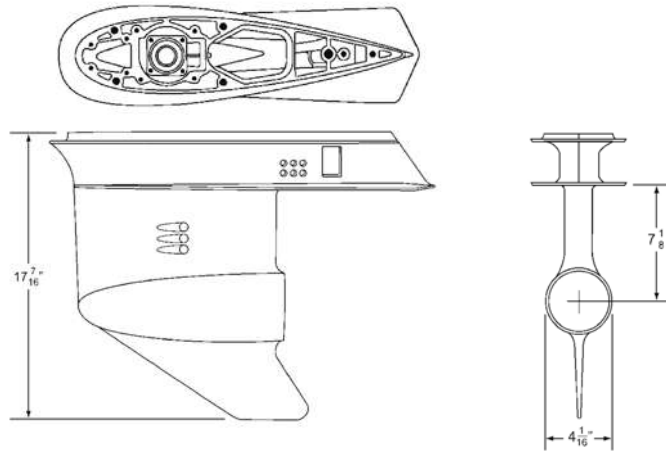

V4 90°

Cola pequeña (1978-98)
 Altura: 18-3/16"
 Final de la aleta de cavitación afilado
 Seis agujeros sobre la aleta de cavitación
 Tomas internas de agua (cuatro agujeros)
 Sin tubo corredera

Small Gearcase (1978-98)
 18-3/16" tall.
 Pointed at the trailing end of the cavitation plate.
 Six holes above the cavitation plate.
 Internal water intake screens (four holes).
 No pitot.

Piede vecchia (1978-98)
 Altezza: 18-3/16".
 Terminale pinna di cavitazione sottile.
 Sei fori nella pinna, e prese d'acqua a 4 fori.
 Senza tubo scorrevole.

Petite embase (1978-98)
 Hauteur : 18-3/16".
 Fin d'aileron de cavitation conique
 Six trous sur l'aileron de cavitation
 Prises d'eau internes (quatre trous)
 Sans tube de speedo

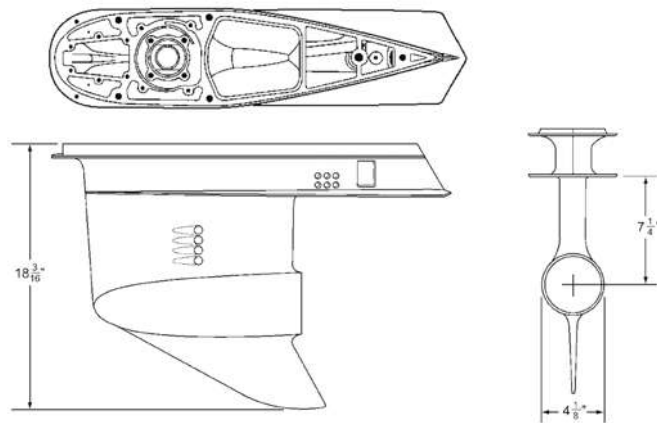

V4 60°

Cola pequeña (1995-06)
 Altura: 19-1/16"
 Final de la aleta de cavitación plano
 Dos ranuras sobre la aleta de cavitación
 Tomas externas de agua.

Small Gearcase (1995-06)
 19-1/16" tall.
 Flat at the trailing end of the cavitation plate.
 Two slots above the cavitation plate.
 External water intake screens.

Piede vecchia (1995-06)
 Altezza: 19-1/16".
 Terminale pinna di cavitazione piano.
 Due fessure sopra la pinna di cavitazione.
 Prese d'acqua esterne.

Petite embase (1995-06)
 Hauteur : 19-1/16".
 Finition d'aileron à cavitation plate
 Deux rainures sur l'aileron de cavitation
 Prises d'eau extérieures

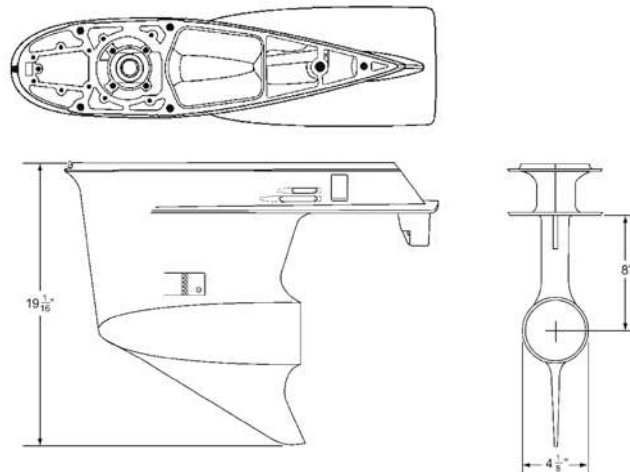

V4 / V6

Cola larga "O" (1979-06)
 Altura: 19-3/16"
 Final de la aleta de cavitación afilado
 Dos ranuras sobre la aleta de cavitación
 Tomas externas de agua

Large Gearcase "O" type (1979-06)
 19-3/16" tall.
 Pointed at the trailing end of the cavitation plate.
 Two slots above the cavitation plate.
 External water intake screens.

Piede lungo "O" (1979-06)
 Altezza: 19-3/6"
 Terminale pinna di cavitazione sottile.
 Due fessure sopra la pinna di cavitazione.
 Prese d'acqua esterne.

Embase longue "O" (1979-06)
 Hauteur : 19-3/16"
 Fin d'aileron de cavitation conique
 Deux rainures sur l'aileron de cavitation
 Prises d'eau extérieures

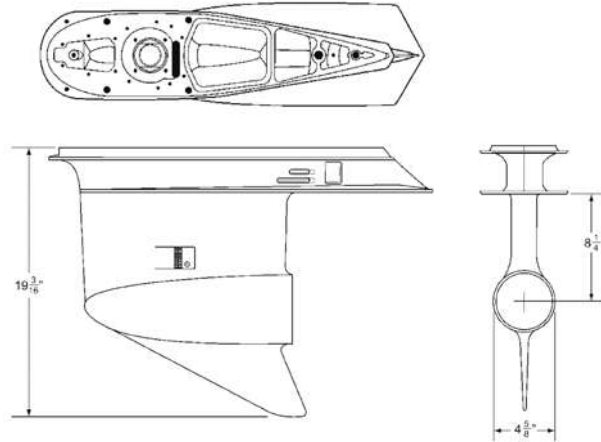

Cola larga "M" (2002-06)
 Altura: 19-3/16"
 Final de la aleta de cavitación plano
 Tres ranuras sobre la aleta de cavitación
 Tomas externas de agua
 Con tubo corredera

Large Gearcase "M" type (2002-06)
 19-3/16" tall.
 Flat at the trailing end of the cavitation plate.
 Three slots above the cavitation plate.
 External water intake screens.
 Includes speedo pitot.

Piede lungo "M" (2002-06)
 Altezza: 19-3/6"
 Terminale pinna di cavitazione sottile.
 Due fessure sopra la pinna di cavitazione.
 Prese d'acqua esterne.
 Con tubo scorrevole.

Embase longue "M" (2002-06)
 Hauteur : 19-3/16"
 Finition d'aileron à cavitation plate
 Trois rainures sur l'aileron de cavitation
 Prises d'eau extérieures
 Avec tube de speedo

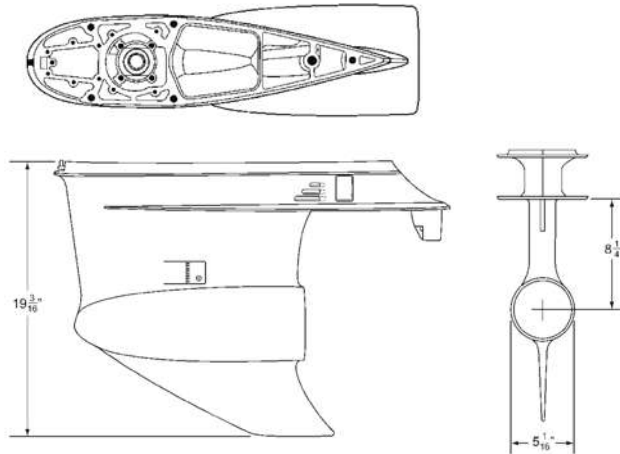

COLA COMPLETA

GEARCASE ASSY

PIEDE COMPLETO

EMBASE COMPLÈTE

REF	OEM	
REC0435279	435279 1993+	20" 40, 48, 50 HP



CARCASA	EMPTY GEARCASE	CARCASSA	CARTER
---------	----------------	----------	--------

REF	OEM	REDUCCIÓN GEAR RATIO RIDUZIONE REDUCTION	
REC5007022	439972 438048	2.25:1 (.44), 12:27	V4 (1978-06) Crossflow (1983-96) 60° Loopcharged (1995-98) 90° Loopcharged (1985-98) V6 (1978-06)
		1.83:1 (.55), 12:22 Heavy Duty	Crossflow (1979-92) 60° Loopcharged (1991-05) 90° Loopcharged (1986-05)



Sin tubo corredera
Without speedo.
Senza tubo scorrevole.
Sans tube de speedo

REF	OEM	REDUCCIÓN GEAR RATIO RIDUZIONE REDUCTION	
REC439973	439973	1.83:1 (.55), 12:22 Heavy Duty	V6 (1978-06) Crossflow (1979-92) 60° Loopcharged (1991-01) 90° Loopcharged (1986-01)



Con tubo corredera
With speedo.
Con tubo scorrevole.
Avec tube de speedo

GUÍA DE COLAS	GEARCASE GUIDE	GUIDA PIEDE	GUIDE D'EMBASES
---------------	----------------	-------------	-----------------

	COMPLETA ASSY COMPLETE	CARCASA GEARCASE EMPTY CARCASSA CARTER		COMPLETA ASSY COMPLETE	CARCASA GEARCASE EMPTY CARCASSA CARTER
40 15"	93	REC0435279	V4 60° Loopcharged 25"	1995-06	REC5007022
48 15"	93	REC0435279	V6 60° Loopcharged 20" w/ External Screens	1995-00	REC5007022
50 15"	93	REC0435279	V6 60° Loopcharged 25" w/ External Screens	1991-99	REC5007022
100 WPL 20"	1999	REC5007022	V6 60° Loopcharged 25" C/R	1992-99	REC5007022
100 WPX 25"	1999	REC5007022	150 Comm. 20"	1993-99	REC5007022
100 Comm. 20" Large	1988-97	REC5007022	150 Comm. 25"	1993-99	REC5007022
100 Comm. 25" Large	1988-97	REC5007022	155 Comm. 20"	1988-92	REC5007022
100 WQX, 105 WEX 25"	1998	REC5007022	155 Comm. 25"	1988-92	REC5007022
105 Comm. WPL 20"	2000-01	REC5007022	V6 Crossflow 20" Et 90° Loopcharged	88-91	REC439973
105 Comm. WPX 25"	2000-01	REC5007022	V6 Crossflow 25" Et 90° Loopcharged	88-91	REC439973
105 Comm. WEL 20"	2000-01	REC5007022	V6 Crossflow 20" Et 90° Loop- charged C/R	88-91	REC439973
105 WEL 20"	1998	REC5007022	V6 90° Loopcharged 20" w/ Internal Screens	92-99	REC439973
105 WRL 20"	1997-98	REC5007022	V6 90° Loopcharged 20" w/ External Screens	92-99	REC5007022
105 WRX 25"	1997-98	REC5007022	V6 90° Loopcharged 25"	92-99	REC5007022
105 RWL 20"	1998	REC5007022	V6 90° Loopcharged 25" C/R	92-99	REC5007022
105 RWY 22.5"	1998	REC5007022	V6 90° Loopcharged 30"	93-99	REC5007022
105 RWX 25"	1998	REC5007022	V6 90° Loopcharged 30" C/R	93-99	REC5007022
115 FPX/FX 25"	2000-01	REC5007022	200 Comm. 20"	93-99	REC5007022
125 RWL 20"	1995-97	REC5007022	200 Comm. 25"	93-99	REC5007022
125 RWY 22.5"	1995-98	REC5007022			
125 WTPL 20"	1992-98	REC5007022			
125 WTPX 25"	1988-98	REC5007022			
130 20"	1995-98	REC5007022			
130 25"	1995-98	REC5007022			
130 25" C/R	1995-97	REC5007022			
135 FPL/FL 20"	2000-01	REC439973			
135 FSL/FS 20"	2000-01	REC5007022			
135 FPX/FX 25"	2000-01	REC5007022			
140 25"	1988-94	REC5007022			
140 25" C/R	1988-94	REC439973			

JOHNSON EVINRUDE



HERRAMIENTAS

TOOLS

ATTREZZI

OUTILS

EXTRACTOR COJINETES Y HÉLICES

PROP AND BEARING PULLER

ESTRATTORE CUSCINETTI E ELICHE

EXTRACTEUR DE ROUEMENTS D'HELICE

REF

REC90095



Para hélices y cojinetes antiguos
For prop and old style bearing carrier.
Per eliche e cuscinetti vecchi.
Pour hélices et roulements anciens

Para cojinetes modernos
For new style bearing carrier.
Per cuscinetti moderni.
Pour roulements récents.

EXTRACTOR COJINETES

BEARING PULLER

ESTRATTORE CUSCINETTI

EXTRACTEUR DE ROUEMENTS

REF

REC91-34569A1



Para utilizar con las herramientas REC91-43579 y REC91-36569T para instalar y desmontar el cojinete

Used with REC91-43579 & REC91-36569T tools to install & remove pinion bearing.

Da utilizzare con gli strumenti REC91-43579 e REC91-36569T per installare e smontare il cuscinetto.

A utiliser avec les outils REC91-43579 et REC91-36569T pour installer et retirer le roulement

REF

REC91-31229



EXTRACTOR PIÑONES Y COJINETES

UNIVERSAL PULLER PLATE

ESTRATTORE PIGNONE E CUSCINETTI

EXTRACTEUR PIGNONS ET ROUEMENTS

REF

PIÑONES
BEARINGS
PIGNONE
PIGNONS

REC91-00001 30-50 mm / 1^{1/4}" - 2^{1/4}"

REC91-00002 50-75 mm / 2^{1/4}" - 3^{1/2}"

REC91-37241 75-105 mm / 3" - 4^{1/2}"



KIT HERRAMIENTAS PARA COLAS

GEAR CASE TOOL KIT

KIT ATTEZZI PIEDI

KIT OUTILS POUR EMBASES

REF

RM91-31229A7

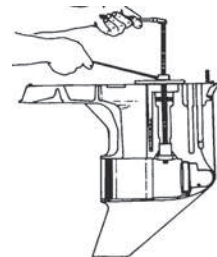

LLAVE TUERCA DIÁBOLO

BEARING CARRIER RETAINER WRENCH

CHIAVE PER CUSCINETTO

CLE POUR ECROU DE DIABOLO

REF

REC91-61069T

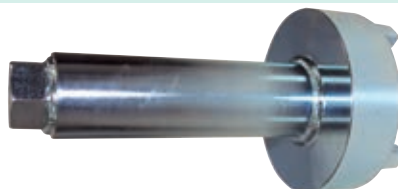

KIT LLAVE HÉLICE

PROP WRENCH KIT

KIT CHIAVE ELICA

CLE POUR ECROU D'HELICE

REF



REC91-859046Q4 1 1/16" 75 - 300 HP



RECMAR

FLOTANTE | FLOATING | GALLEGGIANTE | FLOTTANTE

REF



REC91-859046Q3 15/16" 30, 40, 50 Et 60 HP

RECMAR



new

LLAVE TUERCA EJE VERTICAL

PINION NUT ADAPTOR KIT

CHIAVE DADO ASSE VERTICALE

CLE POUR ARBRE VERTICAL

Incluye un adaptador eje. Sostiene la tuerca del piñón cuando se está sacando el piñón y el eje en las colas.

Holds pinion nut when removing pinion gear and drive shaft on drive units. Comes with drive shaft adaptor.

Incluye un adattatore albero. Tenendo il dado del pignone quando si rimuove la ruota dentata e l'albero nel piede.

Inclus un adaptateur d'arbre. Maintient l'écrou du pignon lors de la dépose du pignon et de l'axe sur les embases.

REF

RECMAR

REC91-61067A04



HERRAMIENTAS VOLANTE MOTOR

FLYWHEEL PULLER

ESTRATTORE VOLANO

EXTRACTEUR DE VOLANT MOTEUR

REF



2T STROKES 4T STROKES

REC90890-06820 40, 45, 50, 60HP (4 CYL) 75, 90, 115 (-1B366822) ✓



RECMAR

REF



2T STROKES 4T STROKES

REC91-895343T02 75-115HP (1B366823+) VERADO 135 - 300HP 150EFI ✓



RECMAR

new

- 1 Adaptador universal de elevacion para motores
- 2 Extractor de volante
- 3 Se adapta directamente en volantes Yamaha y Mercury que no contienen anillos de elevación integrados. (Se suministra con tornillos)
- 4

- Universal lift adapter for motors
- Flywheel puller
- Fits directly on Yamaha and Mercury flywheels that do not contain integrated lift rings. (Supplied with screws)
-

- Adattatore di sollevamento universale per motori
- Estrattore volano
- Si adatta direttamente ai volani Yamaha e Mercury che non contengono anelli di sollevamento integrati. (Fornito con viti)
-

- Adaptateur de levage universel pour moteurs
- Extracteur de volant
- S'adapte directement sur les volants d'inertie Yamaha et Mercury qui ne contiennent pas d'anneaux de levage intégrés. (Fourni avec des vis)
-



1.5"

DESPIECE COLAS
4 TIEMPOS

GEAR CASE PARTS
4 STROKES

PARTI PIEDI
DE 4 TEMPI

PIECES D'EMBASES
4 TEMPS

4T J4, J5, J6 HP
STROKES

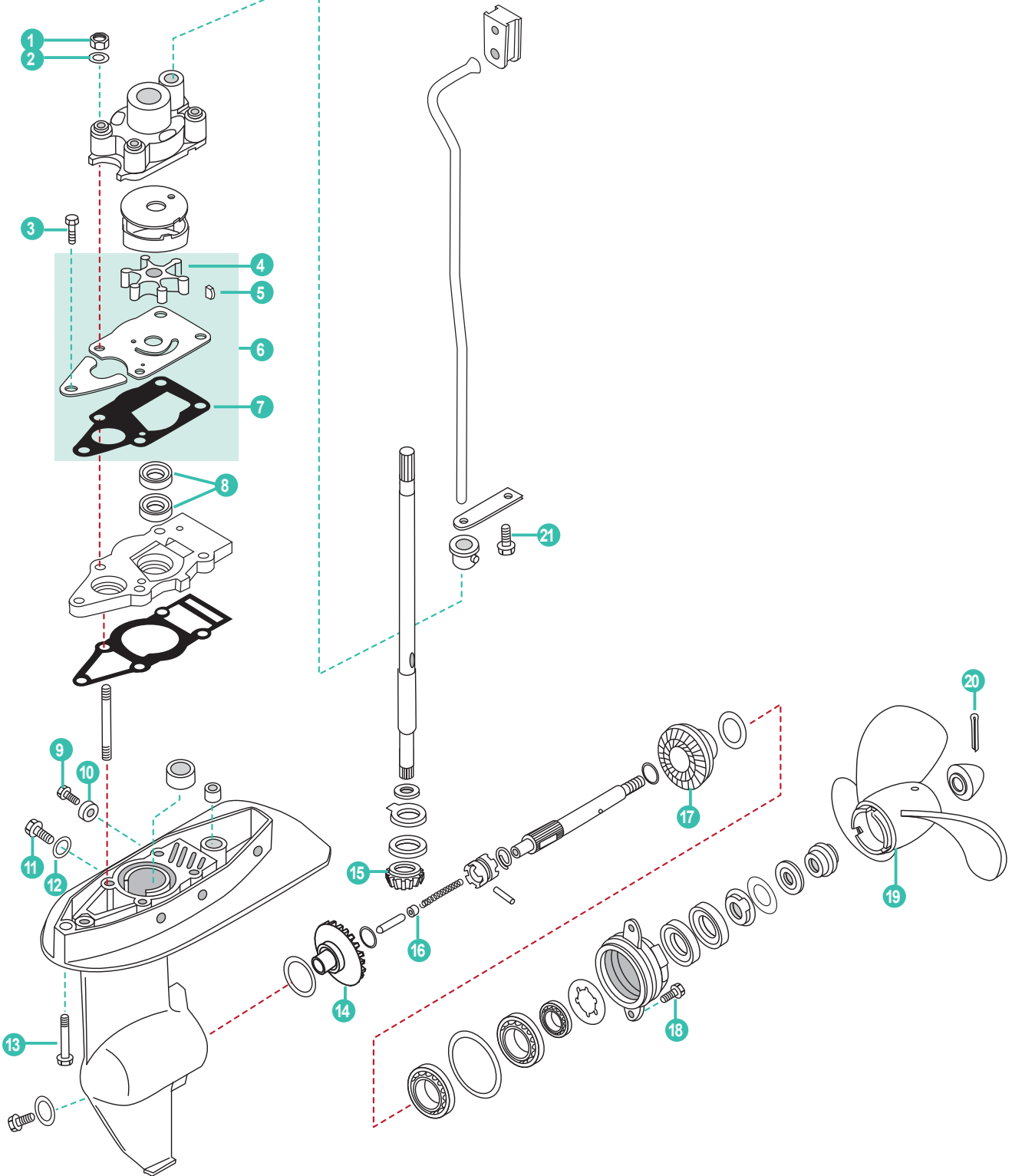

	REF	OEM				
1	PAGB/T6170-M6	5030051	TUERCA HEXÁGONO M6	NUT HEXAGON M6	DADO ESAGONALE M6	ECROU HEXAGONAL M6
2	PAGB/T848-6	530429	ARANDELA	WASHER	RONDELLA	RONDELLE
3	PAGB/T5283-M6X25	5030391	TORNILLO HEXAGONAL M6x25	HEXAGON BOLT M6x25	BULLONE ESAGONALE M6x25	BOULON HEXAGONAL M6x25
4	REC17461-98503	5030188	IMPULSOR	IMPELLER	GIRANTE	TURBINE
5	REC09420-03002	5030137	CHAVETA IMPELLER	KEY	CHIUSURA	CLAVETTE TURBINE
6	REC17400-98661	5034323	KIT BOMBA AGUA	WATER PUMP KIT	KIT POMPA ACQUA	KIT POMPE À EAU
7	REC17472-91J00	5033381	JUNTA DE LA BOMBA	GASKET PUMPCASE	GUARNIZIONE POMPA	JOINT DE POMPE
8	REC09282-10008	5030107	RETÉN ACEITE	OIL SEAL	PARAOLIO	JOINT SPI
9	PAGB/T5783-M6X14	5036691	TORNILLO HEXAGONAL M6x14	HEXAGON BOLT M6x14	BULLONE ESAGONALE M6x14	BOULON HEXAGONAL M6x14
10	REC55321-87J01AL	5031705	ÁNODO	ANODE	ANODO	ANODE
11	REC09248-10008	5030094	TORNILLO 10x7,5	SCREW 10x7,5	VITE 10x7,5	VIS 10x7,5
12	REC09168-10022	5030071	ARANDELA TAPÓN	CAP, O-RING	RONDELLA TAPPO	JOINT DE VIDANGE
13	PAGB/T5787-1986	5031822	TORNILLO HEXAGONAL M8x50	HEXAGON BOLT M8x50	BULLONE ESAGONALE M8x50	BOULON HEXAGONAL M8x50
14	REC57510-91J00	5034203	PIÑÓN MARCHA AVANTE	FORWARD GEAR	INGRANAGGIO MARCIA AVANTI	PIGNON MARCHE AV
15	REC57311-98600	5030276	PIÑÓN ATAQUE	INITIATIVE GEAR	PIGNONE	PIGNON D'ATTAQUE
16	REC57632-97L00	5030282	PIN SELECTOR	SELECTOR PIN	PIN SELETTORE	CLAVETTE
17	REC57521-91J00	5030278	PIÑÓN MARCHA ATRÁS	RESERVE GEAR	PIGNONE MARCIA INDIETRO	PIGNON MARCHE AR
18	PAGB/T5783-M6X16	5030035	TORNILLO HEXAGONAL M6x16	HEXAGON BOLT M6x16	BULLONE ESAGONALE M6x16	BOULON HEXAGONAL M6x16
19	SOL4011-079-07S	5034345	HELICE AMITA 3 7.9x6.75	PROPELLER AMITA 3 7.9x6.75	ELICA AMITA 3 7.9x6.75	HELICE AMITA 3 7.9x6.75
20	REC91490-30025	5030087	PASADOR	PIN	FERMO	GOUPILLE
21	PAGB/T5783-M6X16	5030035	TORNILLO HEXAGONAL M6x16	HEXAGON BOLT M6x16	BULLONE ESAGONALE M6x16	BOULON HEXAGONAL M6x16



REC80W90U3
REC80W90U6
RECGREU1
RECGREU12

P. 43

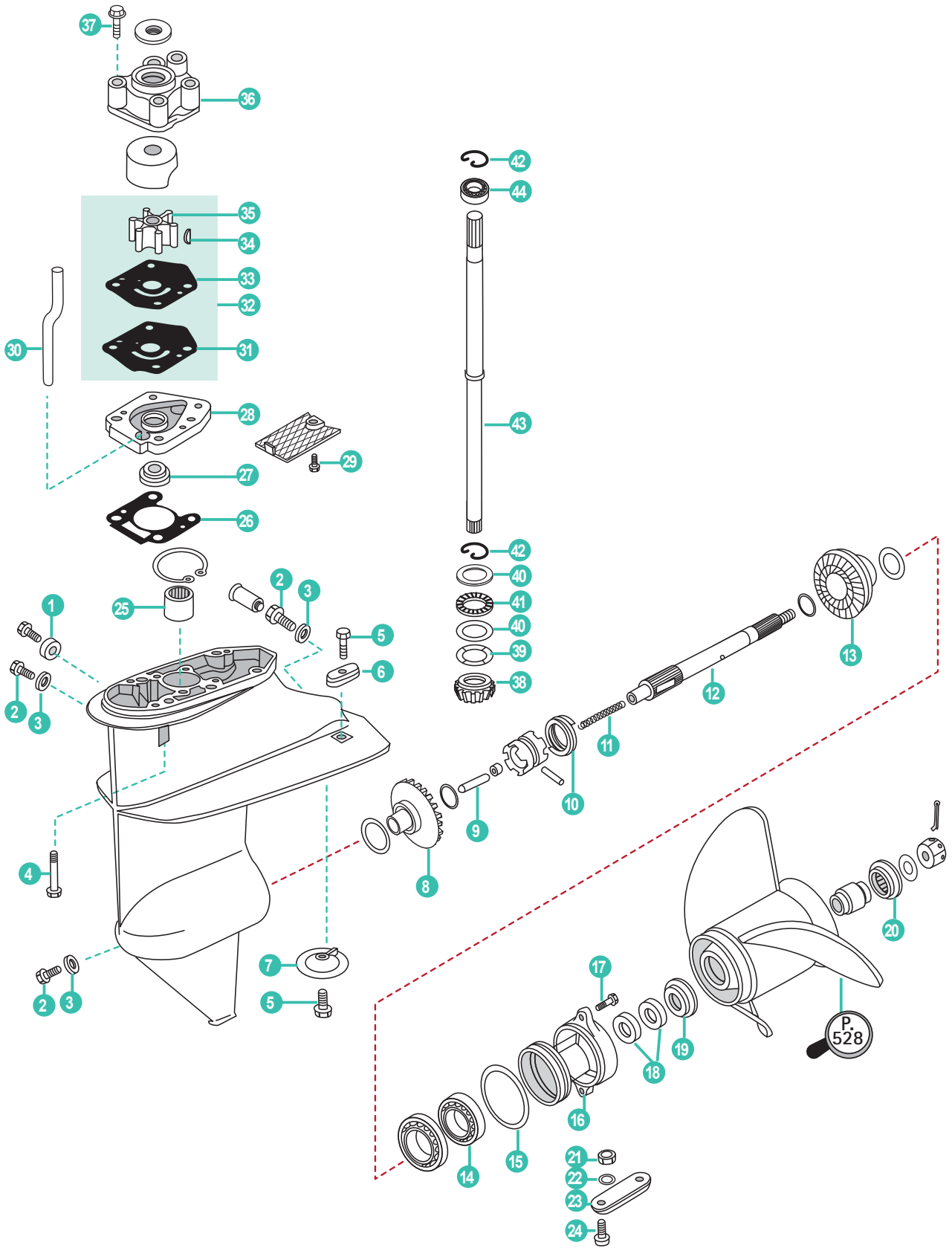

	REF	OEM				
1	CM55321-87J00	5031705	ÁNODO	ANODE	ANODO	ANODE
2	REC09248-10008	5030094	TORNILLO 10x7,5	SCREW 10x7,5	VITE 10x7,5	VIS 10x7,5
3	REC09168-10022	5030071	ARANDELA TAPÓN	CAP, O-RING	RONDELLA TAPPO	JOINT DE VIDANGE
4	PAGB/T5783-M8X30	5031216	TORNILLO M8X30	BOLT M8X30	BULLONE M8X30	BOULON M8X30
5	REC09116-06094	5030034	TORNILLO 6x15	SCREW 6x15	VITE 6x15	VIS 6x15
6	REC55320-98400AL	5033167	ÁNODO	ANODE	ANODO	ANODE
7	REC55321-93900	5033185	ÁNODO	ANODE	ANODO	ANODE
8	REC57510-93910	5033191	PIÑÓN MARCHA AVANTE	FORWARD GEAR	INGRANAGGIO MARCIA AVANTI	PIGNON MARCHE AVANT
9	REC57631-93901	5033196	VARILLA SELECTOR	ROD PUSH	ASTA SELETTORE	CLAVETTE
10	REC09440-32008	5033037	MUELLE	CLUTCH	MOLLA	RESSORT
11	REC09440-05027	5033034	MUELLE SELECTOR	SELECTOR SPRING	MOLLA SELETTORE	RESSORT DE SELECTEUR
12	REC57610-93901	5033193	EJE HELICE	PROPELLER SHAFT	ASSE ELICA	ARBRE D'HELICE
13	REC57521-93910	5033192	PIÑÓN MARCHA ATRÁS	REVERSER GEAR	INGRANAGGIO MARCIA INDIETRO	PIGNON MARCHE ARRIÈRE
14	REC08110-60050	5033303	RODAMIENTO	BEARING	CUSCINETTO	ROULEMENT
15	REC09280-57002	5033010	ARO TORICO	O-RING	O-RING	JOINT TORIQUE
16	REC56120-93900	5032743	DIÁBOLO	CARRIER	DIABOLO	DIABOLO
17	PAGB/T5787-M6X20	50030396	TORNILLO	BOLT, FLANGE	VITE	VIS DE BRIDE
18	REC09289-17006	5033015	RETÉN ACEITE	OIL SEAL	PARAOLIO	JOINT SPI
19	REC57632-94J00	5033197	SEPARADOR HÉLICE	PROPELLER WASHER	DISTANZIALE ELICA	RONDELLE HÉLICE
20	REC57633-93901	5033198	SEPARADOR	SPACER	DISTANZIALE	ENTRETOISE
21	PAGB/T6170-M6	5030051	TUERCA HEXÁGONAL M6	HEXAGON NUT M6	DADO ESAGONALE M6	ECROU HEXAGONAL M6
22	PAGB/T93-6	5030068	ARANDELA MUELLE 6	SPRING WASHER 6	RONDELLA MOLLA 6	RESSORT RONDELLE 6
23	CM55300-95500	5031538	ÁNODO	ANODE	ANODO	ANODE
24	PAGB/T820-M6X20	5032945	TORNILLO M6x20	SCREW M6x20	VITE M6x20	VIS M6X20
25	REC09263-15019	5033002	RODAMIENTO	BEARING	CUSCINETTO	ROULEMENT
26	REC17452-93910	5033110	JUNTA COLA	DRIVE GASKET	GUARNIZIONE PIEDE	JOINT D'EMBASE
27	REC09289-12003	5033014	RETÉN	OIL SEAL	PARAOLIO	JOINT SPI
28	REC17450-93921	5033109	CARCASA BOMBA AGUA	PUMP BASE	BASE POMPA ACQUA	CORPS DE POMPE À EAU
29	PAGB/T818-M6X10	5030409	TORNILLO M6x10	BOLT M6x10	BULLONE M6x10	BOULON M6x10
30	REC17453-93901	5033111	TUBO VACIADO DE AGUA	WATER TUBE	TUBO ACQUA	TUBE VIDANGE D'EAU
31	REC17472-93911	5035603	JUNTA BOMBA AGUA	WATER PUMP GASKET	GUARNIZIONE POMPA ACQUA	JOINT DE POMPE À EAU
32	REC17400-93951	5033106	KIT BOMBA AGUA	WATER PUMP SERVICE KIT	KIT POMPA ACQUA	KIT POMPE À EAU
33	REC17471-93902	5033114	BASE BOMBA AGUA	WATER PUMP PLATE	COPERCHIO GIRANTE	BASE DE POMPE À EAU
34	REC17462-93990	5033113	CHAVETA	KEY	CHIAVETTA	CLAVETTE
35	REC17461-93903	5033112	IMPULSOR	IMPELLER	GIRANTE	TURBINE
36	REC17411-93901	5033107	CUERPO BOMBA AGUA	HOUSING WATER PUMP	CORPO POMPA ACQUA	CORPS DE POMPE À EAU
37	PAGB/T5783-M8X55	5032766	TORNILLO HEXAGONAL M8x55	BOLT HEXAGON M8x55	BULLONE ESAGONALE M8x55	VIS HEXAGONAL M8x55
38	REC57311-93910	5033190	PIÑÓN ATAQUE	INITIATIVE GEAR	PIGNONE ATTACCO	PIGNON D'ATTAQUE
	REC09160-20041	5032985	GRUESO 1.00	SHIM 1.00	SPESSORE 1.00	CALE 1.00
39	REC09160-20042	5032967	GRUESO 1.10	SHIM 1.10	SPESSORE 1.10	CALE 1.10
	REC09160-20043	5032968	GRUESO 1.20	SHIM 1.20	SPESSORE 1.20	CALE 1.20
	REC09160-20044	5032969	GRUESO 1.30	SHIM 1.30	SPESSORE 1.30	CALE 1.30
40	REC09160-21009	5032970	ARANDELA PIÑÓN	WASHER GEAR	RONDELLA PIGNONE	RONDELLE DE PIGNON
41	REC09263-20L04	5033003	RODAMIENTO	BEARING	CUSCINETTO	ROULEMENT
42	REC09380-15001	5033027	CIRCLIP	CLIP	CERCLIP	CLIPS
43	REC57100-93902	5033188	EJE VERTICAL	DRIVE SHAFT	ASSE VERTICALE	ARBRE DE TRANSMISSION
44	REC08110-60020	5033299	RODAMIENTO	BEARING	CUSCINETTO	ROULEMENT



4T J 25 HP
STROKES

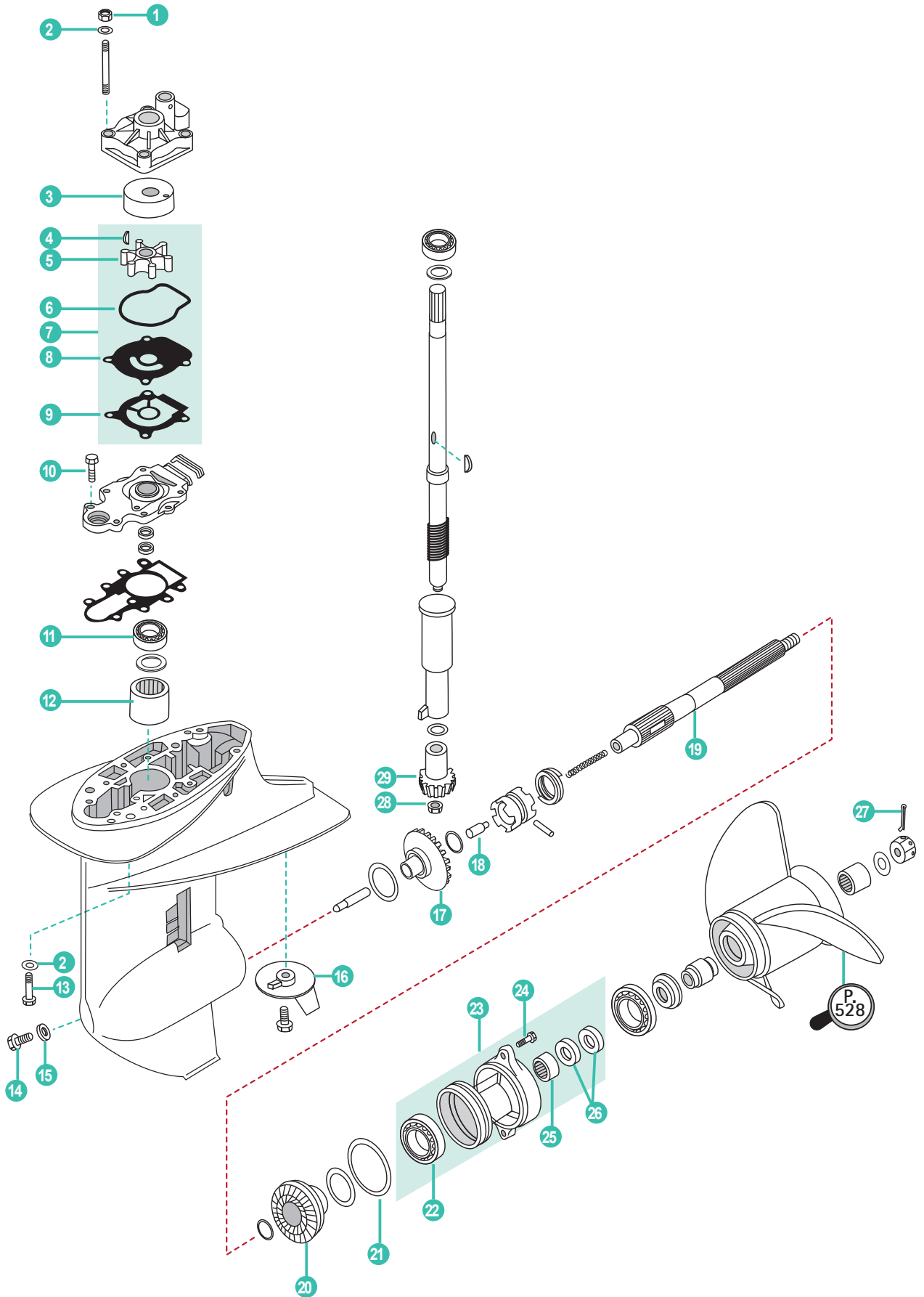

	REF	OEM				
1	PAGB/T6170-M6	5030051	TUERCA HEXÁGONO M6	NUT HEXAGON M6	DADO ESAGONALE M6	ECROU HEXAGONAL M6
2	PAGB/T848-6	5030429	ARANDELA	WASHER	RONDELLA	RONDELLE
3	REC17413-95J00	5036900	CASQUILLO INOX	SLEEVE WATER PUMP	CAPPUCCIO	INSERT DE POMPE À EAU
4	REC09420-04006	5031281	CHAVETA	KEY	CHIAVETTA	CLAVETTE
5	REC17461-96312	5031417	IMPULSOR	IMPELLER	GIRANTE	TURBINE
6	REC17416-95J00	5036901	ARO TÓRICO	O-RING	FASCIA TONDA	JOINT TORIQUE
7	REC17400-95J02	5036908	KIT BOMBA DE AGUA	WATER PUMP KIT	KIT POMPA ACQUA	KIT POMPE A EAU
8	REC17471-95J01	5036902	TAPA DEL IMPULSOR	OUTER PLATE CARTRIDGE	COPERCHIO GIRANTE	PLAQUE DE POMPE À EAU
9	REC17472-96303	5036681	JUNTA DE LA BOMBA DE AGUA	WATER PUMP, GASKET	GUARNIZIONE POMPA ACQUA	JOINT POMPE À EAU
10	REC09116-06094	5030034	TORNILLO 6x15	SCREW 6x15	VITE 6x15	VIS 6x15
11	REC09265-17002	5031885	RODAMIENTO	BEARING	CUSCINETTO	ROULEMENT
12	REC09263-20046	5031883	RODAMIENTO	BEARING	CUSCINETTO	ROULEMENT
13	PAGB/T5787-M6X30	5030394	TORNILLO M6x30	BOLT M6x30	BULLONE M6x30	BOULON M6x30
14	REC09248-10008	5030094	TORNILLO 10x7,5	SCREW 10x7,5	VITE 10x7,5	VIS M10x7,5
15	REC09168-10022	5030071	ARANDELA TAPÓN	CAP, O-RING	RONDELLA TAPPO	JOINT DE VIDANGE
16	REC55125-91L01AL	5032091	ÁNODO	ANODE	ANODO	ANODE
17	REC57510-89J00	5032689	PIÑÓN MARCHA AVANTE	POSITIVE GEAR	PIGNONE MARCIA AVANTI	PIGNON MARCHE AVANT
18	REC09209-08016	5031880	VARILLA PRESION ACEITE	ROD PUSH	ASTA PRESSIONE OLIO	CLAVETTE
19	REC57610-96311	5032101	EJE HELICE	PROPELLER SHAFT	ASSE ELICA	ARBRE D'HELICE
20	REC57521-89J00	5032100	PIÑÓN MARCHA ATRÁS	REVERSER GEAR	PIGNONE MARCIA INDIETRO	PIGNON MARCHE ARRIÈRE
21	REC09280-75001	5031263	ARO TÓRICO	O-RING	FASCIA TONDA	JOINT TORIQUE
22	REC08113-60060	5032295	RODAMIENTO	BEARING	CUSCINETTO	ROULEMENT
23	REC56120-96332-OEP	5034711	DIÁBOLO	CARRIER	DIAVOLO	DIABOLO
24	REC09116-06121	5030391	TORNILLO	BOLT	VITE	VIS
25	REC09263-20047	5031884	RODAMIENTO	BEARING	CUSCINETTO	ROULEMENT
26	REC09289-20009	5031893	RETÉN ACEITE	OIL SEAL	PARAOILIO	JOINT SPI
27	REC91490-30025	5030087	PIN BLOQUEADOR	COTTER PIN	COPPIGLIA	GOUPILLE
28	REC90179-08M06	5031827	TUERCA DE PIÑÓN M8X1	NUT, PINION M8X1	DADO PIGNONE M8X1	ECROU DE PIGNON M8
29	REC57311-96320	5032098	PIÑÓN ATAQUE	INITIATIVE GEAR	PIGNONE ATTACCO	PIGNON D'ATTAQUE

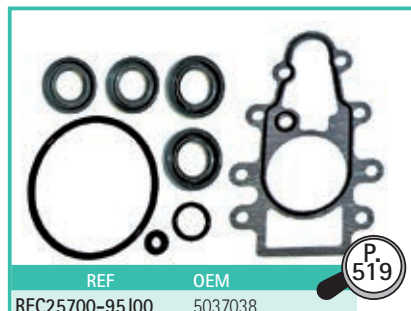

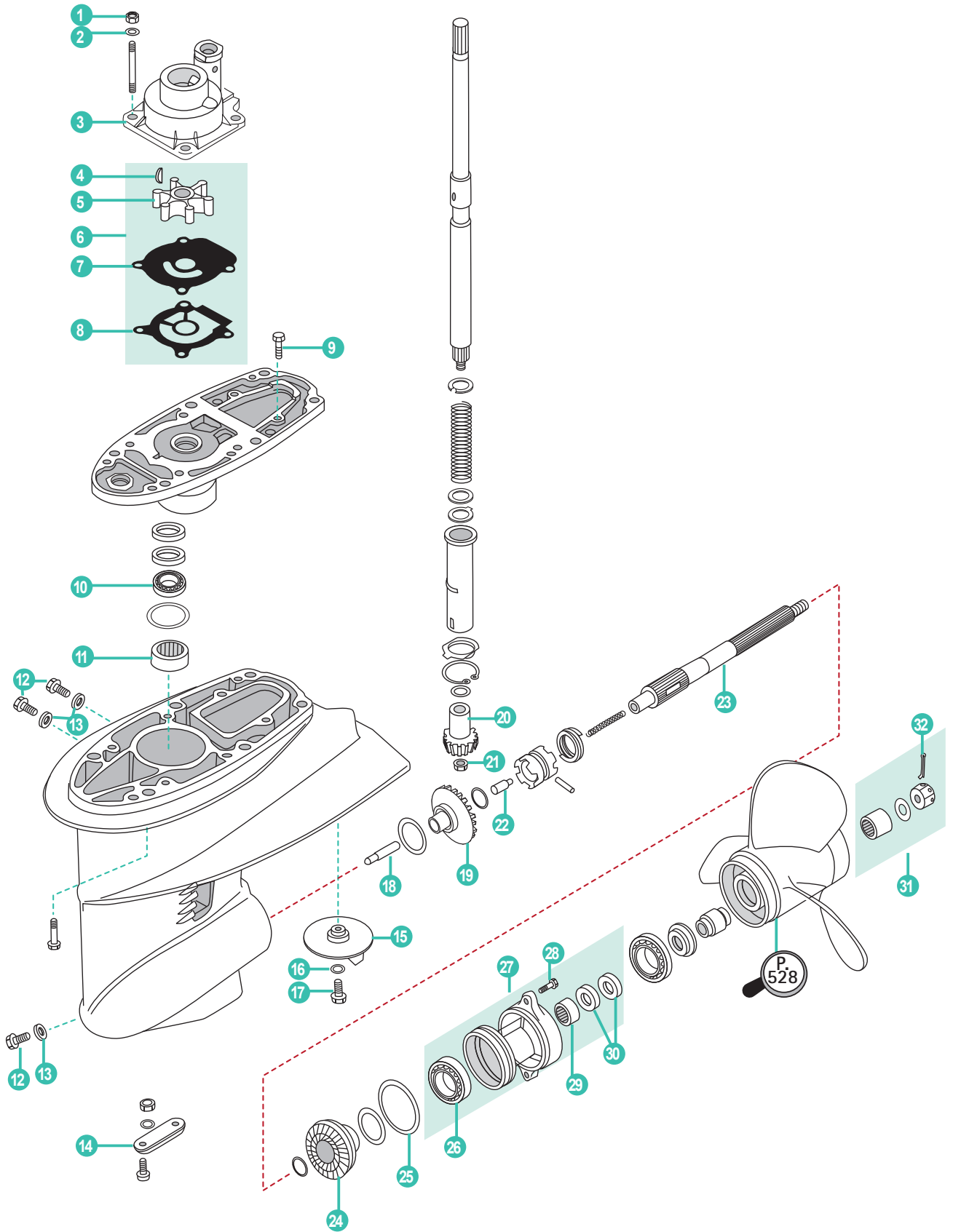

	REF	OEM				
1	PAGB/T6184-2000	5030051	TUERCA M6	NUT M6	DADO M6	ÉCROU M6
2	PAGB/T848-6	5030068	ARANDELA	WASHER	RONDELLA	RONDELLE
3	REC17411-94421	5031990	CUERPO BOMBA AGUA	HOUSING WATER PUMP	CORPO POMPA ACQUA	CORPS DE POMPE À EAU
4	REC09420-04006	5031281	CHAVETA	KEY	CHIAVETTA	CLAVETTE
5	REC17461-96312	5031417	IMPULSOR	IMPELLER	GIRANTE	TURBINE
6	REC17400-96403	5031744	KIT BOMBA DE AGUA	WATER PUMP KIT	KIT POMPA ACQUA	KIT POMPE A EAU
7	REC17471-94401	5031418	BASE BOMBA AGUA	PLATE, WATER PUMP	BASE POMPA ACQUA	BASE DE POMPE À EAU
8	REC17472-96303	5036681	JUNTA DE LA BOMBA DE AGUA	WATER PUMP, GASKET	GUARNIZIONE POMPA ACQUA	JOINT POMPE À EAU
9	PAGB/T5787-M6X20	5030037	TORNILLO	BOLT, FLANGE	VITE	VIS DE BRIDE
10	REC09265-17002	5031885	RODAMIENTO	BEARING	CUSCINETTO	ROULEMENT
11	REC09263-20046	5031883	RODAMIENTO	BEARING	CUSCINETTO	ROULEMENT
12	REC09248-10008	5030094	TORNILLO 10x7,5	SCREW 10x7,5	VITE 10x7,5	VIS 10x7,5
13	REC09168-10022	5030071	ARANDELA TAPÓN	CAP, O-RING	RONDELLA TAPPO	JOINT DE VIDANGE
14	CM55300-95500	5031538	ÁNODO	ANODE	ANODO	ANODE
15	REC55125-91L01AL	5032191	ÁNODO	ANODE	ANODO	ANODE
16	PAGB/T97.1-8		ARANDELA 8	WASHER 8	RONDELLA 8	RONDELLE 8
17	PAGB/T5783-M8X16	5031215	TORNILLO M8x16	BOLT M8x16	BULLONE M8x16	BOULON M8x16
18	REC57631-96301	5032103	VARILLA PRESION ACEITE	ROD PUSH	ASTA PRESSIONE OLIO	CLAVETTE
19	REC57510-89J00	5032698	PIÑÓN MARCHA AVANTE	POSITIVE GEAR	PIGNONE MARCIA AVANTI	PIGNON MARCHE AVANT
20	REC57311-96320	5032098	PIÑÓN ATAQUE	INITIATIVE GEAR	PIGNONE ATTACCO	PIGNON D'ATTAQUE
21	REC90179-08M06	5031827	TUERCA DE PIÑÓN M8X1	NUT, PINION M8X1	DADO PIGNONE M8X1	ECROU DE PIGNON M8
22	REC09209-08016	5031880	VARILLA PRESION ACEITE	ROD PUSH	ASTA PRESSIONE OLIO	CLAVETTE
23	REC57610-96311	5032101	EJE HELICE	PROPELLER SHAFT	ASSE ELICA	ARBRE D'HELICE
24	REC57521-89J00	5032100	PIÑÓN MARCHA ATRÁS	REVERSER GEAR	PIGNONE MARCIA INDIETRO	PIGNON MARCHE ARRIÈRE
25	REC925093	5031890	ARO TORICO SUPERIOR	O-RING UPPER	O-RING SUPERIORE	JOINT TORIQUE SUPERIEUR
26	REC08113-60060	5032295	RODAMIENTO	BEARING	CUSCINETTO	ROULEMENT
27	REC56120-96332-0EP	5034711	DIÁBOLO	CARRIER	DIABOLO	DIABOLO
28	REC09116-06121	5030391	TORNILLO	BOLT	VITE	VIS
29	REC09263-20047	5031884	RODAMIENTO	BEARING	CUSCINETTO	ROULEMENT
30	REC09289-20009	5031893	RETÉN ACEITE	OIL SEAL	PARAOILIO	JOINT SPI
31	REC57630-96300	5032170	KIT CIERRE DE HÉLICE	PROP NUT KIT	KIT CHIUSURA ELICA	KIT ECROU D'HELICE
32	REC91490-30025	5030087	PIN BLOQUEADOR	COTTER PIN	COPPIGLIA	GOUPILLE



4T DF40, DF50
STROKES

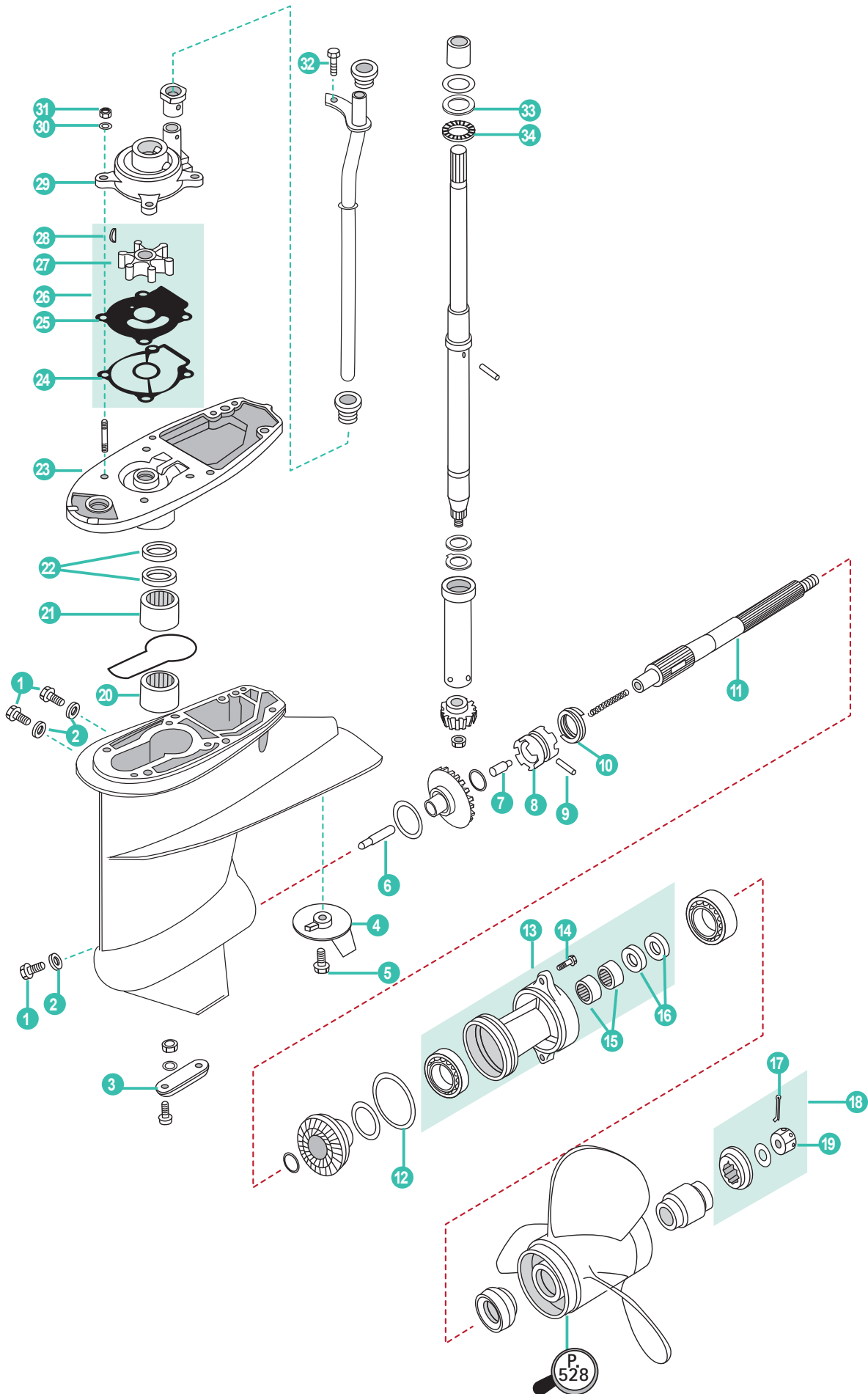

	REF	OEM				
1	REC09248-10008	5030094	TORNILLO 10x7,5	SCREW 10x7,5	VITE 10x7,5	VIS M10x7,5
2	REC09168-10022	5030071	ARANDELA TAPÓN	CAP, O-RING	RONDELLA TAPPO	JOINT DE VIDANGE
3	CM55300-95500	5031538	ÁNODO	ANODE	ANODO	ANODE
4	REC55125-95500AL	5031536	ÁNODO	ANODE	ANODO	ANODE
5	PAGB/T5783-M8X16	5031215	TORNILLO M8x16	BOLT M8x16	BULLONE M8x16	BOULON M8x16
6	REC57631-95303	5031549	VARILLA PRESION ACEITE	ROD PUSH	ASTA PRESSIONE OLIO	CLAVETTE
7	REC57634-88L00	5031251	PIN SELECTOR	CLUTCH PIN	PIN SELETTORE	CALVETTE
8	REC57621-94403	5036059	SELECTOR	SELETTORE	CLUTCH DOG	CRABOT
9	REC09202-04002	5030084	PIN HELICE	PROPELLER PIN	PIN ELICA	CLAVETTE D'HELICE
10	REC09440-40002	5031286	MUELLE SELECTOR	SPRING CLUTCH	MOLLA SELETTORE	RESSORT
11	REC57610-94402	5031546	EJE HELICE	PROPELLER SHAFT	ASSE ELICA	ARBRE D'HELICE
12	REC09280-75001	5031263	ARO TÓRICO	O-RING	FASCIA TONDA	JOINT TORIQUE
13	REC56120-94321-0EP	5032801	DIÁBOLO	CARRIER	DIABOLO	DIABOLO
14	PAGB/T5783-M8X30	5031216	TORNILLO M8x30	BOLT M8x30	BULLONE M8x30	BOULON M8x30
15	REC09263-22020	5031255	RODAMIENTO	BEARING	CUSCINETTO	ROULEMENT
16	REC09289-22007	5031270	RETÉN ACEITE	OIL SEAL	PARAOLIO	JOINT SPI
17	REC91490-30025	5030087	PIN BLOQUEADOR	COTTER PIN	COPPIGLIA	GOUPILLE
18	REC57630-94300	5031548	KIT CIERRE DE HÉLICE	PROP NUT KIT	KIT CHIUSURA ELICA	KIT ECROU D'HELICE
19	REC90171-18M04	5030422	TUERCA	NUT	DADO	ÉCROU
20	REC09263-22L03	5031256	RODAMIENTO	BEARING	CUSCINETTO	ROULEMENT
21	REC09263-25025	5031257	RODAMIENTO	BEARING	CUSCINETTO	ROULEMENT
22	REC09282-17005	5031264	RETÉN ACEITE	OIL SEAL	PARAOLIO	JOINT SPI
23	REC56130-94413-0EP	5032802	DIÁBOLO	CARRIER	DIABOLO	DIABOLO
24	REC17472-96303	5036681	JUNTA DE LA BOMBA DE AGUA	WATER PUMP, GASKET	GUARNIZIONE POMPA ACQUA	JOINT POMPE À EAU
25	REC17471-94401	5031418	BASE BOMBA AGUA	PLATE, WATER PUMP	BASE POMPA ACQUA	BASE DE POMPE À EAU
26	REC17400-96403	5031744	KIT BOMBA DE AGUA	WATER PUMP KIT	KIT POMPA ACQUA	KIT POMPE A EAU
27	REC17461-96312	5031417	IMPULSOR	IMPELLER	GIRANTE	TURBINE
28	REC09420-04006	5031281	CHAVETA	KEY	CHIAVETTA	CLAVETTE
29	REC17411-94421	5031990	CUERPO BOMBA AGUA	HOUSING WATER PUMP	CORPO POMPA ACQUA	CORPS DE POMPE À EAU
30	PAGB/T93-6	5030068	ARANDELA 6	WASHER 6	RONDELLA 6	RONDELLE 6
31	PAGB/T6170-M6	5030051	TUERCA HEXÁGONO M6	NUT HEXAGON M6	DADO ESAGONALE M6	ECROU HEXAGONAL M6
32	REC09116-06094	5030034	TORNILLO 6x15	SCREW 6x15	VITE 6x15	VIS 6x15
33	REC09160-26015	5031232	ARANDELA PIÑÓN	WASHER GEAR	RONDELLA PIGNONE	RONDELLE DE PIGNON
34	REC09263-25062	5031258	RODAMIENTO	BEARING	CUSCINETTO	ROULEMENT

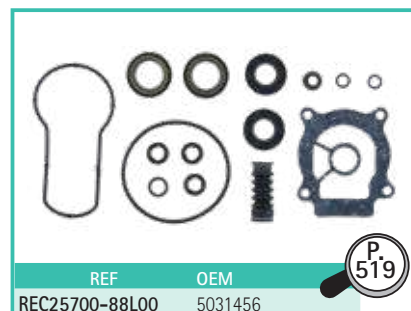

4T J/BJ 60, 70 HP
STROKES

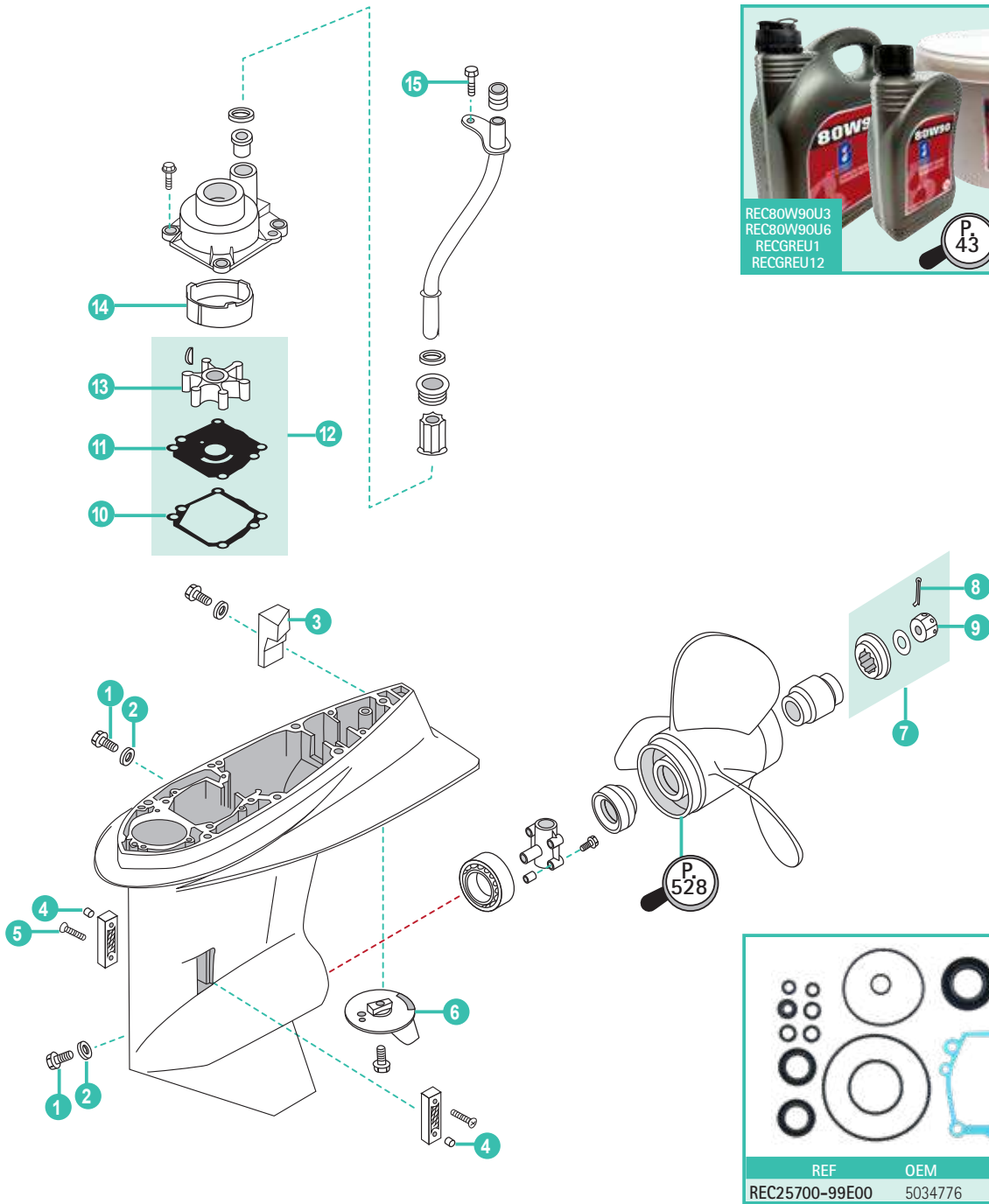

REC80W90U3
REC80W90U6
REC GREU1
REC GREU12

P
43

P
528

P
519

REF	OEM
REC25700-99E00	5034776

	REF	OEM				
1	REC09248-10008	5030094	TORNILLO 10x7,5	SCREW 10x7,5	VITE 10x7,5	VIS 10x7,5
2	REC09168-10022	5030071	ARANDELA TAPÓN	CAP, O-RING	RONDELLA TAPPO	JOINT DE VIDANGE
3	REC55321-90J01AL	5032930	ÁNODO	ANODE	ANODO	ANODE
4	PAGB/T889.1-M4	5030415	TUERCA HEXAGONAL M4	NUT HEXAGON M4	DADO ESAGONALE M4	ECROU HEXAGONAL M4
5	PAGB/T818-M4X30	5030405	TORNILLO M4x30	SCREW PAN HEAD M4x30	VITE TESTA M4x30	VIS M4x30
6	REC55125-90J01AL	5032929	ÁNODO	ANODE	ANODO	ANODE
7	REC57630-94500	5030967	KIT CIERRE HELICE	PROP NUT KIT	KIT CHIUSURA ELICA	KIT ECROU D'HELICE
8	REC91490-30025	5030087	PIN BLOQUEADOR	COTTER PIN	COPPIGLIA	GOUILLE
9	REC90171-18M04	5030422	TUERCA	NUT	DADO	ÉCROU
10	REC17472-87E10	5030725	JUNTA BOMBA AGUA	WATER PUMP GASKET	GUARZIONE POMPA ACQUA	JOINT DE POMPE À EAU
11	REC17471-92J00	5034651	PLACA BOMBA DE AGUA	PATE, WATER PUMP	PLACCA POMPA ACQUA	PLAQUE DE POMPE A EAU
12	REC17400-87E04	5031731	KIT REPARACION BOMBA AGUA	WATER PUMP KIT	KIT RIPARAZIONE POMPA ACQUA	KIT TURBINE
13	REC17461-87E12	5030723	IMPULSOR	IMPELLER	GIRANTE	TURBINE
14	REC17413-99E11		CASQUILLO INOX	INSERT CUP	GHIERA INOX	INSERT INOX POMPE A EAU
15	PAGB/T5783-M6X16	5030038	TORNILLO HEXAGONAL M6x16	BOLT HEXAGON M6x16	BULLONE ESAGONALE M6x16	BOULON HEXAGONAL M6x16

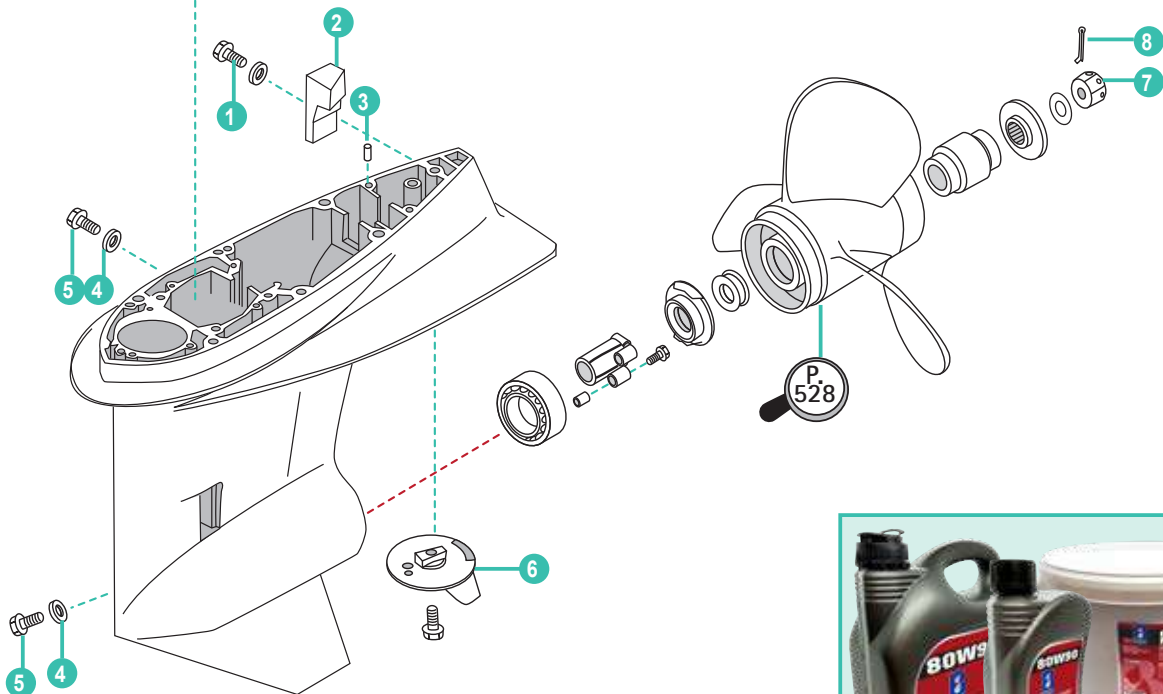
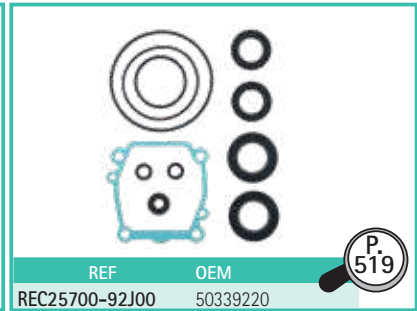
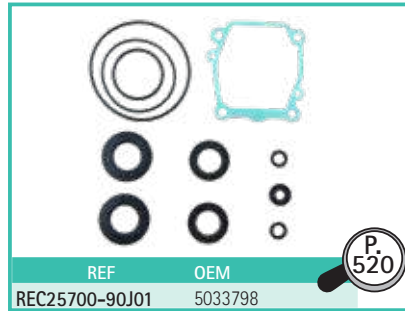
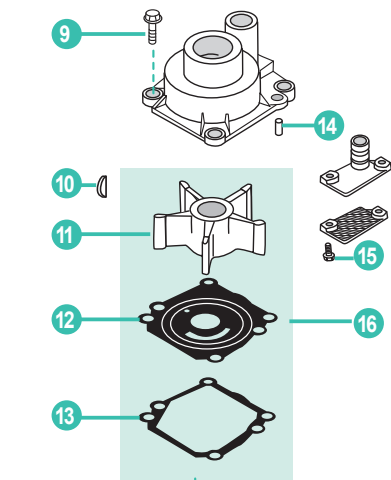

	REF	OEM				
1	PAGB/T5783-M6X12	5030338	TORNILLO M6x12	BOLT M6x12	BULLONE M6x12	BOULON M6x12
2	REC55321-90J01AL	5032930	ÁNODO	ANODE	ANODO	ANODE
3	PAF25-00000014	5030511	PIN CENTRADOR F8x12	PIN, DOWEL F8x12	PIN, CENTRAGGIO F8x12	GOUPILLE FENDUE 8x12
4	REC09168-10022	5030071	TORNILLO 10x7,5	SCREW 10x7,5	VITE 10x7,5	VIS M10x7,5
5	REC09248-10008	5030094	ARANDELA TAPÓN	CAP, O-RING	RONDELLA TAPPO	JOINT DE VIDANGE
6	REC55125-90J01AL	5032929	ÁNODO	ANODE	ANODO	ANODE
7	REC90171-18M04	5030422	TUERCA	NUT	DADO	ÉCROU
8	REC91490-30025	5030087	PIN BLOQUEADOR	COTTER PIN	COPPIGLIA	GOUPILLE
9	PAGB/T5783-M8X25	5030398	PERNO M8X25	BOLT M8X25	BULLONE M8	BOULON M8X25
10	REC09420-05009	5034842	CHAVETA	KEY	CHIAVETTA	CLAVETTE
11	REC17461-90J01	5033542	IMPULSOR	IMPELLER	GIRANTE	TURBINE
12	REC17471-92J00	5037170	TAPA DEL IMPULSOR	OUTER PLATE CARTRIDGE	COPERCHIO GIRANTE	PLAQUE DE POMPE À EAU
13	REC17472-87E10	5030725	JUNTA BOMBA AGUA	WATER PUMP GASKET	GUARZIONE POMPA ACQUA	JOINT DE POMPE À EAU
14	REC93606-12019	5030508	PIN F6X12	PIN F6X12	SPINOTTO F6X12	LEVIER F6X12
15	PAGB/T8.8-2000	5030406	TORNILLO M5X12	SCREW, PAN HEAD M5X12	VITE M5X12	VIS M5X12
16	REC17400-90J20	5033541	KIT BOMBA DE AGUA	WATER PUMP KIT	KIT POMPA ACQUA	KIT POMPE A EAU

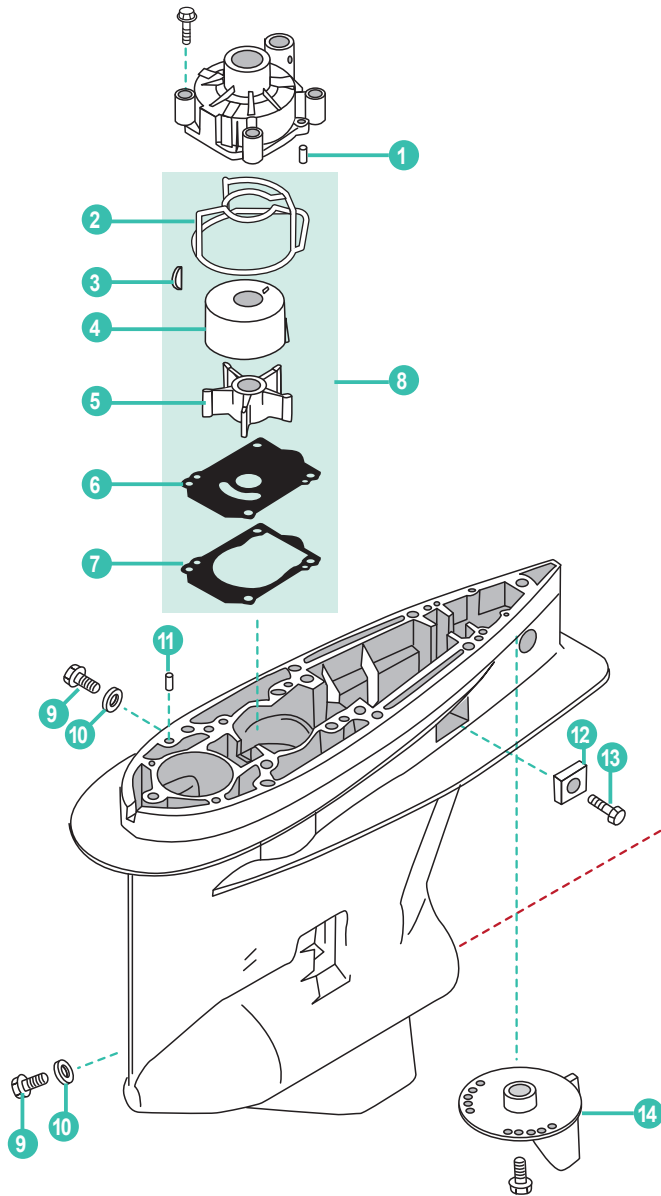

REC80W90U3
REC80W90U6
RECGREU1
RECGREU12

P. 43

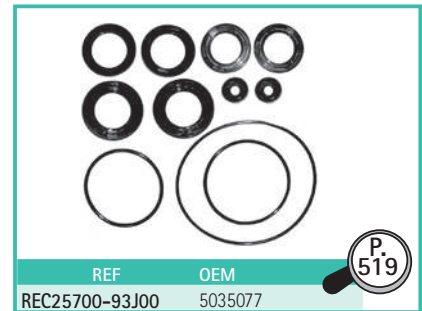

REF	OEM
REC25700-93J00	5035077

P. 519

	REF	OEM				
1	REC93606-12019	5030508	PIN F6X12	PIN F6X12	SPINOTTO F6X12	PIN F6X12
2	REC17416-96J00	5035039	JUNTA TORICA	O-RING	O-RING	JOINT TORIQUE
3	REC09420-05009	5034842	CHAVETA	KEY	CHIAVETTA	CLAVETTE
4	REC17413-96J01	5035038	CASQUILLO INOX	SLEEVE WATER PUMP	CAPPUCCIO	INSERT DE POMPE À EAU
5	REC17461-90J01	5033542	IMPULSOR	IMPELLER	GIRANTE	TURBINE
6	REC17471-92J02	5035041	TAPA DEL IMPULSOR	IMPELLER PLATE	COPERCHIO GIRANTE	PLAQUE DE POMPE À EAU
7	REC17472-93J00	5035042	JUNTA	GASKET	GUARNIZIONE	JOINT
8	REC17400-96J03	5035036	KIT BOMBA DE AGUA	WATER PUMP KIT	KIT POMPA ACQUA	KIT POMPE A EAU
9	REC55128-93J10	5035151	TAPON DRENAJE COLA	WATER PLUG DRAIN	GUARNIZIONE DRENAGGIO	BOUCHON DE VIDANGE
10	REC09168-10034	5034799	JUNTA	GASKET	GUARNIZIONE	JOINT
11	PAF25-00000014	5030511	PIN CENTRADOR F8x12	PIN, DOWEL F8x12	PIN, CENTRAGGIO F8x12	GOUPILLE FENDUE 8x12
12	REC55320-95311AL	5035786	ÁNODO	ANODE	ANODO	ANODE
13	REC09116-06094	5030034	TORNILLO 6x15	SCREW 6x15	VITE 6x15	VIS M6x15
14	REC55125-90J01AL	5035150	ÁNODO	ANODE	ANODO	ANODE
15	REC57630-92E00	5035460	KIT CIERRE HELICE	PROP NUT KIT	KIT CHIUSURA ELICA	KIT ECROU D'HELICE
16	REC90171-18M04	5030422	TUERCA	NUT	DADO	ÉCROU
17	REC91490-30025	5030087	PIN BLOQUEADOR	COTTER PIN	COPPIGLIA	GOUPILLE

DESPIECE COLAS
2 TIEMPOS

GEAR CASE PARTS
2 STROKES

PAR TI PIEDI
DE 2 TEMPI

PIECES D'EMBASES DE 2
TEMPS

2T 4, 4.5, 5, 6, 7.5, 8 HP (1980+)
STROKES

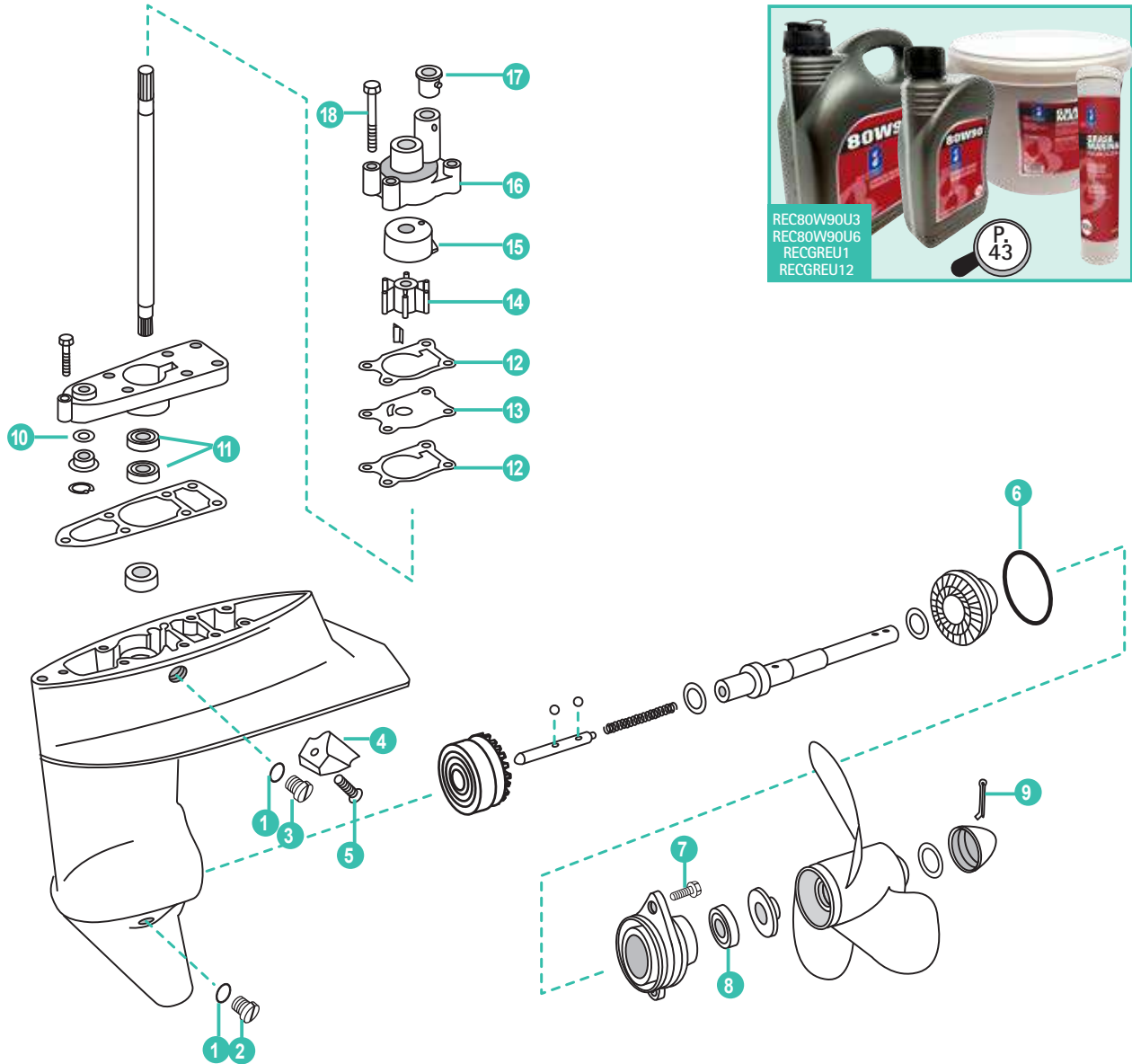

	REF	OEM				
1	REC12-191833	307552	JUNTA	GASKET	GUARNIZIONE	JOINT DE VIDANGE
2	REC22-67892A05	318544	JUEGO TORNILLOS DRENAJE	DRAINING SCREW SET	KIT VITERIA DRENAGGIO	BOUCHON DE VIDANGE MAGNETIQUE + JOINT
3	REC10-79953Q04	307551	JUEGO TORNILLOS	SCREW SET	KIT VITERIA	BOUCHON + JOINT VIDANGE
4	CM334451A	334451	ÁNODO	ANODE	ANODO	ANODE
5	REC328725	328725	TORNILLO	SCREW	VITE	VIS
6	REC322494	322494	JUNTA TORICA	O-RING	O-RING	JOINT TORIQUE
7	REC328744	328744	TORNILLO	SCREW	VITE	VIS
8	REC336493	336493	RETÉN ACEITE	OIL SEAL	PARAOILIO	JOINT SPI
9	REC3852056	306394	PASADOR	COTTER PIN	CHIAVISTELLO	GOUPILLE
10	REC305242	305242	JUNTA TORICA	O-RING	O-RING	JOINT TORIQUE
11	REC324639	324639	RETÉN ACEITE	OIL SEAL	PARAOILIO	JOINT SPI
12	REC325040	325040	JUNTA	GASKET	GUARNIZIONE	JOINT
13	REC324640	324640	TAPA	WEAR PLATE	COPERCHIO	COUVERCLE
14	REC389576	436137	IMPULSOR	IMPELLER	GIRANTE	TURBINE
15	REC324641	324641	TAPA BOMBA	PUMP CUP	COPERCHIO POMPA	INSERT DE POMPE
16	REC389577	389577	CUERPO BOMBA	PUMP HOUSING	CORPO POMPA	CORSP DE POMPE
17	REC302497	302497	GRUESO 20"	GROMMET 20"	SPESSORE 20"	CALE 20"
18	REC331980	331980	TORNILLO	SCREW	VITE	VIS

2T 9.9, 15 HP (1974+)
STROKES

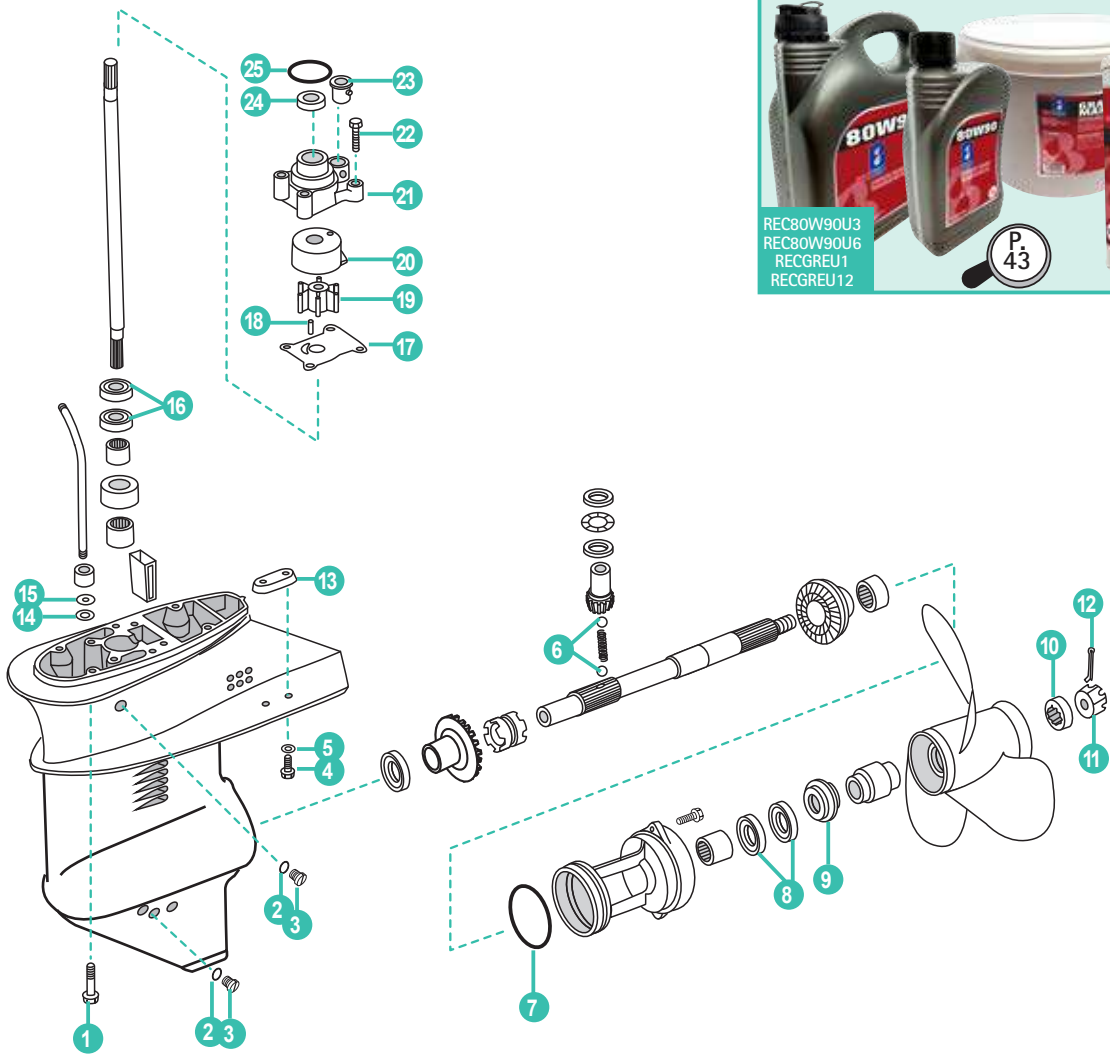

REF	OEM				
1	REC324334	324334	TORNILLO	SCREW	VITE VIS
2	REC12-191833	307552	JUNTA	GASKET	GUARNIZIONE JOINT DE VIDANGE
3	REC10-79953Q04	307551	JUEGO TORNILLO	SCREW SET	KIT VITERIA VIS DE VIDANGE
4	REC306643	306643	TORNILLO	SCREW	VITE VIS
5	REC304454	304454	CIERRE	LOCKWASHER	CHIUSURA RONDELLE
6	REC316506	316506	BOLA	DETENT BALL	FERMO SFERA BILLE
7	REC308627	308627	TÓRICA	O-RING	O-RING JOINT TORIQUE
8	REC321481	321481	RETÉN ACEITE	OIL SEAL	PARAOLIO JOINT SPI
9	REC334590	334590	CIERRE	THRUST WASHER	CHIUSURA ENTRETOISE POUR HELICE
10	REC323942	323942	ESPACIADOR	SPACER	DISTANZIATORE RONDELLE D'HELICE
11	REC318971	318971	TUERCA	NUT	DADO ÉCROU
12	REC328522	328522	PASADOR	COTTER PIN	CHIAVISTELLO GOUPILLE FENDUE
13	CM123009	173029	ÁNODO	ANODE	ANODO ANODE
14	REC321738	321738	ARANDELA	WASHER	RONDELLA RONDELLE
15	REC301877	301877	TÓRICA	O-RING	O-RING JOINT TORIQUE
16	REC321480	321480	RETÉN ACEITE	OIL SEAL	PARAOLIO JOINT SPI
17	REC318995	318995	TAPA	WEAR PLATE	COPERCHIO COUVERCLE
18	REC300611	300611	CHAVETA	KEY	CHIAVE CLAVETTE
19	REC386084	386084	IMPULSOR	IMPELLER	GIRANTE TURBINE
20	REC324097	324097	TAPA BOMBA	PUMP CUP	COPERCHIO POMPA INSERT DE POMPE
21	REC435390	435390	CUERPO BOMBA	PUMP HOUSING	CORPO POMPA CORPS DE POMPE
22	REC302325	302325	TORNILLO	SCREW	VITE VIS
23	REC302497	302497	GRUESO	GROMMET	SPESSORE CALE
24	REC318972	318972	RETÉN ACEITE	OIL SEAL	PARAOLIO JOINT SPI
25	REC319085	319085	TÓRICA	O-RING	O-RING JOINT TORIQUE

2T 20 - 35 HP 2 CYL CROSSFLOW (1980-05) • 25, 30, 35 HP 3 CYL LOOPCHARGED (1996-01)
 STROKES ESCAPE POR HÉLICE | THRU-PROP EXHAUST | SCARICO ALL'ELICA | ÉCHAPPEMENT PAR HÉLICE

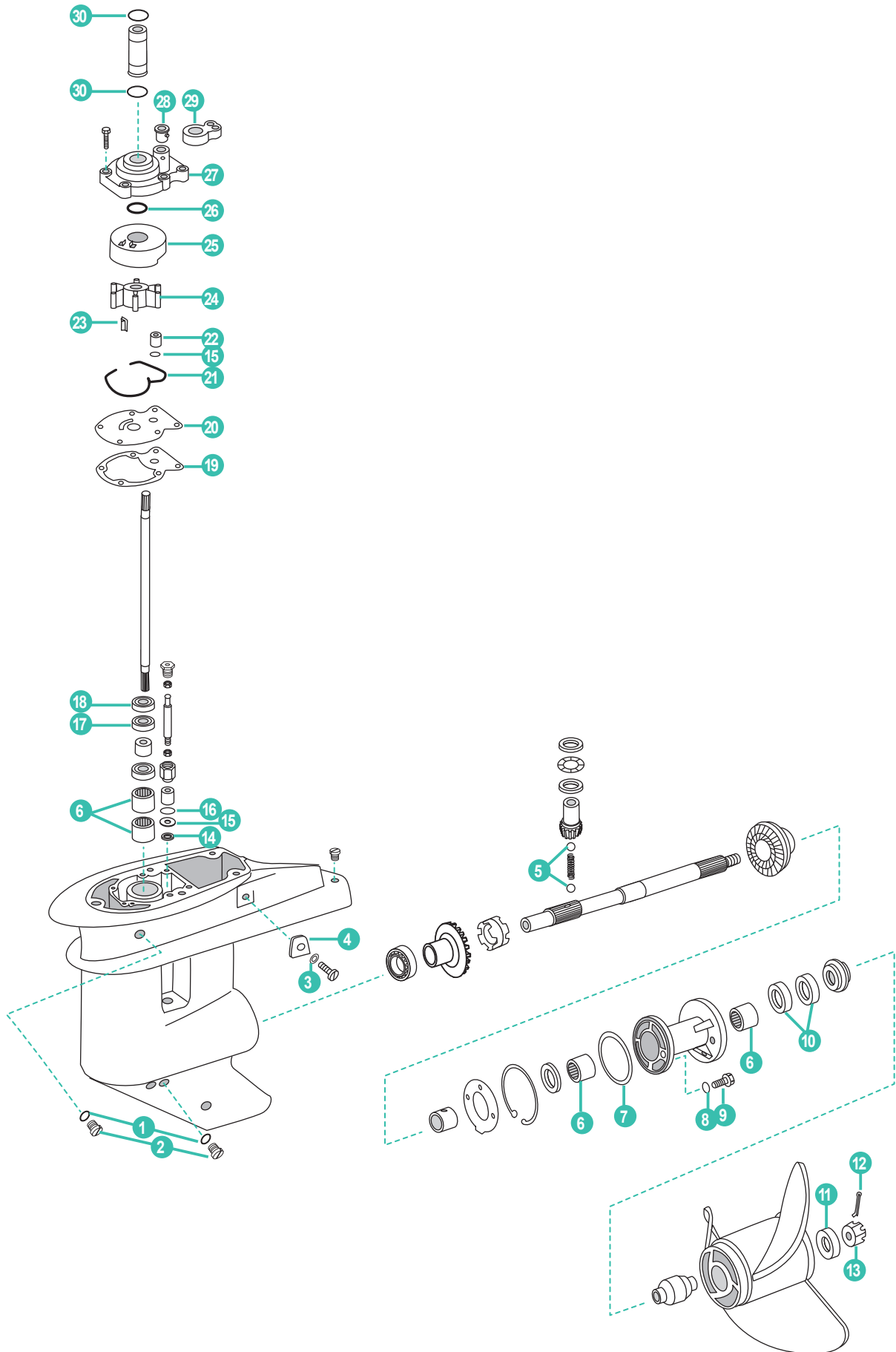

	REF	OEM				
1	REC3855081	311598	JUNTA	GASKET	GUARNIZIONE	JOINT
2	REC10-79953Q04	307551	JUEGO TORNILLOS	SCREW SET	KIT VITERIA	BOUCHON JOINT VIDANGE EMBASSE
3	REC304454	304454	CIERRE	LOCKWASHER	CHIUSURA	RONDELLE
4	CM434029	434029	ÁNODO	ANODE	ANODO	ANODE
5	REC316506	316506	BOLA	BALL	SFERA	BILLE
6	REC437288	437288	COJINETE (1994+)	BEARING (1994+)	CUSCINETTO (1994+)	ROULEMENT (1994+)
7	REC338518	338518	TÓRICA	O-RING	O-RING	JOINT TORIQUE
8	REC26-01674	332583	TÓRICA	O-RING	O-RING	JOINT TORIQUE
9	REC320041	320041	TORNILLO	SCREW	VITE	VIS
10	REC26-69188	321453	RETÉN ACEITE	OIL SEAL	PARAOLIO	JOINT SPI
11	REC323943	323943	ESPACIADOR HÉLICE	PROP SPACER	DISTANZIATORE ELICA	RONDELLE D'HELICE
12	REC320785	320785	PASADOR	COTTER PIN	CHIAVISTELLO	GOUPILLE FENDUE
13	REC319891	319891	TUERCA HÉLICE	PROP NUT	DADO ELICA	ÉCROU D'HELICE
14	REC321738	321738	JUNTA	GASKET	GUARNIZIONE	JOINT
15	REC301877	301877	ARO PARA REC393632	O-RING (FOR REC393632)	O-RING PER REC393632	JOINT TORIQUE POUR REC393632
16	REC303347	303347	TÓRICA	O-RING	O-RING	JOINT TORIQUE
17	REC321928	321928	RETÉN ACEITE	OIL SEAL	PARAOLIO	JOINT SPI
18	REC332261	332261	RETÉN ACEITE	OIL SEAL	PARAOLIO	JOINT SPI
19	REC325537	325537	JUNTA	GASKET	GUARNIZIONE	JOINT
20	REC328755	328755	TAPA BOMBA	WEAR PLATE	COPERCHIO POMPA	PLAQUE DE POMPE
21	REC328753	328753	RETÉN	SEAL	PARAOLIO	JOINT SPI
22	REC328754	328754	GRUESO PARA REC393632	BUSHING (FOR REC393632)	SPESSORE PER REC393632	CALE POUR REC393632
23	REC344470	344470	CHAVETA	KEY	CHIAVE	CLAVETTE
24	REC395289	395289	IMPULSOR	IMPELLER	GIRANTE	TURBINE
25	REC328751	328751	TAPA BOMBA	PUMP CUP	COPERCHIO POMPA	INSERT DE POMPE
26	REC0554545	554545	TÓRICA	O-RING	O-RING	JOINT TORIQUE
27	REC393632	393632	CUERPO BOMBA 2 CIL	PUMP HOUSING 2-CYL	CORPO POMPA 2 Cil	CORPS DE POMPE 2 CYL
28	REC302497	302497	GRUESO PARA REC393632	GROMMET (FOR REC393632)	SPESSORE PER REC393632	CALE POUR REC393632
29	REC340811	340811	GRUESO	GROMMET	SPESSORE	CALE
30	REC25-62705	311338	TÓRICA	O-RING	O-RING	JOINT TORIQUE

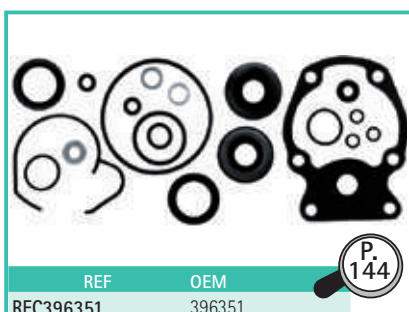

2T 40 - 50 HP 2 CYL LOOPCHARGED (1989-05)
 STROKES COLA PEQUEÑA | SMALL GEARCASE | PIEDE CORTO | EMBASE COURTE

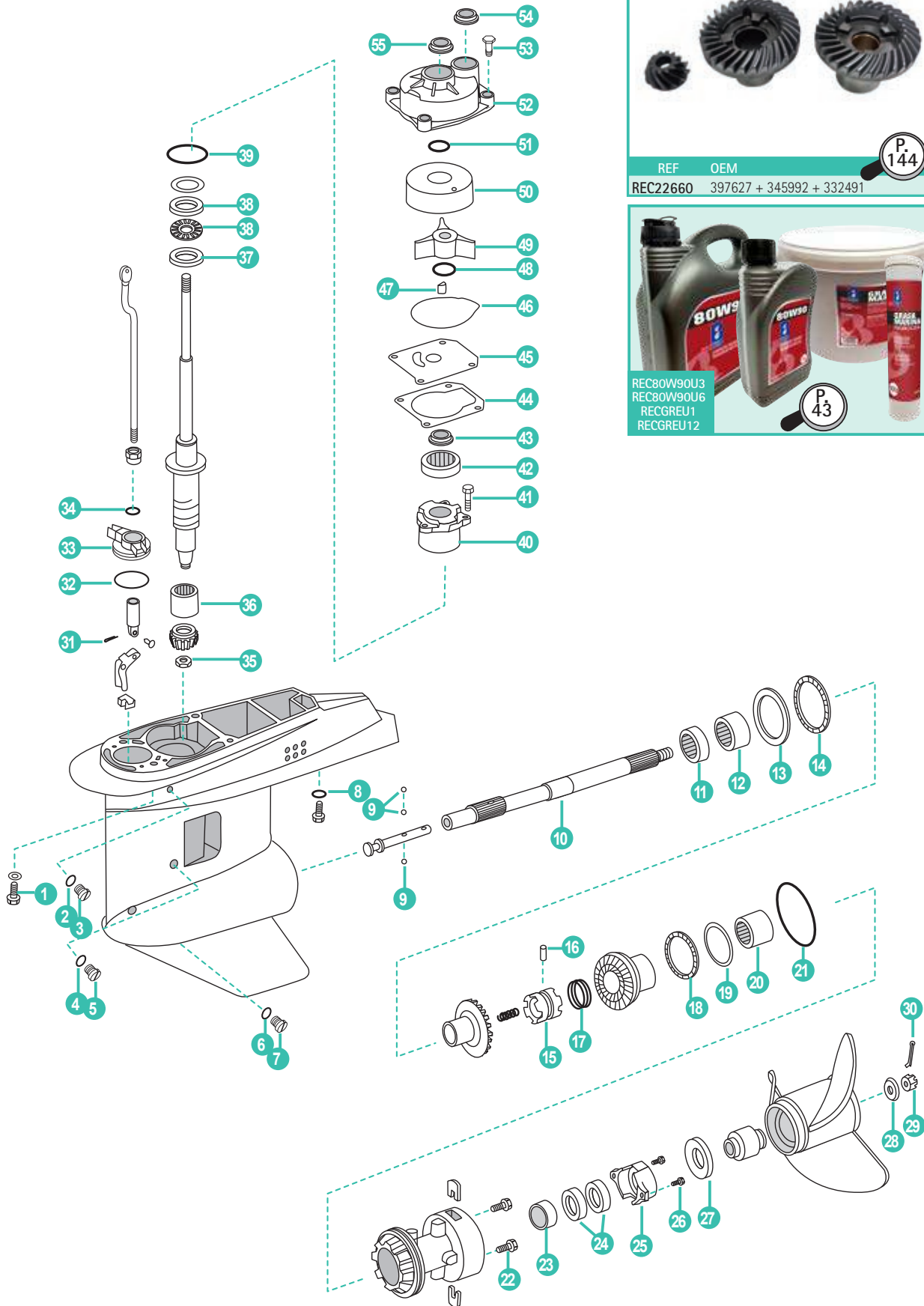

	REF	OEM				
1	REC305282	305282	TORNILLO	SCREW	VITE	VIS
2	REC336982	336982	TÓRICA	O-RING	O-RING	JOINT TORIQUE
3	REC309243	309243	TORNILLO	SCREW	VITE	VIS
4	REC332584	332584	RETÉN	SEAL OIL	PARAOLIO	JOINT SPI
5	REC324852	324852	TORNILLO	SCREW	VITE	VIS
6	REC3855081	311598	JUNTA	GASKET	GUARNIZIONE	JOINT
7	REC22-67892A05	318544	TORNILLO DRENAJE	DRAINING SCREW	VITE DRENAGGIO	VIS VIDANGE
8	REC330265	330265	ARANDELA	WASHER	RONDELLA	RONDELLE
9	REC316506	316506	BOLA	BALL	SFERA	BILLE
10	REC439138	439138	EJE HÉLICE	PROP SHAFT	ASSE ELICA	ARBRED'HÉLICE
11	REC432264	432264	COJINETE	BEARING	CUSCINETTO	ROULEMENT
12	REC382407	382407	COJINETE	BEARING	CUSCINETTO	ROULEMENT
13	REC333725	333725	ARANDELA	THRUST WASHER	RONDELLA	RONDELLE
14	REC397538	397538	ARANDELA COJINETE	THRUST BEARING	RONDELLA CUSCINETTO	RONDELLE CROULEMENT
15	REC332491	332491	SELECTOR	CLUTCH DOG	SELETTORE	CRABOT
16	REC320310	320310	PASADOR	CROSS PIN	CHIAVISTELLO	PIN
17	REC320311	320311	MUELLE	SPRING	MOLLA	RESSORT
18	REC397537	397537	ARANDELA COJINETE	THRUST BEARING	RONDELLA CUSCINETTO	RONDELLE ROULEMENT
19	REC332514	332514	ARANDELA	THRUST WASHER	RONDELLA	RONDELLE
20	REC386764	386764	COJINETE	BEARING	CUSCINETTO	ROULEMENT
21	REC553126	553126	TÓRICA	O-RING	O-RING	JOINT TORIQUE
22	REC328744	328744	TORNILLO	SCREW	VITE	VIS
23	REC386765	386765	COJINETE	BEARING	CUSCINETTO	ROULEMENT
24	REC321467	321467	RETÉN ACEITE	OIL SEAL	PARAOLIO	JOINT SPI
25	CM398873 CM398873A	398873 398873	ÁNODO ÁNODO ALUMINIO	ANODE ALUMINUM ANODE	ANODO ANODO ALLUMINIO	ANODE ANODE AL
26	REC328694	328694	TORNILLO	SCREW	VITE	VIS
27	REC320305	320305	ARANDELA	THRUST WASHER	RONDELLA	RONDELLE
28	REC315810	315810	ESPACIADOR HÉLICE	PROP SPACER	DISTANZIATORE ELICA	RONDELLE BUTEE D'HELICE
29	REC314503	314503	TUERCA HÉLICE	PROP NUT	DADO ELICA	ECROU D'HELICE
30	REC314502	314502	PASADOR	COTTER PIN	CHIAVISTELLO	GOUPILLE
31	REC306376	306376	PASADOR	COTTER PIN	CHIAVISTELLO	GOUPILLE
32	REC3852928	913921	TÓRICA	O-RING	O-RING	JOINT TORIQUE
33	REC434588	434588	TAPA ACOPLAMIENTO	COVER & BUSHING ASSEMBLY	COPERCHIO ACCOPPIAMENTO	COUVERCLE
34	REC318372	318372	TÓRICA	O-RING	O-RING	JOINT TORIQUE
35	REC313339	313339	TUERCA PIÑÓN	PINION NUT	DADO PIGNONE	ECROU
36	REC382343	382343	COJINETE	BEARING	CUSCINETTO	ROULEMENT
37	REC333771	333771	ARANDELA	THRUST WASHER	RONDELLA	RONDELLE
38	REC398901	398901	ARANDELA COJINETE	THRUST BEARING	RONDELLA CUSCINETTO	RONDELLE ROULEMENT
39	REC25-30224	310327	TÓRICA	O-RING	O-RING	JOINT TORIQUE
40	REC435274	435274	CUERPO COJINTE	BEARING HOUSING ASSEMBLY	CORPO CUSCINETTO	PALLIER DE ROULEMENT
41	REC317624	317624	TORNILLO	SCREW	VITE	VIS
42	REC398874	398874	COJINETE	BEARING	CUSCINETTO	ROULEMENT
43	REC342786	342786	RETÉN ACEITE	OIL SEAL	PARAOLIO	JOINT SPI
44	REC336530	336530	JUNTA	GASKET	GUARNIZIONE	JOINT
45	REC341038	341038	TAPA	WEAR PLATE	COPERCHIO	COUVERCLE
46	REC324981	324981	RETÉN	SEAL	TENUTA	JOINT
47	REC334897	334897	CHAVETA	KEY	CHIAVE	CLAVETTE
48	REC331188	331188	TÓRICA	O-RING	O-RING	JOINT TORIQUE
49	REC432941	432941	IMPULSOR (1989-02)	IMPELLER (1989-02)	GIRANTE (1989-02)	TURBINE (1989-02)
50	REC340619	340619	TAPA BOMBA	PUMP CUP	COPERCHIO POMPA	INSERT DE POMPE
51	REC310584	310584	TÓRICA	O-RING	O-RING	JOINT TORIQUE
52	REC438544	438544	CUERPO BOMBA (1989-98)	PUMP HOUSING (1989-98)	CORPO POMPA (1989-98)	CORPS DE POMPE (1989-98)
53	REC302325	302325	TORNILLO	SCREW	VITE	VIS
54	REC333758	333758	GRUESO	GROMMET	SPESSORE	CALE
55	REC341732	341732	GRUESO	GROMMET	SPESSORE	CALE

2T 40 - 60 HP 2 CYL LOOPCHARGED (1975-88) • 60 - 75 HP 2 CYL LOOPCHARGED (1975-88)
 STROKES COLA PEQUEÑA | SMALL GEARCASE | PIEDE CORTO | EMBASE COURTE

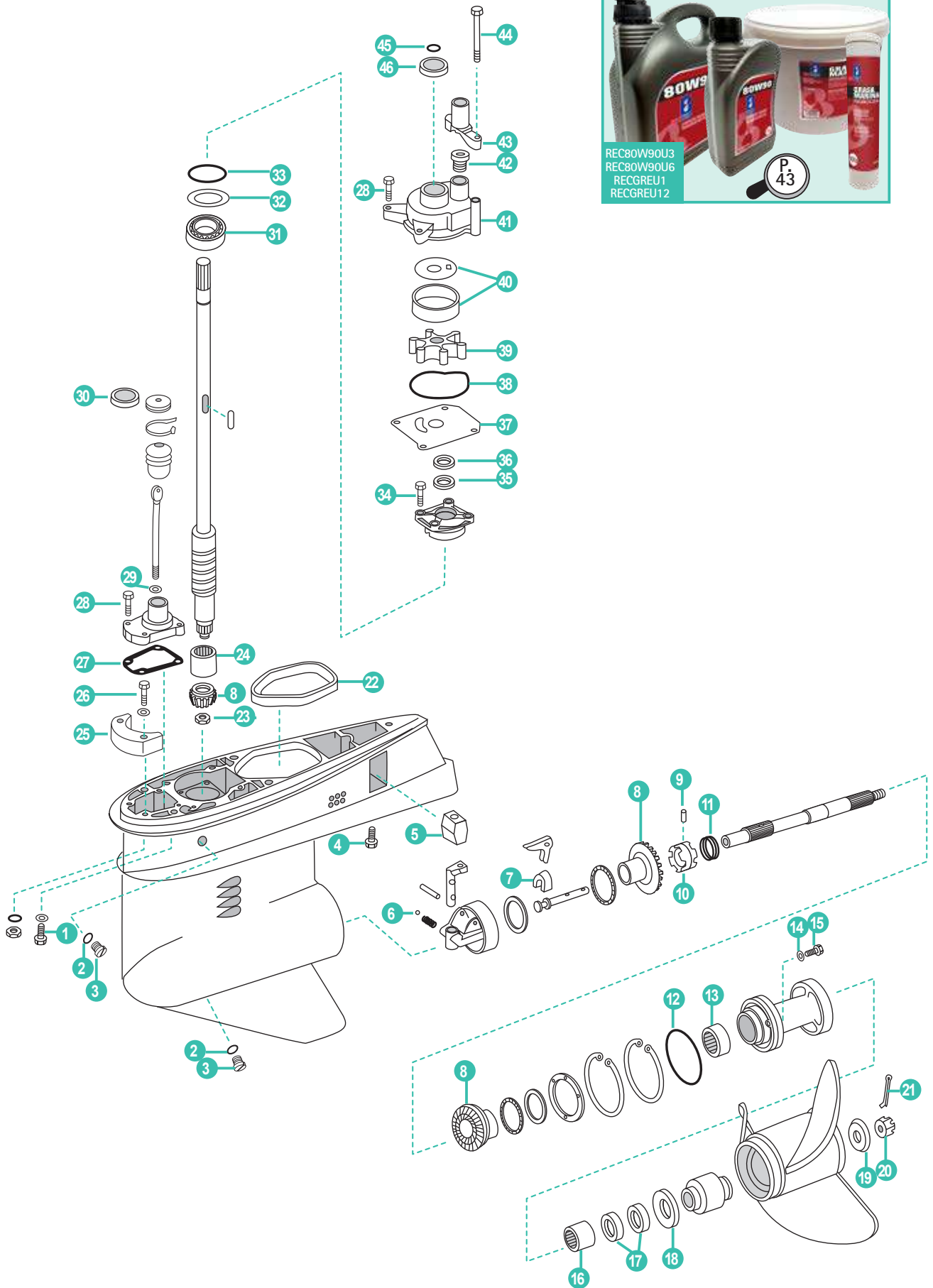

	REF	OEM				
1	REC305282	305282	TORNILLO	SCREW	VITE	VIS
2	REC3855081	311598	JUNTA	GASKET	GUARNIZIONE	JOINT
3	REC10-79953Q04	307551	TORNILLO	SCREW	VITE	VIS
4	REC328096	328096	TORNILLO	SCREW	VITE	VIS
5	REC436745AL	436745	ÁNODO	ANODE	ANODO	ANODE
6	REC160084	160084	BOLA	DETENT BALL	SFERE	BILLE
7	REC334163	334163	REGULADOR EJE	CRADLE	REGOLATORE ASSE	REGULATEUR D'AXE
8	REC433570	433570	KIT PIÑONES	GEAR SET	KIT PIGNONI	KIT PIGNON
9	REC320310	320310	PASADOR	CROSS PIN	CHIAVISTELLO	PIN
10	REC319895	319895	SELECTOR	CLUTCH DOG	SELETTORE	CRABOT
11	REC320311	320311	MUELLE	SPRING	MOLLA	RESSORT
12	REC925093	320303	TÓRICA	O-RING	O-RING	JOINT TORIQUE
13	REC386764	386764	COJINETE	BEARING	CUSCINETTO	ROULEMENT
14	REC332584	332584	TÓRICA	O-RING	O-RING	JOINT TORIQUE
15	REC320041	320041	TORNILLO	SCREW	VITE	VIS
16	REC386765	386765	COJINETE	BEARING	CUSCINETTO	ROULEMENT
17	REC321467	321467	RETÉN ACEITE	OIL SEAL	PARAOLIO	JOINT SPI
18	REC320305	320305	ARANDELA	THRUST WASHER	RONDELLA	RONDELLE
19	REC315810	315810	ESPACIADOR HÉLICE	PROP SPACER	DISTANZIATORE ELICA	RONDELLE BUTEE D'HELICE
20	REC314503	314503	TUERCA HÉLICE	PROP NUT	DADO ELICA	ECROU D'HELICE
21	REC314502	314502	PASADOR	COTTER PIN	CHIAVISTELLO	GROUPELLE FENDUE
22	REC324937	324937	RETÉN	SEAL	TENUTA	JOINT
23	REC313339	313339	TUERCA PIÑÓN	PINION NUT	DADO PIGNONE	ECROU
24	REC386766	386766	PIÑÓN COJINETE	PINION BEARING	PIGNONE CUSCINETTO	PIGNON ROULEMENT
25	CM392462	392462	ÁNODO	ANODE	ANODO	ANODE
26	REC331980	324430	TORNILLO	SCREW	VITE	VIS
27	REC314082	314082	JUNTA	GASKET	GUARNIZIONE	JOINT
28	REC302325	302325	TORNILLO	SCREW	VITE	VIS
29	REC318372	318372	TÓRICA	O-RING	O-RING	JOINT TORIQUE
30	REC305762	305762	GRUESO	GROMMET	SPESSORE	CALE
31	REC31-32575T1	385175	COJINETE	BEARING	CUSCINETTO	ROULEMENT
32	REC320166	320166	SUPLEMENTO .003	SHIM .003	SPESSORE .003	CALE .003
32	REC320167	320167	SUPLEMENTO .004	SHIM .004	SPESSORE .004	CALE .004
32	REC320168	320168	SUPLEMENTO .005	SHIM .005	SPESSORE .005	CALE .005
33	REC302588	302588	TÓRICA	O-RING	O-RING	JOINT TORIQUE
34	REC909386	909386	TORNILLO	SCREW	VITE	VIS
35	REC342786	321466	RETÉN ACEITE	OIL SEAL	PARAOLIO	JOINT SPI
36	REC342786	332205	RETÉN ACEITE	OIL SEAL	PARAOLIO	JOINT SPI
37	REC320981	320981	TAPA	WEAR PLATE	COPERCHIO	COUVERCLE
38	REC315788	315788	RETÉN	SEAL	TENUTA	JOINT
39	REC777214	396809	IMPULSOR (1979-88)	IMPELLER (1979-88)	GIRANTE (1979-88)	TURBINE (1979-88)
39	REC331901	331901	CHAVETA BLANCA (1979-88)	KEY, WHITE (1979-88)	CHIAVE, BIANCO (1979-88)	CLAVETTE, BLANCHE (1979-88)
39	REC344470	344470	CHAVETA NEGRA (1979-88)	KEY, BLACK (1979-88)	CHIAVE, NERO (1979-88)	CLAVETTE NOIRE (1979-88)
39	REC777213	377230	IMPULSOR (1975-78)	IMPELLER (1975-78)	GIRANTE (1975-78)	TURBINE (1975-78)
39	REC308928	308928	CHAVETA (1975-78)	KEY (1975-78)	CHIAVE (1975-78)	CLAVETTE (1975-78)
40	REC320775	320775-6	TAPA BOMBA	PUMP CUP	COPERCHIO POMPA	INSERT DE POMPE
41	REC384087	384087	CUERPO BOMBA	PUMP HOUSING	CORPO POMPA	CORPS DE POMPE
42	REC315837	315837	GRUESO	GROMMET	SPESSORE	CALE
43	REC315838	315838	TUBO GUÍA	TUBE GUIDE	TUBO GUIDA	TUBE GUIDE
44	REC331980	331980	TORNILLO	SCREW	VITE	VIS
45	REC339543	303059	TÓRICA	O-RING	O-RING	JOINT TORIQUE
46	REC341732	341732	GRUESO	GROMMET	SPESSORE	CALE

2T 40 - 60 HP 2 CYL LOOPCHARGED (1975-06) • 60 - 75 HP 2 CYL LOOPCHARGED (1975-01)
 STROKES COLA LARGA | LARGE GEARCASE | PIEDE LUNGO | EMBASE LONGUE

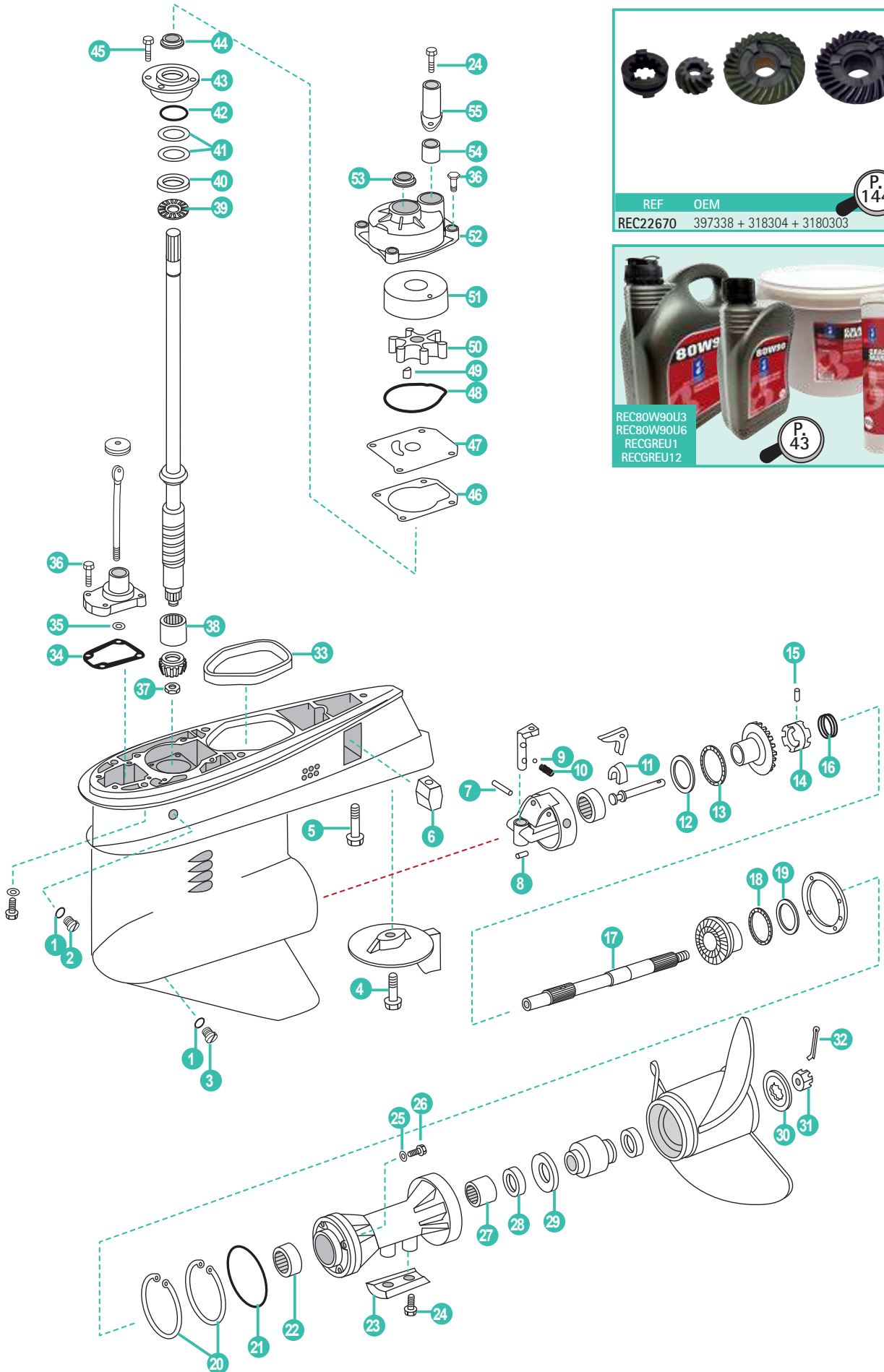

	REF	OEM				
1	REC12-191833	311598	JUNTA	GASKET	GUARNIZIONE	JOINT
2	REC10-79953Q04	307551	TORNILLO	SCREW	VITE	VIS
3	REC22-67892A05	318544	TORNILLO DRENAJE	DRAINING SCREW	VITE DRENAGGIO	VIS VIDANGE
4	REC313715	313715	TORNILLO	SCREW	VITE	VIS
5	REC328096	328096	TORNILLO	SCREW	VITE	VIS
6	REC436745AL	436745	ANODO	ANODE	ANODO	ANODE
7	REC320145	320145	PASADOR	PIN	CHIAVISTELLO	PIN
8	REC331880	331880	PASADOR	PIN	CHIAVISTELLO	PIN
9	REC327345	327345	BOLA	DETENT BALL	SFERA	BILLE
10	REC911961	911961	MUELLE	SPRING	MOLLA	RESSOR
11	REC334163	334163	REGULADOR EJE	CRADLE	REGOLATORE ASSE	REGULATEUR D'AXE
12	REC324766	324766	ARANDELA	THRUST WASHER	RONDELLA	RONDELLE
13	REC385043	385043	ARANDELA COJINETE	THRUST BEARING	RONDELLA CUSCINETTO	RONDELLE ROULEMENT
14	REC318303	318303	SELECTOR	CLUTCH DOG	SELETTORE	CRABOT
15	REC313448	313448	PASADOR	CROSS PIN	CHIAVISTELLO	GROUPELLE FENDUE
16	REC324369	324369	MUELLE	SPRING	MOLLA	RESSORT
17	REC439185	439185	EJE HÉLICE	PROP SHAFT	ASSE ELICA	ARBRE D'HÉLICE
18	REC382408	382408	ARANDELA COJINETE	THRUST BEARING	RONDELLA CUSCINETTO	RONDELLE ROULEMENT
19	REC313447	313447	ARANDELA	THRUST WASHER	RONDELLA	RONDELLE
20	REC313445	313445	ARO RETENEDOR	RETAINING RING	ANELLO RITENITORE	RONDELLE DE RETENUE
21	REC967344	313446	TÓRICA	O-RING	O-RING	JOINT TORIQUE
22	REC382407	382407	COJINETE	BEARING	CUSCINETTO	ROULEMENT
23	CM431708	431708	ANODO	ANODE	ANODO	ANODE
24	REC908158	908158	TORNILLO	SCREW	VITE	VIS
25	REC3852045	332584	TÓRICA	O-RING	O-RING	JOINT TORIQUE
26	REC320041	320041	TORNILLO	SCREW	VITE	VIS
27	REC379504	379504	COJINETE	BEARING	CUSCINETTO	ROULEMENT
28	REC330137	330137	RETÉN ACEITE	OIL SEAL	PARAOLIO	JOINT SPI
29	REC127084	127084	ARANDELA	THRUST WASHER	RONDELLA	RONDELLE
30	REC315810	315810	ESPACIADOR HÉLICE	PROP SPACER	SPESSORE ELICA	RONDELLE BUTEE D'HELICE
31	REC314503	314503	TUERCA HÉLICE	PROP NUT	DADO ELICA	ÉCROU D'HÉLICE
32	REC314502	314502	PASADOR	COTTER PIN	CHIAVISTELLO	PIN
33	REC324937	324937	RETÉN	SEAL	TENUTA	JOINT SPI
34	REC314082	314082	JUNTA	GASKET	GUARNIZIONE	JOINT
35	REC318372	318372	TÓRICA	O-RING	O-RING	JOINT TORIQUE
36	REC302325	302325	TORNILLO	SCREW	VITE	VIS
37	REC313339	313339	TUERCA PIÑÓN	PINION NUT	DADO PIGNONE	ÉCROU
38	REC382343	382343	COJINETE	BEARING	CUSCINETTO	ROULEMENT
39	REC385068	385068	ARANDELA COJINETE	THRUST BEARING	RONDELLA CUSCINETTO	RONDELLE ROULEMENT
40	REC317230	317230	ARANDELA	THRUST WASHER	RONDELLA	RONDELLE
41	REC323889	323889	SUPLEMENTO .003	SHIM .003	SUPPLEMENTO .003	CALE .003
	REC323890	323890	SUPLEMENTO .004	SHIM .004	SUPPLEMENTO .004	CALE .004
	REC317232	317232	SUPLEMENTO .005	SHIM .005	SUPPLEMENTO .005	CALE .005
42	REC313754	313754	TÓRICA	O-RING	O-RING	JOINT TORIQUE
43	REC385087	385087	CUERPO COJINETE Y RETÉN	BEARING HOUSING & SEAL	CORPO CUSCINETTO E PARAOLIO	LOGEMENT JOINT SPI
	REC435519	435519	CUERPO COJINETE Y RETÉN	BEARING HOUSING & SEAL	CORPO CUSCINETTO E PARAOLIO	LOGEMENT JOINT SPI
44	REC342786	342786	RETÉN ACEITE	OIL SEAL	PARAOLIO	JOINT SPI
45	REC909386	909386	TORNILLO	SCREW	VITE	VIS
46	REC336530	336530	JUNTA	GASKET	GUARNIZIONE	JOINT
47	REC341038	341038	TAPA	WEAR PLATE	COPERCHIO	COUVERCLE
48	REC319586	319586	JUNTA (1975-78)	GASKET (1975-78)	GUARNIZIONE (1975-78)	JOINT (1975-78)
	REC324981	324981	RETÉN (1979-06)	SEAL (1979-06)	TENUTA (1979-06)	JOINT SPI (1975-78)
	REC308928	308928	CHAVETA (1975-78)	KEY (1975-78)	CHIAVE (1975-78)	CLAVETTE (1975-78)
	REC331901	331901	CHAVETA BLANCA (1979-06)	KEY, WHITE (1979-06)	CHIAVE, BIANCO (1979-06)	CLAVETTE BLANCHE (1979-06)
	REC334897	334897	CHAVETA NEGRA (1979-06)	KEY, BLACK (1979-06)	CHIAVE, NERO (1979-06)	CLAVETTE NOIRE (1979-06)
50	REC765431	382547	IMPULSOR (1975-78)	IMPELLER (1975-78)	GIRANTE (1975-78)	TURBINE (1975-78)
	REC396725	396725	IMPULSOR (1979-06)	IMPELLER (1979-06)	GIRANTE (1979-06)	TURBINE (1979-06)
51	REC340619	340619	TAPA BOMBA	PUMP CUP	COPERCHIO POMPA	INSERT DE POMPE
52	REC438543	438543	CUERPO BOMBA	PUMP HOUSING	CORPO POMPA	CORPS DE POMPE
53	REC341732	341732	GRUESO	GROMMET	SPESSORE	CALE
54	REC314008	314008	GRUESO	GROMMET	SPESSORE	CALE
55	REC319276	319276	TUBO GUÍA	TUBE GUIDE	TUBO GUIDA	TUBE GUIDE

2T V4 60° (1995-06) RATIO 2.00:1 (.50)
STROKES

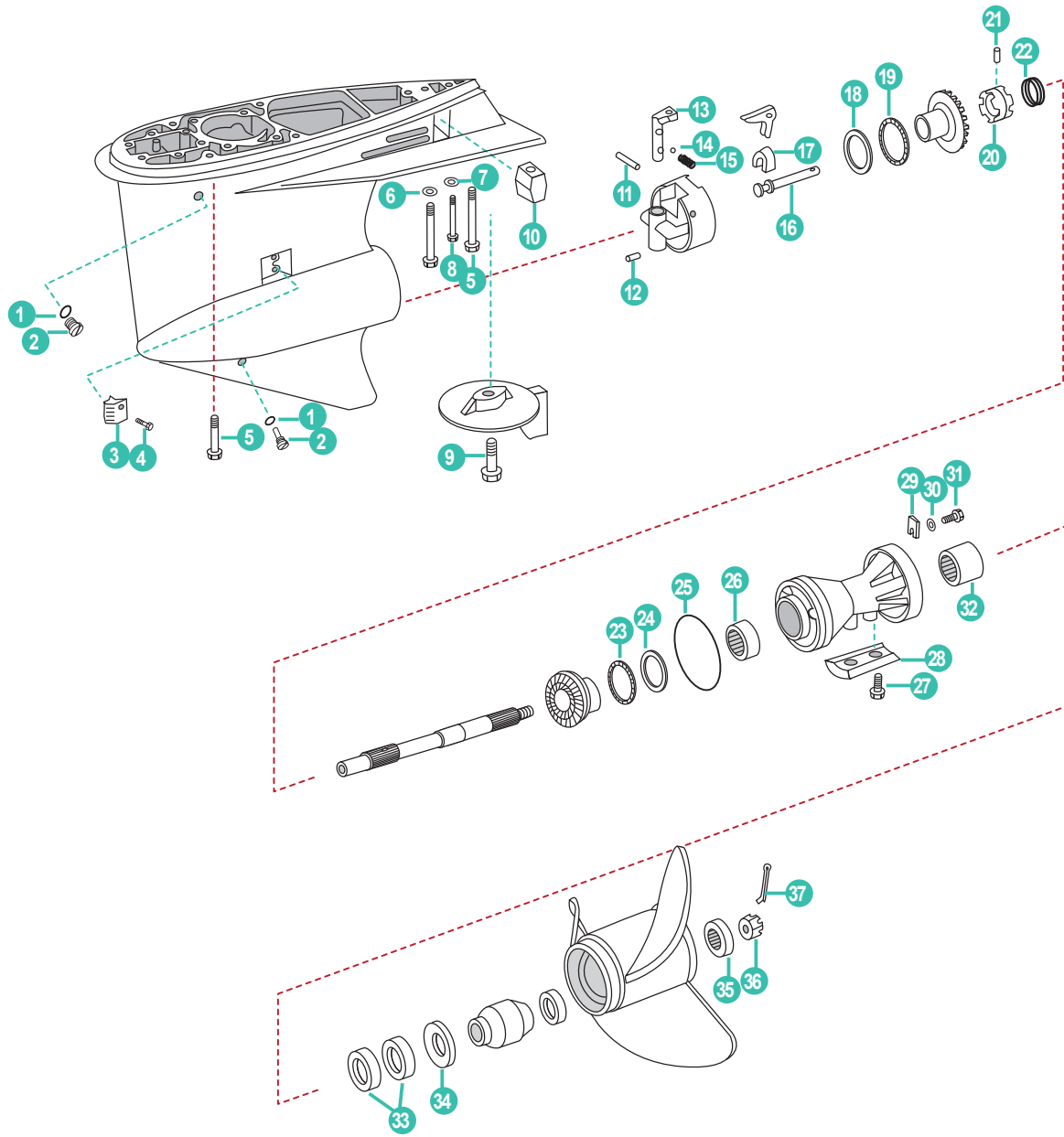

	REF	OEM				
1	REC3855081	311598	JUNTA	GASKET	GUARNIZIONE	JOINT DE VIDANGE
2	REC22-67892A05	318544	TORNILLO DRENAJE	DRAINING SCREW	VITE DRENAGGIO	VIS DE VIDANGE
3	REC337778	337778	REJILLA	SCREEN	VITE	VIS
4	REC337061	337061	TORNILLO	SCREW	VITE	VIS
5	REC331999	331999	TORNILLO	SCREW	VITE	VIS
6	REC330265	330265	ARANDELA	WASHER	RONDELLA	RONDELLE
7	REC307161	307161	CIERRE	LOCKWASHER	CHIUSURA	RONDELLE GROWER
8	REC341219	341219	TORNILLO	SCREW	VITE	VIS
9	REC313763	313715	TORNILLO	SCREW	VITE	VIS
10	REC436745AL	436745	ÁNODO	ANODE	ANODO	ANODE
11	REC320145	320145	PASADOR	PIN	CHIAVISTELLO	PIN
12	REC323664	331880	PASADOR	PIN	CHIAVISTELLO	PIN
13	REC915954	915954	EJE VARILLA CAMBIO	DETENT	ASSE BACCHETTA CAMBIO	ARBRE CHANGEMENT DE VITESSE
14	REC911961	911961	MUELLE	SPRING	MOLLA	RESSORT
15	REC327345	327345	BOLA	DETENT BALL	SFERE	BILLE
16	REC322941	322941	EJE	SHAFT	ASSE	ARBRE
17	REC334163	334163	REGULADOR EJE	CRADLE	REGOLATORE ASSE	REGULATEUR D'AXE
18	REC324766	324766	ARANDELA	THRUST WASHER	RONDELLA	RONDELLE
19	REC385043	385043	ARANDELA COJINETE	THRUST BEARING	RONDELLA CUSCINETTO	RONDELLE ROULEMENT
20	REC323664	323664	SELECTOR	CLUTCH DOG	SELETTORE	CRABOT
21	REC313448	313448	PASADOR	PIN	CHIAVISTELLO	PIN
22	REC324369	324369	MUELLE	SPRING	MOLLA	RESSORT
23	REC382408	382408	ARANDELA COJINETE	THRUST BEARING	RONDELLA CUSCINETTO	RONDELLE ROULEMENT
24	REC314731	314731	ARANDELA	THRUST WASHER	RONDELLA	RONDELLE
25	REC967344	313446	TÓRICA	O-RING	O-RING	JOINT TORIQUE
26	REC382407	382407	COJINETE	BEARING	CUSCINETTO	ROULEMENT
27	REC908158	908158	TORNILLO	SCREW	VITE	VIS
28	CM431708	431708	ÁNODO	ANODE	ANODO	ANODE
29	REC333957	333957	PESTAÑA SUJECCIÓN	TAB	LEVA DI SOSTEGNO	BAGUE DE RETENUE
30	REC328743	328743	ARANDELA	WASHER	RONDELLA	RONDELLE
31	REC350271	350271	TORNILLO	SCREW	VITE	VIS
32	REC379504	379504	COJINETE	BEARING	CUSCINETTO	ROULEMENT
33	REC330137	330137	RETÉN ACEITE	OIL SEAL	PARAOILIO	JOINT SPI
34	REC127084	127084	ARANDELA 3 PALAS	THRUST WASHER (3-BLADE)	RONDELLA 3 PALE	RONDELLE 3 PALES
35	REC315810	315810	ESPACIADOR	SPACER	DISTANZIATORE	RONDELLE BUTEE D'HELICE
36	REC314503	314503	TUERCA HÉLICE	PROP NUT	DADO ELICA	ECROU D'HELICE
37	REC314502	314502	PASADOR	COTTER PIN	CHIAVISTELLO	PIN

2T V4 60° (1995-06) RATIO 2.00:1 (.50)
STROKES

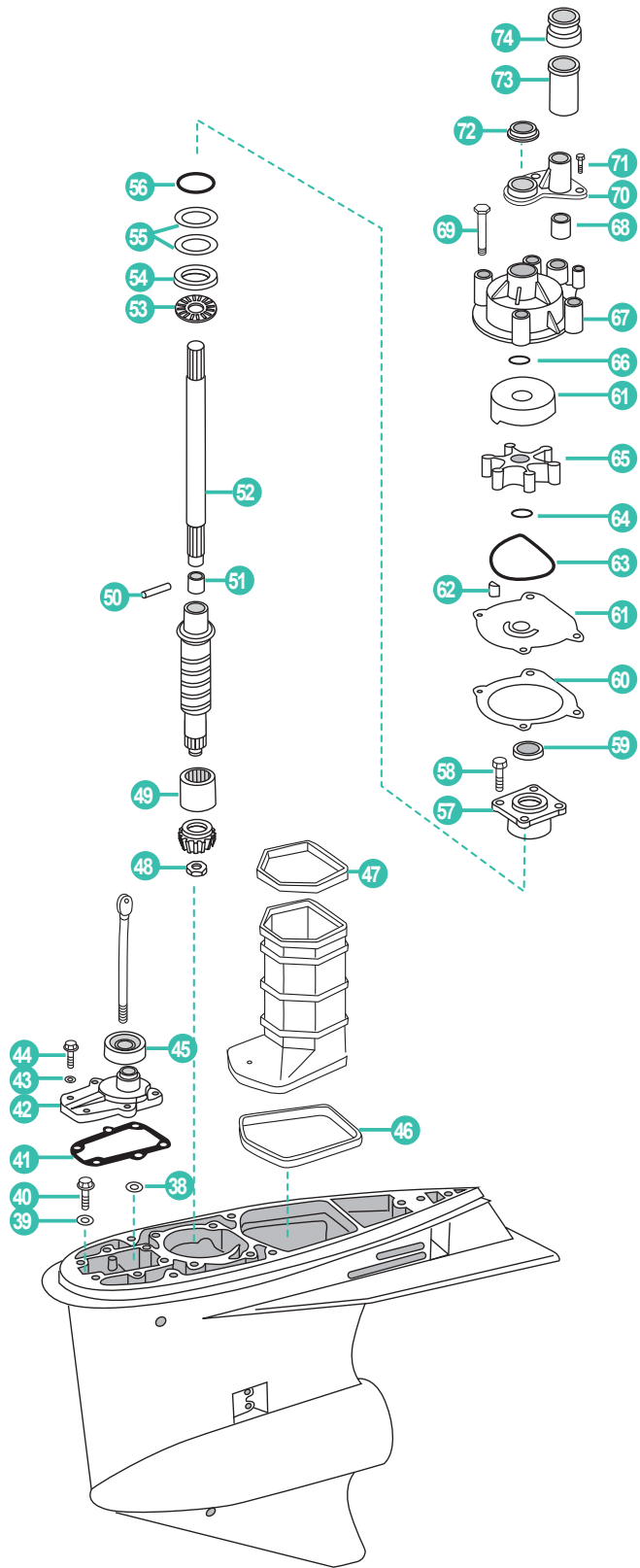

	REF	OEM				
38	REC318372	318372	TÓRICA	O-RING	O-RING	JOINT TORIQUE
39	REC437330	437330	ARANDELA CIERRE	SEAL WASHER	RONDELLA CHIUSURA	RONDELLE
40	REC341220	341220	TORNILLO	SCREW	VITE	VIS
41	REC324670	324670	JUNTA	GASKET	GUARNIZIONE	JOINT
42	REC5006241	5006241	TAPA Y RETÉN	COVER & SEAL ASSEMBLY	COPERCHIO E PARAOLIO	PLAQUE AVEC JOINT SPI
43	REC328702	328702	ARANDELA	WASHER	RONDELLA	RONDELLE
44	REC302325	302325	TORNILLO	SCREW	VITE	VIS
45	REC321008	321008	GRUESO	GROMMET	SPESSORE	CALE
46	REC320961	320961	RETÉN	SEAL	TENUTA	JOINT
47	REC320936	320936	RETÉN	SEAL	TENUTA	JOINT
48	REC11-35921	314730	TUERCA	NUT	DADO	ÉCROU
49	REC384195	384195	PIÑÓN COJINETE	PINION BEARING	PIGNONE CUSCINETTO	ROULEMENT À AIGUILLES
50	REC311538	311538	PASADOR	PIN	CHIAVISTELLO	PIN
51	REC338504	338504	RETENEDOR	RETAINER	FERMO	RETENUE
52	REC5000615	5000615	EJE COLA	DRIVE SHAFT	ASSE PIEDE	ARBRE EMBASE
53	REC387656	387656	ARANDELA COJINETE	THRUST BEARING	RONDELLA CUSCINETTO	RONDELLE ROULEMENT
54	REC327656	327656	ARANDELA	THRUST WASHER	RONDELLA	RONDELLE
55	REC323362	323362	SUPLEMENTO .003	SHIM .003	SPESSORE .003	CALE .003
	REC323361	323361	SUPLEMENTO .004	SHIM .004	SPESSORE .004	CALE .004
	REC314745	314745	SUPLEMENTO .005	SHIM .005	SPESSORE .005	CALE .005
56	REC314728	314728	TÓRICA	O-RING	O-RING	JOINT TORIQUE
57	REC439476	439476	CUERPO COJINETE Y RETÉN	BEARING HOUSING & SEAL	CORPO CUSCINETTO E PARAOLIO	PALLIER DE ROULEMENT ET JOINT SPI
58	REC317624	317624	TORNILLO	SCREW	VITE	VIS
59	REC341280	341280	RETÉN ACEITE	OIL SEAL	PARAOLIO	JOINT SPI
60	REC338484	338484	JUNTA	GASKET	GUARNIZIONE	JOINT
61	REC435027	435027	TAPA Y PLATO	CUP & PLATE ASSEMBLY	COPERCHIO E PIATTO	INSERT DE POMPE
62	REC331107	331107	CHAVETA	KEY	CHIAVE	CLAVETTE
63	REC331353	331353	RETÉN	SEAL	TENUTA	JOINT SPI
64	REC302035	302035	TÓRICA	O-RING	O-RING	JOINT TORIQUE
65	REC5001593	435821	IMPULSOR	IMPELLER	GIRANTE	TURBINE
66	REC331188	331188	TÓRICA	O-RING	O-RING	JOINT TORIQUE
67	REC5007968	435959	CUERPO BOMBA (TRANSOM 25")	PUMP HOUSING (25 TRANSOM)	CORPO POMPA (TRANSOM 25")	CORPS DE POMPE (TRANSOM 25")
	REC435990	435990	CUERPO BOMBA (TRANSOM 20")	PUMP HOUSING (20 TRANSOM)	CORPO POMPA (TRANSOM 20")	CORPS DE POMPE (TRANSOM 20")
68	REC314008	314008	GRUESO	GROMMET	SPESSORE	CALE
69	REC302325	302325	TORNILLO	SCREW	VITE	VIS
70	REC338893	338893	TUBO GUÍA	TUBE GUIDE	TUBO GUIDA	TUBE GUIDE
71	REC306643	306643	TORNILLO	SCREW	VITE	VIS
72	REC320943	320943	GRUESO	GROMMET	SPESSORE	CALE
73	REC338636	338636	TUBO ESPACIADOR CORTO	TUBE SPACER (SHORT)	TUBO DISTANZIATORE CORTO	TUBE GUIDE
74	REC354580	338601	GRUESO	GROMMET	SPESSORE	CALE

2T V4 / V6 "0" (1979-06) RATIO V4 2.25:1 (.44), V6 1.86:1 (.54)
STROKES

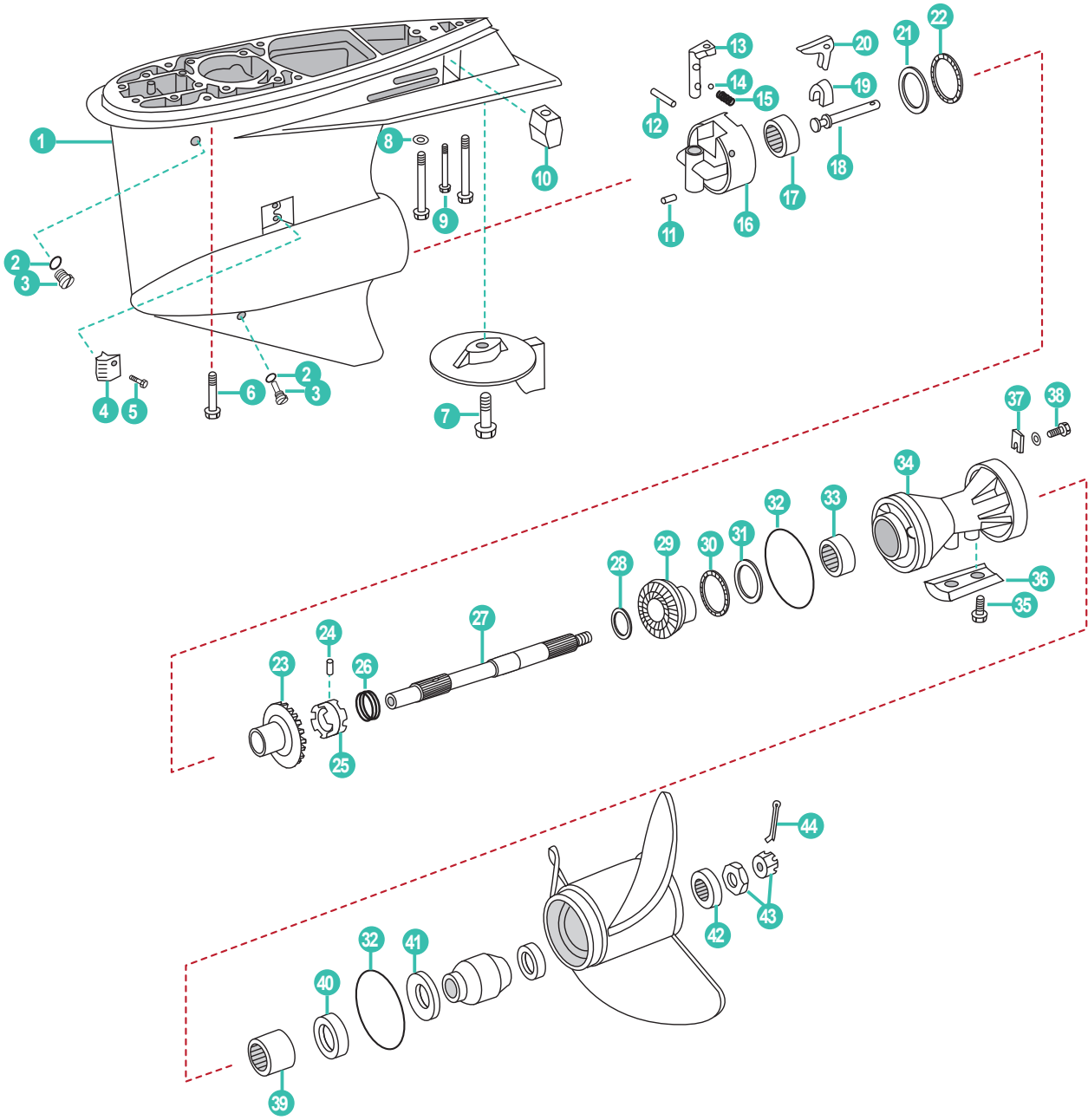

	REF	OEM				
1	REC439973 REC5007022	439973 439972	CARCASA COLA Y TUBO CARCASA COLA	GEARCASE ASSEMBLY / TUBE GEARCASE ASSEMBLY	CARCASSA PIEDE E TUBO CARCASSA PIEDE	EMBASE EMBASE COMPLET
2	REC3855081	311598	JUNTA	GASKET	GUARNIZIONE	JOINT
3	REC22- 67892A05	318544	TORNILLO DRENAJE	DRAINING SCREW	VITE DRENAGGIO	VIS VIDANGE
4	REC337778	337778	REJILLA	SCREEN	GRIGLIA	GRILLE
5	REC337061	337061	TORNILLO	SCREW	VITE	VIS
6	REC331999	331999	TORNILLO	SCREW	VITE	VIS
7	REC313715	313715	TORNILLO	SCREW	VITE	VIS
8	REC330265	330265	ARANDELA	WASHER	RONDELLA	RONDELLE
9	REC328096	328096	TORNILLO	SCREW	VITE	VIS
10	REC436745AL	436745	ÁNODO	ANODE	ANODO	ANODE
11	REC331880	331880	PASADOR	PIN	CHIAVISTELLO	PIN
12	REC328825	328825	PASADOR	PIN	CHIAVISTELLO	PIN
13	REC915954	915954	EJE VARILLA CAMBIO	DETENT	ASSE BACCHETTA CAMBIO	ARBRE CHANGEMENT DE VITESSE
14	REC160084	160084	BOLA	DETENT BALL	SFERA	BILLE
15	REC911962	911962	MUELLE	SPRING	MOLLA	RESSORT
16	REC389455	389455	CUERPO Y COJINETE	HOUSING & BEARING ASSEMBLY	CORPO E CUSCINETTO	PALIER DE ROULEMENT
17	REC389039	389039	COJINETE	BEARING	RONDELLA	ROULEMENT
18	REC322941	322941	EJE	SHAFT	ASSE	ARBRE
19	REC334163	334163	REGULADOR EJE	CRADLE	REGOLATORE ASSE	REGULATEUR D'AXE
20	REC322938	322938	ELEVADOR	LEVER	LEVA	CROCHET
21	REC327669	327669	ARANDELA	THRUST WASHER	RONDELLA	RONDELLE
22	REC389042	389042	ARANDELA COJINETE	THRUST BEARING	RONDELLA CUSCINETTO	RONDELLE ROULEMENT
23	REC435123	435123	KIT PIÑONES MARCHA AVANTE V4	P / FORWARD GEAR SET V4	KIT PIGNONE MARCIA AVANTI V4	KIT PIGNON MARCHE AV ET ATTAQUE
24	REC313448	313448	PASADOR	CROSS PIN	CHIAVISTELLO	GROUPILLE
25	REC337774	337774	SELECTOR	CLUTCH DOG	SELETTORE	CRABOT
26	REC324369	324369	MUELLE	SPRING	MOLLA	RESSORT
27	REC395209 REC5004765	395209 5004765	EJE HÉLICE (1-3/16") V6 EJE HÉLICE (1-1/4") V4/V6	PROP SHAFT (1-3/16") V6 PROP SHAFT (1-1/4") V4/V6	ASSE ELICA (1-3/16") V6 ASSE ELICA (1-1/4") V4/V6	ARBRE D'HÉLICE (1-3/16") V6 ARBRE D'HÉLICE (1-1/4") V4/V6
28	REC435123	336565	ARANDELA	THRUST WASHER	RONDELLA	RONDELLE
29	REC5004218	910994	MARCHA ATRÁS V6	REVERSE GEAR V6	MARCIA INDIETRO V6	MARCHE ARRIÈRE V6
30	REC382408	382408	ARANDELA COJINETE	THRUST BEARING	RONDELLA CUSCINETTO	RONDELLE ROULEMENT
31	REC314731	314731	ARANDELA	THRUST WASHER	RONDELLA	RONDELLE
32	REC305123	305123	TÓRICA	O-RING	O-RING	JOINT TORIQUE
33	REC382407	382407	COJINETE	BEARING	CUSCINETTO	ROULEMENT
34	REC5000074 REC5004257	5000074 5004257	COJINETE DIÁBOLO (1-3/16") COJINETE DIÁBOLO (1-1/4")	BEARING CARRIER (1-3/16") BEARING CARRIER (1-1/4")	CUSCINETTO (1-3/16") CUSCINETTO (1-1/4")	ROULEMENT (1-3/16") ROULEMENT (1-1/4")
35	REC908158	908158	TORNILLO	SCREW	VITE	VIS
36	CM431708	431708	ÁNODO	ANODE	ANODO	ANODE
37	REC333957	333957	LENGÜETA	TAB	LEVA DI SOSTEGNO	BAGUE DE RETENUE
38	REC350271	350271	TORNILLO	SCREW	VITE	VIS
39	REC387247 REC434467	387247 434467	COJINETE (Ø INT. 1-3/16") COJINETE (Ø INT. 1-1/4")	BEARING (INSIDE Ø 1-3/16") BEARING (INSIDE Ø 1-1/4")	CUSCINETTO (Ø INT. 1-3/16") CUSCINETTO (Ø INT. 1-1/4")	ROULEMENT (Ø INT. 1-3/16") ROULEMENT (Ø INT. 1-1/4")
40	REC341281 REC334950 REC26-76868	341281 334950 320862	RETÉN ACEITE (1-1/4") 1 PIEZA RETÉN ACEITE (1-1/4") 2 PIEZAS RETÉN ACEITE (1-3/16") 2 PIEZAS	OIL SEAL (1-1/4") 1 PC. OIL SEAL (1-1/4") 2 PCS. OIL SEAL (1-3/16") 2 PCS.	PARAOILIO (1-1/4") 1 PECE PARAOILIO (1-1/4") 2 PECE PARAOILIO (1-3/16") 2 PECE	JOINT SPI (1-1/4") 1 PIÈCE JOINT SPI (1-1/4") 2 PIÈCES JOINT SPI (1-3/16") 2 PIÈCES
41	REC126870	126870	ARANDELA	THRUST WASHER	RONDELLA	RONDELLE
42	REC320570	320570	ESPACIADOR	SPACER	DISTANZIATORE	RONDELLE BUTEE D'HELICE
43	REC398042	398042	KIT TUERCA HÉLICE	NUT & KEEPER	KIT DADO ELICA	KIT ECROU D'HELICE
44	REC3852056	306394	PASADOR	COTTER PIN	CHIAVISTELLO	PIN

2T V4 / V6 "O" (1979-06) RATIO V4 2.25:1 (.44), V6 1.86:1 (.54)
STROKES

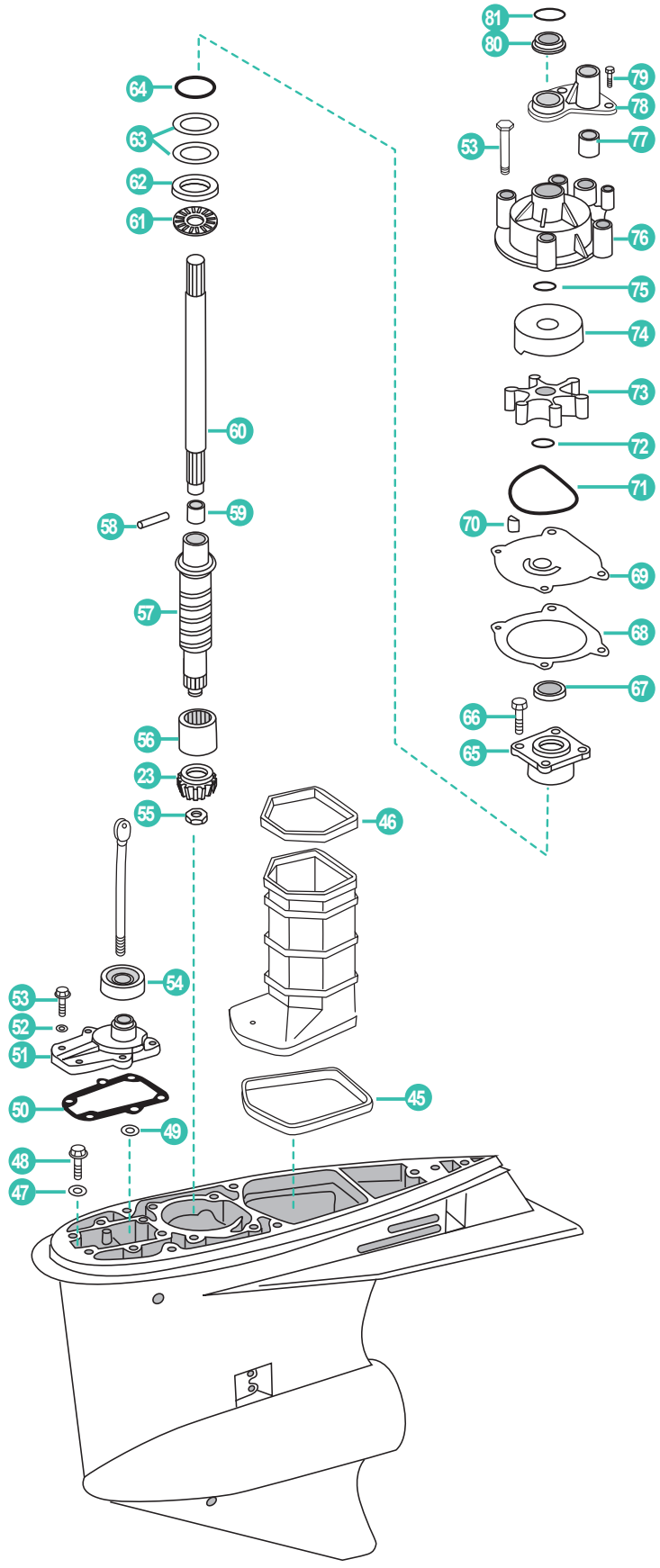

	REF	OEM				
45	REC320961	320961	RETÉN	SEAL	PARAOLIO	JOINT SPI
46	REC320936	320936	RETÉN	SEAL	PARAOLIO	JOINT SPI
47	REC437330	437330	ARANDELA	SEAL WASHER	RONDELLA	RONDELLE
48	REC341220	341220	TORNILLO	SCREW	VITE	VIS
49	REC318372	318372	TÓRICA	O-RING	O-RING	JOINT TORIQUE
50	REC324670	324670	JUNTA	GASKET	GUARNIZIONE	JOINT
51	REC5006241	5006241	TAPA CON RETÉN	COVER & SEAL ASSEMBLY	COPERCHIO E TENUTA	PLAQUE AVEC JOINT SPI
52	REC328702	328702	ARANDELA	WASHER	RONDELLA	RONDELLE
53	REC302325	302325	TORNILLO	SCREW	VITE	VIS
54	REC321008	321008	GRUESO	GROMMET	SPESSORE	CALE
55	REC11-35921	314730	TUERCA	NUT	DADO	ÉCROU
56	REC387817	387817	PIÑÓN COJINETE	PINION BEARING	PIGNONE CUSCINETTO	ROULEMENT À AIGUILLES
57	REC345905	345905	EJE TRANSMISION	LOWER DRIVE SHAFT	ALBERO DI TRASMISSIONE	ARBRE DE TRANSMISSION
58	REC311538	311538	PASADOR	PIN	CHIAVISTELLO	PIN
59	REC338504	338504	RETENEDOR	RETAINER	FERMO	RETENUE
60	REC5000615	5000615	EJE TRANSMISION SUPERIOR	DRIVE SHAFT (LONG)	ALBERO DI TRASMISSIONE SUPERIORE	ARBRE DE TRANSMISSION SUPERIEUR
61	REC387656	387656	ARANDELA COJINETE	THRUST BEARING	RONDELLA CUSCINETTO	RONDELLE ROULEMENT
62	REC327656	327656	ARANDELA	THRUST WASHER	RONDELLA	RONDELLE
63	REC323362	323362	SUPLEMENTO .003	SHIM .003	SPESSORE .003	CALE .003
	REC323361	323361	SUPLEMENTO .004	SHIM .004	SPESSORE .004	CALE .004
	REC314745	314745	SUPLEMENTO .005	SHIM .005	SPESSORE .005	CALE .005
64	REC314728	314728	TÓRICA	O-RING	O-RING	JOINT TORIQUE
65	REC439476	439476	CUERPO COJINETE Y RETÉN	BEARING HOUSING & SEAL	CORPO E CUSCINETTO	PALLIER DE ROULEMENT ET JOINT SPI
66	REC317624	317624	TORNILLO	SCREW	VITE	VIS
67	REC341280	341280	RETÉN ACEITE	OIL SEAL	PARAOLIO	JOINT SPI
68	REC338484	338484	JUNTA	GASKET	GUARNIZIONE	JOINT
69	REC338485	338485	TAPA	WEAR PLATE	COPERCHIO	PLAQUE DE POMPE
70	REC777129	331107	CHAVETA	KEY	CHIAVE	CLAVETTE
71	REC331353	331353	RETÉN	SEAL	PARAOLIO	JOINT SPI
72	REC302035	302035	TÓRICA	O-RING	O-RING	JOINT TORIQUE
73	REC5001593	5001593	IMPULSOR	IMPELLER	GIRANTE	TURBINE
74	REC338486	338486	TAPA BOMBA	PUMP CUP	COPERCHIO POMPA	INSERT DE POMPE
75	REC331188	331188	TÓRICA	O-RING	O-RING	JOINT TORIQUE
76	REC435990	435990	CUERPO BOMBA TRANSOM 20"	PUMP HOUSING (20 TRANSOM)	CORPO POMPA (TRANSOM 20")	CORPS DE POMPE (TRANSOM 20")
	REC5007968	435959	CUERPO BOMBA TRANSOM 25"	PUMP HOUSING (25 TRANSOM)	CORPO POMPA (TRANSOM 25")	CORPS DE POMPE (TRANSOM 25")
77	REC314008	314008	GRUESO	GROMMET	SPESSORE	CALE
78	REC338893	338893	TUBO GUÍA	TUBE GUIDE	TUBO GUIDA	TUBE GUIDE
79	REC306643	306643	TORNILLO	SCREW	VITE	VIS
80	REC320943	320943	GRUESO	GROMMET	SPESSORE	CALE
81	REC320961	320961	RETÉN	SEAL	PARAOLIO	JOINT SPI

2T V4 / V6 "M" (1979-06) RATIO V4 2.25:1 (.44), V6 1.86:1 (.54)
STROKES

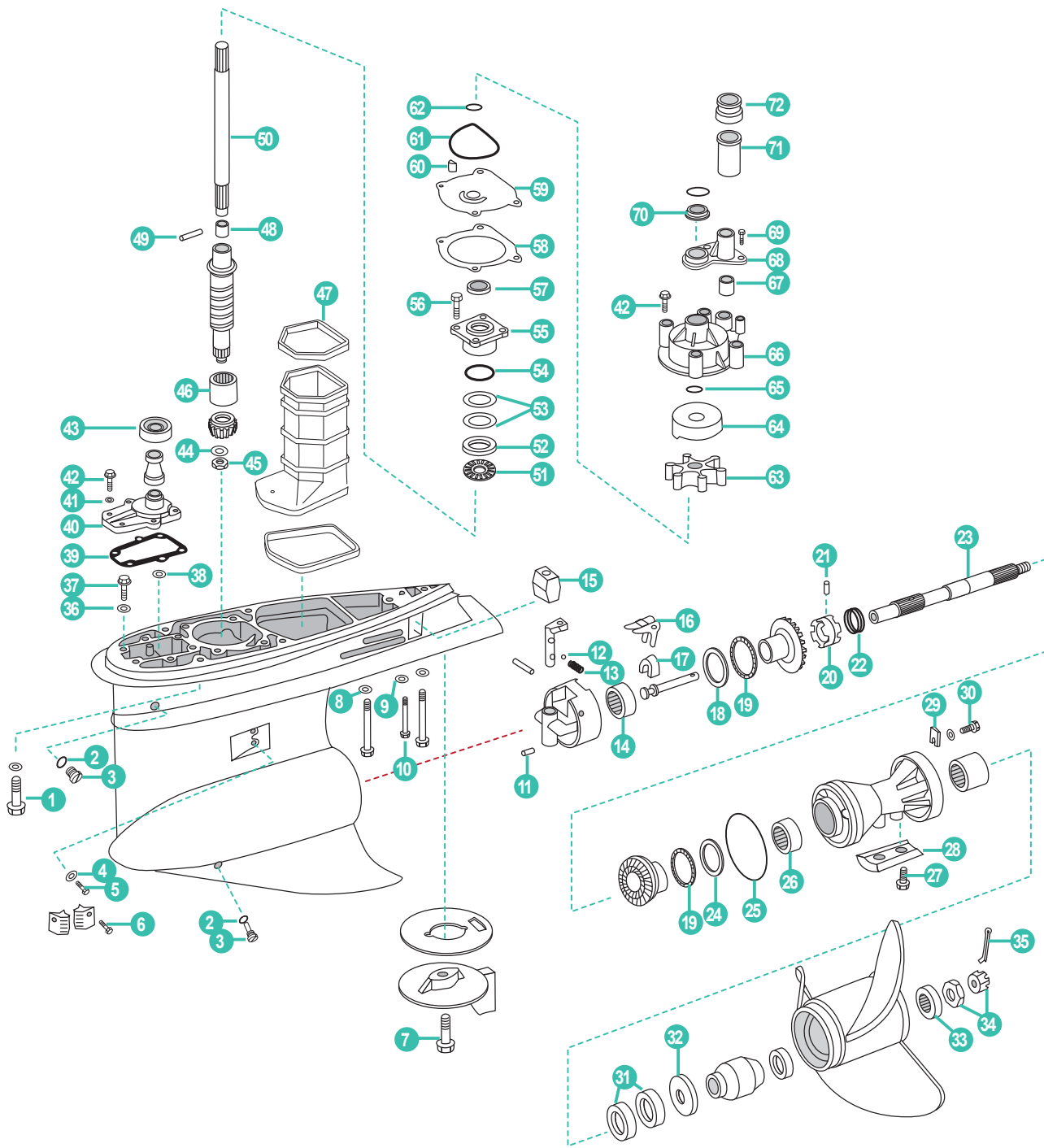

	REF	OEM				
1	REC331999	331999	TORNILLO	SCREW	VITE	VIS
2	REC3855081	311598	JUNTA	GASKET	GUARNIZIONE	JOINT
3	REC22-67892A05	318544	TORNILLO DRENAJE	DRAINING SCREW	VITE DRENAGGIO	VIS VIDANGE
4	REC332584	332584	RETÉN	SEAL	TENUTA	RETAINEUR
5	REC324852	324852	TORNILLO	SCREW	VITE	VIS
6	REC337061	337061	TORNILLO	SCREW	VITE	VIS
7	REC313715	313715	TORNILLO	SCREW	VITE	VIS
8	REC330265	330265	ARANDELA	WASHER	RONDELLA	RONDELLE
9	REC307161	307161	CIERRE	LOCK WASHER	CHIUSURA	RONDELLE GROWER
10	REC341219	341219	TORNILLO	SCREW	VITE	VIS
11	REC331880	331880	PASADOR	PIN	CHIAVISTELLO	PIN
12	REC160084	160084	BOLA	DETENT BALL	SFERA	BILLE
13	REC911962	911962	MUELLE	SPRING	MOLLA	RESSORT

	REF	OEM				
14	REC389039	389039	COJINETE	BEARING	CUSCINETTO	ROULEMENT
15	REC436745AL	436745	ÁNODO	ANODE	ANODO	ANODE
16	REC322938	322938	ELEVADOR	LEVER	LEVA	CROCHET
17	REC334163	334163	REGULADOR EJE	CRADLE	REGOLATORE ASSE	REGULATEUR D'AXE
18	REC327669	327669	ARANDELA	THRUST WASHER	RONDELLA	RONDELLE
19	REC389042	389042	ARANDELA COJINETE	THRUST BEARING	RONDELLA CUSCINETTO	RONDELLE ROULEMENT
20	REC337774	337774	SELECTOR	CLUTCH DOG	SELETTORE	CRABOT
21	REC313448	313448	PASADOR	CROSS PIN	CHIAVISTELLO	PIN
22	REC324369	324369	MUELLE	SPRING	MOLLA	RESSORT
23	REC356900 REC5004765	347371 5004765	EJE TRANSMISION EJE HÉLICE	LOWER DRIVE SHAFT PROP SHAFT	ASSE TRASMISSIONE ASSE ELICA	ARBRE DE TRANSMISSION ARBRE D'HELICE
24	REC349193	349193	ARANDELA	THRUST WASHER	RONDELLA	RONDELLE
25	REC326849	326849	TÓRICA	O-RING	O-RING	JOINT TORIQUE
26	REC382407	382407	COJINETE	BEARING	CUSCINETTO	ROULEMENT
27	REC908158	908158	TORNILLO	SCREW	VITE	VIS
28	CM431708	431708	ÁNODO	ANODE	ANODO	ANODE
29	REC333957	333957	LENGÜETA	TAB	LEVA DI SOSTEGNO	BAGUE DE RETENUE
30	REC350271	350271	TORNILLO	SCREW	VITE	VIS
31	REC341281 REC334950	341281 334950	RETÉN ACEITE 1 PIEZA RETÉN ACEITE 2 PIEZAS	OIL SEAL - 1 PC. OIL SEAL - 2 PCS.	PARAOLIO 1 PEZZO PARAOLIO 2 PEZZI	JOINT SPI 1 PIÈCE JOINT SPI 2 PIÈCES
32	REC126870	126870	ARANDELA	THRUST WASHER	RONDELLA	RONDELLE
33	REC320570	320570	ESPACIADOR	SPACER	DISTANZIALE	CALE
34	REC398042	398042	KIT TUERCA HÉLICE	NUT & KEEPER	KIT DADI ELICA	KIT TUERCA HELICE
35	REC3852056	306394	PASADOR	COTTER PIN	CHIAVISTELLO	PIN
36	REC437330	437330	ARANDELA	SEAL WASHER	RONDELLA	RONDELLE
37	REC341220	341220	TORNILLO	SCREW	VITE	VIS
38	REC318372	318372	TÓRICA	O-RING	O-RING	JOINT TORIQUE
39	REC324670	352165	JUNTA	GASKET	GUARNIZIONE	JOINT
40	REC5006241	5006241	TAPA Y RETÉN	COVER & SEAL ASSEMBLY	COPERCHIO E PARAOLIO	PLAQUE AVEC JOINT SPI
41	REC328702	328702	ARANDELA	WASHER	RONDELLA	RONDELLE
42	REC302325	302325	TORNILLO	SCREW	VITE	VIS
43	REC321008	321008	GRUESO	GROMMET	SPESSORE	CALE
44	REC350038	350038	ARANDELA	WASHER	RONDELLA	RONDELLE
45	REC11-35921	314730	TUERCA	NUT	DADO	ÉCROU
46	REC387817	387817	COJINETE PIÑÓN	PINION BEARING	CUSCINETTO PIGNONE	ROULEMENT À AIGUILLES
47	REC320936	320936	RETÉN	SEAL	PARAOLIO	JOINT SPI
48	REC338504	338504	RETENEDOR	RETAINER	FERMO	RETENUE
49	REC311538	311538	PASADOR	PIN	CHIAVISTELLO	PIN
50	REC5000614 REC5007672 REC5000624	5000614 5000623 5000624	EJE LARGO COLA 20" EJE LARGO COLA 25" EJE LARGO COLA 25"	DRIVE SHAFT 20" L DRIVE SHAFT 25" L DRIVE SHAFT 25" L	ASSE LUNGO PIEDE 20" ASSE LUNGO PIEDE 25" ASSE LUNGO PIEDE 25"	ARBRE DE TRANSMISSION 20" ARBRE DE TRANSMISSION 25" ARBRE DE TRANSMISSION 25"
51	REC387656	387656	ARANDELA COJINETE	THRUST BEARING	RONDELLA CUSCINETTO	RONDELLE ROULEMENT
52	REC327656	327656	ARANDELA	THRUST WASHER	RONDELLA	RONDELLE
53	REC323362 REC323361 REC314745	323362 323361 314745	SUPLEMENTO .003 SUPLEMENTO .004 SUPLEMENTO .005	SHIM .003 SHIM .004 SHIM .005	SPESSORE .003 SPESSORE .004 SPESSORE .005	CALE .003 CALE .004 CALE .005
54	REC314728	314728	TÓRICA	O-RING	O-RING	JOINT TORIQUE
55	REC439476	439476	CUERPO COJINETE Y RETÉN	BEARING HOUSING & SEAL	CORPO CUSCINETTO E PARAOLIO	PALLIER DE ROULEMENT ET JOINT SPI
56	REC317624	317624	TORNILLO	SCREW	VITE	VIS
57	REC341280	341280	RETÉN ACEITE	OIL SEAL	PARAOLIO	JOINT SPI
58	REC338484	338484	JUNTA	GASKET	GUARNIZIONE	JOINT
59	REC338485	338485	TAPA BOMBA	WEAR PLATE	COPERCHIO POMPA	PLAQUE DE POMPE
60	REC331107	331107	CHAVETA	KEY	CHIAVE	CLAVETTE
61	REC331353	331353	RETÉN	SEAL	TENUTA	JOINT
62	REC302035	302035	TÓRICA	O-RING	O-RING	JOINT TORIQUE
63	REC5001593	5001593	IMPULSOR	IMPELLER	GIRANTE	TURBINE
64	REC338486	338486	TAPA BOMBA	PUMP CUP	COPERCHIO POMPA	INSERT DE POMPE
65	REC331188	331188	TÓRICA	O-RING	O-RING	JOINT TORIQUE
66	REC435990	435959	CUERPO BOMBA	PUMP HOUSING	CORPO POMPA	CORPS DE POMPE
67	REC314008	314008	GRUESO	GROMMET	SPESSORE	CALE
68	REC338893	338893	TUBO GUÍA	TUBE GUIDE	TUBO GUIDA	TUBE GUIDE
69	REC306643	306643	TORNILLO	SCREW	VITE	VIS
70	REC320943	320943	GRUESO	GROMMET	SPESSORE	CALE
71	REC338636	338636	TUBO ESPACIADOR	TUBE SPACER	TUBO DISTANZIATORE	TUBE GUIDE
72	REC354580	338601	GRUESO	GROMMET	SPESSORE	CALE

	REF	OEM				
1	REC10-79953Q04	307551	TAPÓN DRENAJE	DRAIN PLUG	TAPPO DRENAGGIO	BOUCHON DE VIDANGE
2	REC313715	313715	TORNILLO	SCREW, TRIM TAB	VITE	VIS
3	REC316506	316506	BOLA RETENEDORA	DETENT BALL	SFERA	BILLE
4	REC320635	320635	PIÑÓN Y MARCHA ADELANTE	PINION & FORWARD GEAR	PIGNONE E MARCIA IN AVANTI	KIT PIGNON AVANT
5	REC337774	320630	SELECTOR	CLUTCH DOG	SELETTORE	CRABOT
6	REC313448	313448	PASADOR SELECTOR	PIN, CLUTCH DOG	CHIAVISTELLO SELETTORE	PIN
7	REC324369	324369	MUELLE SELECTOR	SPRING, CLUTCH DOG	MOLLA SELETTORE	RESSORT
8	REC382408	382408	TOPE COJINETE	REVERSE THRUST BEARING	PUNTA CUSCINETTO	ROULEMENT
9	REC314731	314731	TOPE COJINETE	REVERSE THRUST WASHER	PUNTA CUSCINETTO	ROULEMENT
10	REC305123	305123	TÓRICA	O-RING PROP SHAFT CARRIER	O-RING	JOINT TORIQUE
11	REC316563	316563	TORNILLO	CARRIER RETAINER SCREW	VITE	VIS
12	REC387247	387247	AGUJA COJINETE EJE HÉLICE	NEEDLE BEARING, PROP SHAFT	AGHI CUSCINETTO ASSE ELICA	ROULEMENT À AIGUILLES
13	REC26-76868	320862	RETÉN EJE HÉLICE	PROP SHAFT SEAL	PARAOLIO ASSE ELICA	JOINT TORIQUE
14	REC320570	320570	TOPE HÉLICE	PROP NUT SPACER	PUNTA ELICA	RONDELLE BUTEE D'HELICE
15	REC5008966	320569	TUERCA HÉLICE	PROP NUT	DADO ELICA	ÉCROU D'HÉLICE
16	REC309955	309955	PASADOR TUERCA HÉLICE	PROP NUT COTTER PIN	CHIAVISTELLO DADO ELICA	GOUPILLE
17	REC320140	320140	ARO CAMBIO	O-RING, SHIFT	O-RING CAMBIO	JOINT TORIQUE
18	REC318372	318372	TÓRICA	O-RING, SHIFT ROD	O-RING	JOINT TORIQUE
19	REC11-35921	314730	TUERCA PIÑÓN	PINION NUT	DADO PIGNONE	ÉCROU
20	REC387817	387817	COJINETE PIÑÓN	PINION BEARING	CUSCINETTO PIGNONE	ROULEMENT
21	REC387656	387656	TOPE COJINETE	PINION, THRUST BEARING	PUNTA CUSCINETTO	ROULEMENT
22	REC327656	327656	TOPE ARANDELA	PINION, THRUST WASHER	PUNTA RONDELLA	RONDELLE
23	REC314745	314745	SUPLEMENTO .005	SHIM .005	SPESSORE .005	CALE .005
24	REC314728	314728	ARO COJINETE EJE COLA	O-RING DRIVE SHAFT BEARING	O-RING CUSCINETTO ASSE PIEDE	JOINT TORIQUE ROULEMENT D'ARBRE
25	REC439476	439476	CUERPO COJINETE Y RETÉN	BEARING HOUSING & SEAL	CORPO CUSCINETTO E PARAOLIO	CORS ROULEMENT ET JOINT
26	REC26-69188	321453	RETÉN ACEITE EJE COLA	OIL SEAL, DRIVE SHAFT	PARAOLIO, ASSE PIEDE	JOINT SPI
27	REC338484	338484	JUNTA TAPA	GASKET, PLATE	GUARNIZIONE COPERCHIO	JOINT
28	REC338485	321188	TAPA IMPULSOR	PLATE, IMPELLER	COPERCHIO GIRANTE	PLAQUE DE POMPE
29	REC308928	308928	CHAVETA	IMPELLER KEY	CHIAVE	CLAVETTE
30	REC331353	331353	RETÉN DE TAPA A CUERPO	SEAL, PLATE TO HOUSING	PARAOLIO DEL COPERCHIO E CORPO	JOINT SPI
31	REC777212	385528	IMPULSOR BOMBA AGUA	IMPELLER, W.P.	GIRANTE POMPA ACQUA	TURBINE
32	REC331188	321175	ARO IMPULSOR	O-RING IMPELLER	O-RING GIRANTE	JOINT TORIQUE
33	REC338486	338486	ACOPLE INOX	CUP	ACCOPIAMENTO INOX	INSERT INOX
34	REC5007968	435959	CUERPO	HOUSING	CORPO	CORPS DE POMPE
35	REC13-35048	305981	ARANDELA TORNILLO	WASHER, SCREW	RONDELLA, VITE	RONDELLE
36	REC302325	302873	TORNILLO BOMBA AGUA	SCREW, WATER PUMP	VITE, POMPA ACQUA	VIS
37	REC26-69188	321453	RETÉN	SEAL	TENUTA	JOINT SPI
38	REC314008	314008	GRUESO TUBO AGUA	WATER TUBE GROMMET	SPESSORE TUBO ACQUA	BAGUE DE TUBE D'EAU
39	REC338893	338893	TAPA TUBO AGUA	WATER TUBE COVER	COPERCHIO TUBO ACQUA	COUVERCLE TUBE D'EAU
40	REC306643	306643	TORNILLOS TAPA TUBO AGUA	WATER TUBE COVER SCREWS	VITI COPERCHIO TUBO ACQUA	VIS
41	REC320943	320943	GRUESOS TAPA TUBO AGUA	WATER TUBE COVER GROMMET	SPESSORE COPERCHIO TUBO ACQUA	BAGUE DE POMPE A EAU
42	REC25-30613	310585	TÓRICA	O-RING	O-RING	JOINT TORIQUE



REC80W90U3
REC80W90U6
RECGREU1
RECGREU12

P. 43

PIEZAS TRANSMISIÓN

STERN DRIVE PARTS

PARTI PIEDE

PIECES D'EMBASES

PIÑONES MARCHA AVANTE

POSITIVE GEAR

REF	OEM	RATIO	4T STROKES	2T STROKES
REC435123	435123	12:27		✓



REF	OEM	J10 / J15 (2002-04)	4T STROKES	2T STROKES
REC57510-93910	5033191		✓	



PIGNONI MARCIA AVANTI

PIGNON MARCHÉ AVANT

REF	OEM	J 4, 5, 6 HP	4T STROKES	2T STROKES
REC57510-91J00	5034203 5030277 5031203		✓	



REF	OEM	J/BJ 25, 30 HP	4T STROKES	2T STROKES
REC57510-89J00	5032698 5032099 5036016		✓	



PIÑONES MARCHA ATRÁS

REVERSE GEAR

REF	OEM	J/BJ 25, 30 HP	4T STROKES	2T STROKES
REC57521-96312	5032100		✓	



PIGNONI MARCIA INDIETRO

PIGNON MARCHÉ ARRIÈRE

REF	OEM	J10 / J15 (2002-04)	4T STROKES	2T STROKES
REC57521-93910	5033192		✓	



REF	OEM	J4, 5, 6 HP	4T STROKES	2T STROKES
REC57521-91J00	5030278		✓	



REF	OEM	J/BJ 25, 30 HP	4T STROKES	2T STROKES
REC57521-89J00	5032100		✓	



KITS DE PIÑONES COMPLETO

COMPLETE GEAR SET

REF	OEM
REC5004218	5004218



KIT PIGNONI COMPLETO

KIT PIGNONS COMPLET

REF	OEM
REC986979	22631 + 22632 + 22633





PIÑONES ATAQUE

INITIATIVE GEAR

PIGNONI INIZIATIVA

PIGNON D'ATTAQUE

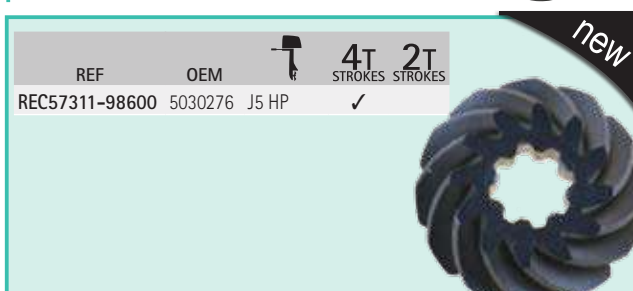
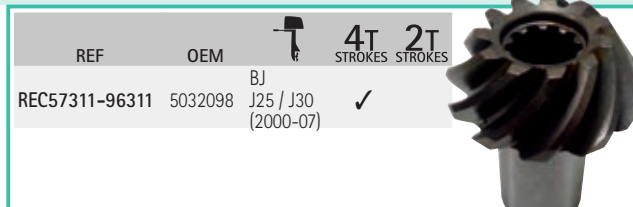
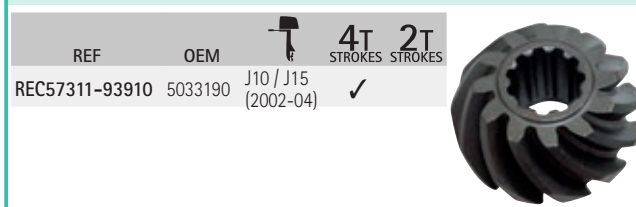

GRUESO PINONES ATAQUE

SHIM INITIATIVE GEAR

SPESSORE PIGNONI INIZIATIVA

CALE PIGNON D'ATTAQUE

REF	OEM	4T STROKES	2T STROKES	Thickness
REC09160-20044	5032969			0.7
REC09160-20041	5032985	J10 / J15	✓	1.0
REC09160-20042	5032967	(2002-07)	✓	1.1
REC09160-20043	5032968			1.2

ARANDELA PINONES ATAQUE

WASHER INITIATIVE GEAR

RONDELLA PIGNONI INIZIATIVA

RONDELLE PIGNON D'ATTAQUE

REF	OEM	4T STROKES	2T STROKES	Dimensions
REC09160-26015	5031232	E40 / J40 / BJ40	✓	26.2 x 42 x 4.0 mm
REC09160-21009	5032970	E50 / J50 / BJ50 (1999-06)	✓	21 x 35 x 2.75 mm
REC09160-20027	5032966	J10, J15 (2002-07)	✓	
	5032966	J10, J15 (2002-07)	✓	

SELECTOR

CLUTCHS DOGS

SELETTORE

CRABOT

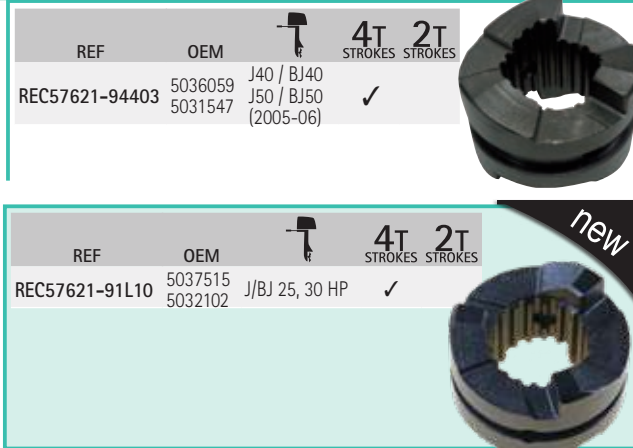

MUELLE PARA SELECTOR SPRING CLUTCH

REF	OEM	
REC09440-32008	5033037	J/BJ 10, 15 HP



new

REF	OEM		
REC09440-40002	5031286	REC57621-94403	J/BJ 40, 50 HP



new

MOLLA SELETTORE

REF	OEM	
REC09440-05027	5033034	J 10, 15 HP



new

RESSORT DE SELECTEUR

PIN

REF	OEM	
REC57632-97L00	5030282	J4, 5, 6, 10, 15 HP



new

PIN

SPINOTTO

REF	OEM	
REC09202-05022	5031245	J/BJ 40, 50 HP



new

PIN

PASADOR PARA SELECTOR CLUTCH PIN

REF	OEM	
REC57634-88L00	5031251	J/BJ 40, 50 HP



new

PIN SELETTORE

REF	OEM	
REC09209-08016	5031880	J/BJ 25 ,30 HP



new

PIVOT

VARILLA PARA SELECTOR ROD PUSH

REF	OEM	
REC57631-93901	5033196	J10, 15 HP



new

ASTA PRESSIONE

REF	OEM	
REC57631-95303	5031549	J/BJ 40, 50 HP







new

TIGE DE POUSSEE

REF	OEM	
REC57631-96301	5032103	J/BJ 25 ,30 HP



new

		KIT + 	KIT		
2 & 3 CYL LOOPCHARGED					
25D	1989-05	REC22660			REC332491
35 (AR, AE & AT)	1987		REC433570	REC433570	REC319895
40	1975-88		REC433570	REC433570	REC319895
40	1989-05	REC22660			REC332491
48	1987-88		REC433570	REC433570	REC319895
18	1989-96	REC22660			REC332491
50	1979-88		REC433570	REC433570	REC319895
50	1989-05	REC22660			REC332491
50 (S CYD)	1995-97	REC22670			REC318303
55 Elect	1979-81		REC433570	REC433570	REC319895
60 Elec	1980-88		REC433570		REC319895
60 (3-Cyl. 20)	1986-97	REC22670			REC318303
65 Comm.	1984-97	REC22670			REC318303
70 E	1975	REC22670			REC318303
70 20	1976-97	REC22670			REC318303
75 20	1975-88	REC22670			REC318303
V4					
85	1977				REC323664
85	1978-80, 1991-95	REC986979			REC323664
88	1987-96	REC986979			REC323664
90	1981-97	REC986979			REC323664
90 V4 60° 2.25:1 "O"	1995-99	GLM22650	REC435123		REC337774
100	1979-80	REC986979			REC323664
100	1989-90	REC986979			REC323664
100 2.25:1 "O"	1991	GLM22650	REC435123		REC337774
100 Comm. (S)	1989-90	REC986979			REC323664
100 Comm. 2.25:1 "O"	1987, 92, 93	GLM22650	REC435123		REC337774
100 Comm. D 2.25:1 "O"	1994-99	GLM22650	REC435123		REC337774
100 Comm. (E J) 2.25:1 "O"	1989	GLM22650	REC435123		REC337774
100 Comm. "O"	1990	GLM22650	REC435123		REC337774
110	1986-89	REC986979			REC323664
112	1994-96	REC986979			REC323664
115	1977	REC986979			REC323664
115	1990-97	REC986979			REC323664
115 V4 60° 2.25:1 "O"	1995-99	GLM22650	REC435123		REC337774
120	1986-92	REC986979			REC323664
120 2.25:1 "O"	1990	GLM22650	REC435123		REC337774
120 TL, TX	1993	REC986979			REC323664
120 TX 2.25:1 "O"	1993	GLM22650	REC435123		REC337774
125 Comm. (ESX)	1989-90	REC986979			REC323664
125 Comm. 2.25:1 "O"	1989-92	GLM22650	REC435123		REC337774
125 Comm. E, R 2.25:1 "O"	1993-96	GLM22650	REC435123		REC337774
125 ESX (F) 2.25:1 "O"	1993	GLM22650	REC435123		REC337774
125 ESX (S)	1993	REC986979			REC323664
130 2.25:1 "O"	1997	GLM22650	REC435123		REC337774
140	1978-84	REC986979			REC323664
140	1986-87	REC986979			REC323664
140 TL	1988-94	REC986979			REC323664
140 TX 2.25:1 "O"	1988-90, 92, 93	GLM22650	REC435123		REC337774
V6					
150	1978		REC320635		REC337774
150	1979-87	REC5004218			REC337774
150	1988-90	REC5004218			REC337774
150	1991-97	REC5004218			REC337774
150 Comm.	1993-95	REC5004218			REC337774
150 Comm.	1989-90	REC5004218			REC337774
155 Comm. WTA	1989	GLM22650	REC435123		REC337774
155 Comm. WTP	1989	REC5004218	REC323664		REC337774
175	1977-78		REC320635		REC337774
175	1979-87	REC5004218			REC337774
175	1988-90	REC5004218	REC323664		REC337774
175	1991-97	REC5004218			REC337774
185	1984-85	REC5004218			REC337774
185	1990	REC5004218			REC337774
185	1991-94	REC5004218			REC337774
200	1976-78		REC320635		REC337774
200	1979-83	REC5004218			REC337774
200	1986-87	REC5004218	REC323664		REC337774
200	1988-90	REC5004218			REC337774
200	1991-06	REC5004218			REC337774
200 Comm.	1990-91	REC5004218			REC337774
225	1986-87	REC5004218			REC337774
225	1988-90	REC5004218			REC337774
225	1991-06	REC5004218			REC337774
235	1978		REC320635		REC337774
235	1979-85	REC5004218			REC337774
1.6L Comm.	1988	GLM22650	REC435123		REC337774

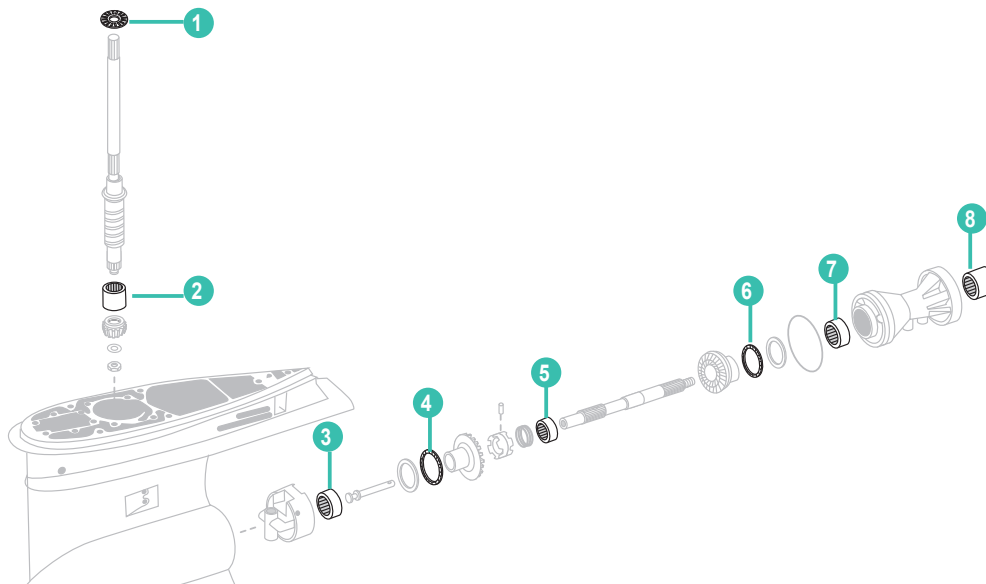

GUÍA COJINETES COLA	LOWER HOUSING BEARING GUIDE	GUIDA CUSCINETTI PIEDE			GUIDE ROULEMENT D'EMBASE				
		1	2	3	4	5	6	7	8
2 CYL. LOOPCHARGED (1975-85) 40 - 60 HP									
40	1984-85								
50	1975-85	REC31-32575T1	REC386766					REC386764	REC386765
55	1976-85								
60	1980-85								
2 CYL. LOOPCHARGED (1986-05) 40 - 60 HP									
40 Pequeño antiguo Small Old	1986-88	REC31-32575T1	REC386766					REC386764	REC386765
Gambo corto vecchio Petit, ancien									
40 Pequeño nuevo Small New	1989-00	REC398901	REC382343	REC382407	REC397538	REC432264	REC397537	REC386764	REC386765
Gambo corto nuovo Petit, nouveau		REC333771			REC333725		REC332514		
45 Pequeño nuevo Small New	1989-97	REC398901	REC382343	REC382407	REC397538		REC397537	REC386764	REC386765
Gambo corto nuovo Petit, nouveau		REC333771			REC333725		REC332514		
45 Largo Large Lungo Longue	1987-97	REC385068	REC382343	REC382407	REC385043		REC382408	REC382407	REC379504
		REC317230			REC324766		REC313447		
48 Pequeño nuevo Small New	1989-96	REC398901	REC382343	REC382407	REC397538	REC432264	REC397537	REC386764	REC386765
Gambo corto nuovo Petit, nouveau		REC333771			REC333725		REC332514		
48 Largo Large Lungo Longue	1987-96	REC385068	REC382343	REC382407	REC385043		REC382408	REC382407	REC379504
		REC317230			REC324766		REC313447		
50 Pequeño antiguo Small Old	1986-88	REC31-32575T1	REC386766					REC386764	REC386765
Gambo corto vecchio Petit, ancien									
50 Pequeño nuevo Small New	1989-05	REC398901	REC382343	REC382407	REC397538	REC432264	REC397537	REC386764	REC386765
Gambo corto nuovo Petit, nouveau		REC333771			REC333725		REC332514		
50 Largo Large Lungo Longue	1986-05	REC385068	REC382343	REC382407	REC385043		REC382408	REC382407	REC379504
		REC317230			REC324766		REC313447		
55 Pequeño antiguo Small Old	1986-88	REC31-32575T1	REC386766					REC386764	REC386765
Gambo corto vecchio Petit, ancien									
55 Pequeño nuevo Small New	1989-05	REC398901	REC382343	REC382407	REC397538		REC397537	REC386764	REC386765
Gambo corto nuovo Petit, nouveau		REC333771			REC333725		REC332514		
55 Largo Large Lungo Longue	1986-05	REC385068	REC382343	REC382407	REC385043		REC382408	REC382407	REC379504
		REC317230			REC324766		REC313447		
60 Pequeño antiguo Small Old	1986-88	REC31-32575T1	REC386766					REC386764	REC386765
Gambo corto vecchio Petit, ancien									
60 Largo Large Lungo Longue	1986-88	REC385068	REC382343	REC382407	REC385043		REC382408	REC382407	REC379504
		REC317230			REC324766		REC313447		
3 CYL. LOOPCHARGED (1973-01) 65 - 75 HP									
65 Largo Large Lungo Longue	1973	REC385068	REC382343	REC382407	REC385043		REC382408	REC382407	REC379504
		REC317230			REC324766		REC313447		
65 Largo Large Lungo Longue	1984-01	REC385068	REC382343	REC382407	REC385043		REC382408	REC382407	REC379504
		REC317230			REC324766		REC313447		
70 Pequeño Small Corto Petit	1974-01	REC31-32575T1	REC386766					REC386764	REC386765
75 Pequeño Small Corto Petit	1979-85	REC31-32575T1	REC386766					REC386764	REC386765
75 Largo Large Lungo Longue	1975-88	REC385068	REC382343	REC382407	REC385043		REC382408	REC382407	REC379504
		REC317230			REC324766		REC313447		
V4 (1978-83)									
85	1978-80	REC387656	REC384195	REC382407	REC385043		REC382408	REC382407	REC379504
		REC327656			REC324766		REC314731		
V4 (1984+)									
80 Pequeño Small Corto Petit	1991-99	REC387656	REC384195	REC382407	REC385043		REC382408		REC379504
		REC327656			REC324766		REC314731		
80 "0"	1991-99	REC387656	REC387817	REC389039	REC389042		REC382408	REC382407	REC434467
		REC327656			REC327669		REC314731		
90 Pequeño Small Corto Petit	1984-03	REC387656	REC384195	REC382407	REC385043		REC382408	REC382407	REC379504
		REC327656			REC324766		REC314731		
90 "0"	1984-90	REC387656	REC387817	REC389039	REC389042		REC382408	REC382407	REC387247
		REC327656			REC327669		REC314731		
90 "0"	1991-03	REC387656	REC387817	REC389039	REC389042		REC382408	REC382407	REC434467
		REC327656			REC327669		REC314731		
100 Pequeño Small Corto Petit	1984-05	REC387656	REC384195	REC382407	REC385043		REC382408	REC382407	REC379504
		REC327656			REC324766		REC314731		
100 "0"	1984-90	REC387656	REC387817	REC389039	REC389042		REC382408	REC382407	REC387247
		REC327656			REC327669		REC314731		
100 "0"	1991-05	REC387656	REC387817	REC389039	REC389042		REC382408	REC382407	REC434467
		REC327656			REC327669		REC314731		
115 Pequeño Small Corto Petit	1984	REC387656	REC384195	REC382407	REC385043		REC382408	REC382407	REC379504
		REC327656			REC324766		REC314731		

		1	2	3	4	5	6	7	8
115 "O" Type	1984-90	REC387656 REC327656	REC387817	REC389039	REC389042 REC327669		REC382408 REC314731	REC382407	REC387247
115 "O" Type	1991	REC387656 REC327656	REC387817	REC389039	REC389042 REC327669		REC382408 REC314731	REC382407	REC434467
120 "O" Type	1985-90	REC387656 REC327656	REC387817	REC389039	REC389042 REC327669		REC382408 REC314731	REC382407	REC387247
120 "O" Type	1991-94	REC387656 REC327656	REC387817	REC389039	REC389042 REC327669		REC382408 REC314731	REC382407	REC434467
125 "O" Type	1989-90	REC387656 REC327656	REC387817	REC389039	REC389042 REC327669		REC382408 REC314731	REC382407	REC387247
125 "O" Type	1991-98	REC387656 REC327656	REC387817	REC389039	REC389042 REC327669		REC382408 REC314731	REC382407	REC434467
130 Pequeño Small Corto Court	1995-00	REC387656 REC327656	REC384195	REC382407	REC385043 REC324766		REC382408 REC314731	REC382407	REC379504
130 "O" Type	1995-00	REC387656 REC327656	REC387817	REC389039	REC389042 REC327669		REC382408 REC314731	REC382407	REC434467
135 Pequeño Small Corto Court	2001	REC387656 REC327656	REC384195	REC382407	REC389042 REC327669		REC382408 REC314731	REC382407	REC379504
135 "O" Type	2001	REC387656 REC327656	REC387817	REC389039	REC389042 REC327669		REC382408 REC314731	REC382407	REC434467
135 "M"	2002	REC387656 REC327656	REC387817	REC389039	REC389042 REC327669		REC389042 REC349193	REC382407	
140 Pequeño Small Corto Court	1984	REC387656 REC327656	REC384195	REC382407	REC385043 REC324766		REC382408 REC314731	REC382407	REC379504
140 "O"	1985-90	REC387656 REC327656	REC387817	REC389039	REC389042 REC327669		REC382408 REC314731	REC382407	REC387247
140 "O"	1991-94	REC387656 REC327656	REC387817	REC389039	REC389042 REC327669		REC382408 REC314731	REC382407	REC434467
V6 (1979-90)									
150	1979-90	REC387656 REC327656	REC387817	REC389039	REC389042 REC327669		REC382408 REC314731	REC382407	REC387247
V6 (1991+)									
150 "O"	1991	REC387656 REC327656	REC387817	REC389039	REC389042 REC327669		REC382408 REC314731	REC382407	REC434467
150 "M"	2002						REC389042		
175 "M"	2002						REC389042		
175 "O"	1991						REC349193 REC382408		
185 "O"	1993-94						REC314731 REC382408		
200 "O"	1991						REC314731 REC382408		
200 "M"	2002						REC314731 REC389042		
225 "O"	1991						REC349193 REC382408		
225 "M"	2002						REC314731 REC389042 REC349193		

EJE TRANSMISIÓN INFERIOR		LOWER DRIVE SHAFT				ASSE TRANSMISSIONE INFERIORE		ARBRE DE TRANSMISSION INFERIEUR			
REF	OEM			Ø	2	1		REF	OEM		
REC346006	346006	V4 90°	8 - 3/4"		1 - 1/8"	6	V4 All Crossflow	1978-97	Small V4 90°	REC346006	346006
REC345905	345905	"O"	9 - 1/2"		1 - 1/8"	19	V4 All Crossflow	1984-97	"O"	REC345905	345905
REC356900	347371	"M"	9 - 1/2"		1 - 1/8"	20	V4 90° Loopcharged	1985-98	"O"	REC345905	345905
REC335679	335679	V8	10"		1 - 9/32"	19	V4 60°	1995-06	"O"	REC345905	345905
							V6 90°	1978-06	"O"	REC345905	345905
							V6 60°	1991-06	"O"	REC345905	345905
							V6	2002-06	"M"	REC356900	347371



















EJE TRANSMISIÓN INFERIOR. COJINETES		LOWER DRIVE SHAFT BEARING		ALBERO DI TRASMISSIONE INFERIORE, CUSCINETTO		ROULEMENT D'ARBRE DE TRANSMISSION INFERIEUR	
REF	OEM						
REC09263-22L03	5031256	J/BJ 40, 50 HP			REC09263-20046	5031883	J/BJ 25, 30 HP
REC09263-15019	5033002	J10, 15 HP					

EJE TRANSMISIÓN SUPERIOR			UPPER DRIVE SHAFT	ASSE TRANSMISSIONE SUPERIORE			ARBRE DE TRANSMISSION SUPERIEUR		
REF	OEM			REF	OEM		TRANSOM		
REC5000618	5000618	25 - 1/4"		J10 J15	2002-07	REC57100-93902	5033188	20"	
REC5000626	5000626	30 - 1/4"		V4 All	1978-91	REC5000618	5000618	25 - 1/4"	20" Standard
REC5000614	5000614	25 - 11/16"		V4 All	1978-91	REC5000626	5000626	30 - 1/4"	25" Standard
REC5007672	5000623	30 - 11/16"		V4 90°	1992-98	REC5000614	5000614	25 - 11/16"	20" Standard
REC5000615	5000615	24 - 3/4"		V4 90°	1992-98	REC5007672	5000623	30 - 11/16"	25" Standard
REC5000624	5000624	29 - 3/4"		V4 60°	1995-06	REC5000615	5000615	24 - 3/4"	20" Standard
				V4 60°	1995-06	REC5000624	5000624	29 - 3/4"	25" Standard
				V6 All	1976-91	REC5000618	5000618	25 - 1/4"	20" Standard
				V6 All	1976-91	REC5000626	5000626	30 - 1/4"	25" Standard
				V6 90°	1992-06	REC5000614	5000614	25 - 11/16"	20" Standard
				V6 90°	1992-06	REC5007672	5000623	30 - 11/16"	25" Standard
				V6 60°	1991-06	REC5000615	5000615	24 - 3/4"	20" Standard
				V6 60°	1991-06	REC5000624	5000624	29 - 3/4"	25" Standard

EJE TRANSMISIÓN SUPERIOR. COJINETES			UPPER DRIVE SHAFT BEARING	ALBERO DI TRANSMISSIONE SUPERIORE. CUSCINETTO			ROULEMENT D'ARBRE DE TRANSMISSION SUPERIEUR		
REF	OEM			REF	OEM				
REC08110-60020	5033299	J10, 15 HP		REC09265-17002	5031885	J/B/J 25 HP J 30 HP			

EJE HÉLICE		PROP SHAFT	ASSE ELICA			ARBRE D'HÉLICE	
REF	OEM			Ø	2	1	3
REC439138	439138	2 Cyl. Loopcharged Small	1989-05	13 - 13/32"	1.0"	13	REC320305
	436834	V4 60° Small	1995-06	16 - 9-16"	1 - 1/8"	13	REC127084
REC439185	439185	2 - 3 Cyl. Loopcharged	1975-06	14 - 29/64"	1 - 1/8"	13	REC127084
REC395209	395209	"O" Large	1979-90	17 - 27/22"	1 - 3/16"	15	
REC436888	436888	V4 90° Small	1989-05	15 - 7/16"	1 - 1/8"	13	REC127084
REC5004765	5004765	"O" Large "M" Large	1991-06 2001-06	17 - 7/8"	1 - 1/4"	15	REC126870

	REF	OEM
J10	REC57610-93901	5033193
J15	REC57610-93901	5033193
2 Cyl. Loopcharged	REC439138	439138
2 & 3 Cyl. Loopcharged	REC439185	439185
V4 All Crossflow	REC436888	436888
V4 90° All	REC395209	395209
V4 90° All	REC5004765	5004765
V4 60°	REC5004765	5004765
V6 90°	REC395209	395209
V6 90°	REC5004765	5004765
V6 60°	REC5004765	5004765
V6	REC5004765	5004765



CASQUILLO BASCULANTE		BUSH SWIVEL		TAPO GIREVOLE		BAGUE TOURNANTE			
REF	OEM		4T STROKES	2T STROKES	REF	OEM		4T STROKES	2T STROKES
REC43211-87JL0	5032058		✓		REC43711-97E11	5030852		✓	
E25, E30, E40, E50 J10, J15, J25, J30, J40, J50 BJ40, BJ50 (2000-07)				J/JBJ 60 --> 225 HP					
									
BOMBA DE ACEITE		OIL PUMP		POMPA OLIO		DE POMPE À HUILE			
REF	OEM		4T STROKES	2T STROKES					
REC43211-94401	5032058		✓						
J10, 15, 25, 30, 40, 50 HP									
									
FUELLES VARILLA DE CAMBIO		SHIFT, BELOW		MANICOTTO MARCIE		SOUFFLET DU LEVIER DE CHANGEMENT DE VITESSE			
REF	OEM				REF	OEM			
REC08110-60020	5033299				REC25222-96300	25222-96300			
J/JBJ 200, 225 HP				J25, 30 HP					
									
ARO TÓRICO VARILLA DE CAMBIO		SHIFT, O-RING		O-RING MARCE		JOINT TORIQUE DU LEVIER			
REF	OEM				REF	OEM			
REC09280-08005	5031260				REC09280-11005	5031261			
J2 --> J50 HP 1,8 x 7,7 mm				BJ/JJ 40, 50 HP 2,4 x 10,8 mm					
									
TUERCA VARILLA DE CAMBIO		TURNBUCKE, CUTCH ROD		DADO ASTA CAMBIO		ECROU DU LEVIER			
REF	OEM		4T STROKES	2T STROKES					
REC23311-95DL0	5031449		✓						
E25, E30, E40 J10, J15, J25, J30, J40, J50 BJ40, BJ50 (1999-07)									

TORNILLOS Y JUNTAS DE DRENAJE



DRAIN, SCREW AND GASKETS

VITI E GUARNIZIONE, DRENAGGIO



VIS ET JOINTS DE VIDANGE

REF	OEM		
REC09248-10008	5030094	4 --> 140 HP	10 x 7.2 mm

new

REF	OEM		
REC55128-93J10	5035151	J/BJ 200, 225 HP	

new

REF	OEM		
REC09168-10034	5034799	J/BJ 200, 225 HP	

new

REF	OEM		
REC59178-97J00	5037356	J2 HP	



new

TUBO DRENAJE BOMBA DE AGUA

DRAIN WATER TUBE

TUBO DRENAGGIO ACQUA

TUBE DE VIDANGE DE LA POMPE A EAU

REF	OEM		
REC17453-93901	5033111 5035609	J10, 15 HP	

new

DIÁBOLO

DIABOLO

DIABOLO

DIABOLO

REF	OEM		
REC56120-93900	5032743	J10, 15 HP	

new

REF	OEM		
REC56120-96332-OEP	5034711	J/BJ 25, 30 HP	



new

ARO TÓRICO DEL DIÁBOLO



DIABOLO, O-RING

O-RING DIABOLO

JOINT TORIQUE DU DIABOLO

REF	OEM		
REC09280-57002	5033010	J10, 15 HP	3.5 x 65.2 mm

new

REF	OEM		
REC09280-75001	5031263	J/BJ 40, 50 HP	3.3 x 75 mm

new

COJINETE DE DIÁBOLO

DIABOLO BEARING

CUSCINETTO DIABOLO

ROULEMENT DE DIABOLO

REF	OEM		
REC08110-60050	5033303	J10, 15 HP	

new

REF	OEM		
REC08113-60060	5032295	BJ/J 25, 30 HP	

new

REF	OEM		
REC09263-20047	5031884	J/BJ 25, 30 HP	

new

REF	OEM		
REC09263-22020	5031255	J/BJ 40, 50 HP	

new

BOMBA DE AGUA

WATER PUMP

POMPA ACQUA

**ROULEMENT DE POMPE
A EAU**

REF	OEM	
REC09263-25062	5031258	J/BJ 40, 50 HP



REF	OEM	
REC09263-25025	5031257	J/BJ 40, 50 HP



KIT REPARACION COLA

GEARCASE SEAL KIT

KIT RIPARAZIONE PIEDE

**KIT REPARATION
EMBASE**

**CAMBIO MECÁNICO
ESCAPE POR HELICE**

**MECHANICAL SHIFT
THRU-PROP EXHAUST**

**CAMBIO MECCANICO,
SCARICO TRAMITE L'ELICA**

**CHANGEMENT DE VITESSE
MECANIQUE**

REF	OEM	
REC396350	396350	9.9, 15 HP (-1974)



REF	OEM	
REC396351	396351	2 Cyl. Crossflow 20, 25, 30, 35 HP



REF	OEM	
REC433550	433550	40, 48, 50 HP 2 cyl Loopcharged (1989-05)



REF	OEM	
REC396355	396355	Cola pequeña Small housing Gambo corto Courte 2 cyl Loopcharged (1975-88) 40 - 60 HP 3 cyl Loopcharged (1975-88) 60 - 75 HP



REF	OEM	
REC5000309	5000309	Cola larga Large housing Gambo lungo Longue 2 cyl Loopcharged (1975-06) 40 - 60 HP 3 cyl Loopcharged (1975-01) 60 - 75 HP



**CAMBIO MECÁNICO
V4, V6, V8 (1978-06)**

**MECHANICAL SHIFT
V4, V6, V8 (1978-06)**

**CAMBIO MECCANICO
V4, V6, V8 (1978-06)**

**CHANGEMENT MÉCANIQUE
V4, V6, V8 (1978-06)**

REF	OEM
REC5006373	5006373

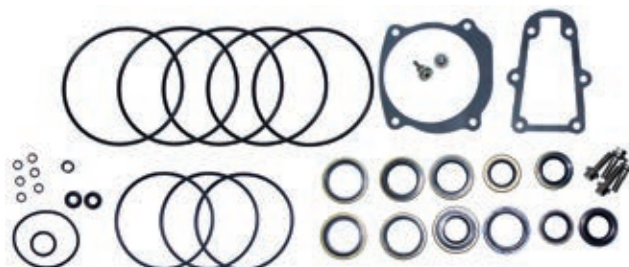

CAMBIO ELÉCTRICO ESCAPE EN ALETA DE CAVITACION

ELECTRIC SHIFT CAVITATION PLATE EXHAUST

CAMBIO ELETTRICO SCARICO NELL'ALETTA DI CAVITAZIONE

CHANGEMENT DE VITESSE ELECTRIQUE ECHAP PAR LA PLAQUE DE CAVITATION

REF	OEM	
REC87608	V4 (1962-68)	



CAMBIO ELÉCTRICO/HIDRAULICO ESCAPE A TRAVES DE HELICE

ELECTRIC / HYDRAULIC SHIFT THRU-PROP-EXHAUST

CAMBIO ELETTRICO / IDRAULICO CON SCARICO DALL'ELICA

CHANGEMENT DE VITESSE ELECTRIQUE / HYDRAU ECHAP PAR L'HELICE

REF	OEM	
REC87622	2 Cyl Loopcharged (1971-74)	

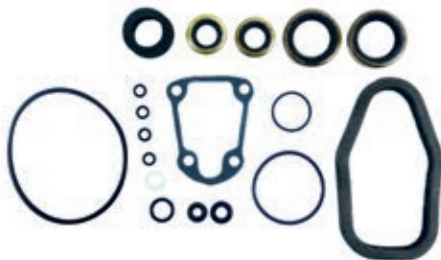

REF	OEM	
REC43713	55, 100, 125 HP V4 Crossflow (1971-72)	



COLA DE 2 PIEZAS CON ESCAPE EN ALETA DE CAVITACION

TWO-PIECE GEARCASE WITH CAVITATION PLATE EXHAUST

PIEDE 2 PIECI CON SCARICO NELL'ALETTA DI CAVITAZIONE

CARTER EN DEUX PARTIES ECHAPPEMENT PAR LA PLAQUE DE CAVITATION

REF	OEM	
REC87604	5.5, 6 HP (1955-67)	



REF	OEM	
REC87607	25, 28, 30, 33, 35, 40 HP (1955-73) Cambio manual Manual shift Cambio manuale Changement manual	



REF	OEM	
REC87606	18 HP (1958-65)	

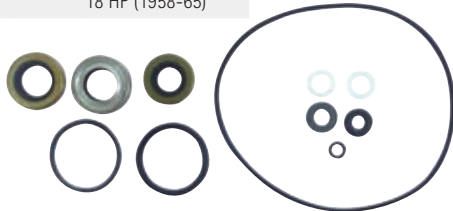

REF	OEM	
REC87617	18 HP (16 HP (1968-79))	



REF	OEM	
REC87619	20, 25 HP (1979-82)	



REF	OEM	
REC396352	396352 25, 28 HP (1985+)	



GUÍA KITS REPARACIÓN

GEARCASE SEAL KIT APPLICATION

GUIDA KIT RIPARAZIONE PIEDE

GUIDE KIT REPARATION

		REF
5.5	1955-67	REC87604
6	1955-67	REC87604
6	1968-79	REC87617
7.5	1955-67	REC87604
9.9/15	1974	REC396350
18	1958-65	REC87606
20	1966-73	REC87606
20	1981-82	REC87619
20	1985	REC396351
25	1955-59	REC87607
25	1969-78	REC87606
25	1979-82	REC87619
25	1984	REC396352
25	1985	REC396351
25	1990-95	REC433550
25 Comm.	1985	REC396352
28	1962-70	REC87607
28	1985	REC396352
30	1955-59	REC87607
30	1976-95	REC396351
33	1962-70	REC87607
35	1955-59	REC87607
35	1977-92	REC396351
40		
Cambio manual Manual shift Cambio manuale Changement manual	1960-73	REC87607
40	1976-88	REC396355
40	1989	REC433550
48	1976-88	REC396355
48	1989, 92-93	REC433550
50	1971-74	REC87622
50	1976-88	REC396355
50	1989	REC433550
55	1976-88	REC396355
60 Elect.	1960-68	REC87608
60 2-Cyl.	1976-88	REC396355
60 3-Cyl.	1978-01	REC5000309
65 Elect.	1960-68	REC87608
65	1978-01	REC5000309
70	1978-01	REC5000309
75 Elect.	1960-68	REC87608
75	1978-01	REC5000309
75		
Cola pequeña Small housing Gambo corto Courte	1976-88	REC396355
V4	1978-84	REC5006373
85 Elect.	1968	REC87608

		REF
85 V4	1973-83	REC5006373
85	1991-95	REC5006373
88	1985	REC5006373
90 Elect.	1964-65	REC87608
90 V4	1973-83	REC5006373
90	1985	REC5006373
100 V4	1973-83	REC5006373
100 Comm.	1984-95	REC5006373
100	1991-01	REC5006373
110 V4	1973-83	REC5006373
110	1985-Up	REC5006373
115 V4	1973-83	REC5006373
115	1985-Up	REC5006373
120	1985-92	REC5006373
120	1993-Up	REC5006373
125	1991-98	REC5006373
125 Comm.	1991-93	REC5006373
135 V4	1973-83	REC5006373
140 V4	1973-83	REC5006373
140	1985-94	REC5006373
150 V6	1978-86	REC5006373
150	1991-95	REC5006373
155 Comm.	1984-93	REC5006373
175 V6	1977-86	REC5006373
175	1991-Up	REC5006373
185	1991-93	REC5006373
200 V6	1976-86	REC5006373
200	1991-Up	REC5006373
V6	1979-92	REC5006373
225	1991-95	REC5006373
235 V6	1977-86	REC5006373
V8	1985-91	REC5006373
250 V8	1991-95	REC5006373
300 V8	1991-95	REC5006373
OMC		
1.6 L	1985-90	REC5006373
1.8 L	1987	REC5006373
2.0 L	1988-90	REC5006373
2.5 L	1984-85	REC5006373
2.6 L	1984-86	REC5006373
2.7 L	1987	REC5006373
3.0 L	1988-90	REC5006373
3.6 L	1987	REC5006373
4.0 L	1989-90	REC5006373

SISTEMA DE PROPULSIÓN PROPULSION SYSTEM

SISTEMA DI PROPULSIONE SYSTEME DE PROPULSION

HÉLICES ALUMINIO E
INOXIDABLE
DE 3 Y 4 PALAS

3 & 4 BLADE
ALUMINIUM & SS
PROPELLERS

ELICHE ALLUMINIO E
INOX DA 3 E 4 PALE

HELICE ALUMINIUM ET
INOX 3 ET 4 PALES

CÓDIGO DE REFERENCIAS

PART NO. CODING SYSTEM

SISTEMA DI CODICE

CODAGE DES REFERENCES

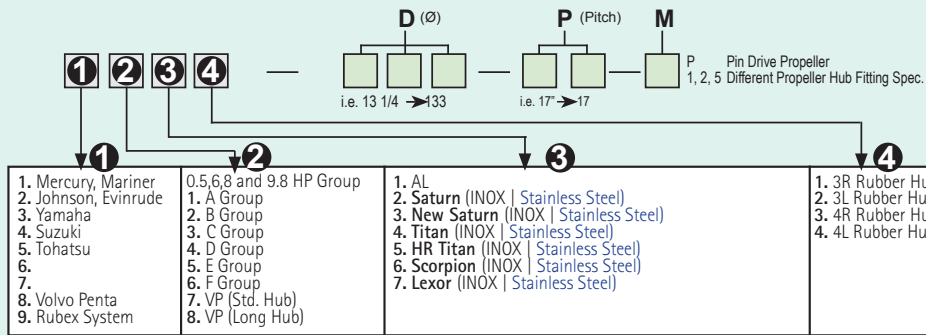

SOLAS

AMITA 3

SOLAS

Hélice de aluminio con núcleo de goma de gran resistencia.

Aluminum propeller with heavy duty rubber hub.

Eliche di alluminio con mozzi in gomma ad alta resistenza.

Hélice en aluminium avec moyeu en caoutchouc



AMITA 4

SOLAS

Hélices de aluminio con núcleo de goma de gran resistencia. Van muy suaves a poca velocidad y hace el barco muy manejable con la mar picada.

Aluminum propeller with heavy duty rubber hub. Smoother low speed makes the offshore boating activity much easier.

Eliche di alluminio con mozzo in gomma ad alta resistenza. Molto morbido a bassa velocità e rende la barca molto gestibile con mare cattivo.

Hélice en aluminium avec moyeu en caoutchouc. Permet d'aller doucement à basse vitesse et rend le bateau très maniable lorsque la mer est agitée



TITAN

SOLAS

Hélices de acero inox. Diseño de pala grande para un área más grande. Gran capacidad de transporte de carga. Excelente economía de combustible.

Stainless steel propeller. High camber blade and large blade area design. Great load carrying capability. Excellent fuel economy.

Eliche in acciaio inossidabile. Ampia capacità di carico. Eccellente riduzione consumo del carburante.

Hélice en acier inox. Pale à carrossage élevé et conception à grande surface de pale. Grande capacité de charge. Excellente économie de carburant.



NEW SATURN

SOLAS

Hélices de acero inoxidable. Ofrece buena aceleración y rendimiento. Tamaño más pequeño que ofrece un diámetro extragrande.

Stainless steel propeller. Offers good acceleration & all-round performance. Smaller pitch sizes offered in extra large diameter with increased blade area.

Eliche di acciaio inox. Buona accelerazione. Piccola dimensione che offre un più grande diametro.

Hélice inox, offrant de bonnes accélérations et performances. Taille de pas réduite pour les modèles de grands diamètres avec une surface de pale plus importante.

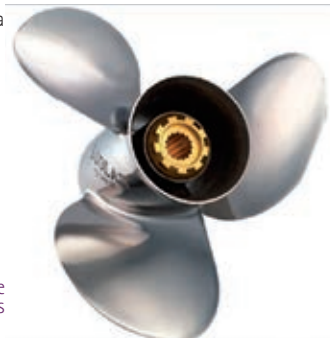

HR TITAN 3 PROP

SOLAS

Hélice de acero inoxidable. Alto rendimiento para cascos de alta velocidad. La inclinación de la hoja proporciona un excelente elevación de proa y aceleración. El diseño de copa grande aumenta la mordida y reduce el deslizamiento.

Stainless steel propeller. Performance prop for high speed planning hulls. High rake blade design provides excellent bow lift and acceleration. Heavy cup design increases bite and reduces slip.

Eliche in acciaio inox. Alte prestazioni per scafi ad alta velocità. Il passo della pala fornisce un'eccellente spinta e accelerazione. Il disegno aumenta le prestazioni.

Hélice en inox, haute performance pour les coques à grande vitesse. L'inclinaison des pales offre une excellente portance et une meilleure accélération. La conception des grandes pales augmente la morsure et réduit le glissement.



**GUÍA DE HÉLICES
CON NÚCLEO INTEGRADO**

**PROPELLERS APPLICATION
WITH RUBBER HUB**

**GUIDA ELICHE
CON MOZZO**

**GUIDE DES HELICES ET
MOYEUR**

	R.O. OEM						AL		INOX STAINLESS STEEL		
		AMITA 3		AMITA 4		NEW SATURN	TITAN	HR TITAN 3			
2.5, 3.5 HP	48-815083	3	7 ^{1/4"}	6	R	PLAST.	SOL0001-073-06P				
4, 4.5, 6, 7.5, 8 HP (2 T / Strokes)		3	8	7	R	AL	SOL2011-080-07				
5, 6 HP (4 T / Strokes)		3	8,5	9			SOL2011-085-09				
	398126		10	7			SOL2111-093-07				
9.9 HP (2 Et 4 T / Strokes)	174938		9 ^{1/4"}	8			SOL2111-093-08				
15 HP (2 Et 4 T / Strokes) Thru-Hub		13	3	9	R	AL	SOL2111-093-09				
8 HP (4 T / Strokes)	174950		9	10			SOL2111-093-10				
	174817		9	11			SOL2111-093-11				
	5033200			7			SOL4111-093-07A				
	5005383			8			SOL4111-093-08A				
9.9, 15 HP (4 T / Strokes)	5005384	10	3	9 ^{1/4"}	9	R	AL	SOL4111-093-09A			
	5005385			10			SOL4111-093-10A				
	5033203			11			SOL4111-093-11A				
	386317		3	11	9						
20, 25, 35 HP 15, 30 HP (Incluye / Include / incluso E-TEC) Thru-Hub	175190		3	10 ^{1/2}	11		SOL2211-105-11				
	176424	14	4	10 ^{1/2}	12	R	AL	SOL2211-103-12			
	175191		4	10	13		SOL2211-101-13				
	176425		4	10 ^{1/4}	14		SOL2211-100-14				
	5032107			10 ^{1/2}	11		SOL4211-105-11				
25, 30 HP (4 T / Strokes)	5032108	10	3	10 ^{1/4}	12	R	AL	SOL4211-103-12			
	5032109			10 ^{1/4}	13		SOL4211-101-13				
	5032110			10 ^{1/4}	14		SOL4211-100-14				
	386909			12 ^{1/2}	13		SOL2311-125-13				
40, 48, 50, 55, 60, 65, 75 HP Thru-Hub		13	3	12 ^{1/2}	14	R	AL	SOL2311-125-14			
	176421			12 ^{1/4}	15		SOL2311-123-15				
	176422			11 ^{3/4}	17		SOL2311-120-17				
	5031622			11 ^{1/2}	10		SOL4311-120-10				
	5031623			11 ^{1/2}	11		SOL4311-118-11				
40, 50 HP (4 T / Strokes)	5031624	13	3	11 ^{5/8}	12	R	AL	SOL4311-116-12			
	5031619			11 ^{1/2}	13		SOL4311-116-13				
	5031620			11 ^{3/8}	14		SOL4311-116-14				
	382761		14	11			SOL2411-140-11				
	391668		14	13			SOL2411-138-13	SOL2413-133-13			
40, 45, 50, 55, 60, 65 HP Comercial	391198			13 ^{3/4}	15	R	AL	SOL2411-135-15	SOL2413-130-15	SOL2431-135-15	
	176214	13	3	14	17		SOL2411-133-17	SOL2413-128-17	SOL2431-133-17		
	176215			14	19		SOL2411-130-19	SOL2413-125-19	SOL2431-130-19		
70, 75, 80, 85, 88, 90, 100, 110, 112, 115, 120, 125, 130, 135, 140 E-TECH (2 Et 4 T / Strokes)	176216			14	21		SOL2411-130-21	SOL2413-125-21	SOL2431-130-21		
	389949			13 ^{3/4}	15				SOL2431-135-15		
	389948			13 ^{3/8}	17	R	INOX / SS		SOL2431-133-17		
	389510	13	3	13	19				SOL2431-130-19		
	389512			12 ^{3/4}	21				SOL2431-130-21		

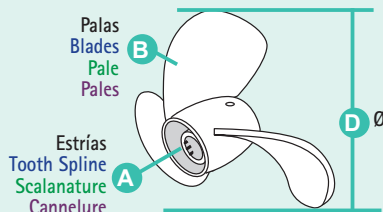

- P** Paso
Pitch
Passo
Pas
- R** Rotación L (izquierda) R (derecha)
Rotation L (left) R (Right)
Rotazione L (SX) R (DX)
Rotation L (gauche) R (droit)

	R.O. OEM	A B D P R					AL		INOX STAINLESS STEEL			
							AMITA 3	AMITA 4	NEW SATURN	TITAN	HR TITAN 3	
90, 115, 140 HP (4 T / Strokes)	5033322			13 ^{1/2}	15	R		SOL3413-138-15				
	5033323			14	17	R		SOL3413-138-17			SOL3451-139-17	
	5033324	15	3	14	19	R	AL	SOL3413-138-19			SOL3451-139-19	
	5033325			14	21	R		SOL3413-138-21			SOL3451-139-21	
	5033326			14	23	R					SOL3451-139-23	
	5033327			14	18	R					SOL3451-139-17	
	5033955			14	18	L					SOL3452-139-17	
	5033328			14	20	R					SOL3451-139-19	
	5033956	15	3	14	20	L	INOX / SS				SOL3452-139-19	
	5033329			14	22	R					SOL3451-139-21	
	5033957			14	22	L					SOL3452-139-21	
	5033330			14	24	R					SOL3451-139-23	
	90, 100, 115, 130, 150 HP 120-140 / V4 V6 Gear Case 135, 150, 155, 175, 185, 200, 225, 235, 250 2.6 L / V6 E-TEC	391535			15 ^{1/2}	15	R		SOL2511-150-15	SOL2513-148-15	SOL2531-145-15	
				15	15	L		SOL2512-150-15	SOL2514-148-15	SOL2532-145-15		
391200				15	17	R		SOL2511-148-17	SOL2513-145-17	SOL2531-143-17		
				17	17	L		SOL2512-148-17	SOL2514-145-17	SOL2532-143-17		
391201				14 ^{1/2}	19	R		SOL2511-145-19	SOL2513-143-19	SOL2531-140-19		
				19	19	L		SOL2512-145-19	SOL2514-143-19	SOL2532-140-19		
391202				14 ^{1/2}	21	R		SOL2511-143-21	SOL2513-140-21	SOL2531-140-21		
				21	21	L		SOL2512-143-21	SOL2514-140-21	SOL2532-140-21		
391203				14 ^{1/2}	23	R		SOL2511-142-23		SOL2531-140-23		
				23	23	L				SOL2532-140-23		
Non-SX Drive 100-150 Comercial V6 Gear Case 150, 155, 175, 200, 225, 250, 275, 300, 3.6L / V8		390831			15 ^{1/2}	14	R					
		174926			15	15	R			SOL2531-145-15		
		174927			15	15	L			SOL2532-145-15		
	391290			15	17	R			SOL2531-143-17			
	431930			15	17	L			SOL2532-143-17			
Non-SX Drive E-TEC	389924	15	3	14 ^{1/2}	19	R	INOX / SS			SOL2531-140-19		
	390821			14 ^{1/2}	19	L			SOL2532-140-19			
	389923			14 ^{1/4}	21	R			SOL2531-140-21			
	390822			14 ^{1/4}	21	L			SOL2532-140-21			
	289019			14 ^{1/4}	23	R			SOL2531-140-23			
	390823			14 ^{1/4}	23	L			SOL2532-140-23			
200, 225 HP (4 T / Strokes)				15.8	15	R		SOL4511-150-15				
				15.8	15	L		SOL4512-158-15				
				15.5	17	R		SOL4511-155-17				
				15.5	7	L		SOL4512-155-17				
				15 ^{3/8}	18	R					SOL4571-154-18	
				15 ^{3/8}	18	L					SOL4572-154-18	
				15.3	19	R		SOL4511-153-19				
			15	3	15.3	19	L	AL	SOL4512-153-19			
				15 ^{1/8}	20	R					SOL4571-151-20	
				15 ^{1/8}	20	L					SOL4572-151-20	
				15.3	21	R		SOL4511-153-21				
				15.3	21	L		SOL4512-153-21				
				14 ^{7/8}	22	R					SOL4571-149-22	
			14 ^{7/8}	22	L					SOL4572-149-22		
			14 ^{3/4}	23	R					SOL4571-148-23		
			14 ^{3/4}	23	L					SOL4572-148-23		

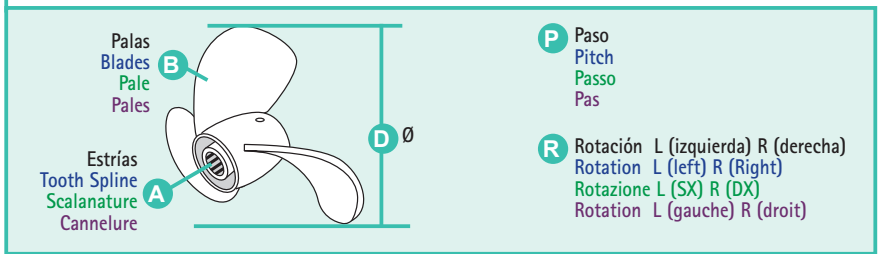

NÚCLEO INTERCAMBIABLE INTERCHANGEABLE HUB

MOZZO INTERCAMBIABILE

MOYEU INTERCHANGEABLE

	2T STROKES	4T STROKES	A		REF	
45-75 HP Cola pequeña Small gearcase <i>Piede piccolo</i> <i>Embase courte</i>				3 ^{3/8"}	SOLRBX-111	C
45-75 HP Cola larga Large gearcase <i>Piede lungo</i> <i>Embase Longue</i>			13		SOLRBX-106	D
85-140 HP Cola larga Large gearcase <i>Piede lungo</i> <i>Embase Longue</i>			13	4 ^{1/4"}	SOLRBX-106	D
60 & 70 HP		✓	13		SOLRBX-110	D
90, 115 HP		✓	15		SOLRBX-125	D
140 HP		✓	15		SOLRBX-126	D
90, 140 HP Cola larga Large gearcase <i>Piede lungo</i> <i>Embase Longue</i>			15		SOLRBX-101	E
90, 140 HP Cola larga Large gearcase <i>Piede lungo</i> <i>Embase Longue</i>			15		SOLRBX-100	E
150-300 HP			15		SOLRBX-101	E
150-300 HP			15		SOLRBX-100	E



HÉLICES PARA NÚCLEO INTERCAMBIABLE

PROPELLERS FOR INTERCHANGEABLE HUB

ELICHE PER MOZZO INTERCAMBIABILE

HELICES AVEC MOYEU INTERCHANGEABLE

	B	D	P	R	AL
C 30-75 HP	3	11.4	12	R	SOL9311-114-12
		11.1	13	R	SOL9311-111-13
		14	9	R	SOL9411-140-09
D 40-140 HP	3	14	11	R	SOL9411-140-11
		13.75	13	R	SOL9411-138-13
		13.5	15	R	SOL9411-135-15
		13.25	17	R	SOL9411-133-17
		13.2	19	R	SOL9411-132-19
		13.2	21	R	SOL9411-132-21
E 135-350 HP	3	15.5	11	R	SOL9511-155-11
		16	13	R	SOL9511-160-13
		15.3	13	R	SOL9511-153-13
		15	15	R	SOL9511-150-15
		15	15	L	SOL9511-150-15
		14.8	17	R	SOL9511-148-17
		14.8	17	L	SOL9511-148-17
		14.5	19	R	SOL9511-145-19
		14.5	19	L	SOL9511-145-19
		14.3	21	R	SOL9511-143-21
14.3	21	L	SOL9511-143-21		

	B	D	P	R	INOX STAINLESS STEEL
D 40-140 HP	3	13 ^{3/4}	13	R	SOL9431-138-13
		13 ^{3/4}	13	L	SOL9432-138-13
		13 ^{1/2}	15	R	SOL9431-135-15
		13 ^{1/2}	15	L	SOL9432-135-15
		13 ^{1/4}	17	R	SOL9431-133-17
		13 ^{1/4}	17	L	SOL9432-133-17
		13	19	R	SOL9431-130-19
		13	19	L	SOL9432-130-19
		13	21	R	SOL9431-130-21
		13	21	L	SOL9432-130-21
E 90-140 HP	3	14 ^{1/2}	15	R	SOL9531-145-15
		14 ^{1/2}	15	L	SOL9532-145-15
		14 ^{1/4}	17	R	SOL9531-143-17
		14 ^{1/4}	17	L	SOL9532-143-17
		14	19	R	SOL9531-140-19
		14	19	L	SOL9532-140-19
		14	21	R	SOL9531-140-21
		14	21	L	SOL9532-140-21
		14	23	R	SOL9531-140-23
		14	23	L	SOL9532-140-23
E 135-350 HP	3	15 ^{3/4}	15	R	SOL9571-158-15
		15 ^{3/4}	15	L	SOL9572-158-15
		15 ^{1/2}	17	R	SOL9571-155-17
		15 ^{1/2}	17	L	SOL9572-155-17
		15 ^{1/4}	19	R	SOL9571-153-19
		15 ^{1/4}	19	L	SOL9572-153-19
		15	21	R	SOL9571-150-21
		15	21	L	SOL9572-150-21
		14 ^{3/4}	23	R	SOL9571-148-23
		14 ^{3/4}	23	L	SOL9572-148-23

RUBEX



Núcleo intercambiable (no incluido).
Interchangeable hub (not included).
Mozzo intercambiabile (non incluso).
Moyeu interchangeable (non inclus)



PIEZAS HÉLICE

PROP PARTS

PARTI ELICA

PIECES D'HÉLICE

TUERCA DE HÉLICE

PROPELLER NUT

DADO DI ELICA

ÉCROU D'HÉLICE

REF	OEM	Icon
REC09141-12005	5032950	J10, 15 HP



new

REF	OEM	Icon
REC90171-18M04	09141-18005	40 --> 250 HP



new

REF	OEM	Icon
REC314503	314503	5/8" NC 11
REC318971	318971	7/16" NC14
REC319891	319891	1/2" NC13



PASADOR

PIN

SPINOTTO

GOUPILLE FENDUE

REF	OEM	Icon
REC314502	314502	
REC3852056	3852056	
REC18-32665	302804	
REC309955	309955	
REC320785	320785	
REC328522	552906	



REF	OEM	Icon
REC09204-02004	5032996	J10, 15 HP



new

REF	OEM	Icon
REC91490-30025	5030087	4 --> 225 HP



new

REF	OEM	Icon
PAGB/T91-1.6X12	5037363 5037373	J10, 15 HP



new

SEPARADOR DE HÉLICE

PROPELLER WASHER

DISTANZIALE ELICA

ENTRETOISE D'HELICE

REF	OEM	Icon
REC57632-94J00	5033197	J10, 15 HP



new

REF	OEM	Icon
REC57633-93901	5033198	J10, 15 HP



new

PASADOR DE HÉLICE

PROPELLER PIN

PIN ELICA

CLAVETTE D'HELICE

REF	OEM	Icon
REC09202-04002	5030084	J2, 4, 5 HP



new

TOPE HÉLICE

THRUST WASHER

RONDELLA CHIUSSURA

RONDELLE DE BUTÉE

REF	OEM	GROSOR THICK SPESSORE ÉPAISSEUR	Ø EXT	
REC320305	320305	15/32"	2 1/8"	
REC127084	127084	19/32"	2 9/16"	
REC126870	3852020	3/4"	2 7/8"	"O", "M" (1991+)
REC319890	319890	3/8"	1 3/4"	2 Cyl. Crossflow 20-35 HP
REC334590	334590	5/8"	1 1/2"	9.9 - 15 HP (1989+)



REF	OEM		Ø EJE Ø SHAFT Ø ASSE Ø ARBRE
REC315810	315810	13	7/8"
REC320570	320570	15	1"
REC323942	323942	13	5/8"
REC323943	323943	14	13/16"





GUÍA DE RECAMBIOS DE HÉLICE

PROPELLER SPARE PARTS

GUIDA RICAMBIO ELICHE

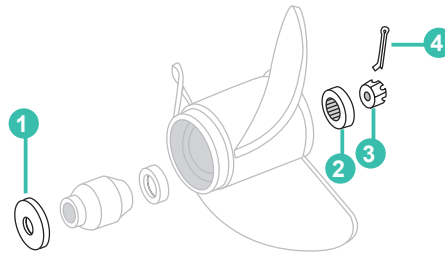
GUIDE DES PIÉCES POUR HÉLICE



	1	2	3	4	KIT	
9.9/15	1974-78		REC323942	REC318971	REC328522	REC175269
9.9/15	1989	REC334590	REC323942	REC318971	REC328522	REC175269
20	1985	REC319890	REC323943	REC319891	REC320785	REC175268
25	1985	REC319890	REC323943	REC319891	REC320785	REC175268
30	1985	REC319890	REC323943	REC319891	REC320785	REC175268
35	1976	REC319890	REC323943	REC319891	REC320785	REC175268
40	1984	REC320305	REC315810	REC314503	REC314502	REC175267
45	1985	REC320305	REC315810	REC314503	REC314502	REC175267
48	1987	REC320305	REC315810	REC314503	REC314502	REC175267
50	1972-74	REC127084	REC315810	REC314503	REC314502	REC175267
50	1975-76	REC320305	REC315810	REC314503	REC314502	REC175267
50	1979	REC320305	REC315810	REC314503	REC314502	REC175267
50	1981	REC320305	REC315810	REC314503	REC314502	REC175267
50	1982	REC320305	REC315810	REC314503	REC314502	REC175267
55	1977-79	REC127084	REC315810	REC314503	REC314502	REC175267
55	1981	REC320305	REC315810	REC314503	REC314502	REC175267
55	1983	REC127084	REC315810	REC314503	REC314502	REC175267
55	1985	REC127084	REC315810	REC314503	REC314502	REC175267
60	1971	REC127084	REC315810	REC314503	REC314502	REC175267
60	1980	REC320305	REC315810	REC314503	REC314502	REC175267
65	1972-73	REC127084	REC315810	REC314503	REC314502	REC175267
65 Comm.	1984	REC127084	REC315810	REC314503	REC314502	REC175267
70 (15")	1979-85	REC320305	REC315810	REC314503	REC314502	REC175267
70 (20")	1974-94	REC127084	REC315810	REC314503	REC314502	REC175267
75 (15")	1975-88	REC320305	REC315810	REC314503	REC314502	REC175267
75 (20")	1975-87	REC127084	REC315810	REC314503	REC314502	REC175267
85	1971-80	REC127084	REC315810	REC314503	REC314502	REC175267
88	1987-94	REC127084	REC315810	REC314503	REC314502	REC175267

		1	2	3	4	KIT
90	1981-94	REC127084	REC315810	REC314503	REC314502	REC175267
100	1971-72	REC127084	REC315810	REC314503	REC314502	REC175267
100	1979-94	REC127084	REC315810	REC314503	REC314502	REC175267
100 Comm.	1984		REC320570	REC5008966 REC398042	REC3852056	REC175266
110	1987-94	REC127084	REC315810	REC314503	REC314502	REC175267
115	1973-94	REC127084	REC315810	REC314503	REC314502	REC175267
120	1985		REC320570	REC5008966 REC398042	REC3852056	REC175266
120	1986-94	REC127084	REC315810	REC314503	REC314502	REC175267
125	1971-72	REC127084	REC315810	REC314503	REC314502	REC175267
135	1973-76	REC127084	REC315810	REC314503	REC314502	REC175267
140	1977-84	REC127084	REC315810	REC314503	REC314502	REC175267
140	1985		REC320570	REC5008966 REC398042	REC3852056	REC175266
140	1986-94	REC127084	REC315810	REC314503	REC314502	REC175267
150	1978-90		REC320570	REC5008966 REC398042	REC3852056	REC175266
150	1991	REC126870	REC320570	REC5008966 REC398042	REC3852056	REC175266
155 Comm.	1984-90		REC320570	REC5008966 REC398042	REC3852056	REC175266
155 Comm.	1991	REC126870	REC320570	REC5008966 REC398042	REC3852056	REC175266
175	1977-90		REC320570	REC5008966 REC398042	REC3852056	REC175266
175	1991	REC126870	REC320570	REC5008966 REC398042	REC3852056	REC175266
185	1984-90		REC320570	REC5008966 REC398042	REC3852056	REC175266
185	1991	REC126870	REC320570	REC5008966 REC398042	REC3852056	REC175266
200	1986-90		REC320570	REC5008966 REC398042	REC3852056	REC175266
200	1991	REC126870	REC320570	REC5008966 REC398042	REC3852056	REC175266
225	1986-90		REC320570	REC5008966 REC398042	REC3852056	REC175266
225	1991	REC126870	REC320570	REC5008966 REC398042	REC3852056	REC175266
235	1976-90		REC320570	REC5008966 REC398042	REC3852056	REC175266
275	1985-90		REC320570	REC5008966 REC398042	REC3852056	REC175266
275	1991	REC126870	REC320570	REC5008966 REC398042	REC3852056	REC175266
3.6 L	1985-90		REC320570	REC5008966 REC398042	REC3852056	REC175266
300	1991	REC126870	REC320570	REC5008966 REC398042	REC3852056	REC175266
1.6 Seadrive	1982-90	REC127084	REC315810	REC314503	REC314502	REC175267
2.5 L Seadrive	1984-90		REC320570	REC5008966 REC398042	REC3852056	REC175266
2.6 L Seadrive	1982-90		REC320570	REC5008966 REC398042	REC3852056	REC175266

KIT CIERRE HÉLICE		PROP NUT KITS		KIT CHIUSURA ELICA		KIT ÉCROU D'HÉLICE	
REF	OEM	4T STROKES	2T STROKES	REF	OEM	4T STROKES	2T STROKES
REC57630-96300	5032170	E25 / E30 / J25 / J30 BJ25 (2000-07)	✓	REC57630-94500	5030976	E60 / J60 / BJ60 E70 / J70 / BJ70 (1998-04)	✓
REF	OEM	4T STROKES	2T STROKES	REF	OEM	4T STROKES	2T STROKES
REC57630-94300	5031548	E40 / J40 / BJ40 E50 / J50 / BJ50 (1999-06)	✓	REC57630-92E00	5035460	J200 / J225 BJ200 / BJ225 (2004-06)	✓

REF	OEM		4T STROKES	2T STROKES
REC386866	386866		2 Et 3 Cyl. (1972+)	Small





REF	OEM		4T STROKES	2T STROKES
REC5005034	5005034		2 Et 3 Cyl. (1975+)	Large V4 (1973+) Small



REF	OEM		4T STROKES	2T STROKES
REC414153	434153		V4 / V6 "0" (1976-90)	Large



REF	OEM		4T STROKES	2T STROKES
REC22186			V4 / V6 / V8 "0"	(1991+) Large



**KIT CIERRE HÉLICE
SIN ARANDELA**

**PROP NUT KITS
WITHOUT WASHER**

**KIT CHIUSURA ELICA
SENSA RONDELLA**

**KIT ÉCROU D'HÉLICE
SANS RONDELLE**

REF	OEM	
REC175269	175269	9.9 - 15 HP



REF	OEM	REF	OEM	REF	OEM
REC323942	323942	REC318971	318971	REC328522	328522

REF	OEM	
REC175268	175268	2 Cyl. Crossflow 20 - 35 HP (1980-05)



REF	OEM	REF	OEM	REF	OEM
REC323943	323943	REC319891	319891	REC320785	320785

REF	OEM
REC175267	175267



REF	OEM	
REC398042	398042	3/4" NF 16



REF	OEM
REC175266	175266







GUÍA DE KITS DE RECAMBIOS DE CIERRE

PROPELLER KITS & HARDWARE APPLICATIONS

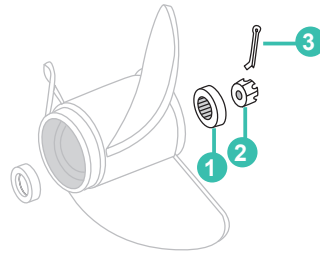
GUIDA RICAMBI CHIUSURA ELICHE

GUIDE DES KITS ET PIÈCES POUR HÉLICE



							
		1	1	2	3	KIT	KIT +
9.9 - 15 HP	1974-88		REC323942	REC318971	REC328522	REC175269	
9.9 - 15 HP	-1989	REC334590	REC323942	REC318971	REC328522	REC175269	
2 Cyl. Crossflow 20-35 HP, Thru-prop exhaust	1980-05	REC319890	REC323943	REC319891	REC320785	REC175268	
2-Cyl. Loopcharged, 40-60 HP	1972-85	REC320305	REC315810	REC314503	REC314502	REC175267	REC386866
2-Cyl. Loopcharged, 40-60 HP small	1986-88	REC320305	REC315810	REC314503	REC314502	REC175267	REC386866
2-Cyl. Loopcharged, 40-60 HP large	1986-88	REC127084	REC315810	REC314503	REC314502	REC175267	REC5005034
2-Cyl. Loopcharged, 40-50 hp	1989-05	REC320305	REC315810	REC314503	REC314502	REC175267	REC386866
2-Cyl. Loopcharged, 55 hp	1989-05	REC127084	REC315810	REC314503	REC314502	REC175267	REC5005034
3-Cyl., 65 + 70 HP	1972-74	REC320305	REC315810	REC314503	REC314502	REC175267	REC386866
3-Cyl., 65, 70, 75 HP small	1975-88	REC320305	REC315810	REC314503	REC314502	REC175267	REC386866
3-Cyl., 65, 70, 75 HP large	1975-88	REC127084	REC315810	REC314503	REC314502	REC175267	REC5005034
3-Cyl., 60, 65, 70 HP	1989-01	REC127084	REC315810	REC314503	REC314502	REC175267	REC5005034
3-Cyl., 25, 30, 35 HP	1996-01		REC323943	REC319891	REC320785		
V4, Ø 7/8" 13 estriás spline scalanature Cannelure	1973	REC127084	REC315810	REC314503	REC314502	REC175267	REC5005034
V4, Ø 1" 15 estriás spline scalanature Cannelure	1984-90		REC320570	REC398042	REC3852056	REC175266	REC414153
V4, Ø 1" 15 estriás spline scalanature Cannelure	1991	REC126870	REC320570	REC398042	REC3852056	REC175266	REC22186
V6 / V8	1976-90		REC320570	REC398042	REC3852056	REC175266	REC414153
V6 / V8	1991	REC126870	REC320570	REC398042	REC3852056	REC175266	REC22186

REF --> RO / OEM

REF	R.O. / OEM	REF	R.O. / OEM	REF	R.O. / OEM
C					
CEF500303C	439	CM984547	984547	PAGB/T91-1.6X12	5037373 548
CEF500305	439	CM984547A	983952	PAGB/T93-6	5030068 499-505
CEF500306	439	CM984547A	984547	PAGB/T97.1-8	
CEF500306C	439	CMOMC5075KITA	457	PH130-0006	5040786 405
CEF500307	439	CMOMCV4V6KITA	457	PH130-0008	391511 408
CEF500345	439			PH130-0008	397023 408
CEF500350	439			PH130-0008	396235 408
CEF500351	439			PH130-0008	584799 408
CEF500352	439			PH130-0008	586890 408
CEF500353	439-453			PH130-0008	384799 408
CEF500354G	439			PH130-0008	586289 408
CEF500355	439			PH130-0008	586411 408
CEF500358	439			PH130-0008	586731 408
CEF500370C	439			PH130-0008	586897 408
CEF500370C	439			PH130-0012	393570 407
CEF500372C	439			PH130-0012	585600 407
CHAJ8C	401-403			PH130-0012	586285 407
CHAL77JC4	401-402-403-404			PH130-0012	778994 407
CHAL78YC	401-402-403-404			PH130-0013	584608 405
CHAL82C	401-402-403-404			PH130-0013	586275 405
CHAL87YCC	401-403			PH130-0014	386430 405
CHAPROSL	405			PH130-0014	586276 405
CHAQL16V	402			PH130-0016	583482 406
CHAQL77JC4	401-402-403-404			PH130-0016	585056 406
CHAQL78YC	401-402-403-404			PH130-0016	586279 406
CHAQL82C	401-402-403-404			PH130-0017	5583473 406
CHAQL87YC	401-403			PH130-0017	585059 406
CHARA8HC	401-403			PH130-0017	778991 406
CHARJ8C	401-403			PH130-0018	432925 407
CHAUL77V	401-402-403-404			PH130-0018	586286 407
CHAUL81C	401-402-403-404			PH130-0018	586287 407
CHAXC12PEPB	402-404			PH130-0026	586277 406
CM11130-94600	462			PH130-0026	584818 406
CM123009	123009			PH130-0026	778996 406
CM123009	173029			PH130-0027	584980 407
CM123009A	173029			PH130-0027	586284 407
CM327606	327606			PH130-0032	438878 407
CM327606A	327606			PH130-0032	586257 407
CM334451	334451			PH130-0035	586768 405
CM334451A	432397			PH130-0035	587045 405
CM334451A	334451			PH130-0038	386591 405
CM334451A	432397			PH130-0038	392133 405
CM338635	338635			PH130-0038	585061 405
CM338742	338742			PH130-0038	586278 405
CM389999	389999			PH130-0038	277432 405
CM389999A	389999			PH130-0038	278232 405
CM392123	392123			PH130-0038	278232 405
CM392123A	392123			PH130-0038	378674 405
CM392462	392462			PH130-0038	379091 405
CM392462A	392462			PH130-0038	379818 405
CM393023	393023			PH130-0038	380139 405
CM393023A	393023			PH130-0038	380238 405
CM397768	397768			PH130-0038	381864 405
CM397768A	397768			PH130-0038	385401 405
CM398873	398873			PH130-0038	386597 405
CM398873A	398873			PH130-0039	387094 407
CM431708	431708			PH130-0039	395207 407
CM431708A	431708			PH130-0039	585062 407
CM433458	433458			PH130-0039	586288 407
CM433458A	398331			PH130-0039	778992 407
CM433458A	433458			PH130-0039	777693 407
CM434029	434029			PH130-0043	383691 406
CM5007089	5007089			PH130-0043	384777 406
CM5007089A	5007089			PH130-0043	386657 406
CM5031538	5031538			PH130-0043	391735 406
CM5031705	5031705			PH130-0043	585058 406
CM5032929	5032929			PH130-0043	585197 406
CM5032930	5032930			PH130-0043	586281 406
CM5033167	5033167			PH130-0044	385529 407
CM55125-95500	5031536			PH130-0044	389954 407
CM55300-95500	5031538			PH130-0044	585057 407
CM55320-98600	5030267			PH130-0044	585196 407
CM55321-87J00	5031705			PH130-0044	586282 407
CM55321-90J01AL	5032930			PH130-0044	586283 407
CM55321-93900	5033185			PH130-0044	386465 407
CM976669	976669			PH130-0044	389380 407
CM976669A	976669			PH130-0044	391554 407
CM980756	980756			PH130-0045	585051 407
CM980756A	980756			PH130-0045	384163 406
CM982438	982438			PH130-0045	387684 406
CM982438	982438			PH130-0045	389275 406
CM983494	983494			PH130-0045	585063 406
CM983494A	983494			PH130-0045	586280 406
CM984513	984513			PH130-0045	778993 406
CM984513A	984513			PH130-0061	5040343 405
CM984547	983952			PH130-0071	5033799 407
				PH130-0077	5036972 406
				PH130-0078	5035078 408
				PH130-0079	5030780 409
				PH200-T004	439937 425
				PH200-T004	5005254 425
				PH200-T004	438786 425
				PH200-T005	434495 424
				PH200-T005	434496 424
				PH200-T005	438529 424
				PH200-T005	5005374 424
				PH200-T005	438531 424
				PH200-T014	391264 423
				PH200-T014	393259 423
				PH200-T014	393988 423
				PH200-T014	394176 423
				PH200-T014	983019 423
				PH200-T020	387277 423

REF	R.O. / OEM		REF	R.O. / OEM		REF	R.O. / OEM	
PH200-T020	582048	423	REC0176408	176408	429	REC0583672	583023	419
PH200-T020	582155	423	REC0319661	319661	485	REC0583672	583104	419
PH200-T020	584107	423	REC0319662	319662	445	REC0583672	583671	419
PH200-T020	582047	423	REC0321479	321479	486	REC0583672	583672	419
PH200-T020	777784	423	REC0323327	0323327	398	REC0583672	581030	419
PH200-T021	437801	424	REC0324323	3234323	482	REC0583672	581987	419
PH200-T021	435532	424	REC0326260	326260	486	REC0583672		421-422
PH200-T022	433226	424	REC0326264	326264	482	REC0583689	583266	413
PH200-T046	5032670	424	REC0326877	326877	408	REC0583689	583689	413
PH200-T061	5006319	425	REC0329319	329319	436	REC0583689	586000	413
PH200-T061	5005838	425	REC0330621	330621	480	REC0583689	5844241	413
PH200-T061	5005817	425	REC0334665	334665	466	REC0583689		414
PH200-T062	5036081	424	REC0340975	340975	455	REC0583724	581957	418
PH200-T062	5032670	424	REC0340976	340976	455	REC0583724	582506	418
PH200-T062	5031482	424	REC0385008	384461	417	REC0583724	582730	418
PH200-T072	5005822	424	REC0385008	385008	417	REC0583724	583119	418
PH200-T072	5005831	424	REC0395204	395204	412	REC0583724	583644	418
PH200-T072	5005875	424	REC0395204	395391	412	REC0583724	583724	418
PH200-T072	5006479	424	REC0395204	582904	412	REC0583724		421
PH200-WH01	84-819514T26	423	REC0395204		414	REC0583740	583740	400-401
PH200-WH01	84-826075A2	423	REC0395911	395911	430	REC0583748	583748	416-421
PH200-WH01	84-826802A4	423	REC0397004	397004	430	REC0583865	583865	414-421-422
PH350-0001	583408	414	REC0398243	398243	430	REC0584028	583773	415
PH350-0001	582399	414	REC0433325	433325	430	REC0584028	584027	415
PH350-0002	581778	414	REC0435230	435230	430	REC0584028	584028	415
PH350-0003	509219	411	REC0435279	435279	492-493	REC0584028		421
PH375-0012	582708	410	REC0436367	436367	415	REC0584035	583471	414
PH375-0012	395419	410	REC0436367	584122	415	REC0584035	584034	414
PH375-0012	380095	410	REC0439542	439542	430	REC0584035	584035	414
PH375-0012	383622	410	REC0500581	500581	430	REC0584035		422
PH375-0012	389398	410	REC0500581	396161	430	REC0584041	583489	414
PH375-0012	389493	410	REC0502880	581407	400	REC0584041	584040	414
PH375-0012	586180	410	REC0502881	502881	400	REC0584041	584041	414
PH375-0027	586730	410	REC0502881	581786	400	REC0584041		421-422
PH375-0027	586842	410	REC0502888		400	REC0584288	583561	419
PH375-0027	778209	410	REC0502888	582888	400	REC0584288	584288	419
PH375-0027	980801	410	REC0502888	582091	400	REC0584288		421-422
PH375-0027	981703	410	REC0502888		401	REC0584333	583485	418
PH375-0027	982189	410	REC0502890	502890	400	REC0584333	584333	418
PH375-0027	985064	410	REC0502890	582160	400	REC0584477	584477	400
PH375-0027	385389	410	REC0502890	584632	400	REC0584954	584954	418-420
PH375-0029	985063	409	REC0502890		401	REC0584985	584910	415
PH375-0029	892187	409	REC0554545	554545	445-513	REC0584985	584985	415
PH375-0029	98410	409	REC0580148	580148	427	REC0584985	584990	415
PH375-0029	778025	409	REC0580256	580256	426-427	REC0584985		421-422
PH375-0029	584128	409	REC0580290	580290	427	REC0584986	584986	414
PH375-0030	979774	410	REC0580321	580321	426-427	REC0584986	584988	414
PH375-0030	778021	410	REC0581207	581207	427	REC0584986	584912	414
PH375-0033	172869	410	REC0581419	581419	426-427	REC0584986	584989	414
PH375-0033	581528	410	REC0582056	581731	417	REC0584986	584991	414
PH375-0033	777699	410	REC0582056	582056	417	REC0585081	585081	412
PH375-0047	5031483	411	REC0582056		421	REC0585195	583529	413
PH375-0047	5032195	411	REC0582057	582057	417-421-422	REC0585195	584204	413
PH375-0048	5032197	411	REC0582115	582115	416	REC0585195	585195	413
PREMC30506	173106	430	REC0582115	583125	416	REC0585195		414
PREMC30507	173107	430	REC0582115	583143	416	REC0585274	585274	415-421
PREMC30508	173105	430	REC0582115		421	REC0586271	586271	413
PREMC30509	173109	430	REC0582125	582684	416	REC0586271	584641	413
PREMC30510	173110	430	REC0582125	582125	416	REC0586271	585995	413
PREMC30511	173111	430	REC0582125	582454	416	REC0586271		414
PREMC30512	173112	430	REC0582125	581805	416	REC0586343	584265	417
PREMC30513	173113	430	REC0582125		421-422	REC0586343	584914	417
PREMC30514	173114	430	REC0582262	5814014	415	REC0586343	586343	417
PREMC30515	173115	430	REC0582262	582262	415	REC0586343		421-422
PREMC30516	173116	430	REC0582262	583041	415	REC0586661	584636	414
PREMC30517	173117	430	REC0582262	583103	415	REC0586661	584637	414
PREMC30518	173118	430	REC0582262	583336	415	REC0586661	585114	414
PREMC30519	173119	430	REC0582262		421-422	REC0586661	586212	414
PREMC30520	173120	430	REC0582382	582382	401	REC0586661	586661	414
PREMC30521	173121	430	REC0582452	582453	416	REC0586661		422
PREMC30522	173122	430	REC0582452	583380	416	REC0586667	583476	414
PREMC30523	173123	430	REC0582452		420-421	REC0586667	584036	414
PREMC30524	173124	430	REC0582508	582508	400-401	REC0586667	584037	414
R			REC0582642	582138	416	REC0586667	586217	414
RAC120R-RAC-01		386-387	REC0582642	582400	416	REC0586667	586667	414
RAC23289-10		388	REC0582642	582642	416	REC0586667		422
RAC23299-10		388	REC0582642	582556	416	REC0586695	396077	416
RAC320R-INOX-01		387	REC0582642		421-422	REC0586695	582261	416
RAC320R-RAC-01	8M0097838	386-387	REC0582901	582474	416	REC0586695	582504	416
RAC320R-RAC-02		387	REC0582901	582864	416	REC0586695	582714	416
RAC320R-RAC-03	8M0097838	386	REC0582901	582901	416	REC0586695	582800	416
RAC490R-RAC-01		388	REC0582901		421	REC0586695	582889	416
RACPF5510		385	REC0583114	583114	416-421-422	REC0586695	583172	416
RACRK22628		388	REC0583320	583122	416	REC0586695	583174	416
RACS3213		386-387	REC0583320	583320	416	REC0586695	583241	416
RACS3214		387	REC0583320		421	REC0586695	584508	416
RACS3220UL		387	REC0583387	583387	417-420-421	REC0586695	584528	416
RACS3227		387-388	REC0583415	584287	419	REC0586695	584746	416
RACS3228UL		387	REC0583415	763765	419	REC0586695		420-421
RACS3240		386-387	REC0583415		421	REC0586697	396141	416
REC0172522		427	REC0583668	582574	419	REC0586697	582281	416
REC0172523		427	REC0583668	583050	419	REC0586697	582285	416
REC0172525		427	REC0583668	583274	419	REC0586697	582502	416
REC0172806		427	REC0583668	583668	419	REC0586697	582757	416
REC0175316	175316	415	REC0583668	763785	419	REC0586697	582880	416
REC0175316	585261	415	REC0583670		421-422	REC0586697	583167	416
REC0175316	585262	415	REC0583670	582847	418	REC0586697	583168	416
REC0175316		420-421	REC0583670	583117	418	REC0586697	583169	416
REC0176333	176333	430	REC0583670	583670	418	REC0586697	583170	416
REC0176335	176335	430	REC0583670		422	REC0586697	583175	416
REC0176340	176340	430	REC0583672	582016	419	REC0586697	583604	416
REC0176342	176342	430	REC0583672	582497	419	REC0586697		420-421
			REC0583672	582867	419	REC0586767	0586767	410

REF	R.O. / OEM		REF	R.O. / OEM		REF	R.O. / OEM	
REC0586767	586767	410	REC09282-15008	5036938	489	REC14212-93J00	5034982	482
REC0586798	584783	415-420	REC09282-17005	5031264	489-505	REC15-201		404
REC0763759	584109	419	REC09282-17009	5031266	489	REC15-202		404
REC0763759	584981	419-421-422	REC09283-10003	5030109	489	REC15-203	84-813715A1	404
REC0763760	584849	418	REC09283-10009	5033339	489	REC15-204		404
REC0763760	763760	418	REC09283-20018	5030110	489	REC15170-91J00	5033372	394-395
REC0763760		421	REC09283-20045	5030111	489	REC15170-94J00	5037584	394-395
REC0763763	584560	419	REC09283-25076	5033481	489	REC15170-98110	5030181	394-395
REC0763763	763763	419	REC09289-12003	5033014	499	REC15170-99E00	5030699	394-395
REC0763763		420-421	REC09289-17006	5033015	489-499	REC15410-87J00	5031400	390
REC0763764	583710	419	REC09289-20009	5031893	489-501-503	REC15410-87J10	5032323	389
REC0763764	584292	419	REC09289-22007	5031270	489-505	REC15410-87J10	5030702	389
REC0763764	763764	419	REC09380-15001	5033027	447-499	REC15410-87J30	5035974	389
REC0763764		421-422	REC09420-03002	5030137	441-497	REC15410-93J00	5034984	389
REC0763765	583415	419	REC09420-03005	5033113	441	REC15410-98500	5032238	389
REC0763765	584287	419	REC09420-04006	5031281	441-501-503-505	REC15440-90J00	5033704	391
REC0763765	763765	419	REC09420-05009	5034842	441	REC15440-93J00	5034985	390
REC0763765		422	REC09420-05009	5033632	441	REC15440-99E01	5030706	391
REC0763767	583340	419	REC09420-05009	5084842	441	REC15626-90J00	5033706	394
REC0763767	583536	419	REC09420-05009	5034842	507-508	REC15626-99E00	5031114	394
REC0763767	763767	419	REC09440-05027	5033034	499-534	REC15710-65D00	5033708	395
REC0763767		421-422	REC09440-32008	5033037	499-534	REC15710-66D00	5032693	395
REC0763769	583410	419	REC09440-40002	5031286	505-534	REC15710-87J00	5031403	395
REC0763769	763769	419			509-510-511-513-517-519-531	REC15710-93J00	5035010	396
REC0763769		421	REC10-79953Q04	307551	513-517-519-531	REC15710-99E00	5030708	395
REC0763770	581651	419				REC160084	160084	517-525-528
REC0763770	584755	419	REC10W30U3		392	REC16433-93J00	5035022	487
REC0763770	585087	419	REC10W30U6		392	REC16510-05240	5033102, 7	391
REC0763770	763770	419	REC10W40U3		392	REC16510-82703	5033919	391
REC0763770		420	REC10W40U6		392	REC16510-82703	778887	391
REC0763773	584804	418			523-527-529-531	REC16510-87J00	5031411	391
REC0763773	763773	418	REC11-35921	314730	523-527-529-531	REC16510-87J00	778885	391
REC0763773		420-421	REC11141-87J02	5031293	463-464	REC16510-90J00	5033539	391
REC0763776	583289	418	REC11141-87J02	5034353	464	REC16510-90J00	778886	391
REC0763776	583379	418	REC11141-90J01	5033639	464	REC16510-93J00	5035703	391
REC0763776	582514	418	REC11141-91J10	5033342	464	REC16510-93J00	778888	391
REC0763776	583045	418	REC11141-92J01	5034644	464	REC16910-GB2-005	5030183	389
REC0763776	763776	418	REC11141-93E20	5033046	464	REC173944	173944	425
REC0763776		421-422	REC11141-93J10	5036629	464	REC173944	172588	425
REC0763779	584643	419	REC11141-93J10	5035971	464	REC17400-87E04	5031731	451-506
REC0763779	763779	419	REC11141-95J00	5036802	464	REC17400-90J20	5033541	451-507
REC0763779		422	REC11141-97J02	5037490	464	REC17400-92J00	5037176	450
REC0763782		421-422	REC11142-93J10	5035971	464	REC17400-93951	5033106	450-499
REC0763791	583512	413	REC11142-93J10	5036629	464	REC17400-93J01	5035036	451
REC0763791	584205	413	REC11189-87J00	5031297	463-465	REC17400-94J00	5037545	450
REC0763791	585192	413	REC11265-87E10	5030623	462-463	REC17400-95J02	5036908	451-501
REC0763791		414	REC11400-87804	5034354	465	REC17400-96403	5031744	451-503-505
REC0763793	582705	415	REC11400-87804	5036714	465	REC17400-96J03	5035036	508
REC0763803	584642	414-422	REC11400-87804	5031302	465	REC17400-98652	5030352	449
REC0763808	175386	417-420-421	REC11400-87804	5034354	465	REC17400-98661	5034323	449-497
REC0764708	581397	417-420	REC11400-87804	5036714	465	REC17411-93901	5033107	452-499
REC0765386	586015	414	REC11400-87804	5031302	465	REC17411-94421	5031990	445-503-505
REC0765386	586098	414	REC11413-87J00	5031304	463-466	REC17413-92J01	50367173	448
REC0765386	586292	414	REC11413-87J00	5032428	466	REC17413-95J00	5036900	448-501
REC0765386		421	REC11433-87J00	5031306	463-466	REC17413-96J01	5035038	508
REC0767407	433935	439-453	REC11489-87J00	5031307	463-484	REC17413-99E11		506
REC08110-60020	5033299	499-538	REC11489-90J00	5033649	484	REC17416-93J00	5035039	448
REC08110-60050	5033303	499-540	REC11489-93E11	5034462	484	REC17416-95J00	5036901	448-501
REC08113-60060	5032295	501-503-540	REC11489-93J00	5034878	484	REC17416-96J00	5035039	508
REC09116-06094	5030034	462-499-501-505-508	REC115742	115742	416-420	REC17417-92J00	5037175	448
REC09116-06121	5030391	462	REC12-191833	307552	509-510	REC17450-93921	5033109	499
REC09116-06121	5032502	462	REC12-191833	311598	519	REC17452-93910	5033110	449
REC09116-06121	5030391	501-503	REC12065		449-553	REC17453-93901	5033111	499-540
REC09141-12005	5032950	548	REC12104		452-454	REC17453-93901	5035609	540
REC09160-20027	5032966	533	REC12108		453	REC17461-87E12	5030723	506
REC09160-20041	5032985	499-533	REC125017	302540	445	REC17461-90J01	5033542	507-508
REC09160-20042	5032967	499-533	REC126776	126776	438	REC17461-93903	5033112	499
REC09160-20043	5032968	499-533	REC126870	126870	525-529	REC17461-96312	5031417	501-503-505
REC09160-20044	5032969	499-533	REC126870		538	REC17461-98503	5030188	497
REC09160-21009	5032970	499-533	REC126870	3852020	549	REC17462-93990	5033113	441-499
REC09160-26015	5031232	505-533	REC126870		550-552	REC17471-92J00	5034651	448
		489-497-499-501-503-505-506-507	REC127084	127084	519-520	REC17471-92J00	5037170	448
REC09168-10022	5030071	506-507	REC127084		538	REC17471-92J00	5030724	448
REC09168-10034	5034799	508-540	REC127084	127084	549	REC17471-92J00	5037170	448
REC09168-12012	5030465	391	REC127084		549-550-552	REC17471-92J00	5034651	506
REC09168-12017	5031863	391	REC12761-72F00	5030660	481	REC17471-92J00	5037170	507
REC09168-12017	5032987	391	REC12761-93E10	5033070	481	REC17471-92J02	5035041	448-508
REC09202-04002	5030084	505-548	REC12778-93J00	5034916	487	REC17471-93902	5033114	448-499
REC09202-05022	5031245	534	REC13119-93J00	5034959	486	REC17471-94401	5031418	448-503-505
REC09204-02004	5032996	548	REC13122-95J00	5036852	487	REC17471-95J01	5036902	448-501
REC09209-08016	5031880	501-503-534	REC13200-91J70	5036549	396	REC17471-97J00	5037431	448
		497-499-501-503-505-506-540	REC13200-91J70	5036191	396	REC17471-98601	5031196	448
REC09248-10008	5030094	507-540	REC13200-91J70	5036192	396	REC17471-98601	5030189	448
		499-537	REC13250-95D01	5033086	397	REC17472-87E10	5030725	446-506-507
REC09263-15019	5033002	501-503-537	REC13260		435	REC17472-91J00	5033381	449-497
REC09263-20046	5031883	501-503-540	REC13270		435-439	REC17472-93911	5035603	449-499
REC09263-20047	5031884	499-533	REC13280		435	REC17472-93J00	5035042	449-508
REC09263-20L04	5033003	505-540	REC13290		435	REC17472-96303	5036681	446
REC09263-22020	5031255	505-540	REC13310		435	REC17472-96303	5031419	446
REC09263-22L03	5031256	505-537	REC13350		434-439	REC17472-96303	5036681	463-501-503-505
REC09263-25025	5031257	505-541	REC13421-87J00	5031390	463-466	REC17472-97J00	5037432	448
REC09263-25062	5031258	505-541	REC13450		434	REC17472-98611	5030190	449
REC09265-17002	5031885	501-503-538	REC13650-52G00	5031392	399	REC175266	175266	550-551-552
REC09280-08005	5031260	539	REC13650-56B00	5030687	399	REC175267	175267	549-550-551-552
REC09280-11005	5031261	539	REC13910-89J01	5032424	397-398	REC175268	175268	549-551-552
REC09280-22019	5035305	462	REC1397-2150	983870	390	REC175269	175269	549-551-552
REC09280-54001	5033009	391	REC1397-2150	910139	390	REC17616-87J00	5031426	463
REC09280-57002	5033010	499-540	REC1399-07350	397839	392	REC17616-87J00	5031426	466
REC09280-75001	5031263	501-505-540	REC1399-07351	438562	392	REC17670-87J00	50317562	434
REC09282-10008	5030107	489-497	REC1399-07352	438555	392	REC17670-90J10	5033722	434
REC09282-12008	5030108	489	REC14151-93J00	5034978	482	REC17670-91J01	5033385	434
REC09282-12010	5033011	489	REC14152-93J00	5034979	482	REC17670-93962	5030742	434

REF	R.O. / OEM	
REC17670-93962	5031175	434
REC17670-93962	5030742	434
REC17670-94402	5031758	434
REC17670-94J01	5036226	434
REC17685-87D10	5031430	463-465
REC17693-95J00	5036914	487
REC17913-93J00	5035054	439
REC17914-93J00	5035055	439
REC18-32665	302804	548
REC18-4329		467
REC18-4330		467
REC18-4331		467
REC18-4332		467
REC18-6865	5005114	425
REC18-7044		398
REC18-7761		397-398
REC18-8355		467
REC18137-52D00	5035412	399
REC18590-72F21	5033780	399
REC203130	203130	475-479
REC21-20553	305981	531
REC22-67892A05	318544	509-515-519-520-525-528-551-552
REC22186		
REC22660	397627 + 345992 + 332491	514-533
REC22660		535
REC22670	397338 + 318304 + 3180303	518-533
REC22670		535
REC23311-95DLO	5031449	539
REC24942		385
REC24950		385
REC24952		385
REC25-25439	3852565	445
REC25-30224	310327	515
REC25-30613	310585	445
REC25-30613	310967	445
REC25-30613	310585	452-531
REC25-33145	302337	445
REC25-35027	303360	445
REC25-48171	202893	445
REC25-62702	303191	445
REC25-62705	311338	445-513
REC25000	89876A3	385
REC25010		385
REC25020		385
REC25030		385
REC25222-93901	5030215	539
REC25222-96300	25222-96300	539
REC25700-87E00	5030973	442
REC25700-87E00	5034775	441
REC25700-88L00	5031456	441-505
REC25700-90J01	5033798	442-507
REC25700-92J00	5033922	442-507
REC25700-93J00	5035077	442-508
REC25700-95D01	5032167	441
REC25700-95D01	5036040	441
REC25700-95D01	5032167	503
REC25700-95J00	5037038	441-501
REC25700-99E00	5034776	441-506
REC25W40U3		392
REC26-01674	332583	513
REC26-43035		445
REC26-69188		444-445
REC26-69188	321453	443-513-531
REC26-76868		444-445
REC26-76868	320862	443-525-531
REC27-62386001	310058	433-435-436
REC27-62386001	332108	436
REC2TU3		392
REC2TU6		392
REC300-01633	330525	409
REC300-01744	203698	409
REC300-03585	586075	413-414
REC300-03586	586048	413-414
REC300-03587	585001	412-414
REC300-03588	584890	412-414
REC300-08010	439561	413-414
REC300-26084	583663	417
REC300-26084	583667	417
REC300-26084	584488	417
REC300-26084		420
REC300-26085	583896	417
REC300-26085	584329	417
REC300-26085	584331	417
REC300-26085	584489	417
REC300-26085		420-421
REC300611	300611	439-441-510
REC300771	300771	441
REC301877	301877	445-510-513
REC301967	301967	432-445-511
REC302035	302035	523-527-529
REC302325	302325	452-510
REC302325	324960	511
REC302325	302325	515-517-519-523-527-529
REC302325	302873	531
REC302497	302497	509-510-511-513
REC302537	302537	445
REC302564	302564	443-444
REC302588	302588	445-517

REF	R.O. / OEM	
REC303345	303345	443-444
REC303347	303347	445-513
REC303615	303615	393
REC304174	304174	445
REC304454	304454	510-513
REC305123	305123	445-525-531
REC305176	305176	483
REC305185	305185	390
REC305242	305242	445-509
REC305282	305282	515-517
REC305586	305586	437
REC305762	305762	517
REC306376	306376	515
REC306643	306643	433-452-510-523-527-529-531
REC307069	307069	476-479
REC307133	307133	485
REC307161	307161	520-528
REC308239	308239	390
REC308328	308328	437
REC308627	308627	510
REC308876	308876	445
REC308928	308928	439-441-517-519-531
REC309004	309004	511
REC309243	309243	515
REC309731	309731	445
REC309955	309955	531-548
REC309989	309989	443
REC31-02747	330854	470
REC31-02748	382481	470
REC31-02798	389613	470
REC31-02799	393896	469-470
REC31-02803	385503	470-471
REC31-02806	390641	470-471
REC31-17514A2	437088	469
REC31-32575T1	385175	517-536
REC310414	310414	445
REC310433	310433	470-471
REC310584	310584	445-515
REC310599	310599	443-444
REC310649	310649	443
REC311145	311145	437
REC311538	311538	523-527-529
REC313175	313175	445
REC313282	313282	443-444
REC313284	313284	443-444
REC313339	313339	515-517-519
REC313340	313340	445
REC313353	313353	443
REC313445	313445	519
REC313447	313447	519-536-537
REC313448	313448	519-520-525-529-531
REC313715	313715	519-525-528-531
REC313754	313754	445-519
REC313763	313763	480
REC313763	313715	520
REC313782	313782	475-479
REC314008	314008	452-519-523-527-529-531
REC314082	314082	517-519
REC314115	314115	488
REC314167	314167	443-444
REC314491	314491	445
REC314502	314502	515-517-519-520-548-549-550-552
REC314503	314503	515-517-519-520-548-549-550-552
REC314728	314728	445-523-527-529-531
REC314731	314731	520-525-531-536-537
REC314745	314745	523-527-529-531
REC315232	315232	398
REC315538	315538	484
REC315578	315578	486
REC315788	315788	517
REC315810	315810	515-517-519-520-549-550-552
REC315837	315837	517
REC315838	315838	517
REC315868	315868	482
REC315869	315869	482
REC316506	316506	510-513-515-531
REC316563	316563	531
REC317230	317230	519-536-537
REC317232	317232	519
REC317245	317245	432-433-435-437-439
REC317624	317624	515-523-527-529
REC317914	317914	483
REC317955	317955	483
REC318303	318303	519-533-535
REC318335	318335	484
REC318358	318358	475-480
REC318372	318372	445-515-517-519-523-527-529-531

REF	R.O. / OEM	
REC318373	318373	432-480
REC318395	318395	432-435-437-439
REC318717	318717	445
REC318917	318917	437
REC318924	318924	486
REC318925	318925	482
REC318932	318932	485
REC318971	318971	510-548-549-551-552
REC318972	318972	443-444-510
REC318995	318995	453-510
REC319085	319085	510
REC319174	319174	486
REC319276	319276	519
REC319332	319332	485
REC319348	319348	480
REC319586	319586	519
REC319633	319633	475-479
REC319665	319665	484
REC319710	319710	480
REC319890	319890	549-552
REC319891	319891	513-548-549-551-552
REC319895	319895	517-535
REC320041	320041	513-517-519
REC320140	320140	531
REC320145	320145	519-520
REC320166	320166	517
REC320167	320167	517
REC320168	320168	517
REC320305	320305	515-517-549
REC320305	320305	538-549-552
REC320310	320310	515-517
REC320311	320311	515-517
REC320570	320570	525-529-531-549
REC320570	320570	550-552
REC320635	320635	531-535
REC320679	320679	488
REC320775	320775 + 320776	447
REC320775	320775	453
REC320775	320775-6	517
REC320785	320785	513-548-551
REC320785	320785	549-552
REC320880	320880	433-435-438-439
REC320936	320936	483-523-527-529
REC320943	320943	452-523-527-529-531
REC320961	320961	483-523-527
REC320981	320981	453-517
REC321008	321008	452-523-527-529
REC321027	321027	433-435-437-439
REC321120	321120	433
REC321182	321182	483
REC321184	321184	433-435-437
REC321220	321220	435-437-439
REC321221	321221	433-435-438-439
REC321222	321222	433-435-438-439
REC321459	321459	443-444-511
REC321466	321466	443-444-445
REC321467	321467	443-444-468-515-517
REC321480	321480	443-444-510
REC321481	334950	443-444
REC321481	321481	510
REC321497	321497	489
REC321692	321692	432-435-436-439
REC321722	321722	488
REC321738	321738	510-513
REC321786	321786	443-444
REC321787	321787	443-444-511
REC321788	321788	443-444-468
REC321794	3214794	488
REC321831	321831	443-468
REC321886	321886	438
REC321895	321895	443-468
REC321921	321921	511
REC321928	321928	443-444-513
REC321932	321932	432-435-436
REC322494	322494	509
REC322938	322938	525-529
REC322941	322941	520-525
REC323214	323214	481
REC323338	323338	488
REC323361	323361	523-527-529
REC323362	323362	523-527-529
REC323469	323469	483
REC323582	323582	436
REC323664	323664	520
REC323664	323664	520-533
REC323664	323664	535
REC323889	323889	519
REC323890	323890	519
REC323942	323942	510-549-551-552
REC323943	323943	513-549-551-552
REC324097	324097	447-453-510

REF	R.O. / OEM		REF	R.O. / OEM		REF	R.O. / OEM	
REC38410-93J12	5036701	425	REC331353	331353	452-523-527-529-531	REC338893	338893	452-523-527-529-531
REC38410-93J12	5034606	425	REC331532	331532	487	REC339044	339044	436
REC324334	324334	510	REC331880	331880	519-525-528	REC339543	339543	445
REC324369	324369	519-520-525-529-531	REC331901	331901	439	REC339543	303059	445-517
REC324449	324449	511	REC331901	331901	441-517-519	REC339620	339620	443-468
REC324639	324639	443-444-509	REC331916	331916	482	REC340115	340115	475-480
REC324639	324639	509	REC331917	331917	482	REC340116	340116	476
REC324640	324640	453-509	REC331980	331980	509-517	REC340116	333554	476
REC324641	324641	447-453-509	REC331980	331980	324430	REC340116		480
REC324670	324670	523-527	REC331999	331999	520-525-528	REC340559	340559	467
REC324670	352165	529	REC332108	332108	437	REC340559	34559	467
REC324717	324717	480	REC332130	332130	436	REC340559	778417	467
REC324766	324766	519-520-536-537	REC332200-76G02	5031468	399	REC340619	340619	447
REC324852	324852	515-528	REC332200-76G02	5032786	399	REC340619		453-454
REC324937	324937	483-517-519	REC332261	332261	443-444-513	REC340619	340619	515-519
REC324981	324981	515-519	REC332266	332266	486	REC340811	340811	513
REC325040	325040	509	REC332319	332319	485	REC341038	341038	453-454 -515-519
REC325092	325092	485	REC332369	332369	432-435-437	REC341219	341219	520-528
REC325211	325211	482	REC332491	332491	515-533-535	REC341220	341220	523-527-529
REC325260	325260	486	REC332514	332514	515-536-537	REC341280	341280	443-523-527-529
REC325397	325397	447-453	REC332583	317178	445	REC341280		529
REC325537	325537	513	REC332583	332584	445-452	REC341281	314281	443-525-529
REC325721	325721	480	REC332583	332583	445	REC341732	341732	515-517-519
REC326649	326649	445	REC332583	305739	445	REC342513	342513	432-481
REC326649	909047	445	REC332584	332584	515-517-528	REC342786	332205	443
REC326649	329380	445	REC332816	332816	476-479-480	REC342786	342786	443-515-519
REC326741	326741	445	REC332817	332817	476-480	REC342786		444
REC326849	326849	529	REC332818	332818	476-480	REC342786	321466	517
REC326926	326926	485	REC332819	332819	475-480	REC342786	332205	517
REC327031	327031	443-444	REC332944	332944	435-436	REC343105	343105	435-438
REC327345	327345	519-520	REC333008	333008	488	REC343105	3343105	438
REC327606		458	REC333572	333572	445-511	REC343141	343141	432-436
REC327606AL		458	REC333670	334726	476	REC343853	343853	481
REC327656	327656	523-527-529-531-536-537	REC333670	333670	476	REC343863	343863	482
REC327669	327669	525-529-536-537	REC333725	333725	515-536-537	REC344386	344386	481
REC327674	327674	484	REC333758	333758	515	REC344470		439
REC327707	327707	485	REC333771	333771	515	REC344470	330619	441-511
REC32800-38F10	5036107	412	REC333771	342786	517	REC344470	344470	513-517-519
REC32800-87J10	5032615	412	REC333771		536-537	REC344771	344771	436
REC32800-89J00	5032030	412	REC333879	333879	481	REC345257	345257	476-480
REC32800-89J11	5034680	412	REC333957	333957	520-525-529	REC345905	345905	527-537
REC32800-90J00	5036618	412	REC33410-94400-000	5032732	400	REC346006	346006	537
REC32800-90J00	5033820	412	REC334163	334163	517-519-520-525-529	REC34801-93J03	5035099	425
REC32800-92E20	5030795	412	REC334590	334590	510-549-552	REC34801-93J03	5036277	425
REC32800-93J03	5036637	413	REC334897	334897	439-441-515-519	REC34801-99E04	5036054	425
REC32800-94620	5034255	411	REC334950	334950	525-529	REC34801-99E04	5031474	425
REC32800-94J11	5036261	411	REC335334	335334	394	REC34801-99E04	5031116	425
REC32800-95D01	5030356	411-420	REC335359	327795	475	REC349193	349193	529-536-537
REC328096	328096	517-519-525	REC335359	335359	475	REC35-49088A2	312456	390
REC328522	328522	510	REC335359	335359	475	REC35-53336	908034	390
REC328522	552906	548	REC335361	335361	479	REC35-802893Q		385
REC328522		549-552	REC335361	335361	476	REC35-802893Q01		385
REC328522	328522	551	REC335361	325647	476-480	REC350038	350038	529
REC328590	328590	481	REC335403	335403	480	REC350271	350271	520-525-529
REC328603	328603	467	REC335404	335404	480	REC350357	342291	484
REC328618	328618	480	REC335419	335419	485	REC351018	351018	480
REC328622	328622	486	REC335523	335523	485	REC351019	351019	483
REC328623	328623	475-480	REC335633	335633	481	REC352960	320499	470-471
REC328694	328694	515	REC335679	335679	445	REC353076	332942	443-468
REC328702	328702	523-527-529	REC335818	335818	486	REC354580	338601	523-529
REC328725	328725	509	REC335819	335819	537	REC356900	347371	529-537
REC328743	328743	520	REC335981	335981	485	REC377139	377139	470-471
REC328744	328744	509	REC336178	336178	485	REC37820-92E03	5031481	422
REC328751	328751	447-453-454-511-513	REC336185	336185	436	REC378252	378252	469-470-471
REC328753	328753	513	REC336185	336185	432-438	REC37830-89E03	5030225	422
REC328754	328754	513	REC336226	336226	432	REC37830-89E03	5032047	422
REC328755	328755	513-453-454	REC336227	336227	438	REC378444	378444	410
REC328825	328825	525	REC336289	336289	486	REC378444	777700	410
REC329076	329076	437	REC336308	336308	486	REC379504	379504	519-520
REC329103	329103	475-479	REC336388	336388	486	REC379504		536-537
REC329390	329390	511	REC336493	336493	483	REC38100-87J00	5031482	424
REC329419	329419	475-479	REC336530	336530	486	REC38100-96J00	5033838	424
REC329718	329718	487	REC336947	336947	509	REC38100-96J00	5034526	424
REC329826	329826	483	REC336982	336982	515-519	REC38100-96J00	5034627	424
REC329828	329828	480	REC337061	337061	437	REC38100-96J00	5035113	424
REC329830	329830	432-437	REC337067	337067	520-525-528	REC38100-96J00	5035113	424
REC329836	329836	476-480	REC337068	337068	437	REC38100-99E01-OEP	5030829	424
REC329920	329920	484	REC337533	337533	437	REC38100-99E01-OEP	5030828	424
REC329922	329922	443-444-445	REC337774	337774	438	REC38100-99E01-OEP	5030830	424
REC329923	329923	443-444-445-468	REC337774	337774	525-529-533	REC382343	382343	515-519-536
REC329975	329975	481	REC337774	914716	531	REC382363	382363	397
REC330137	330137	443-444-445-468-519-520	REC337778	337778	533	REC382407	382407	515-519-520-525-529-536-537
REC330265	330265	515-520-525-528	REC337778	337778	535	REC382407		537
REC330273	330273	438-439	REC338222	338222	520-525	REC382408	382408	519-520-525-531-536-537
REC330327	330327	443-444-468-511	REC338484	338484	475	REC384087	384087	446-453-517
REC330560	330560	445-453-511	REC338485	338485	452-523-527-529-531	REC384195	384195	523-536-537
REC330689	330689	489	REC338485	338485	536-537-452	REC385043	385043	519-520-536-537
REC330818	330818	475	REC338486	321188	454	REC385068	385068	519-536
REC330909	330909	489	REC338486	338486	454	REC385072	385072	439-454
REC331016	331016	483	REC338486	338486	447-452-527-529-531	REC385072	385072	519
REC331103	331103	443	REC338504	338504	523-527-529	REC3852045	329381	445
REC331107	331107	439-441-452-523-529	REC338518	313893	445	REC3852045	303067	445
REC331188	331188	435-515-527-529	REC338522	338522	445-513	REC3852045	332584	519
REC331188	321175	529	REC338632	338632	445	REC3852056	306394	509-525-529
REC331211	331211	476-480	REC338636	338636	435-436	REC3852056	3852056	548
			REC338876	338876	523-529	REC3852120	313416	550-552
			REC338879	338879	393	REC3852548	3852548	443
			REC338882	338882	393	REC3852928	305270	445
					488	REC3852928	913921	515

REF	R.O. / OEM		REF	R.O. / OEM		REF	R.O. / OEM	
REC3853655	916058	443	REC398172	398172	478-480	REC439075		398
REC3855081	311598	513-515-517-520-525-528	REC398514	398514	393-395	REC439076	439076	397
REC3857533	584416	410	REC398529	398529	469-470-471	REC439076	434888	397
REC3857533	581295	410	REC398693	398693	479-480	REC439076	435443	397
REC3857533	582472	410	REC398874	398874	515	REC439076	398526	397
REC3857533	582473	410	REC398901	398901	515-536	REC439076	392550	397
REC3857533	586147	410	REC40135	398327	389	REC439076		398
REC3857533	586224	410	REC40135	398319	389	REC439077	439077	452-453
REC3857533	777702	410	REC40145	354016	389	REC439078	435752	396
REC386084	386084	439-453-510	REC40155		389	REC439078	439078	396
REC386280	386280	473	REC40165		389	REC439078	435678	396
REC386573	386573	488	REC40970		423	REC439078	43577	396
REC386573	319771	488	REC40990		423	REC439078	435676	396
REC386764	386764	515-517-536	REC414153	434153	551-552	REC439078		398
REC386765	386765	515-517-536	REC431870	431870	474	REC439083	393433	477
REC386766	386766	536	REC43211-87JLO	5032058	539	REC439083	439083	477
REC386866	386866	551-552	REC43211-94401	5032058	539	REC439083		479
REC386918	386279	473	REC432264	432264	515-536	REC439084	385416	477
REC387247	387247	525-531-536-537	REC432276	432276	515	REC439084	390078	477
REC387262	379312	398	REC432570	432570	478-480	REC439084		479-480
REC387262	387262	398	REC432941	432941	439-453-515	REC439085	389556	478
REC387262	387262	398	REC432955	432955	451-454	REC439085	391300	478
REC387656	387656	523-527-529-531	REC432962	432962	394-395	REC439085	439085	478
REC387656		536-537	REC433190	433190	389	REC439085		480
REC387787	387787	469-471	REC433190	765553	389	REC439138	439138	515-538
REC387817	387817	527-529-531	REC433550	433550	541-543	REC439185	439185	519-538
REC387817		536-537	REC433570	433570	517-535	REC439476	439476	523-527-529-531
REC388344	388344	469-470-471	REC434137	434137	433	REC439559	439559	478-480
REC38860-76F01	5033264	409	REC434381	434381	478	REC439973	439973	493-525
REC389039	389039	525-529	REC434381	394885	480	REC4428	5004428	393
REC389039		536-537	REC434391	434391	519	REC4428	5000800	393
REC389042	389042	525-529	REC434424	434424	439-453	REC4428	439347	393
REC389042		536-537	REC434467	434467	525-536-537	REC48630-92J00	5033935	426
REC389133	389133	451-453	REC434588	434588	515	REC48630-94900	5030870	426
REC389455	389455	525	REC434839	434839	391	REC5000074	5000074	525
REC389576	389576	439	REC434844	434844	468-471	REC5000308	5000308	450-453
REC389576		453	REC435027	435027	523	REC5000309	5000309	541-543
REC389576	436137	439-509	REC435123	435123	525-532	REC5000400	5000400	478-480
REC389577	389577	445-453-509	REC435123	336565	525	REC5000611	581670	418
REC390286	390286	439	REC435123		535	REC5000611	584504	418
REC390509	390509	473	REC435274	435274	515	REC5000611	584840	418
REC390510	390510	473	REC435390	435390	446-453-510	REC5000611	585073	418
REC390613	390613	445-453	REC435491	435491	433-435	REC5000611		420-421
REC390900	390900	469-470-471	REC435519	435519	519	REC5000614	5000614	529-538
REC391170	391170	473-474	REC435546	5006655	473	REC5000615	5000615	523-527-538
REC391416	391416	473-474	REC435548	435548	425	REC5000618	5000618	538
REC391741	391741	450-453	REC435548	983446	425	REC5000624	5000624	529-538
REC391988	391988	479-480	REC435548	985237	425	REC5000626	5000626	538
REC393088	393088	393	REC435597		435	REC5001036	5001036	433
REC393088		395	REC435957	435957	432	REC5001344	584767	416
REC393103	393103	394-395	REC435957	321692	438	REC5001344	584768	416
REC393561	393561	483	REC435990	435990	446	REC5001344	584908	416
REC393630	393630	450-453-513	REC435990	435990	454	REC5001344	585074	416
REC393632	393632	446-453-513	REC435990	435990	523-527	REC5001344		420-421
REC39390	398047	477	REC436254	436254	529	REC5001593	5001593	439
REC39390	438904	477	REC436353	436353	474	REC5001593	435821	439-452-523
REC39390		479-480	REC436358	436358	474	REC5001593		454
REC394408	394408	438-439	REC436745		458	REC5001593	5001593	527-529
REC394411	394411	433	REC436745AL	436745	458-517-519-520-525-529	REC5001594	5001594	452-454
REC394462	394462	466	REC436888	436888	538	REC5001595	5001595	452-454
REC394711	394711	449-453	REC436891	436891	479	REC5004218	910994	525
REC394930	394930	473-474	REC436891	436891	479	REC5004218	5004218	532
REC395073	395073	452-454	REC436891	436891	480	REC5004218		535
REC395209	395209	525-538	REC436972	436972	474	REC5004257	5004257	525
REC395270	395270	450	REC437090	437090	433-435	REC5004428	5004428	393
REC395270		453	REC43711-97E11	5030852	539	REC5004428	5000800	393
REC395289	395289	439	REC43713		542	REC5004428	439347	393
REC395289		453-454	REC437155	437155	479-480	REC5004532	584808	415
REC395289	395289	511-513	REC437288	437288	513	REC5004532	585145	415
REC395401	395401	469-470	REC437330	437330	523-527-529	REC5004532	585189	415
REC395627	395627	468-470-471	REC437725	437725	479-480	REC5004532	5004533	415
REC395861	395861	466	REC437907	437907	450-454	REC5004532		415
REC396350	396350	541-543	REC438543	438543	446-453-454	REC5004705	394488	466
REC396351	396351	513-541-543	REC438544	3438544	519	REC5004765	5004765	525-529-538
REC396352	396352	542-453	REC438544		445	REC5005034	5005034	551-552
REC396355	396355	541-543	REC438544		453	REC5005801	5005801	409
REC396377	396377	473-474	REC438544	438544	515	REC5005801	175974	409
REC396379	396379	473-474	REC438545	438545	453-515	REC5005907	5005907	477-479
REC396504	396504	473-474	REC438559	438559	393	REC5005931	5005931	478-480
REC396520	396520	398	REC438559	765591	393	REC5006180	5006180	428
REC396521	378895	398	REC438579	438579	451-454	REC5006181	5006181	428
REC396521	396521	398	REC438592	438592	451-453	REC5006182	5006182	429
REC396521	678882	398	REC438602	438602	450-453	REC5006184	5006184	429
REC396521		398	REC438616	438616	394-395	REC5006186	5006186	429
REC396522	379312	398	REC438996	438996	396	REC5006241	5006241	523-527-529
REC396522	396522	398	REC438996	438996	396	REC5006373	5006373	541-543
REC396522		398	REC438996	438996	396	REC5006657	5006657	473
REC396644		453	REC439071	439071	396	REC5006658	5006658	473
REC396701	396701	397	REC439071	398532	396	REC5006662	5006662	473
REC396701	398729	397	REC439071	383067	396	REC5006664	5006664	473
REC396701	392061	397	REC439071	383052	396	REC5006665	5006665	473
REC396701		398	REC439071	382049	396	REC5006666	5006666	474
REC396725	396725	439-519	REC439071		396	REC5006668	5006668	473
REC396725		453-454	REC439072	439072	396	REC5006670	5006670	473
REC396750	396750	478-480	REC439072	398452	396	REC5006687	5006687	474
REC396987	396987	433-435-439	REC439072	391305	396	REC5006688	5006688	474
REC397537	397537	515	REC439072	398453	396	REC5006694	5006694	474
REC397538	397538	515-536	REC439072		398	REC5006701	5006701	474
REC398042	398042	525-529-551	REC439074	4359073	397-398	REC5006702	5006702	474
REC398042		550-552	REC439075	439074	397	REC5006710	5006710	474
REC398051	398051	467	REC439075	439075	397	REC5006713	5006713	474

REF	R.O. / OEM		REF	R.O. / OEM		REF	R.O. / OEM	
REC5006714	5006714	474	REC584580	584580	409	REC925093	5031890	503
REC5006716	5006716	474	REC586774	586774	410	REC925093	320303	517
REC5006751	5006751	474	REC586774	5009214	410	REC93-06511	312932	408
REC5007022	439972	493	REC59178-97J00	5037356	540	REC93-06511		408
REC5007022	438048	493	REC5W40U3		392	REC93-06522	323653	408
REC5007022		493	REC5W40U6		392	REC93-06522	338534	408
REC5007022	439972	525	REC63P-13907-03	5032617	393	REC93-06522		408
REC5007129	5007129	479-480	REC63P-13907-03	5033702	393	REC93-08663	203697	408
REC5007190	387041	469-471	REC63P-13907-03	5036635	393	REC93-08664	203725	408
REC5007335	5007326	389	REC63P-13907-03	5030700	393	REC93-08665	330527	408
REC5007335	5005266	389	REC65720-98520	5033221	384	REC93-08666	331970	408
REC5007672	5000623	529-538	REC65720-986L0	5032150	384	REC93-08667	335905	408
REC5007850	5007850	477-480	REC65L-24563-00	5035695	389	REC93-08668	395460	408
REC5007968	435959	446-454	REC65L-24563-00	778162	389	REC93606-12019	5030508	507-508
REC5007968	435959	523-527-531	REC67F-12411-01	5033722	434	REC967344	313446	445-519-520
REC5008966	320569	531-550	REC69J-24501-10	5034995	391	REC981195	981195	443
REC5010190		458	REC6F5-12411-03	5005440	432-433	REC981196	981196	443
REC5010190AL		458	REC6F5-12411-03	434841	433-435	REC981268	981268	443
REC51123-93J00	5035133		REC6F5-12411-03		439	REC981911	981911	390
REC51142-93J00	5035135		REC70720		388	REC982230	982230	390
REC51211-87J00	5031523	463-465	REC763735	387361	439-453	REC984491	984491	390
REC51211-90J10	5034757	465	REC763775	583533	418	REC986979	22631 + 22632 + 22633	532
REC51211-90J2	5037205	465	REC763775	584586	418	REC986979		535
REC51211-93J00	5035138	465	REC763775	763775	418	REC986979		385
REC51212-94400	5031535	449	REC763775		422	REC986979		386
REC51212-90J01AL	5032929	506-507	REC764102	387139	469	REC986979		386
REC51212-90J01AL	5035150	508	REC764102	387142	469	REC986979		386
REC51212-91J01AL	5032191	503	REC764102		470-471	REC986979		386
REC51212-91L01		458	REC764337	313992	443	REC986979		426
REC51212-91L01AL		458	REC765431	382547	439-454-519	REC986979		426
REC51212-91L01AL	5032091	501	REC765642	329391	453-511	REC986979		426
REC51212-95500		458	REC766779	335360	476	REC986979		426
REC51212-95500AL		458	REC766779	320745	476	REC986979		426
REC51212-93J10	5035151	508-540	REC766779		480	REC986979		426
REC51212-93J10			REC766871	318609	484	REC986979		426
REC51212-93J10			REC767970	305987	443-468	REC986979		386
REC51212-93J10			REC775518	375638	439-453	REC986979		385
REC51212-93J10			REC777129	389589	439	REC986979		494
REC51212-93J10			REC777129		453	REC986979		392
REC51212-93J10			REC777129	331107	527	REC986979		392
REC51212-93J10			REC777129	389642	439	REC986979		392
REC51212-93J10			REC777129		454	REC986979		392
REC51212-93J10			REC777212	385528	531	REC986979		392
REC51212-93J10			REC777213	377230	439-453-517	REC986979		545
REC51212-93J10			REC777214	396809	439-453-517	REC986979		545
REC51212-93J10			REC802113	394546	477-479	REC986979		545
REC51212-93J10			REC802133	433941	477	REC986979		545
REC51212-93J10			REC802133	392567	477	REC986979		545
REC51212-93J10			REC802133	392615	477	REC986979		545
REC51212-93J10			REC802133		479	REC986979		545
REC51212-93J10			REC802243	313065	482	REC986979		545
REC51212-93J10			REC802288	325273	475-479	REC986979		545
REC51212-93J10			REC802307	332010	475-479	REC986979		545
REC51212-93J10			REC80W90U3		392	REC986979		545
REC51212-93J10			REC80W90U6		392	REC986979		545
REC51212-93J10			REC855686		385	REC986979		545
REC51212-93J10			REC87604		542-543	REC986979		545
REC51212-93J10			REC87606		542	REC986979		545
REC51212-93J10			REC87607		542	REC986979		545
REC51212-93J10			REC87608		542-543	REC986979		545
REC51212-93J10			REC87617		542-543	REC986979		545
REC51212-93J10			REC87619		542-543	REC986979		545
REC51212-93J10			REC87622		542-543	REC986979		545
REC51212-93J10			REC87670		468	REC986979		545
REC51212-93J10			REC878763	396041	469-471	REC986979		545
REC51212-93J10			REC878846	313413	476-479-480	REC986979		545
REC51212-93J10			REC878904	436195	432-433-439	REC986979		545
REC51212-93J10			REC89-825096T01	5030783	409	REC986979		545
REC51212-93J10			REC90095		494	REC986979		545
REC51212-93J10			REC90171-18M04	5030422	505-506-507-508	REC986979		545
REC51212-93J10			REC90171-18M04	09141-18005	548	REC986979		545
REC51212-93J10			REC90179-08M06	5031827	501-503	REC986979		545
REC51212-93J10			REC90794-46866		386	REC986979		545
REC51212-93J10			REC908158	908158	519-520-525-529	REC986979		545
REC51212-93J10			REC908194	908194	445	REC986979		545
REC51212-93J10			REC908383	908383	445	REC986979		545
REC51212-93J10			REC908855	908855	443	REC986979		545
REC51212-93J10			REC90890-06820	90890-06820	495	REC986979		545
REC51212-93J10			REC90890-06820	91-83164M	495	REC986979		546
REC51212-93J10			REC909140	909140	445	REC986979		546
REC51212-93J10			REC909386	909386	517-519	REC986979		546
REC51212-93J10			REC91-00001		494	REC986979		546
REC51212-93J10			REC91-00002		494	REC986979		546
REC51212-93J10			REC91-31229	91-31229	494	REC986979		546
REC51212-93J10			REC91-34569A1	91-34569A1	494	REC986979		546
REC51212-93J10			REC91-36569T	91-36569T	494	REC986979		546
REC51212-93J10			REC91-37241		494	REC986979		546
REC51212-93J10			REC91-61067A04	91-61067A04	495	REC986979		546
REC51212-93J10			REC91-61069T	91-61069T	495	REC986979		546
REC51212-93J10			REC91-859046Q3	91-859046Q3	495	REC986979		546
REC51212-93J10			REC91-859046Q4	91-821887T1	495	REC986979		546
REC51212-93J10			REC91-895343T02	91-895343T02	495	REC986979		546
REC51212-93J10			REC91-895343T02	91-895343T01	495	REC986979		546
REC51212-93J10			REC911019	911019	443	REC986979		546
REC51212-93J10			REC9111685	9111685	443	REC986979		546
REC51212-93J10			REC911961	911961	519-520	REC986979		546
REC51212-93J10			REC911962	911962	525-528	REC986979		546
REC51212-93J10			REC91490-30025	5030087	497-503-508-548	REC986979		546
REC51212-93J10			REC91490-40030	5030087	501-505-506-507	REC986979		546
REC51212-93J10			REC915954	915954	520-525	REC986979		546

REF	R.O. / OEM		REF	R.O. / OEM	
SOL2531-143-17	391290	546	SOLRBX-100		547
SOL2531-145-15	391535	546	SOLRBX-101		547
SOL2531-145-15	174926	546	SOLRBX-106		547
SOL2532-140-19		546	SOLRBX-110		547
SOL2532-140-19	390821	546	SOLRBX-111		547
SOL2532-140-21		546	SOLRBX-125		547
SOL2532-140-21	390822	546	SOLRBX-126		547
SOL2532-140-23		546	STA93900		431
SOL2532-140-23	390823	546	STA93922		431
SOL2532-143-17		546	STA93932		431
SOL2532-143-17	431930	546	STA94100		431
SOL2532-145-15		546			
SOL2532-145-15	174927	546			
SOL3413-138-15	5033322	546	TEN00900	976669	459
SOL3413-138-17	5033323	546	TEN00901	982277	459
SOL3413-138-19	5033324	546	TEN00902	385818	459
SOL3413-138-21	5033325	546	TEN00902	982438	459
SOL3451-139-17	5033323	546	TEN00903	3853818	459
SOL3451-139-17	5033327	546	TEN00903	984513	459
SOL3451-139-19	5033324	546	TEN00904	983952	459
SOL3451-139-19	5033328	546	TEN00905	338742	461
SOL3451-139-21	5033325	546	TEN00906	983494	459
SOL3451-139-21	5033329	546	TEN00907	393023	460
SOL3451-139-23	5033326	546	TEN00907	436745	460
SOL3451-139-23	5033330	546	TEN00907AL	393023	460
SOL3452-139-17	5033955	546	TEN00907AL	436745	460
SOL3452-139-19	5033956	546	TEN00907BIS	397768	460
SOL3452-139-21	5033957	546	TEN00908	392123	460
SOL4011-079-07S	5034345	497	TEN00909	392462	461
SOL4111-093-07A	5033200	545	TEN00910	398331	461
SOL4111-093-08A	5005383	545	TEN00910	433458	461
SOL4111-093-09A	5005384	545	TEN00911	395780	460
SOL4111-093-10A	5005385	545	TEN00911AL	395780	460
SOL4111-093-11A	5033203	545	TEN00912	173029	462
SOL4211-100-14	5032110	545	TEN00912	123009	462
SOL4211-101-13	5032109	545	TEN00912	327606	462
SOL4211-103-12	5032108	545	TEN00913	432397	460
SOL4211-105-11	5032107	545	TEN00913	334451	460
SOL4311-116-12	5031624	545	TEN00914	434029	461
SOL4311-116-13	5031619	545	TEN00914/1	434029	461
SOL4311-116-14	5031620	545	TEN00915	398873	461
SOL4311-118-11	5031623	545	TEN00916	984547	459
SOL4311-120-10	5031622	545	TEN00917	431708	460
SOL4511-150-15		546	TEN00918	5007089	460
SOL4511-153-19		546	TEN00918	433580	460
SOL4511-153-21		546	TEN00918AL	5007089	460
SOL4511-155-17		546	TEN00918AL	433580	460
SOL4512-153-19		546	TEN00919	986158	459
SOL4512-153-21		546	TEN00919	3853930	459
SOL4512-155-17		546	TEN00920	987067	459
SOL4512-158-15		546	TEN00920	3854061	459
SOL4571-148-23		546	TEN00920	987067	459
SOL4571-149-22		546	TEN00921	338635	460
SOL4571-151-20		546	TEN00922	3854130	459
SOL4571-154-18		546	TEN00923		460
SOL4572-148-23		546	TEN00925	5031705	460
SOL4572-149-22		546	TEN00925AL	5031705	460
SOL4572-151-20		546	TEN00926	5034616	461
SOL4572-154-18		546	TEN00926	5030907	461
SOL9311-111-13		547	TEN00926AL	5034616	461
SOL9311-114-12		547	TEN00926AL	5030907	461
SOL9411-132-19		547	TEN00927	5032929	462
SOL9411-132-21		547	TEN00928	397768	460
SOL9411-133-17		547	TEN00928AL	397768	460
SOL9411-135-15		547	TEN00929	389999	459
SOL9411-138-13		547	TEN00930	5030265	459
SOL9411-140-09		547	TEN00930	5035786	459
SOL9411-140-11		547	TEN00931	5031536	461
SOL9431-130-19		547	TEN00932	5030267	461
SOL9431-130-21		547	TEN00933	5031705	461
SOL9431-133-17		547	TEN00934	5033185	461
SOL9431-135-15		547	TEN00935	5031538	461
SOL9431-138-13		547	TEN00936	5033167	461
SOL9432-130-19		547	TEN00937	5032930	461
SOL9432-133-17		547	TEN00937AL	5032930	461
SOL9432-135-15		547	TEN01205		462
SOL9432-138-13		547	TEN01213		462
SOL9511-143-21		547	TENKITOMC-50-75		462
SOL9511-145-19		547	TENKITOMC-V4-V6		462
SOL9511-148-17		547			
SOL9511-150-15		547			
SOL9511-153-13		547			
SOL9511-155-11		547			
SOL9511-160-13		547			
SOL9531-140-19		547			
SOL9531-140-21		547			
SOL9531-140-23		547			
SOL9531-143-17		547			
SOL9531-145-15		547			
SOL9532-140-19		547			
SOL9532-140-21		547			
SOL9532-140-23		547			
SOL9532-143-17		547			
SOL9532-145-15		547			
SOL9571-148-23		547			
SOL9571-150-21		547			
SOL9571-153-19		547			
SOL9571-155-17		547			
SOL9571-158-15		547			
SOL9572-148-23		547			
SOL9572-150-21		547			
SOL9572-153-19		547			
SOL9572-155-17		547			
SOL9572-158-15		547			

RO / OEM --> REF

RO/OEM	REF	RO/OEM	REF	RO/OEM	REF
0323327	REC0323327	398	302804	REC18-32665	548
34559	REC340559	467	302873	REC302325	531
43577	REC439078	396	303059	REC339543	445-517
98410	PH375-0029	409	303067	REC3852045	445
115742	REC115742	416	303191	REC25-62702	445
123009	CM123009	455	303345	REC303345	443
123009	TEN00912	462	303347	REC303347	445-513
126776	REC126776	438	303360	REC25-35027	445
126870	REC126870	525-529	303615	REC303615	393
127084	REC127084	519-520	304174	REC304174	445
127084	REC127084	549	304454	REC304454	510-513
160084	REC160084	517-525-528	304784	REC304784	445
172588	REC173944	425	305123	REC305123	445-525-531
172869	PH375-0033	410	305176	REC305176	483
172869	REC581528	410	305185	REC305185	390
173029	CM123009	510	305242	REC305242	445-509
173029	CM123009A	455	305270	REC3852928	445
173029	TEN00912	462	305282	REC305282	515-517
173105	PREMC30508	430	305586	REC305586	437
173106	PREMC30506	430	305739	REC332583	445
173107	PREMC30507	430	305762	REC305762	517
173109	PREMC30509	430	305981	REC21-20553	531
173110	PREMC30510	430	305987	REC767970	443
173111	PREMC30511	430	306376	REC306376	515
173112	PREMC30512	430	306394	REC3852056	509-525-529
173113	PREMC30513	430	306643	REC306643	433-452-510-523-527-529-531
173114	PREMC30514	430	307069	REC307069	476
173115	PREMC30515	430	307133	REC307133	485
173116	PREMC30516	430	307161	REC307161	520-528
173117	PREMC30517	430	307551	REC10-79953Q04	509-510-511-513-517-519-531
173118	PREMC30518	430	307552	REC12-191833	509-510
173119	PREMC30519	430	308239	REC308239	390
173120	PREMC30520	430	308328	REC308328	437
173121	PREMC30521	430	308627	REC308627	510
173122	PREMC30522	430	308876	REC308876	445
173124	PREMC30524	430	308928	REC308928	441-517-519-531
173944	REC173944	425	309004	REC309004	511
174508	GS31084	384	309243	REC309243	515
174817	SOL2111-093-11	545	309731	REC309731	445
174926	SOL2531-145-15	546	309955	REC309955	531-548
174927	SOL2532-145-15	546	309989	REC309989	443
174938	SOL2111-093-08	545	310058	REC27-62386001	433-435-436
174950	SOL2111-093-10	545	310327	REC25-30224	515
175190	SOL2211-105-11	545	310414	REC310414	445
175191	SOL2211-101-13	545	310433	REC310433	470
175266	REC175266	551	310584	REC310584	445-515
175267	REC175267	551	310585	REC25-30613	445-452-531
175268	REC175268	551	310599	REC310599	443
175269	REC175269	551	310649	REC310649	443
175316	REC0175316	415	310967	REC25-30613	445
175386	REC0763808	417	311145	REC311145	437
175974	REC5005801	409	311338	REC25-62705	445-513
176214	SOL2411-133-17	545	311538	REC311538	523-527-529
176214	SOL2413-128-17	545	311598	REC12-191833	519
176214	SOL2431-133-17	545	311598	REC3855081	513-515-517-520-525-528
176215	SOL2411-130-19	545	312456	REC35-49088A2	390
176215	SOL2413-125-19	545	312932	REC93-06511	408
176215	SOL2431-130-19	545	313065	REC802243	482
176216	SOL2411-130-21	545	313175	REC313175	445
176216	SOL2413-125-21	545	313282	REC313282	443
176216	SOL2431-130-21	545	313284	REC313284	443
176333	REC0176333	430	313339	REC313339	515-517-519
176335	REC0176335	430	313340	REC313340	445
176340	REC0176340	430	313353	REC313353	443
176342	REC0176342	430	313413	REC878846	476
176408	REC0176408	429	313416	REC3852120	436
176421	SOL2311-123-15	545	313445	REC313445	519
176422	SOL2311-120-17	545	313446	REC967344	445-519-520
176424	SOL2211-103-12	545	313447	REC313447	519
176425	SOL2211-100-14	545	313448	REC313448	519-520-525-529-531
202893	REC25-48171	445	313715	REC313715	519-525-528-531
203130	REC203130	475	313715	REC313763	520
203697	REC93-08663	408	313754	REC313754	445-519
203698	REC300-01744	409	313763	REC313763	480
203725	REC93-08664	408	313782	REC313782	475
277432	PH130-0038	405	313893	REC338518	445
278232	PH130-0038	405	313992	REC764337	443
289019	SOL2531-140-23	546	314008	REC314008	452-519-523-527-529-531
300611	REC300611	441-510	314082	REC314082	517-519
300771	REC300771	441	314115	REC314115	488
301877	REC301877	445-510-513	314167	REC314167	443
301967	REC301967	432-445-511	314281	REC314281	443-525-529
302035	REC302035	523-527-529	314491	REC314491	445
302325	REC302325	452-510	314502	REC314502	515-517-519-520-548
302325	REC302325	515-517-519-523-527-529	314503	REC314503	515-517-519-520-548
302337	REC25-33145	445	314728	REC314728	445-523-527-529-531
302497	REC302497	509-510-511-513	314730	REC11-35921	523-527-529-531
302537	REC302537	445	314731	REC314731	520-525-531
302540	REC125017	445			
302564	REC302564	443			
302588	REC302588	445-517			
314745	REC314745	523-527-529-531			
315232	REC315232	398			
315538	REC315538	484			
315578	REC315578	486			
315788	REC315788	517			
315810	REC315810	515-517-519-520-549			
315837	REC315837	517			
315838	REC315838	517			
315868	REC315868	482			
315869	REC315869	482			
316506	REC316506	510-513-515-531			
316563	REC316563	531			
317178	REC332583	445			
317230	REC317230	519			
317232	REC317232	519			
317245	REC317245	432-433-435-437			
317624	REC317624	515-523-527-529			
317914	REC317914	483			
317955	REC317955	483			
318303	REC318303	519-533			
318335	REC318335	484			
318358	REC318358	475			
318372	REC318372	445-515-517-519-523-527-529-531			
318373	REC318373	432-480			
318395	REC318395	432-435-437			
318544	REC22-67892A05	509-515-519-520-525-528			
318609	REC766871	484			
318717	REC318717	445			
318917	REC318917	437			
318924	REC318924	486			
318925	REC318925	482			
318932	REC318932	485			
318971	REC318971	510-548			
318972	REC318972	443-510			
318995	REC318995	510			
319085	REC319085	510			
319174	REC319174	486			
319276	REC319276	519			
319332	REC319332	485			
319348	REC319348	480			
319586	REC319586	519			
319633	REC319633	475			
319661	REC0319661	485			
319662	REC0319662	445			
319665	REC319665	484			
319710	REC319710	480			
319890	REC319890	549			
319891	REC319891	513-548-551			
319895	REC319895	517			
320041	REC320041	513-517-519			
320140	REC320140	531			
320145	REC320145	519-520			
320166	REC320166	517			
320167	REC320167	517			
320168	REC320168	517			
320303	REC925093	517			
320305	REC320305	515-517-549			
320310	REC320310	515-517			
320311	REC320311	515-517			
320499	REC352960	470			
320569	REC5008966	531			
320570	REC320570	525-529-531-549			
320630	REC337774	531			
320635	REC320635	531			
320679	REC320679	488			
320745	REC766779	476			
320785	REC320785	513-548-551			
320862	REC26-76868	443-525-531			
320880	REC320880	433-435-438			
320936	REC320936	483-523-527-529			
320943	REC320943	452-523-527-529-531			
320961	REC320961	483-523-527			
320981	REC320981	517			
321008	REC321008	452-523-527-529			
321027	REC321027	433-435-437			
321120	REC321120	433			
321175	REC331188	531			
321182	REC321182	483			
321184	REC321184	433-435-437			
321188	REC338485	531			
321220	REC321220	435-437			
321221	REC321221	433-435-438			
321222	REC321222	433-435-438			
321453	REC26-69188	443			
321453	REC26-69188	513-531			
321459	REC321459	443-511			
321466	REC321466	443			
321466	REC324786	517			
321467	REC321467	443-515-517			
321479	REC0321479	486			

RO/OEM	REF	RO/OEM	REF	RO/OEM	REF
321480	REC321480	443-444-510	329380	REC326649	445
321481	REC321481	510	329381	REC3852045	445
321497	REC321497	489	329390	REC329390	511
321692	REC321692	432-435-436	329391	REC765642	511
321692	REC435957	438	329419	REC329419	475
321738	REC321738	510-513	329718	REC329718	487
321786	REC321786	443	329826	REC329826	483
321787	REC321787	443-511	329828	REC329828	480
321788	REC321788	443	329830	REC329830	432-437
321831	REC321831	443	329836	REC329836	476
321886	REC321886	438	329920	REC329920	484
321895	REC321895	443	329922	REC329922	443
321921	REC321921	511	329923	REC329923	443
321928	REC321928	443-513	329975	REC329975	481
321932	REC321932	432-435-436	330137	REC330137	443-519-520
322494	REC322494	509	330265	REC330265	515-520-525-528
322938	REC322938	525-529	330273	REC330273	438
322941	REC322941	520-525	330327	REC330327	443-511
323214	REC323214	481	330525	REC300-01633	409
323338	REC323338	488	330527	REC93-08665	408
323361	REC323361	523-527-529	330560	REC330560	445-511
323362	REC323362	523-527-529	330619	REC344470	441-511
323469	REC323469	483	330621	REC0330621	480
323582	REC323582	436	330698	REC330698	489
323653	REC93-06522	408	330818	REC330818	475
323664	REC323664	520-533	330854	REC31-02747	470
323889	REC323889	519	330909	REC330909	489
323890	REC323890	519	331016	REC331016	483
323942	REC323942	510-549-551	331103	REC331103	443
323943	REC323943	513-549-551	331107	REC331107	441-452-523-529
324097	REC324097	447-510	331107	REC777129	527
324334	REC324334	510	331188	REC331188	435-515-527-529
324369	REC324369	519-520-525-529-531	331211	REC331211	476
324430	REC331980	517	331353	REC331353	452-523-527-529-531
324449	REC324449	511	331532	REC331532	487
324639	REC324639	443-509	331880	REC323664	520
324640	REC324640	509	331880	REC331880	519-525-528
324641	REC324641	447-509	331901	REC331901	441-517-519
324670	REC324670	523-527	331916	REC331916	482
324717	REC324717	480	331917	REC331917	482
324766	REC324766	519-520	331970	REC93-08666	408
324852	REC324852	515-528	331980	REC331980	509-517
324937	REC324937	483-517-519	331999	REC331999	520-525-528
324960	REC302325	511	332010	REC802307	475
324981	REC324981	515-519	332108	REC27-62386001	436
325040	REC325040	509	332108	REC332108	437
325092	REC325092	485	332130	REC332130	436
325211	REC325211	482	332205	REC342786	443-517
325260	REC325260	486	332261	REC332261	443-513
325273	REC802288	475	332266	REC332266	486
325397	REC325397	447	332319	REC332319	485
325537	REC325537	513	332369	REC332369	432-435-437
325647	REC335361	476	332491	REC332491	515-533
325721	REC325721	480	332514	REC332514	515
326260	REC0326260	486	332583	REC26-01674	513
326264	REC0326264	482	332583	REC332583	445
326649	REC326649	445	332584	REC332583	445-452
326741	REC326741	445	332584	REC332584	515-517-528
326849	REC326849	529	332584	REC3852045	519
326877	REC0326877	408	332816	REC332816	476
326926	REC326926	485	332817	REC332817	476
327031	REC327031	443	332818	REC332818	476
327345	REC327345	519-520	332819	REC332819	475
327606	CM327606	455	332942	REC353076	443
327606	CM327606A	455	332944	REC332944	435-436
327606	TEN00912	462	333008	REC333008	488
327656	REC327656	523-527-529-531	333554	REC340116	476
327669	REC327669	525-529	333572	REC333572	445-511
327674	REC327674	484	333670	REC333670	476
327707	REC327707	485	333725	REC333725	515
327795	REC335359	475	333758	REC333758	515
328096	REC328096	517-519-525	333771	REC333771	515
328522	REC328522	510-551	333879	REC333879	481
328590	REC328590	481	333957	REC333957	520-525-529
328603	REC328603	467	334163	REC334163	517-519-520-525-529
328618	REC328618	480	334451	CM334451	455
328622	REC328622	486	334451	CM334451A	455
328623	REC328623	475	334451	TEN00913	460
328694	REC328694	515	334590	REC334590	510-549
328702	REC328702	523-527-529	334665	REC0334665	466
328725	REC328725	509	334726	REC333670	476
328743	REC328743	520	334897	REC334897	441-515-519
328744	REC328744	509	334950	REC321481	443
328751	REC328751	447-511-513	334950	REC334950	525-529
328753	REC328753	513	335334	REC335334	394
328754	REC328754	513	335359	REC335359	475
328755	REC328755	513	335360	REC766779	476
328825	REC328825	525	335361	REC335361	476
329076	REC329076	437	335403	REC335403	485
329103	REC329103	475-479	335404	REC335404	485
329319	REC0329319	436	335419	REC335419	481
335523	REC335523	445			
335633	REC335633	486			
335679	REC335679	537			
335818	REC335818	485			
335819	REC335819	485			
335905	REC93-08667	408			
335981	REC335981	436			
336178	REC336178	432-438			
336185	REC336185	432-438			
336226	REC336226	486			
336227	REC336227	486			
336308	REC336308	483			
336388	REC336388	486			
336389	REC336289	486			
336493	REC336493	509			
336530	REC336530	515-519			
336565	REC435123	525			
336947	REC336947	437			
336982	REC336982	515			
337061	REC337061	520-525-528			
337067	REC337067	437			
337068	REC337068	437			
337533	REC337533	438			
337774	REC337774	525-529-533			
337778	REC337778	520-525			
338222	REC338222	475			
338484	REC338484	452-523-527-529-531			
338485	REC338485	452-527-529			
338486	REC338486	447-452-527-529-531			
338504	REC338504	523-527-529			
338518	REC338518	445-513			
338522	REC338522	445			
338534	REC93-06522	408			
338601	REC354580	523-529			
338632	REC338632	435-436			
338635	CM338635	455			
338635	TEN00921	460			
338636	REC338636	523-529			
338742	CM338742	457			
338742	TEN00905	461			
338876	REC338876	393			
338879	REC338879	393			
338882	REC338882	488			
338893	REC338893	452-523-527-529-531			
339044	REC339044	436			
339620	REC339620	443			
340115	REC340115	475			
340116	REC340116	476			
340559	REC340559	467			
340619	REC340619	447-515-519			
340811	REC340811	513			
340975	REC0340975	455			
340976	REC0340976	455			
341038	REC341038	515-519			
341219	REC341219	520-528			
341220	REC341220	523-527-529			
341280	REC341280	443-523-527-529			
341732	REC341732	515-517-519			
342291	REC350357	484			
342513	REC342513	432-481			
342786	REC333771	517			
342786	REC342786	443-515-519			
343105	REC343105	435-438			
343141	REC343141	432-436			
343853	REC343853	481			
343863	REC343863	482			
344386	REC344386	481			
344470	REC344470	513-517-519			
344771	REC344771	436			
345257	REC345257	476			
345905	REC345905	527-537			
346006	REC346006	537			
347371	REC356900	529-537			
349193	REC349193	529			
350038	REC350038	529			
350271	REC350271	520-525-529			
351018	REC351018	480			
351019	REC351019	483			
352165	REC324670	529			
354016	REC40145	389			
375638	REC775518	439			
377139	REC377139	470			
377230	REC777213	439			
377230	REC777213	517			
378252	REC378252	469			
378444	REC378444	410			
378674	PH130-0038	405			
378895	REC396521	398			
379091	PH130-0038	405			
379312	REC387262	398			

RO/OEM	REF		RO/OEM	REF		RO/OEM	REF	
379312	REC396522	398	390821	SOL2532-140-19	546	396377	REC396377	473-474
379504	REC379504	519-520	390822	SOL2532-140-21	546	396379	REC396379	473-474
379818	PH130-0038	405	390823	SOL2532-140-23	546	396504	REC396504	473-474
380095	PH375-0012	410	390900	REC390900	469	396520	REC396520	398
380139	PH130-0038	405	391170	REC391170	473-474	396521	REC396521	398
380238	PH130-0038	405	391198	SOL2411-135-15	545	396522	REC396522	398
381864	PH130-0038	405	391198	SOL2413-130-15	545	396701	REC396701	397
382049	REC439071	396	391198	SOL2431-135-15	545	396725	REC396725	439
382343	REC382343	515-519	391200	SOL2511-148-17	546	396725	REC396725	519
382363	REC382363	397	391200	SOL2513-145-17	546	396750	REC396750	478
382407	REC382407	515-519-520-525-529	391200	SOL2531-143-17	546	396809	REC777214	439-517
382408	REC382408	519-520-525-531	391201	SOL2511-145-19	546	396987	REC396987	433
382547	REC765431	439-519	391201	SOL2513-143-19	546	397004	REC0397004	430
382761	SOL2411-140-11	545	391201	SOL2531-140-19	546	397023	PH130-0008	408
383052	REC439071	396	391202	SOL2511-143-21	546	397537	REC397537	515
383067	REC439071	396	391202	SOL2513-140-21	546	397538	REC397538	515
383622	PH375-0012	410	391202	SOL2531-140-21	546	397768	CM397768	456
383691	PH130-0043	406	391203	SOL2511-142-23	546	397768	CM397768A	456
384087	REC384087	446-517	391203	SOL2531-140-23	546	397768	TEN00907BIS	460
384163	PH130-0045	406	391264	PH200-T014	423	397768	TEN00928	460
384195	REC384195	523	391290	SOL2531-143-17	546	397768	TEN00928AL	460
384461	REC0385008	417	391300	REC439085	478	397839	REC1399-07350	392
384777	PH130-0043	406	391305	REC439072	396	398042	REC398042	525-529-551
384799	PH130-0008	408	391416	REC391416	473-474	398047	REC39390	477
385008	REC0385008	417	391511	PH130-0008	408	398051	REC398051	467
385043	REC385043	519-520	391535	SOL2511-150-15	546	398126	SOL2111-093-07	545
385068	REC385068	519	391535	SOL2513-148-15	546	398172	REC398172	478
385072	REC385072	439	391535	SOL2531-145-15	546	398243	REC0398243	430
385087	REC385087	519	391554	PH130-0044	407	398319	REC40135	389
385175	REC31-32575T1	517	391668	SOL2411-138-13	545	398327	REC40135	389
385389	PH375-0027	410	391668	SOL2413-133-13	545	398331	CM433458	455
385401	PH130-0038	405	391735	PH130-0043	406	398331	CM433458A	455
385416	REC439084	477	391741	REC391741	450	398331	TEN00910	461
385503	REC31-02803	470	391988	REC391988	479	398452	REC439072	396
385528	REC777212	531	392061	REC396701	397	398453	REC439072	396
385529	PH130-0044	407	392123	CM392123	456	398514	REC398514	393
385818	TEN00902	459	392123	CM392123A	456	398526	REC439076	397
386084	REC386084	439-510	392123	TEN00908	460	398529	REC398529	469
386279	REC386918	473	392133	PH130-0038	405	398532	REC439071	396
386280	REC386280	473	392462	CM392462	455-517	398693	REC398693	479
386430	PH130-0014	405	392462	CM392462A	455	398729	REC396701	397
386465	PH130-0044	407	392462	TEN00909	461	398873	CM398873	455-515
386545	MP39100		392550	REC439076	397	398873	CM398873A	455-515
386573	REC386573	488	392567	REC802133	477	398873	TEN00915	461
386591	PH130-0038	405	392615	REC802133	477	398874	REC398874	515
386597	PH130-0038	405	393023	CM393023	455	398901	REC398901	515
386657	PH130-0043	406	393023	CM393023A	455	431708	CM431708	455-519-520-525-529
386764	REC386764	515-517	393023	TEN00907	460	431708	CM431708A	455
386765	REC386765	515-517	393023	TEN00907AL	460	431708	TEN00917	460
386766	REC386766		393088	REC393088	393	431870	REC431870	474
386866	REC386866	551	393103	REC393103	394	431930	SOL2532-143-17	546
386909	SOL2311-125-13	545	393259	PH200-T014	423	432264	REC432264	515
387041	REC5007190	469	393301	MP39760	409	432276	REC432276	515
387094	PH130-0039	407	393433	REC439083	477	432397	CM334451	455
387139	REC764102	469	393561	REC393561	483	432397	CM334451A	455
387247	REC387247	525-531	393570	PH130-0012	407	432397	TEN00913	460
387262	REC387262	398	393630	REC393630	450-513	432570	REC432570	478
387277	PH200-T020	423	393632	REC393632	446-513	432571	REC436891	479
387361	REC763735	439	393896	REC31-02799	469	432925	PH130-0018	407
387656	REC387656	523-527-529-531	393988	PH200-T014	423	432941	REC432941	439-515
387684	PH130-0045	406	394176	PH200-T014	423	432955	REC432955	451
387787	REC387787	469	394408	REC394408	438	432962	REC432962	394
387817	REC387817	527-529-531	394411	REC394411	433	433190	REC433190	389
388344	REC388344	469	394462	REC394462	466	433226	PH200-T022	424
389039	REC389039	525-529	394488	REC5004705	466	433325	REC0433325	430
389042	REC389042	525-529	394546	REC802113	477	433458	CM433458	455
389133	REC389133	451	394711	REC394711	449	433458	CM433458A	455
389275	PH130-0045	406	394885	REC434381	478	433458	TEN00910	461
389380	PH130-0044	407	394930	REC394930	473-474	433550	REC433550	541
389398	PH375-0012	410	395073	REC395073	452	433570	REC433570	517
389455	REC389455	525	395204	REC0395204	412	433580	CM433580	
389493	PH375-0012	410	395207	PH130-0039	407	433580	CM433580A	
389510	SOL2431-130-19	545	395209	REC395209	525-538	433580	TEN00918	460
389512	SOL2431-130-21	545	395270	REC395270	450	433580	TEN00918AL	460
389556	REC439085	478	395289	REC395289	439-511-513	433935	REC0767407	439
389577	REC389577	445-509	395391	REC0395204	412	433941	REC802133	477
389589	REC777129	439	395401	REC395401	469	434029	CM434029	456
389642	REC777212	439	395419	PH375-0012	410	434029	TEN00914	461
389923	SOL2531-140-21	546	395460	REC93-08668	408	434029	TEN00914/1	461
389924	SOL2531-140-19	546	395627	REC395627	468	434137	REC434137	433
389948	SOL2431-133-17	545	395780	TEN00911	460	434153	REC414153	551
389949	SOL2431-135-15	545	395780	TEN00911AL	460	434381	REC434381	478
389954	PH130-0044	407	395861	REC395861	466	434391	REC434391	519
389999	CM389999	455	395911	REC0395911	430	434424	REC434424	439
389999	CM389999A	455	396041	REC878763	469	434467	REC434467	525
389999	TEN00929	459	396077	REC0586695	416	434495	PH200-T005	424
390078	REC439084	477	396141	REC0586697	416	434496	PH200-T005	424
390286	REC390286	439	396235	PH130-0008	408	434588	REC434588	515
390509	REC390509	473	396350	REC396350	541	434839	REC434839	391
390510	REC390510	473	396351	REC396351	513-541	434841	REC6F5-12411-03	433-435
390613	REC390613	445	396352	REC396352	542	434844	REC434844	468
390641	REC31-02806	470	396355	REC396355	541	434888	REC439076	397

RO/OEM	REF	RO/OEM	REF	RO/OEM	REF			
435027	REC435027	523	581295	REC3857533	410	583410	REC0763769	419
435123	REC435123	525-532	581397	REC0764708	417	583415	REC0763765	419
435230	REC0435230	430	581407	REC0502880	400	583471	REC0584035	414
435274	REC435274	515	581419	REC0581419	426-427	583476	REC0586667	414
435279	REC0435279	492	581528	PH375-0033	410	583482	PH130-0016	406
435390	REC435390	446-510	581528	REC581528	410	583485	REC0584333	418
435442	REC438996	396	581651	REC0763770	419	583489	REC0584041	414
435443	REC439076	397	581670	REC5000611	418	583512	REC0763791	413
435491	REC435491	433-435	581726	REC581726	417	583529	REC0585195	413
435519	REC435519	519	581731	REC0582056	417	583533	REC763775	418
435532	PH200-T021	424	581778	PH350-0002	414	583536	REC0763767	419
435548	REC435548	425	581786	REC0502881	400	583561	REC0584288	419
435676	REC439078	396	581805	REC0582125	416	583604	REC0586697	416
435678	REC439078	396	581957	REC0583724	418	583644	REC0583724	418
435752	REC439078	396	581987	REC0583672	419	583663	REC300-26084	417
435821	REC5001593	452-523	582016	REC0583672	419	583667	REC300-26084	417
435957	REC435957	432	582047	PH200-T020	423	583668	REC0583668	419
435959	REC435990	529	582048	PH200-T020	423	583670	REC0583670	418
435959	REC5007968	446	582056	REC0582056	417	583671	REC0583672	419
435959	REC5007968	523-527-531	582057	REC0582057	417	583672	REC0583672	419
435990	REC435990	446-523-527	582091	REC0502888	400	583689	REC0583689	413
436137	REC389576	509	582115	REC0582115	416	583710	REC0763764	419
436195	REC878904	432-433	582125	REC0582125	416	583724	REC0583724	418
436254	REC436254	474	582138	REC0582642	416	583737	REC584561	400
436353	REC436353	474	582155	PH200-T020	423	583740	REC0583740	400
436358	REC436358	477	582160	REC0502890	400	583748	REC0583748	416
436367	REC0436367	415	582261	REC0586695	416	583773	REC0584028	415
436745	REC436745AL	517-519-520-525-529	582262	REC0582262	415	583777	REC584030	415
436745	TEN00907	460	582281	REC0586697	416	583865	REC0583865	414
436745	TEN00907AL	460	582285	REC0586697	416	583896	REC300-26085	417
436888	REC436888	538	582366	REC584561	400	584027	REC0584028	415
436891	REC436891	479	582399	PH350-0001	414	584028	REC0584028	415
436972	REC436972	474	582400	REC0582642	416	584029	REC584030	415
437088	REC31-17514A2	469	582453	REC0582452	416	584030	REC584030	415
437090	REC437090	433-435	582454	REC0582125	416	584034	REC0584035	414
437155	REC437155	479	582472	REC3857533	410	584035	REC0584035	414
437288	REC437288	513	582473	REC3857533	410	584036	REC0586667	414
437330	REC437330	523-527-529	582474	REC0582901	416	584037	REC0586667	414
437725	REC437725	479	582497	REC0583672	419	584040	REC0584041	414
437801	PH200-T021	424	582502	REC0586697	416	584041	REC0584041	414
437909	REC437907	450	582504	REC0586695	416	584107	PH200-T020	423
438048	REC5007022	493	582506	REC0583724	418	584109	REC0763759	419
438529	PH200-T005	424	582508	REC0582508	400	584122	REC0436367	415
438531	PH200-T005	424	582514	REC0763776	418	584128	PH375-0029	409
438543	REC438543	446-519	582556	REC0582642	416	584204	REC0585195	413
438544	REC438544	515	582574	REC0583668	419	584205	REC0763791	413
438545	REC438545	515	582642	REC0582642	416	584265	REC0586343	417
438555	REC1399-07353	392	582684	REC0582125	416	584287	REC0583415	419
438556	REC1399-07352	393	582705	REC0763793	415	584287	REC0763765	419
438559	REC438559	393	582708	PH375-0012	410	584288	REC0584288	419
438562	REC1399-07351	392	582714	REC0586695	416	584292	REC0763764	419
438579	REC438579	451	582730	REC0583724	418	584329	REC300-26085	417
438592	REC438592	451	582757	REC0586697	416	584331	REC300-26085	417
438602	REC438602	450	582800	REC0586695	416	584333	REC0584333	418
438616	REC438616	394	582847	REC0583670	418	584416	REC3857533	410
438786	PH200-T004	425	582864	REC0582901	416	584477	REC0584477	400
438878	PH130-0032	407	582867	REC0583672	419	584488	REC300-26084	417
438904	REC39390	477	582880	REC0586697	416	584489	REC300-26085	417
438996	REC438996	396	582888	REC0502888	400	584504	REC5000611	418
439071	REC439071	396	582889	REC0586695	416	584508	REC0586695	416
439072	REC439072	396	582901	REC0582901	416	584528	REC0586695	416
439074	REC439075	397	582904	REC0395204	412	584560	REC0763763	419
439075	REC439075	397	583023	REC0583672	419	584561	REC584561	400
439076	REC439076	397	583041	REC0582262	415	584580	REC584580	409
439077	REC439077	452	583045	REC0763776	418	584586	REC763775	418
439078	REC439078	396	583050	REC0583668	419	584608	PH130-0013	405
439083	REC439083	477	583103	REC0582262	415	584632	REC0502890	400
439085	REC439085	478	583104	REC0583672	419	584636	REC0586661	414
439138	REC439138	515-538	583114	REC0583114	416	584637	REC0586661	414
439185	REC439185	519-538	583117	REC0583670	418	584641	REC0586271	413
439347	REC4428	393	583119	REC0583724	418	584642	REC0763803	414
439347	REC5004428	393	583122	REC0583320	416	584643	REC0763779	419
439476	REC439476	523-527-529-531	583125	REC0582115	416	584746	REC0586695	416
439542	REC0439542	430	583143	REC0582115	416	584755	REC0763770	419
439559	REC439559	478	583167	REC0586697	416	584767	REC5001344	416
439561	REC300-08010	413	583168	REC0586697	416	584768	REC5001344	416
439937	PH200-T004	425	583169	REC0586697	416	584783	REC0586798	415
439972	REC5007022	493-525	583170	REC0586697	416	584799	PH130-0008	408
439973	REC439973	493-525	583172	REC0586695	416	584804	REC0763773	418
502881	REC0502881	400	583174	REC0586695	416	584808	REC5004532	415
502890	REC0502890	400	583175	REC0586697	416	584818	PH130-0026	406
508180	MP39760	409	583241	REC0586695	416	584840	REC5000611	418
509219	PH350-0003	411	583266	REC0583689	413	584849	REC0763760	418
552906	REC328522	548	583274	REC0583668	419	584890	REC300-03588	412
553126	REC553126	445-515	583289	REC0763776	418	584908	REC5001344	416
554545	REC0554545	445-513	583320	REC0583320	416	584910	REC0584985	415
580148	REC0580148	427	583336	REC0582262	415	584912	REC0584986	414
580256	REC0580256	426-427	583340	REC0763767	419	584914	REC0586343	417
580290	REC0580290	427	583379	REC0763776	418	584954	REC0584954	418
580321	REC0580321	426-427	583380	REC0582452	416	584980	PH130-0027	407
581030	REC0583672	419	583387	REC0583387	417	584981	REC0763759	419
581207	REC0581207	427	583408	PH350-0001	414	584985	REC0584985	415

RO/OEM	REF	RO/OEM	REF	RO/OEM	REF			
584986	REC0584986	414	777699	REC581528	410	5000308	REC5000308	450
584988	REC0584986	414	777700	REC378444	410	5000309	REC5000309	541
584989	REC0584986	414	777702	REC3857533	410	5000400	REC5000400	478
584990	REC0584985	415	777784	PH200-T020	423	5000614	REC5000614	529-538
584991	REC0584986	414	778021	PH375-0030	410	5000615	REC5000615	523-527-538
585001	REC300-03587	412	778025	PH375-0029	409	5000618	REC5000618	538
585051	PH130-0044	407	778162	REC65L-24563-00	389	5000623	REC5000623	529-538
585056	PH130-0016	406	778209	PH375-0027	410	5000624	REC5000624	529-538
585057	PH130-0044	407	778417	REC340559	467	5000626	REC5000626	538
585058	PH130-0043	406	778885	REC16510-87J00	391	5000800	REC4428	393
585059	PH130-0017	406	778886	REC16510-90J00	391	5000800	REC5004428	393
585060	PH130-0012	407	778887	REC16510-82703	391	5001036	REC5001036	433
585061	PH130-0038	405	778888	REC16510-93J00	391	5001593	REC5001593	527-529
585062	PH130-0039	407	778991	PH130-0017	406	5001594	REC5001594	452
585063	PH130-0045	406	778992	PH130-0039	407	5001595	REC5001595	452
585073	REC5000611	418	778993	PH130-0045	406	5004218	REC5004218	532
585074	REC5001344	416	778994	PH130-0012	407	5004257	REC5004257	525
585081	REC0585081	412	778996	PH130-0026	406	5004428	REC4428	393
585087	REC0763770	419	892187	PH375-0029	409	5004428	REC5004428	393
585114	REC0586661	414	908034	REC35-53336	390	5004533	REC5004532	415
585134	MP28870	422	908158	REC908158	519-520-525-529	5004765	REC5004765	525-529-538
585145	REC5004532	415	908194	REC908194	445	5005034	REC5005034	551
585189	REC5004532	415	908383	REC908383	445	5005114	REC18-6865	425
585192	REC0763791	413	908855	REC908855	443	5005254	PH200-T004	425
585195	REC0585195	413	909047	REC326649	445	5005266	REC5007335	389
585196	PH130-0044	407	909140	REC909140	445	5005374	PH200-T005	424
585197	PH130-0043	406	909386	REC909386	517-519	5005383	SOL4111-093-08A	545
585261	REC0175316	415	910139	REC1397-2150	390	5005384	SOL4111-093-09A	545
585262	REC0175316	415	910994	REC5004218	525	5005385	SOL4111-093-10A	545
585274	REC0585274	415	911019	REC911019	443	5005440	REC6F5-12411-03	432-433
585995	REC0586271	413	911685	REC911685	443	5005801	REC5005801	409
586000	REC0583689	413	911961	REC911961	519-520	5005817	PH200-T061	425
586015	REC0765386	414	911962	REC911962	525-528	5005822	PH200-T072	424
586048	REC300-03586	413	913921	REC3852928	515	5005831	PH200-T072	424
586075	REC300-03585	413	914716	REC337774	533	5005838	PH200-T061	425
586098	REC0765386	414	915954	REC915954	520-525	5005875	PH200-T072	424
586147	REC3857533	410	916058	REC3853655	443	5005907	REC5005907	477
586180	PH375-0012	410	976669	CM976669	455	5005931	REC5005931	478
586212	REC0586661	414	976669	CM976669A	455	5006180	REC5006180	428
586217	REC0586667	414	976669	TEN00900	459	5006181	REC5006181	428
586224	REC3857533	410	979774	PH375-0030	410	5006182	REC5006182	429
586257	PH130-0032	407	980756	CM980756	456	5006184	REC5006184	429
586271	REC0586271	413	980756	CM980756A	456	5006186	REC5006186	429
586275	PH130-0013	405	980801	PH375-0027	410	5006241	REC5006241	523-527-529
586276	PH130-0014	405	981195	REC981195	443	5006319	PH200-T061	425
586277	PH130-0026	406	981196	REC981196	443	5006373	REC5006373	541
586278	PH130-0038	405	981268	REC981268	443	5006479	PH200-T072	424
586279	PH130-0016	406	981703	PH375-0027	410	5006655	REC435546	473
586280	PH130-0045	406	981911	REC981911	390	5006657	REC5006657	473
586281	PH130-0043	406	982189	PH375-0027	410	5006658	REC5006658	473
586282	PH130-0044	407	982230	REC982230	390	5006662	REC5006662	473
586283	PH130-0044	407	982277	CM982438	457	5006664	REC5006664	473
586284	PH130-0027	407	982277	TEN00901	459	5006665	REC5006665	473
586285	PH130-0012	407	982438	CM982438	457	5006666	REC5006666	474
586286	PH130-0018	407	982438	TEN00902	459	5006668	REC5006668	473
586287	PH130-0018	407	983019	PH200-T014	423	5006669	REC5006669	473
586288	PH130-0039	407	983446	REC435548	425	5006670	REC5006670	473
586289	PH130-0008	408	983494	CM983494	457	5006687	REC5006687	474
586292	REC0765386	414	983494	CM983494A	457	5006688	REC5006688	474
586343	REC0586343	417	983494	TEN00906	459	5006694	REC5006694	474
586411	PH130-0008	408	983870	REC1397-2150	390	5006701	REC5006701	474
586661	REC0586661	414	983952	CM984547	456	5006702	REC5006702	474
586667	REC0586667	414	983952	CM984547A	456	5006711	REC5006711	474
586730	PH375-0027	410	983952	TEN00904	459	5006713	REC5006713	474
586731	PH130-0008	408	984491	REC984491	390	5006714	REC5006714	474
586767	REC0586767	410	984513	CM984513	457	5006716	REC5006716	474
586768	PH130-0035	405	984513	CM984513A	457	5006751	REC5006751	474
586774	REC586774	410	984513	TEN00903	459	5007089	CM5007089	456
586842	PH375-0027	410	984547	CM984547	456	5007089	CM5007089A	456
586890	PH130-0008	408	984547	CM984547A	456	5007089	TEN00918	460
586897	PH130-0008	408	984547	TEN00916	459	5007089	TEN00918AL	460
586957	PH130-0008	408	985063	PH375-0029	409	5007129	REC5007129	479
587045	PH130-0035	405	985064	PH375-0027	410	5007326	REC5007326	389
678882	REC396521	398	985237	REC435548	425	5007850	REC5007850	477
763760	REC0763760	418	986158	TEN00919	459	5009214	REC586774	410
763763	REC0763763	419	987067	TEN00920	459	5030034	REC09116-06094	462-499-501-505-508
763764	REC0763764	419	987067	TEN00920	459	5030035	PAGB/T5783-M6X16	497
763765	REC0583415	419	3214722	REC321722	488	5030037	PAGB/T5787-M6X20	503
763765	REC0763765	419	3214794	REC321794	488	5030038	PAGB/T5783-M6X16	506
763767	REC0763767	419	3234323	REC0324323	482	5030051	PAGB/T6170-M6	497-499-501-505
763769	REC0763769	419	3343105	REC343105	438	5030051	PAGB/T6184-2000	503
763770	REC0763770	419	3438544	REC438544	445	5030068	PAGB/T848-6	503
763773	REC0763773	418	3852020	REC126870	549	5030068	PAGB/T93-6	499-505
763775	REC763775	418	3852056	REC3852056	548	5030071	REC09168-10022	489-497-499-501-503-505-506-507
763776	REC0763776	418	3852548	REC3852548	443	5030084	REC09202-04002	505-548
763779	REC0763779	419	3852565	REC25-25439	445	5030087	REC91490-30025	497-503-508-548
763785	REC0583668	419	3853818	TEN00903	459	5030087	REC91490-40030	501-505-506-507
765553	REC433190	389	3853930	TEN00919	459	5030094	REC09248-10008	497-499-501-503-505-506-507-540
765591	REC438559	393	3854061	TEN00920	459	5030107	REC09282-10008	489-497
772681	GS31083	384	3854130	TEN00922	459	5030108	REC09282-12008	489
777693	PH130-0039	407	4359073	REC439073	397	5030109	REC09283-10003	489
777699	PH375-0033	410	5000074	REC5000074	525			

RO/OEM	REF		RO/OEM	REF		RO/OEM	REF	
5030110	REC09283-20018	489	5031403	REC15710-87J00	395	5032801	REC56120-94321-OEP	505
5030111	REC09283-20045	489	5031411	REC16510-87J00	391	5032802	REC56130-94413-OEP	447-505
5030137	REC09420-03002	441-497	5031417	REC17461-96312	501-503-505	5032929	CM5032929	457
5030181	REC15170-98110	394	5031418	REC17471-94401	448-503-505	5032929	REC55125-90J01AL	506-507
5030183	REC16910-GB2-005	389	5031419	REC17472-96303	446	5032929	TEN00927	462
5030188	REC17461-98503	497	5031426	REC17616-87J00	463	5032930	CM5032930	456
5030189	REC17471-98601	448	5031426	REC17616-87J00	466	5032930	REC55125-90J01AL	507
5030190	REC17472-98611	449	5031430	REC17685-87D10	463	5032930	REC55321-90J01AL	506
5030215	REC25222-93901	539	5031449	REC23311-95D10	539	5032930	TEN00937	461
5030225	REC37830-89E03	422	5031456	REC25700-88L00	441-505	5032930	TEN00937AL	461
5030265	TEN00930	459	5031468	REC33220-76G02	399	5032945	PAGB/T820-M6X20	499
5030267	CM55320-98600	456	5031474	REC34801-99E04	425	5032950	REC09141-12005	548
5030267	TEN00932	461	5031481	REC37820-92E03	422	5032966	REC09160-20027	533
5030276	REC57311-98600	497-533	5031482	PH200-T062	424	5032967	REC09160-20042	499-533
5030277	REC57510-91J00	532	5031482	REC38100-87J00	424	5032968	REC09160-20043	499-533
5030278	REC57521-91J00	497-532	5031483	PH375-0047	411	5032969	REC09160-20044	499-533
5030282	REC57632-97L00	497-534	5031523	REC51211-87J00	463-465	5032970	REC09160-21009	499-533
5030338	PAGB/T5783-M6X12	507	5031535	REC55122-94400	449	5032985	REC09160-20041	499-533
5030352	REC17400-98652	449	5031536	CM55125-95500	457-505	5032987	REC09168-12017	391
5030356	REC32800-95D01	411	5031536	TEN00931	461	5032996	REC09204-02004	548
5030391	PAGB/T5283-M6X25	497	5031538	CM5031538	457	5033002	REC09263-15019	499-537
5030391	REC09116-06121	462-501-503	5031538	CM55300-95500	499-503-505	5033003	REC09263-20L04	499-533
5030394	PAGB/T5787-M6X30	501	5031538	TEN00935	461	5033009	REC09280-54001	391
5030398	PAGB/T5783-M8X25	507	5031546	REC57610-94402	505	5033010	REC09280-57002	499-540
5030405	PAGB/T818-M4X30	506	5031547	REC57621-94403	533	5033011	REC09282-12010	489
5030406	PAGB/T8.8-2000	507	5031548	REC57630-94300	505-550	5033014	REC09289-12003	499
5030409	PAGB/T818-M6X10	499	5031549	REC57631-95303	505-534	5033015	REC09289-17006	489-499
5030415	PAGB/T889.1-M4	506	5031619	SOL4311-116-13	545	5033027	REC09380-15001	447-499
5030422	REC90171-18M04	505-506-507-508	5031620	SOL4311-116-14	545	5033034	REC09440-05027	499-534
5030429	PAGB/T848-6	497-501	5031622	SOL4311-120-10	545	5033037	REC09440-32008	499-534
5030465	REC09168-12012	391	5031623	SOL4311-118-11	545	5033046	REC11141-93E20	464
5030508	REC93606-12019	507-508	5031624	SOL4311-116-12	545	5033070	REC12761-93E10	481
5030511	PAF25-00000014	507-508	5031705	CM5031705	455	5033086	REC13250-95D01	397
5030623	REC11265-87E10	462-463	5031705	CM55321-87J00	456	5033106	REC17400-93951	450-499
5030660	REC12761-72F00	481	5031705	CM55321-87J00	499	5033107	REC17411-93901	452-499
5030687	REC13650-56B00	399	5031705	REC57631-87J01AL	497	5033109	REC17450-93921	499
5030699	REC15170-99E00	394	5031705	TEN00925	460	5033110	REC17452-93910	449
5030700	REC63P-13907-03	393	5031705	TEN00925AL	460	5033111	REC17453-93901	499-540
5030702	REC15410-87J10	389	5031705	TEN00933	461	5033112	REC17461-93903	499
5030706	REC15440-99E01	391	5031731	REC17400-87E04	451-506	5033113	REC09420-03005	441
5030708	REC15710-99E00	395	5031744	REC17400-96403	451-503-505	5033113	REC17462-93990	441-499
5030723	REC17461-87E12	506	5031758	REC17670-94402	434	5033114	REC17471-93902	448-499
5030724	REC17471-92J00	448	5031822	PAGB/T5787-1986	497	5033167	CM5033167	456
5030725	REC17472-87E10	446-506-507	5031827	REC90179-08M06	501-503	5033167	REC55320-98400AL	499
5030742	REC17670-93962	434	5031863	REC09168-12017	391	5033167	TEN00936	461
5030742	REC17670-93962	434	5031880	REC09209-08016	501-503-534	5033185	CM55321-93900	456
5030780	PH130-0079	409	5031883	REC09263-20046	501-503-537	5033185	REC55321-93900	499
5030783	REC89-825096T01	409	5031884	REC09263-20047	501-503-540	5033185	TEN00934	461
5030795	REC32800-92E20	412	5031885	REC09265-17002	501-503-538	5033188	REC57100-93902	499-538
5030828	REC38100-99E01-OEP	424	5031890	REC925093	503	5033190	REC57311-93910	499-533
5030829	REC38100-99E01-OEP	424	5031893	REC09289-20009	489-501-503	5033191	REC57510-93910	499-532
5030830	REC38100-99E01-OEP	424	5031990	REC17411-94421	445-503-505	5033192	REC57521-93910	499-532
5030852	REC43711-97E11	539	5032030	REC32800-89J00	412	5033193	REC57610-93901	499-538
5030870	REC48630-94900	426	5032058	REC43211-87J10	539	5033196	REC57631-93901	499-534
5030907	TEN00926	461	5032058	REC43211-94401	539	5033197	REC57632-94J00	499-548
5030907	TEN00926AL	461	5032091	REC55125-91L01AL	501	5033198	REC57633-93901	499-548
5030967	REC57630-94500	506	5032098	REC57311-96311	533	5033200	SOL4111-093-07A	545
5030973	REC25700-87E00	442	5032098	REC57311-96320	501-503	5033203	SOL4111-093-11A	545
5030976	REC57630-94500	550	5032099	REC57510-89J00	532	5033221	REC65720-98520	384
5031114	REC15626-99E00	394	5032100	REC57521-89J00	501-503-532	5033222	GS31035	384
5031116	REC34801-99E04	425	5032100	REC57521-96312	532	5033222	GS31036	384
5031166	REC38100-99E01-OEP	424	5032101	REC57610-96311	501-503	5033264	REC38860-76F01	409
5031175	REC17670-93962	434	5032102	REC57621-91L10	533	5033299	REC08110-60020	499-538
5031196	REC17471-98601	448	5032103	REC57631-96301	503-534	5033303	REC08110-60050	499-540
5031203	REC57510-91J00	532	5032107	SOL4211-105-11	545	5033322	SOL3413-138-15	546
5031215	PAGB/T5783-M8X16	503-505	5032108	SOL4211-103-12	545	5033323	SOL3413-138-17	546
5031216	PAGB/T5783-M8X30	499-503	5032109	SOL4211-101-13	545	5033323	SOL3451-139-17	546
5031232	REC09160-26015	505-533	5032110	SOL4211-100-14	545	5033324	SOL3413-138-19	546
5031245	REC09202-05022	534	5032150	GS31089	384	5033324	SOL3451-139-19	546
5031251	REC57634-88L00	505-534	5032150	REC65720-986L0	384	5033325	SOL3413-138-21	546
5031255	REC09263-22020	505-540	5032167	REC25700-95D01	441	5033325	SOL3451-139-21	546
5031256	REC09263-22L03	505-537	5032167	REC25700-95D01	503	5033326	SOL3451-139-23	546
5031257	REC09263-25025	505-541	5032170	REC57630-96300	501-503-550	5033327	SOL3451-139-17	546
5031258	REC09263-25062	505-541	5032191	REC55125-91J01AL	503	5033328	SOL3451-139-19	546
5031260	REC09280-08005	539	5032197	PH375-0048	411	5033329	SOL3451-139-21	546
5031261	REC09280-11005	539	5032238	REC15410-98500	389	5033330	SOL3451-139-23	546
5031263	REC09280-75001	501-505-540	5032295	REC08113-60060	501-503-540	5033339	REC09283-10009	489
5031264	REC09282-17005	489-505	5032323	REC15410-87J10	389	5033342	REC11141-91J10	464
5031266	REC09282-17009	489	5032424	REC13910-89J01	397	5033371	PAF4-0409000	392
5031270	REC09289-22007	489-505	5032428	REC11413-87J00	466	5033372	REC15170-91J00	394
5031281	REC09420-04006	441-501-503-505	5032502	REC09116-06121	462	5033381	REC17472-91J00	449-497
5031286	REC09440-40002	505-534	5032615	REC32800-87J10	412	5033385	REC17670-91J01	434
5031293	REC11141-87J02	463-464	5032617	REC63P-13907-03	393	5033481	REC09283-25076	489
5031297	REC11189-87J00	463-465	5032670	PH200-T046	424	5033539	REC16510-90J00	391
5031302	REC11400-87804	465	5032670	PH200-T062	424	5033541	REC17400-90J20	451-507
5031302	REC11400-87804	465	5032689	REC57510-89J00	501	5033542	REC17461-90J01	507-508
5031304	REC11413-87J00	463-466	5032693	REC15710-66D00	395	5033632	REC09420-05009	441
5031306	REC11433-87J00	463-466	5032698	REC57510-89J00	503-532	5033639	REC11141-90J01	464
5031307	REC11489-87J00	463-484	5032732	REC33410-94400-000	400	5033649	REC11489-90J00	484
5031390	REC13421-87J00	463-466	5032743	REC56120-93900	499-540	5033702	REC63P-13907-03	393
5031392	REC13650-52G00	399	5032766	PAGB/T5783-M8X55	499	5033704	REC15440-90J00	391
5031400	REC15410-87J00	390	5032786	REC33220-76G02	399	5033706	REC15626-90J00	394



RO/OEM	REF		RO/OEM	REF	
5033708	REC15710-65D00	395	5036637	REC32800-93J03	413
5033722	REC17670-90J10	434	5036681	REC17472-96303	446-463-501-503-505
5033722	REC67F-12411-01	434	5036691	PAGB/T5783-M6X14	462-497
5033780	REC18590-72F21	399	5036701	REC38410-93J12	425
5033798	REC25700-90J01	442-507	5036714	REC11400-87804	465
5033799	PH130-0071	407	5036802	REC11141-95J00	464
5033820	REC32800-90J00	412	5036852	REC13122-95J00	487
5033838	REC38100-96J00	424	5036900	REC17413-95J00	448-501
5033919	REC16510-82703	391	5036901	REC17416-95J00	448-501
5033922	REC25700-92J00	442-507	5036902	REC17471-95J01	448-501
5033935	REC48630-92J00	426	5036908	REC17400-95J02	451-501
5033955	SOL3452-139-17	546	5036914	REC17693-95J00	487
5033956	SOL3452-139-19	546	5036938	REC09282-15008	489
5033957	SOL3452-139-21	546	5036972	PH130-0077	406
5034203	REC57510-91J00	497-532	5037038	REC25700-95J00	441-501
5034255	REC32800-94620	411	5037170	REC17471-92J00	448-507
5034323	REC17400-98661	449-497	5037175	REC17417-92J00	448
5034345	SOL4011-079-07S	497	5037176	REC17400-92J00	450
5034353	REC11141-87J02	464	5037205	REC51211-90J2	465
5034354	REC11400-87804	465	5037356	REC59178-97J00	540
5034354	REC11400-87804	465	5037363	PAGB/T91-1.6X12	548
5034462	REC11489-93E11	484	5037373	PAGB/T91-1.6X12	548
5034526	REC38100-96J00	424	5037431	REC17471-97J00	448
5034606	REC38410-93J12	425	5037432	REC17472-97J00	448
5034616	TEN00926	461	5037490	REC11141-97J02	464
5034616	TEN00926AL	461	5037515	REC57621-91L10	533
5034627	REC38100-96J00	424	5037518	PAF4-04090000	392
5034644	REC11141-92J01	464	5037545	REC17400-94J00	450
5034651	REC17471-92J00	448	5037584	REC15170-94J00	394
5034651	REC17471-92J00	506	5040140	PAF4-05000300	389
5034680	REC32800-89J11	412	5040343	PH130-0061	405
5034711	REC56120-96332-OEP	501-503-540	5040786	PH130-0006	405
5034757	REC51211-90J10	465	5084842	REC09420-05009	441
5034776	REC25700-99E00	441-506	5583473	PH130-0017	406
5034799	REC09168-10034	508-540	5814014	REC0582262	415
5034842	REC09420-05009	441	5844241	REC0583689	413
5034842	REC09420-05009	507-508	50030396	PAGB/T5787-M6X20	499
5034878	REC11489-93J00	484	50317562	REC17670-87J00	434
5034916	REC12778-93J00	487	50367173	REC17413-92J01	448
5034959	REC13119-93J00	486	0586767	REC0586767	410
5034978	REC14151-93J00	482	09141-		
5034979	REC14152-93J00	482	18005	REC90171-18M04	548
5034982	REC14212-93J00	482	176445		
5034984	REC15410-93J00	389	0775641	GS31085	384
5034985	REC15440-93J00	390	22-34982	GS31067	388
5034995	REC69J-24501-10	391	22-89771Q2	GS31066	388
5035010	REC15710-93J00	396	25222-		
5035022	REC16433-93J00	487	96300	REC25222-96300	539
5035036	REC17400-93J01	451	319771	REC386573	488
5035036	REC17400-96J03	508	320775-6	REC320775	517
5035038	REC17413-96J01	508	339543	REC339543	445
5035039	REC17416-93J00	448	387142	REC764102	469
5035039	REC17416-96J00	508	389576	REC389576	439
5035041	REC17471-92J02	448-508	436137		
5035042	REC17472-93J00	449-508	435821	REC5001593	439
5035054	REC17913-93J00	439	5001593		
5035055	REC17914-93J00	439	48-815083	SOL0001-073-06P	545
5035077	REC25700-93J00	442-508	5005440	REC6F5-12411-03	433
5035078	PH130-0078	408	500581	REC0500581	430
5035099	REC34801-93J03	425	396161	REC0500581	430
5035113	REC38100-96J00	424	5032047	REC37830-89E03	422
5035133	REC51123-93J00	487	5032195	PH375-0047	411
5035135	REC51142-93J00	465	5033102, 7	REC16510-05240	391
5035138	REC51211-93J00	465	5034775	REC25700-87E00	441
5035150	REC55125-90J01AL	508	5036040	REC25700-95D01	441
5035151	REC55128-93J10	508-540	5036629	REC11141-93J10	464
5035305	REC09280-22019	462	5035971	REC11141-93J10	464
5035412	REC18137-52D00	399	5036629	REC11142-93J10	464
5035460	REC57630-92E00	508-550	5035971	REC11142-93J10	464
5035513	REC38100-96J00	424	84-		
5035603	REC17472-93911	449-499	813715A1	REC15-203	404
5035609	REC17453-93901	540	84-		
5035695	REC65L-24563-00	389	819514T26	PH200-WH01	423
5035703	REC16510-93J00	391	84-		
5035786	REC55320-9511AL	508	826075A2	PH200-WH01	423
5035786	TEN00930	459	84-		
5035971	REC11142-93J10	464	826802A4	PH200-WH01	423
5035974	REC15410-87J30	389	89876A3	REC25000	385
5036016	REC57510-89J00	532	8M0097838	RAC320R-RAC-01	386
5036054	REC34801-99E04	425	8M0097838	RAC320R-RAC-03	386
5036059	REC57621-94403	505-533	90890-		
5036081	PH200-T062	424	06820	REC90890-06820	495
5036107	REC32800-38F10	412	91-31229	REC91-31229	494
5036191	REC13200-91J70	396	91-31229A7	RM91-31229A7	494
5036192	REC13200-91J70	396	91-34569A1	REC91-34569A1	494
5036226	REC17670-94J01	434	91-36569T	REC91-36569T	494
5036261	REC32800-94J11	411	91-		
5036277	REC34801-93J03	425	61067A04	REC91-61067A04	495
5036549	REC13200-91J70	396	91-61069T	REC91-61069T	495
5036618	REC32800-90J00	412	91-		
5036629	REC11141-93J10	464	821887T1	REC91-859046Q4	495
5036635	REC63P-13907-03	393	91-83164M	REC90890-06820	495
			91-859046Q	REC91-859046Q3	495
			91-		
			895343T01	REC91-895343T02	495
			91-		
			895343T02	REC91-895343T02	495

POLÍTICA DE GARANTÍAS RECMAR

Todos los productos comercializados por **Recambios Marinos S.L.U.** deben ser instalados y utilizados por personal competente bajo su exclusiva responsabilidad. **Recambios Marinos S.L.U.** no se responsabiliza de las consecuencias producidas por una instalación defectuosa o inapropiada de ningún artículo que no incluya soluciones de instalación.

El instalador será el responsable de verificar la correcta aplicación de las recomendaciones del fabricante en cuanto a compatibilidades de uso.

Los artículos comercializados por **Recambios Marinos S.L.U.** están amparados por la garantía legal de conformidad, conforme a las condiciones expuestas en el real decreto legislativo 1/2007 de 16 de Noviembre, aprobación del texto refundido de la ley general para la defensa de los consumidores y usuarios.

Recambios Marinos S.L.U. distribuye los artículos presentes en sus catálogos únicamente a profesionales, nunca a particulares o cliente final, el importe de la instalación jamás estará incluido en el precio por lo que no será responsable de ésta.

Los artículos comercializados por **Recambios Marinos S.L.U.** disponen de una garantía limitada por defectos de fabricación, los periodos pueden variar entre los 2 años y los 3 meses dependiendo del producto, aplicación y tipo de embarcación (lista 7ª/ 6ª/ 5ª), descartando los artículos considerados como

consumibles: bombillas, productos eléctricos, baterías y otros que carecen de periodo alguno, si necesita conocer el plazo exacto del producto contacte con el departamento comercial.

Por daños ocasionados en el transporte, se aplicará lo indicado en el artículo 366 de Código de Comercio, que dice : "Dentro de las veinticuatro horas siguientes al recibo de las mercancías, podrá hacerse reclamación contra la empresa de transporte asignada. Transcurridos los términos expresados o pagados los portes, no se admitirá reclamación alguna contra el transportista sobre el estado en que se entregó la mercancía." El material que enviamos diariamente desde **Recambios Marinos S.L.U.** a nuestros clientes es examinado antes de empaquetarse para su perfecta integridad y evitar daños en el transporte. Recuerde que es muy importante inspeccionar las cargas en presencia del transportista. Cuando se observen daños en la caja, deberá incluirse en el albarán de entrega del transportista una mención del tipo (CONFORME MERCANCÍA, SALVO INSPECCIÓN), y deberá ser firmada por usted y el transportista. En caso de recibir material defectuoso por estas causas debe hacerlo constar tanto al transportista como a **Recambios Marinos S.L.U.** para poder reclamar a la empresa de transporte correspondiente.

SOLICITUD DE GARANTÍA

La garantía siempre estará sujeta a la valoración final del departamento técnico de **Recambios Marinos S.L.U.** Esta valoración se llevará a cabo en nuestras instalaciones o en caso necesario por el fabricante del artículo, en ambas opciones el artículo tiene que estar físicamente en nuestras instalaciones centrales de Viladecans. El tiempo para la resolución será un máximo de 30 días naturales desde su recepción.

Para enviar el artículo defectuoso, debe ir a la pagina web www.recambiosmarinos.es, ir a su cuenta y

seleccionar TRAMITAR GARANTÍA dentro del área privada, desde aquí podrá descargar el archivo para la solicitud de garantías de motores y piezas, y seguir las instrucciones.

Recambios Marinos S.L.U. no asumirá ningún préstamo de reemplazo durante el proceso de garantía.

EXCLUSIONES DE GARANTÍA

Recambios Marinos S.L.U. no podrá ser acusado como responsable del defecto ante:

- Desgaste normal del producto.
- Defectos de instalación o uso inadecuado.
- Instalación de un artículo no destinado a ese modelo.
- Daños por causa externa (accidente, rayo, fluctuación de corriente...)
- Defectos y consecuencias relacionadas con el transporte.
- Alteraciones en instalaciones o barcos destinados a la competición.

En caso de rechazo de la garantía, el cliente tiene la posibilidad de recuperar su artículo defectuoso poniéndose en contacto con nosotros vía e-mail solicitando la devolución del mismo dentro de los 7 días naturales siguientes a la fecha en que se le informó del rechazo de garantía.

Recambios Marinos S.L.U. no forma parte de las garantías comerciales anunciadas en ocasiones por los fabricantes.

NORMAS PARA LA DEVOLUCIÓN DE PIEZAS EN STOCK

Con el fin de ayudar a nuestros clientes a mantener un stock correcto, **Recambios Marinos S.L.U.** aceptará la devolución de aquellas piezas que se hayan pedido por error.

No se aceptarán devoluciones de material cuyo importe sea inferior a 30€.

REQUISITOS FORMALES:

El material a retornar, tiene que estar reflejado en un albarán. Ni el material ni el embalaje deben presentar desperfectos. Bajo ningún concepto se aceptarán devoluciones que no cumplan con alguno de estos puntos. La devolución se tramitará dentro del área privada desde la web www.recambiosmarinos.es

PLAZOS:

El plazo máximo para solicitar la devolución, será de 15 días naturales contados a partir de la fecha de expedición de la mercancía desde nuestras instalaciones. El plazo para la devolución de la mercancía será, como máximo, de 15 días naturales contados a partir de la fecha de recepción del número de pre-autorización de devolución (será notificado automáticamente por **Recambios Marinos S.L.U.** durante el proceso de devolución).

CONDICIONES:

Recambios Marinos S.L.U. , no aceptará bajo ningún concepto la devolución de estos artículos:

- Calzado.
- Material eléctrico.
- Material solicitado por encargo.
- Ánodos, anclas, cadena, mangueras.
- Artículos obsoletos o descatalogados.
- Hélices, neumáticas, Paddle Surf y motores Parsun.
- Aceites, pinturas, grasas , líquidos, incluyendo cualquier producto de limpieza y mantenimiento en general.

DAÑOS OCASIONADOS POR EL TRANSPORTE:

Se aplicará lo indicado en el artículo 366 de Código de Comercio, que dice: "Dentro de las veinticuatro horas siguientes al recibo de las mercancías, podrá hacerse reclamación contra la empresa de transporte asignada. Transcurridos los términos expresados o pagados los portes, no se admitirá reclamación alguna contra el transportista sobre el estado en que se entregó la mercancía.

El material que enviamos diariamente desde **Recambios Marinos S.L.U.** a nuestros clientes es examinado antes de empaquetarse para su perfecta integridad y evitar daños en el transporte. Recuerde que es muy importante inspeccionar las cargas en presencia del transportista. Cuando se observen daños en la caja, deberá incluirse en el albarán de entrega del transportista una mención del tipo (CONFORME MERCANCÍA, SALVO INSPECCIÓN), y deberá ser firmada por usted y el transportista, en caso de recibir material defectuoso por estas causas debe hacerlo constar tanto al transportista como a **Recambios Marinos S.L.U.** para poder reclamar a la empresa de transporte correspondiente.

Todas las devoluciones de material que previamente hayan sido autorizadas se remitirán a **Recambios Marinos S.L.U.** indicando en el lugar visible el número de devolución.

ABONOS:

Recambios Marinos S.L.U. procederá a abonar todas las devoluciones (que cumplan todos y cada uno de los requisitos formales, plazos y condiciones) por un importe del 90% del facturado originalmente. El 10% restante irá destinado a soportar los costes originados por las devoluciones (manipulación, embalaje, control de calidad...).

RESERVA DE PROPIEDAD:

Recambios Marinos S.L.U. se reserva el derecho de propiedad de todos los materiales que suministre hasta que el comprador haya satisfecho el pago total de los mismos.

RECMAR WARRANTY POLICY

All products sold by **Recambios Marinos S.L.U.** must be installed and used by competent personnel under their exclusive responsibility. **Recambios Marinos S.L.U.** shall not be responsible for the consequences of the faulty or improper installation of any item that does not include installation solutions.

The fitter will be responsible for checking that the manufacturer recommendations have been followed correctly in terms of compatible uses.

Articles sold by **Recambios Marinos S.L.U.** are covered by legal warranty of conformity, in accordance with Royal Legislative Decree 1/2007, of 16 November, approving the recast text of the general law on consumer and user protection.

Recambios Marinos S.L.U. distribute the products only to professionals and never to privates of final clients. The cost of installing the part would never be included in the price for which reason, **Recambios Marinos S.L.U.** would never be responsible for its installation.

Articles sold by **Recambios Marinos S.L.U.** are covered by warranty for manufacturing defects for a limited period of time that may vary between 2 years and 3 months, depending on the product, application and type of boat it is installed on (7th/6th/5th list), except for the articles considered consumable, light

bulbs, electrical products, batteries and others that are not covered at all. For information on the exact warranty period of an article, please contact the Sales Department.

In the case of damage caused during shipping, article 366 of the Code of Commerce will apply. The article says: "Claims to the delivery company may be made within 24 hours from receiving the goods. Once this term has elapsed, or the freight costs have been paid, claims to the delivery company with regard to the condition of the goods can no longer be made." The goods that **Recambios Marinos S.L.U.** sends every day to its customers are examined before being packed to ensure their perfect integrity and avoid damage during shipping. Remember that it is essential to check the goods in the presence of the dispatcher. If the package is damaged, the dispatcher's delivery note must mention what type (CONFORMING GOODS, UNLESS INSPECTED), and must be signed by you and by the dispatcher. If you receive damaged goods for these reasons you must notify both the dispatcher and **Recambios Marinos S.L.U.** to be able to make the claim to the relevant delivery company.

WARRANTY CLAIMS

Warranties are always subject to **Recambios Marinos S.L.U.** Technical Department's assessment. The assessment will be carried out on **Recambios Marinos S.L.U.**'s premises or, if necessary, by the article's manufacturer. In both cases, the article must be physically on **Recambios Marinos S.L.U.**'s premises in Viladecans. Assessment time will not exceed 30 calendar days from receiving the article.

To return the faulty item, visit www.recambiosmarinos.es, go to your account and select PROCESS WARRANTY in the private section. From there you will be able to download the file to claim the warranty of engines and parts and follow the instructions.

Recambios Marinos S.L.U. will not charge for the loan of the replacement during the warranty process.

WARRANTY EXCLUSIONS

Recambios Marinos S.L.U. shall not be responsible for product faults in the following cases:

- Normal wear and tear of a product. Installation faults or improper use.
- Installation of an article not designed for the model in question.
- Damage due to external causes (accidents, lightning, power surges...)
- Defects and consequences of transport.
- Alterations to installations or to boats intended for competitions.

If the warranty is refused, the customer may retrieve the faulty article by contacting **Recambios Marinos S.L.U.** via email and requesting that the article is returned to them within 7 calendar days from the day the warranty was refused.

Recambios Marinos S.L.U. does not apply the warranties offered from time to time by manufacturers.

RETURN POLICY FOR PARTS IN STOCK

To help our customers maintain their stock correctly, **Recambios Marinos S.L.U.** will allow any parts ordered by mistake to be returned.

Goods with a value below €30 may not be returned.

FORMAL REQUIREMENTS:

Goods returned must be accounted for in a delivery note. Neither the goods nor the packaging must be damaged. Goods that do not meet any of these requirements will not be accepted under any circumstance. Goods may be returned via the private section of the website www.recambiosmarinos.es

TERMS:

Goods must be returned maximum within 15 calendar days from the date the goods were shipped from our premises. The deadline to return goods will be maximum 15 calendar days from the date the return pre-authorisation number is received (it will be automatically provided by **Recambios Marinos S.L.U.** during the return process)

CONDITIONS:

Under no circumstances will **Recambios Marinos S.L.U.** accept the following articles:

- Footwear.
- Electrical goods.
- Custom-made goods.
- Anodes, anchors, chains, hoses.
- Obsolete or discontinued articles.
- Thrusters, pneumatics, paddle surfing boards and Parsun engines.
- Oils, paints, greases, liquids, including all cleaning and maintenance products in general.

DAMAGE DURING TRANSPORT:

Article 366 of the Code of Commerce will apply. The article says: "Claims to the delivery company may be made within 24 hours from receiving the goods. Once this term has elapsed, or the freight costs have been paid, claims to the delivery company with regard to the condition of the goods can no longer be made."

The materials that **Recambios Marinos S.L.U.** sends every day to its customers are examined before being packed to ensure their perfect integrity and avoid damage during shipping. Remember that it is essential to check the goods in the presence of the dispatcher. If the package is damaged, the dispatcher's delivery note must mention what type (conforming goods, unless inspected), and must be signed by you and by the dispatcher, if you receive damaged goods for these reasons you must notify both the dispatcher and **Recambios Marinos S.L.U.** to be able to make the claim to the relevant delivery company.

All previously authorised returned goods must be sent to **Recambios Marinos S.L.U.** visibly specifying the return number.

CREDITING:

Recambios Marinos S.L.U. will credit 90% of the amount originally charged of all returned goods (which comply with each and every formal requirement, terms and conditions). 10% is retained to cover the cost of returning the goods (handling, packaging, quality control...).

RESERVATION OF OWNERSHIP:

Recambios Marinos S.L.U. retains ownership of all goods it supplies until the buyer pays for them in full.

POLITICA DI GARANZIE RECMAR

Tutti i prodotti commercializzati da **Recmar S.R.L.** devono essere installati e utilizzati da personale competente sotto la sua esclusiva responsabilità.

Recmar S.R.L. non è responsabile per le conseguenze di un'installazione difettosa o inadeguata di qualsiasi articolo che non includa soluzioni di installazione.

L'installatore è responsabile della verifica della corretta applicazione delle raccomandazioni del fabbricante in materia di compatibilità d'uso.

Gli articoli commercializzati dalla **Recmar S.R.L.** sono coperti dalla garanzia legale di conformità, conforme alle condizioni enunciate nel regio decreto legislativo 1/2007 del 16 novembre, approvazione del testo consolidato della legge generale per la difesa dei consumatori e degli utenti.

Recmar S.R.L. distribuisce gli articoli presenti nei suoi cataloghi solo a professionisti, mai a privati o cliente finale, l'importo dell'impianto non sarà mai incluso nel prezzo e quindi non sarà responsabile di quest'ultimo.

Gli articoli commercializzati dalla **Recmar S.R.L.** dispongono di una garanzia limitata per difetti di fabbricazione, i periodi possono variare da 2 anni a 3 mesi a seconda del prodotto applicazione e tipo di imbarcazione (elenco 7^a/ 6^a/ 5^a), scartando gli articoli

considerati come consumabili lampadine, prodotti elettrici, batterie e altri che non hanno alcun periodo di tempo, se avete bisogno di conoscere il tempo esatto del prodotto contattare il reparto commerciale.

Per i danni causati al trasporto si applica l'articolo 366 del codice di commercio che recita: "Entro 24 ore dal ricevimento delle merci, può essere presentato un reclamo nei confronti della società di trasporto designata. Alla scadenza dei termini espressi o pagati, non sono ricevibili reclami contro il trasportatore in merito allo stato in cui la merce è stata consegnata."

Il materiale che inviamo quotidianamente da **Recmar S.R.L.** ai nostri clienti viene esaminato prima di essere confezionato per la sua perfetta integrità ed evitare danni al trasporto. Si ricorda che è molto importante ispezionare i colli alla presenza del vettore. In caso di danneggiamento della cassa, sul bollettino di consegna del trasportatore deve figurare un'indicazione del tipo (CONFORME MERCE, SALVO ISPEZIONE) e deve essere firmato dall'utente e dal trasportatore, in caso di ricezione di materiale difettoso per questi motivi deve essere messo a verbale sia al trasportatore che alla **Recmar S.R.L.** per poter reclamare all'impresa di trasporto interessata.

RICHIESTA DI GARANZIA

La garanzia sarà sempre soggetta alla valutazione finale del Dipartimento Tecnico della **Recmar S.R.L.** Questa valutazione sarà effettuata presso la nostra sede o, se necessario, dal fabbricante dell'articolo, in entrambe le opzioni l'articolo deve essere fisicamente nella nostra sede centrale di Viladecans, il tempo per la risoluzione è un massimo di 30 giorni di calendario dalla ricezione.

Per inviare l'articolo difettoso, è necessario andare al sito www.recmar.it, andare al tuo account e selezionare la GARANZIA all'interno del settore privato, da qui è possibile scaricare il file per la richiesta di garanzie di motori e parti e seguire le istruzioni.

Recmar S.R.L. non assumerà alcun prestito di sostituzione durante il processo di garanzia.

ESCLUSIONI DI GARANTIA

Recmar S.R.L. non può essere accusato come responsabile del difetto di fronte a:

- Normale usura di un prodotto.
- Difetti di installazione o uso improprio.
- Installazione di un articolo non destinato a quel modello.
- Danni dovuti a cause esterne (incidente, fulmine, fluttuazione di corrente...)
- Difetti e conseguenze connesse al trasporto.
- Modifiche in impianti o barche destinati alla competizione.

In caso di rifiuto della garanzia, il cliente ha la possibilità di recuperare il suo articolo difettoso contattandoci via e richiesta di rimborso entro 7 giorni di calendario dalla data in cui viene informato del rifiuto della garanzia.

Recmar S.R.L. non fa parte delle garanzie commerciali annunciate a volte dai produttori.

REGOLE PER I RESI MERCE

Recmar S.R.L., accetteranno i resi di merce se preventivamente autorizzati dalla Direzione. Si accetteranno i resi solo degli articoli che sono stati ordinati per errore.

Per errori del magazzino, del catalogo ecc. prego richiedere il modulo attraverso la mail barbara@recmar.it, specificando il motivo.

Non si accetteranno resi di materiale il cui importo sia inferiore a € 30,00

REQUISITI FORMALI:

La merce da restituire deve essere indicato in un documento di trasporto nel quale vanno trascritti, codici, quantità e descrizione e il riferimento della bolla originale di acquisto.

Il modulo per la richiesta di autorizzazione al reso lo potrà scaricare dal sito www.recmar.it e le verrà fornito un numero di pre-autorizzazione. Una volta compilato, il modulo dovrà essere inviato a postventa@recmar.es, allegando copia della bolla. La mancanza dei requisiti descritti, il reso non potrà essere accettato e verrà restituito al mittente con l'addebito delle spese di trasporto.

SCADENZE:

Il termine per la richiesta di autorizzazione al reso sarà di 15 giorni a partire dalla data di spedizione della merce e il tempo per la restituzione della merce sarà di 15 giorni a partire dalla data di pre-autorizzazione al reso comunicata dalla **Recmar S.R.L.**

CONDIZIONI:

Recmar S.R.L., non accetterà resi, qualunque sia il motivo per i seguenti articoli:

- Calzature
- Materiale elettrico
- Materiale su ordinazione extra catalogo
- Anodi, ancore, catene, tubi
- Articoli obsoleti o non più presenti a catalogo
- Eliche, gommoni, paddle surf e motori Parsun
- Olio, vernici, grasso, liquidi, inclusi tutti i prodotti di pulizia e manutenzione in generale.

DANNI CASUSATI DURANTE IL TRASPORTO:

Si applicheranno le regole indicate dall'art. 366 del Codice del Commercio che recita: Il reclamo contro la Ditta di trasporti può essere fatto entro le ventiquattrore dalla ricezione della merce. Trascorso tale termine, non potrà essere fatto alcun reclamo.

Il materiale che viene spedito giornalmente dalla **Recmar S.R.L.** ai propri clienti, è controllato prima di essere impacchettato al fine di preservarne la sua integrità ed evitare danni durante il trasporto. Si prega di controllare sempre l'integrità delle scatole e nel caso in cui ci siano dei danni esteriori, si prega di accettare sempre con riserva e di firmare unitamente al corriere la copia della bolla di consegna e trattenere una copia. Una copia di tutto va poi inviata alla **Recmar S.R.L.** per poterla inoltrare alla Ditta di Trasporti corrispondente.

Tutti resi di materiale preventivamente autorizzato, dovranno essere spedito alla **Recmar S.R.L.** in porto franco entro i termini concordati includendo la copia della bolla e la richiesta di reso accettata.

NOTE DI CREDITO:

Recmar S.R.L., procederà alla emissione delle note di credito per tutti quei resi che abbiano i requisiti formali precedentemente indicati per il 90% del valore originario. Il restante 10% verrà trattenuto a copertura dei costi di movimentazione, imballaggio, controllo qualità etc.

RISERVA DI PROPRIETÀ:

Recmar S.R.L. si riserva il diritto di proprietà di tutto il materiale venduto fino al pagamento totale delle relative fatture.

POLITIQUE DE GARANTIE RECMAR

Tous les produits vendus par **Recambios Marinos S.L.U.** doivent être installés et utilisés par du personnel compétent sous sa seule responsabilité.

Recambios Marinos S.L.U. n'est pas responsable des conséquences d'une installation défectueuse ou inappropriée de tout élément n'incluant pas les solutions d'installation.

L'installateur sera responsable de la vérification de l'application correcte des recommandations du fabricant concernant la compatibilité d'utilisation.

Les articles vendus par **Recambios Marinos S.L.U.** bénéficient de la garantie légale de conformité, conformément aux conditions énoncées dans le décret législatif royal 1/2007 du 16 novembre, portant approbation du texte consolidé de la loi générale de la défense des consommateurs et des utilisateurs.

Les articles vendus par **Recambios Marinos S.L.U.** ont une garantie limitée pour les défauts de fabrication, les périodes peuvent varier de 2 ans à 3 mois en fonction de l'application du produit et du type de navire où ils ont été installés (7ème / 6ème / 5ème liste), excluant les articles considérés comme des consommables, ampoules, produits électriques, batteries et autres.

Si vous ne connaissez pas la durée de garantie exacte du produit, contactez le service commercial.

Pour les dommages causés au cours du transport, les dispositions de l'article 366 du code de commerce seront appliquées, ce qui stipule:

Vingt-quatre heures maximum après la réception de la marchandise, une réclamation doit être adressée à la société de transport.

Après que les conditions aient été exprimées ou que le fret eu été payé, aucune réclamation ne sera acceptée contre le transporteur auprès de l'État.

Lorsque la marchandise a été livrée. Le matériel que nous envoyons quotidiennement de **Recambios Marinos S.L.U.** à nos clients est examiné avant l'emballage pour une intégrité parfaite et éviter les dommages de transport. N'oubliez pas qu'il est très important d'inspecter le chargement en présence du transporteur.

Lorsque des dommages sont constatés sur le colis, ils doivent figurer sur le bon de livraison du transporteur.

Une mention du type (EN FONCTION DE LA MARCHANDISE, SAUF INSPECTION), et doit être signé par vous et le transporteur, s'il est reçu défectueux le matériel doit être enregistré pour ces raisons à la fois par le transporteur et par **Recambios Marinos S.L.U.** pour qu'une réclamation soit faite la compagnie de transport correspondante.

DEMANDE DE GARANTIE

La garantie sera toujours soumise à l'évaluation finale du service technique de **Recambios Marinos S.L.U.** Cette évaluation sera effectuée dans nos installations ou, si nécessaire, par le fabricant de l'article, dans les deux cas, l'article doit être physiquement dans nos locaux de Viladecans, le délai de résolution sera de 30 jours maximum à partir de sa réception.

Pour envoyer l'article défectueux, vous devez vous rendre sur le site www.recambiosmarinos.es, accéder à votre compte et sélectionner PIECES DE RETOUR.

Dans l'espace privé, vous pouvez télécharger le fichier pour demander des garanties de moteurs et de pièces et suivre les instructions.

Si tel est votre souhait, **Recambios Marinos S.L.U.** n'assurera aucun prêt de remplacement pendant le processus de garantie.

EXCLUSIONS DE GARANTIE

Recambios Marinos S.L.U. ne sera pas responsable des défauts suivants:

- Usure normale d'un produit.
- Défauts d'installation ou d'utilisation inadéquate.
- Installation d'un article non destiné à ce modèle.
- Dommages dus à une cause externe (accident, foudre, fluctuation de courant...)
- Défauts et conséquences liés au transport.
- Modifications d'installations ou de bateaux destinés à la compétition.

En cas de refus de la garantie, le client a la possibilité de récupérer son article défectueux en nous contactant par courrier électronique pour demander le retour à ses frais de celui-ci dans les 7 jours calendaires suivant la date à laquelle vous avez été informé du rejet de la garantie.

Recambios Marinos S.L.U. ne participe pas à des garanties commerciales parfois annoncées par les fabricants.

RÈGLES POUR LE RETOUR DE PIÈCES EN STOCK

Afin d'aider nos clients à maintenir un stock correct, **Recambios Marinos S.L.U.** acceptera les retours des pièces commandées par erreur. Les retours de matériel dont le montant est inférieur à 30 € ne seront pas acceptés.

EXIGENCES FORMELLES:

Le matériel à retourner doit être apparaître dans un bon de livraison ou une facture.

Ni le matériel ni l'emballage ne doivent présenter de dommage. Aucun retour ne sera accepté qui ne respecte aucun de ces points. Le remboursement sera traité dans l'espace privé à partir du site Web www.recambiosmarinos.es

DÉLAIS:

Le délai maximum pour demander le retour sera de 15 jours calendaires à compter de la date d'envoi de la marchandise de nos installations. La période pour le retour de la marchandise sera au maximum de 15 jours à compter de la date de réception du numéro d'autorisation de retour (vous serez informé automatiquement par **Recambios Marinos S.L.U.** au cours du processus de retour)

CONDITIONS:

Recambios Marinos S.L.U., n'acceptera en aucun cas le retour de ces articles:

- Chaussures.
- Matériel électrique.
- Matériel commandé sur demande.
- Anodes, ancres, chaîne, tuyaux.
- Les articles obsolètes ou abandonnés.
- Hélices, pneumatiques, blocs moteurs, Paddle, Surf et moteurs Parsun.
- Huiles, peintures, graisses, liquides, y compris les produits de nettoyage et d'entretien en général.

DOMMAGES CAUSÉS PAR LE TRANSPORT:

Les dispositions de l'article 366 du Code de commerce seront appliquées, qui stipule: «Dans les vingt-quatre heures après la réception de la marchandise, une réclamation doit être faite à la compagnie de transport assignée.

Une fois que les conditions ont été exprimées ou que le fret est payé, aucune réclamation ne sera acceptée contre le transporteur sur l'état dans lequel les marchandises ont été livrées.

Le matériel que nous envoyons chaque jour de **Recambios Marinos S.L.U.** à nos clients est examiné avant d'être emballé pour une intégrité parfaite et éviter les dommages de transport. Rappelez-vous qu'il est très important d'inspecter les colis en présence du transporteur. Lorsque des dommages sur le colis sont observés, vous devez noter une mention du type (selon la marchandise, sauf inspection), et doit être signé par vous et le transporteur, s'il est reçu défectueux le matériel doit être enregistré pour ces raisons à la fois par le transporteur et par **Recambios Marinos S.L.U.** pour qu'une réclamation soit faite la compagnie de transport correspondante.

Tous les retours de matériel préalablement autorisés seront envoyés à **Recambios Marinos S.L.U.** indiquant à l'endroit visible le numéro de retour.

ABONNEMENTS:

Recambios Marinos S.L.U. procédera au paiement de toutes les déclarations (qui respectent chacune des conditions de forme, modalités et conditions) pour un montant égal à 90% de la facture originale. Les 10% restants seront destinés à supporter les coûts occasionnés par les retours (manutention, emballage, contrôle de qualité...).

RESERVE DE PROPRIETE:

Recambios Marinos S.L.U. se réserve le droit de disposer de tout le matériel fourni jusqu'à concurrence du paiement intégral par l'acheteur, le transfert de leur propriété ne pouvant intervenir avant cette échéance.

BARCELONA

Jocelyn Bell, 26
Pol. Ca n'Alemaný
08840 Viladecans (Barcelona)
Tel. 902 10 85 85 - 93 633 34 80
Fax 93 662 66 59

International
phone: (+34) 93 662 66 55
Fax (+34) 93 662 66 59

info@recambiosmarinos.es
www.recambiosmarinos.es

GIRONA

C/ Gironés, 5
Pol. Ind. El Plà
17486 Castelló d'Empúries (Girona)
Tel. (+34) 972 158 809

girona@recmar.es

CANARIAS

Laura Grote de la Puerta, 3, Nave 5
Pol. Industrial El Mayorazgo
38110 Santa Cruz de Tenerife
Tel. (+34) 922 621 499

canarias@recmar.es

ITALIA

RECMAR SRL
Via Israele 10 H
Zona Industriale Settore 7
07026 Olbia (OT)

Tel. (+39) 0789 51962
Fax (+39) 0789 600177
sales@recmar.it